



CATALOG

SINGLE & MULTI-ZONE SYSTEMS
SKYAIR PRODUCTS

Daikin is one of the largest manufacturers of heating, cooling and refrigerant products in the world.

Daikin is recognized as one of the world leaders in the manufacture of HVAC equipment and refrigerants. For over 90 years, Daikin has grown consistently and successfully due to the loyalty and success of our customers, as well as a track record of innovation and quality. Daikin is redefining home comfort in North America with some of the most technologically and aesthetically advanced solutions. These intelligent, energy efficient systems provide an unprecedented level of individual comfort and control.

Additional Information

Before purchasing this appliance, read important information about its estimated annual energy consumption, yearly operating cost, or energy efficiency rating that is available from your retailer.

Daikin is expansive in its manufacturing footprint. It is global, but with a local focus. We have operations around the world, with research and development, as well as production facilities in 70 countries. Using our advanced technology and expertise, Daikin has earned a reputation for excellence as an indoor comfort specialist in countries and regions spanning the globe by providing solutions for the needs of our customers. In the United States, we operate major manufacturing and research and development facilities in Texas, Tennessee, Minnesota, Alabama and Ohio.

Table of Contents

Why Zoned Systems?	4
Daikin Benefits	5
Key Features and Benefits	6
Regional Efficiency Standards	8
Single-Zone Systems	15
Daikin 17 series Wall-Mounted	16
Daikin 19 series Wall-Mounted	20
Daikin <i>EMURA</i> Wall-Mounted	24
Daikin <i>AURORA</i> Wall-Mounted	26
Daikin <i>AURORA</i> Floor-Mounted	28
<i>VISTA</i> Ceiling Cassette	30
LV series Wall-Mounted	32
LV series Slim-Duct, Built-In Concealed Ceiling Unit	34
FDMQ Ducted Concealed Indoor Unit	36
NV series Heat Pump or Cooling Systems	38
LV series 30/36	42
<i>QUATERNITY</i> series	44
Multi-Zone Systems	47
Daikin <i>AURORA</i> Multi-Zone Outdoor Units	50
MXS series Multi-Zone Outdoor Units	52
Multi-Zone Indoor Units	58
Multi-Zone Combinations	70
SkyAir Products	73
FAQ_TAVJU - Wall-Mounted Unit	76
FBQ_PVJU - DC Ducted Concealed	78
FCQ_TAVJU - <i>Round Flow</i> Cassette	80
FHQ_PVJU - Ceiling Suspended	82
FTQ_TAVJU - Multi-Position Air Handling Unit	84

Why Zoned Systems?

DAIKIN HAS A FOCUS AND TRACK RECORD OF QUALITY

With over ninety years of HVAC history since its founding, Daikin has created a global indoor comfort revolution with innovative new technologies and products that have brought firsts to the world. From the introduction of new compressor designs or new ways to precisely control refrigerant flow, Daikin strives to be a global leader by investing in technology. We bring this same focus on innovation to North America, applying our portfolio of product features from around the world to meet the challenges we face in North American homes and businesses.

Optimal design and comfort for the whole home

Integrated design

Daikin indoor single and multi-zone units offer homeowners a discreet, modern design. The unit's smooth curve blends beautifully with the wall resulting in an unobtrusive presence that matches virtually all interior décors.

Efficient and smart

Inside the single and multi-zone system is a highly intelligent system, with innovative features designed to reduce power consumption. Some units offer whisper-quiet performance down to 19dB(A) to further to your sense of comfort.

Intelligent eye

The intelligent eye occupancy sensor, available on select models, controls comfort and conserves energy. If the room is empty for 20 minutes it changes the set point to start saving energy. As soon as someone enters the room, it immediately returns to the original setting. Regular use of this feature can provide additional energy savings of up to 20% or more compared to units without this feature.

Daikin single and multi-zone systems offer dealers:

- » High-quality, energy-efficient comfort solutions
- » Opportunities to spend less time on installations and more time with new customers
- » Differentiated product offerings that deliver improved customer satisfaction
- » Outstanding limited warranties* and reduced call backs



FORM. FUNCTION. REDESIGNED.

As an innovation leader, Daikin is laying the foundation for next generation technology with multiple cutting-edge core technologies. In May 2013, Forbes Magazine recognized Daikin as an innovation leader, putting Daikin on its list of the 100 Most Innovative companies in the world.



Source: www.forbes.com

* Complete warranty details available from your local distributor or manufacturer's representative or at www.daikincomfort.com

COMFORTABLE LIMITED WARRANTY* PROTECTION

Single and Multi-Zone Systems		SkyAir ^{††}
Daikin 17 series [†] , LV 30/36 ^{††} NV series ^{††}	Daikin EMURA [†] Daikin 19 series [†] , Daikin AURORA [†] , LV series [†] , FDMQ [†] , QUATERNITY [†] , MXS series [†] VISTA [†] and RMXS [†]	All products
		

* Complete warranty details available from your local dealer/contractor or at www.daikincomfort.com. To receive the 10-Year or 12-Year Parts Limited Warranties, online registration must be completed within 60 days of installation. Online registration is not required in California or Quebec.

[†] If product installed in a commercial application, limited warranty period is 5 years.

^{††} Limited warranty, registration not required for residential and commercial installations.

A full range of styles and options for every home, and every room

Daikin single and multi-zone systems are an ideal solution to displace traditional systems in primary living spaces or for refurbishing and remodeling additional spaces. They have a modern design and are extremely quiet in operation.

Our heat pumps are all-in-one heating and cooling solutions, meaning comfortably warm in winter and cool in summer.

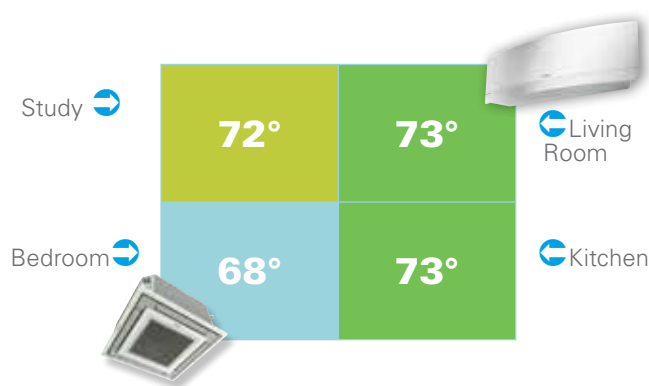

Smart Inverter Technology

Daikin’s inverter technology is a true innovation in the field of climate control. The principle is simple: inverters adjust the power used to suit the actual requirement – no more, no less! Single & multi-zone systems deliver the capacity required to maintain desired room conditions, typically reducing energy consumption by up to 30% or more compared to traditional fixed-speed ducted systems. This technology minimizes temperature fluctuations and provides continuous cooling and heating comfort.

Whisper Quiet

Daikin systems feature low indoor and outdoor operating sound levels. Daikin systems most often operate at low speeds with indoor sound levels as low as 19 decibels (dB) and outdoor sound levels as low as 46 dB. Activate the indoor unit quiet operation and sound levels drop by 2-3 dB for gentler heating and cooling, quiet operation.

Advanced Filtration

Long life, washable filters.

Heating Performance

Daikin systems provide heating performance with single and multi-zone Heating Seasonal Performance Factor's (HSPF's) as high as 12.5, making Daikin systems efficient and effective even in extreme environments.

Single and Multi-Zone Systems

Key Features and Benefits

Superior Comfort Control

Indoor Unit Quiet Operation.



Sound levels are reduced by 2-3 decibels (dB) from the low fan speed for quieter and gentler heating and cooling.

Outdoor Unit Quiet Operation.



Outdoor unit sound levels can be reduced by 3dB for times when quieter operation is needed.

Intelligent Eye.



The intelligent eye is an infrared sensor with the ability to sense movement in the room. When you are in the room, the air conditioner operates normally.

If you leave the room for more than 20 minutes the air conditioner automatically changes to an energy-saving operation. Using the intelligent eye, savings of up to 20% in cooling and up to 30% in heating can be achieved compared to units without this feature.

Automatic Operation.



For unattended year-round comfort, this function allows the unit to automatically switch between heating and cooling modes as required. (heat pumps types only)

Program Dry Function.



This gives priority to reducing the level of humidity in the room rather than room temperature.

Auto Fan Speed.



To reduce operating sound and power consumption, the fan speed is automatically controlled by the micro-processor to suit the controller setting and prevailing room temperature.

Hot Start.



When the heating operation starts or when the unit changes from cooling to heating there is no cold draft released into the room.

Cold Climate Optimized

Daikin AURORA Models.



These systems have been designed to deliver effective heating performance to ambient conditions as low as -13°F / -25°C.

Low Ambient Cooling.



Cooling operation down to -22°F (-30°C) outside temperature for cooling only models. No field installed kit required.

Lifestyle Convenience

Econo Mode.



Limits the maximum operating current and power consumption of the outdoor unit by approximately 30% during start-up. This saves energy and reduces the load on the electrical circuit when multiple electrical devices are used simultaneously.

Powerful Operation.



Pushing the POWERFUL button on the remote control gives you a boost in cooling or heating power for a 20-minute period, even if the unit is already operating at high capacity.

Remote Controller with Back-lit Display.



Features a back-lit LCD and luminescent control buttons, allowing for easy viewing in dimly lit rooms.

Home Leave Operation.



Select this energy saving function when leaving the house and the air conditioner will operate at a pre-selected temperature. Your home can then be warmed or cooled much quicker upon your return. It can also be used to record your preferred (default) settings.

Indoor Unit On/Off Switch.



A convenient on/off switch on the indoor unit allows you to start up the system even if you have misplaced the remote control or the remote control batteries are exhausted.

Comfortable Airflow

Wide Angle Louvers.



Smoothly curved wide-angle louvers provide wide airflow coverage for effective heating and cooling no matter where the indoor unit is placed within the room.

Draft Reduction.



This system directs warm air to the floor in winter and cool air across the room in summer for optimal efficiency and comfort. The large flap governs airflow direction while the small flap (or diffuser) swings, producing fine air currents that help circulate the air around the room.

Comfort Mode.



Comfort Mode operation improves comfort. When cooling, the flap positions itself horizontally to keep cold airflow from being blown directly onto the body. When heating, the flap turns vertically downwards to drive warm air to the bottom of the room.

Single and Multi-Zone Systems

Key Features and Benefits

ECO+



An intelligent feature that ensures optimum energy consumption while fulfilling basic human comfort needs. Once activated, set temperature will be adjusted automatically to an optimum energy consumption level.

Vertical Auto-Swing (up and down).



The vertical auto swing automatically sweeps the air across the room in an up and down motion. When the unit is switched off, the louvers close automatically.

Horizontal Auto-Swing (left and right).



Automatically moves to ensure an even distribution of air throughout a room.

3-D Airflow.



Combines vertical and horizontal auto-swing to circulate cool/warm air to the corners of large spaces.

Worry Free

Auto-Restart.



The unit memorizes the operation mode, airflow and temperature settings. Should there be a power failure when the unit is in operation, it will automatically return to the same operating conditions when the power is restored.

Self-Diagnosis.



In the event that a problem develops with the unit, malfunction codes can be displayed on the liquid crystal panel of the remote control for fast and easy fault diagnosis.

Anti-Corrosion.



The special anti-corrosion coating on the outdoor unit heat exchanger provides resistance to salt damage and atmospheric corrosion.

Comfortable and Clean

Air-Purifying Filter with Photocatalytic Deodorizing Function.



This combination operates as a highly-effective unit and can be used for up to three years if periodic maintenance is performed.

Titanium Apatite Photocatalytic Air-Purifying Filter.



This filter combines the air-purifying filter and titanium apatite photocatalytic deodorizing filter in a single highly effective unit. The filter can last for up to three years without replacement if washed once every six months.

Specialized Air Filter.



The pre-filter net is impregnated with a safe, colorless and odorless agent that is intended to help reduce mold on the filter itself.

Wipe-Clean Flat Panel.



The flat panel models can be cleaned with only the single pass of a cloth across their smooth surface. The flat panel can also be easily removed for more thorough cleaning.

Timers

24-Hour On/Off Timer.



The timer can be preset to start and stop the air conditioner at any time within a 24-hour period. Once the times are set, the air conditioner can be operated for a period by simply pressing the ON or OFF timer buttons.

Weekly Timer.



The weekly timer function makes it easy to enter up to four settings per day for each day of the week. The weekly timer function not only allows you to program on and off time, but also the desired temperature.

Night Set Mode.



Through the use of the 'Timer-OFF Circuit', the preset room temperature gently rises in cooling or falls in heating before the unit stops. This energy-saving feature allows you to sleep comfortably without feeling a sudden change in the room temperature, while at the same time saving energy.

Keeping Warm

Quick Warming Function.



Prevents the compressor from pumping liquid refrigerant in low-ambient conditions. (Heat pumps only)

Automatic Defrosting.



Sensor performs automatic defrosting of the outdoor heat exchanger if necessary, ensuring optimum heating performance. (Heat pumps only)

Intelligent Defrost Mode.



The outdoor unit will enable this mode to help prevent frost/ice from building up in cold climate conditions. It will also help with longer heating operation time for additional comfort for occupants (compared to HVAC systems without this function).

Regional Efficiency Standards

U.S. Department of Energy (DOE) minimum efficiency changes went into effect on January 1, 2015, affecting all residential air conditioners and heat pumps we manufacture. One additional change implemented that adds complication is regional standards that apply to Split System and Package Air Conditioners. Now, the DOE minimum efficiency standards include both national standards (which are based on date of manufacture) and regional standards (which are based on date of installation).

National Standards

- » Split system heat pumps (14 SEER / 8.2 HSPF)
- » Single package heat pumps (14 SEER / 8.0 HSPF)
- » Single package gas/electric (14 SEER / 81% AFUE)
- » Gas fired furnaces (80% AFUE)
- » Kept 13 SEER base national standard for split-system air conditioners

Labeling

There are two methods to help identify products subject to regional standards. The first is the EnergyGuide label that is noticeably different, with the inclusion of the map of the United States that identifies where the equipment can be installed.

The second is a separate statement that will be on the rating plate or on a label next to the rating plate called the "Install Prohibited" statement. All products subject to regional standards have both the EnergyGuide label and the Install Prohibited statement.

NOTE: The Federal Trade Commission (FTC) originally required a range of SEER be placed on Split System products subject to regional efficiency standards. However, they reversed their decision and now only a single value is listed (since mid-2017). Products in inventory may have mixed EnergyGuide labels (some having a range, others having a single value for SEER).

EnergyGuide Labels Currently In Effect

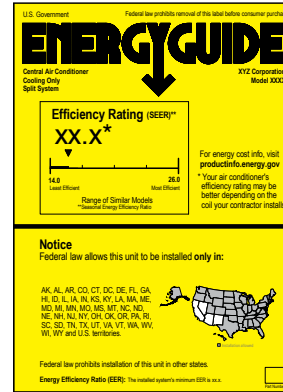

Subject to regional standards

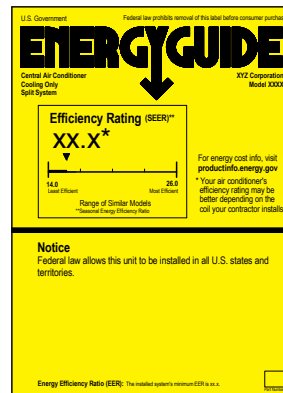

Can be installed anywhere

Efficiency Standards

The map to the right summarizes the national and regional efficiency standards.

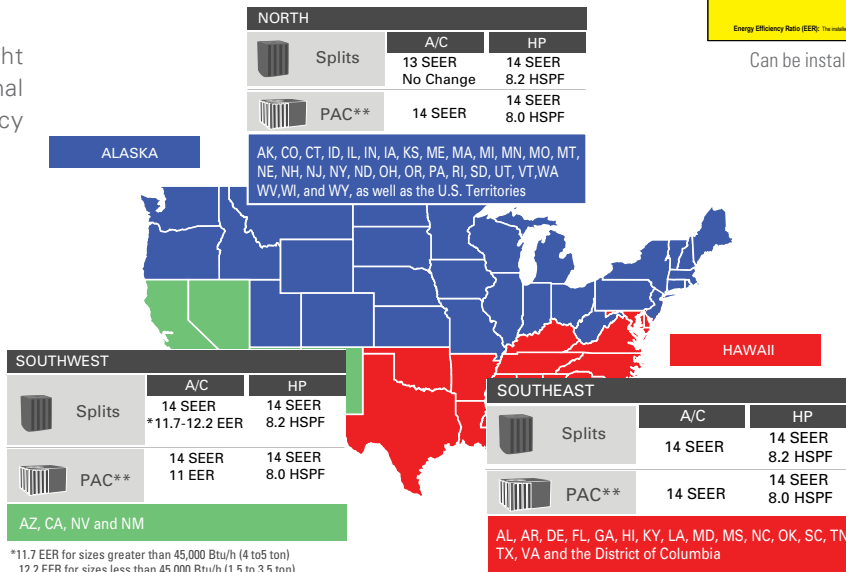

*11.7 EER for sizes greater than 45,000 Btu/h (4 to 5 ton)
12.2 EER for sizes less than 45,000 Btu/h (1.5 to 3.5 ton)
**PAC includes both single package cooling only and single package gas/electric models

• Regional standards apply only to single phase air conditioners, 5 ton and less

What You Need to Know as a Distributor

DOE defines a distributor as “a person (other than a manufacturer or retailer) to whom a consumer product is delivered or sold for purposes of distribution in commerce.” Therefore, if you resell product for sale other than to an end user, you may be considered a distributor as opposed to a contractor or dealer (see definitions below).

Distributors are required to comply with the requirements:

1. Do not knowingly sell product that will be installed in violation of regional standards.
2. Conduct regional standards training for all employees and customers.
3. Maintain records for all units subject to the regional standards for a period of 54 months. These records are to include the outdoor unit manufacturer, model number, serial number, date of purchase, date of sale, customer name and delivery address if delivered.

What You Need to Know as a Contractor/Dealer

As a contractor or dealer, you will also be required to adhere to requirements of the DOE 2015 HVAC Regional Standards Enforcement Rules. DOE has defined a contractor as “a person (other than the manufacturer or distributor) who sells to and/or installs for an end user a central air conditioner subject to

regional standards.” DOE has defined a dealer as “a type of contractor, generally with a relationship with one or more specified manufacturers.” The contractor/dealer requirements include the following:

1. Do not knowingly install product that is in violation of regional standards.
2. Conduct regional standards training for all employees.
3. Maintain records for all units subject to the regional standards for a period of 48 months. These records to include the indoor and outdoor unit manufacturer and model number, outdoor unit serial number, distributor purchased from, date and address of installation.

Enforcement

Enforcement of the standards will be at least partially via complaints registered with the DOE. DOE has set up an email for reporting suspected violations directly to them at EnergyEfficiencyEnforcement@doe.gov, or suspected violations can be reported by phone, at (202) 287-6997.

All verified violations will require remediation and can result in stiff fines. Notices of Violation will be posted publicly by the DOE. Further, if a distributor or contractor/dealer is found to routinely violate the standards, manufacturers can be prohibited from selling products to that party.

Contractors, dealers and distributors should be aware that the DOE may request copies of documentation proving product sales and installations are in compliance. Records requested by DOE must be provided within 30 days.





















































Training

A recorded webinar providing details about the efficiency standards is available for viewing at www.daikincomfort.com/standards. Questions about the efficiency standards can be emailed to RegionalStandardsQuestions@goodmanmfg.com.

IMPORTANT NOTE:

The information provided is a summarized overview and is not intended to provide a complete description of the DOE 2015 Regional Standards. For more information regarding the DOE 2015 HVAC Regional Standards and the enforcement of these standards, please visit <https://energy.gov/gc/regional-standards-enforcement>.

Single and Multi-Zone Systems

			7K Btu/h	9K Btu/h	12K Btu/h	15K Btu/h	18K Btu/h	24K Btu/h	30K Btu/h	36K Btu/h	48K Btu/h	Warranty*	
SINGLE-ZONE	DAIKIN 17 SERIES	HP											
		AC											
	DAIKIN 19 SERIES	HP											
		AC											
	EMURA	HP											
	DAIKIN AURORA	HP											
	LV SERIES	HP											
		AC											
	FDMQ	HP											
	NV SERIES	HP											
AC													
QUATERNITY	HP												
VISTA	HP												
MULTI-ZONE	DAIKIN AURORA (MULTI-ZONE)	HP											
	MXS SERIES	HP											
	RMXS_LVJU	HP											

* Complete warranty details available from your local dealer/contractor or at www.daikincomfort.com. To receive the 10-Year or 12-Year Parts Limited Warranty, online registration must be completed within 60 days of installation. Online registration is not required in California or Quebec.
If product installed in a commercial application, limited warranty period is 5 years.

Zoned System Features

Models		FTKB_AX	FTXB_AX	FTK_NM	FTX_NM	FDXS_LV	FTXS_LV	FTX_NVJU	FTXG_H	FVXS_N	CDXS_LV	FDMQ_R	CTXS_LV	FTXR	FFO_Q
Comfortable Airflow	Power Airflow Dual Flaps						■	■	■				■	■	
	Wide Angle Louvers	■	■	■	■		■	■	■	■			■	■	
	Vertical Auto Swing (up and down)	■	■	■	■		■	■	■	■			■	■	■
	Horizontal Auto Swing (left and right)						■	■	■				■	■	
	3-D Airflow						■	■	■				■	■	
	Comfort Airflow Orientation			■	■		■	■	■				■	■	
Comfort Control	Indoor Unit Quiet Operation	■	■	■	■	■	■	■	■	■	■		■	■	
	Outdoor Unit Quiet Operation					■	■	■		■	■		■	■	
	Intelligent Eye						■	■	■				■	■	
	Automatic Operation		■		■	■	■	■	■	■	■	■	■	■	■
	Program Dry Function	■	■	■	■	■	■	■		■	■	■	■	■	■
	Auto Fan Speed	■	■	■	■	■	■	■	■	■	■	■†	■	■	■†
	Hot Start			■	■	■	■	■	■	■	■	■	■	■	■
Comfortable and Clean	Titanium Apatite Photocatalytic Air Purifying Filter	■	■	■	■		■	■	■	■			■	■	
	Wipe Clean Flat Panel	■	■	■	■		■	■	■	■			■	■	
Lifestyle	Econo Mode			■	■	■	■	■		■	■		■	■	
	Inverter Powerful Operation	■	■	■	■	■	■	■	■	■	■		■	■	
	Remote Controller with Back-lit Display			■	■	■	■	■		■	■	■†	■	■	■†
	LCD Wireless Remote Control	■	■	■	■	■	■	■	■	■	■		■	■	
	Indoor Unit On/Off Button	■	■	■	■	■	■	■	■	■	■		■	■	
Timers	24 Hour On/Off Timer					■	■	■	■	■	■	■†	■	■	
	Weekly Timer						■	■		■			■	■	
	Night Set Mode	■	■	■	■	■	■	■	■	■	■		■	■	
Worry Free	Auto Restart after Power Failure	■	■	■	■	■	■	■	■	■	■	■	■	■	■
	Self Diagnosis with Digital Display	■	■	■	■	■	■	■	■	■	■	■	■	■	■
	Anti-corrosion Treatment of Outdoor Heat Exchanger Fin	■	■	■	■	■	■	■	■	■	■	■	■	■	■
Cold Climate	Daikin <i>AURORA</i> Line Up				■	■	■			■	■	■	■	■	■
	Low Ambient Cooling							■							

† With wired remote controller

■ When connected to Daikin *AURORA* Multi-Zone System

Control from Anywhere

Innovative Control Solutions



Navigation Remote Controller (Wired) (BRC1E73)

The *Navigation* Remote Controller offers scalable control architecture optimized for Daikin FFQ, FDMQ single-zone, multi-zone and *SkyAir* systems. The wall-mounted controller features a back-lit LCD display as well as intuitive menus. The menu displays are available in English, French, or Spanish languages.



Hand-held Wireless Controller

Hand-held controllers, included with most indoor units, provide flexible control of Daikin single and multi-zone systems including: temperature control, operating modes, weekly programming, and more.



Easy-to-use

User-friendly interface makes it easy to set up a personalized program, adjust settings, and make adjustments anytime, anywhere.



Nature

Save money on utility bills and reduce energy consumption (as compared to non-scheduled systems) with the weekly schedule.

Daikin Comfort Control App and DKN App for Wi-Fi control of your Single & Multi-Zone System*



It can happen to anyone. You forgot to change the temperature of your heat pump system or air conditioner before leaving the house or you will be delayed returning home and wish to avoid needlessly heating or cooling your home. What in the past would have resulted in wasted energy is no

longer a problem? With the Daikin Comfort Control App or DKN App, you are always in control. You can use your tablet or smartphone to access your Daikin system via the internet. Fault conditions can also be detected remotely, allowing a quick response to problems.

Functions accessible via the Daikin Comfort Control App & DKN App



Auto Mode Your Daikin system will change between cooling or heating to maintain the desired temperature range.



Fan Mode The indoor unit fan will run to circulate the air in the space without cooling or heating



Heating Mode Your Daikin system will only run in heating mode to maintain the desired heating temperature



Cooling Mode Your Daikin system will only run in cooling mode to maintain the desired cooling temperature



Dry Mode Your Daikin system will continually work to dry the air without affecting the temperature in the space



Schedule Adjust or set a schedule remotely



Scan QR code to download the Daikin Comfort Control App



Daikin Comfort Control



Available on the App Store

*Requires BRP072A43 or AZA16WSCDKA wi-fi adapters depending on the indoor unit





Single-Zone Systems



Daikin 17 series

Wall-Mounted Cooling Only & Heat Pump 17 SEER | 9 HSPF

COMFORTABLE LIMITED WARRANTY* PROTECTION



* Complete warranty details available from your local dealer/contractor or at www.daikincomfort.com. To receive the 10-Year Parts Limited Warranty, online registration must be completed within 60 days of installation. Online registration is not required in California or Quebec.
If product installed in a commercial application, limited warranty period is 5 years.

Daikin 17 series is available in both cooling only and heat pump configuration to offer a stylish design at an outstanding value. Wall-mounted units are simple to install and can be placed subtly, high on a wall, where they do not detract from your décor and operate very quietly.

Standard Features

- » Energy Efficient – 17 SEER, 9 HSPF, up to 11 EER – Variable-Speed Inverter Compressor
- » Cooling Range: 50° - 115°F
- » Heating Range: 5° - 65°F
- » Indoor Sound Pressure as low as 22 dB(A)
- » Outdoor Sound Pressure as low as 46 dB(A)
- » Eco+
- » Titanium Apatite Photocatalytic Air Purifying Filter
- » Powerful Operation Mode
- » Wireless Remote Controller
- » Auto Changeover (Heat Pump Only)
- » Auto Fan Speed Control
- » Self-Diagnostics with Digital Display
- » Auto-Restart after Power Failure
- » Anti-Corrosion Heat Exchanger Treatment
- » Quick warming function (Heat Pump)
- » Automatic defrosting (Heat Pump)



BRC52B63 – 17 series heat pump shown, BRC52B64 for AC

IDEAL SOLUTIONS FOR:

- » Renovations, remodeling and new construction
- » Sun rooms, basements, attics, garages, hot or cold rooms, and more
- » Rooms where floor space comes at a premium or is not available for other application
- » Ceiling void or attic does not allow for a viable duct run option
- » Cooling Only models are an excellent value for space not requiring heating



ECO+ – An intelligent feature that ensures optimum energy consumption while fulfilling basic human comfort needs. Once activated, set temperature will be adjusted automatically to an optimum energy consumption level



Auto-Restart – The unit memorizes the operation mode, airflow and temperature settings. Should there be a power failure when the unit is in operation, it will automatically return to the same operating conditions when the power is restored.



Titanium Apatite Photocatalytic Air Purifying Filter – This filter combines the air-purifying filter and titanium apatite photocatalytic deodorizing filter in a single highly effective unit.



Blue Fin Protection – The hydrophilic coated fin ensures the condensate water moves easily to the drain pan — thus enhancing the cleanliness and lifespan of the cooling coil.



Powerful Operation Mode – Pushing the POWERFUL button on the remote control gives you a boost in cooling or heating power for a 20-minute period, even if the unit is already operating at high capacity.

Daikin 17 series

Wall-Mounted Cooling Only

17 SEER | Up to 11 EER

SINGLE-ZONE SYSTEMS



Model	Indoor Unit		FTKB09AXVJU	FTKB12AXVJU	FTKB18AXVJU	FTKB24AXVJU
	Outdoor Unit		RKB09AXVJU	RKB12AXVJU	RKB18AXVJU	RKB24AXVJU
Capacity Rated (Min. - Max.)	Btu/h		8,800	11,000	18,000	21,200
Moisture Removal	gal/h		4,400 - 10,200	4,400 - 13,000	4,300 - 21,200	6,000 - 22,200
EER Rated			11	8.5	10.5	11
SEER			17	17	17	17
Piping Connections	Liquid	in. (mm)	Ø 1/4 (Ø 6.4)			
	Gas		Ø 3/8 (Ø 9.5)		Ø 1/2 (Ø 12.7)	
	Drain		Ø 3/4 (Ø 19.0)			
Max. Interunit Piping Length			65-5/8 (20)		98-1/2 (30)	
Max. Interunit Height Difference			32-13/16 (10)			
Chargeless			25 (7.6)			
Amount of Additional Charge of Refrigerant	oz/ft (g/m)		0.21 (20)			
Operating Range - Cooling	°F DB		50° - 115°F			
Indoor Unit			FTKB09AXVJU	FTKB12AXVJU	FTKB18AXVJU	FTKB24AXVJU
Airflow Rate	H	cfm (m³/min)	330 (9.3)	360 (10.2)	430 (12.2)	555 (5.7)
	M		272 (7.7)	282 (8.0)	374 (10.6)	486 (13.8)
	L		215 (6.1)	232 (6.6)	318 (9.0)	405 (11.5)
	SL		165 (4.7)	165 (4.7)	274 (7.8)	336 (9.5)
Fan	Speed	Steps	5 Steps, Quiet, Auto			
Air Direction Control			Horizontal, Downward			
Air Filter			Titanium Apatite			
Dimensions (H x W x D)	in. (mm)		11-11/16 x 35-1/16 x 8-1/4 (297 x 891 x 210)		12-5/8 x 46-1/8 x 9-1/2 (321 x 1172 x 241)	
Weight	lbs. (kg)		20 (9.5)		31 (14)	
Sound Pressure Level (H / M / L / SL)	dB(A)		42 / 35 / 30 / 23	42 / 35 / 32 / 22	40 / 37 / 35 / 32	47 / 44 / 41 / 37
Outdoor Unit			RKB09AXVJU	RKB12AXVJU	RKB18AXVJU	RKB24AXVJU
Compressor	Motor Output	W	-			
Refrigerant	Type		R-410A			
	Charge	lbs. (kg)	1-5/8 (.34)	2-1/5 (1)	2-3/4 (1.3)	3-1/5 (1.5)
Airflow Rate	H	cfm (m³/min)	900 (25.5)	730 (20.7)	1690 (47.9)	1796 (50.9)
	SL		-	-	-	-
Dimensions (H x W x D)	in. (mm)		21-5/8 x 25-5/16 x 10-3/4 (549 x 643 x 273)		25-11/16 x 33-11/16 x 12-15/16 (653 x 856 x 328)	
Weight	lbs. (kg)		53 (24)	57 (26)	82 (37)	97 (44)
Sound Pressure Level	H	dB(A)	46	48	53	52

Unit Combination		Power Supply				Compressor	OFM		IFM	
Indoor Unit	Outdoor Unit	Hz - Volts	Voltage Range	MCA	MOCP	RLA	W	FLA	W	FLA
FTKB09AXVJU	RKB09AXVJU	60 - 208	Min. 187 V Max. 253 V	6.95	15	6.75	41	0.19	18	0.20
		60 - 230								
FTKB12AXVJU	RKB12AXVJU	60 - 208	Min. 187 V Max. 253 V	7.7	15	7.5	41	0.19	18	0.20
		60 - 230								
FTKB18AXVJU	RKB18AXVJU	60 - 208	Min. 187 V Max. 253 V	13.2	20	13	61	0.5	40	0.24
		60 - 230								
FTKB24AXVJU	RKB24AXVJU	60 - 208	Min. 187 V Max. 253 V	13.2	20	13	61	0.5	40	0.24
		60 - 230								

Daikin 17 series

Wall-Mounted Heat Pump

17 SEER | 9 HSPF



Model	Indoor Unit		FTXB09AXVJU RXB09AXVJU		FTXB12AXVJU RXB12AXVJU		FTXB18AXVJU RXB18AXVJU		FTXB24AXVJU RXB24AXVJU	
	Outdoor Unit		Cooling	Heating	Cooling	Heating	Cooling	Heating	Cooling	Heating
Capacity Rated (Min. - Max.)	Btu/h		8,800	9,400	11,000	11,300	18,000	17,900	21,200	21,200
Moisture Removal	gal/h		4,400 - 10,200	4,400 - 13,600	4,400 - 13,000	4,400 - 16,200	4,300 - 21,200	4,000 - 22,500	6,000 - 22,200	4,100 - 27,300
COP Rated			3.6		3.3		3.3		3.7	
EER Rated			11		8.5		10.5		11	
SEER							17			
HSPF							9			
Piping Connections	Liquid	in. (mm)	Ø 1/4 (Ø 6.4)				Ø 1/2 (Ø 12.7)		Ø 5/8 (Ø 15.9)	
	Gas		Ø 3/8 (Ø 9.5)							
	Drain						Ø 3/4 (Ø 19.0)			
Max. Interunit Piping Length			65-5/8 (20)				98-1/2 (30)			
Max. Interunit Height Difference	ft. (m)						32-13/16 (10)			
Chargeless							25 (7.6)			
Amount of Additional Charge of Refrigerant	oz/ft (g/m)						0.21 (20)			
Operating Range - Cooling	°F DB						50° - 115°F			
Operating Range - Heating*	°F W/D						5° - 65°F			
Indoor Unit			FTXB09AXVJU		FTXB12AXVJU		FTXB18AXVJU		FTXB24AXVJU	
Airflow Rate	H	cfm (m³/min)	330 (9.3)		360 (10.2)		430 (12.2)		435 (12.3)	
	M		272 (7.7)		282 (8.0)		374 (10.6)		486 (13.8)	
	L		215 (6.1)		232 (6.6)		318 (9.0)		405 (11.5)	
	SL		165 (4.7)		165 (4.7)		274 (7.8)		336 (9.5)	
Fan	Speed	Steps	5 Steps, Quiet, Auto							
Air Direction Control			Horizontal, Downward							
Air Filter			Titanium Apatite							
Dimensions (H x W x D)	in. (mm)		11-11/16 x 35-1/16 x 8-1/4 (297 x 891 x 210)				12-5/8 x 46-1/8 x 9-1/2 (321 x 1172 x 241)			
Weight	lbs. (kg)		20 (9.5)				31 (14)			
Sound Pressure Level (H / M / L / SL)	dB(A)		42 / 35 / 30 / 23		42 / 35 / 32 / 22		40 / 37 / 35 / 32		47 / 44 / 41 / 37	
Outdoor Unit			RXB09AXVJU		RXB12AXVJU		RXB18AXVJU		RXB24AXVJU	
Compressor	Motor Output	W	—							
Refrigerant	Type	R-410A								
	Charge	lbs. (kg)	1-5/8 (.34)		2-1/5 (1)		2-3/4 (1.3)		3-1/5 (1.5)	
Airflow Rate	H	cfm (m³/min)	900 (25.5)		730 (20.7)		1690 (47.9)		1796 (50.9)	
	SL		—		—		—		—	
Dimensions (H x W x D)	in. (mm)		21-5/8 x 25-5/16 x 10-3/4 (549 x 643 x 273)				25-11/16 x 33-11/16 x 12-15/16 (653 x 856 x 328)		29-11/16 x 33-11/16 x 12-15/16 (754 x 856 x 328)	
Weight	lbs. (kg)		53 (24)		57 (26)		82 (37)		97 (44)	
Sound Pressure Level	H	dB(A)	46		48		53		52	

*Applicable to heat pump models only, refer to installation manual for more details.

Unit Combination		Power Supply				Compressor		OFM		IFM	
Indoor Unit	Outdoor Unit	Hz - Volts	Voltage Range	MCA	MOCP	RLA	W	FLA	W	FLA	
FTXB09AXVJU	RXB09AXVJU	60 - 208	Min. 187 V Max. 253 V	6.95	15	6.75	41	0.19	18	0.2	
		60 - 230									
FTXB12AXVJU	RXB12AXVJU	60 - 208	Min. 187 V Max. 253 V	7.95	15	7.5	41	0.19	18	0.2	
		60 - 230									
FTXB18AXVJU	RXB18AXVJU	60 - 208	Min. 187 V Max. 253 V	16.2	20	16	61	0.5	40	0.24	
		60 - 230									
FTXB24AXVJU	RXB24AXVJU	60 - 208	Min. 187 V Max. 253 V	16.2	20	16	61	0.5	40	0.24	
		60 - 230									



Daikin 19 series

Wall-Mounted Cooling Only & Heat Pump Up to 19 SEER | 9.0 HSPF

COMFORTABLE LIMITED WARRANTY* PROTECTION



* Complete warranty details available from your local dealer/contractor or at www.daikincomfort.com. To receive the 12-Year Parts Limited Warranty, online registration must be completed within 60 days of installation. Online registration is not required in California or Quebec.
If product installed in a commercial application, limited warranty period is 5 years.

Daikin 19 series is available in both cooling only and heat pump configuration to offer advanced features and energy savings. Wall-mounted units are simple to install and can be placed subtly, high on a wall, where they do not detract from your décor and operate very quietly. Daikin 19 series is offered with an outstanding 12-year limited warranty* and is ENERGYSTAR® rated, for additional peace of mind.

Standard Features

- » Energy Efficient – Up to 19 SEER, 9.0 HSPF, up to 12.5 EER – Variable-Speed Inverter Compressor
- » Cooling Range: 50° - 115°F (Extended operation to -4° - 115°F with facility setting and air adjustment grille)
- » Heating Range: 5° - 65°F
- » Indoor Sound Pressure as Low as 19 dB(A)
- » Outdoor Sound Pressure as Low as 46 dB(A)
- » Washable Air Filter
- » Program Dry Function
- » Econo Mode.
- » Titanium Apatite Photocatalytic Air Purifying Filter
- » Powerful Operation Mode
- » Backlit Wireless Remote Controller
- » Auto-Changeover (Heat Pump Only)
- » Auto-Fan Speed Control
- » Self Diagnostics with Digital Display
- » Auto-Restart after Power Failure
- » Anti-Corrosion Heat Exchanger Treatment
- » Quick Warming Function (Heat Pump)
- » Hot Start Function (Heat Pump)
- » Automatic Defrosting (Heat Pump)

Optional Features

- » Wired controller
- » Compatible with Daikin Comfort App (adaptor required)

Indoor Unit	Optional Accessories
BRP072A43	Wireless Interface Adaptor (S21 Adaptor Included)
BRC944B2-A08	Wired Remote Controller kit (Adaptor Required)
BRCW901A08	Wired Remote Controller Cord - 8m (Included in above kit)
DACA-BRCW901P10	Remote Controller Cable, Plenum Rated, 10 ft
DACA-BRCW901P25	Remote Controller Cable, Plenum Rated, 25 ft
KRP980B2	Adaptor for wired remote controller (18 & 24)
KRP067A41	Adaptor for wired remote controller (09 & 12)
KAF970A45	Titanium apatite photocatalytic air-purifying filter WITH frame
KAF970A46	Titanium apatite photocatalytic air-purifying filter WITHOUT frame
DACA-CP3-1	Condensate Pump (Fits inside all Daikin indoor unit heads)
Outdoor Unit	Optional Accessories
DACA-WB-1	Powder Coated Wall-Mounted Bracket
KPW063A4	Air direction adjustment grille (18 & 24)
KPW937E4	Air direction adjustment grille (09 & 12)
KKG067A41	Back protection wire net (09 & 12)
KKG063A42	Back protection wire net (18 & 24)
KKG063A43	Side protection wire net (18 & 24)
KKP937A4	Drain Plug for OD Unit
KEH067A41E	Drain pan Heater (09/12)
KEH063A4E	Drain pan Heater (18/24)

IDEAL SOLUTIONS FOR:

- » Renovations, remodeling and new construction
- » Sun rooms, basements, attics, garages, hot or cold rooms, and more
- » Rooms where floor space comes at a premium or is not available for other application
- » Ceiling void or attic does not allow for a viable duct run option
- » Cooling Only models are an excellent value for space not requiring heating



Daikin Comfort App – Easily control your system from anywhere in the world or the comfort of your living room.



Auto-Restart – The unit memorizes the operation mode, airflow and temperature settings. Should there be a power failure when the unit is in operation, it will automatically return to the same operating conditions when the power is restored.



Titanium Apatite Photocatalytic Air Purifying Filter – This filter combines the air-purifying filter and titanium apatite photocatalytic deodorizing filter in a single highly effective unit.



Program Dry Function – This gives priority to reducing the level of humidity in the room rather than room temperature.



Comfort Mode – Comfort Mode operation improves comfort. When cooling, the flap positions itself horizontally to prevent cold airflow from being blown directly onto the body. When heating, the flap turns vertically downwards to drive warm air to the bottom of the room.



Hot Start – (Heat Pump) When the heating operation starts or when the unit changes from cooling to heating, there is no cold draft.



Powerful Operation Mode – Pushing the POWERFUL button on the remote control gives you a boost in cooling or heating power for a 20-minute period, even if the unit is already operating at high capacity.



ARC480A8 - 19 series heat pump shown, ARC480A9 for AC



Proper sizing and installation of equipment is critical to achieve optimal performance. Split system air conditioners and heat pumps must be matched with appropriate coil components to meet **ENERGY STAR®** criteria. Ask your contractor for details or visit www.energystar.gov.

Daikin 19 series

Wall-Mounted Cooling Only

Up to 19 SEER | 12.5 EER

SINGLE-ZONE SYSTEMS



Model	Indoor Unit		FTK09NMVJU	FTK12NMVJU	FTK18NMVJU	FTK24NMVJU
	Outdoor Unit		RK09NMVJU	RK12NMVJU	RK18NMVJU	RK24NMVJU
Capacity Rated (Min. ~ Max.)	Btu/h		9,000 (4,400 ~ 10,200)	10,900 (4,400 ~ 13,300)	18,000 (5,500 ~ 20,000)	21,200 (5,500 ~ 24,000)
Moisture Removal	gal/h		0.32	0.45	1	1.2
EER Rated	12.5					
SEER	19			18		
Piping Connections	Liquid	in. (mm)	Ø 1/4 (Ø 6.4)			
	Gas		Ø 3/8 (Ø 9.5)	Ø 1/2 (Ø 12.7)		Ø 5/8 (Ø 15.9)
	Drain		Ø 5/8 (Ø 16.0)			
Max. Interunit Piping Length			65-5/8 (20)		98-1/2 (30)	
Max. Interunit Height Difference	ft. (m)		49-1/4 (15)		65-5/8 (20)	
Chargeless	32-13/16 (10)					
Amount of Additional Charge of Refrigerant	oz/ft (g/m)		0.21 (20)			
Operating Range - Cooling			50° - 115°F			
Operating Range - Low-Ambient Cooling**	°F DB		5° - 115°F			
Operating Range - Cooling with Optional Air Adjustment Grille**			-4° - 115°F			
Indoor Unit			FTK09NMVJU	FTK12NMVJU	FTK18NMVJU	FTK24NMVJU
Airflow Rate	H	cfm (m³/min)	417 (11.8)	434 (12.3)	713 (20.2)	713 (20.2)
	M		297 (8.4)	311 (8.8)	579 (16.4)	579 (16.4)
	L		244 (6.9)	247 (7.0)	448 (12.7)	512 (14.5)
	SL		141 (4.0)	145 (4.1)	403 (11.4)	403 (11.4)
Fan	Speed	Steps	5 Steps, Quiet, Auto			
Air Direction Control	Right, Left, Horizontal, Downward					
Air Filter	Removable, Washable, Mildew Proof					
Dimensions (H x W x D)	in. (mm)		11-1/4 x 30-5/16 x 8-3/4 (285 x 770 x 223)		11-5/8 x 39 x 10-3/8 (295 x 990 x 263)	
Weight	lbs. (kg)		18 (8)		27 (12)	
Sound Pressure Level (H / M / L / SL)	dB(A)		43 / 36 / 30 / 19	45 / 37 / 30 / 19	49 / 44 / 38 / 33	53 / 45 / 39 / 34
Outdoor Unit			RKN09NMVJU	RKN12NMVJU	RKN18NMVJU	RKN24NMVJU
Compressor	Motor Output	W	790			
Refrigerant	Type		R-410A			
	Charge	lbs. (kg)	1.54 (0.70)	2.09 (0.95)	2.49 (1.13)	3.20 (1.45)
Airflow Rate	H	cfm (m³/min)	1,102 (31.2)	1,105 (31.3)	2,461 (69.7)	2,101 (59.5)
	SL		1,035 (29.3)	865 (24.5)	2,108 (59.7)	1,762 (49.9)
Dimensions (H x W x D)	in. (mm)		21-5/8 x 26-9/16 x 11-3/16 (550 x 675 x 284)		28-15/16 x 34-1/4 x 12-5/8 (735 x 870 x 320)	
Weight	lbs. (kg)		55 (25)	60 (27)	97 (44)	108 (49)
Sound Pressure Level	H	dB(A)	46	49	54	55
ENERGY STAR® Certified			Yes	Yes	Yes	Yes

**Cutting a jumper or a dipswitch setting is required. Refer to installation manual.

Unit Combination		Power Supply				Compressor	OFM		IFM	
Indoor Unit	Outdoor Unit	Hz - Volts	Voltage Range	MCA	MOCP	RLA	W	FLA	W	FLA
FTK09NMVJU	RK09NMVJU	60 - 208	Min. 187 V Max. 253 V	12.1	15	6.8	14	0.13	21	0.20
		60 - 230								
FTK12NMVJU	RK12NMVJU	60 - 208	Min. 187 V Max. 253 V	12.2	15	7.5	18	0.15	28	0.23
		60 - 230								
FTK18NMVJU	RK18NMVJU	60 - 208	Min. 187 V Max. 253 V	18.3	20	10	69	0.45	46	0.3
		60 - 230								
FTK24NMVJU	RK24NMVJU	60 - 208	Min. 187 V Max. 253 V	18.3	20	12	58	0.38	46	0.3
		60 - 230								



19 series

Wall-Mounted Heat Pump

Up to 19 SEER | 9.0 HSPF



Proper sizing and installation of equipment is critical to achieve optimal performance. Split system air conditioners and heat pumps must be matched with appropriate coil components to meet ENERGY STAR® criteria. Ask your contractor for details or visit www.energystar.gov.



Model	Indoor Unit		FTX09NMVJU RX09NMVJU		FTX12NMVJU RX12NMVJU		FTX18NMVJU RX18NMVJU		FTX24NMVJU RX24NMVJU			
	Outdoor Unit		Cooling	Heating	Cooling	Heating	Cooling	Heating	Cooling	Heating		
Capacity Rated (Min. ~ Max.)	Btu/h		9,000 (4,400 ~ 10,200)	10,000 (4,400 ~ 13,000)	10,900 (4,400 ~ 13,300)	13,500 (4,400 ~ 16,400)	18,000 (5,500 ~ 20,000)	21,600 (5,500 ~ 24,000)	21,200 (5,500 ~ 24,000)	24,000 (5,800 ~ 27,600)		
Moisture Removal	gal/h		0.32	—	0.45	—	1	—	1.2	—		
COP Rated			4.06		3.80		3.60		3.50			
EER Rated			12.5		12.5		12.5		12.5			
SEER			19		19		18		18			
HSPF			9		9		9		9			
Piping Connections	Liquid	in. (mm)					Ø 1/4 (Ø 6.4)					
	Gas						Ø 3/8 (Ø 9.5)		Ø 1/2 (Ø 12.7)		Ø 5/8 (Ø 15.9)	
	Drain						Ø 5/8 (Ø 16.0)					
Max. Interunit Piping Length			65-5/8 (20)						98-1/2 (30)			
Max. Interunit Height Difference	ft. (m)		49-1/4 (15)						65-5/8 (20)			
Chargeless							32-13/16 (10)					
Amount of Additional Charge of Refrigerant	oz/ft (g/m)						0.21 (20)					
Operating Range - Cooling							50° - 115°F					
Operating Range - Low-Ambient Cooling**	°F DB						5° - 115°F					
Operating Range - Cooling with Optional Air Adjustment Grille**							-4° - 115°F					
Operating Range - Heating*	°F WB						5° - 65°F					
Indoor Unit			FTX09NMVJU		FTX12NMVJU		FTX18NMVJU		FTX24NMVJU			
Airflow Rate	H	(cfm)	417 (11.8)	403 (11.4)	434 (12.3)	413 (11.7)	713 (20.2)	745 (21.1)	713 (20.2)	745 (21.1)		
	M		297 (8.4)	328 (9.3)	311 (8.8)	321 (9.1)	579 (16.4)	604 (17.1)	579 (16.4)	604 (17.1)		
	L		244 (6.9)	251 (7.1)	247 (7.0)	258 (7.3)	448 (12.7)	470 (13.3)	512 (14.5)	470 (13.3)		
	SL		141 (4.0)	215 (6.1)	145 (4.1)	219 (6.2)	403 (11.4)	420 (11.9)	403 (11.4)	420 (11.9)		
Fan	Speed	Steps	5 Steps, Quiet, Auto									
Air Direction Control			Right, Left, Horizontal, Downward									
Air Filter			Removable, Washable, Mildew Proof									
Dimensions (H x W x D)	in. (mm)		11-1/4 x 30-5/16 x 8-3/4 (285 x 770 x 223)				11-5/8 x 39 x 10-3/8 (295 x 990 x 263)					
Weight	lbs. (kg)		18 (8)				27 (12)					
Sound Pressure Level (H / M / L / SL)	dB(A)		43 / 36 / 30 / 19	43 / 36 / 29 / 25	45 / 37 / 30 / 19	45 / 37 / 30 / 26	49 / 44 / 38 / 33	49 / 42 / 37 / 33	53 / 45 / 39 / 34	53 / 43 / 37 / 34		
Outdoor Unit			RX09NMVJU		RX12NMVJU		RX18NMVJU		RX24NMVJU			
Compressor	Motor Output	W	790				1,100					
Refrigerant	Type	R-410A										
	Charge	lbs. (kg)	1.54 (0.70)		2.09 (0.95)		2.49 (1.13)		3.20 (1.45)			
Airflow Rate	H	(cfm)	1,102 (31.2)	1,006 (28.5)	1,105 (31.3)	922 (26.1)	2,461 (69.7)	2,217 (62.8)	2,101 (59.5)	1,893 (53.6)		
	SL	m³/min	1,035 (29.3)	918 (26.0)	865 (24.5)	777 (22.0)	2,108 (59.7)	1,896 (53.7)	1,762 (49.9)	1,585 (44.9)		
Dimensions (H x W x D)	in. (mm)		21-5/8 x 26-9/16 x 11-3/16 (550 x 675 x 284)				28-15/16 x 34-1/4 x 12-5/8 (735 x 870 x 320)					
Weight	lbs. (kg)		55 (25)		60 (27)		97 (44)		108 (49)			
Sound Pressure Level	H	dB(A)	46	48	49		54		55			
ENERGY STAR® Certified			YES		YES		YES		YES			

*Applicable to heat pump models only, refer to installation manual for more details.

**Cutting a jumper or a dipswitch setting is required. Refer to installation manual.

Unit Combination		Power Supply				Compressor	OFM		IFM	
Indoor Unit	Outdoor Unit	Hz - Volts	Voltage Range	MCA	MOCP	RLA	W	FLA	W	FLA
FTX09NMVJU	RX09NMVJU	60 - 208	Min. 187 V Max. 253 V	12.1	15	8.5	14	0.13	21	0.20
		60 - 230								
		60 - 230								
FTX12NMVJU	RX12NMVJU	60 - 208	Min. 187 V Max. 253 V	12.2	15	8.5	18	0.15	28	0.23
		60 - 230								
		60 - 230								
FTX18NMVJU	RX18NMVJU	60 - 208	Min. 187 V Max. 253 V	18.3	20	10.8	69	0.45	46	0.30
		60 - 230								
		60 - 230								
FTX24NMVJU	RX24NMVJU	60 - 208	Min. 187 V Max. 253 V	18.3	20	12.0	58	0.38	46	0.30
		60 - 230								
		60 - 230								



Daikin EMURA

Wall-Mounted Heat Pump

Up to 18 SEER | Up to 10 HSPF

COMFORTABLE LIMITED WARRANTY* PROTECTION



* Complete warranty details available from your local dealer/contractor or at www.daikincomfort.com. To receive the 12-Year Parts Limited Warranty, online registration must be completed within 60 days of installation. Online registration is not required in California or Quebec. *If product installed in a commercial application, limited warranty period is 5 years.*

The next generation of home air conditioning is here, offering smart technology within a sleek, curved silhouette. Daikin EMURA air conditioners are designed to satisfy a uniquely “Designer” sense of style.

Offering a sophisticated solution for contemporary interiors, the new Daikin EMURA single-zone system combines form and functionality to create an icon of contemporary climate control. Available in silver or pure matte white, Daikin EMURA makes a modern design statement on any wall.

Standard Features

- » Energy Efficient – Up to 18 SEER, 10 HSPF, 11.0 EER
- » Cooling Range: 50° - 115°F (Extended operation to -4° - 115°F with facility setting and air adjustment grille)
- » Heating Range: 5° - 65°F
- » Redesigned PCB in the outdoor unit to withstand extreme conditions
- » Indoor Sound Pressure as Low as 19 dB(A)
- » Outdoor Sound Pressure as Low as 46 dB(A)
- » Washable Air Filter
- » Program Dry Function
- » Econo Mode
- » Titanium Apatite Photocatalytic Air Purifying Filter
- » Powerful Operation Mode
- » Backlit Wireless Remote Controller
- » Outdoor Unit Quiet Operation
- » Auto-Changeover
- » Auto-Fan Speed Control
- » Self Diagnostics with Digital Display
- » Auto-Restart After Power Failure
- » Anti-Corrosion Heat Exchanger Treatment
- » Quick Warming Function
- » Hot Start Function
- » Automatic Defrosting

Optional Features

- » Wired controller
- » Compatible with Daikin Comfort App (adaptor required)

IDEAL SOLUTIONS FOR:

- » Hot & cold regions where homeowners want to enjoy a reliable, energy efficient source of heating and cooling
- » Cold regions where homeowners want to enjoy a reliable, energy efficient source of heat
- » Renovations, remodeling and new construction
- » Sun rooms, basements, attics, garages, hot or cold rooms, and more
- » Rooms where floor space comes at a premium or is not available for other application
- » Ceiling void or attic does not allow for a viable duct run option



2-Area Intelligent Eye – The two-area intelligent eye sensor controls comfort in two ways. If the room is empty for 20 minutes, it changes the set point to start saving energy. As soon as someone enters the room, it immediately returns to the original setting. The intelligent eye also directs air flow away from people in the room to avoid cold drafts.



3-D Airflow – To ensure a harmonized temperature throughout the room, the Daikin EMURA 3D air flow system combines vertical and horizontal auto-swing creating an even distribution of air throughout the room to the corners of even large spaces.



Comfort Mode – Draft-free operation improves comfort. When cooling, the flap positions itself horizontally to prevent cold airflow from being blown directly onto the body. When heating, the flap turns vertically downwards to drive warm air to the bottom of the room.



Night Set Mode – Rapid changes in room temperature can disturb your sleep. To avoid this, Daikin EMURA prevents overheating or over-cooling during the night. If the timer is switched on, the unit will automatically set the temperature to 0.9°F warmer in cooling and 3.6°F cooler in heating.



Clean Air – A sophisticated titanium apatite photo-catalytic air purification filter helps clean the air.

Indoor Unit	Optional Accessories	Outdoor Unit	Optional Accessories	Outdoor Unit	Optional Accessories
BRP072A43	Wireless Interface Adaptor	DACA-WB-1	Powder-Coated Wall-Mounted Bracket	KPS063A41	Snow hood (intake side plate) (18)
BRC944B2-A08	Wired Remote Controller kit	KPW063A4	Air direction adjustment grille (18)	KPS063A44	Snow hood (intake rear plate) (18)
BRCW901A08	Wired Remote Controller Cord - 8m (Included in above kit)	KPW937E4	Air direction adjustment grille (09 & 12)	KPS063A47	Snow hood (outlet) (18)
DACA-BRCW901P10	Remote Controller Cable, Plenum Rated, 10 ft	KEH067A41E	Daikin BMS Drain Pan Heater Small (09 & 12)	KKP937A4	Drain Plug for OD Unit
DACA-BRCW901P25	Remote Controller Cable, Plenum Rated, 25 ft	KEH063A4E	Daikin BML Drain Pan Heater Large (18)	KPS067A42	Snow hood (intake rear plate) (09 & 12)
KAF970A46	Titanium apatite photocatalytic air-purifying filter WITHOUT frame	KKG067A41	Back protection wire net (09 & 12)	KPS067A44	Snow hood (outlet) (09)
DACA-CP4-1	Condensate Pump	KKG063A42	Back protection wire net (18)		
DACA-CP1-1	Inline Condensate Pump	KPS067A41	Snow hood (intake side plate) (09 & 12)		

Daikin EMURA

Wall-Mounted Heat Pump

Up to 18 SEER | Up to 10 HSPF

SINGLE-ZONE SYSTEMS



Model	Indoor Unit		FTXR09TVJUW/S RX09RMVJU9		FTXR12TVJUW/S RX12RMVJU9		FTXR18TVJUW/S RX18RMVJU9	
	Outdoor Unit		Cooling	Heating	Cooling	Heating	Cooling	Heating
Capacity Rated (Min. ~ Max.)	Btu/h		9,000 (4,500 ~ 10,600)	10,000 (4,100 ~ 14,600)	12,000 (4,500 ~ 12,800)	13,500 (4,100 ~ 15,800)	18,000 (5,100 ~ 18,500)	20,000 (5,800 ~ 21,200)
COP Rated			4		3.58		3.34	
EER Rated			11				9.6	
SEER			18		17		14.5	
HSPF			9.3		10		9.8	
Piping Connections	Liquid	in. (mm)	Ø 1/4 (Ø 6.4)					
	Gas		Ø 3/8 (Ø 9.5)				Ø 1/2 (Ø 12.7)	
	Drain		Ø 11/16 (Ø 18.0)					
Max. Interunit Piping Length	ft (m)		65-5/8 (20)		98-1/2 (30)		65-5/8 (20)	
Max. Interunit Height Difference			49-1/4 (15)					
Chargeless			32-13/16 (10)					
Amount of Additional Charge of Refrigerant	oz/ft (g/m)		0.21 (20)					
Operating Range - Cooling			50° - 115°F					
Operating Range - Low-Ambient Cooling*			14° - 115°F					
Operating Range - Cooling with Optional Air Adjustment Grille*			-4° - 115°F					
Operating Range - Heating†			5° - 65°F					
Airflow Rate	Indoor Unit		FTXR09TVJUW/S		FTXR12TVJUW/S		FTXR18TVJUW/S	
	H	cfm (m³/min)	272 (7.7)	346 (9.8)	335 (9.5)	395 (11.2)	350 (9.9)	413 (11.7)
	M		208 (5.9)	258 (7.3)	219 (6.2)	290 (8.2)	275 (7.8)	332 (9.4)
	L		162 (4.6)	201 (5.7)	169 (4.8)	226 (6.4)	226 (6.4)	275 (7.8)
SL	134 (3.8)		117 (3.3)	131 (3.7)	131(3.7)	208 (5.9)	208 (5.9)	
Fan	Speed	Steps	5 Steps, Quiet, Auto					
Air Direction Control			Right, Left, Horizontal, Downward					
Air Filter			Removable, Washable, Mildew Proof					
Dimensions (H × W × D)	in. (mm)		11-15/16 × 39-5/16 × 8-3/8 (303 × 998 × 212)				11-15/16 × 39-5/16 × 8-3/8 (303 × 998 × 212)	
Weight	Lbs (kg)		27 (12)					
Sound Pressure Level (H / M / L / SL)	dB(A)		38 / 32 / 25 / 19	41 / 34 / 28 / 19	45 / 34 / 26 / 20	45 / 37 / 29 / 20	46 / 40 / 35 / 30	47 / 41 / 35 / 30
Refrigerant	Outdoor Unit		RX09RMVJU9		RX12RMVJU9		RX18RMVJU9	
	Type		R-410A					
	Charge	Lbs (kg)	2.09 (0.95)				2.49 (1.13)	
Airflow Rate	H	cfm (m³/min)	985 (27.9)	1130 (32)	1,105 (31.3)	1,130 (32)	2,461 (69.7)	2,553 (72.3)
Dimensions (H × W × D)	in. (mm)		21-5/8 × 26-9/16 × 11-3/16 (550 × 675 × 284)				28-15/16 × 34-1/4 × 12-5/8 (735 × 870 × 320)	
Weight	Lbs (kg)		60 (27)		60 (27)		97 (44)	
Sound Pressure Level	H	dB(A)	46	50	49	51	54	55
ENERGY STAR® Certified			No		No		No	

*Cutting a jumper or a dipswitch setting is required. Refer to installation manual.

Unit Combination		Power Supply				Compressor		OFM		IFM	
Indoor Unit	Outdoor Unit	Hz - Volts	Voltage Range		MCA	MOCP	RLA	W	FLA	W	FLA
FTXR09TVJUW/S	RX09RMVJU9	60 - 208	Min. 187 V Max. 253 V		9	15	7.5	39	0.13	29	0.13
		60 - 230									
FTXR12TVJUW/S	RX12RMVJU9	60 - 208	Min. 187 V Max. 253 V		9.1	15	7.5	39	0.13	29	0.19
		60 - 230									
FTXR18TVJUW/S	RX18RMVJU9	60 - 208	Min. 187 V Max. 253 V		12.8	15	10.75	110	0.38	29	0.21
		60 - 230									

Daikin **AURORA**

Wall-Mounted Heat Pump

Up to 20 SEER | Up to 12.5 HSPF

COMFORTABLE LIMITED WARRANTY* PROTECTION



* Complete warranty details available from your local dealer/contractor or at www.daikincomfort.com. To receive the 12-Year Parts Limited Warranty, online registration must be completed within 60 days of installation. Online registration is not required in California or Quebec.
If product installed in a commercial application, limited warranty period is 5 years.

Total indoor climate control means having the ability to select a desirable temperature for each space in a house and to have that temperature maintained no matter what the temperature outside – from -13°F / -25°C to 114.8°F / 46°C, ensuring all year round comfort. For all regions, the outdoor units of this Daikin **AURORA** heat pump system have been redesigned to withstand extreme weather conditions with excellent energy efficiency ratings.

Standard Features

- » Energy Efficient – Up to 20 SEER, 12.5 HSPF, 13.0 EER
- » Up to 100% Cooling Capacity at 104°F (40°C).
- » Cooling Range: 50° - 115°F (Extended operation to -4° - 115°F with facility setting and air adjustment grille)
- » Heating Range: -13° - 60°F
- » Redesigned PCB in the outdoor unit to withstand extreme conditions
- » Indoor Sound Pressure as Low as 19 dB(A)
- » Outdoor Sound Pressure as Low as 49 dB(A)
- » Washable Air Filter
- » Program Dry Function
- » Econo Mode
- » Titanium Apatite Photocatalytic Air Purifying Filter
- » Powerful Operation Mode
- » Backlit Wireless Remote Controller
- » Outdoor Unit Quiet Operation
- » Auto-Changeover
- » Auto-Fan Speed Control
- » Self Diagnostics with Digital Display
- » Auto-Restart After Power Failure
- » Anti-Corrosion Heat Exchanger Treatment
- » Quick Warming Function
- » Hot Start Function
- » Automatic Defrosting

Optional Features

- » Wired controller
- » Compatible with Daikin Comfort App (adaptor required)

IDEAL SOLUTIONS FOR:

- » Hot & cold regions where homeowners want to enjoy a reliable, energy efficient source of heating and cooling
- » Cold regions where homeowners want to enjoy a reliable, energy efficient source of heat
- » Renovations, remodeling and new construction
- » Sun rooms, basements, attics, garages, hot or cold rooms, and more
- » Rooms where floor space comes at a premium or is not available for other application
- » Ceiling void or attic does not allow for a viable duct run option



Daikin **AURORA heat pump for extreme weather conditions** – Up to 100% heating capacity at 5°F (-15°C) and operate efficiently as low as -13°F ambient temperature.



Daikin Comfort App – Easily control your system from anywhere in the world or the comfort of your living room.



Auto-Restart – The unit memorizes the operation mode, airflow and temperature settings. Should there be a power failure when the unit is in operation, it will automatically return to the same operating conditions when the power is restored.



Titanium Apatite Photocatalytic Air Purifying Filter – This filter combines the air-purifying filter and titanium apatite photocatalytic deodorizing filter in a single highly effective unit.



Comfort Mode – Comfort Mode operation improves comfort. When cooling, the flap positions itself horizontally to prevent cold airflow from being blown directly onto the body. When heating, the flap turns vertically downwards to drive warm air to the bottom of the room.



Hot Start – (Heat Pump) When the heating operation starts or when the unit changes from cooling to heating, there is no cold draft.



Powerful Operation Mode – Pushing the POWERFUL button on the remote control gives you a boost in cooling or heating power for a 20-minute period, even if the unit is already operating at high capacity.

Indoor Unit	Optional Accessories	Outdoor Unit	Optional Accessories	Outdoor Unit	Optional Accessories
BRP072A43	Wireless Interface Adaptor	DACA-WB-1	Powder-Coated Wall-Mounted Bracket	KPS063A41	Snow hood (intake side plate) (15)
BRC944B2-A08	Wired Remote Controller kit (Adaptor Required)	KPW063A4	Air direction adjustment grille (15)	KPS063A44	Snow hood (intake rear plate) (15)
BRCW901A08	Wired Remote Controller Cord - 8m (Included in above kit)	KPW937E4	Air direction adjustment grille (09 & 12)	KPS063A47	Snow hood (outlet) (15)
DACA-BRCW901P10	Remote Controller Cable, Plenum Rated, 10 ft	KEH067A41E	Daikin BMS Drain Pan Heater Small (09 & 12)	KKP937A4	Drain Plug for OD Unit
DACA-BRCW901P25	Remote Controller Cable, Plenum Rated, 25 ft	KEH063A4E	Daikin BML Drain Pan Heater Large (15)		
KRP980B2	Adaptor for wired remote controller (15)	KKG067A41	Back protection wire net (09 & 12)		
KRP067A41	Adaptor for wired remote controller (09 & 12)	KKG063A42	Back protection wire net (15)		
KAF970A45	Titanium apatite photocatalytic air-purifying filter WITH frame	KPS067A41	Snow hood (intake side plate) (09 & 12)		
KAF970A46	Titanium apatite photocatalytic air-purifying filter WITHOUT frame	KPS067A42	Snow hood (intake rear plate) (09 & 12)		
DACA-CP3-1	Condensate Pump (Fits inside all Daikin indoor unit heads)	KPS067A44	Snow hood (outlet) (09 & 12)		



Proper sizing and installation of equipment is critical to achieve optimal performance. Split system air conditioners and heat pumps must be matched with appropriate coil components to meet **ENERGY STAR®** criteria. Ask your contractor for details or visit www.energystar.gov.

Daikin **AURORA** Wall-Mounted Heat Pump

Up to 20 SEER | Up to 12.5 HSPF



Our outdoor unit drain pans have up to 14 holes which allows for effective drainage of condensation. In some cases, this improved drain pan design eliminates the need for drain pan heaters, resulting in higher efficiencies in low ambient temperatures.

SINGLE-ZONE SYSTEMS

Model	Indoor Unit		FTX09NMVJU RXL09QMVJU		FTX12NMVJU RXL12QMVJU		FTX15NMVJU RXL15QMVJU	
	Outdoor Unit		Cooling	Heating	Cooling	Heating	Cooling	Heating
Capacity Rated (Min. ~ Max.)	Btu/h		9,000 (4,400 ~ 10,900)	10,900 (4,400 ~ 16,000)	10,900 (4,400 ~ 13,300)	13,600 (4,400 ~ 18,800)	15,000 (5,800 ~ 18,400)	18,300 (5,800 ~ 24,600)
Moisture Removal	gal/h		0.32	—	0.45	—	0.63	—
COP Rated			4.20		3.90		4.00	
EER Rated			12.5		12.5		13	
SEER			12.5		12		12.5	
Piping Connections	Liquid	in. (mm)	Ø 1/4 (Ø 6.4)					
	Gas		Ø 3/8 (Ø 9.5)					
	Drain		Ø 5/8 (Ø 16.0)					
Max. Interunit Piping Length			65-5/8 (20)				98-1/2 (30)	
Max. Interunit Height Difference		ft. (m)	49-1/4 (15)				65-5/8 (20)	
Chargeless					32-13/16 (10)			
Amount of Additional Charge of Refrigerant	oz/ft (g/m)				0.21 (20)			
Operating Range - Cooling					50° - 115°F			
Operating Range - Low-Ambient Cooling*	°F DB				5° - 115°F			
Operating Range - Cooling with Optional Air Adjustment Grille*					-4° - 115°F			
Operating Range - Heating†	°F WB				-13° - 60°F			
Indoor Unit			FTX09NMVJU		FTX12NMVJU		FTX15NMVJU	
Airflow Rate	H	cfm (m³/min)	417 (11.8)	403 (11.4)	434 (12.3)	413 (11.7)	593 (16.8)	653 (18.5)
	M		297 (8.4)	328 (9.3)	311 (8.8)	321 (9.1)	505 (14.3)	554 (15.7)
	L		244 (6.9)	251 (7.1)	247 (7.0)	258 (7.3)	431 (12.2)	470 (13.3)
	SL		141 (4.0)	215 (6.1)	145 (4.1)	219 (6.2)	367 (10.4)	399 (11.3)
Fan	Speed	Steps	5 Steps, Quiet, Auto					
Air Direction Control			Right, Left, Horizontal, Downward					
Air Filter			Removable, Washable, Mildew Proof					
Dimensions (H x W x D)		in. (mm)	11-1/4 x 30-5/16 x 8-3/4 (285 x 770 x 223)				11-5/8 x 39 x 10-3/8 (295 x 990 x 263)	
Weight		lbs. (kg)	18 (8)				27 (12)	
Sound Pressure Level (H / M / L / SL)		dB(A)	43 / 36 / 30 / 19	43 / 36 / 29 / 25	45 / 37 / 30 / 19	45 / 37 / 30 / 26	45 / 41 / 36 / 33	45 / 41 / 37 / 33
Outdoor Unit			RXL09QMVJU		RXL12QMVJU		RXL15QMVJU	
Compressor	Motor Output	W	790		1,100			
Refrigerant	Type		R-410A					
	Charge	lbs. (kg)	2.09 (0.95)		3.20 (1.45)			
Airflow Rate	H	cfm (m³/min)	1,105 (31.3)	922 (26.1)	1,144 (32.4)	1,006 (28.5)	2,044 (57.9)	2,044 (57.9)
	SL		865 (24.5)	777 (22.0)	865 (24.5)	777 (22.0)	1,762 (49.9)	1,585 (44.9)
Dimensions (H x W x D)		in. (mm)	21-5/8 x 26-9/16 x 11-3/16 (550 x 675 x 284)				28-15/16 x 34-1/4 x 12-5/8 (735 x 870 x 320)	
Weight		lbs. (kg)	60 (27)		70 (32)		108 (49)	
Sound Pressure Level	H	dB(A)	49		50		50	55
ENERGY STAR® Certified			YES		YES		YES	

*Cutting a jumper or a dipswitch setting is required. Refer to installation manual.

†The installation of an optional drain-pan is recommended in areas where ambient temperature may fall below 5°F (-15°C) or in areas of heavy snowfall or high levels of wintertime humidity.

Unit Combination		Power Supply				Compressor	OFM			IFM	
Indoor Unit	Outdoor Unit	Hz - Volts	Voltage Range	MCA	MOCP	RLA	W	FLA	W	FLA	
FTX09NMVJU	RXL09QMVJU	60 - 208	Min. 187 V Max. 253 V	9.5	15	8.5	18	0.15	21	0.20	
		60 - 230									
		60 - 208									
FTX12NMVJU	RXL12QMVJU	60 - 208	Min. 187 V Max. 253 V	13	15	12	20	0.17	28	0.23	
		60 - 230									
		60 - 208									
FTX15NMVJU	RXL15QMVJU	60 - 208	Min. 187 V Max. 253 V	13	15	11.8	71	0.47	33	0.23	
		60 - 230									
		60 - 208									

Daikin **AURORA**

Floor-Mounted Heat Pump

Up to 20 SEER | Up to 11.7 HSPF

COMFORTABLE LIMITED WARRANTY* PROTECTION



* Complete warranty details available from your local dealer/contractor or at www.daikincomfort.com. To receive the 12-Year Parts Limited Warranty, online registration must be completed within 60 days of installation. Online registration is not required in California or Quebec. *If product installed in a commercial application, limited warranty period is 5 years.*

Daikin **AURORA** floor-mounted units are simple to install and can be setup in various configurations, on the floor or hanging low on a wall. Its low height enables the unit to fit perfectly beneath a window. The airflow distribution pattern of Daikin's floor-mounted unit is ideal for heating or cooling a space, and is a perfect replacement to traditional radiant systems. For all regions, the outdoor units of this Daikin **AURORA** heat pump system have been redesigned to withstand extreme weather conditions with excellent energy efficiency ratings, from -13°F / -25°C to 114°F / 46°C outside.

Standard Features

- » Energy Efficient – Up to 20 SEER, 11.7 HSPF, 12.5 EER
- » Up to 100% Cooling Capacity at 104°F (40°C).
- » Cooling Range: 50° - 115°F (Extended operation to -4° - 115°F with facility setting and air adjustment grille)
- » Heating Range: -13° - 60°F
- » Redesigned PCB in the outdoor unit to withstand extreme conditions
- » Indoor Sound Pressure as Low as 23 dB(A)
- » Outdoor Sound Pressure as Low as 49 dB(A)
- » Washable Air Filter
- » Program Dry Function
- » Econo Mode
- » Titanium Apatite Photocatalytic Air Purifying Filter
- » Powerful Operation Mode
- » Backlit Wireless Remote Controller
- » Outdoor Unit Quiet Operation
- » Auto-Changeover
- » Auto-Fan Speed Control
- » Self Diagnostics with Digital Display
- » Auto-Restart After Power Failure
- » Anti-Corrosion Heat Exchanger Treatment
- » Quick Warming Function
- » Hot Start Function
- » Automatic Defrosting

Optional Features

- » Wired controller
- » Compatible with Daikin Comfort App (adaptor required)

IDEAL SOLUTIONS FOR:

- » Hot & cold regions where homeowners want to enjoy a reliable, energy efficient source of heating and cooling
- » Cold regions where homeowners want to enjoy a reliable, energy efficient source of heat
- » Renovations, remodeling and new construction
- » Sun rooms, basements, garages, hot or cold rooms, attics where the walls tend to be lower, or wherever wall space is at a premium
- » Ceiling void or attic does not allow for a viable duct run option



Daikin **AURORA heat pump for extreme weather conditions** – Up to 100% heating capacity at 5°F (-15°C) and operate efficiently as low as -13°F ambient temperature.



Daikin Comfort App – Easily control your system from anywhere in the world or the comfort of your living room.



Auto-Restart – The unit memorizes the operation mode, airflow and temperature settings. Should there be a power failure when the unit is in operation, it will automatically return to the same operating conditions when the power is restored.



Titanium Apatite Photocatalytic Air Purifying Filter – This filter combines the air-purifying filter and titanium apatite photocatalytic deodorizing filter in a single highly effective unit.



Comfort Mode – Comfort Mode operation improves comfort. When cooling, the flap positions itself horizontally to prevent cold airflow from being blown directly onto the body. When heating, the flap turns vertically downwards to drive warm air to the bottom of the room.



Hot Start – (Heat Pump) When the heating operation starts or when the unit changes from cooling to heating, there is no cold draft.



Powerful Operation Mode – Pushing the POWERFUL button on the remote control gives you a boost in cooling or heating power for a 20-minute period, even if the unit is already operating at high capacity.

Indoor Unit	Optional Accessories	Outdoor Unit	Optional Accessories	Outdoor Unit	Optional Accessories
BRP072A43	Wireless Interface Adaptor	DACA-WB-1	Powder-Coated Wall-Mounted Bracket	KPS067A41	Snow hood (intake side plate) (09 & 12)
BRC944B2-A08	Wired Remote Controller kit (Adaptor Required)	KPW063A4	Air direction adjustment grille (15)	KPS067A42	Snow hood (intake rear plate) (09 & 12)
BRCW901A08	Wired Remote Controller Cord - 8m (Included in above kit)	KPW937E4	Air direction adjustment grille (09 & 12)	KPS067A44	Snow hood (outlet) (09 & 12)
DACA-BRCW901P10	Remote Controller Cable, Plenum Rated, 10 ft	KEH067A41E	Daikin BMS Drain Pan Heater Small (09 & 12)	KPS063A41	Snow hood (intake side plate) (15)
DACA-BRCW901P25	Remote Controller Cable, Plenum Rated, 25 ft	KEH063A4E	Daikin BML Drain Pan Heater Large (15)	KPS063A44	Snow hood (intake rear plate) (15)
KAF968B42	Titanium apatite photocatalytic air-purifying filter WITH frame	KKG067A41	Back protection wire net (09 & 12)	KPS063A47	Snow hood (outlet) (15)
DACA-CP3-1	Condensate Pump (Fits inside all Daikin indoor unit heads)	KKG063A42	Back protection wire net (15)	KKP937A4	Drain Plug for OD Unit



Proper sizing and installation of equipment is critical to achieve optimal performance. Split system air conditioners and heat pumps must be matched with appropriate coil components to meet **ENERGY STAR**® criteria. Ask your contractor for details or visit www.energystar.gov.

Daikin **AURORA** Floor-Mounted Heat Pump

Up to 20 SEER | Up to 11.7 HSPF



Our outdoor unit drain pans have up to 14 holes which allows for effective drainage of condensation. In some cases, this improved drain pan design eliminates the need for drain pan heaters, resulting in higher efficiencies in low ambient temperatures.

SINGLE-ZONE SYSTEMS

Model	Indoor Unit		FVXS09NVJU RXL09QMVJU		FVXS12NVJU RXL12QMVJU		FVXS15NVJU RXL15QMVJU	
	Outdoor Unit		Cooling	Heating	Cooling	Heating	Cooling	Heating
Capacity Rated (Min. – Max.)		Btu/h	9,000 (4,400 ~ 10,200)	10,100 (4,400 ~ 14,300)	10,200 (4,400 ~ 12,300)	13,000 (4,400 ~ 17,100)	15,000 (5,800 ~ 17,100)	18,000 (5,800 ~ 24,000)
Moisture Removal		gal/h	0.32	—	0.45	—	0.63	—
COP Rated			4.10		4.00		3.76	
EER Rated			12.5		12.0		12.5	
SEER			11.7		11.4		11.3	
Piping Connections	Liquid	in. (mm)			Ø 1/4 (Ø 6.4)			
	Gas				Ø 3/8 (Ø 9.5)		Ø 1/2 (Ø 12.7)	
	Drain				Ø 13/16 (Ø 20.0)			
Max. Interunit Piping Length			65-5/8 (20)				98-1/2 (30)	
Max. Interunit Height Difference		ft. (m)	49-1/4 (15)				65-5/8 (20)	
Chargeless					32-13/16 (10)			
Amount of Additional Charge of Refrigerant		oz/ft (g/m)			0.21 (20)			
Operating Range - Cooling					50° - 115°F			
Operating Range - Low-Ambient Cooling**		°F DB			5° - 115°F			
Operating Range - Cooling with Optional Air Adjustment Grille**					4° - 115°F			
Operating Range - Heating†		°F WB			-13° - 60°F			
	Indoor Unit		FVXS09NVJU		FVXS12NVJU		FVXS15NVJU	
Airflow Rate	H	cfm (m³/min)	290 (8.2)	311 (8.8)	300 (8.5)	332 (9.4)	378 (10.7)	417 (11.8)
	M		230 (6.5)	244 (6.9)	237 (6.7)	258 (7.3)	325 (9.2)	357 (10.1)
	L		169 (4.8)	177 (5.0)	173 (4.9)	184 (5.2)	275 (7.8)	300 (8.5)
	SL		145 (4.1)	155 (4.4)	159 (4.5)	166 (4.7)	233 (6.6)	251 (7.1)
Fan	Speed	Steps	5 Steps, Quiet, Auto					
Air Direction Control			Right, Left, Horizontal, Downward					
Air Filter			Removable, Washable, Mildew Proof					
Dimensions (H × W × D)		in. (mm)	23-5/8 × 27-9/16 × 8-1/4 (600 × 700 × 210)					
Weight		lbs. (kg)	31 (14)					
Sound Pressure Level (H / M / L / SL)		dB(A)	38 / 32 / 26 / 23	38 / 32 / 26 / 23	39 / 33 / 27 / 24	39 / 33 / 27 / 24	44 / 40 / 36 / 32	45 / 40 / 36 / 32
	Outdoor Unit		RXL09QMVJU		RXL12QMVJU		RXL15QMVJU	
Compressor	Motor Output	W	790		1,100			
Refrigerant	Type		R-410A					
	Charge	lbs. (kg)	2.09 (0.95)		3.20 (1.45)			
Airflow Rate	H	cfm (m³/min)	1,106 (31.3)	922 (26.1)	1,114 (32.4)	2,045 (57.9)	2,045 (57.9)	2,045 (57.9)
	SL		865 (24.5)	777 (22.0)	865 (24.5)	777 (22.0)	1,762 (49.9)	1,586 (44.9)
Dimensions (H × W × D)		in. (mm)	21-5/8 × 26-9/16 × 11-3/16 (550 × 675 × 284)			28-15/16 × 34-1/4 × 12-5/8 (735 × 870 × 320)		
Weight		lbs. (kg)	60 (27)		70 (32)		108 (49)	
Sound Pressure Level	H	dB(A)	49		50		50	55
ENERGY STAR® Certified*			YES		NO		YES	

* Proper sizing and installation of equipment is critical to achieve optimal performance. Split system air conditioners and heat pumps must be matched with appropriate coil components to meet **ENERGY STAR** criteria. Ask your contractor for details or visit www.energystar.gov.

**Cutting a jumper or a dipswitch setting is required. Refer to installation manual.

†The installation of an optional drain-pan is recommended in areas where ambient temperature may fall below 5° (-15°C) or in areas of heavy snowfall or high levels of wintertime humidity.

Unit Combination		Power Supply				Compressor	OFM		IFM	
Indoor Unit	Outdoor Unit	Hz - Volts	Voltage Range	MCA	MOCP	RLA	W	FLA	W	FLA
FVXS09NVJU	RXL09QMVJU	60 - 208	Min. 187 V Max. 253 V	9.5	15	8.5	18	0.15	12	0.21
		60 - 230								
FVXS12NVJU	RXL12QMVJU	60 - 208	Min. 187 V Max. 253 V	13	15	12	20	0.17	13	0.22
		60 - 230								
FVXS15NVJU	RXL15QMVJU	60 - 208	Min. 187 V Max. 253 V	13	15	11.8	71	0.47	23	0.29
		60 - 230								



VISTA

Ceiling Cassette Heat Pump

Up to 20.9 SEER | Up to 11.7 HSPF

COMFORTABLE LIMITED WARRANTY* PROTECTION



* Complete warranty details available from your local dealer/contractor or at www.daikincomfort.com. To receive the 12-Year Parts Limited Warranty, online registration must be completed within 60 days of installation. Online registration is not required in California or Quebec. If product installed in a commercial application, limited warranty period is 5 years.

Daikin VISTA ceiling cassette heat pumps are a remarkable blend of iconic design and engineering excellence with an elegant white or a silver and white finish. Fitting within the ceiling grid and discreetly mounted to the ceiling itself, VISTA ceiling cassette is stylish, low profile, and compact. High efficiency and comfort is delivered through the combined use of floor and presence sensors (optional). It is also possible to close individual louvers via the wired remote control for personalized comfort.

Standard Features

- » Seamless integration in standard architectural ceiling tiles, leaving only 5/16"
- » High efficiencies with up to 20.9 SEER and up to 11.7 HSPF
- » Cooling Range: 50° - 115°F (Extended operation to -4° - 115°F with facility setting and air adjustment grille)
- » Heating Range: 5° - 65°F
- » Energy efficient thanks to specially developed small tube heat exchanger, DC fan motor and two optional intelligent sensors
- » Remarkable blend of iconic design and engineering excellence with an elegant finish in white or a combination of silver and white
- » No optional adaptor needed for DIII-connection, link your unit into the wider building management system
- » Fresh air integration possible
- » 12-Year Parts Limited Warranty*

Optional Features

- » Wired controller
- » Fresh air integration possible
- » Presence and Floor Sensor
- » Compatible with DKN Cloud Wi-Fi Adaptor

Indoor Unit	Optional Accessories
BRYQ60A2S	Sensor kit (Silver) Intelligent Eye, and Floor Sensor
BRYQ60A2W	Sensor kit (White) Intelligent Eye, and Floor Sensor
BDBHQ44C60	Sealing member of air discharge outlet
KAFQ441BA60	Long life filter
BYFQ60C2W1S	Low Profile Decoration Panel (Silver) - 1- ³ / ₁₆ × 24- ⁷ / ₁₆ × 24- ⁷ / ₁₆
AZAI6WSCDKA	DKN Cloud Wi-Fi Adaptor (Requires BRC1E73)
BYFQ60C2W1W	Low Profile Decoration Panel (White) - 1- ³ / ₁₆ × 24- ⁷ / ₁₆ × 24- ⁷ / ₁₆
Outdoor Unit	Optional Accessories
DACA-WB-1	Powder-Coated Wall-Mounted Bracket
KPW937E4	Air direction adjustment grille (09 & 12)
KPW063A4	Air direction adjustment grille (15 & 18)
KEH067A41E	Daikin BMS Drain Pan Heater Small (09 & 12)
KEH063A4E	Daikin BML Drain Pan Heater Large (15 & 18)
KKG067A41	Back protection wire net (09 & 12)
KKG063A42	Back protection wire net (15 & 18)
KPS067A41	Snow hood (intake side plate) (09 & 12)
KPS067A42	Snow hood (intake rear plate) (09 & 12)
KPS067A44	Snow hood (outlet) (09 & 12)
KPS063A41	Snow hood (intake side plate) (15 & 18)
KPS063A44	Snow hood (intake rear plate) (15 & 18)
KPS063A47	Snow hood (outlet) (15 & 18)
KKP937A4	Drain Plug for OD Unit



Draft Reduction – This system directs warm air to the floor in winter and cool air across the room in summer for optimal efficiency and comfort. The large flap governs airflow direction while the small flap (or diffuser) swings, producing fine air currents that help circulate the air around the room.



Individual Louver Control – The new louver changes the delivery angle to horizontal for cooling and vertical for heating operation, to keep cold or warm air from blowing directly onto your body.



Included in the optional sensor kit:

Presence and Floor Sensor (optional part #BRYQ60A2W or BRYQ60A2S)

The presence and floor sensors are infrared sensors with the ability to sense movement in the room. When you are in the room, the system operates normally. If you leave the room for more than 20 minutes the system automatically changes to an energy-saving operation. Using the intelligent eye, savings of up to 20% in cooling and up to 30% in heating can be achieved. The floor sensor detects the average floor temperature and ensures even temperature distribution between ceiling and floor.

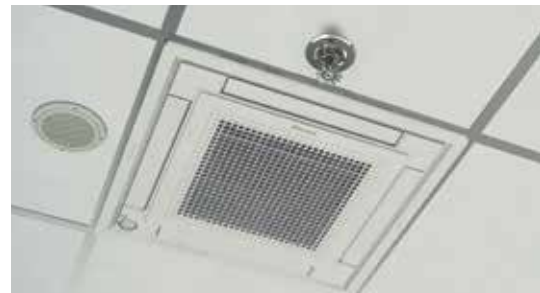

The VISTA Ceiling Cassette fits within a 2'x 2' ceiling grid and can be installed in close proximity to other building accessories.



Proper sizing and installation of equipment is critical to achieve optimal performance. Split system air conditioners and heat pumps must be matched with appropriate coil components to meet **ENERGY STAR®** criteria. Ask your contractor for details or visit www.energystar.gov.

VISTA

Ceiling Cassette Heat Pump

Up to 20.9 SEER | Up to 11.7 HSPF



SINGLE-ZONE SYSTEMS

Model	Indoor Unit		FFQ09Q2VJU RX09RMVJU9		FFQ12Q2VJU RX12RMVJU9		FFQ15Q2VJU RX15RMVJU		FFQ18Q2VJU RX18RMVJU9	
	Outdoor Unit		Cooling	Heating	Cooling	Heating	Cooling	Heating	Cooling	Heating
Capacity Rated (Min. ~ Max.)	Btu/h		9,100 (4,600 - 11,000)	10,000 (4,600 - 14,000)	10,800 (4,600 - 13,300)	13,500 (4,600 - 16,800)	14,400 (5,100 - 16,200)	16,200 (5,200 - 16,300)	17,400 (5,100 - 18,800)	21,600 (5,400 - 21,800)
Moisture Removal	gal/h		N/A	-	N/A	-	N/A	-	N/A	-
COP Rated			4.58		4.02		3.86		3.36	
EER Rated			13.0		12.5		12.5		12.5	
SEER			20.9		20.2		20.7		19.3	
HSPF			11.7		11.2		11.0		10.1	
Piping Connections	Liquid	in. (mm)	Ø 1/4 (Ø 6.4)				Ø 1/2 (Ø 12.7)			
	Gas		Ø 3/8 (Ø 9.5)				Ø 1-1/32 (Ø 26.0)			
	Drain									
Max. Interunit Piping Length			65-5/8 (20)				98-7/16 (30)			
Max. Interunit Height Difference			49-1/4 (15)				65-5/8 (20)			
Chargeless							32-13/16 (10)			
Amount of Additional Charge of Refrigerant	oz/ft (g/m)						0.21 (20)			
Operating Range - Cooling							50° - 115°F			
Operating Range - Low-Ambient Cooling*							14° - 115°F			
Operating Range - Cooling with Optional Air Adjustment Grille*							-4° - 115°F			
Operating Range - Heating	°F WB						5° - 65°			
Indoor Unit			FFQ09Q2VJU		FFQ12Q2VJU		FFQ15Q2VJU		FFQ18Q2VJU	
Airflow Rate	H	cfm (m³/min)	378 (10.7)	399 (11.3)	406 (11.5)	427 (12.1)	420 (11.9)	441 (12.5)	448 (12.7)	498 (14.1)
	M		339 (9.6)	357 (10.1)	353 (10.0)	371 (10.5)	367 (10.4)	385 (10.9)	378 (10.7)	420 (11.9)
	L		268 (7.6)	282 (8.0)	268 (7.6)	282 (8.0)	293 (8.3)	307 (8.7)	275 (7.8)	307 (8.7)
	SL		-	-	-	-	-	-	-	-
Fan	Speed	Steps	Turbo Fan, 3 Steps, Quiet, Auto							
Air Direction Control			Right, Left, Horizontal, Downward							
Air Filter			Removable, Washable, Mildew Proof							
Dimensions (H x W x D)	in. (mm)		10-1/4 x 22-5/8 x 22-5/8 (260 x 575 x 575)							
Weight	lbs. (kg)		36 (16)				39 (17.5)			
Sound Pressure Level (H / M / L / SL)	dB(A)		38 / 35 / 29		39 / 36 / 30		40 / 37 / 31		44 / 40 / 32	
Outdoor Unit			RX09RMVJU9		RX12RMVJU9		RX15RMVJU		RX18RMVJU9	
Compressor	Motor Output	W	790				1,100		1,100	
Refrigerant	Type		R-410A							
	Charge	lbs. (kg)	2.09 (0.95)				2.49 (1.13)			
Airflow Rate	H	cfm (m³/min)	985 (27.9)	1,105 (31.3)	1,105 (31.3)	1,105 (31.3)	2,314 (65.53)	2,108 (59.7)	2,461 (69.7)	2,553 (72.3)
Dimensions (H x W x D)	in. (mm)		21-5/8 x 26-9/16 x 11-3/16 (550 x 675 x 284)				28-15/16 x 34-1/4 x 12-5/8 (735 x 870 x 320)			
Weight	lbs. (kg)		60 (27)				97 (44)			
Sound Pressure Level	H	dB(A)	46	50	49	51	50	51	54	55
ENERGY STAR® Certified*			YES		YES		YES		YES	

*Cutting a jumper or a dipswitch setting is required. Refer to installation manual.

Unit Combination		Power Supply				Compressor	OFM		IFM		
Indoor Unit	Outdoor Unit	Hz - Volts	Voltage Range		MCA	MOCP	RLA	W	FLA	W	FLA
FFQ09Q2VJU	RX09RMVJU9	60 - 208	Min. 187 V Max. 253 V		9.0	15	7.5	39	0.13	50	0.28
		60 - 230									
FFQ12Q2VJU	RX12RMVJU9	60 - 208	Min. 187 V Max. 253 V		9.1	15	7.5	39	0.13	50	0.28
		60 - 230									
FFQ15Q2VJU	RX15RMVJU	60 - 208	Min. 187 V Max. 253 V		9.7	15	8.0	91	0.31	50	0.28
		60 - 230									
FFQ18Q2VJU	RX18RMVJU9	60 - 208	Min. 187 V Max. 253 V		12.8	15	10.75	110	0.38	50	0.28
		60 - 230									

LV series

Wall-Mounted Heat Pump

Up to 24.5 SEER | Up to 12.5 HSPF

COMFORTABLE LIMITED WARRANTY* PROTECTION



* Complete warranty details available from your local dealer/contractor or at www.daikincomfort.com. To receive the 12-Year Parts Limited Warranty, online registration must be completed within 60 days of installation. Online registration is not required in California or Quebec. If product installed in a commercial application, limited warranty period is 5 years.

LV series is a feature-packed, intelligent wall-mounted system that includes intelligent eye for energy savings and horizontal auto swing outlet fins for 3-D airflow comfort. With up to 24.5 SEER level, LV series has been awarded the ENERGYSTAR® Most Efficient Mark in 2018.

Standard Features

- » Energy Efficient – Up to 24.5 SEER, 12.5 HSPF, up to 15.3 EER – Variable-Speed Inverter Compressor
- » Cooling Range: 50° - 115°F (Extended operation to 0° - 115°F with facility setting and air adjustment grille)
- » Heating Range: 5° - 65°F
- » Indoor Sound Pressure as Low as 22 dB(A)
- » Outdoor Sound Pressure as Low as 43 dB(A)
- » Intelligent Eye
- » Power airflow dual flaps and 3-D Airflow
- » Titanium Apatite Photocatalytic Air Purifying Filter
- » Weekly timer
- » Program Dry Function
- » Econo Mode
- » Powerful Operation Mode
- » Backlit Wireless Remote Controller
- » Auto-Changeover
- » Auto-Fan Speed Control
- » Self Diagnostics with Digital Display
- » Auto-Restart After Power Failure
- » Anti-Corrosion Heat Exchanger Treatment
- » Quick Warming Function
- » Hot Start Function
- » Automatic Defrosting

Optional Features

- » Wired controller
- » Compatible with Daikin Comfort App (adaptor required)

Indoor Unit	Optional Accessories
BRP072A43	Wireless Interface Adaptor
BRC944B2-A08	Wired Remote Controller
BRCW901A08	Wired Remote Controller Cord - 3m
DACA-BRCW901P10	Remote Controller Cable, Plenum Rated, 10 ft
DACA-BRCW901P25	Remote Controller Cable, Plenum Rated, 25 ft
DACA-ARCW901P10	IR Receiver Cable, Plenum Rated, 10ft
DACA-ARCW901P25	IR Receiver Cable, Plenum Rated, 25ft
DACA-CP3-1	Condensate Pump (Fits inside all Daikin indoor unit heads)
Outdoor Unit	Optional Accessories
DACA-WB-3	Powder Coated Wall-Mounted Bracket
KEH041A41	Drain Pan Heater (09x12)
KEH041A42	Drain Pan Heater (15x18)
KEH041A43	Drain Pan Heater (24)
KKP937A4	Drain Plug (9,12,15,18)
KKP945A4	Drain Plug (24)
KPW937C4	Air Direction Adjustment Grille (09, 12)
KPW945A4	Air Direction Adjustment Grille (15,18,24)

IDEAL SOLUTIONS FOR:

- » Renovations, remodeling and new construction
- » Sun rooms, basements, garages, hot or cold rooms, attics where the walls tend to be lower, or wherever wall space is at a premium
- » Ceiling void or attic does not allow for a viable duct run option
- » Homeowners desiring advanced features for comfort and savings



Daikin Comfort App – Easily control your system from anywhere in the world or the comfort of your living room.



3-D Airflow – Combines vertical and horizontal auto-swing to circulate cool/warm air to the corners of large spaces.



Intelligent Eye – The intelligent eye is an infrared sensor with the ability to sense movement in the room. When you are in the room, the air conditioner operates normally. If you leave the room for more than 20 minutes the air conditioner automatically changes to an energy-saving operation. Using the intelligent eye, savings of up to 20% in cooling and up to 30% in heating can be achieved compared to units without this feature.



Auto-Restart – The unit memorizes the operation mode, airflow and temperature settings. Should there be a power failure when the unit is in operation, it will automatically return to the same operating conditions when the power is restored.



Titanium Apatite Photocatalytic Air Purifying Filter – This filter combines the air-purifying filter and titanium apatite photocatalytic deodorizing filter in a single highly effective unit.



Hot Start – (Heat Pump) When the heating operation starts or when the unit changes from cooling to heating, there is no cold draft.



Powerful Operation Mode – Pushing the POWERFUL button on the remote control gives you a boost in cooling or heating power for a 20-minute period, even if the unit is already operating at high capacity.





Proper sizing and installation of equipment is critical to achieve optimal performance. Split system air conditioners and heat pumps must be matched with appropriate coil components to meet **ENERGY STAR®** criteria. Ask your contractor for details or visit www.energystar.gov.

LV series Wall-Mounted Heat Pump

Up to 24.5 SEER | Up to 12.5 HSPF



SINGLE-ZONE SYSTEMS

Model	Indoor Unit		FTXS09LVJU		FTXS12LVJU		FTXS15LVJU		FTXS18LVJU		FTXS24LVJU			
	Outdoor Unit		RXS09LVJU		RXS12LVJU		RXS15LVJU		RXS18LVJU		RXS24LVJU			
			Cooling	Heating	Cooling	Heating	Cooling	Heating	Cooling	Heating	Cooling	Heating		
Capacity Rated (Min. ~ Max.)	Btu/h		9,000 (4,400 ~ 9,000)	12,000 (4,400 ~ 12,000)	12,000 (4,800 ~ 12,000)	14,400 (4,800 ~ 14,400)	15,000 (5,800 ~ 15,000)	18,000 (5,800 ~ 18,000)	18,000 (5,800 ~ 18,000)	21,600 (5,800 ~ 21,600)	21,500 (7,800 ~ 21,500)	25,400 (7,800 ~ 25,400)		
Moisture Removal	gal/h		0.3 (1.1)	—	0.5 (1.9)	—	0.8 (3.0)	—	1.0 (3.8)	—	1.2 (4.5)	—		
COP Rated			4.46		4.35		4.00		3.70		3.37			
EER Rated			15.3		12.8		14.4		12.7		12.5			
SEER			24.5		23.0		20.6		20.3		20.0			
HSPF			12.5		12.5		11.6		11.0		10.6			
Piping Connections	Liquid	in. (mm)	Ø 3/8 (9.5)				Ø 1/4 (6.4)				Ø 1/2 (12.7)			
	Gas													
	Drain													
Max. Interunit Piping Length			65.6 (20)				98.4 (30)				65.6 (20)			
Max. Interunit Height Difference	ft. (m)		49.2 (15)											
Chargeless							32.8 (10)							
Amount of Additional Charge of Refrigerant	oz/ft (g/m)						0.21 (20)							
Operating Range - Cooling*	°F DB						14° - 115°F							
Operating Range - Cooling with Optional Air Adjustment Grille*	°F DB						0° - 115°F							
Operating Range - Heating	°F WB						5° - 65°F							
Indoor Unit			FTXS09LVJU		FTXS12LVJU		FTXS15LVJU		FTXS18LVJU		FTXS24LVJU			
Airflow Rate	H	cfm (m³/min)	381 (10.8)	420 (11.9)	403 (11.4)	438 (12.4)	568 (16.1)	593 (16.8)	583 (16.5)	625 (17.7)	643 (18.2)	699 (19.8)		
	M		279 (7.9)	321 (9.1)	307 (8.7)	335 (9.5)	477 (13.5)	505 (14.3)	484 (13.7)	526 (14.9)	494 (14.0)	572 (16.2)		
	L		194 (5.5)	233 (6.6)	205 (5.8)	240 (6.8)	385 (10.9)	417 (11.8)	385 (10.9)	431 (12.2)	350 (9.9)	445 (12.6)		
	SL		145 (4.1)	219 (6.2)	155 (4.4)	212 (6.0)	360 (10.2)	371 (10.5)	360 (10.2)	399 (11.3)	328 (9.3)	403 (11.4)		
Fan Speed	Steps		5 Steps, Quiet, Auto											
Air Direction Control			Right, Left, Horizontal, Downward											
Air Filter			Removable / Washable / Mildew Proof											
Dimensions (H x W x D)	in. (mm)		11-5/8 x 31-1/2 x 8-7/16 (295 x 800 x 215)				13-3/8 x 41-5/16 x 9-3/4 (340 x 1,050 x 248)							
Weight	lbs. (kg)		20 (9)		22 (10)		31 (14)		31 (14)		31 (14)			
Sound Pressure Level (H / M / L / S)	dB(A)		41 / 33 / 25 / 22	42 / 35 / 28 / 25	45 / 37 / 29 / 23	45 / 39 / 29 / 26	45 / 40 / 35 / 32	43 / 38 / 33 / 30	46 / 41 / 36 / 33	45 / 40 / 35 / 32	51 / 44 / 37 / 34	48 / 42 / 37 / 34		
Outdoor Unit			RXS09LVJU		RXS12LVJU		RXS15LVJU		RXS18LVJU		RXS24LVJU			
Compressor	Motor Output	W	600				1,100				1,920			
Refrigerant	Type		R-410A											
	Charge	lbs. (kg)	2.43 (1.1)		2.65 (1.2)		3.97 (1.8)		3.97 (1.8)		5.07 (2.3)			
Airflow Rate	H	cfm	1,102 (31.2)	992 (28.1)	1,183 (33.5)	992 (28.1)	1,713 (48.5)	1,405 (39.8)	1,780 (50.4)	1,444 (40.9)	1,924 (54.5)	1,854 (52.5)		
	SL	(m³/min)	989 (28.0)	840 (23.8)	989 (28.0)	840 (23.8)	1,469 (41.6)	1,306 (37.0)	1,494 (42.3)	1,328 (37.6)	1,624 (46.0)	1,624 (46.0)		
Dimensions (H x W x D)	in. (mm)		21-5/8 x 30-1/8 x 11-1/4 (550 x 765 x 285)				28-15/16 x 32-1/2 x 11-13/16 (735 x 825 x 300)				30-5/16 x 35-7/16 x 12-5/8 (770 x 900 x 320)			
Weight	lbs. (kg)		75 (34)				104 (47)				159 (72)			
Sound Pressure Level	H/L	dB(A)	47 / 43	48 / 44	49 / 44	49 / 45	47 / 44	48 / 45	49 / 46	49 / 46	52 / 49	52 / 49		
ENERGY STAR® Certified			YES		YES		YES		YES		YES			

*Cutting a jumper or a dipswitch setting is required. Refer to installation manual.

Unit Combination		Power Supply				Compressor		OFM		IFM	
Indoor Unit	Outdoor Unit	Hz - Volts	Voltage Range	MCA	MOCP	RLA	W	FLA	W	FLA	
FTXS09LVJU	RXS09LVJU	60 - 208	Min. 187 V Max. 253 V	8.00	15	3.2	23	0.22	23	0.15	
		60 - 230				2.9					
		60 - 208				4.4					
FTXS12LVJU	RXS12LVJU	60 - 208	Min. 187 V Max. 253 V	8.75	15	4.4	23	0.22	23	0.15	
		60 - 230				3.9					
		60 - 208				4.7					
FTXS15LVJU	RXS15LVJU	60 - 208	Min. 187 V Max. 253 V	13.75	20	4.2	53	0.32	48	0.31	
		60 - 230				4.7					
		60 - 208				6.6					
FTXS18LVJU	RXS18LVJU	60 - 208	Min. 187 V Max. 253 V	13.75	20	5.9	53	0.32	48	0.32	
		60 - 230				5.9					
		60 - 208				7.9					
FTXS24LVJU	RXS24LVJU	60 - 208	Min. 187 V Max. 253 V	17.50	20	7.1	66	0.40	48	0.57	
		60 - 230				7.1					
		60 - 208				7.1					



LV series

Slim-Duct Concealed Ceiling Units

Up to 15.5 SEER | Up to 10.4 HSPF

COMFORTABLE LIMITED WARRANTY* PROTECTION



* Complete warranty details available from your local dealer/contractor or at www.daikincomfort.com. To receive the 12-Year Parts Limited Warranty, online registration must be completed within 60 days of installation. Online registration is not required in California or Quebec. *If product installed in a commercial application, limited warranty period is 5 years.*

LV series is offered in a slim-ducted concealed ceiling unit providing an extremely unobtrusive, compact solution, where only the discharge and intake grilles are visible. In addition, they free up the maximum amount of floor and wall space to minimize the impact on decor. Also, their new low consumption DC fan motor offers energy saving.

Standard Features

- » Energy Efficient – Up to 15.5 SEER, 10.4 HSPF, up to 11.2 EER – Variable Speed Inverter Compressor
- » Cooling Range: 50° - 115°F (Extended operation to 0° - 115°F with facility setting and air adjustment grille)
- » Heating Range: 5° - 65°F
- » Indoor Sound Pressure as Low as 31 dB(A)
- » Outdoor Sound Pressure as Low as 43 dB(A)
- » Program Dry Function
- » Econo Mode
- » Powerful Operation Mode
- » Backlit Wireless Remote Controller
- » Auto-Changeover
- » Auto-Fan Speed Control
- » Self Diagnostics with Digital Display
- » Auto Restart After Power Failure
- » Anti-Corrosion Heat Exchanger Treatment
- » Quick Warming Function
- » Hot Start Function
- » Automatic Defrosting

Optional Features

- » Wired controller
- » Compatible with Daikin Comfort App (adaptor required)

IDEAL SOLUTIONS FOR:

- » Renovations, remodeling and new construction
- » Sun rooms, basements, garages, hot or cold rooms, attics where the walls tend to be lower, or wherever wall space is at a premium
- » Ceiling void or attic does not allow for a viable standard ducted solution
- » Homeowners' reluctance to use a visible wall or a floor mounted unit



Daikin Comfort App – Easily control your system from anywhere in the world or the comfort of your living room.



Auto-Restart – The unit memorizes the operation mode, airflow and temperature settings. Should there be a power failure when the unit is in operation, it will automatically return to the same operating conditions when the power is restored.



Hot Start – (Heat Pump) When the heating operation starts or when the unit changes from cooling to heating, there is no cold draft.



Powerful Operation Mode – Pushing the POWERFUL button on the remote control gives you a boost in cooling or heating power for a 20-minute period, even if the unit is already operating at high capacity.

Indoor Unit	Optional Accessories
BRP072A43	Wireless Interface Adaptor
BRC944B2-A08	Wired Remote Controller
BRCW901A08	Wired Remote Controller Cord - 3m
DACA-BRCW901P10	Remote Controller Cable, Plenum Rated, 10 ft
DACA-BRCW901P25	Remote Controller Cable, Plenum Rated, 25 ft
DACA-ARCW901P10	IR Receiver Cable, Plenum Rated, 10ft
DACA-ARCW901P25	IR Receiver Cable, Plenum Rated, 25ft
DACA-CP3-1	Condensate Pump (Fits inside all Daikin indoor unit heads)
Outdoor Unit	Optional Accessories
DACA-WB-3	Powder Coated Wall-Mounted Bracket
KEH041A41	Drain Pan Heater (09x12)
KEH041A42	Drain Pan Heater (15x18)
KEH041A43	Drain Pan Heater (24)
KKP937A4	Drain Plug
KPW937C4	Air Adjustment grille (09x12)
KPW945A4	Air Adjustment grille (15x18x24)

LV series

Slim-Duct Concealed Ceiling Units

Up to 15.5 SEER | Up to 10.4 HSPF

SINGLE-ZONE SYSTEMS



Model	Indoor Unit		FDXS09LVJU		FDXS12LVJU	
	Outdoor Unit		RXS09LVJU		RXS12LVJU	
			Cooling	Heating	Cooling	Heating
Capacity Rated (Min.-Max.)	Btu/h		8,500 (4,400 ~ 8,500)	10,000 (4,400 ~ 10,000)	11,500 (4,800 ~ 11,500)	11,500 (4,800 ~ 11,500)
Moisture Removal	gal/h (L/h)		2.5 (9.5)	—	4.0 (15.1)	—
COP Rated			3.45		3.51	
EER Rated			11.2		9.1	
SEER			15.1		15.5	
HSPF			10.3		10.4	
Piping Connections	Liquid	in. (mm)	Ø 1/4 (6.4)			
	Gas		Ø 3/8 (9.5)			
	Drain		Ø 25/32 (20.0)			
Max. Interunit Piping Length			65.6 (20)			
Max. Interunit Height Difference	ft. (m)		49.2 (15)			
Chargeless			32.8 (10)			
Amount of Additional Charge of Refrigerant	oz./ft (g/m)		0.21 (20)			
Operating Range - Cooling*	°F DB		14° - 115°F			
Operating Range - Cooling with Optional Air Adjustment Grille*			0° - 115°F			
Operating Range - Heating	°F WB		5° - 65°F			
Indoor Unit			FDXS09LVJU		FDXS12LVJU	
External Static Pressure	in. Wg (Pa)		0.12 (30)			
Airflow Rate	H	cfm (m³/min)	305 (8.6)			
	M		280 (7.9)			
	L		260 (7.4)			
	SL		235 (6.7)			
Fan	Speed		5 Steps, Quiet, Auto			
Air Filter			Removable / Washable / Mildew Proof			
Dimensions (H x W x D)	in. (mm)		7-7/8 x 27-9/16 x 24-7/16 (200 x 700 x 620)			
Weight	lbs. (kg)		47 (21)			
Sound Pressure Level (H / M / L)	dB(A)		35 / 33 / 31			
Outdoor Unit			RXS09LVJU		RXS12LVJU	
Compressor	Motor Output		600			
Refrigerant	Type		R-410A			
	Charge		2.43 (1.1)		2.65 (1.2)	
Airflow Rate	H	cfm (m³/min)	1,102 (31.2)		1,183 (33.5)	
	L		989 (28.0)	840 (23.8)	989 (28.0)	840 (23.8)
Dimensions (H x W x D)	in. (mm)		21-5/8 x 30-1/8 x 11-1/4 (550 x 765 x 285)			
Weight	lbs. (kg)		75 (34)			
Sound Pressure Level (H / L)	dB(A)		47 / 43	48 / 44	49 / 44	49 / 45

*Cutting a jumper or a dipswitch setting is required. Refer to installation manual.

Unit Combination		Power Supply				Compressor		OFM		IFM	
Indoor Unit	Outdoor Unit	Hz - Volts	Voltage Range	MCA	MOCP	RLA	W	FLA	W	FLA	
FDXS09LVJU	RXS09LVJU	60 - 208	Min. 187 V Max. 253 V	8.00	15	4.1	23	0.22	62	0.52	
		60 - 230				3.7					
FDXS12LVJU	RXS12LVJU	60 - 208	Min. 187 V Max. 253 V	8.75	15	5.9	23	0.22	62	0.52	
		60 - 230				5.3					

FDMQ_RVJU

Ducted Concealed Indoor Unit

Up to 20.2 SEER | Up to 10.6 HSPF

COMFORTABLE LIMITED WARRANTY* PROTECTION



* Complete warranty details available from your local dealer/contractor or at www.daikincomfort.com. To receive the 12-Year Parts Limited Warranty, online registration must be completed within 60 days of installation. Online registration is not required in California or Quebec. If product installed in a commercial application, limited warranty period is 5 years.

A ducted concealed ceiling unit provides a completely concealed installation, minimizing the impact on decor. Easily incorporate longer duct runs and high MERV filters with available external static pressures of up to 0.6.

Standard Features

- » Energy Efficient – Up to 20.2 SEER, up to 10.6 HSPF, up to 12.7 EER – Variable Speed Inverter Compressor
- » Cooling Range 50° - 115°F (Extended operation to -4° - 115°F with facility setting and air adjustment grille)
- » Heating Range 5° - 65°F
- » Indoor Sound Pressure as low as 32 dB(A)
- » Outdoor Sound Pressure as Low as 46 dB(A)
- » Auto Changeover
- » Auto-Fan Speed control (with wired controller)
- » Self-Diagnostics with digital display
- » Drain Pan Inspection Port
- » Integral Lift Mechanism
- » Auto Restart After Power Failure
- » Anti-Corrosion Heat Exchanger Treatment
- » Quick Warming Function
- » Hot Start Function
- » Automatic Defrosting
- » Compatible with DKN Cloud Wi-Fi Adaptor

IDEAL SOLUTIONS FOR:

- » Renovations, remodeling and new construction
- » Sun rooms, basements, garages, hot or cold rooms, attics where the walls tend to be lower, or wherever wall space is at a premium
- » Ceiling void or attics which allow for a ducted solution with longer duct runs
- » Homeowners' requiring higher level of filtration
- » Homeowners' reluctance to use a visible wall or a floor mounted unit



Auto-Restart – The unit memorizes the operation mode, airflow and temperature settings. Should there be a power failure when the unit is in operation, it will automatically return to the same operating conditions when the power is restored.



Hot Start – (Heat Pump) When the heating operation starts or when the unit changes from cooling to heating, there is no cold draft.



Powerful Operation Mode – Pushing the POWERFUL button on the remote control gives you a boost in cooling or heating power for a 20-minute period, even if the unit is already operating at high capacity.

Indoor Unit	One Controller Required
BRC1E73	Wired Remote Controller
BRC082A43	Wireless hand held controller (sensor included)
DACA-CP2-1	Maxi Orange Condensate Pump
AZAI6WSCDKA	DKN Cloud Wi-Fi Adaptor (Requires BRC1E73)
DFBS27A13	MERV 13 Filter Kit for FDMQ 09 & 12
DFBS39A13	MERV 13 Filter Kit for FDMQ 15, 18 & 24
DACA-CP3-1	Mini Condensate Pump
Outdoor Unit	Optional Accessories
DACA-WB-1	Powder-Coated Wall-Mounted Bracket
KEH067A41E	Drain Pan Heater (09/12 MBH)
KEH063A4E	Drain Pan Heater (15/18/24 MBH)
KKP937A4	Drain Plug for OD Unit
KPW937E4	Low Ambient Wind Baffle / Air Adjustment Grille (09/12 MBH)
KPW063A4	Low Ambient Wind Baffle / Air Adjustment Grille (15/18 /24 MBH)
KKG067A41	Back protection wire net (09/12 MBH)
KKG063A42	Back protection wire net (15/18/24 MBH)
KPS067A41	Snow hood (intake side plate) (09/12 MBH)
KPS063A41	Snow hood (intake side plate) (15/18/24 MBH)
KPS067A42	Snow hood (intake rear plate) (09/12 MBH)
KPS063A44	Snow hood (intake rear plate) (15/18/24 MBH)
KPS067A44	Snow hood (outlet) (09/12 MBH)
KPS063A47	Snow hood (outlet) (15/18/24 MBH)



- » Increases the flexibility of the FDMQ systems in both residential and commercial applications by adding a Zoning Box to an indoor unit fan coil
- » Allows several separate ducts to supply air to different individually-controlled zones.
- » The DZK BACnet™ Interface will work with any BACnet/IP compatible Building Management System



Wired*
Thermostat



Wireless*
Thermostat



Wireless Lite*
Thermostat

*for DZK Kit



Proper sizing and installation of equipment is critical to achieve optimal performance. Split system air conditioners and heat pumps must be matched with appropriate coil components to meet **ENERGY STAR®** criteria. Ask your contractor for details or visit www.energystar.gov.

FDMQ_RVJU

Ducted Concealed Indoor Unit

Up to 20.2 SEER | Up to 10.6 HSPF



SINGLE-ZONE SYSTEMS

Model	Indoor Unit		FDMQ09RVJU		FDMQ12RVJU		FDMQ15RVJU		FDMQ18RVJU		FDMQ24RVJU	
	Outdoor Unit		RX09RMVJU9		RX12RMVJU9		RX15RMVJU		RX18RMVJU9		RX24RMVJU	
			Cooling	Heating	Cooling	Heating	Cooling	Heating	Cooling	Heating	Cooling	Heating
Capacity Rated	Btu/h		9,000	10,900	10,800	13,600	14,400	18,000	17,600	21,600	21,800	24,000
Moisture Removal	gal/h		N/A	—	N/A	—	N/A	—	N/A	—	N/A	—
COP Rated			4.1		3.7		3.8		3.8		3.8	
EER Rated			11.1		11.6		12.7		12.5		12.5	
SEER			17.8		19.4		20.2		18.5		18.6	
HSPF			10.3		10.6		10.3		10.3		10	
Piping Connections	Liquid	in. (mm)	Ø 1/4 (Ø 6.4)									
	Gas		Ø 3/8 (Ø 9.5)				Ø 1/2 (Ø 12.7)				Ø 5/8 (15.9)	
	Drain		Ø 1 (25.0)									
Max. Interunit Piping Length	ft. (m)		65.6 (20)				98.4 (30)					
Max. Interunit Height Difference			49.2 (15)				65.6 (20)					
Chargeless			32.8 (10)									
Amount of Additional Charge of Refrigerant	oz/ft (g/m)		0.21 (20)									
Operating Range - Cooling*	°F DB		14° - 115°F									
Operating Range - Cooling with Optional Air Adjustment Grille*			-4° - 115°F									
Operating Range - Heating	°F WB		5° - 65°									
Indoor Unit			FDMQ09RVJU		FDMQ12RVJU		FDMQ15RVJU		FDMQ18RVJU		FDMQ24RVJU	
External Static Pressure	"Wg(Pa)		0.6 (150)									
Airflow Rate	H	cfm (m³/min)	343 (9.7)	343 (9.7)	392 (11.1)	392 (11.1)	516 (14.6)	516 (14.6)	675 (19.1)	675 (19.1)	798 (22.6)	798 (22.6)
	M		290 (8.2)	290 (8.2)	332 (9.4)	332 (9.4)	438 (12.4)	438 (12.4)	572 (16.2)	572 (16.2)	678 (19.2)	678 (19.2)
	L		240 (6.8)	240 (6.8)	275 (7.8)	275 (7.8)	360 (10.2)	360 (10.2)	473 (13.4)	473 (13.4)	558 (15.8)	558 (15.8)
	SL		-	-	-	-	-	-	-	-	-	-
Fan	Speed	Steps	-									
Air Filter			-									
Dimensions (H x W x D)	in. (mm)		9-5/8 x 27-9/16 x 31-1/2 (245 x 700 x 800)				9-5/8 x 39-3/8 x 31-1/2 (245 x 1,000 x 800)					
Weight	lbs. (kg)		64 (29)				77 (35)				82 (37)	
Sound Pressure Level	dB(A)		32	32	33	33	34	34	35	35	40	40
Outdoor Unit			RX09RMVJU9		RX12RMVJU9		RX15RMVJU		RX18RMVJU9		RX24RMVJU	
Compressor	Motor Output	W	790									
Refrigerant	Type	R-410A										
	Charge	lbs. (kg)	2.09 (0.95)				2.49 (1.13)				3.20 (1.45)	
Airflow Rate	H	cfm (m³/min)	985 (27.9)	1,105 (31.3)	1,105 (31.3)	1,105 (31.3)	2,313 (65.5)	2,108 (59.7)	2,461 (69.7)	2,553 (72.3)	2,642 (74.8)	2,642 (74.8)
Dimensions (H x W x D)	in. (mm)		21-5/8 x 26-9/16 x 11-3/16 (550 x 675 x 284)				28-15/16 x 34-1/4 x 12-5/8 (735 x 870 x 320)					
Weight	lbs. (kg)		60 (27)				97 (44)				108 (49)	
Sound Pressure Level	H	dB(A)	46	50	49	51	50	51	54	55	56	58
ENERGY STAR® Certified			NO		NO		YES		YES		YES	

*Cutting a jumper or a dipswitch setting is required. Refer to installation manual.

Unit Combination		Power Supply				Compressor	OFM		IFM	
Indoor Unit	Outdoor Unit	Hz - Volts	Voltage Range	MCA	MOCP	RLA	W	FLA	W	FLA
FDMQ09RVJU	RX09RMVJU9	60 - 208	Min. 187 V Max. 253 V	9	15	7.5	39	0.13	130	0.63
		60 - 230								
FDMQ12RVJU	RX12RMVJU9	60 - 208	Min. 187 V Max. 253 V	9.1	15	7.5	39	0.13	130	0.73
		60 - 230								
FDMQ15RVJU	RX15RMVJU	60 - 208	Min. 187 V Max. 253 V	9.7	15	8	91	0.31	230	0.87
		60 - 230								
FDMQ18RVJU	RX18RMVJU9	60 - 208	Min. 187 V Max. 253 V	12.8	15	10.75	110	0.38	230	1.22
		60 - 230								
FDMQ24RVJU	RX24RMVJU	60 - 208	Min. 187 V Max. 253 V	16.9	20	14.5	125	0.43	230	1.54
		60 - 208								



NV series

Wall-Mounted Heat Pump & Cooling Only

Up to 17.5 SEER
Up to 9.3 HSPF | Up to 9.85 EER

COMFORTABLE LIMITED WARRANTY* PROTECTION



* Complete warranty details available from your local dealer/contractor or at www.daikincomfort.com. Warranty registration not required to receive the 10-Year parts limited warranty for residential or commercial installations.

Daikin NV series is available in both cooling only and heat pump configurations. This feature-packed wall-mount unit offers extended capacity in an elegant design. Comfort Airflow, 3-D Air-flow and Wide Angle Louvers are just a few of the features used in the new NV series to improve comfort in a room.

Standard Features

- » Energy Efficient – Up to 17.5 SEER, 9.3 HSPF, up to 9.85 EER – Inverter, Variable-Speed Compressor
- » Cooling Range: 50° - 115°F (Extended operation to -22° - -115°F with facility setting and air adjustment grille)
- » Heating Range: 5° - 65°F
- » Indoor Sound Pressure as Low as 35 dB(A)
- » Outdoor Sound Pressure as Low as 56 dB(A)
- » Intelligent Eye
- » Power airflow dual flaps and 3-D Airflow
- » Titanium Apatite Photocatalytic Air Purifying Filter
- » Weekly timer
- » Program Dry Function
- » Econo Mode
- » Powerful Operation Mode
- » Backlit Wireless Remote Controller
- » Auto-Changeover
- » Auto-Fan Speed Control
- » Self Diagnostics with Digital Display
- » Auto-Restart After Power Failure
- » Anti-Corrosion Heat Exchanger Treatment
- » Quick Warming Function
- » Hot Start Function
- » Automatic Defrosting
- » Compatible with Daikin Comfort App (adaptor required)

IDEAL SOLUTIONS FOR:

- » Renovations, remodeling and new construction
- » Sun rooms, basements, garages, hot or cold rooms, attics where the walls tend to be lower, or wherever wall space is at a premium
- » Ceiling void or attic does not allow for a viable duct run option
- » Homeowners desiring advanced features for comfort and savings



Low Ambient Cooling – Cooling operation down to -22°F (-30°) outside temperature for cooling only models. No field installed kit required.



Daikin Comfort App – Easily control your system from anywhere in the world or the comfort of your living room.



3-D Airflow – Combines vertical and horizontal auto-swing to circulate cool/warm air to the corners of large spaces.



Intelligent Eye – The intelligent eye is an infrared sensor with the ability to sense movement in the room. When you are in the room, the air conditioner operates normally. If you leave the room for more than 20 minutes the air conditioner automatically changes to an energy-saving operation. Using the intelligent eye, savings of up to 20% in cooling and up to 30% in heating can be achieved compared to units without this feature.



Auto-Restart – The unit memorizes the operation mode, airflow and temperature settings. Should there be a power failure when the unit is in operation, it will automatically return to the same operating conditions when the power is restored.



Titanium Apatite Photocatalytic Air Purifying Filter – This filter combines the air-purifying filter and titanium apatite photocatalytic deodorizing filter in a single highly effective unit.



Hot Start – (Heat Pump) When the heating operation starts or when the unit changes from cooling to heating, there is no cold draft.

Indoor Unit	Optional Accessories
BRC944B2	Wired Remote Controller (Requires 1 cord below)
BRCW901A03	Wired Remote Controller Cord (Shielded wire) 9.8 ft
BRCW901A08	Wired Remote Controller Cord (Shielded wire) 26.3 ft
BRP072A43	Wireless LAN connection Adaptor
KAF970A48	Titanium Apatite Deodorizing Filter (Without frame) Standard
KKF910AA4	Remote Controller Loss Prevention with Chain
Outdoor Unit	Optional Accessories
KPW063A4	Air Direction Adjustment Grille
KKG063A42	Back Protection Wire Net
KKP937A4	Drain Plug - Standard
KEH063A4E	Drain Pan Heater
KPS063A41	Snow Hood (Intake side panel)
KPS063A44	Snow Hood (Intake side panel)
KPS063A47	Snow Hood (Outlet)



NV series

Wall-Mounted Cooling Only

Up to 17.5 SEER | Up to 9.85 EER

SINGLE-ZONE SYSTEMS

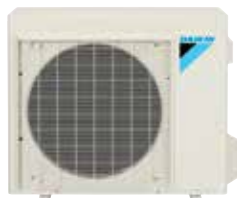

Model	Indoor Unit		FTX30NVJU	FTX36NVJU
	Outdoor Unit		RK30NMVJU	RK36NMVJU
Capacity Rated (Min. - Max.)	Btu/h		31,400 (10,200 - 31,400)	34,400 (10,200 - 34,400)
Moisture Removal	gal/h		N/A	N/A
EER Rated			9.85	9.1
SEER			17.5	15.9
Piping Connections	Liquid	in. (mm)	Ø 1/4 (Ø 6.4)	
	Gas		Ø 5/8 (Ø 16.0)	
	Drain		Ø 5/8 (Ø 16.0)	
Max. Interunit Piping Length	ft. (m)		98-3/8 (29.8)	
Max. Interunit Height Difference			65-5/8 (20)	
Chargeless			32-13/16 (9.8)	
Amount of Additional Charge of Refrigerant			0.32 (30)	
Operating Range - Cooling	°F DB		50° - 115°F	
Operating Range - Enhanced Cooling*			14° - 115°F	
Operating Range - Low Ambient Cooling**			-4° - 115°F	
Operating Range - Ultra Low Ambient Cooling***			-22° - 115°F	
Airflow Rate	Indoor Unit		FTX30NVJU	FTX36NVJU
	H	cfm (m³/min)	890 (25.2)	915 (25.9)
	M		727 (20.6)	742 (21.0)
	L		572 (16.2)	572 (16.2)
SL	512 (14.5)		512 (14.5)	
Fan	Speed	Steps	5 Steps, Quiet, Auto	
Air Direction Control			Right, Left, Horizontal, Downward	
Air Filter			Removable, Washable, Mildew Proof	
Dimensions (H x W x D)	in. (mm)		13-3/8 x 47-1/4 x 10-3/16 (340 x 1,200 x 259)	
Weight	lbs. (kg)		38 (17)	
Sound Pressure Level (H / M / L / SL)	dB(A)		53 / 47 / 40 / 37	54 / 47 / 40 / 37
Compressor	Outdoor Unit		RK30NMVJU	RK36NMVJU
	Motor Output	W	1,920	
	Type		R-410A	
	Charge	lbs. (kg)	3.64 (1.65)	3.64 (1.65)
Airflow Rate	H	cfm (m³/min)	2,528 (71.6)	2,811 (79.6)
	SL		—	—
Dimensions (H x W x D)	in. (mm)		28-15/16 x 34-1/4 x 12-5/8 (735 x 870 x 320)	
Weight	lbs. (kg)		133 (60)	133 (60)
Sound Pressure Level	H	dB(A)	56	59

* Activated with a dipswitch setting. Refer to installation manual for more details.

** Activated with a dipswitch setting and use of air direction adjustment grille (KPW063A4). Refer to installation manual for more details.

*** Activated with additional dipswitch setting and notes per **. Refer to installation manual for more details.

Unit Combination		Power Supply				Compressor	OFM		IFM	
Indoor Unit	Outdoor Unit	Hz - Volts	Voltage Range	MCA	MOP	RLA	W	FLA	W	FLA
FTX30NVJU	RK30NMVJU	60 - 208	Min. 187 V Max. 253 V	17	20	16.25	93	0.62	64	0.37
		60 - 230								
FTX36NVJU	RK36NMVJU	60 - 208	Min. 187 V Max. 253 V	17	20	16.25	123	0.83	64	0.37
		60 - 230								

NV series

Wall-Mounted Heat Pump

Up to 17.5 SEER | Up to 9.3 HSPF

COMFORTABLE LIMITED WARRANTY* PROTECTION



* Complete warranty details available from your local dealer/contractor or at www.daikincomfort.com. Warranty registration not required to receive the 10-Year parts limited warranty for residential or commercial installations.

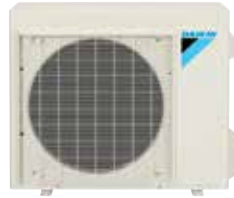

Model	Indoor Unit		FTX30NVJU		FTX36NVJU	
	Outdoor Unit		RX30NMVJU		RX36NMVJU	
			Cooling	Heating	Cooling	Heating
Capacity Rated		Btu/h	31,400	34,800	34,400	36,000
(Min. ~ Max.)			(10,200 ~ 31,400)	(10,200 ~ 34,800)	(10,200 ~ 34,400)	(10,200 ~ 36,000)
Moisture Removal		gal/h	N/A	—	N/A	—
COP Rated			2.92		2.78	
EER Rated			9.85		9.1	
SEER			17.5		15.9	
HSPF			9.3		9.2	
Piping Connections		Liquid	Ø 1/4 (Ø 6.4)			
		Gas	Ø 5/8 (Ø 16.0)			
		Drain	Ø 5/8 (Ø 16.0)			
Max. Interunit Piping Length		ft. (m)	98-3/8 (29.8)			
Max. Interunit Height Difference			65-5/8 (20)			
Chargeless			32-13/16 (9.8)			
Amount of Additional Charge of Refrigerant		oz/ft (g/m)	0.32 (30)			
Operating Range - Cooling		°F DB	50° - 115°F			
Operating Range - Enhanced Cooling**			14° - 115°F			
Operating Range - Low Ambient Cooling***			-4° - 115°F			
Operating Range - Heating*		°F WD	5° - 65°F			
Indoor Unit		FTX30NVJU		FTX36NVJU		
Airflow Rate	H	cfm (m³/min)	890 (25.2)	960 (27.2)	915 (25.9)	960 (27.2)
	M		727 (20.6)	791 (22.4)	742 (21.0)	791 (22.4)
	L		572 (16.2)	629 (17.8)	572 (16.2)	629 (17.8)
	SL		512 (14.5)	544 (15.4)	512 (14.5)	544 (15.4)
Fan	Speed	Steps	5 Steps, Quiet, Auto			
Air Direction Control		Right, Left, Horizontal, Downward				
Air Filter		Removable, Washable, Mildew Proof				
Dimensions (H x W x D)		in. (mm)	13-3/8 x 47-1/4 x 10-3/16 (340 x 1,200 x 259)			
Weight		lbs. (kg)	38 (17)			
Sound Pressure Level (H / M / L / SL)		dB(A)	53 / 47 / 40 / 37	53 / 46 / 38 / 35	54 / 47 / 40 / 37	53 / 46 / 38 / 35
Outdoor Unit		RX30NMVJU		RX36NMVJU		
Compressor	Motor Output	W	1,920		1,920	
Refrigerant	Type	R-410A				
	Charge	lbs. (kg)	3.64 (1.65)		3.64 (1.65)	
Airflow Rate	H	cfm (m³/min)	2,528 (71.6)	2,274 (64.4)	2,811 (79.6)	2,352 (66.6)
	SL		—	—	—	—
Dimensions (H x W x D)		in. (mm)	28-15/16 x 34-1/4 x 12-5/8 (735 x 870 x 320)			
Weight		lbs. (kg)	133 (60)		133 (60)	
Sound Pressure Level		H dB(A)	56	58	59	

*Applicable to heat pump models only, refer to installation manual for more details.

** Activated with a dipswitch setting. Refer to installation manual for more details.

*** Activated with a dipswitch setting and use of air direction adjustment grille (KPV063A4). Refer to installation manual for more details.

Unit Combination		Power Supply				Compressor	OFM		IFM		
Indoor Unit	Outdoor Unit	Hz - Volts	Voltage Range		MCA	MOP	RLA	W	FLA	W	FLA
FTX30NVJU	RX30NMVJU	60 - 208	Min. 187 V Max. 253 V		19.8	20	18.25	93	0.62	64	0.37
		60 - 230									
FTX36NVJU	RX36NMVJU	60 - 208	Min. 187 V Max. 253 V		19.8	20	18.25	123	0.83	64	0.37
		60 - 230									



LV 30/36 Wall-Mount

Cooling Only

Up to 19.3 SEER | 10.7 EER

COMFORTABLE LIMITED WARRANTY* PROTECTION



* Complete warranty details available from your local dealer/contractor or at www.daikincomfort.com. Warranty registration not required to receive the 10-Year parts limited warranty for residential or commercial installations.

Daikin's LV 30/36 Wall-Mount offers Cooling Only solutions for larger capacity applications. With the optional Ultra-Low Ambient Kit, cooling range can be extended to -40°F which is perfect for process cooling applications. The LV 30/36 also has some great features for comfort cooling applications like Comfort Airflow, 3-D Airflow, and an Intelligent Eye for room occupancy sensing.

Standard Features

- » Energy Efficient – Up to 19.3 SEER, up to 10.7 EER – Inverter, Variable-Speed Compressor
- » Cooling Range: 50° - 115°F (Extended operation to 0° - 115°F with facility setting and air adjustment grille)
- » Heating Range: 5° - 65°F
- » Indoor Sound Pressure as Low as 37 dB(A)
- » Outdoor Sound Pressure as Low as 51 dB(A)
- » Intelligent Eye
- » Power airflow dual flaps and 3-D Airflow
- » Titanium Apatite Photocatalytic Air Purifying Filter
- » Weekly timer
- » Program Dry Function
- » Econo Mode
- » Powerful Operation Mode
- » Backlit Wireless Remote Controller
- » Auto-Fan Speed Control
- » Self Diagnostics with Digital Display
- » Auto-Restart After Power Failure
- » Anti-Corrosion Heat Exchanger Treatment
- » Compatible with Daikin Comfort App (adaptor required)

IDEAL SOLUTIONS FOR:

- › Renovations, remodeling and new construction
- › Sun rooms, basements, garages, rooms with poor airflow
- › Ceiling void or attic does not allow for a viable standard ducted solution
- › Mechanical Rooms
- › Server Rooms



Daikin Comfort App – Easily control your system from anywhere in the world or the comfort of your living room.



Intelligent Eye – The intelligent eye is an infrared sensor with the ability to sense movement in the room. When you are in the room, the air conditioner operates normally. If you leave the room for more than 20 minutes the air conditioner automatically changes to an energy-saving operation. Using the intelligent eye, savings of up to 20% in cooling and up to 30% in heating can be achieved compared to units without this feature.



Titanium Apatite Photocatalytic Air Purifying Filter – This filter combines the air-purifying filter and titanium apatite photocatalytic deodorizing filter in a single highly effective unit.



3-D Airflow – Combines vertical and horizontal auto-swing to circulate cool/warm air to the corners of large spaces.



Indoor Unit	Optional Accessories
BRC944B2-A08	Wired Remote Controller
BRCW901A08	Wired Remote Controller Cord (Shielded Wire) 26.3 ft
BRP072A43	Wireless Interface Adaptor
KAF970A48	Titanium Apatite Deodorizing Filter (Without frame) Standard
KKF910AA4	Remote Controller Loss Prevention with Chain
Outdoor Unit	Optional Accessories
KPW5E112	Air Adjustment Grille
KKG063A42	Back protection wire net
2F018535-1	Ultra Low Ambient Kit (30)
2F018535-2	Ultra Low Ambient Kit (36)

LV 30/36 Wall-Mount Cooling Only

Up to 19.3 SEER | 10.7 EER

SINGLE-ZONE SYSTEMS



Model	Indoor Unit		FTXS30LVJU		FTXS36LVJU	
	Outdoor Unit		RKS30LVJU		RKS36LVJU	
Capacity Rated (Min. - Max.)	Btu/h		30,000 (10,200 - 30,000)		36,000 (10,200 - 36,000)	
Moisture Removal	gal/h		1.5		1.8	
EER Rated			10.71		8.37	
SEER			19.3		17.9	
Piping Connections	Liquid	in. (mm)	Ø 3/8 (Ø 9.5)			
	Gas		Ø 5/8 (Ø 16.0)			
	Drain		Ø 5/8 (Ø 16.0)			
Max. Interunit Piping Length	ft. (m)		98-1/2 (30)			
Max. Interunit Height Difference			65-5/8 (20)			
Chargeless			32-13/16 (10)			
Amount of Additional Charge of Refrigerant	oz/ft (g/m)		0.21 (20)			
Operating Range - Cooling			50° - 115°F			
Operating Range - Low-Ambient Cooling*			14° - 115°F			
Operating Range - Cooling with Optional Air Adjustment Grille*			0° - 115°F			
Operating Range - Cooling with Ultra Low-Ambient kit and Optional Air Adjustment Grille			-40° - 115°F			
Indoor Unit			FTXS30LVJU		FTXS36LVJU	
Airflow Rate	H	cfm (m³/min)	706 (20)		770 (21.8)	
	M		611 (17.3)		635 (18.0)	
	L		519 (14.7)		519 (14.7)	
	SL		473 (13.4)		473 (13.4)	
Fan	Speed	Steps	5 Steps, Quiet, Auto			
Air Direction Control			Right, Left, Horizontal, Downward			
Air Filter			Removable, Washable, Mildew Proof			
Dimensions	in.		13-3/8 x 47-1/4 x 9-7/16			
(H x W x D)	(mm)		(340 x 1,200 x 240)			
Weight	Lbs (kg)		38 (17)			
Sound Pressure Level (H / M / L / SL)	dB(A)		47/45/40/37		49/45/40/37	
Outdoor Unit			RKS30LVJU		RKS36LVJU	
Compressor	Motor Output	W	2,030			
Refrigerant	Type		R-410A			
	Charge	Lbs (kg)	6.17 (2.8)			
Airflow Rate	H	cfm (m³/min)	2,627 (74.4)			
	SL		2,316 (65.6)		2,316 (35.6)	
Dimensions	in.		38-15/16 x 37 x 12-5/8			
(H x W x D)	(mm)		(990 x 940 x 320)			
Weight	Lbs (kg)		179 (81)			
Sound Pressure Level	H	dB(A)	54			

*Cutting a jumper or a dipswitch setting is required. Refer to installation manual.

Unit Combination		Power Supply				Compressor	OFM		IFM	
Indoor Unit	Outdoor Unit	Hz - Volts	Voltage Range	MCA	MOP	RLA	W	FLA	W	FLA
FTXS30LVJU	RKS30LVJU	60 - 208	Min. 187 V Max. 253 V	19.5	20	13.5	200	0.39	64	0.37
		60 - 230				12.2		0.35		0.34
FTXS36LVJU	RKS36LVJU	60 - 208	Min. 187 V Max. 253 V	19.5	20	18.9	200	0.39	64	0.37
		60 - 230				18.4		0.35		0.34

Wall-Mounted Heat Pump

HEAT. COOL. DEHUMIDIFY. CLEAN AIR.

Up to 26.1 SEER | Up to 11.0 HSPF

COMFORTABLE LIMITED
WARRANTY* PROTECTION



* Complete warranty details available from your local dealer/contractor or at www.daikincomfort.com. To receive the 12-Year Parts Limited Warranty, online registration must be completed within 60 days of installation. Online registration is not required in California or Quebec.
If product installed in a commercial application, limited warranty period is 5 years.

The Daikin *QUATERNITY* wall-mounted heat pumps are designed to maximize comfort even under the most challenging weather conditions. Equipped with built-in intelligence and extensive features in a highly efficient system, *QUATERNITY* provides a comfortable and refreshing indoor environment with advanced filtration and climate control.

Standard Features

- » Energy Efficient – Up to 26.1 SEER, 11.0 HSPF, up to 15.8 EER – Variable-Speed Inverter Compressor
- » Cooling Range: 14° - 109°F
- » Heating Range: -4° - 75°F
- » Indoor Sound Pressure as low as 26 dB(A)
- » Outdoor Sound Pressure as Low as 46 dB(A)
- » Power airflow dual flaps and 3-D Airflow
- » Titanium Apatite Photocatalytic Air Purifying Filter
- » Powerful Operation Mode
- » Wireless Remote Controller
- » Auto-Changeover
- » Auto-Fan Speed Control
- » Self Diagnostics with Digital Display
- » Auto-Restart After Power Failure
- » Anti-Corrosion Heat Exchanger Treatment
- » Quick Warming Function
- » Hot Start Function
- » Automatic Defrosting

Optional Features

- » Wired controller

Indoor Unit	Optional Accessories
ARC447A3	Handheld Wireless Remote Controller (Included)
DACA-CP3-1	Condensate Pump with Integral Float Switch
Outdoor Unit	Optional Accessories
DACA-WB-3	Powder Coated Wall-Mounted Bracket
KPW937C41	Air Adjustment Grille (03,12,15)



IDEAL SOLUTIONS FOR:

- » Renovations, remodeling and new construction
- » Challenging hot, humid, or poorly ventilated environments such as basement, garage or attic conversion
- » Ceiling void or attic does not allow for a viable standard ducted solution



Daikin Comfort App – Easily control your system from anywhere in the world or the comfort of your living room.



Flash Streamer – Increases indoor air quality through a powerful multistage filtration system.



Titanium Apatite Photocatalytic Air Purifying Filter – This filter combines the air-purifying filter and titanium apatite photocatalytic deodorizing filter in a single highly effective unit.



Hot Start – (Heat Pump) When the heating operation starts or when the unit changes from cooling to heating, there is no cold draft.



Humidity Control – Active dehumidification to a relative setting. Rooms with large amount of wood floors, pianos, computer rooms that require RH setting.



3-D Airflow – Combines vertical and horizontal auto-swing to circulate cool/warm air to the corners of large spaces.



Powerful Operation Mode – Pushing the POWERFUL button on the remote control gives you a boost in cooling or heating power for a 20-minute period, even if the unit is already operating at high capacity.



Auto-Restart – The unit memorizes the operation mode, airflow and temperature settings. Should there be a power failure when the unit is in operation, it will automatically return to the same operating conditions when the power is restored.



Proper sizing and installation of equipment is critical to achieve optimal performance. Split system air conditioners and heat pumps must be matched with appropriate coil components to meet **ENERGY STAR®** criteria. Ask your contractor for details or visit www.energystar.gov.



Wall-Mounted Heat Pump

HEAT. COOL. DEHUMIDIFY. CLEAN AIR.

Up to 26.1 SEER | Up to 11.0 HSPF



SINGLE-ZONE SYSTEMS

Model	Indoor Unit		FTXG09HVJU		FTXG12HVJU		FTXG15HVJU	
	Outdoor Unit		Cooling	Heating	Cooling	Heating	Cooling	Heating
Capacity Rated (Min.-Max.)		Btu/h	9,000 (5,300-12,300)	12,000 (4,400-18,000)	12,000 (5,300-15,700)	16,000 (4,400-19,100)	15,000 (5,300-18,000)	18,000 (4,400-21,200)
Moisture Removal		Pt/h	3.3	—	4.1	—	4.8	—
COP Rated			4.51		4.04		3.99	
EER Rated			15.8		14.0		12.9	
SEER			26.1		24.2		21.0	
HSPF			11.0		10.6		10.0	
Piping Connections	Liquid	in. (mm)	Ø 1/4 (6.4)					
	Gas		Ø 3/8 (9.5)					
	Drain		Ø 11/16 (17.5)					
Max. Interunit Piping Length			32 ft (10)					
Max. Interunit Height Difference		ft. (m)	26 ft (8)					
Chargeless			—		—		—	
Amount of Additional Charge of Refrigerant		oz/ft	—		—		—	
Operating Range - Cooling		°F DB	14° - 109°F					
Operating Range - Heating		°F WB	-4° - 75°F					
Indoor Unit			FTXG09HVJU		FTXG12HVJU		FTXG15HVJU	
Airflow Rate	H	cfm (m³/min)	420 (11.9)	438 (12.4)	459 (13.0)	470 (13.3)	487 (13.8)	494 (14.0)
	M		325 (9.2)	346 (9.8)	346 (9.8)	367 (10.4)	371 (10.5)	392 (11.1)
	L		230 (6.5)	258 (7.3)	240 (6.8)	272 (7.7)	258 (7.3)	293 (8.3)
Fan	Speed	Steps	5 Steps, Quiet, Auto					
Air Direction Control			Right, Left, Horizontal, Downward					
Air Filter			Removable / Washable / Mildew Proof					
Dimensions (HxWxD)		in. (mm)	12 x 35-1/16 x 8-1/4 (305 x 891 x 210 mm)					
Weight		lbs. (kg)	31 (14)					
Operation Sound		dBA	42 / 33 / 26	42 / 35 / 28	43 / 35 / 27	43 / 36 / 29	45 / 37 / 29	44 / 38 / 31
Outdoor Unit			RXG09HVJU		RXG12HVJU		RXG15HVJU	
Compressor	Motor Output	W	1,100					
Refrigerant	Type		R-410A					
	Charge	lbs.	3.1					
Airflow Rate	H	cfm (m³/min)	1,178 (33.4)	1,095 (31.0)	1,262 (35.7)	1,111 (31.5)	1,262 (35.7)	1,195 (33.8)
	L		—	—	—	—	—	—
Dimensions (HxWxD)		in. (mm)	22-3/8 x 31-5/16 x 11-1/4 (568 x 795 x 286 mm)					
Weight		lbs. (kg)	99 (45)				99 (45)	
Operation Sound (H / L)		dBA	46 / —	46 / —	49 / —	48 / —	50 / —	50 / —
ENERGY STAR® Certified			YES		YES		YES	

Unit Combination		Power Supply				OFM			IFM	
Indoor Unit	Outdoor Unit	Hz - Volts	Voltage Range	MCA	MOCP	RLA	W	FLA	W	FLA
FTXG09HVJU	RXG09HVJU	60 - 208	Min. 187 V Max. 253 V	14.5	15	2.3	60	0.10	57	0.13
		60 - 230				2.1				0.12
FTXG12HVJU	RXG12HVJU	60 - 208	Min. 187 V Max. 253 V	14.5	15	3.7	60	0.13	57	0.15
		60 - 230				3.3				0.14
FTXG15HVJU	RXG15HVJU	60 - 208	Min. 187 V Max. 253 V	14.5	15	5.1	60	0.13	57	0.17
		60 - 230				4.6				0.15



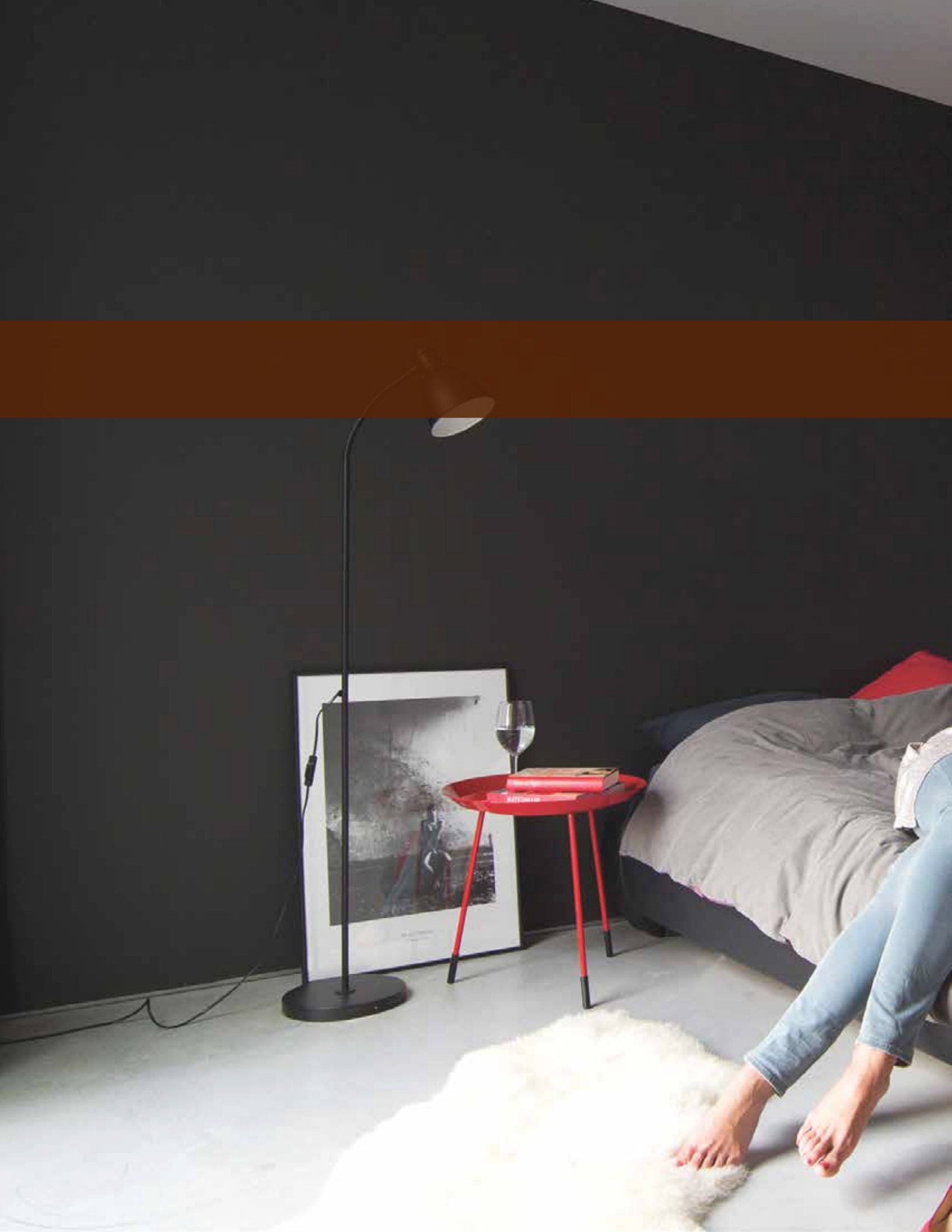

A woman with long brown hair is sitting on a bed, reading a magazine. She is wearing a white top and a grey cardigan. The bed has a grey duvet and a red throw blanket. A floor lamp is visible behind her. On the wall above the bed is a sleek, modern air conditioner. The room has dark walls and a minimalist aesthetic.

Multi-Zone Systems

Multi-Zone Systems



Ideal Solutions for:

	Wall-Mounted	Ducted	VISTA Cassette	Floor-Mounted
Primary living areas (master bedrooms and living rooms)	✓	✓	✓	✓
Hot or cold rooms	✓	✓	✓	✓
Rooms with poor air flow	✓	✓	✓	✓
New construction	✓	✓	✓	✓
Renovations and remodeling	✓	✓		✓
Secondary bedrooms, offices, garages, basements, attics, and sun rooms	✓	✓		✓
Rooms with soffit ceilings and areas that require short duct runs		✓		
Units can be installed in conditioned spaces or in unconditioned spaces if unit is properly insulated.		✓		
Desire of innovative design and features	✓		✓	

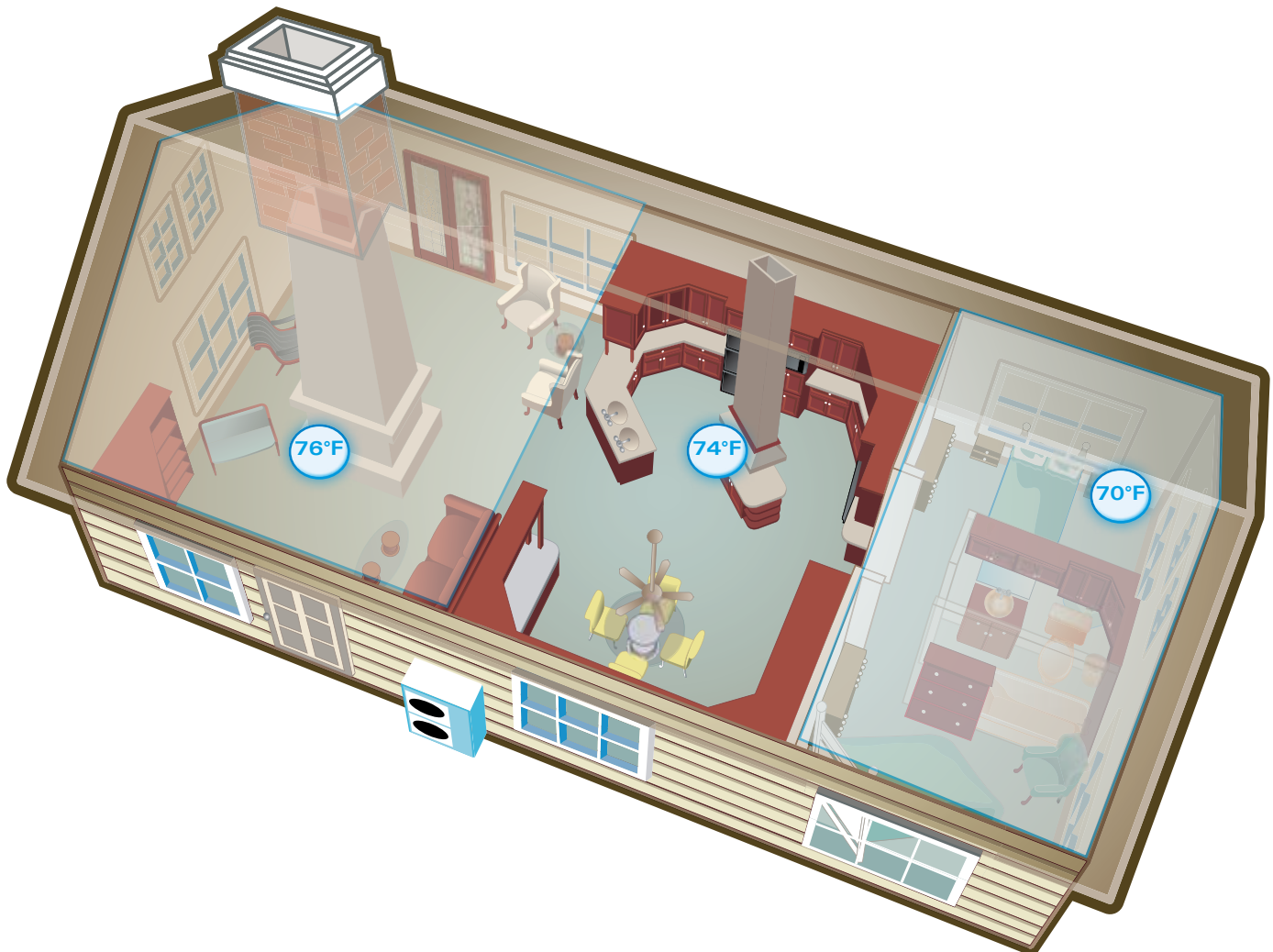

Zoned comfort control

Homeowners fight over temperatures in their homes and have rooms that go unused for long periods. Now they can save energy and control temperatures independently in up to eight separate zones with a single outdoor unit. With available wall-mounted, concealed slim-duct, ceiling cassette, and floor-mounted indoor options, Daikin Multi-Zone Systems offer multiple indoor unit styles to meet all home comfort needs.

Heat or cool multiple spaces independently with 1 outdoor unit

- » Great installation flexibility and a wide choice of styles.
- » Wide range of outdoor units, to which up to 8 indoor units can be connected.
- » All indoor units can be individually controlled.
- » The discrete, robust outdoor unit can easily be mounted onto a roof or terrace, or simply to the outside wall.
- » It is possible to combine different types of indoor units.

Compatible Indoor Units:



EMURA - Designed to perfectly balance technological capability and the beauty of aerodynamics

- » Iconic award winning design and engineering excellence
- » Elegant finish in pure matte white or modern silver
- » Two-area intelligent eye sensor controls comfort and allows for energy savings during unoccupied periods
- » Titanium apatite photo-catalytic air purification



VISTA - Unique design that integrates seamlessly into the ceiling

- » Iconic award winning design and engineering excellence
- » Elegant finish in white or silver / white combination
- » DC fan motor and two optional intelligence sensors for energy efficiency



FTXS - Discreet wall-mounted unit providing high efficiency and comfort

- » Discreet, stylish front panel blends easily with the wall, and matches all interior decors
- » Dry program allows humidity levels to be reduced without variations in room temperature
- » Intelligent Eye function reduces heating or cooling operation during unoccupied periods



FVXS - Floor mounted unit for optimal heating comfort thanks to dual airflow

- » Its low height enables the unit to fit beneath a window
- » Can be installed against a wall or recessed
- » Vertical auto swing moves the louver up and down for efficient air and temperature distribution



FDMQ - Ducted concealed unit capable of up to .6 esp

- » Higher external static pressure capabilities allow for longer duct runs and easily implementing high MERV filters
- » Drain Pan inspection port makes it easy to observe drain pan conditions
- » Rear or bottom return air configurations for installation flexibility



FDXS/CDXS - Slim duct concealed ceiling unit capable of up to 0.18 esp

- » External static pressure facilitates unit's use with minimal length of duct runs
- » Discretely concealed in the ceiling; only the suction and discharge grills are visible
- » DC fan motor for low energy consumption

Multi-Zone Systems

Daikin **AURORA** OUTDOOR UNITS

Up to 21.7 SEER | Up to 12.5 HSPF

COMFORTABLE LIMITED
WARRANTY* PROTECTION



* Complete warranty details available from your local dealer/contractor or at www.daikincomfort.com. To receive the 12-Year Parts Limited Warranty, online registration must be completed within 60 days of installation. Online registration is not required in California or Quebec.
If product installed in a commercial application, limited warranty period is 5 years.

The Daikin **AURORA** multi-zone system is a flexible solution for individual zone comfort. Connecting up to 4 indoor units to a single outdoor unit reduces installation space and costs while maximizing comfort and energy efficiency. With a choice of 6 indoor unit types in a wide range of capacities, For all regions, the outdoor units of the multi-zone **AURORA** heat pump system have been redesigned to withstand extreme weather conditions with excellent energy efficiency ratings.

Standard Features

- » Multi-Zone comfort: One outdoor unit connects up to four separate fan coils individually controlled
- » Energy Efficient – Up to 21.7 SEER, up to 12.5 HSPF, up to 12.7 EER – Variable-Speed Inverter Compressor
- » Cooling Range 14° - 115°F
- » Heating Range -13° - 60°F
- » Up to 100% heating capacity at 5°F / -15°C with confirmed continuous operation down to -13°F / 25°C
- » Quick and easy installation
- » Precision temperature control for individual rooms
- » Space-saving design
- » Quiet operation
- » Fully optimized for R-410A refrigerant
- » World renowned Daikin Inverter "Variable Speed" compressor technology

Outdoor Unit	Optional Accessories
KPW063A4	Air Direction Adjustment grille (2/3MXL)
KKG063A42	Back protection wire net (2/3MXL)
KKP937A4	Drain plug (2/3MXL)
KEH063A41E	Drain pan heater (2/3MXL)
KPS063A41	Snow hood (intake side plate) (2/3MXL)
KPS063A44	Snow hood (intake rear plate)(2/3MXL)
KPS063A47	Snow hood (outlet) (2/3MXL)
KEH082A41	Drain pan heater (4MXL)
KPW082A41	Air Direction Adjustment grille (4MXL)
KKG082A41	Back protection wire net (4MXL)

IDEAL SOLUTIONS FOR:

- › Primary living area (master bedrooms and living rooms)
- › Hot or cold rooms
- › Rooms with poor air flow
- › Renovations and remodeling
- › Basements, attics and garages
- › New construction



Daikin **AURORA heat pump for extreme weather conditions** – Up to 100% heating capacity at 5°F (-15°C) and operate efficiently as low as -13°F ambient temperature.



Outdoor Unit Quiet Operation – can reduce sound levels by 3dB for times when quieter operation is needed.



Auto-Restart – The unit memorizes the operation mode, airflow and temperature settings. Should there be a power failure when the unit is in operation, it will automatically return to the same operating conditions when the power is restored.



Intelligent Defrost Mode* – The outdoor unit will enable this mode to help prevent frost/ice from building up in cold climate conditions. It will also help with longer heating operation time for additional comfort for occupants (compared to HVAC systems without this function).*available on 4MXL only



2/3MXL outdoor unit drain pans have up to 14 holes which allows for effective drainage of condensation. In some case, this improved drain pan design eliminates the need for drain pan heaters, resulting in higher efficiencies in low ambient temperatures.



New Drain Pan – 4MXL newly designed drain pan on outdoor unit to help prevent condensate from freezing and causing damage to the fan and coil.



2/3MXL



FDXS/CDXS

FFQ

Up to 4 indoor units



4MXL

EMURA



FTXR



FDMQ



CTXS/FTXS



FVXS



Multi-Zone Systems

Daikin *AURORA*

OUTDOOR UNITS

Up to 21.7 SEER | Up to 12.5 HSPF

MULTI-ZONE SYSTEMS

Model			2MXL18QMVJU		3MXL24RMVJU		4MXL36TVJU		
			Cooling	Heating	Cooling	Heating	Cooling	Heating	
Capacity Rated	kW		21,000	25,000	30,000	36,000	34,400	36,600	
COP Rated (Min. - Max.)			—		4.20		—		
EER Rated (Min. - Max.)			12.7		—		12.5		
SEER / HSPF			See Performance Table below						
Compressor	Motor Output	W	1,920				3,000		
Refrigerant	Type		R-410A						
	Charge	lbs. (kg)	6.17 (2.8)				8.60 (3.9)		
Airflow Rate	H	cfm (m ³ /min)	2,150 (60.9)	1,963 (55.6)	2,094 (59.3)	1,886 (53.4)	3,684 (104)	3,356 (95)	
	M		2,150 (60.9)	1,963 (55.6)	2,094 (59.3)	1,780 (50.4)	3,029 (86)	3,138 (88.9)	
	L		1,949 (55.2)	1,006 (28.5)	1,977 (56.0)	1,006 (28.5)	2,756 (78)	1,500 (42.5)	
Fan	Motor Output	W	51		58		84		
	Running Current	A	H: 0.32 / M: 0.32 / L: 0.27	H: 0.33 / M: 0.33 / L: 0.07	H: 0.38 / M: 0.38 / L: 0.33	H: 0.38 / M: 0.33 / L: 0.07	H: 1.49 / M: 1.28 / L: 0.94	H: 1.28 / M: 1.15 / L: 0.38	
	Power Consumption	W	H: 62 / M: 62 / L: 54	H: 65 / M: 65 / L: 14	H: 75 / M: 75 / L: 65	H: 75 / M: 65 / L: 14	H: 158.5 / M: 93.3 / L: 73.2	H: 122.9 / M: 102.5 / L: 34.9	
Starting Current	A	15.5			17.5		27.0		
Dimension (H x W x D)	in. (mm)	28-15/16 x 34-1/4 x 12-5/8 (735 x 870 x 320)					34-1/4 x 43-5/16 x 18-1/8 (870 x 1,100 x 460)		
Weight	lbs. (kg)	139 (63)			140 (63)		214 (97)		
Sound Pressure Level	dB(A)	50	51	52	54	53	55		
Piping Connections	Liquid	in. (mm)	Ø 1/4 x 2 (Ø 6.4 x 2)		Ø 1/4 x 3 (Ø 6.4 x 3)		Ø 1/4 x 4 (Ø 6.4 x 4)		
	Gas		Ø 3/8 x 1, Ø 1/2 x 1 (Ø 9.5 x 1, Ø 12.7 x 1)		Ø 3/8 x 1, Ø 1/2 x 2 (Ø 9.5 x 1, Ø 12.7 x 2)		Ø 3/8 x 1, Ø 1/2 x 2, Ø 5/8 x 1 (Ø 9.5 x 1, Ø 12.7 x 2, Ø 15.9 x 1)		
	Drain		Ø 5/8 (Ø 15.9)				Ø 1 (Ø 25)		
Max. Interunit Piping Length	ft. (m)	164 (50) (for Total of Each Room)			230 (70) (for Total of Each Room)				
		82 (25) (for One Room)						98 (30) (for One Room)	
Amount of Additional Charge of Refrigerant	oz/ft (g/m)	0.21 (20) (98-7/16 ft (30 m) or more)			0.21 (20) (131-1/4 ft (40 m) or more)				
Max. Installation Height Difference	ft. (m)	49-1/4 (15) (between Indoor Unit and Outdoor Unit)							
		24-5/8 (7.5) (between Indoor Units)							
Operating Range - Cooling	°F DB	14° - 115°F							
Operating Range - Heating	°F WB	-13° - 60°F							
ENERGY STAR® Certified*									

* Proper sizing and installation of equipment is critical to achieving optimal performance. Split system air conditioners and heat pumps must be matched with appropriate coil components to meet ENERGY STAR criteria. Ask your contractor for details or visit www.energystar.gov.

Outdoor Unit	Power Supply				Compressor		OFM	
	Hz - Volts	Voltage Range	MCA	MOCP	MSC	RLA	W	FLA
2MXL18QMVJU	60 - 208	Min. 187 V Max. 253 V	17.1	20	15.5	15.5	51	0.33
	60 - 230							
3MXL24RMVJU	60 - 208	Min. 187 V Max. 253 V	22.6	25	17.5	17.5	122	0.42
	60 - 230							
4MXL36RVJU	60 - 208	Min. 187 V Max. 253 V	32.5	35	27	27	84	1.15
	60 - 230							

Performance					
Daikin <i>AURORA</i> Performance	Model	Connected to	SEER	EER	HSPF
		2MXL18QMVJU	Non-Ducted	17	12.7
	2MXL18QMVJU	Ducted	14	10.1	8.2
	2MXL18QMVJU	Mixed	15.5	11.4	9.25
	3MXL24RMVJU	Non-Ducted	18	12.7	12.5
	3MXL24RMVJU	Ducted	14	9.9	8.2
	3MXL24RMVJU	Mixed	15.95	11.3	10.35
	4MXL36TVJU	Non-Ducted	21.7	12.5	11.2
	4MXL36TVJU	Ducted	16.9	11	9.1
	4MXL36TVJU	Mixed	19.3	11.75	10.15



4MXL

Multi-Zone Systems

MXS series

OUTDOOR UNITS

Up to 20.2 SEER | Up to 12.5 HSPF

COMFORTABLE LIMITED WARRANTY* PROTECTION



* Complete warranty details available from your local dealer/contractor or at www.daikincomfort.com. To receive the 12-Year Parts Limited Warranty, online registration must be completed within 60 days of installation. Online registration is not required in California or Quebec. *If product installed in a commercial application, limited warranty period is 5 years.*

The Daikin Multi-Zone System is a flexible solution for individual zone comfort. Connecting up to 5 indoor units to a single outdoor unit reduces installation space and costs while maximizing comfort and energy savings. With a choice of six indoor unit types in a wide range of capacities, Daikin Multi-Zone Systems allow mixed and matched combinations.

Standard Features

- » Multi-Zone comfort: One outdoor unit connects up to five separate fan coils individually controlled
- » Energy Efficient – Up to 20.2 SEER, up to 12.5 HSPF, up to 12.7 EER – Variable Speed Inverter Compressor
- » Cooling Range 14° - 115°F
- » Heating Range 5° - 60°F
- » Quick and easy installation
- » Precision temperature control for individual rooms
- » Space-saving design
- » Quiet operation
- » Fully optimized for R-410A refrigerant
- » World renowned Daikin Inverter "Variable Speed" compressor technology
- » Intelligent Defrost Mode: The outdoor unit will enable this mode to help prevent frost/ice from building up in cold climate conditions. It will also help with longer heating operation time for additional comfort for occupants (compared to HVAC systems without this function). *available on 5MXS only

IDEAL SOLUTIONS FOR:

- › Entire homes or floors of homes
- › Multiple zones
- › New construction
- › Primary living areas (master bedrooms and living rooms)
- › Basements



2/3/4MXS series models feature an enhanced drain pan with optimal drainage for reduced ice build-up in extreme conditions.



New Drain Pan – 5MXS newly designed drain pan on outdoor unit to help prevent condensate from freezing and causing damage to the fan and coil.

Outdoor Unit	Optional Accessories
KPW063A4	Air direction adjustment grille
KKG063A42	Back protection wire net
KKP937A4	Drain plug
FTDBHML, KEH063A4E	Drain pan heater
KPS063A41	Snow hood (intake side plate)
KPS063A44	Snow hood (intake rear plate)
KPS063A47	Snow hood (outlet)

Up to 5 indoor units

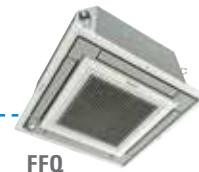

FFQ

EMURA

FTXR

FDMQ



FVXS



2/3/4MXS

Other indoor units available:



FDXS/CDXS



CTXS/FTXS



Multi-Zone Systems

MXS series

OUTDOOR UNITS

Up to 20.2 SEER | Up to 12.5 HSPF

MULTI-ZONE SYSTEMS

Model		2MXS18NMVJU		3MXS24RMVJU		4MXS36RMVJU		5MXS48TVJU	
		Cooling	Heating	Cooling	Heating	Cooling	Heating	Cooling	Heating
Capacity Rated	kW	21,000	25,000	30,000	36,000	38,000	43,000	47,000	48,500
COP Rated (Min. - Max.)		—		4.1		—		3.2 - 4.6	
EER Rated (Min. - Max.)		9.5 - 12.5		—		9.7 - 12.7		—	
SEER / HSPF		—		—		7.9 - 9.2		—	
Compressor		1,100		1,920		3,000		3,000	
Refrigerant		R-410A		R-410A		R-410A		R-410A	
Charge		3.86 (1.75)		6.17 (2.8)		8.60 (3.9)		8.60 (3.9)	
Airflow Rate		56		51		75		84	
Motor Output		W		W		W		W	
Running Current		A		A		A		A	
Power Consumption		W		W		W		W	
Starting Current		A		A		A		A	
Dimension (H x W x D)		in. (mm)		in. (mm)		in. (mm)		in. (mm)	
Weight		lbs. (kg)		lbs. (kg)		lbs. (kg)		lbs. (kg)	
Piping Connections		in. (mm)		in. (mm)		in. (mm)		in. (mm)	
Max. Interunit Piping Length		ft. (m)		ft. (m)		ft. (m)		ft. (m)	
Amount of Additional Charge of Refrigerant		oz/ft. (g/m)		oz/ft. (g/m)		oz/ft. (g/m)		oz/ft. (g/m)	
Max. Installation Height Difference		ft. (m)		ft. (m)		ft. (m)		ft. (m)	
Operating Range - Cooling		°F DB		°F DB		°F DB		°F DB	
Operating Range - Heating		°F WB		°F WB		°F WB		°F WB	
ENERGY STAR® Certified*						NO		NO	

* Proper sizing and installation of equipment is critical to achieving optimal performance. Split system air conditioners and heat pumps must be matched with appropriate coil components to meet ENERGY STAR criteria. Ask your contractor for details or visit www.energystar.gov.

Outdoor Unit	Power Supply				Compressor		OFM	
	Hz - Volts	Voltage Range	MCA	MOCP	MSC	RLA	W	FLA
2MXS18NMVJU	60 - 208	Min. 187 V Max. 253 V	15.80	20	14.0	14.0	56	0.37
	60 - 230							
3MXS24RMVJU	60 - 208	Min. 187 V Max. 253 V	21.9	25	15.5	15.5	73	0.25
	60 - 230							
4MXS36RMVJU	60 - 208	Min. 187 V Max. 253 V	23.9	25	17.5	17.5	122	0.42
	60 - 230							
5MXS48TVJU	60 - 208	Min. 187 V Max. 253 V	33.2	35	27	27	84	1.15
	60 - 230							

Performance					
MXS series Performance	Model	Connected to	SEER	EER	HSPF
		2MXS18NMVJU	Non-Ducted	18.9	12.5
2MXS18NMVJU		Ducted	14	9.5	8.2
2MXS18NMVJU		Mixed	16.45	11	9.45
3MXS24RMVJU		Non-Ducted	18	12.7	12.5
3MXS24RMVJU		Ducted	14	9.7	8.2
3MXS24RMVJU		Mixed	15.95	11.2	10.35
4MXS36RMVJU		Non-Ducted	17.7	9.2	12.2
4MXS36RMVJU		Ducted	14	7.9	8.2
4MXS36RMVJU		Mixed	15.85	8.55	10.2
5MXS48TVJU		Non-Ducted	20.2	10.5	11.1
5MXS48TVJU		Ducted	15.3	8.6	9.85
5MXS48TVJU		Mixed	17.75	9.55	8.6



5MXS

Multi-Zone Systems

OUTDOOR UNITS

RMXS_LVJU and BPMKS_A

Up to 18.8 SEER | Up to 11.3 HSPF

COMFORTABLE LIMITED WARRANTY* PROTECTION



* Complete warranty details available from your local dealer/contractor or at www.daikincomfort.com. To receive the 12-Year Parts Limited Warranty, online registration must be completed within 60 days of installation. Online registration is not required in California or Quebec. *If product installed in a commercial application, limited warranty period is 5 years.*

The 8-Zone Multi-Zone system is the ultimate, flexible solution for individual zone comfort. Connecting up to eight indoor units to a single outdoor unit reduces installation space and costs while maximizing comfort and energy savings. With a choice of six indoor unit types in a wide range of capacities, the 8-Zone Multi-Zone allows mixed and matched combinations for absolute comfort in almost any residential or light commercial application.

Standard Features

- » Multi-Zone comfort: one outdoor unit connects up to eight separate units
- » Energy Efficient – up to 18.8 SEER, up to 11.3 HSPF, up to 10.3 EER
- » Cooling Range 23° - 115°F
- » Heating Range 5° - 60°F
- » Up to 130% connection ratio
- » Long piping lengths up to 633 ft. total
- » Spacing-saving design

Outdoor Unit	Optional Accessories
KKPJ5F180	Drain plug
KHRP26A22T	REFNET joint

Space Saving Design

- » More than 60% in physical space savings versus a traditional cube style outdoor unit
- » More than 80% in total (including clearances) space savings versus a traditional cube style outdoor unit

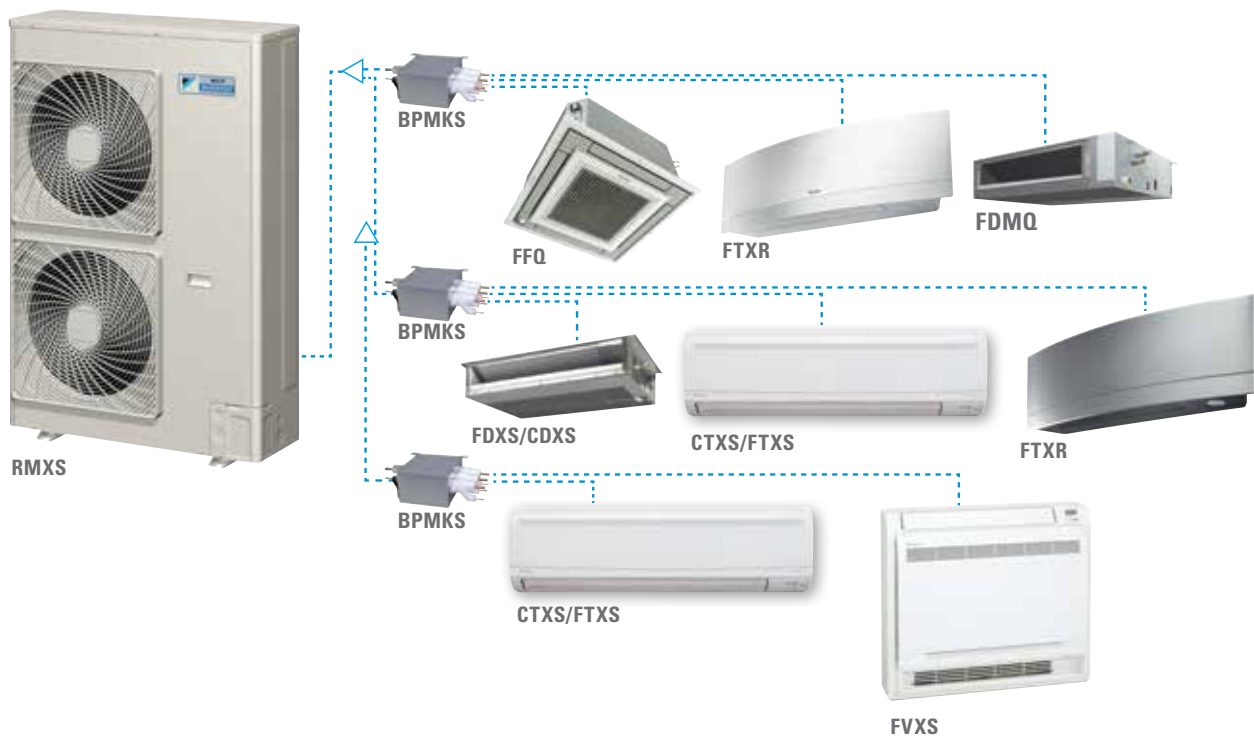
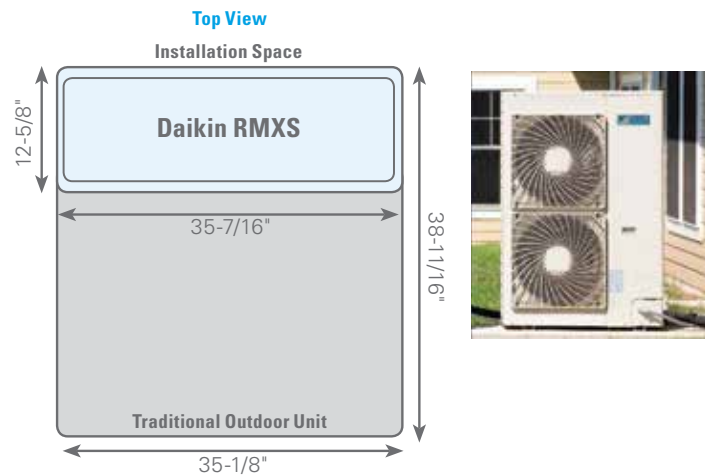

Longer Refrigerant Piping

Longer refrigerant piping capabilities offers much more flexibility in the choice of installation positions for the indoor units, and greatly simplifies system layout.

Piping Requirements			Allowable Length Details
Maximum allowable length	Between outdoor and BP units	Total piping length	Piping length between outdoor and BP units ≤ 180 ft (55 m) - [Example] a+b+c+d+e ≤ 180 ft
	Between BP and indoor units		Piping length between BP and indoor units: 262 ft (80 m) - [Example] f+g+h+i+j+k+l ≤ 262ft
	Between BP and indoor unit	1 room length	Piping length between BP and indoor unit ≤ 49 ft (15 m) - [Example] f, g, h, i, j, k, l ≤ 49 ft
Allowable height	Between outdoor and indoor units	Difference in height	Difference in height between outdoor and indoor units (H1) ≤ 98 ft (30 m)
	Between outdoor and BP units		Difference in height between outdoor and BP units (H2) ≤ 98 ft (30 m)
	Between BP and BP units		Difference in height between BP and BP units (H3) ≤ 49 ft (15 m)
	Between indoor and indoor units		Difference in height between indoor and indoor units (H4) ≤ 49 ft (15 m)
Minimum allowable length		Piping length	Pipe length between outdoor unit and first refrigerant branch kit (REFNET joint) ≥ 16.4 ft [Example] a ≥ 16.4 ft
Allowable length after the REFNET branch			Piping length from first refrigerant branch kit (REFNET joint) to indoor unit ≤ 131 ft (40 m) [Example] unit 6: b+c+k ≤ 131 ft [Example] unit 5: b+e+j ≤ 131 ft [Example] unit 3: d+h ≤ 131 ft
Additional refrigerant calculation			$R = \left(\begin{array}{l} \text{Total length (ft/m)} \\ \text{of liquid piping size at} \\ \text{Ø 3/8 inch (Ø 9.5 mm)} \end{array} \right) \times \begin{array}{l} 0.036 \text{ lb./ft} \\ (0.054 \text{ kg/m}) \end{array} + \left(\begin{array}{l} \text{Total length (ft/m)} \\ \text{of liquid piping size at} \\ \text{Ø 1/4 inch (Ø 6.4 mm)} \end{array} \right)$

BPMKS

- » Branch Provider Unit
- » Varies the refrigerant volume to meet the cooling or heating requirements of each room connected to the system.
- » Facilitates zone on/off and capacity control to operate rooms individually via zone temperature controls
- » Simple installation with flare nut connections

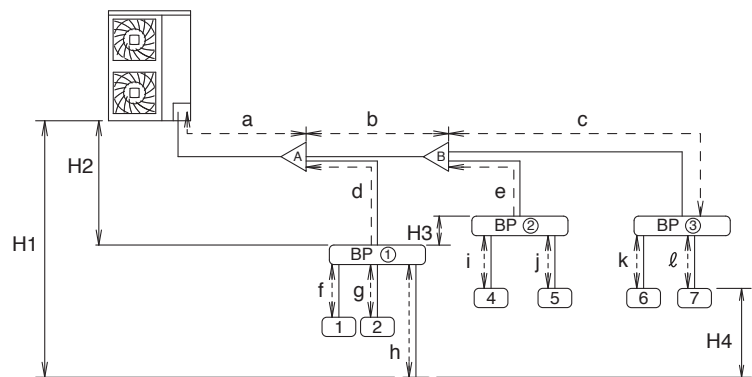
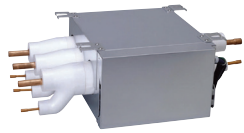

REFNET joint

- » Reduces the amount of work involved in installation and increases the reliability of the system.

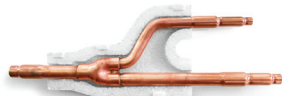

REFNET Joint

Multi-Zone Systems

OUTDOOR UNITS

RMXS_LVJU and BPMKS_A

Up to 18.8 SEER | Up to 11.3 HSPF

Model			RMXS48LVJU	
			Cooling	Heating
Capacity	Btu/h		48,000	54,000
COP Rated (Min. - Max.)				
EER Rated (Min. - Max.)				
SEER / HSPF				
Compressor	Motor Output	kW	3	
Refrigerant	Type		R-410A	
	Charge	lbs. (kg)	8.8 (4.0)	
Fan	Motor Output	kW	0.070 x 2	
	Airflow rate	cfm	3740	
Dimension (H x W x D)		in. (mm)	52-15/16 x 35-7/16 x 12-5/8 (1,345 x 900 x 320)	
Weight		lbs. (kg)	283 (129)	
Piping Connections	Liquid	in. (mm)	3/8 (9.5) C1220T (Flare Connection)	
	Gas		3/4 (19.1) C1220T (Brazing Connection)	
Operating Range - Cooling*		°F DB	23° - 115°F	
Operating Range - Heating		°F WB	5° - 60°F	

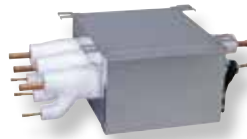

Model			BPMKS048A2U	BPMKS049A3U
Power Consumption	W		10	10
Running Current	A		0.05	0.05
Refrigerant Type				
Heat insulation				
Both Liquid and Gas Pipes				
Min. Combination				
Btu/h				
Max. Combination				
Btu/h				
Dimension (H x W x D)		in. (mm)	7-1/16 x 11-9/16 [26-11/16]* 13-3/4 (180 x 294 [678]* x 350)	
Weight		lbs. (kg)	18 (8)	20 (9)
Piping Connections	Liquid	O.U. side	Ø 3/8 (Ø 9.5) x 1	
		I.U. side	Ø 1/4 (Ø 6.4) x 2	Ø 1/4 (Ø 6.4) x 3
	Gas	O.U. side	Ø 5/8 (Ø 15.9) x 1	
		I.U. side	Ø 5/8 (Ø 15.9) x 2	Ø 5/8 (Ø 15.9) x 3

[*] -including auxiliary piping length

Unit Combination	Outdoor Unit	Hz - Volts	Power Supply				Compressor		OFM	
			Voltage Range	Min	Max	MCA	MOCP	MSC	RLA	W
RMXS48LVJU	60	208	187	229	27.0	30	23.7	22.7	70 x 2	0.3 x 2
			207	253			21.5	20.5	70 x 2	0.3 x 2

MXS series Performance		SEER	EER	HSPF
RMXS48LVJU	Non-Ducted	18.8	10.3	11.3
	Ducted	14.1	9.3	9.6
	Mixed	16.45	9.8	10.45

Simplified Electrical Wiring

The outdoor unit and BP units operate from separate 208/230V single-phase power supplies. Indoor units are powered from the BP unit and wired as Daikin's current 4 wire single split systems reducing the wiring size and easing installation

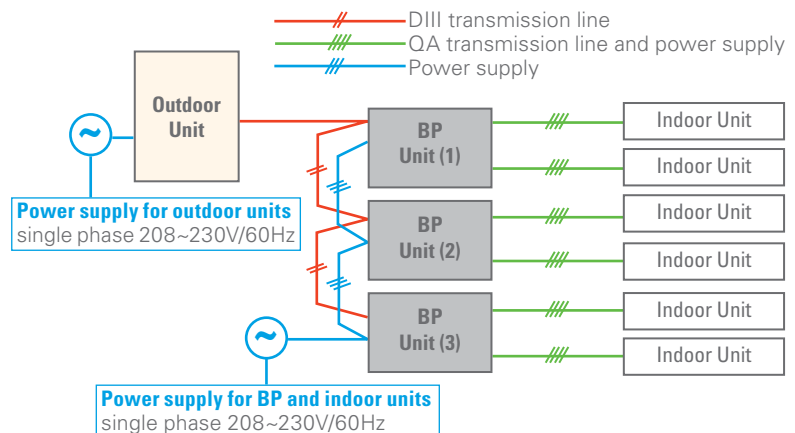



Multi-Zone Systems

EMURA Wall-Mounted

INDOOR UNITS

FTXR_TVJU (W/S)

COMFORTABLE LIMITED
WARRANTY* PROTECTION



* Complete warranty details available from your local dealer/contractor or at www.daikincomfort.com. To receive the 12-Year Parts Limited Warranty, online registration must be completed within 60 days of installation. Online registration is not required in California or Quebec. If product installed in a commercial application, limited warranty period is 5 years.

The Daikin *EMURA* wall-mounted units, are the next generation of home air conditioning is available for Multi-Zone combinations, offering smart technology within a sleek, curved silhouette. Daikin *EMURA* is designed to satisfy a uniquely “Designer” sense of style.

Offering sophisticated solutions for contemporary interiors, the new Daikin *EMURA* combines form and functionality to create an icon of contemporary climate control. Available in silver or pure matte white, Daikin *EMURA* makes a modern design statement on any wall.

Standard Features

- » Indoor Sound Pressure as low as 19 dB(A)
- » 2-Area Intelligent Eye
- » Power airflow dual flaps and 3-D Airflow
- » Titanium Apatite Photocatalytic Air Purifying Filter
- » Weekly Timer
- » Program Dry Function
- » Econo Mode
- » Comfort Mode
- » Powerful Operation Mode
- » Backlit Wireless Remote Controller

Optional Features

- » Wired controller
- » Compatible with Daikin Comfort App (adaptor required)

Indoor Unit	Optional Accessories
BRC944B2-A08	Wired Remote Controller kit (Includes BRC944B2 & BRCW901A08)
DACA-BRCW901P10	Remote Controller Cable, Plenum Rated, 10 ft (For BRC944B2)
DACA-BRCW901P25	Remote Controller Cable, Plenum Rated, 25 ft (For BRC944B2)
BRP072A43	Wireless Interface Adaptor
DACA-CP1-1	Condensate Pump (Fits inside all Daikin indoor unit heads - 33 ft head - 22dB)
KAF970A46	07, 15, 18 Class Air-purifying filter with photocatalytic deodorizing function (without frame)
KRP928BB2S	Interface adaptor for DIII-NET



IDEAL SOLUTIONS FOR:

- » Renovations, remodeling and new construction
- » Sun rooms, basements, garages, hot or cold rooms, attics where the walls tend to be lower, or wherever wall space is at a premium
- » Ceiling void or attic does not allow for a viable duct run option
- » Homeowners desiring advanced features for comfort, savings, and a “Designer” sense of style



Daikin Comfort App – Easily control your system from anywhere in the world or the comfort of your living room.



3-D Airflow – Combines vertical and horizontal auto-swing to circulate cool/warm air to the corners of large spaces.



Comfort Mode – Comfort Mode operation improves comfort. When cooling, the flap positions itself horizontally to prevent cold airflow from being blown directly onto the body. When heating, the flap turns vertically downwards to drive warm air to the bottom of the room.



2-Area Intelligent Eye – The two-area intelligent eye sensor controls comfort in two ways. If the room is empty for 20 minutes, it changes the set point to start saving energy. As soon as someone enters the room, it immediately returns to the original setting. The intelligent eye also directs air flow away from people in the room to avoid cold drafts.



Titanium Apatite Photocatalytic Air Purifying Filter – (Option) This filter combines the air-purifying filter and titanium apatite photocatalytic deodorizing filter in a single highly effective unit.



Night Set Mode – Rapid changes in room temperature can disturb your sleep. To avoid this, Daikin *EMURA* prevents overheating or over-cooling during the night. If the timer is switched on, the unit will automatically set the temperature to 3°F warmer.



Auto-Restart – The unit memorizes the operation mode, airflow and temperature settings. Should there be a power failure when the unit is in operation, it will automatically return to the same operating conditions when the power is restored.

Multi-Zone Systems

EMURA Wall-Mounted

INDOOR UNITS

FTXR_TVJU (W/S)

Pure matte white finish



Silver finish



Wireless I/R controller



Model			FTXR09TVJUW (White) FTXR09TVJUS (Silver)		FTXR12TVJUW (White) FTXR12TVJUS (Silver)		FTXR18TVJUW (White) FTXR18TVJUS (Silver)	
			Cooling	Heating	Cooling	Heating	Cooling	Heating
Nominal Capacity			9 kBtu/h Class		12 kBtu/h Class		18 kBtu/h Class	
Front Panel Color			White or Silver		White or Silver		White or Silver	
Airflow Rate	H	cfm (m ³ /min)	279 (7.9)	346 (9.8)	335 (9.5)	395 (11.2)	350(9.9)	413 (11.7)
	M		208 (5.9)	258 (7.3)	219 (6.2)	290 (8.2)	275 (7.8)	332 (9.4)
	L		162 (4.6)	201 (5.7)	169 (4.8)	226 (6.4)	226 (6.4)	275 (7.8)
	SL		134 (3.8)	117 (3.3)	131 (3.7)	131 (3.7)	208 (5.9)	208 (5.9)
Fan	Motor Output	W	29					
	Speed	Steps	5 Steps, Quiet, Auto					
Air Direction Control			Right, Left, Horizontal, Downward					
Air Filter			Removable, Washable, Mildew Proof					
Power Consumption (Rated)		W	13	26	26	38	28	42
Dimensions (H x W x D)		in. (mm)	11-15/16 x 39-5/16 x 8-3/8 (303 x 998 x 212)					
Weight (Mass)		lbs. (kg)	27 (12)					
Sound Pressure Level	H / M / L / SL	dB(A)	38 / 32 / 25 / 19	41 / 34 / 28 / 19	45 / 34 / 26 / 20	45 / 37 / 29 / 20	46 / 40 / 35 / 30	47 / 41 / 35 / 30
Piping Connections	Liquid	in.(mm)	Ø 1/4 (Ø 6.4)					
	Gas		Ø 3/8 (Ø 9.5)			Ø 1/2 (Ø 12.7)		
	Drain		Ø 11/16 (Ø 18)					

MULTI-ZONE SYSTEMS

Multi-Zone Systems

INDOOR UNITS

CTXS_LVJU and FTXS_LVJU

COMFORTABLE LIMITED
WARRANTY* PROTECTION



* Complete warranty details available from your local dealer/contractor or at www.daikincomfort.com. To receive the 12-Year Parts Limited Warranty, online registration must be completed within 60 days of installation. Online registration is not required in California or Quebec. If product installed in a commercial application, limited warranty period is 5 years.

CTXS/FTXS series is a feature-packed, intelligent wall-mounted system that includes intelligent eye for energy savings and horizontal auto swing outlet fins for 3-D airflow comfort.

Standard Features

- » Indoor Sound Pressure as low as 22 dB(A)
- » Intelligent Eye
- » Power airflow dual flaps and 3-D Airflow
- » Titanium Apatite Photocatalytic Air Purifying Filter
- » Weekly Timer
- » Program Dry Function
- » Econo Mode
- » Powerful Operation Mode
- » Backlit Wireless Remote Controller
- » Auto-Changeover
- » Auto-Fan Speed Control

Optional Features

- » Wired controller
- » Compatible with Daikin Comfort App (adaptor required)

Indoor Unit	Optional Accessories
BRC944B2-A08	Wired Remote Controller kit (Includes BRC944B2 & BRCW901A08)
DACA-BRCW901P10	Remote Controller Cable, Plenum Rated, 10 ft (For BRC944B2)
DACA-BRCW901P25	Remote Controller Cable, Plenum Rated, 25 ft (For BRC944B2)
BRP072A43	Wireless Interface Adaptor
DACA-CP1-1	Condensate Pump (Fits inside all Daikin indoor unit heads - 33 ft head - 22dB)
DACA-CP2-1	Condensate Pump (Higher ft head needs - 50 ft head - 38db)
DACA-CP3-1	Condensate Pump (Will not fit in certain unit size heads - 33 ft head - 22dB)
KAF952A42	09, 12 Class Air-purifying filter with photocatalytic deodorizing function (without frame)
KAF970A46	07, 15, 18 Class Air-purifying filter with photocatalytic deodorizing function (without frame)
KRP928BB2S	Interface adaptor for DIII-NET



IDEAL SOLUTIONS FOR:

- » Renovations, remodeling and new construction
- » Sun rooms, basements, garages, hot or cold rooms, attics where the walls tend to be lower, or wherever wall space is at a premium
- » Ceiling void or attic does not allow for a viable duct run option
- » Homeowners desiring advanced features for comfort and savings



3-D Airflow – Combines vertical and horizontal auto-swing to circulate cool/warm air to the corners of large spaces.



Intelligent Eye – The intelligent eye is an infrared sensor with the ability to sense movement in the room. When you are in the room, the air conditioner operates normally. If you leave the room for more than 20 minutes the air conditioner automatically changes to an energy-saving operation. Using the intelligent eye, savings of up to 20% in cooling and up to 30% in heating can be achieved compared to units without this feature.



Hot Start – (Heat Pump) When the heating operation starts or when the unit changes from cooling to heating, there is no cold draft.



Titanium Apatite Photocatalytic Air Purifying Filter – This filter combines the air-purifying filter and titanium apatite photocatalytic deodorizing filter in a single highly effective unit.



Auto-Restart – The unit memorizes the operation mode, airflow and temperature settings. Should there be a power failure when the unit is in operation, it will automatically return to the same operating conditions when the power is restored.



Powerful Operation Mode – Pushing the POWERFUL button on the remote control gives you a boost in cooling or heating power for a 20-minute period, even if the unit is already operating at high capacity.

Multi-Zone Systems INDOOR UNITS CTXS_LVJU and FTXS_LVJU



MULTI-ZONE SYSTEMS

Model			CTXS07LVJU		FTXS09LVJU		FTXS12LVJU	
			Cooling	Heating	Cooling	Heating	Cooling	Heating
Nominal Capacity			7 kBtu/h Class		9 kBtu/h Class		12 kBtu/h Class	
Front Panel Color			White					
Airflow Rate	H	cfm (m ³ /min)	332 (9.4)	350 (9.9)	381 (10.8)	420 (11.9)	403 (11.4)	438 (12.4)
	M		261 (7.4)	290 (8.2)	279 (7.9)	321 (9.1)	307 (8.7)	335 (9.5)
	L		194 (5.5)	233 (6.6)	194 (5.5)	233 (6.6)	205 (5.8)	240 (6.8)
	SL		145 (4.1)	219 (6.2)	145 (4.1)	219 (6.2)	155 (4.4)	212 (6.0)
Fan	Motor Output	W	23					
	Speed	Steps	5 Steps, Quiet, Auto					
Air Direction Control			Right, Left, Horizontal, Downward					
Air Filter			Removable, Washable, Mildew Proof					
Power Consumption (Rated)		W	18	21	18	21	26	28
Dimensions (H x W x D)		in. (mm)	11-5/8 x 31-1/2 x 8-7/16 (295 x 800 x 215)					
Weight (Mass)		lbs. (kg)	20 (9)				22 (10)	
Sound Pressure Level	H / M / L / SL	dB(A)	38 / 32 / 25 / 22	38 / 33 / 28 / 25	41 / 33 / 25 / 22	42 / 35 / 28 / 25	45 / 37 / 29 / 23	45 / 39 / 29 / 26
	Liquid		in. (mm)	Ø 1/4 (6.4)				
Piping Connections	Gas	in. (mm)	Ø 3/8 (9.5)					
	Drain	in. (mm)	Ø 5/8 (16.0)					

Model			FTXS15LVJU		FTXS18LVJU		FTXS24LVJU	
			Cooling	Heating	Cooling	Heating	Cooling	Heating
Nominal Capacity			15 kBtu/h Class		18 kBtu/h Class		24 kBtu/h Class	
Front Panel Color			White					
Airflow Rate	H	cfm (m ³ /min)	568 (16.1)	593 (16.8)	583 (16.5)	625 (17.7)	643 (18.2)	699 (19.8)
	M		477 (13.5)	505 (14.3)	484 (13.7)	526 (14.9)	494 (14.0)	572 (16.2)
	L		385 (10.9)	417 (11.8)	385 (10.9)	431 (12.2)	350 (9.9)	445 (12.6)
	SL		360 (10.2)	371 (10.5)	360 (10.2)	399 (11.3)	328 (9.3)	403 (11.4)
Fan	Motor Output	W	48					
	Speed	Steps	5 Steps, Quiet, Auto					
Air Direction Control			Right, Left, Horizontal, Downward					
Air Filter			Removable, Washable, Mildew Proof					
Power Consumption (Rated)		W	38 - 38				69 - 68	
Dimensions (H x W x D)		in. (mm)	13-3/8 x 41-5/16 x 9-3/4 (340 x 1,050 x 248)					
Weight (Mass)		lbs. (kg)	31 (14)					
Sound Pressure Level	H / M / L / SL	dB(A)	45 / 40 / 35 / 32	43 / 38 / 33 / 30	46 / 41 / 36 / 33	45 / 40 / 35 / 32	51 / 44 / 37 / 34	48 / 42 / 37 / 34
	Liquid		in. (mm)	Ø 1/4 (6.4)				
Piping Connections	Gas	in. (mm)	Ø 1/2 (12.7)				Ø 5/8 (15.9)	
	Drain	in. (mm)	Ø 5/8 (16)					

Multi-Zone Systems

INDOOR UNITS

FDXS _LVJU and CDXS

COMFORTABLE LIMITED
WARRANTY* PROTECTION



* Complete warranty details available from your local dealer/contractor or at www.daikincomfort.com. To receive the 12-Year Parts Limited Warranty, online registration must be completed within 60 days of installation. Online registration is not required in California or Quebec.
If product installed in a commercial application, limited warranty period is 5 years.

A slim-ducted concealed ceiling unit provides an extremely unobtrusive, compact solution, where only the discharge and intake grilles are visible. In addition, they free up floor and wall space to minimize the impact on decor.

Standard Features

- » Indoor Sound Pressure as low as 31 dB(A)
- » Program Dry Function
- » Econo Mode
- » Powerful Operation Mode
- » Backlit Wireless Remote Controller
- » Auto-Changeover
- » Auto-Fan Speed Control
- » Self-Diagnostics with Digital Display

Optional Features

- » Wired controller
- » Compatible with Daikin Comfort App (adaptor required)

Indoor Unit	Optional Accessories
BRC944B2-A08	Wired Remote Controller kit (Includes BRC944B2 & BRCW901A08)
DACA-BRCW901P10	Remote Controller Cable, Plenum Rated, 10 ft (For BRC944B2)
DACA-BRCW901P25	Remote Controller Cable, Plenum Rated, 25 ft (For BRC944B2)
BRP072A43	Wireless Interface Adaptor
DACA-CP1-1	Condensate Pump (33 ft head - 22dB)
DACA-CP2-1	Condensate Pump (Higher ft head needs - 50 ft head - 38db)
DACA-CP3-1	Condensate Pump (33 ft head - 22dB)
KRP928BB2S	Interface adaptor for DIII-NET
DACA-ARCW901P10	IR Receiver Box Cable, Plenum Rated, 10ft
DACA-ARCW901P25	IR Receiver Box Cable, Plenum Rated, 25ft
KDT25N32	09, 12 Class Insulation kit for high humidity
KDT25N50	15, 18 Class Insulation kit for high humidity

IDEAL SOLUTIONS FOR:

- » Renovations, remodeling and new construction
- » Sun rooms, basements, garages, hot or cold rooms, attics where the walls tend to be lower, or wherever wall space is at a premium
- » Ceiling void or attic does not allow for a viable standard ducted solution
- » Homeowners' reluctance to use a visible wall or a floor mounted unit



Daikin Comfort App – Easily control your system from anywhere in the world or the comfort of your living room.



Hot Start – (Heat Pump) When the heating operation starts or when the unit changes from cooling to heating, there is no cold draft.



Powerful Operation Mode – Pushing the POWERFUL button on the remote control gives you a boost in cooling or heating power for a 20-minute period, even if the unit is already operating at high capacity.



Multi-Zone Systems INDOOR UNITS FDXS_LVJU and CDXS



MULTI-ZONE SYSTEMS

Model			CDXS07LVJU		FDXS09LVJU		FDXS12LVJU	
			Cooling	Heating	Cooling	Heating	Cooling	Heating
Nominal Capacity			7 kBtu/h Class		9 kBtu/h Class		12 kBtu/h Class	
External Static Pressure		inAq (Pa)	0.12 (30)		0.12 (30)		0.12 (30)	
Airflow Rate	H	cfm (m ³ /min)	305 (8.6)	305 (8.6)	305 (8.6)	305 (8.6)	305 (8.6)	305 (8.6)
	M		280 (7.9)	280 (7.9)	280 (7.9)	280 (7.9)	280 (7.9)	280 (7.9)
	L		260 (7.4)	260 (7.4)	260 (7.4)	260 (7.4)	260 (7.4)	260 (7.4)
	SL		235 (6.7)	235 (6.7)	235 (6.7)	235 (6.7)	235 (6.7)	235 (6.7)
Fan	Motor Output	W	62					
	Speed	Steps	5 Steps, Quiet, Auto					
Air Filter			Removable, Washable, Mildew Proof					
Power Consumption (Rated)		W	72					
Dimensions (H × W × D)		in. (mm)	7-7/8 × 27-9/16 × 24-7/16 (200 × 700 × 620)					
Weight (Mass)		lbs. (kg)	47 (21)					
Sound Pressure Level	H / M / L	dB(A)	35 / 33 / 31					
Piping Connections	Liquid	in. (mm)	Ø 1/4 (Ø 6.4)					
	Gas		Ø 3/8 (Ø 9.5)					
	Drain		Ø 25/32 (Ø 20)					

Model			CDXS15LVJU		CDXS18LVJU		CDXS24LVJU	
			Cooling	Heating	Cooling	Heating	Cooling	Heating
Nominal Capacity			15 kBtu/h Class		18 kBtu/h Class		24 kBtu/h Class	
External Static Pressure		inAq (Pa)	0.16 (40)		0.16 (40)		0.16 (40)	
Airflow Rate	H	cfm (m ³ /min)	424 (12.0)	424 (12.0)	424 (12.0)	424 (12.0)	565 (16)	565 (16)
	M		388 (11.0)	388 (11.0)	388 (11.0)	388 (11.0)	523 (14.8)	523 (14.8)
	L		353 (10.0)	353 (10.0)	353 (10.0)	353 (10.0)	477 (13.5)	477 (13.5)
	SL		297 (8.4)	297 (8.4)	297 (8.4)	297 (8.4)	395 (11.2)	395 (11.2)
Fan	Motor Output	W	130					
	Speed	Steps	5 Steps, Quiet, Auto					
Air Filter			Removable, Washable, Mildew Proof					
Power Consumption (Rated)		W	172		160		160	
Dimensions (H × W × D)		in. (mm)	7-7/8 × 35-7/16 × 24-7/16 (200 × 900 × 620)		7-7/8 × 43-5/16 × 24-7/16 (200 × 1,100 × 620)			
Weight		lbs. (kg)	60 (27)		66 (30)			
Sound Pressure Level	H / M / L / SL	dB(A)	37 / 35 / 33 / 31		38/36/34/32			
Piping Connections	Liquid	in. (mm)	Ø 1/4 (Ø 6.4)					
	Gas		Ø 1/2 (Ø 12.7)					
	Drain		Ø 1-1/32 (Ø 26) Ø 25/32 (Ø 20))		Ø 1-1/32 (Ø 26) Ø 25/32 (Ø 20))		Ø 5/8 (Ø 15.8) Ø 1-1/32 (Ø 26) Ø 25/32 (Ø 20))	

Multi-Zone Systems

INDOOR UNITS

FDMQ_RVJU

Ducted Concealed

COMFORTABLE LIMITED
WARRANTY* PROTECTION



* Complete warranty details available from your local dealer/contractor or at www.daikincomfort.com. To receive the 12-Year Parts Limited Warranty, online registration must be completed within 60 days of installation. Online registration is not required in California or Quebec. *If product installed in a commercial application, limited warranty period is 5 years.*

A ducted concealed ceiling unit provides a completely concealed installation, minimizing the impact on decor. Easily incorporate longer duct runs and MERV filters with available external static pressures of up to 0.6.

Standard Features

- » Indoor Sound Pressure as low as 32 dB(A)
- » Auto-Fan Speed control (with wired controller)
- » No optional adaptor needed for DIII-connection, link your unit into the wider building management system
- » Self-Diagnostics with digital display
- » Drain Pan Inspection Port
- » Integral lift mechanism
- » Compatible with DKN Cloud Wi-Fi Adaptor

Indoor Unit	One Controller Required
BRC1E73	Wired Remote Controller
KRCS01-4B	Remote Sensor
BRC082A43	Wireless handheld controller (sensor included)
AZAI6WSCDKA	DKN Cloud Wi-Fi Adaptor (Requires BRC1E73)
DFBS27A13	MERV 13 Filter Kit for FDMQ 09 & 12
DFBS39A13	MERV 13 Filter Kit for FDMQ 15, 18 & 24

IDEAL SOLUTIONS FOR:

- » Renovations, remodeling and new construction
- » Sun rooms, basements, garages, hot or cold rooms, attics where the walls tend to be lower, or wherever wall space is at a premium
- » Ceiling void or attics which allow for a ducted solution with longer duct runs
- » Homeowners requiring higher level of filtration
- » Homeowners' reluctance to use a visible wall or a floor mounted unit



Program dry function – This gives priority to reducing the level of humidity in the room rather than room temperature.



Hot Start – (Heat Pump) When the heating operation starts or when the unit changes from cooling to heating, there is no cold draft.



Powerful Operation Mode – Pushing the POWERFUL button on the remote control gives you a boost in cooling or heating power for a 20-minute period, even if the unit is already operating at high capacity.



- » Increases the flexibility of the FDMQ systems in both residential and commercial applications by adding a Zoning Box to an indoor unit fan coil
- » Allows several separate ducts to supply air to different individually-controlled zones.
- » The DZK BACnet™ Interface will work with any BACnet/IP compatible Building Management System



Wired*
Thermostat



Wireless*
Thermostat



Wireless Lite*
Thermostat

*for DZK Kit

Multi-Zone Systems INDOOR UNITS FDMQ_RVJU Ducted Concealed



MULTI-ZONE SYSTEMS

Model			FDMQ09RVJU		FDMQ12RVJU		FDMQ15RVJU	
			Cooling	Heating	Cooling	Heating	Cooling	Heating
Nominal Capacity			9 kBtu/h Class		12 kBtu/h Class		15 kBtu/h Class	
External Static Pressure		inAq (Pa)	0.6 (150)					
Airflow Rate	H	cfm (m³/min)	343 (9.7)	343 (9.7)	392 (11.1)	392 (11.1)	516 (19.1)	516 (19.1)
	M		290 (8.2)	290 (8.2)	332 (9.4)	332 (9.4)	438 (12.4)	438 (12.4)
	L		240 (6.8)	240 (6.8)	275 (7.8)	275 (7.8)	360 (10.2)	360 (10.2)
	SL		—	—	—	—	—	—
Fan	Motor Output	W	—					
	Speed	Steps	—					
Air Filter			—					
Power Consumption (Rated)		W	—					
Dimensions (H × W × D)		in. (mm)	9-5/8 × 27-9/16 × 31-1/2 (245 × 700 × 800)			9-5/8 × 39-3/8 × 31-1/2 (245 × 1,000 × 800)		
Weight (Mass)		Lbs (kg)	64 (29)			77 (35)		
Sound Pressure Level	H / M / L	dB(A)	32		33		34	
Piping Connections	Liquid	in. (mm)	—				Ø 1/4 (Ø 6.4)	
	Gas		Ø 3/8 (Ø 9.5)				Ø 1/2 (Ø 12.7)	
	Drain		—				Ø 1 (25.0)	

Model			FDMQ18RVJU		FDMQ24RVJU			
			Cooling	Heating	Cooling	Heating		
Nominal Capacity			18 kBtu/h Class		24 kBtu/h Class			
External Static Pressure		inAq (Pa)	0.6 (150)					
Airflow Rate	H	cfm (m³/min)	675 (19.1)	675 (19.1)	798 (22.6)	798 (22.6)		
	M		572 (16.2)	572 (16.2)	678 (19.2)	678 (19.2)		
	L		473 (13.4)	473 (13.4)	558 (15.8)	558 (15.8)		
	SL		—	—	—	—		
Fan	Motor Output	W	—					
	Speed	Steps	—					
Air Filter			—					
Power Consumption (Rated)		W	—					
Dimensions (H × W × D)		in. (mm)	9-5/8 × 39-3/8 × 31-1/2 (245 × 1,000 × 800)					
Weight		Lbs (kg)	82 (37)					
Sound Pressure Level	H	dB(A)	35		40			
Piping Connections	Liquid	in. (mm)	—				Ø 1/4 (Ø 6.4)	
	Gas		Ø 1/2 (Ø 12.7)		Ø 5/8 (Ø 15.9)			
	Drain		—				Ø 1 (25.0)	

Multi-Zone Systems

INDOOR UNITS

FVXS_NVJU

COMFORTABLE LIMITED WARRANTY* PROTECTION



* Complete warranty details available from your local dealer/contractor or at www.daikincomfort.com. To receive the 12-Year Parts Limited Warranty, online registration must be completed within 60 days of installation. Online registration is not required in California or Quebec. *If product installed in a commercial application, limited warranty period is 5 years.*

Floor-mounted units are simple to install and can be setup in various configurations, on the floor or hanging low on a wall. Its low height enables the unit to fit beneath a window. The airflow distribution pattern of Daikin's floor-mounted unit is ideal for heating a space, and is a perfect replacement to traditional radiant systems.

Standard Features

- » Indoor Sound Pressure as low as 19 dB(A)
- » Washable Air Filter
- » Program Dry Function
- » Econo Mode
- » Powerful Operation Mode
- » Titanium Apatite Photocatalytic Air Purifying Filter
- » Backlit Wireless Remote Controller
- » Outdoor Unit Quiet Operation
- » Auto-Changeover
- » Auto-Fan Speed Control
- » Self-Diagnostics with Digital Display

Optional Features

- » Wired controller
- » Compatible with Daikin Comfort App (adaptor required)

Indoor Unit	Optional Accessories
BRC944B2-A08	Wired Remote Controller kit (Includes BRC944B2 & BRCW901A08)
DACA-BRCW901P10	Remote Controller Cable, Plenum Rated, 10 ft (For BRC944B2)
DACA-BRCW901P25	Remote Controller Cable, Plenum Rated, 25 ft (For BRC944B2)
BRP072A43	Wireless Interface Adaptor
DACA-CP1-1	Condensate Pump (Fits inside all Daikin indoor unit heads - 33 ft head - 22dB)
DACA-CP2-1	Condensate Pump (Higher ft head needs - 50 ft head - 38db)
DACA-CP3-1	Condensate Pump (Will not fit in certain unit size heads - 33 ft head - 22dB)
KRP928BB2S	Interface adaptor for DIII-NET
KAF968A42 or KAF968B42	Titanium apatite photocatalytic air-purifying filter (without frame)

IDEAL SOLUTIONS FOR:

- » Cold regions where homeowners want to enjoy a reliable, energy efficient source of heat
- » Renovations, remodeling and new construction
- » Sun rooms, basements, garages, hot or cold rooms, attics where the walls tend to be lower, or wherever wall space is at a premium
- » Ceiling void or attic does not allow for a viable duct run option



Auto-Restart – The unit memorizes the operation mode, airflow and temperature settings. Should there be a power failure when the unit is in operation, it will automatically return to the same operating conditions when the power is restored.



Titanium Apatite Photocatalytic Air Purifying Filter – This filter combines the air-purifying filter and titanium apatite photocatalytic deodorizing filter in a single highly effective unit.



Program dry function – This gives priority to reducing the level of humidity in the room rather than room temperature.



Comfort Mode – Comfort Mode operation improves comfort. When cooling, the flap positions itself horizontally to prevent cold airflow from being blown directly onto the body. When heating, the flap turns vertically downwards to drive warm air to the bottom of the room.



Hot Start – (Heat Pump) When the heating operation starts or when the unit changes from cooling to heating, there is no cold draft.



Powerful Operation Mode – Pushing the POWERFUL button on the remote control gives you a boost in cooling or heating power for a 20-minute period, even if the unit is already operating at high capacity.



Multi-Zone Systems

INDOOR UNITS

FVXS_NVJU



MULTI-ZONE SYSTEMS

Model			FVXS09NVJU		FVXS12NVJU		FVXS15NVJU		FVXS18NVJU	
			Cooling	Heating	Cooling	Heating	Cooling	Heating	Cooling	Heating
Nominal Capacity			9 kBtu/h Class		12 kBtu/h Class		15 kBtu/h Class		18 kBtu/h Class	
Front Panel Color			White							
Airflow Rate	H	cfm (m ³ /min)	290 (8.2)	311 (8.8)	300 (8.5)	332 (9.4)	378 (10.7)	417 (11.8)	378 (10.7)	417 (11.8)
	M		230 (6.5)	244 (6.9)	237 (6.7)	258 (7.3)	325 (9.2)	357 (10.1)	325 (9.2)	357 (10.1)
	L		169 (4.8)	177 (5.0)	173 (4.9)	184 (5.2)	275 (7.8)	300 (8.5)	275 (7.8)	300 (8.5)
	SL		145 (4.1)	155 (4.4)	159 (4.5)	166 (4.7)	233 (6.6)	251 (7.1)	233 (6.6)	251 (7.1)
Fan	Motor Output	W	12.3		13.4		23.3			
	Speed	Steps	5 Steps, Quiet, Auto							
Air Direction Control			Right, Left, Horizontal, Downward							
Air Filter			Removable, Washable, Mildew Proof							
Power Consumption (Rated)		W	15	17	15	17	27	34 - 34	—	—
Dimensions (H x W x D)		in. (mm)	23-5/8 x 27-9/16 x 8-1/4 (600 x 700 x 210)							
Weight (Mass)		lbs. (kg)	31 (14)							
Sound Pressure Level	H / M / L / SL	dB(A)	38 / 32 / 26 / 23		39 / 33 / 27 / 24		44 / 40 / 36 / 32	45 / 40 / 36 / 32	44 / 40 / 36 / 32	45 / 40 / 36 / 32
Piping Connections	Liquid	in. (mm)	Ø 1/4 (Ø 6.4)							
	Gas		Ø 3/8 (Ø 9.5)				Ø 1/2 (Ø 12.7)			
	Drain		Ø 13/16 (Ø 20)							

VISTA Ceiling Cassette

Multi-Zone Systems

INDOOR UNITS

FFQ_Q2VJU

COMFORTABLE LIMITED WARRANTY* PROTECTION



* Complete warranty details available from your local dealer/contractor or at www.daikincomfort.com. To receive the 12-Year Parts Limited Warranty, online registration must be completed within 60 days of installation. Online registration is not required in California or Quebec. *If product installed in a commercial application, limited warranty period is 5 years.*

The Daikin VISTA ceiling cassettes are a remarkable blend of iconic design and engineering excellence with an elegant white or a silver and white finish. Fitting within the ceiling grid and discreetly mounted to the ceiling itself, VISTA is stylish, low profile, and compact. High efficiency and comfort is delivered through the combined use of floor and presence sensors (optional). It is also possible to close individual louvers via the wired remote control for personalized comfort.

Standard Features

- » Indoor Sound Pressure as low as 29 dB(A)
- » Energy efficient thanks to specially developed small tube heat exchanger, DC fan motor and two optional intelligent sensors
- » No optional adaptor needed for DIII-connection, link your unit into the wider building management system
- » Draft Prevention
- » Program Dry Function
- » Hot Start Function
- » Auto-Fan Speed Control (with wired controller)
- » Self-Diagnostics with Digital Display
- » Schedule TIMER operation (with wired controller)

Optional Features

- » Wired controller
- » Fresh air integration possible
- » Presence and Floor Sensor
- » Compatible with DKN Cloud Wi-Fi Adaptor

Indoor Unit	Optional Accessories
BRC1E73	Wired <i>Navigation</i> Remote Controller (For Ceiling Cassette Only)
AZAI6WSDKA	DKN Cloud Wi-Fi Adaptor (Requires BRC1E73)
BRC082A42W	Wireless Remote Controller (White)
BRC082A42S	Wireless Remote Controller (Silver)
BYFQ60C2W1S	Low Profile Decoration Panel (Silver) - 1-19/16" x 24-7/16" x 24-7/16"
BYFQ60C2W1W	Low Profile Decoration Panel (White) - 1-19/16" x 24-7/16" x 24-7/16"
BRYQ60A2S	Sensor kit (Silver) Intel agent Eye, Comfort Airflow, and Floor Sensor
BRYQ60A2W	Sensor kit (White) intelligent Eye, Comfort Airflow, and Floor Sensor
BDBHQ44C60	Sealing member of air discharge outlet
KAFQ441BA60	Long life filter

IDEAL SOLUTIONS FOR:

- » Renovations, remodeling and new construction
- » Sun rooms, basements, garages, hot or cold rooms, attics where the walls tend to be lower, or wherever wall space is at a premium
- » Ceiling void or attic does not allow for a viable standard ducted solution
- » Homeowners' reluctance to use a visible wall or a floor mounted unit



Draft Reduction – This system directs warm air to the floor in winter and cool air across the room in summer for optimal efficiency and comfort. The large flap governs airflow direction while the small flap (or diffuser) swings, producing fine air currents that help circulate the air around the room.



Individual Louver Control – The new louver changes the delivery angle to horizontal for cooling and vertical for heating operation, to keep cold or warm air from blowing directly onto your body.



Included in the optional sensor kit: Presence and Floor Sensor (optional part #BRYQ60A2W or BRYQ60A2S)
The presence and floor sensors are infrared sensors with the ability to sense movement in the room. When you are in the room, the system operates normally. If you leave the room for more than 20 minutes the system automatically changes to an energy-saving operation. The floor sensor detects the average floor temperature and ensures even temperature distribution between ceiling and floor.

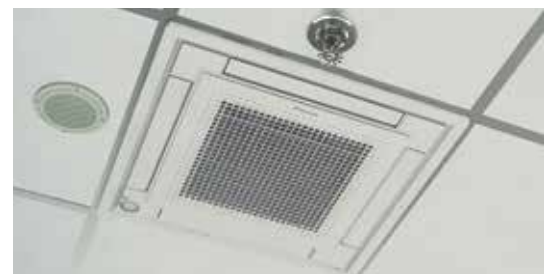

The VISTA Ceiling Cassette fits within a 2'x 2' ceiling grid and can be installed in close proximity to other building accessories.

VISTA Ceiling Cassette

Multi-Zone Systems

INDOOR UNITS

FFQ_Q2VJU

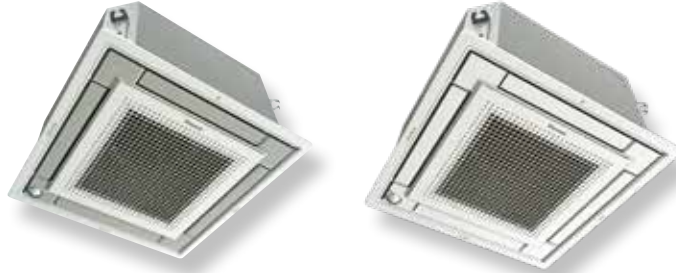

MULTI-ZONE SYSTEMS

Model			FFQ09Q2VJU		FFQ12Q2VJU	
			Cooling	Heating	Cooling	Heating
Nominal Capacity			9 kBtu/h Class		12 kBtu/h Class	
Airflow Rate	H	cfm (m ³ /min)	378 (10.7)	399 (11.3)	406 (11.5)	427 (12.1)
	M		339 (9.6)	357 (10.1)	353 (10.0)	371 (10.5)
	L		268 (7.6)	282 (8.0)	268 (7.6)	282 (8.0)
Fan	Speed	Steps	Turbo fan, 3 steps			
Air Direction Control			Up, Down			
Dimensions (H × W × D)		in. (mm)	10-1/4 × 22-5/8 × 22-5/8 (260 × 575 × 575)			
Weight		lbs. (kg)	36 (16)			
Sound Pressure Level	H / M / L	dB(A)	38 / 35 / 29		39 / 36 / 30	
Heat Insulation			Both Liquid and Gas Pipes			
Piping Connections	Liquid	in. (mm)	Ø 1/4 (Ø 6.4)			
	Gas		Ø 3/8 (Ø 9.5)			
	Drain		Ø 1-1/32 (Ø 26)			

Model			FFQ15Q2VJU		FFQ18Q2VJU	
			Cooling	Heating	Cooling	Heating
Nominal Capacity			15 kBtu/h Class		18 kBtu/h Class	
Airflow Rate	H	cfm (m ³ /min)	420 (11.9)	441 (12.5)	448 (12.7)	498 (14.1)
	M		367 (10.4)	385 (10.9)	378 (10.7)	420 (11.9)
	L		293 (8.3)	307 (8.7)	275 (7.8)	30 (8.7)
Fan	Speed	Steps	Turbo fan, 3 steps			
Air Direction Control			Up, Down			
Dimensions (H × W × D)		in. (mm)	10-1/4 × 22-5/8 × 22-5/8 (260 × 575 × 575)			
Weight		lbs. (kg)	36 (16)		39 (17.5)	
Sound Pressure Level	H / M / L	dB(A)	40 / 37 / 31		44 / 40 / 32	
Piping Connections	Liquid	in. (mm)	Ø 1/4 (Ø 6.4)			
	Gas		Ø 1/2 (Ø 12.7)			
	Drain		Ø 1-1/32 (Ø 26)			

Multi-Zone Combinations

MXL_QMVJU / MXL_RMVJU / 4MXL36TVJU / MXS_NMJVJU / MXS_RMVJU

MAX: 24K BTU/H 2MXL18 / 2MXS18	MAX: 39K BTU/H 3MXL24 / 3MXS24		MAX: 48K BTU/H 4MXL36/4MXS36				
2 Zone	2 Zone	3 Zone	2 Zone	3 Zone		4 Zone	
07+07	07+07	07+07+07	07+07	07+07+07	09+09+15	07+07+07+07	07+09+09+18
07+09	07+09	07+07+09	07+09	07+07+09	09+09+18	07+07+07+09	07+09+12+12
07+12	07+12	07+07+12	07+12	07+07+12	09+09+24	07+07+07+12	07+09+12+15
07+15	07+15	07+07+15	07+15	07+07+15	09+12+12	07+07+07+15	07+09+12+18
09+09	07+18	07+07+18	07+18	07+07+18	09+12+15	07+07+07+18	07+09+15+15
09+12	09+09	07+09+09	07+24	07+07+24	09+12+18	07+07+07+24	07+12+12+12
09+15	09+12	07+09+12	09+09	07+09+09	09+12+24	07+07+09+09	07+12+12+15
12+12	09+15	07+09+15	09+12	07+09+12	09+15+15	07+07+09+12	09+09+09+09
	09+18	07+09+18	09+15	07+09+15	09+15+18	07+07+09+15	09+09+09+12
	12+12	07+12+12	09+18	07+09+18	09+15+24	07+07+09+18	09+09+09+15
	12+15	07+12+15	09+24	07+09+24	09+18+18	07+07+09+24	09+09+09+18
	12+18	07+12+18	12+12	07+12+12	12+12+12	07+07+12+12	09+09+12+12
	15+15	07+15+15	12+15	07+12+15	12+12+15	07+07+12+15	09+09+12+15
	15+18	09+09+09	12+18	07+12+18	12+12+18	07+07+12+18	09+09+12+18
	18+18	09+09+12	12+24	07+12+24	12+12+24	07+07+15+15	09+09+15+15
		09+09+15	15+15	07+15+15	12+15+15	07+07+15+15	09+12+12+12
		09+09+18	15+18	07+15+18	12+15+18	07+09+09+09	09+12+12+15
		09+12+12	15+24	07+18+18	12+18+18	07+09+09+12	12+12+12+12
		09+12+15	18+18	09+09+09	15+15+15	07+09+09+15	
		09+12+18	18+24	09+09+12	15+15+18		
		09+15+15	24+24				
		12+12+12					
		12+12+15					

AHRI CERTIFIED REF #	MODEL	INDOOR TYPE	EER	SEER	HSPF
8849534	2MXL18QMVJU	Ducted Indoor Units	10.1	14	8.2
8849535	2MXL18QMVJU	Non-Ducted Indoor Units	12.7	17	10.3
8849536	2MXL18QMVJU	Mixed Ducted and Non-ducted Indoor Units	11.4	15.5	9.25
8103477	2MXS18NMVJU	Ducted Indoor Units	9.5	14	8.2
8103542	2MXS18NMVJU	Non-Ducted Indoor Units	12.5	18.9	10.7
8104492	2MXS18NMVJU	Mixed Ducted and Non-ducted Indoor Units	11	16.45	9.45
201851578	3MXL24RMVJU	Ducted Indoor Units	9.9	14	8.2
201851577	3MXL24RMVJU	Non-Ducted Indoor Units	12.7	17.9	12.5
201851582	3MXL24RMVJU	Mixed Ducted and Non-ducted Indoor Units	11.3	15.95	10.35

Multi-Zone Combinations

5MXS48TVJU

MAX: 58K BTU/H 5MXS48								
2 Zone	3 Zone		4 Zone			5 Zone		
07+07	07+07+07	09+12+12	07+07+07+07	07+09+12+15	09+09+12+18	07+07+07+07+07	07+07+09+15+15	09+09+09+12+15
07+09	07+07+09	09+12+15	07+07+07+09	07+09+12+18	09+09+12+24	07+07+07+07+09	07+07+09+15+18	09+09+09+12+18
07+12	07+07+12	09+12+18	07+07+07+12	07+09+12+24	09+09+15+15	07+07+07+07+12	07+07+12+12+12	09+09+09+15+15
07+15	07+07+15	09+12+24	07+07+07+15	07+09+15+15	09+09+15+18	07+07+07+07+15	07+07+12+12+15	09+09+12+12+12
07+18	07+07+18	09+15+15	07+07+07+18	07+09+15+18	09+09+15+24	07+07+07+07+18	07+07+12+12+18	09+09+12+12+15
07+24	07+07+24	09+15+18	07+07+07+24	07+09+15+24	09+09+18+18	07+07+07+07+24	07+09+09+09+09	09+12+12+12+12
09+09	07+09+09	09+15+24	07+07+09+09	07+09+18+18	09+12+12+12	07+07+07+09+09	07+09+09+09+12	
09+12	07+09+12	09+18+18	07+07+09+12	07+09+18+24	09+12+12+15	07+07+07+09+12	07+09+09+09+15	
09+15	07+09+15	09+18+24	07+07+09+15	07+12+12+12	09+12+12+18	07+07+07+09+15	07+09+09+09+18	
09+18	07+09+18	09+24+24	07+07+09+18	07+12+12+15	09+12+12+24	07+07+07+09+18	07+09+09+09+24	
09+24	07+09+24	12+12+12	07+07+09+24	07+12+12+18	09+12+15+15	07+07+07+09+24	07+09+09+12+12	
12+12	07+12+12	12+12+15	07+07+12+12	07+12+12+24	09+12+15+18	07+07+07+12+12	07+09+09+12+15	
12+15	07+12+15	12+12+18	07+07+12+15	07+12+15+15	09+12+18+18	07+07+07+12+15	07+09+09+12+18	
12+18	07+12+18	12+12+24	07+07+12+18	07+12+15+18	09+15+15+15	07+07+07+12+18	07+09+09+15+15	
12+24	07+12+24	12+15+15	07+07+12+24	07+12+15+24	09+15+15+18	07+07+07+12+24	07+09+09+15+18	
15+15	07+15+15	12+15+18	07+07+15+18	07+12+18+18	12+12+12+12	07+07+07+15+15	07+09+12+12+12	
15+18	07+15+18	12+15+24	07+07+15+15	07+15+15+15	12+12+12+15	07+07+07+15+18	07+09+12+12+15	
15+24	07+15+24	12+18+18	07+07+15+24	07+15+15+18	12+12+12+18	07+07+07+18+18	07+09+12+12+18	
18+18	07+18+18	12+18+24	07+07+18+18	07+15+18+18	12+12+15+15	07+07+09+09+09	07+09+12+15+15	
18+24	07+18+24	15+15+15	07+07+18+24	09+09+09+09	12+12+15+18	07+07+09+09+12	07+12+12+12+12	
24+24	07+24+24	15+15+18	07+09+09+09	09+09+09+12	12+15+15+15	07+07+09+09+15	07+12+12+12+15	
	09+09+09	15+15+24	07+09+09+12	09+09+09+15		07+07+09+09+18	09+09+09+09+09	
	09+09+12	15+18+18	07+09+09+15	09+09+09+18		07+07+09+09+24	09+09+09+09+12	
	09+09+15	15+18+24	07+09+09+18	09+09+09+24		07+07+09+12+12	09+09+09+09+15	
	09+09+18	18+18+18	07+09+09+24	09+09+12+12		07+07+09+12+15	09+09+09+09+18	
	09+09+24		07+09+12+12	09+09+12+15		07+07+09+12+18	09+09+09+12+12	

MULTI-ZONE SYSTEMS

AHRI CERTIFIED REF #	MODEL	INDOOR TYPE	EER	SEER	HSPF
202522139	4MXL36TVJU	Ducted Indoor Units	11	16.9	9.1
202521824	4MXL36TVJU	Non-Ducted Indoor Units	12.5	21.7	11.2
202522140	4MXL36TVJU	Mixed Ducted and Non-Ducted Indoor units	11.75	19.3	10.15
201851576	3MXS24RMVJU	Ducted Indoor Units	9.7	14	8.2
201851575	3MXS24RMVJU	Non-Ducted Indoor Units	12.7	18	12.5
201851581	3MXS24RMVJU	Mixed Ducted and Non-Ducted Indoor Units	11.2	15.95	10.35
201851580	4MXS36RMVJU	Ducted Indoor Units	7.9	14	8.2
201851579	4MXS36RMVJU	Non-Ducted Indoor Units	9.2	17.7	12.2
201851583	4MXS36RMVJU	Mixed Ducted and Non-Ducted Indoor Units	8.55	15.85	10.2
202638702	5MXS48TVJU	Ducted Indoor Units	8.6	15.3	8.6
202638701	5MXS48TVJU	Non-Ducted Indoor Units	10.5	20.2	11.1
202650862	5MXS48TVJU	Mixed Ducted and Non-Ducted Indoor Units	9.55	17.75	9.85
5731241	RMXS48LVJU	Ducted Indoor Units	9.3	14.1	9.6
5731240	RMXS48LVJU	Non-Ducted Indoor Units	10.3	18.8	11.3





SkyAir Products

SkyAir Heat Pumps and Air Conditioners



Quick and easy installation for a broad range of applications

SkyAir is the ultimate ducted and duct free solution for light commercial and residential whole house applications. Ranging from 18,000 Btu/h to 48,000 Btu/h, these innovative systems provide energy efficiency, technological reliability and installation flexibility.

SkyAir systems key features and benefits include:

- › DC fan motor improves efficiency compared to conventional AC motors.
- › Aero spiral fan and grille minimizes turbulence and increases sound reduction.
- › Reluctance brushless DC compressor increases efficiency compared to fixed-speed compressor technology.
- › Swing Compressor Model – Friction and refrigerant leakage are minimized for greater energy savings.
- › Long piping lengths up to 230 ft. allow layout flexibility.
- › Anti-corrosion treatment on the outdoor heat exchanger increases durability.
- › Low-Ambient cooling operation down to 0°F (with optional Air Adjustment Grille(s))

Model	
Wall-Mounted Units (FAQ Type)	<ul style="list-style-type: none"> › For rooms with no false ceiling nor free floor space › Energy efficiency up to SEER 17.6 and HSPF 8.6 › Wide angle louvers distribute comfortable airflow with Auto-swing function › Quiet operation as low as 37 dB(A)
DC Duct Concealed (FBQ Type)	<ul style="list-style-type: none"> › Medium external static pressure (ESP) capabilities offer up to 0.8 "W.G. › DC fan motor provides improved efficiency › Three user selected fan speeds available plus fan "Auto" logic › Built-in condensate pump › Bottom access for easy service › Low profile design at less than 12" high
Round Flow Sensing Cassette (FCQ Type)	<ul style="list-style-type: none"> › 18 configurable airflow patterns ensure ideal air distribution › 360° airflow and three room sensors enables optimized occupant comfort and efficiency › Lower air velocities provide better airflow distribution › Optional self-cleaning filter panel to automatically clean filters on a set schedule. › Condensate pump provided as standard
Ceiling Suspended (FHQ Type)	<ul style="list-style-type: none"> › Slim height at less than 8" › Auto-swing capability with 100° airflow pattern distributes comfortable airflow › Innovative stream fan technology keeps sound pressure levels low › Lateral servicing space allows installation in corners, narrow spaces, walls, and ceilings
Multi-positional Air Handling Unit (FTQ Type)	<ul style="list-style-type: none"> › Up flow, downflow, horizontal left or horizontal right configurations for the indoor unit › Designed for zero clearance on three sides and only 24" clearance on the front for service. › 100% heating capacity at -4°F (-20C) on systems up to 3 tons, without electrical heat › Field-installed electric heater options available from 3kW to 19 kW (electric heater connection kit part no.

- » Energy-Intelligent™ technology with variable speed compressors for small offices, shops, retail, stores, restaurants, banks, or technical cooling
- » Provides reliable and high quality comfort with a smart use of energy and flexible installation and operation
- » Can provide total comfort over space heating and cooling needs

Wide range of simple and/or intelligent controllers to choose from



■	Available in Heat Pump
■	Available in Cooling Only

Indoor Unit name	Sizes available (rated Cooling kBTU/h)						Matching Outdoor Units
	18	24	30	36	42	48	
 FAQ_TAVJU	■ ■	■ ■					RZR_TAVJU (Cooling Only) RZQ_TAVJU (Heat Pump) 
 FBQ_PVJU	■ ■	■ ■	■ ■	■ ■	■ ■	■ ■	RZR_TAVJU (Cooling Only) RZQ_TAVJU (Heat Pump) 
 FCQ_TAVJU	■ ■	■ ■	■ ■	■ ■	■ ■	■ ■	RZR_TAVJU (Cooling Only) RZQ_TAVJU (Heat Pump) 
 FHQ_PVJU FHQ_MVJU*	■ ■	■ ■	■ ■	■ ■ *	■ ■ *		RZR_TAVJU (Cooling Only) RZQ_TAVJU (Heat Pump) 
 FTQ_TAVJUD/A	■ ■	■ ■	■ ■	■ ■	■ ■	■ ■	RZR_TAVJU (Cooling Only) RZQ_TAVJU (Heat Pump) 

FAQ_TAVJU RZR_TAVJU / RZO_TAVJU Wall-Mounted Unit

COMFORTABLE LIMITED
WARRANTY* PROTECTION



* Complete warranty details available from your local dealer/contractor or at www.daikincomfort.com. Warranty registration not required to receive the 10-Year parts limited warranty for residential or commercial installations.

Sleek in design with comfort control features.

Standard Features

- » Energy efficiency up to SEER 17.6 and HSPF 8.4
- » Wide angle louvers distribute comfortable airflow
- » Auto-swing function ensures efficient air distribution
- » Front panel can be removed for easy cleaning
- » Quiet operation as low as 37 dB(A)
- » Optional wireless controller
- » Optional wired controller
- » Optional condensate pump



FAQ_TAVJU



DKN Cloud
Wi-Fi adaptor
(option)



BRC7E818



BRC1E73



BRC2A71



RZO_TAVJU
RZR_TAVJU

FAQ_TAVJU RZR_TAVJU / RZO_TAVJU Wall-Mounted Unit

SKYAIR PRODUCTS

Model	Indoor Unit		FAQ18TAVJU		FAQ24TAVJU	
	Outdoor Unit (Cooling Only)		RZR18TAVJU		RZR24TAVJU	
	Outdoor Unit (Heat Pump)		RZO18TAVJU		RZO24TAVJU	
			Cooling	Heating*	Cooling	Heating*
Capacity Rated	Btu/h		18,000	20,000*	23,800	26,000*
COP Rated*			3.0		2.7	
EER Rated			11.9		10.2	
SEER			17.0		17.6	
HSPF*			8.2		8.4	
Piping Connections	Liquid	in. (mm)	Ø 3/8 (Ø 9.5)			
	Gas		Ø 5/8 (Ø 15.8)			
	Drain		Ø 1 (Ø 25.4)			
Max. Interunit Piping Length	ft. (m)		164(50)			
Max. Interunit Height Difference			98.4 (30)			
Chargeless	lbs (kg)		15 (4.5)			
Amount of Additional Charge of Refrigerant	lbs./ft. (kg/m)		0.036 (0.0536)			
Operating Range – Cooling	°F DB (°C DB)		23° – 122°F (-5 – 50°C)			
Cooling range with Optional Air Adjustment Grille	°F DB (°C DB)		0° - 122°F (-17.7° - 50°C)			
Operating Range – Heating*	°F WB (°C WB)		-4° – 60°F (-20 – 15.5°C)			
Indoor Unit			FAQ18TAVJU		FAQ18TAVJU	
Airflow Rate	H	cfm (m³/min)	500 (14.2)		635 (18)	
	M		400 (11.3)		470 (13.3)	
Fan Type			Cross flow fan			
Air Direction Control			N/A			
Air Filter			Resin net (Washable)			
Dimensions (H x W x D)	in. (mm)		11-3/8 x 41-3/8 x 9-1/4 (290 x 1050 x 238)			
Weight	lbs (kg)		31 (14)			
Sound Pressure Level (H / M / L / SL)	dB(A)		43 / 37		47 / 41	
Outdoor Unit			RZO18TAVJU / RZR18TAVJU		RZO24TAVJU / RZR24TAVJU	
Compressor	Motor Output	W	1,900			
Refrigerant	Type		R-410A			
	Charge	lbs (kg)	6.4 (2.9)			
Airflow Rate	H	cfm (m³/min)	2,682 (76)			
Dimensions (H x W x D)	in. (mm)		39 x 37 x 12-5/8 (990 x 940 x 320)			
Weight	lbs (kg)		172 (78)			
Sound Pressure Level	H	dB(A)	58	61*	58	61*

*Applicable to heat pump models only, refer to installation manual for more details.

Air Adjustment Grille	
KPW5E112	RZR18TAVJU, RZR24TAVJU, RZO18TAVJU, RZO24TAVJU

FBQ_PVJU RZR_TAVJU / RZQ_TAVJU DC Duct Concealed

COMFORTABLE LIMITED
WARRANTY* PROTECTION



* Complete warranty details available from your local dealer/contractor or at www.daikincomfort.com. Warranty registration not required to receive the 10-Year parts limited warranty for residential or commercial installations.

Sleek in design with comfort control features.

Premium Comfort Features

- » Medium external static pressure (ESP) capabilities offer up to 0.8 "W.G.
- » DC fan motor provides excellent efficiency
- » Three user selected fan speeds available plus fan "Auto" logic
- » Built-in condensate pump
- » Bottom access for easy service
- » Low profile design at less than 12" high
- » Optional wired controller
- » Connect to Daikin Zoning Kit (Optional)



- » Increases the flexibility of the *SkyAir* systems in both residential and commercial applications by adding a Zoning Box to an indoor unit fan coil
- » Allows several separate ducts to supply air to different individually-controlled zones.
- » The DZK BACnet™ Interface will work with any *BACnet*/IP compatible Building Management System



Wired*
Thermostat



Wireless*
Thermostat



Wireless Lite*
Thermostat

*for DZK Kit



RZR_TAVJU
RZQ_TAVJU



FBQ_PVJU



DZK Kit
(Option)



DKN Cloud
Wi-Fi adaptor
(option)



BRC1E73



BRC4C82
BRC082A43

FBQ_PVJU RZR_TAVJU / RZQ_TAVJU DC Duct Concealed

SKYAIR PRODUCTS

Model	Indoor Unit		FBQ18PVJU		FBQ24PVJU		FBQ30PVJU		FBQ36PVJU		FBQ42PVJU		FBQ48PVJU			
	Outdoor Unit (Cooling Only)		RZR18TAVJU		RZR24TAVJU		RZR30TAVJU		RZR36TAVJU		RZR42TAVJU		RZR48TAVJU			
	Outdoor Unit (Heat Pump)		RZQ18TAVJU		RZQ24TAVJU		RZQ30TAVJU		RZQ36TAVJU		RZQ42TAVJU		RZQ48TAVJU			
			Cooling	Heating*	Cooling	Heating*	Cooling	Heating*	Cooling	Heating*	Cooling	Heating*	Cooling	Heating*		
Capacity Rated			Btu/h		18,000	20,000*	24,000	27,000*	30,000	34,000*	36,000	40,000*	40,500	47,000*	48000	54000*
COP Rated*					3.5		3.2		3.4		3.6		3.5		3.1	
EER Rated					13		12		10.5		11.1		10.1		8.6	
SEER					16.7		16.5		16.0		17.5		16		14.0	
HSPF*					10.6		10.5		9.2		9.1		8.8		8.4	
Piping Connections	Liquid	in. (mm)	Ø 3/8 (Ø 9.5)													
	Gas		Ø 5/8 (Ø 15.8)													
	Drain		Ø 1 (Ø 25.4)													
Max. Interunit Piping Length		ft. (m)	164 (50)						230 (70)							
Max. Interunit Height Difference			98.4 (30)													
Chargeless			15 (4.5)													
Amount of Additional Charge of Refrigerant		lb/ft (kg/m)	0.036 (0.0535)													
Operating Range - Cooling		°F DB (°C DB)	23° - 122°F (-5 - 50°C)													
Cooling range with Optional Air Adjustment Grille		°F DB (°C DB)	0° - 122°F (-17.7° - 50°C)													
Operating Range - Heating*		°F WB (°C WB)	-4° - 60°F (-20 - 15.5°C)													
Indoor Unit			FBQ18PVJU		FBQ24PVJU		FBQ30PVJU		FBQ36PVJU		FBQ42PVJU		FBQ48PVJU			
External Static Pressure		In. Wg (Pa)	0.8 (200)													
Airflow Rate	H	cfm	635 (18)		688 (19.5)		1094 (31)		1130 (32)		1400 (39)		1400 (39)			
	M	(m³/min)	582 (16.5)		618 (17.5)		953 (27)		953 (27)		1165 (33)		1165 (33)			
	L		529 (15)		565 (16)		812 (23)		812 (23)		988 (28)		988 (28)			
Fan	Type		Sirocco Fan													
Air Direction Control			N/A													
Air Filter			N/A													
Dimensions (H x W x D)		in. (mm)	11-13/16 x 39-3/8 x 27-9/16 (300 x 1000 x 700)						11-13/16 x 55-1/8 x 27-9/16 (300 x 1400 x 700)							
Weight		Lbs (kg)	80 (36)						102 (46)							
Sound Pressure Level (H / M / L / SL)		dB(A)	41 / 39 / 37		42 / 40 / 38		43 / 41 / 39		43 / 41 / 39		44 / 42 / 40					
Outdoor Unit			RZR18TAVJU / RZQ18TAVJU		RZR24TAVJU / RZQ24TAVJU		RZR30TAVJU / RZQ30TAVJU		RZR36TAVJU / RZQ36TAVJU		RZR42TAVJU / RZQ42TAVJU		RZR48TAVJU / RZQ48TAVJU			
Compressor		Motor Output	W		1,900						3,500					
Refrigerant	Type		R-410A													
	Charge		Lbs (kg)		6.4 (2.9)						7.9 (3.6)					
Airflow Rate		H	cfm (m³/min)		2682 (76)						3,741 (106)					
Dimensions (H x W x D)		in. (mm)	39 x 37 x 12-5/8 (990 x 940 x 320)						52-15/16 x 35-7/16 x 12-5/8 (1345 x 900 x 320)							
Weight		Lbs (kg)	172 (78)						225 (102)							
Sound Pressure Level		H	58	61*	58	61*	57	59*	57	59*	57	59*	57	59*		

*Applicable to heat pump models only, refer to installation manual for more details.

Enthalpy economizer (field applied accessory)	
Model	Indoor Units
ECONMQ30P-8-1K (MERV 8 Filter)	FBQ18-30PVJU
ECONMQ30P-13-1K (MERV 13 Filter)	
ECONMQ48P-8-1K (MERV 8 Filter)	FBQ36-48PVJU
ECONMQ48P-13-1K (MERV 13 Filter)	

Air Adjustment Grille	
KPW5E112	RZR18TAVJU, RZR24TAVJU, RZQ18TAVJU, RZQ24TAVJU
KPW5E80 (X2)	RZR30TAVJU, RZR36TAVJU, RZR42TAVJU, RZR48TAVJU
	RZQ30TAVJU, RZQ36TAVJU, RZQ42TAVJU, RZQ48TAVJU

MERV 13 Filter Kit Option contains a MERV 13 filter, adaptor frame and easy to follow installation instructions and can be installed on the following models only:

Kit Model	Indoor Unit
DACA-FXMQ30131K	FBQ18-30PVJU
DACA-FXMQ48131K	FBQ36-48PVJU

FCQ_TAVJU
RZR_TAVJU / RZQ_TAVJU
Round Flow Sensing Cassette

COMFORTABLE LIMITED
 WARRANTY* PROTECTION



* Complete warranty details available from your local dealer/contractor or at www.daikincomfort.com. Warranty registration not required to receive the 10-Year parts limited warranty for residential or commercial installations.

Customizable comfort ideal for open plan applications.

Premium Comfort Features

- » 18 configurable airflow patterns ensure ideal air distribution for maximized comfort and savings
- » 360° airflow and three room sensors enables optimized occupant comfort and efficiency
- » Lower air velocities provide better airflow distribution
- » Optional self-cleaning filter panel to automatically clean filters on a set schedule.
- » Condensate pump provided as standard
- » Outside air integration possible

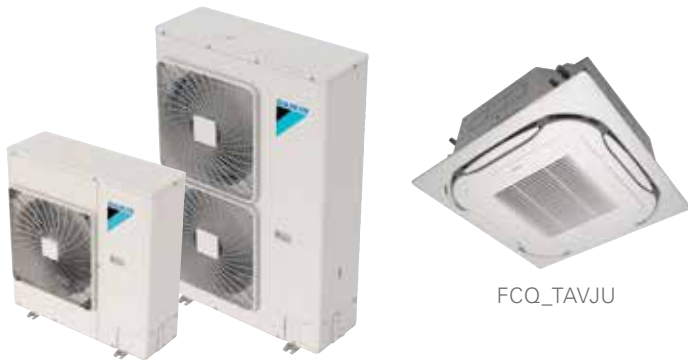

RZQ_TAVJU
 RZR_TAVJU

FCQ_TAVJU



Self-Cleaning Air Filter Panel

FCQ_TAVJU RZR_TAVJU / RZQ_TAVJU Round Flow Sensing Cassette

SKYAIR PRODUCTS

Model	Indoor Unit		FCQ18TAVJU		FCQ24TAVJU		FCQ30TAVJU		FCQ36TAVJU		FCQ42TAVJU		FCQ48TAVJU	
	Outdoor Unit (Cooling Only)		RZR18TAVJU		RZR24TAVJU		RZR30TAVJU		RZR36TAVJU		RZR42TAVJU		RZR48TAVJU	
	Outdoor Unit (Heat Pump)		RZQ18TAVJU		RZQ24TAVJU		RZQ30TAVJU		RZQ36TAVJU		RZQ42TAVJU		RZQ48TAVJU	
			Cooling	Heating*	Cooling	Heating*	Cooling	Heating*	Cooling	Heating*	Cooling	Heating*	Cooling	Heating*
Capacity Rated	Btu/h		18,000	20,000	23,800	27,000	30,000	33,800	36,000	40,000	41,500	47,000	48,000	54,000
COP Rated*			4.2		3.8		4.5		4.3		4.0		3.7	
EER Rated			13		12		9.3		11.4		10.3		9	
SEER			18.6		18.5		17.2		17.6		17		17	
HSPF*			10.1		10.2		10.2		9		8.6		9.3	
Piping Connections	Liquid	in. (mm)	Ø 3/8 (Ø 9.5)											
	Gas		Ø 5/8 (Ø 15.8)											
	Drain		Ø 1 (Ø 25.4)											
Max. Interunit Piping Length	ft. (m)		164 (50)				230 (70)							
Max. Interunit Height Difference			98.4 (30)											
Chargeless	Lbs (kg)		15 (4.5)											
Amount of Additional Charge of Refrigerant	lb/ft (kg/m)		0.036 (0.0535)											
Operating Range - Cooling	°F DB (°C DB)		23° - 122°F (-5 - 50°C)											
Cooling range with Optional Air Adjustment Grille	°F DB (°C DB)		0° - 122°F (-17.7° - 50°C)											
Operating Range - Heating*	°F WB (°C WB)		-4° - 60°F (-20 - 15.5°C)											
Indoor Unit			FCQ18TAVJU		FCQ24TAVJU		FCQ30TAVJU		FCQ36TAVJU		FCQ42TAVJU		FCQ48TAVJU	
Airflow Rate	H	cfm (m³/min)	742 (21.0)		777 (22.0)		1112 (31.5)		1165 (33.0)		1218 (34.5)		1218 (34.5)	
	M		618 (17.5)		618 (17.5)		918 (26.0)		918 (26.0)		971 (27.5)		971 (27.5)	
	L		477 (13.5)		477 (13.5)		671 (19.0)		671 (19.0)		742 (21.0)		742 (21.0)	
Fan Type			Turbo Fan											
Air Direction Control			N/A											
Air Filter			N/A											
Dimensions (H x W x D)	in. (mm)		10-1/16 x 33-1/16 x 33-1/16 (256 x 840 x 840)				11-23/32 x 33-1/16 x 33-1/16 (298 x 840 x 840)							
Weight	Lbs (kg)		63 (28.5)				70 (31.5)							
Sound Pressure Level (H / M / L / SL)	dB(A)		35.5 / 32 / 28		36 / 32 / 28		43.5 / 38 / 32		44 / 38 / 32		45 / 40 / 35			
Outdoor Unit			RZR18TAVJU / RZQ18TAVJU		RZR24TAVJU / RZQ24TAVJU		RZR30TAVJU / RZQ30TAVJU		RZR36TAVJU / RZQ36TAVJU		RZR42TAVJU / RZQ42TAVJU		RZR48TAVJU / RZQ48TAVJU	
Compressor	Motor Output	W	1,900				3,500							
Refrigerant	Type		R-410A											
	Charge	Lbs (kg)	6.4 (2.9)				7.9 (3.6)							
Airflow Rate	H	cfm (m³/min)	2682 (76)				3,741 (106)							
Dimensions (H x W x D)	in. (mm)		39 x 37 x 12-5/8 (990 x 940 x 320)				52-15/16 x 35-7/16 x 12-5/8 (1345 x 900 x 320)							
Weight	Lbs (kg)		172 (78)				225 (102)							
Sound Pressure Level	H	dB(A)	58	61*	58	61*	57	59*	57	59*	57	59*	57	59*

*Applicable to heat pump models only, refer to installation manual for more details.

Air Adjustment Grille	
KPW5E112	RZR18TAVJU, RZR24TAVJU, RZQ18TAVJU, RZQ24TAVJU
KPW5E80 (X2)	RZQ30TAVJU, RZQ36TAVJU, RZQ42TAVJU, RZQ48TAVJU, RZR30TAVJU, RZR36TAVJU, RZR42TAVJU, RZR48TAVJU

OPTION		FCQ18-48TAVJU	
Type of panel		Self-Cleaning Filter Panel	Standard Sensing Decoration Panel
Self-Cleaning Filter Panel		BYCQ125BGW1	-
Connection pipe (for dust recovery)		KKHAP55B160	-
L-shape extension pipe		KKHAP55A160	-
Standard Sensing Decoration Panel		-	BYCQ125B-W1
Sealing material for air discharge outlet		KDBH55K160F	KDBHQ55B140
Panel spacer		KDBP55H160FA	KDBP55H160FA
Fresh air intake kit	Chamber type	Without T shape pipe	KDDQ55B140
		With T shape pipe	KDDP55B160K
Replacement long life filter		-	KAFP55B160
Self-Cleaning Filter Panel replacement filter		KAFP55A160	-
MERV 13 Filter Kit		-	DACA-FQP13-1K

FHQ_PVJU RZR_TAVJU / RZO_TAVJU Ceiling Suspended

COMFORTABLE LIMITED
WARRANTY* PROTECTION



* Complete warranty details available from your local dealer/contractor or at www.daikincomfort.com. Warranty registration not required to receive the 10-Year parts limited warranty for residential or commercial installations.

A slim solution for open or structured ceilings.

Premium Comfort Features

- » Slim in height at less than 8"
- » Auto-swing capability with 100° airflow pattern distributes comfortable airflow
- » Innovative stream fan technology keeps sound pressure levels low
- » Lateral servicing space allows installation in corners, narrow spaces, walls, and ceilings
- » Flat panel design makes cleaning simple
- » Concealed piping
- » Optional wired controller
- » Optional condensate pump



RZO_TAVJU
RZR_TAVJU



FHQ_PVJU
FHQ_MVJU



DKN Cloud
Wi-Fi adaptor
(option)



BRC1E73



BRC7E83



BRC2A71

FHQ_PVJU RZR_TAVJU / RZO_TAVJU Ceiling Suspended

SKYAIR PRODUCTS

Model	Indoor Unit		FHQ18PVJU		FHQ24PVJU		FHQ30PVJU		FHQ36MVJU		FHQ42MVJU	
	Outdoor Unit (Cooling Only)		RZR18TAVJU		RZR24TAVJU		RZR30TAVJU		RZR36TAVJU		RZR42TAVJU	
	Outdoor Unit (Heat Pump)		RZO18TAVJU		RZO24TAVJU		RZO30TAVJU		RZO36TAVJU		RZO42TAVJU	
			Cooling	Heating*	Cooling	Heating*	Cooling	Heating*	Cooling	Heating*	Cooling	Heating*
Capacity Rated	Btu/h		18,000	20,000	24,000	27,000	30,000	34,000	36,000	40,000	40,500	40,000
COP Rated*			3.9		3.5		3.1		2.8		2.8	
EER Rated			12.9		11.3		10.5		9.5		8.8	
SEER			16.3		16.6		16		14		14	
HSPF*			9.1		9.3		8.4		8.2		8.2	
Piping Connections	Liquid	in. (mm)	Ø 3/8 (Ø 9.5)									
	Gas		Ø 5/8 (Ø 15.8)									
	Drain		Ø 1 (Ø 25.4)									
Max. Interunit Piping Length			164 (50)						230 (70)			
Max. Interunit Height Difference	ft. (m)		98.4 (30)									
Chargeless			15 (4.5)									
Amount of Additional Charge of Refrigerant	lb/ft (kg/m)		0.036 (0.0535)									
Operating Range - Cooling	°F DB (°C DB)		23° - 115°F (-5 - 50°C)									
Cooling range with Optional Air Adjustment Grille	°F DB (°C DB)		0° - 122°F (-17.7° - 50°C)									
Operating Range - Heating*	°F WB (°C WB)		-4° - 60°F (-20 - 15.5°C)									
Indoor Unit			FHQ18PVJU		FHQ24PVJU		FHQ30PVJU		FHQ36MVJU		FHQ42MVJU	
Airflow Rate	H	cfm (m³/min)	790 (22.4)		790 (22.4)		790 (22.4)		830 (23.5)		850 (24.1)	
	M		N/A		N/A		N/A		N/A		N/A	
	L		670 (19)		670 (19)		670 (19)		670 (19)		700 (19.8)	
Fan	Type		Sirocco Fan									
Air Direction Control			N/A									
Air Filter			N/A									
Dimensions (H x W x D)	in. (mm)		7-11/16 x 62-5/8 x 26-3/4 (195 x 1590 x 679)									
Weight	Lbs (kg)		90 (41)									
Sound Pressure Level (H / M / L / SL)	dB(A)		N/A									
Outdoor Unit			RZR18TAVJU / RZO18TAVJU		RZR24TAVJU / RZO24TAVJU		RZR30TAVJU / RZO30TAVJU		RZR36TAVJU / RZO36TAVJU		RZR42TAVJU / RZO42TAVJU	
Compressor	Motor Output	W	1,900				3,500					
Refrigerant	Type		R-410A									
	Charge	Lbs (kg)	6.4 (2.9)				7.9 (3.6)					
Airflow Rate	H	cfm (m³/min)	2682 (76)				3,741 (106)					
Dimensions (H x W x D)	in. (mm)		39 x 37 x 12-5/8 (990 x 940 x 320)				52-15/16 x 35-7/16 x 12-5/8 (1345 x 900 x 320)					
Weight	Lbs (kg)		172 (78)				225 (102)					
Sound Pressure Level	H	dB(A)	58	61*	58	61*	57	59*	57	59*	57	59*

*Applicable to heat pump models only, refer to installation manual for more details.

Air Adjustment Grille	
KPW5E112	RZR18TAVJU, RZR24TAVJU, RZO18TAVJU, RZO24TAVJU
KPW5E80 (X2)	RZO30TAVJU, RZO36TAVJU, RZO42TAVJU, RZR30TAVJU, RZR36TAVJU, RZR42TAVJU

FTQ_TAVJUD/A RZQ_TAVJU / RZQ_TAVJU

Multi-Position Air Handling Unit

COMFORTABLE LIMITED
WARRANTY* PROTECTION



* Complete warranty details available from your local dealer/contractor or at www.daikincomfort.com. Warranty registration not required to receive the 10-Year parts limited warranty for residential or commercial installations.

An intelligent alternative to traditional unitary systems.

Standard Features

- » Upflow downflow, horizontal left or horizontal right configurations for the indoor unit
- » Designed for zero clearance on three sides and only 24" clearance on the front for service.
- » 100% heating capacity at -4F on systems up to 3 tons, without electrical heat
- » Field-installed electric heater options available from 3 kW to 19 kW
- » Factory installed disconnect switch



FTQ_TAVJUD/A RZQ_TAVJU / RZQ_TAVJU

Multi-Position Air Handling Unit

SKYAIR PRODUCTS

Model	Indoor Unit		FTQ18TAVJUD		FTQ24TAVJUD		FTQ30TAVJUD		FTQ36TAVJUD		FTQ42TAVJUD		FTQ48TAVJUD	
	Indoor Unit (Without Factory Disconnect)		FTQ18TAVJUA		FTQ24TAVJUA		FTQ30TAVJUA		FTQ36TAVJUA		FTQ42TAVJUA		FTQ48TAVJUA	
	Outdoor Unit (Cooling Only)		RZR18TAVJU		RZR24TAVJU		RZR30TAVJU		RZR36TAVJU		RZR42TAVJU		RZR48TAVJU	
	Outdoor Unit (Heat Pump)		RZQ18TAVJU		RZQ24TAVJU		RZQ30TAVJU		RZQ36TAVJU		RZQ42TAVJU		RZQ48TAVJU	
Capacity Rated			Cooling	Heating*	Cooling	Heating*	Cooling	Heating*	Cooling	Heating*	Cooling	Heating*	Cooling	Heating*
Btu/h			18,000	20,000	24,000	27,000	30,000	34,000	36,000	40,000	42,000	47,000	48,000	54,000
COP Rated*			3.5		3.3		3.7		3.4		3.6		3.4	
EER Rated			12.5		10.3		12.5		11.3		11		9.5	
SEER			15.5		15.2		16		15.3		16		14.8	
HSPF*			8.6		9.4		10.4		9.5		9		9	
Piping Connections	Liquid	in. (mm)	Ø 3/8 (Ø 9.5)											
	Gas		Ø 5/8 (Ø 15.8)											
	Drain		Ø 1 (Ø 25.4)											
Max. Interunit Piping Length		ft. (m)	164 (50)						230 (70)					
Max. Interunit Height Difference			98.4 (30)											
Chargeless			15 (4.5)											
FTQ Additional Charge†		lbs	0.1						0.71			1.05		
Amount of Additional Charge of Refrigerant		lb/ft (kg/m)	0.036 (0.0536)											
Operating Range - Cooling		°F DB (°C DB)	23° - 122°F (-5 - 50°C)											
Cooling range with Optional Air Adjustment Grille		°F DB (°C DB)	0° - 122°F (-17.7° - 50°C)											
Operating Range - Heating*		°F WB (°C WB)	-4° - 60°F (-20 - 15.5°C)											
Indoor Unit			FTQ18TAVJUD / FTQ18TAVJUA		FTQ24TAVJUD / FTQ24TAVJUA		FTQ30TAVJUD / FTQ30TAVJUA		FTQ36TAVJUD / FTQ36TAVJUA		FTQ42TAVJUD / FTQ42TAVJUA		FTQ48TAVJUD / FTQ48TAVJUA	
External Static Pressure		In. wg (Pa)	0.9 (224)											
Airflow Rate	H	cfm (m³/min)	600 (17.0)		800 (22.7)		1000 (28.3)		1050 (29.7)		1400 (39.6)		1520 (43.1)	
	M		510 (14.4)		680 (19.3)		850 (24.1)		900 (25.5)		1190 (32.7)		1290 (36.5)	
	L		420 (11.9)		560 (15.9)		700 (19.8)		750 (21.2)		980 (27.8)		1060 (30)	
Fan		Type	Sirocco Fan											
Air Direction Control			N/A											
Air Filter			N/A											
Dimensions (H x W x D)		in. (mm)	45 x 17.5 x 21 (1143 x 445 x 533)						53.4 x 21 x 21 (1357 x 533 x 533)					
Weight		Lbs (kg)	115 (52.2)						140 (63.5)			150 (68)		
Sound Pressure Level (H / M / L / SL)		dB(A)	53 / 50 / 47		45 / 41 / 38		52 / 48 / 44		52 / 48 / 44		54 / 50 / 46		54 / 50 / 46	
Outdoor Unit			RZR18TAVJU / RZQ18TAVJU		RZR24TAVJU / RZQ24TAVJU		RZR30TAVJU / RZQ30TAVJU		RZR36TAVJU / RZQ36TAVJU		RZR42TAVJU / RZQ42TAVJU		RZR48TAVJU / RZQ48TAVJU	
Compressor		Motor Output	1,900						3,500					
Refrigerant		Type	R-410A											
		Charge	6.4 (2.9)						7.9 (3.6)					
Airflow Rate		H	2,682 (76)						3,741 (106)					
Dimensions (H x W x D)		in. (mm)	39 x 37 x 12-5/8 (990 x 940 x 320)						52-15/16 x 35-7/16 x 12-5/8 (1345 x 900 x 320)					
Weight		Lbs (kg)	172 (78)						225 (102)					
Sound Pressure Level		H	58	61*	58	61*	57	59*	57	59*	57	59*	57	59*

*Applicable to heat pump models only, refer to installation manual for more details.
† Additional charge needed regardless of piping length. Refer to installation manual.

Air Adjustment Grille	
KPW5E112	RZQ18TAVJU, RZQ24TAVJU, RZR18TAVJU, RZR24TAVJU
KPW5E80 (X2)	RZQ30TAVJU, RZQ36TAVJU, RZQ42TAVJU, RZQ48TAVJU, RZR30TAVJU, RZR36TAVJU, RZR42TAVJU, RZR48TAVJU

Electric Heater Options							
Model Name	3kW	5kW	6kW	8kW	10kW	15kW*	19kW*
FTQ18TAVJUD(A)	●	●	●	●	●		
FTQ24TAVJUD(A)	●	●	●	●	●		
FTQ30TAVJUD(A)	●	●	●	●	●		
FTQ36TAVJUD(A)	●	●	●	●	●		
FTQ42TAVJUD(A)		●	●	●	●	●	●
FTQ48TAVJUD(A)		●	●	●	●	●	●

* Two-stage heater control

All combinations of indoor unit capacity & heater capacity may be configured as either Auxiliary Heat or Heat Pump Lockout Heat. Refer to the installation manual for more details.

PROTECT THEIR INVESTMENT FOR YEARS TO COME.
ASURESM EXTENDED SERVICE PLAN



Daikin brand equipment is optimized to provide premium comfort through the latest innovations. However, any mechanical product occasionally fails. As an authorized Asure dealer, you can offer your customer extended service agreements as a safeguard from those occasional failures.

The Asure program provides your business with the following benefits:

- » Adds value to homeowner's purchase. Provides the homeowner peace-of-mind that they have protected their investment and guaranteed their comfort system for the terms of their agreement against unplanned repair bills.
- » Builds your customer base. By providing your customer with worry-free comfort, you earn your customer's loyalty and confidence, along with that of their friends and neighbors. What better way is there to grow your business?

What is covered?

Asure provides coverage on all functional parts of Daikin brand 3/4-through-5 ton, single-phase ductless HVAC products. Coverage may be offered on equipment that has been installed within the last year. Routine maintenance and the cost to correct failures other than those considered to be manufacturing defects are excluded from coverage. For more information, please visit www.daikincomfort.com.

About Daikin:

DAIKIN



Daikin Industries, Ltd. (DIL) is a global Fortune 1000 company which celebrated its 95th anniversary in May 2019. The company is recognized as one of the largest HVAC (Heating, Ventilation, Air Conditioning) manufacturers in the world. DIL is primarily engaged in developing indoor comfort systems and refrigeration products for residential, commercial and industrial applications. Its consistent success is derived, in part, from a focus on innovative, energy-efficient and premium quality indoor climate and comfort management solutions.



Proper sizing and installation of equipment is critical to achieve optimal performance. Split system air conditioners and heat pumps must be matched with appropriate coil components to meet **ENERGY STAR®** criteria. Ask your contractor for details or visit www.energystar.gov.

Additional Information

Before purchasing this appliance, read important information about its estimated annual energy consumption, yearly operating cost, or energy efficiency rating that is available from your retailer.

DAIKIN



Our continuing commitment to quality products may mean a change in specifications without notice.

© 2019 **DAIKIN NORTH AMERICA LLC** · Houston, Texas · USA · www.daikincomfort.com or www.daikinac.com

CT-ZONE 09-19