



Z-LINE® SERIES

SB, ZL & HV

FEATURES

The Glasfloss Z-Line Series pleated filters offer improved performance for virtually every application. All Glasfloss Z-Line pleated filters feature electrostatically charged, 100% synthetic media for high initial and sustained efficiency over the life of the filter. The fibers do not absorb moisture and will not support microbial growth. The Glasfloss Z-Line Series achieves a MERV 7 per ASHRAE 52.2 Test Standard with no increase in initial pressure drop.

The Z-Line Series pleated filter products include:

- "SB" - our most economically priced pleated filter.
- "ZL" - offers excellent performance and value for a wide range of applications.
- "HV" - ideal in high velocity systems where maximum square footage of media is necessary.

CONSTRUCTION

Glasfloss Z-Line Series pleated filters incorporate thermally bonded, electrostatically charged, 100% synthetic fibers to ensure efficiency and high dust holding capacity. The media is laminated to a galvanized metal that stabilizes the media during operation. The pleats are formed in a radial configuration to ensure proper dust loading. The standard pleated cartridge is bonded into a two-piece, heavy-duty, beverage board die cut frame that creates a double-wall thickness around the filter and prevents air bypass. The die cut grilles are internally bonded to the pleat apexes on the air entering and air leaving sides to ensure maximum integrity and support during the life of the filter.

APPLICATIONS

Glasfloss Z-Line Series pleated filters are used in a broad range of installations, from pre-filters to primary filters for computer room units. Whether used as primary filters or as pre-filters in multi-stage systems, Glasfloss Z-Line Series pleated filters offer a solution for virtually every commercial, industrial and residential HVAC application.

Special construction and higher efficiency models are also available for special applications.

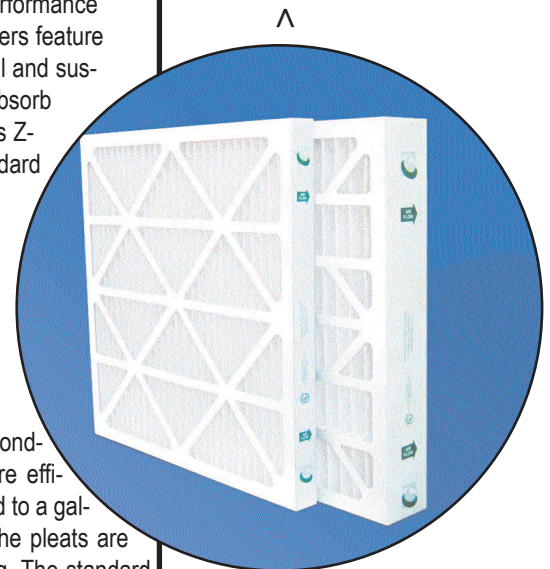

- MERV 7
- Electrostatically Charged, 100% Synthetic Media
- Heavy-duty, Moisture Resistant Construction
- Galvanized Expanded Metal Backing
- Standard Size 4" and 6" HV Incorporates Media Separators

SPECIFICATIONS

Glasfloss Z-Line Series SB, ZL and HV air filters shall be of the extended surface pleated media type. The media utilized shall be made of 100% synthetic fibers. The media shall be pleated in a tapered radial configuration. An expanded metal reinforcement shall be laminated to the air leaving side of the media by a thermosetting adhesive to maintain continuity of the radial pleats. The expanded metal shall be galvanized to resist rust and corrosion. The pleated cartridge shall be bonded to the peripheral interior of the outer frame. A heavy-duty, moisture resistant beverage board shall be utilized for an encasing frame. The frame face shall be internally laminated to the pleated cartridge apexes. Glasfloss Z-Line Series SB, ZL and HV filters shall be rated to withstand temperatures up to 180 degrees Fahrenheit. Glasfloss Z-Line Series SB, ZL and HV filters shall be rated Class 2 under U.L. std. 900. Glasfloss Z-Line Series SB, ZL and HV shall have an average efficiency of 25-30% when tested in accordance with the ASHRAE 52.1 Test Standard. Glasfloss Z-Line Series SB, ZL and HV shall be rated a MERV 7 when tested in accordance with the ASHRAE 52.2 Test Standard.

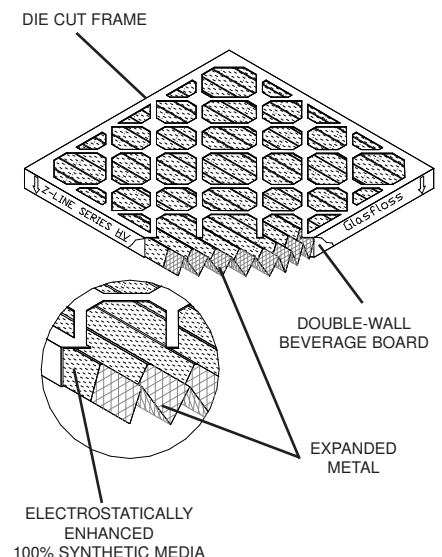

"Serving You With Locations Throughout The Nation"

Glasfloss has a policy of uninterrupted research, development and product improvement and reserves the right to change design and specifications without notice.

Z-LINE® SERIES

SB, ZL & HV

SB, ZL & HV STANDARD SIZE FILTERS

SIZE W x H x D NOMINAL	SIZE W x H x D EXACT	RATED VELOCITY FPM	INITIAL RESIST. IN. W.G.			MEDIA SQUARE FEET			SIZE W x H x D NOMINAL MM	RATED VELOCITY M/H	INITIAL RESIST. PASCALS		
			SB	ZL	HV	SB	ZL	HV			SB	ZL	HV
10 x 10 x 1	9-1/2 x 9-1/2 x 7/8	300	.20	.17	.15	1.24	1.48	1.61	254 x 254 x 26	5490	49.8	42.3	39.8
10 x 20 x 1	9-1/2 x 19-1/2 x 7/8	300	.20	.17	.15	2.06	2.47	2.67	254 x 508 x 26	5490	49.8	42.3	39.8
10 x 24 x 1	9-1/2 x 23-1/2 x 7/8	300	.20	.17	.15	2.47	2.97	3.22	254 x 610 x 26	5490	49.8	42.3	39.8
10 x 30 x 1	9-5/8 x 29-5/8 x 7/8	300	.20	.17	.15	3.71	4.33	4.95	254 x 762 x 26	5490	49.8	42.3	39.8
12 x 12 x 1	11-1/2 x 11 1/2 x 7/8	300	.20	.17	.15	1.55	1.80	2.06	305 x 305 x 26	5490	49.8	42.3	39.8
12 x 20 x 1	11-1/2 x 19-1/2 x 7/8	300	.20	.17	.15	2.47	2.88	3.29	305 x 508 x 26	5490	49.8	42.3	39.8
12 x 24 x 1	11-3/8 x 23-3/8 x 7/8	300	.20	.17	.15	2.97	3.46	3.96	305 x 610 x 26	5490	49.8	42.3	39.8
12 x 30 x 1	11-5/8 x 29-1/2 x 7/8	300	.20	.17	.15	3.88	4.51	5.16	305 x 762 x 26	5490	49.8	42.3	39.8
14 x 14 x 1	13-1/2 x 13-1/2 x 7/8	300	.20	.17	.15	2.29	2.62	3.12	356 x 356 x 26	5490	49.8	42.3	39.8
14 x 20 x 1	13-1/2 x 19-1/2 x 7/8	300	.20	.17	.15	2.88	3.29	3.91	356 x 508 x 26	5490	49.8	42.3	39.8
14 x 24 x 1	13 1/2 x 23 1/2 x 7/8	300	.20	.17	.15	3.46	3.96	4.70	356 x 610 x 26	5490	49.8	42.3	39.8
14 x 25 x 1	13-1/2 x 24-1/2 x 7/8	300	.20	.17	.15	3.61	4.13	4.90	356 x 635 x 26	5490	49.8	42.3	39.8
14 x 30 x 1	13 5/8 x 29 5/8 x 7/8	300	.20	.17	.15	4.92	5.74	6.56	356 x 762 x 26	5490	49.8	42.3	39.8
15 x 20 x 1	14-1/2 x 19-1/2 x 7/8	300	.20	.17	.15	3.09	3.70	4.11	381 x 508 x 26	5490	49.8	42.3	39.8
15 x 30 5/8 x 1	14-5/8 x 30-1/4 x 7/8	300	.20	.17	.15	5.09	9.28	10.57	381 x 777 x 26	5490	49.8	42.3	39.8
16 x 16 x 1	15-1/2 x 15-1/2 x 7/8	300	.20	.17	.15	2.63	3.12	3.45	406 x 406 x 26	5490	49.8	42.3	39.8
16 x 20 x 1	15-1/2 x 19-1/2 x 7/8	300	.20	.17	.15	3.29	3.91	4.32	406 x 508 x 26	5490	49.8	42.3	39.8
16 x 24 x 1	15-1/2 x 23-1/2 x 7/8	300	.20	.17	.15	3.96	4.70	5.20	406 x 610 x 26	5490	49.8	42.3	39.8
16 x 25 x 1	15-1/2 x 24-1/2 x 7/8	300	.20	.17	.15	4.13	4.90	5.41	406 x 635 x 26	5490	49.8	42.3	39.8
16 x 30 x 1	15-5/8 x 29-5/8 x 7/8	300	.20	.17	.15	5.00	5.83	6.67	406 x 762 x 26	5490	49.8	42.3	39.8
18 x 18 x 1	17-1/2 x 17-1/2 x 7/8	300	.20	.17	.15	3.70	4.32	4.94	457 x 457 x 26	5490	49.8	42.3	39.8
18 x 20 x 1	17-1/2 x 19-1/2 x 7/8	300	.20	.17	.15	3.70	4.32	4.94	457 x 508 x 26	5490	49.8	42.3	39.8
18 x 24 x 1	17-1/2 x 23-1/2 x 7/8	300	.20	.17	.15	4.45	5.20	5.94	457 x 610 x 26	5490	49.8	42.3	39.8
18 x 25 x 1	17-1/2 x 24-1/2 x 7/8	300	.20	.17	.15	4.64	5.41	6.19	457 x 635 x 26	5490	49.8	42.3	39.8
18 x 30 x 1	17-5/8 x 29-5/8 x 7/8	300	.20	.17	.15	6.17	7.20	8.23	457 x 762 x 26	5490	49.8	42.3	39.8
20 x 20 x 1	19-1/2 x 19-1/2 x 7/8	300	.20	.17	.15	4.11	4.73	5.55	508 x 508 x 26	5490	49.8	42.3	39.8
20 x 22 x 1	19-1/2 x 21-7/8 x 7/8	300	.20	.17	.15	4.56	5.24	6.15	508 x 558 x 26	5490	49.8	42.3	39.8
20 x 24 x 1	19-3/8 x 23-3/8 x 7/8	300	.20	.17	.15	4.95	5.69	6.68	508 x 610 x 26	5490	49.8	42.3	39.8
20 x 25 x 1	19-1/2 x 24-1/2 x 7/8	300	.20	.17	.15	5.16	5.93	6.96	508 x 635 x 26	5490	49.8	42.3	39.8
20 x 30 x 1	19-5/8 x 29-5/8 x 7/8	300	.20	.17	.15	6.17	7.20	8.23	508 x 762 x 26	5490	49.8	42.3	39.8
22 x 22 x 1	21-1/2 x 21-1/2 x 7/8	300	.20	.17	.15	5.44	6.43	7.17	558 x 558 x 26	5490	49.8	42.3	39.8
24 x 24 x 1	23-3/8 x 23-3/8 x 7/8	300	.20	.17	.15	5.94	6.93	7.92	610 x 610 x 26	5490	49.8	42.3	39.8
24 x 30 x 1	23-5/8 x 29-5/8 x 7/8	300	.20	.17	.15	7.42	8.66	9.90	610 x 762 x 26	5490	49.8	42.3	39.8
25 x 25 x 1	24-1/2 x 24-1/2 x 7/8	300	.20	.17	.15	6.45	7.48	8.51	635 x 635 x 26	5490	49.8	42.3	39.8
10 x 20 x 2	9-1/2 x 19-1/2 x 1-3/4	500	.29	.26	.24	3.36	3.84	6.24	254 x 508 x 51	9150	72.3	69.6	54.7
12 x 12 x 2	11-1/2 x 11-1/2 x 1-3/4	500	.29	.26	.24	2.31	2.89	4.33	305 x 305 x 51	9150	72.3	69.6	54.7
12 x 20 x 2	11-1/2 x 19-1/2 x 1-3/4	500	.29	.26	.24	3.84	4.80	7.20	305 x 508 x 51	9150	72.3	69.6	54.7
12 x 24 x 2	11-3/8 x 23-3/8 x 1-3/4	500	.29	.26	.24	4.62	5.77	8.66	305 x 610 x 51	9150	72.3	69.6	54.7
14 x 20 x 2	13-1/2 x 19-1/2 x 1-3/4	500	.29	.26	.24	4.32	5.76	8.64	356 x 508 x 51	9150	72.3	69.6	54.7
14 x 25 x 2	13-1/2 x 24-1/2 x 1-3/4	500	.29	.26	.24	5.41	7.22	10.83	356 x 635 x 51	9150	72.3	69.6	54.7
15 x 20 x 2	14-1/2 x 19-1/2 x 1-3/4	500	.29	.26	.24	4.80	6.24	9.12	381 x 508 x 51	9150	72.3	69.6	54.7
16 x 16 x 2	15-3/4 x 15-3/4 x 1-3/4	500	.29	.26	.24	4.21	4.98	7.66	406 x 406 x 51	9150	72.3	69.6	54.7
16 x 20 x 2	15-1/2 x 19-1/2 x 1-3/4	500	.29	.26	.24	5.28	6.24	9.60	406 x 508 x 51	9150	72.3	69.6	54.7
16 x 24 x 2	15-1/2 x 23-1/2 x 1-3/4	500	.29	.26	.24	6.35	7.50	11.55	406 x 610 x 51	9150	72.3	69.6	54.7
16 x 25 x 2	15-1/2 x 24-1/2 x 1-3/4	500	.29	.26	.24	6.62	7.82	12.03	406 x 635 x 51	9150	72.3	69.6	54.7
18 x 18 x 2	17-1/2 x 17-1/2 x 1-3/4	500	.29	.26	.24	5.76	7.20	11.04	457 x 457 x 51	9150	72.3	69.6	54.7
18 x 20 x 2	17-1/2 x 19-1/2 x 1-3/4	500	.29	.26	.24	5.76	7.20	11.04	457 x 508 x 51	9150	72.3	69.6	54.7
18 x 24 x 2	17-1/2 x 23-1/2 x 1-3/4	500	.29	.26	.24	6.93	8.66	13.28	457 x 610 x 51	9150	72.3	69.6	54.7
18 x 25 x 2	17-1/2 x 24-1/2 x 1-3/4	500	.29	.26	.24	7.22	9.02	13.84	457 x 635 x 51	9150	72.3	69.6	54.7
20 x 20 x 2	19-1/2 x 19-1/2 x 1-3/4	500	.29	.26	.24	6.24	8.16	12.00	508 x 508 x 51	9150	72.3	69.6	54.7
20 x 24 x 2	19-3/8 x 23-3/8 x 1-3/4	500	.29	.26	.24	7.50	9.81	14.43	508 x 610 x 51	9150	72.3	69.6	54.7
20 x 25 x 2	19-1/2 x 24-1/2 x 1-3/4	500	.29	.26	.24	7.82	10.23	15.04	508 x 635 x 51	9150	72.3	69.6	54.7
20 x 30 x 2	19-5/8 x 29-5/8 x 1-3/4	500	.29	.26	.24	9.60	12.00	18.24	508 x 762 x 51	9150	72.3	69.6	54.7
24 x 24 x 2	23-3/8 x 23-3/8 x 1-3/4	500	.29	.26	.24	9.24	11.55	17.61	610 x 610 x 51	9150	72.3	69.6	54.7
25 x 25 x 2	24-1/2 x 24-1/2 x 1-3/4	500	.29	.26	.24	10.23	12.63	18.65	635 x 635 x 51	9150	72.3	69.6	54.7

Tolerances shall be +/- 1/8" for height, width and +/- 1/16" for depth. Recommended final resistance is 1.00" w.g. All special sizes will be undersized by 1/8" unless specified otherwise.

Pleats Per Lineal Foot

DEPTH	"SB"	"ZL"	"HV"
1"	12	14	16
2"	8	10	15
4"	7	9	11
6"	NA	9	11

Media Area to Face Area Ratio

DEPTH	"SB"	"ZL"	"HV"
1"	1.48	1.73	1.97
2"	2.30	2.88	4.40
4"	4.38	5.56	6.80
6"	NA	8.53	10.43

SIZE W x H x D NOMINAL	SIZE W x H x D EXACT	RATED VELOCITY FPM	INITIAL RESIST. IN. W.G.			MEDIA SQUARE FEET			SIZE W x H x D NOMINAL MM	RATED VELOCITY M/H	INITIAL RESIST. PASCALS		
			SB	ZL	HV	SB	ZL	HV			SB	ZL	HV
12 x 24 x 4	11-3/8 x 23-3/8 x 3-3/4	500	.29	.22	.20	8.66	11.13	13.61	457 x 610 x 102	9150	59.7	54.7	49.8
16 x 20 x 4	15-1/2 x 19-1/2 x 3-3/4	500	.29	.22	.20	9.26	12.34	15.43	406 x 508 x 102	9150	59.7	54.7	49.8
16 x 25 x 4	15-1/2 x 24-1/2 x 3-3/4	500	.29	.22	.20	11.60	15.47	19.34	406 x 635 x 102	9150	59.7	54.7	49.8
18 x 24 x 4	17-1/2 x 23-1/2 x 3-3/4	500	.29	.22	.20	13.61	17.32	21.03	457 x 610 x 102	9150	59.7	54.7	49.8
20 x 20 x 4	19-1/2 x 19-1/2 x 3-3/4	500	.29	.22	.20	12.34	15.43	18.52	508 x 508 x 102	9150	59.7	54.7	49.8
20 x 24 x 4	19-3/8 x 23-3/8 x 3-3/4	500	.29	.22	.20	14.84	18.55	22.27	508 x 610 x 102	9150	59.7	54.7	49.8
20 x 25 x 4	19-1/2 x 24-1/2 x 3-3/4	500	.29	.22	.20	15.47	19.34	23.20	508 x 635 x 102	9150	59.7	54.7	49.8
24 x 24 x 4	23-3/8 x 23-3/8 x 3-3/4	500	.29	.22	.20	17.32	22.27	27.21	610 x 610 x 102	9150	59.7	54.7	49.8
*25 x 29 x 4	24-1/2 x 28-1/2 x 3-3/4	500	-	.22	.20	-	28.36	34.80	635 x 737 x 102	9150	-	54.7	49.8
*28 x 30 x 4	27-3/8 x 29-3/8 x 3-3/4	500	-	.22	.20	-	30.63	37.92	711 x 762 x 102	9150	-	54.7	49.8
12 x 24 x 6	11-3/8 x 23-3/8 x 5-3/4	500	-	.18	.16	-	17.07	20.86	305 x 610 x 152	9150	-	44.8	41.2
16 x 20 x 6	15-1/2 x 19-1/2 x 5-3/4	500	-	.18	.16	-	18.93	23.66	406 x 508 x 152	9150	-	44.8	41.2
16 x 25 x 6	15-1/2 x 24-1/2 x 5-3/4	500	-	.18	.16	-	23.72	29.65	406 x 635 x 152	9150	-	44.8	41.2
18 x 24 x 6	17-1/2 x 23-1/2 x 5-3/4	500	-	.18	.16	-	26.55	32.24	457 x 610 x 152	9150	-	44.8	41.2
20 x 20 x 6	19-1/2 x 19-1/2 x 5-3/4	500	-	.18	.16	-	23.66	28.39	508 x 508 x 152	9150	-	44.8	41.2
20 x 24 x 6	19-3/8 x 23-3/8 x 5-3/4	500	-	.18	.16	-	28.45	34.14	508 x 610 x 152	9150	-	44.8	41.2
20 x 25 x 6	19-1/2 x 24-1/2 x 5-3/4	500	-	.18	.16	-	29.65	35.58	508 x 635 x 152	9150	-	44.8	41.2
24 x 24 x 6	23-3/8 x 23-3/8 x 5-3/4	500	-	.18	.16	-	34.14	41.73	610 x 610 x 152	9150	-	44.8	41.2

Tolerances shall be +/- 1/8" for height, width and +/- 1/16" for depth. Recommended final resistance is 1.00" w.g. All special sizes will be undersized by 1/8" unless specified otherwise.
*Utilizes four piece frame construction.

STANDARD PRESSURE DROP

Test Filter Size 24" x 24" x 2" Nominal

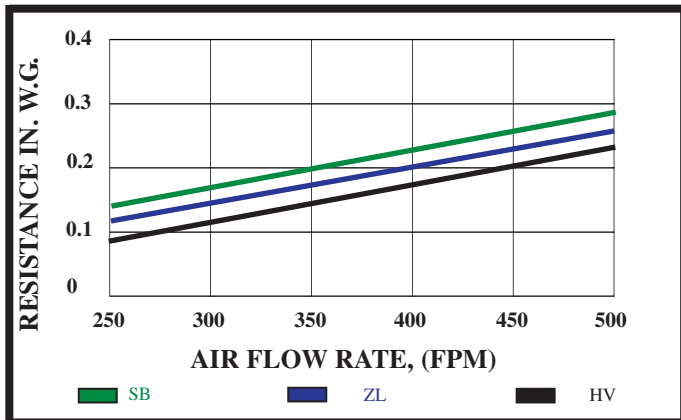

MINIMUM PARTICLE SIZE EFFICIENCY

Test Filter Size 24" x 24" x 2" Nominal

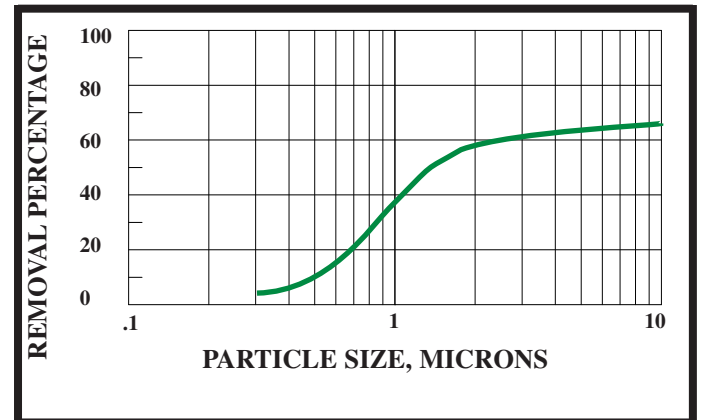

The Z-Line Series offers the most complete line of pleated filters in the market. With electrostatically enhanced media fibers, the Z-Line Series offers high initial efficiency the minute you turn the system on. The mechanical structure of the media fibers sustains the efficiency over the service life of the filter and produces high dust holding capacity. Glasfloss Z-Line Series pleated filters are used in a broad range of installations, from pre-filter for high efficiency filters to primary filters for computer room units.

The Z-Line Series offers three grades to choose from:

“**SB**” - Our most economical pleated filter grade provides efficiency and dependability.

“**ZL**” - Offers the optimum combination of price and performance and is designed to ensure maximum filter life.

“**HV**” - Ideal in high velocity systems where maximum square footage of media is necessary. The HV has increased surface area that ensures a good air flow to media ratio where low resistance and filter integrity are of prime importance. The 4” and 6” HV standard size filter incorporate media separators that supports and maintain pleat alignment.

4” and 6” HV Incorporates Media Separators

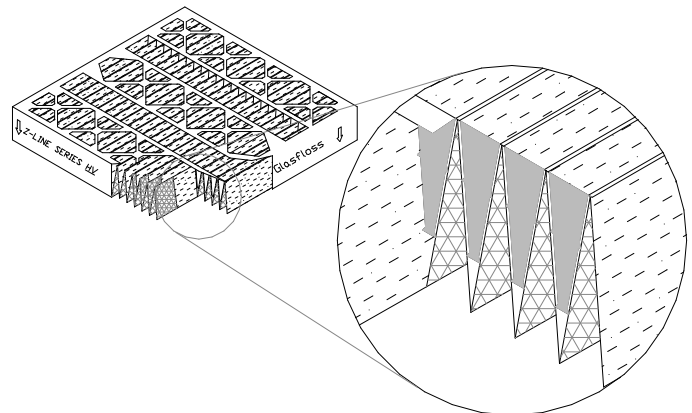

“Serving You With Locations Throughout The Nation”

Glasfloss has a policy of uninterrupted research, development and product improvement and reserves the right to change design and specifications without notice.



Z-LINE SERIES FEATURES

- MERV 7
- Electrostatically Charged Fibers Increase Initial Efficiency
- Media Will Not Support Microbial Growth
- Excellent Pre-filter or Primary Filter
- Wide Range of Standard & Special Sizes
- Optional 6" & 8" Depth Filters Available in ZL and HV
- Optional High Efficiency Media Available

Comparison of Glasfloss Z-Line Series Pleat to a Regular Pleat

STANDARD PRESSURE DROP

Test Filter Size 24" x 24" x 2" Nominal

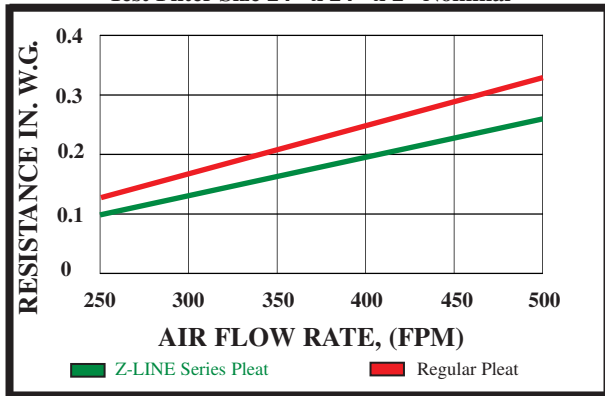

MINIMUM PARTICLE SIZE EFFICIENCY

Test Filter Size 24" x 24" x 2" Nominal

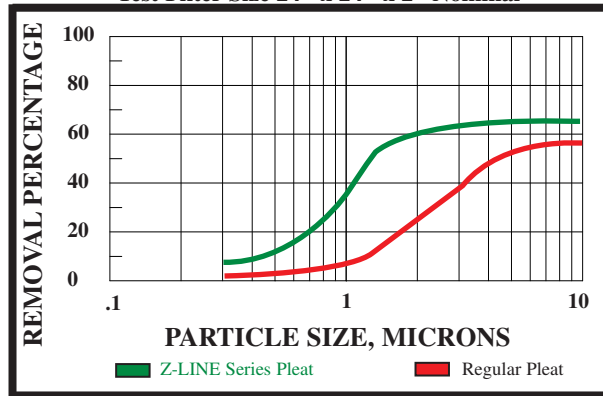

Distributed by:



"Serving You With Locations Throughout The Nation"

Glasfloss has a policy of uninterrupted research, development and product improvement and reserves the right to change design and specifications without notice.