

Features

- Advanced spray engine provides three alternate experiences: wide coverage, intense drenching, and targeted spray
- Wide coverage spray produces an encompassing spray for everyday use
- Intense drenching spray delivers a forceful spray ideal for rinsing shampoo from hair
- Targeted spray is a focused stream for targeting sore muscles or use as a utility spray
- Pause feature temporarily pauses water flow to conserve water while you lather, shave, or shampoo
- Thumb tab allows for a smooth transition between sprays
- MasterClean™ sprayface features an easy-to-clean surface that withstands mineral buildup
- 2.5 gpm (9.5 lpm) maximum flow rate at 45 psi (3.1 bar)
- 36" (914 mm) slidebar features adjustable mounting brackets for installation flexibility
- 60" (1524 mm) hose length

Material

- Durable material construction
- KOHLER finishes resist corrosion and tarnishing

Installation

- Wall-mount

Recommended Products/Accessories

K-30646 Shower filter
K-30647 Shower filter replacement
K-23723 Faucet cleaner

Optional Products/Accessories

K-98350 wall-mount supply elbow
K-98351 wall-mount supply elbow with check valve

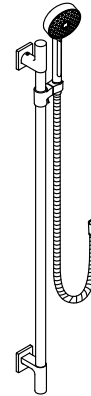

Codes/Standards





None Applicable

KOHLER® Faucet Lifetime Limited Warranty

See website for detailed warranty information.

Available Colors/Finishes

Color tiles intended for reference only.

Color	Code	Description
	CP	Polished Chrome
	BN	Vibrant™ Brushed Nickel
	2BZ	Oil-Rubbed Bronze
	BL	Matte Black
	2MB	Vibrant™ Brushed Moderne Brass

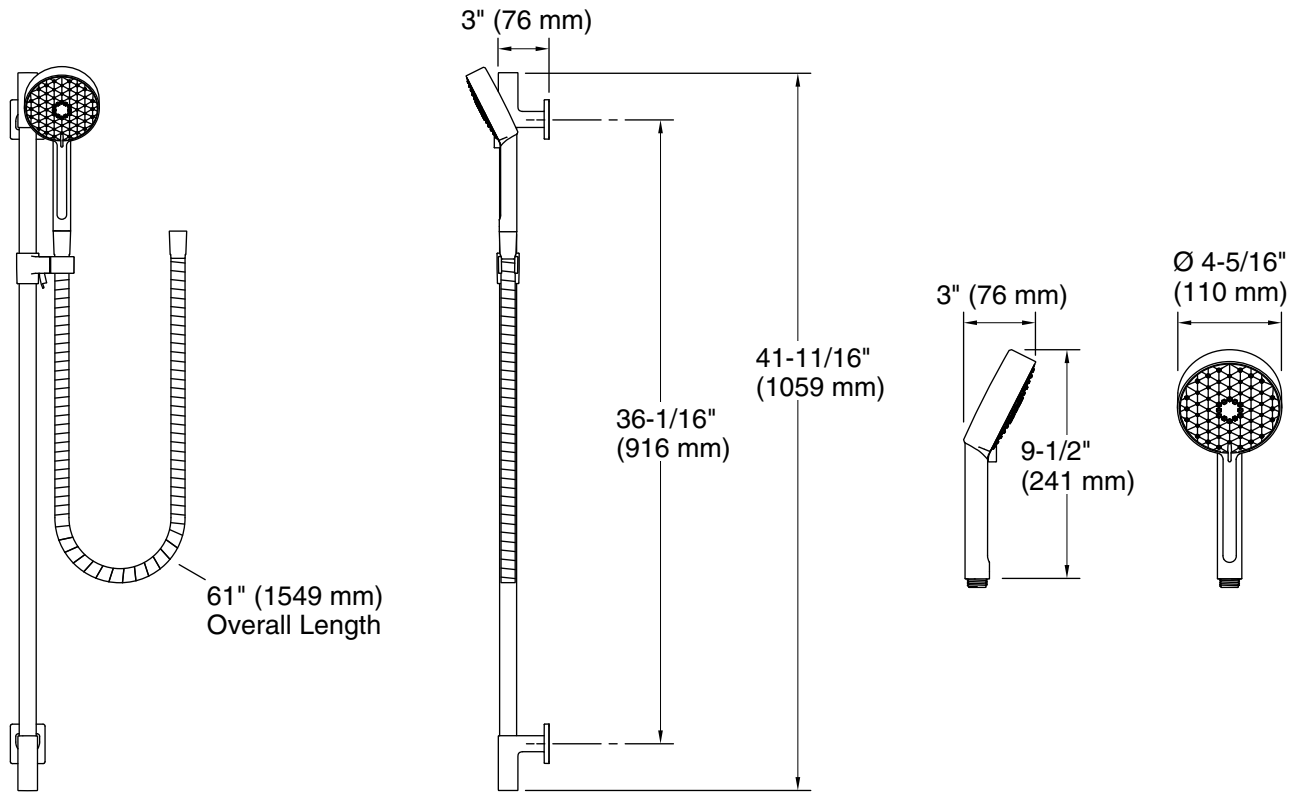

Technical Information

All product dimensions are nominal.

Drain included: No

Handshower:

Rated maximum flow: 2.5 gal/min (9.5 l/min)

Pressure: 45 psi (3.1 bar)

Notes

Install this product according to the installation instructions.

Plumbing codes require approved backflow prevention devices to be installed in-line to handshowers. Please consult with local plumbing officials.

Mount the sidebar to stud framing or install backing support. For tile or other solid finish surfaces: Pre-drill mounting holes through surface material only; do not drill into the stud. For drywall surface: No pre-drill is required.