

Features

- Lid design conceals toilet seat to create a clean, sleek look
- Grip-Tight installation hardware makes it easy to fasten the seat – everything is done from above the bowl
- Grip-Tight bumpers hold seat firmly in place
- ReadyLatch™ hinge provides a positive lock/unlock latch to securely hold seat in position, yet seat easily removes for cleaning or adjusting fit
- Single-hinge cover simplifies cleaning
- Quiet-Close™ round-front lid and seat prevents slamming
- Contoured seat for user comfort
- Color-matched plastic hinges

Material

- Plastic construction



Codes/Standards







IAPMO/ANSI Z124.5

KOHLER® Toilets and Seats Limited Warranty

See website for detailed warranty information.

Available Colors/Finishes

Color tiles intended for reference only.

| Color | Code | Description |
|---|------|---------------|
|  | 0 | White |
|  | 96 | Biscuit |
|  | NY | Dune |
|  | 95 | Ice™ Grey |
|  | 58 | Thunder™ Grey |
|  | 7 | Black Black™ |

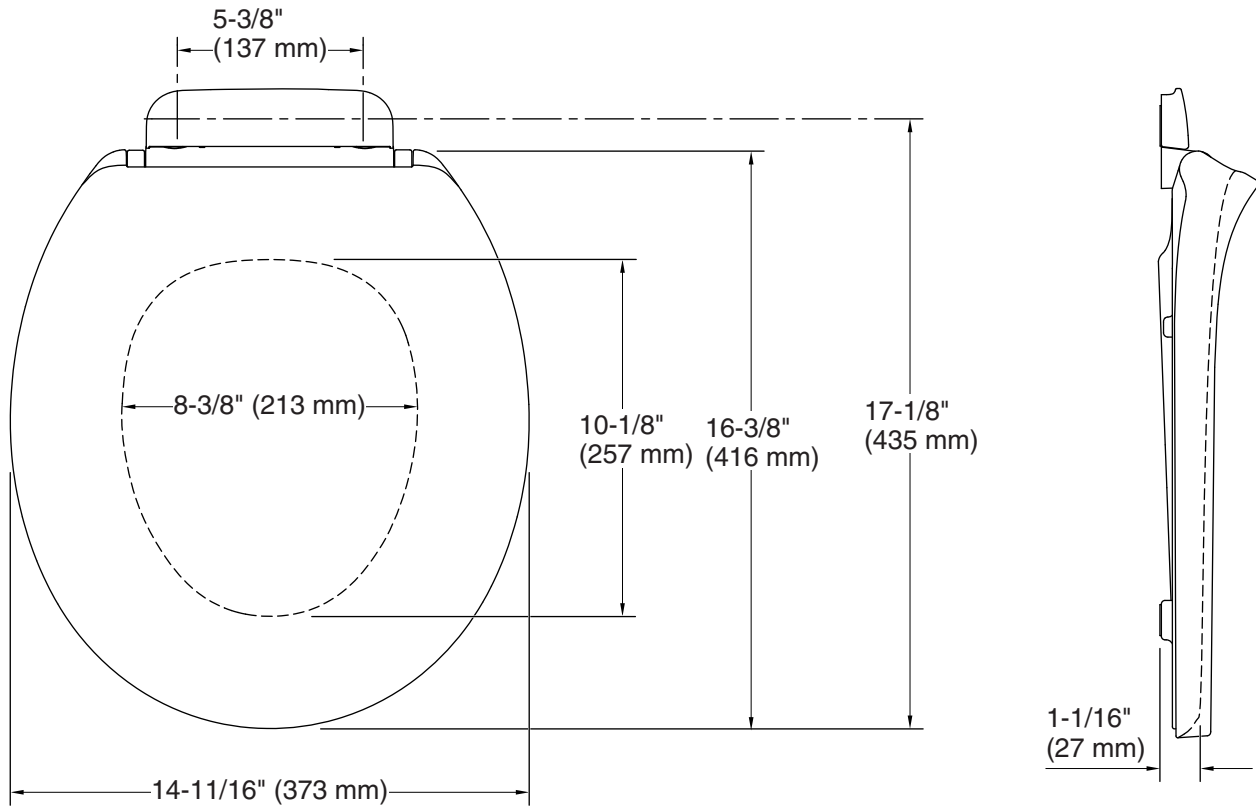

Technical Information

All product dimensions are nominal.

Seat shape type: Round-front
Seat front type: Closed-front
Seat-mounting holes: 5-7/16" (137 mm)

Notes

Install this product according to the installation instructions.