

evolve™

Auto-Diverting Tub Spout System

+ ShowerStart® TSV

FIXTURE SET FOR
TUB/SHOWER BATHING UNITS
EV3352 & EV3382

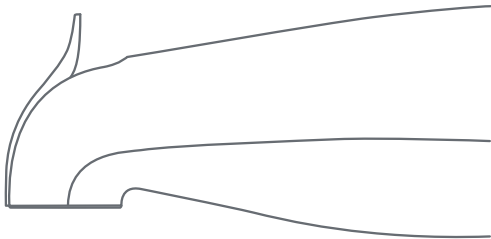
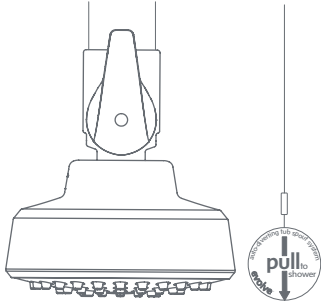

GUIDE

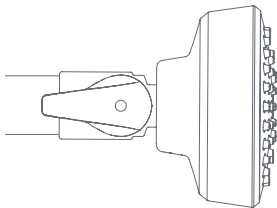

CERTIFIED SUPERIOR PERFORMANCE

part number	max flow at 80 psi	min flow at 45 psi
EV3352-CP125	1.25gpm (4.7 L/min)	.9gpm (3.4 L/min)
EV3352-CP150	1.5gpm (5.7 L/min)	1.1gpm (4.2 L/min)
EV3382-CP150	1.5gpm (5.7 L/min)	1.1gpm (4.2 L/min)



IMPORTANT SAFETY INFORMATION:

ShowerStart TSV is NOT an anti-scald device.

- Lower water heater temperature to prevent scalding accidents.
Water temperatures above 120° F can cause severe burns or even death.
- Always resume water flow and check water temperature before entering shower.
- Not designed for use with tankless hot water heaters.



HOW IT WORKS

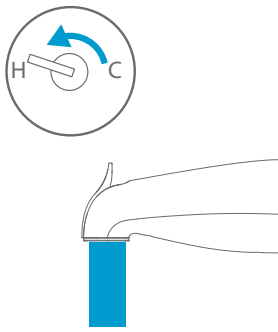

1 Turn on water

Cold water exits spout

Continue with your typical routine - the things you do while waiting for the shower to become warm.

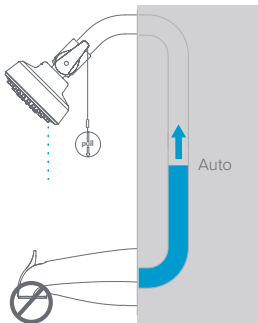

2 Auto diverts when hot water arrives

Upon reaching 95°F, ShowerStart Technology automatically diverts flow. Showerhead trickles - saving hot water until you get in.

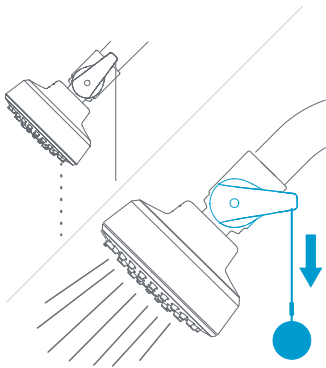

3 Pull cord when ready to get in

Pull the cord to activate normal flow and begin showering.

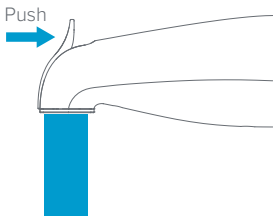

4 Option: Taking a bath

If a bath is preferred, simply push tub spout lever back to its original position.

SHOWERHEAD INSTALLATION

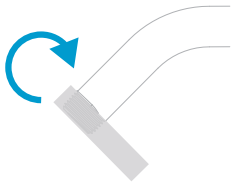

1

Wrap **Teflon Tape** in a clockwise direction tightly around the screw threads on the shower pipe. The tape will stretch. This is OK and is desired. Wrapping the tape creates a solid seal to prevent water leakage.

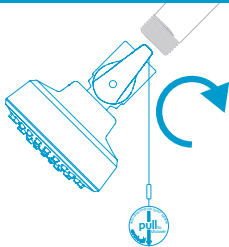

2

Remove washer from pipe if present.

Hand tighten **Evolve Showerhead** clockwise onto the shower pipe. The showerhead will operate effectively in any position, however, the preferred position is to have the pull cord located on the side of the shower pipe that is closest to your shower's entry.

SHOWERHEAD MAINTENANCE

Your showerhead comes with a screen filter. To clean, simply remove, rinse and replace.

THREADED CONNECTION INSTALLATION

Use Threaded Connection Install if:

- threaded pipe extends 1.5" or less from wall

Parts needed:

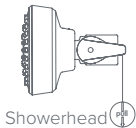
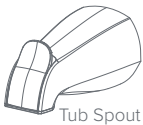

Tools needed:



hex key
(included)



Registration
Plate



Teflon Tape



1/2" Threaded
Quick Connect
Receiver



3/4" Threaded
Quick Connect
Receiver



Trim Plate
(optional)

THREADED CONNECTION INSTALLATION



1

Wrap supplied **Teflon Tape** around threads in a clockwise direction.

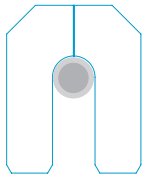

2

Place **Registration Plate** to assure accurate alignment.

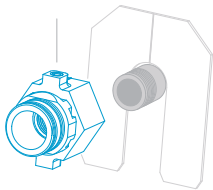

3

Thread the appropriate size **Quick Connect Receiver** onto the water supply pipe. Align vertical indication on mount with registration plate. Adjust teflon tape if necessary to achieve tight and vertical. Remove **Registration Plate**.

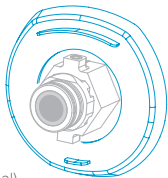

4 (Optional)

If necessary or desired affix **Trim Plate**.

THREADED CONNECTION INSTALLATION

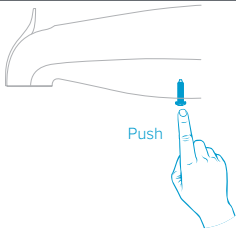

5

Before attaching the **Auto-Diverting Tub Spout**, press up on the unit's set screw until it can move upwards no further. (unthread screw slightly if interfering)

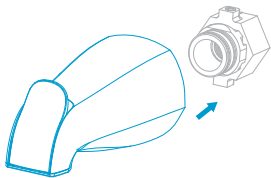

6

Fully seat the **Auto-Diverting Tub Spout**.

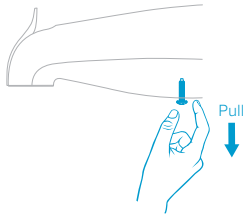

7

Pull the **Auto-Diverting Tub Spout's** set screw until it slides downward no further. This holds the unit in place.

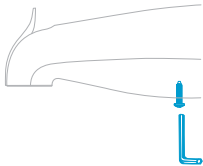

8

Lock the **Auto-Diverting Tub Spout** in place by tightening the unit's set screw.

SLIP-FIT CONNECTION INSTALLATION

Use Slip-Fit Connection Install if:

- previous tub spout was a slip-fit
- water pipe extends more than 1.25" from wall

Parts needed:

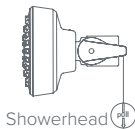
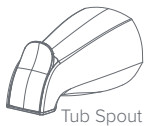

Tools needed:



pencil



SLIP-FIT CONNECTION INSTALLATION

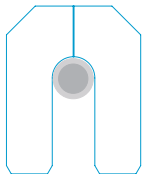
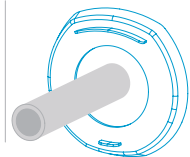

1 (optional Trim Plate)

The trim plate is only needed if the existing hole in the wall would not be fully covered by the back end of the tub spout or the wall is uneven.

2

Place the **Registration Plate** against the wall over pipe.

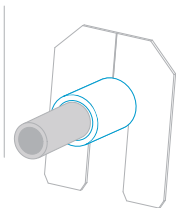

3
Slide the **Spacing Tube** over the water supply pipe until it touches the **Registration Plate**.

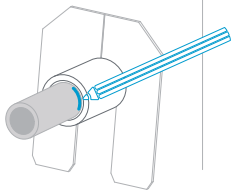

4
Place a mark on the water supply pipe at the end of the **Spacing Tube**. Remove the **Spacing Tube**.

SLIP-FIT CONNECTION INSTALLATION

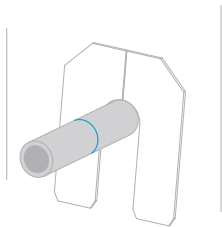

5

Cut the water supply pipe at the mark.

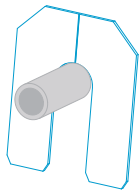

6

Place the **Registration Plate** against the wall so the water supply pipe fits within its notch. Adjust so its alignment indicator is vertical.

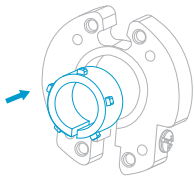

7

For 1/2" copper pipe only:

Slide **Split-Ring** into **Slip-Fit Clamp** before continuing with next step.

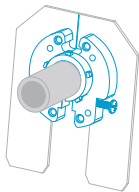

8

Slide the **Slip-Fit Clamp** over the water supply pipe until it's touching the **Registration Plate**.

SLIP-FIT CONNECTION INSTALLATION

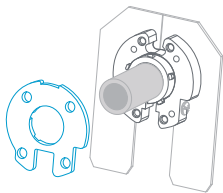

- 9**
Slide the Slip-Fit Quick Connect Back Plate over the water supply pipe until it connects to the Slip-Fit Clamp. It seats via alignment tabs.

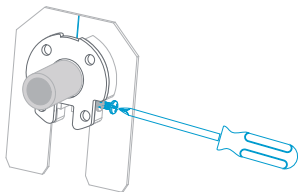

- 10**
Tighten the Slip-Fit Clamp's set screw.

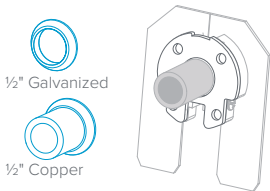

- 11**
Slide the correct Seal over the water supply pipe until it touches the Slip-Fit Quick Connect Back Plate. The small end of either seal should be facing outwards.

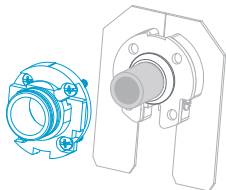

- 12**
Slide the Slip-Fit Quick Connect Receiver over the water supply pipe until it is seated upon the Seal.

SLIP-FIT CONNECTION INSTALLATION

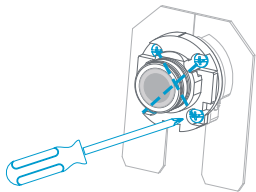

13

Tighten the Slip-Fit Quick Connects Receiver's four front facing screws. Each screw should be tightened a little at a time, working in an "X" pattern until they are fully tightened.



14

Remove the Registration Plate.

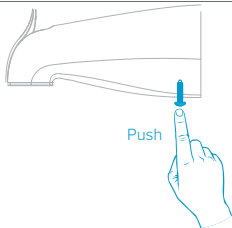

15

Before attaching the Auto-Diverting Tub Spout, press up on the unit's set screw until it can move upwards no further (unscrew first slightly if interfering).

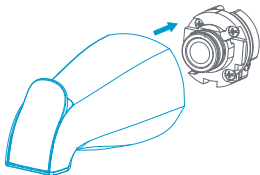

16

Fully seat the Auto-Diverting Tub Spout.

SLIP-FIT CONNECTION INSTALLATION

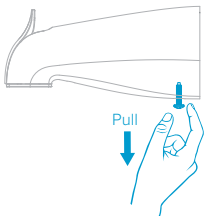

17

Pull the Auto-Diverting Tub Spout's set screw until it slides downward no further. This holds the unit in place.

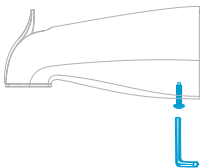

18

Lock the Auto-Diverting Tub Spout in place by tightening the unit's set screw.

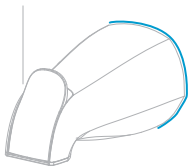

19

Apply caulk around the back edge of the tub spout leaving a small gap at the bottom.

Questions?

Contact us at www.thinkevolve.com/support
or call 480-496-2294

Compatibility:

- For use in homes with static water pressure of at least 35 psi
- Works with galvanized or copper plumbing
- Not for use with wall mount diverters
- Tankless systems require a minimum flow rate to produce hot water. With some tankless systems, a brief yet noticeable change in the shower's temperature may occur shortly after resuming the shower's normal flow

Codes / Standards



WaterSense

Conforms to A112.18.1M.

1.25 GPM models: For use with automatic compensating valves rated at .9 gpm (3.4 L/min) or less.

1.5 GPM models: For use with automatic compensating valves rated at 1.1 gpm (4.2 L/min) or less.

1.75 GPM models: For use with automatic compensating valves rated at 1.3 gpm (4.9 L/min) or less.

2.0 GPM models: For use with automatic compensating valves rated at 1.5 gpm (5.7 L/min) or less.

Default operating mode:

- The system's default mode assumes a shower will be taken

Auto resets for next use:

- The system automatically resets to its default mode after a shower or bath is completed

ShowerStart TSV:

- ShowerStart TSV is not an anti-scald device
- Lower water heater to 120° F (49° C)
- Always resume water flow and check water temperature before entering shower

3 Year Limited Lifetime Warranty

For warranty claims please contact us at www.thinkevolve.com or call 480-496-2294

Evolve Technologies warrants this product to be free from defects in materials and workmanship for a period of three years from the date of purchase. This warranty is limited to repairing or replacing, at Evolve Technologies' sole option, any such defective products. To obtain service under warranty you must obtain a Return Material Authorization (RMA) number from an Evolve Technologies representative. The product must be returned with transportation charges prepaid and must be accompanied by a brief description of the problem encountered and proof of date and place of purchase. This warranty does not apply to equipment which has been damaged by accident, negligence, or misapplication or has been altered or modified in any way. This warranty applies to the original purchaser. EXCEPT AS PROVIDED HEREIN, Evolve Technologies MAKES NO WARRANTIES, EXPRESSED OR IMPLIED, INCLUDING WARRANTIES OF MERCHANTABILITY AND FITNESS FOR A PARTICULAR PURPOSE. Some countries do not permit limitation or exclusion of implied warranties; therefore, the aforesaid limitation(s) or exclusion(s) may not apply to the purchaser. EXCEPT AS PROVIDED ABOVE, IN NO EVENT SHALL Evolve Technologies BE LIABLE FOR DIRECT, INDIRECT, SPECIAL, INCIDENTAL, OR CONSEQUENTIAL DAMAGES ARISING OUT OF THE USE OF THIS PRODUCT, EVEN IF ADVISED OF THE POSSIBILITY OF SUCH DAMAGE. Specifically, Evolve Technologies is not liable for any costs, such as lost products or revenue, loss of equipment, loss of use of equipment, costs of substitutes, claims by third parties, or otherwise. This warranty gives you specific legal rights and you may also have other rights which may vary from location to location.

thinkevolve.com

©2018 Evolve Technologies LLC. All rights reserved.

Patent <http://www.thinkevolve.com/patents>

Other U.S. and Foreign Patents Pending.

Designed and developed in USA. Manufactured in China. Rev-1217

evolve™

Sistema de Auto-Desviación de Grifo de Bañera

+ ShowerStart® TSV

ACCESORIOS PARA
UNIDADES DE REGADERA/BAÑERA
EV3312 & EV3322

GUÍA

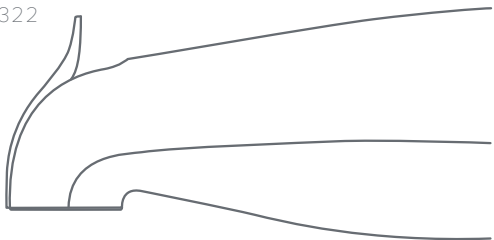
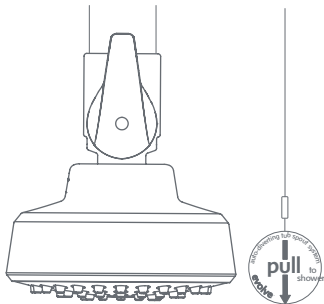

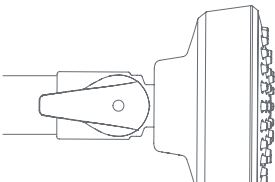

DESEMPEÑO SUPERIOR CERTIFICADO

Número de parte	Flujo máximo a 80 psi	Flujo mínimo a 45 psi
EV3312-CP125	1.25gpm (4.7 L/min)	.9gpm (3.4 L/min)
EV3312-CP150	1.5gpm (5.7 L/min)	1.1gpm (4.2 L/min)
EV3312-CP175	1.75gpm (6.6 L/min)	1.3gpm (4.9 L/min)
EV3312-CP200	2.0gpm (7.6 L/min)	1.5gpm (5.7 L/min)
EV3322-CP125	1.25gpm (4.7 L/min)	.9gpm (3.4 L/min)
EV3322-CP150	1.5gpm (5.7 L/min)	1.1gpm (4.2 L/min)
EV3322-CP175	1.75gpm (6.6 L/min)	1.3gpm (4.9 L/min)
EV3322-CP200	2.0gpm (7.6 L/min)	1.5gpm (5.7 L/min)



Certified by
IAPMO R&T



INFORMACIÓN DE SEGURIDAD IMPORTANTE:

ShowerStart TSV NO es un dispositivo contra quemaduras

- Reduzca la temperatura del calentador de agua para prevenir quemaduras. Temperaturas sobre 120° F pueden causar quemaduras severas o incluso la muerte.
- Siempre reanude el flujo de agua y asegúrese de revisar la temperatura del agua antes de entrar a la regadera.
- No está diseñado para uso con calentadores de agua sin tanque.



CÓMO FUNCIONA

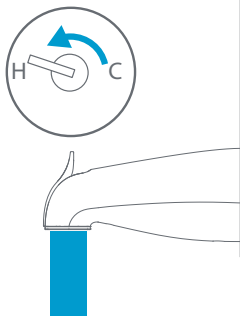

1 Abra la llave del agua

Abra la llave del agua caliente de su tina, déjela correr y siga con su rutina mientras espera que salga el agua tibia.

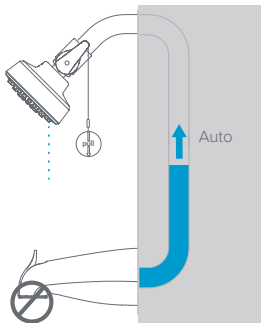

2 Desvío Automático, comienza a funcionar

Cuando el agua caliente comienza a salir en la llave de la tina, ShowerStart automáticamente desvía el flujo de agua a la regadera y se inicia un goteo, ahorrando así agua caliente, hasta que esté listo para bañarse.

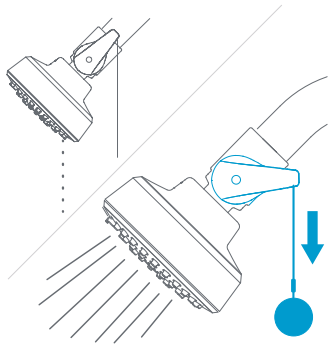

3 Cuando este listo, jale el cordón

Para reanudar la presión completa del agua jale el cordón del sistema.

oprime

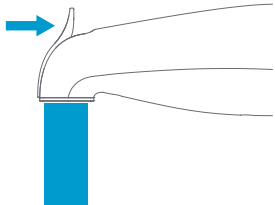

4 Opción: Baño de tina

Para continuar su baño de tina si lo prefiere, active la salida de agua para la tina como usualmente lo hace.

INSTALACIÓN DE REGADERA

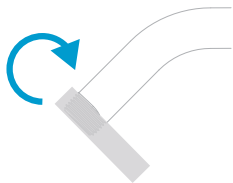

- 1**
- Envuelva cinta de plomería en dirección a las agujas del reloj de manera justa alrededor de las roscas de tornillo en la tubería de la regadera. La cinta se extenderá. Esto está bien si así se desea. Envolver con la cinta crea un sello sólido y previene goteos.

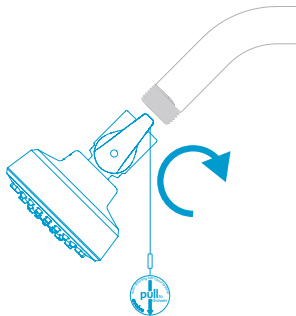

- 2**
- Ajuste a mano su Regadera Evolve en dirección a las agujas del reloj sobre la tubería de la regadera. La regadera funcionará eficazmente en cualquier posición, sin embargo, la posición ideal consiste en tener el cordón localizado al lado el tubo de regadera más cercano a donde comienza la regadera.

INSTALACIÓN DE CONEXIÓN ENROSCADA

Use la Instalación de Conexión Enroscada si:

- la tubería con rosca sale $\frac{5}{8}$ " o menos de la pared

Partes necesarias:



Grifo de bañera

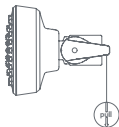

Regadera



Placa de Registro



cinta de teflón



$\frac{1}{2}$ " Recividor de Rosca de Conexión Rápida (con tornillos)



$\frac{3}{4}$ " Recividor de Rosca de Conexión Rápida (con tornillos)



Placa de ajuste (opcional)

Herramientas necesarias:



llave hexagonal
(provided)

INSTALACIÓN DE CONEXIÓN ENROSCADA

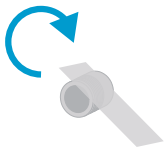

1

Envuelva la cinta de teflón alrededor de la tubería.

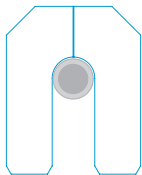

2

Coloque la **Placa de Registro** contra la pared de manera que la tubería del agua encaje dentro del espacio. Ajuste de manera que el indicador de alineación quede vertical.

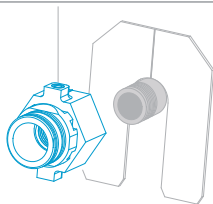

3

Enrosque el **Recividor de Conexión Rápida** del tamaño apropiado en la tubería del agua. Alinee el indicador vertical de la base con la placa de registro. Ajuste la cinta de teflón si es necesario para obtener la posición justa y vertical.

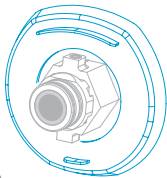

4 (Opcional)

Coloque la **Placa de Ajuste**.

INSTALACIÓN DE CONEXIÓN ENROSCADA

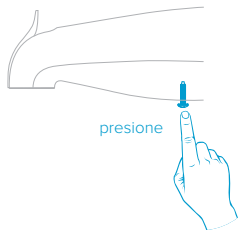

- 5**
Antes de sujetar el Grifo de Bañera de Auto-Desviación, presione el tornillo fijo de la unidad hasta que no pueda subir más alto.

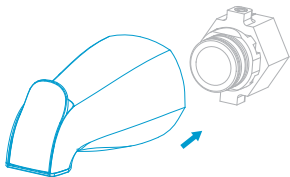

- 6**
Coloque y ajuste el Grifo de Bañera de Auto-Desviación.

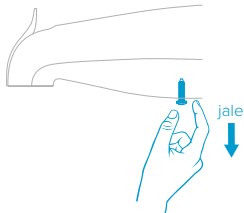

- 7**
Tire del tornillo fijo del Grifo de Bañera de Auto-Desviación, deslizándose hacia abajo hasta detenerse. Esto mantiene la unidad en su lugar.

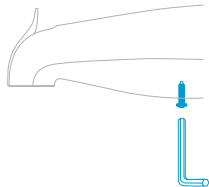

- 8**
Ajuste el Grifo de Bañera de Auto-Desviación en su lugar atornillando el tornillo fijo de la unidad.

INSTALACIÓN DE CONEXIÓN POR DESLIZAMIENTO

Use la Instalación de Conexión Deslizada si:

- el grifo de bañera tenía una conexión por deslizamiento
- la tubería del agua sale más de 1.25" de la pared

Parts necesarias:



Grifo de bañera

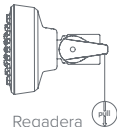

Regadera



Placa de Registro



Placa de ajuste
(opcional)



Tubo
Espaciador



Sello de
cobre de 1/2"



Anillo abierto
(para tubería
de cobre de 1/2")



Pinza de
Deslizamiento
(con tornillo fijo)



Placa Posterior
Desñizable de
Conexión Rápida



Recividor
Deslizable de
Conexión Rápida

Herramientas necesarias:



lápiz



Destornillador de estrella



Destornillador plano



cortador
de tubos



llave hexagonal
(provided)



cinta de teflón



Sello galvanizado
de 1/2"

INSTALACIÓN DE CONEXIÓN POR DESLIZAMIENTO

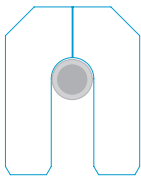

1

Coloque la placa de registro contra la pared sobre la tubería. Nota: Si la Placa de Registro no se acomoda justa contra la pared, ahora es cuando debe instalar la placa de ajuste opcional.

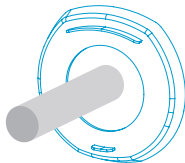

2 (opcional)

Coloque la Placa de Ajuste.

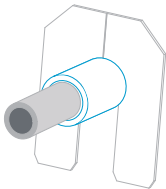

3

Corte el Tubo Espaciador sobre la tubería hasta tocar la placa de registro.

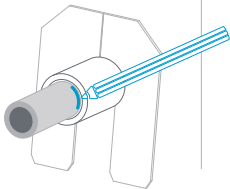

4

Marque la tubería del agua al final del Tubo Espaciador. Retire el Tubo Espaciador.

INSTALACIÓN DE CONEXIÓN POR DESLIZAMIENTO

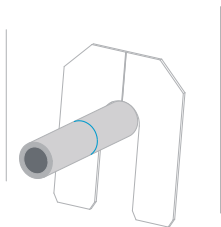

- 5**
Corte la tubería del agua donde se encuentra la marca.

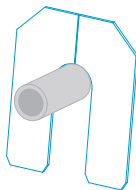

- 6**
Coloque la **Placa de Registro** contra la pared de manera que la tubería del agua encaje dentro del espacio. Ajuste de manera que el indicador de alineación quede vertical.

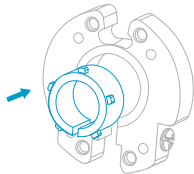

- 7**
Para tubería de cobre de ½" :
Deslice el **Anillo Abierto** dentro de la **Pinza Deslizable** antes de continuar con el siguiente paso.

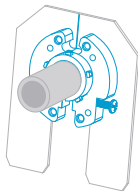

- 8**
Coloque la **Pinza Deslizable** sobre la tubería del agua hasta que toque la **Placa de Registro**.

INSTALACIÓN DE CONEXIÓN POR DESLIZAMIENTO

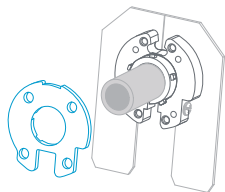

9

Deslice Placa Posterior Deslizable de Conexión Rápida sobre la tubería del agua hasta conectarse con la Pinza Deslizable. Se aloja por medio de las pestañas de alineación

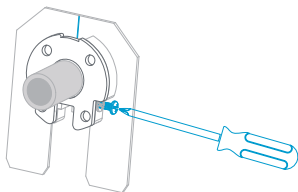

10

Ajuste el tornillo fijo de la Placa Deslizable.



½" Galvanizado



½" Cobre

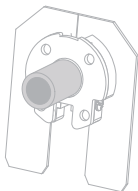

11

Deslice el Sello correcto sobre la tubería del agua hasta tocar la Placa Posterior Deslizable de Conexión Rápida. La parte pequeña del sello debe salir por delante.

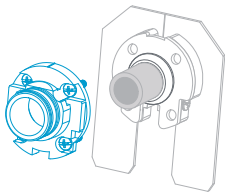

12

Deslice el Recividor Deslizable de Conexión Rápida sobre la tubería del agua hasta que se encuentre sobre el Sello.

INSTALACIÓN DE CONEXIÓN POR DESLIZAMIENTO

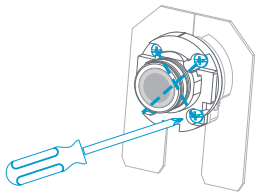

13

Ajuste los cuatro tornillos frontales del Recividor Deslizable de Conexión Rápida. Cada tornillo debe ser ajustado poco a poco, creando una "X" hasta que todos estén apretados de igual manera.



14

Retire la Placa de Registro.

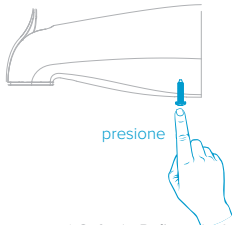

15

Antes de sujetar el Grifo de Bañera de Auto-Desviación, presione el tornillo fijo de la unidad hasta que no pueda subir más alto.

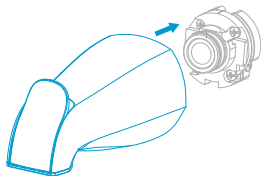

16

Coloque y ajuste el Grifo de Bañera de Auto-Desviación.

INSTALACIÓN DE CONEXIÓN POR DESLIZAMIENTO

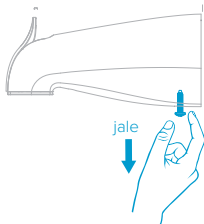

- 17**
Tire del tornillo fijo del Grifo de Bañera de Auto-Desviación, deslizándose hacia abajo hasta detenerse. Esto mantiene la unidad en su lugar.

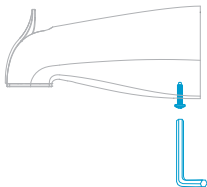

- 18**
Ajuste el Grifo de Bañera de Auto-Desviación en su lugar atornillando el tornillo fijo de la unidad.

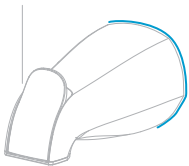

- 19**
Apply caulk around the back edge of the tub spout leaving a small gap at the bottom.

¿Preguntas?

Contáctenos en www.thinkevolve.com/-support or llame al 480-496-2294

COMPATIBILIDAD & CONSIDERACIONES TÉCNICAS

Compatibilidad:

- Para uso en hogares con presión estática de agua de al menos 35 psi
- Funciona con tuberías de Acero Galvanizado o Cobre
- Sistemas sin tanque requieren un determinado flujo de agua para producir agua caliente. Cambios breves pero notables pueden ocurrir con algunos sistemas sin tanque al reanudar el flujo normal de la regadera.

Modo de funcionamiento estándar:

- El modo de funcionamiento estándar de este sistema asume que la regadera será utilizada.

Reinicio para el siguiente uso:

- El sistema se reinicia automáticamente, volviendo al modo de funcionamiento estándar después de cada uso en regadera o bañera.

ShowerStart TSV:

- ShowerStart TSV no es un dispositivo contra quemaduras.
- Reduzca la temperatura de su calentador de agua a 120° F (49° C)
- Siempre reanude el flujo de agua y asegúrese de revisar la temperatura del agua antes de entrara a la regadera.

CÓDIGOS / ESTÁNDARES



WaterSense

Cumple con A112.18.1M

1.25 GPM: Para su uso con válvulas automáticas compensadoras clasificadas a .9 gpm (3.4 L/min) ó menos.

1.5 GPM: Para su uso con válvulas automáticas compensadoras clasificadas a 1.1 gpm (4.2 L/min) ó menos.

1.75 GPM: Para su uso con válvulas automáticas compensadoras clasificadas a 1.3 gpm (4.9 L/min) ó menos.

2.0 GPM: Para su uso con válvulas automáticas compensadoras clasificadas a 1.5 gpm (5.7 L/min) ó menos.

Garantía de por Vida Limitada de 3 Años

Para reclamaciones de garantía por favor comuníquese con nosotros en www.thinkevolve.com ó llame al 480-496-2294

Evolve Technologies garantiza que este producto está libre de defectos en materiales y mano de obra durante un período de tres años de la fecha de compra. Esta garantía está limitada a la reparación o el reemplazo, a la discreción única de Evolve Technologies, de cualquier producto defectuoso. Para obtener servicio bajo garantía usted debe obtener un número de Autorización de Devolución del Material (RMA por sus siglas en inglés) de un representante de Evolve Technologies. El producto debe ser devuelto con los gastos de transporte pre-pagados y debe ser acompañado por una breve descripción del problema encontrado y el comprobante de la fecha y el lugar de compra. Esta garantía no es aplicable al equipo que haya sido dañado por accidente, negligencia, o mala aplicación o que haya sido alterado o modificado de cualquier manera. Esta garantía es aplicable al comprador original. SALVO COMO SE ESTIPULE EN ÉSTA, Evolve Technologies NO OFRECE GARANTÍAS, EXPRESAS O IMPLÍCITAS, INCLUYENDO GARANTÍAS DE COMERCIALIZABILIDAD Y APTITUD PARA UN PROPÓSITO EN PARTICULAR. Algunos países no permiten la limitación o exclusión de garantías implícitas; por lo tanto, las limitaciones o exclusiones antes mencionadas pueden no ser aplicables al comprador. SALVO COMO SE ESTIPULA ANTERIORMENTE, EN NINGÚN CASO Evolve Technologies DEBERÁ SER RESPONSABLE POR DAÑOS DIRECTOS, INDIRECTOS, ESPECIALES, INCIDENTALES O RESULTANTES QUE SURJAN DEBIDO AL USO DE ESTE PRODUCTO, AÚN SI ES ADVERTIDO DE LA POSIBILIDAD DE DICHOS DAÑOS. Específicamente, Evolve Technologies no es responsable por cualquier costo, tal como productos o ingresos perdidos, pérdida de equipo, pérdida del uso del equipo, costo de sustitutos, reclamaciones de terceros, o de otra forma. Esta garantía le otorga derechos legales específicos y usted también puede tener otros derechos que pueden variar de un lugar a otro.

thinkevolve.com

©2018 Evolve Technologies LLC. Se reservan todos los derechos.

Patentes <http://www.thinkevolve.com/patents>

Otras patentes pendientes en los E.U.A. y el extranjero.

Diseñada y desarrollada en los E.U.A. Fabricada en China. 1217