

CATALOG



THE KEENEY MANUFACTURING COMPANY

CONTENTS

Visit us on the Internet at: www.keeneymanufacturing.com

BRASS TUBULAR.....	1-17
P TRAPS & S TRAPS	1-4
SINK TRAPS	4-6
WASHING MACHINE TRAPS.....	5
J BENDS & WALL BENDS.....	5-7
FLOOR TUBES.....	7
CONTINUOUS WASTES, DISPOSER KITS	7-8
CAST TEES	8-9
WASTE ARMS	9-10
TAILPIECES.....	10-11
EXTENSION TUBES.....	11-13
THREADED TUBES.....	13-14
BRANCH TAILPIECES.....	14-15
P.O. & C.O. PLUGS, DOUBLE OFFSETS	15
SLIP JOINT ELBOWS.....	16
COVERING TUBES	16
REPAIR COUPLINGS	16
WASTE CONNECTIONS.....	16-17
NUTS & WASHERS.....	17
FLANGES	18-20
SURE GRIP FLANGES: SHALLOW, DEEP, BOX	18
FLOOR & CEILING PLATES.....	19
CAST BRASS FLANGES.....	19
SPRINKLER FLANGES	19
SHOWER ROD FLANGES	20
PLASTIC FLANGES	20
COMMERCIAL LINE.....	21-23
SEMI CAST P TRAPS.....	21-22
LAVATORY STRAINERS	22
LOOSE KEY STOPS.....	22
TRAP & SUPPLY PROTECTORS.....	23
HEATING.....	23
SHOWER ACCESSORIES	24
PLASTIC TUBULAR.....	25-32
P TRAPS & S TRAPS	25-26
WASHING MACHINE TRAPS.....	26
SINK TRAPS	26
CONTINUOUS WASTES & MASTERWASTES.....	26-28
DISPOSER ELBOWS & KITS.....	28
WASTE ARM, TEE & TAILPIECES.....	28-29
P.O. & C.O. PLUGS & LAVATORY POP-UPS.....	29-30
BRANCH TAILPIECES.....	30
SINK TAILPIECES, EXTENSION TUBES & COUPLINGS	31-32
NUTS & WASHERS.....	32
CONNECTORS.....	32
STRAINERS.....	33-36
BRASS & STAINLESS STEEL.....	33-35
TRAY PLUGS & ACCESSORIES.....	35
REPLACEMENT PARTS.....	35-36
BATH DRAINS	37-51
BRASS	37-38
TRIM KITS.....	38-39
PLASTIC	39-40
SCHEDULE 40.....	41-47

continued

CONTENTS

SEAL ² TEST BATH DRAIN	44-46
SPECIALITY DRAINS: ROUGH IN KITS, CABLE DRIVEN, TRIAD, SIDE OUTLET, DIRECT OUTLET	47-48
ASSEMBLIES, LINKAGE & ACCESSORY ITEMS	48-51
WATER SUPPLIES	52-64
QUARTER TURN VALVES	52-55
ADAPTERS	54-55
REPAIR VALVES	55
QUARTER TURN LOOSE KEY VALVES	55
MULTI-TURN VALVES, SUPPLY KITS	56-57
MASTERVERVALVE™	58
RISER TUBES: PEX, LAVATORY, CLOSET	58-59
VINYL SUPPLY TUBES	59-60
BRAIDED STAINLESS STEEL FAUCET & TOILET CONNECTORS	60-62
BRAIDED STAINLESS STEEL DISHWASHER, ICE MAKER, WATER HEATER CONNECTORS	62-63
CONNECTOR DISPLAY	63
WASHERS	64
KEENEY BY DESIGN COLLECTION	65-70
BATH DRAINS	65
BATH DRAIN ACCESSORIES	65-67
TRIM KITS	66-67
STRAINERS	67-69
DISPOSER COLLARS	69
P TRAPS	69
POP-UPS	70
VALVES, SUPPLY TUBES	70
FLANGES	70
NIPPLES	70
SOAP LOTION DISPENSERS	70
SUPPLY LINES	70
KEENEY CONVENIENCE CENTER	71-88
BRASS	71-78
FLANGES	79-80
WATER SUPPLY	81
PLASTIC	82-88
"INDEPENDENCE" LINE OF BATH SAFETY	89-94
INTERLOCK HANDLEBAR™ SYSTEM	89-90
CHROME, BRASS, COLORED, STAINLESS STEEL HANDLEBARS™	91-93
BATH SAFETY ACCESSORIES: SAFETY SEATS, TUB RAILS	94
NUMERICAL INDEX	95-98

LOOK FOR THESE HELPFUL SYMBOLS
THROUGHOUT THIS CATALOG...



What's New?... What's Different?...

THERMOPLASTIC RUBBER (TPR) WASHERS (pages 17, 36)

Available in Select Premium Grade Traps and for Individual Sale. Most brass traps come with square cut flat black rubber washers. Flat cut washers do not seal as well as tapered washers. Rubber washers lose their shape. Rubber washers crack, dry out and breakdown causing leaks and callbacks. So why are you settling for traditional rubber washers? Make The Change To Keeney's New Red TPR Washers, The Latest Advance In Leak-Free Technology. Thermo Plastic Rubber (TPR) (or Thermo Plastic Elastomer) has a better flex fatigue resistance than traditional rubber and will hold its shape. TPR Washers offer improved resistance to oil, chemicals like Chloramine, and water. That means over time they will not dry out and crack because they are not just rubber, they are plastic. Check out this advance in Leak-Free Technology from Keeney.

SEAL²TEST BATHDRAIN (pages 44-46)

Keeney's Seal²Test Bathdrain is the newest idea in the fight against leaks and mold! Traditionally, the overflow is sealed only against the back wall of the tub. Keeney's Seal²Test seals using a combination of a Sponge Foam Overflow Washer, an O-Ring seal that is adhered to the Overflow Head and finally a Flat Rubber that seals at the Interior Tub Wall. The Seal²Test creates a double seal to ensure years of leak-free operation. The Seal²Test installs quickly and easily. The screw on test cap allows for a one-man installation and 3-story testing. Then, Pry-Off the Overflow Test Plug with a knife or a screwdriver and Snap-on the Decorative Faceplate. Available with Lift 'n Turn, Roller Ball, & Keeney's New & Improved Foot Lok Stop™ Configurations.

THE KEENEY BY DESIGN COLLECTION (pages 65-70)

The Keeney by Design Collection assembles the products and components required by today's showroom and design centers. This collection features bathroom and kitchen products in finishes meeting the demands of current decorating trends.

SPECIFICATION DRAWINGS ~ BRASS TUBULAR

1- 1/2"

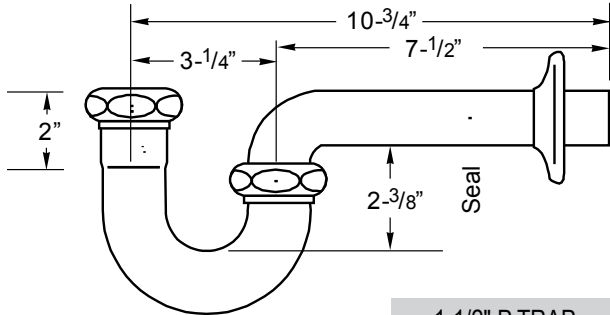

1-1/2" P TRAP
305 17GA.
304 20GA.

1- 1/4"

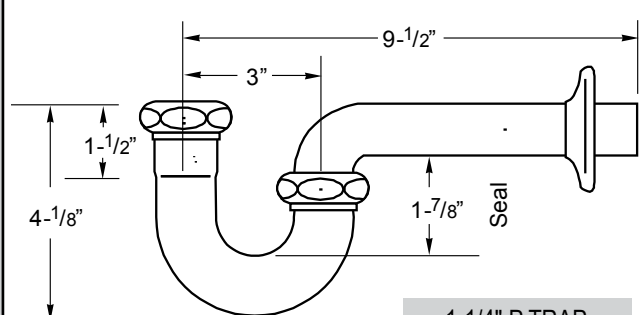

1-1/4" P TRAP
301 17GA.
300 20GA.

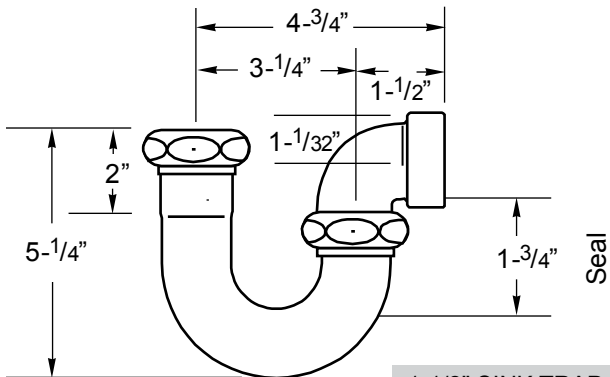

1-1/2" SINK TRAP
455 17GA.
454 20GA.

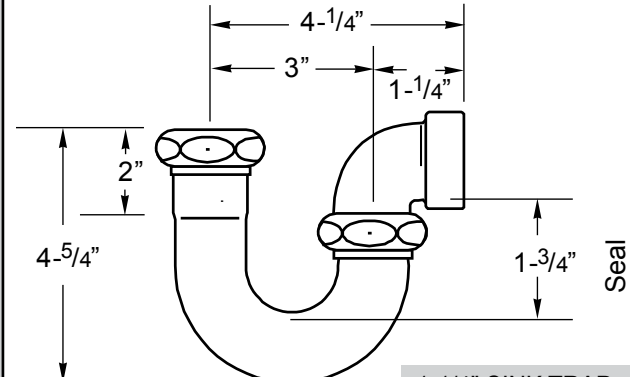

1-1/4" SINK TRAP
453 17GA.

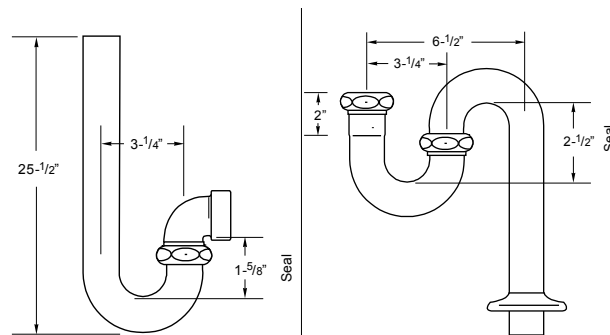

1-1/2" WASHING MACHINE TRAP
30

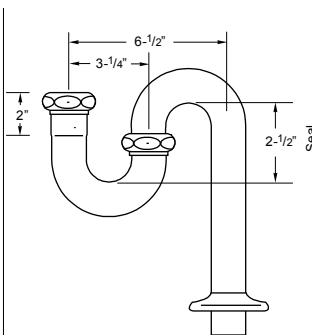



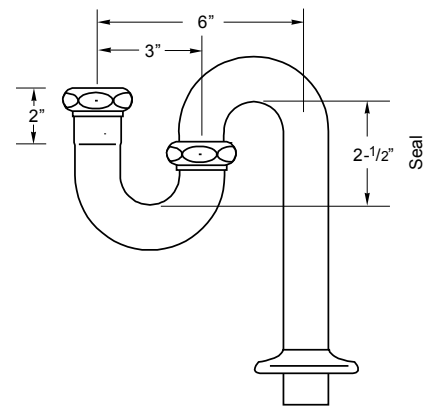

1-1/2" S TRAP
333 17GA.
332 20GA.

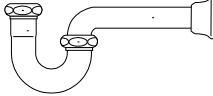

1-1/4" S TRAP
325 17GA.
324 20GA.

Part Num.	Item Description	UPC# 046224 +	Ctn Qty	Ctn Wt	Line Art
P TRAPS - LESS CLEANOUT 1 1/4" X 1 1/4"					
300CCP	22GA CHROME PLATED	71315 9	25	18 lbs.	
300CCPDF	22GA CHROME PLATED - DEEP FLANGE	72047 8	25	18 lbs.	
300CLCP	22GA CHROME PLATED WITH 12" WALL TUBE	71314 2	25	23 lbs.	
300CP	20GA CHROME PLATED	70091 3	25	23 lbs.	
300CPDF	20GA CHROME PLATED - DEEP FLANGE	92484 5	25	27 lbs.	
300CPBNDF	20GA CHROME PLATED - BRASS NUTS - DEEP FLANGE	92478 4	25	27 lbs.	
300PC	20GA POLISHED CHROME	70094 4	25	23 lbs.	
300LPC	20GA POLISHED CHROME WITH 12" WALL TUBE	71316 6	25	23 lbs.	
300PCBN	20GA POLISHED CHROME - BRASS NUTS	92492 0	25	23 lbs.	
300PCDF	20GA POLISHED CHROME - DEEP FLANGE	92494 4	25	23 lbs.	
301CP	17GA CHROME PLATED	92509 5	25	30 lbs.	
301LCP	17GA CHROME PLATED WITH 12" WALL TUBE	92515 6	25	30 lbs.	
301LLSN	17GA CHROME PLATED WITH 15" WALL TUBE	72292 2	25	30 lbs.	
301CPDF	17GA CHROME PLATED - DEEP FLANGE	92511 8	25	30 lbs.	
301CPBNDF	17GA CHROME PLATED - BRASS NUTS - DEEP FLANGE	92510 1	25	33 lbs.	
301CPBN866	17GA CHROME PLATED - BRASS NUTS - BOX FLANGE	01694 6	25	30 lbs.	
301XCP	17GA CHROME PLATED GROUND JOINT	71317 3	25	30 lbs.	
301XCPBN	17GA CHROME PLATED GROUND JOINT - BRASS NUTS	01342 6	25	30 lbs.	
301PC	17GA POLISHED CHROME	99915 7	25	30 lbs.	
301PCBN	17GA POLISHED CHROME - BRASS NUTS	99917 1	25	30 lbs.	
BRASS MASTERTRAP P TRAPS - LESS CLEANOUT - GROUND JOINT WITH INDUSTRY EXCLUSIVE DURABOND SEAL - DEEP FLANGE - CHROME PLATED					
301PXCPBNDF	1 1/4" X 1 1/4" 17GA - BRASS NUT	01007 4	25	30 lbs	
305PXCPBNDF	1 1/2" X 1 1/2" 17GA - BRASS NUT	01006 7	25	40.5 lbs	
P TRAPS - LESS CLEANOUT 1 1/4" X 1 1/4" - POLISHED BRASS					
6301	17GA DEEP FLANGE - BRASS NUTS	99900 3	25	30 lbs.	
6300	20GA DEEP FLANGE - BRASS NUTS	99901 0	25	25 lbs.	
6301PB866	17GA BOX FLANGE - BRASS NUTS	99903 4	25	30 lbs.	
P TRAPS - LESS CLEANOUT 1 1/2" X 1 1/2"					
304CRB	22GA ROUGH BRASS	92644 3	25	22 lbs.	
304CCP	22GA CHROME PLATED	71324 1	25	22 lbs.	
304CCPDF	22GA CHROME PLATED - DEEP FLANGE	72605 0	25	23 lbs.	
304CLCP	22GA CHROME PLATED WITH 12" WALL TUBE	71323 4	25	22 lbs.	
304RB	20GA ROUGH BRASS	92657 3	25	26 lbs.	
304CP	20GA CHROME PLATED	70529 1	25	26 lbs.	
304PC	20GA POLISHED CHROME	70074 6	25	26 lbs.	
305RB	17GA ROUGH BRASS	92700 6	25	38 lbs.	
305CP	17GA CHROME PLATED	92688 7	25	38 lbs.	
305LCP	17GA POLISHED CHROME WITH 12" WALL TUBE	41326 5	25	38 lbs.	
305LLSN	17GA SATIN WITH 15" WALL TUBE	92692 4	25	38 lbs.	

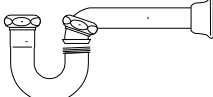

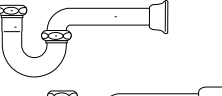
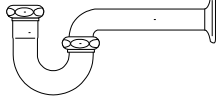
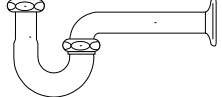
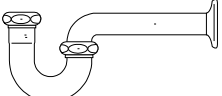
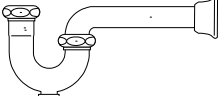
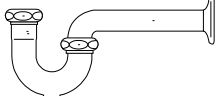
BRASS TUBULAR

Part Num.	Item Description	UPC# 046224 +	Ctn Qty	Ctn Wt	Line Art	
P TRAPS - LESS CLEANOUT 1 1/2" X 1 1/2" - CONTINUED						
305CPDF	17GA CHROME PLATED - DEEP FLANGE	92690 0	25	38 lbs.		
305CPBNDF	17GA CHROME PLATED - BRASS NUTS - DEEP FLANGE	92689 4	25	39 lbs.		
305CPBN867	17GA CHROME PLATED - BRASS NUTS - BOX FLANGE	01692 2	25	40 lbs.		
305PC	17GA POLISHED CHROME	99924 9	25	38 lbs.		
305PCDF	17GA POLISHED CHROME - DEEP FLANGE	99927 0	25	38 lbs.		
305PCBN	17GA POLISHED CHROME - BRASS NUTS	99926 3	25	38 lbs.		
305XRBBN	17GA ROUGH BRASS GROUND JOINT BRASS NUTS	 92716 7	25	38 lbs.		
305XCP	17GA CHROME PLATED GROUND JOINT	71327 2	25	38 lbs.		
305XCPBN	17GA CHROME PLATED GROUND JOINT - BRASS NUTS	72023 2	25	38 lbs.		
305XPC	17GA POLISHED CHROME GROUND JOINT	99929 4	25	38 lbs.		
305XPCBN	17GA POLISHED CHROME GROUND JOINT - BRASS NUTS	99930 0	25	38 lbs.		
305XPCBNDF	17GA POLISHED CHROME GROUND JOINT BRASS NUTS AND DEEP FLANGE	99931 7	25	38 lbs.		
P TRAPS - LESS CLEANOUT 1 1/2" X 1 1/2" - POLISHED BRASS						
6305	17GA - DEEP FLANGE - BRASS NUTS	 99905 8	25	38 lbs.		
6305PB867	17GA - BOX FLANGE - BRASS NUTS	99908 9	25	38 lbs.		
P TRAPS - LESS CLEANOUT 1 1/2" X 1 1/4" - REDUCING NUT						
308CCP	22GA CHROME PLATED	72000 3	25	25 lbs.		
308CP	20GA CHROME PLATED	72001 0	25	30 lbs.		
309CP	17GA CHROME PLATED	72002 7	25	38 lbs.		
P TRAPS - LESS CLEANOUT 1 1/2" X 1 1/4" WITH REDUCED INLET						
319CP	17GA CHROME PLATED	92773 0	25	38 lbs.		
319XCPBN	17GA CHROME PLATED GROUND JOINT - BRASS NUTS	01334 1	25	38 lbs.		
P TRAPS - WITH CLEANOUT 1 1/4" X 1 1/4"						
302CP	20GA CHROME PLATED	71318 0	25	24 lbs.		
302PC	20GA POLISHED CHROME	92537 8	25	24 lbs.		
303CP	17GA CHROME PLATED	71322 7	25	30 lbs.		
303PC	17GA POLISHED CHROME	99937 9	25	30 lbs.		
303LLPC	17GA POLISHED CHROME WITH 15" WALL TUBE	73184 9	25	35 lbs.		
303PCDF	17GA POLISHED CHROME - DEEP FLANGE	99939 3	25	30 lbs.		
303PCBN	17GA POLISHED CHROME - BRASS NUTS	99938 6	25	30 lbs.		
303CPDF	17GA CHROME PLATED - DEEP FLANGE	73152 8	25	30 lbs.		
P TRAPS - WITH CLEANOUT 1 1/2" X 1 1/2"						
306CP	20GA CHROME PLATED	71328 9	25	29 lbs.		
306CPDF	20GA POLISHED CHROME - DEEP FLANGE	01336 5	25	30 lbs.		
306PC	20GA POLISHED CHROME	70024 1	25	29 lbs.		
307CP	17GA CHROME PLATED	71329 6	25	35 lbs.		

Part Num.	Item Description	UPC# 046224 +	Ctn Qty	Ctn Wt	Line Art
P TRAPS - WITH CLEANOUT 1 1/2" X 1 1/2" - CONTINUED					
307XCPBN	17GA CHROME PLATED GROUND JOINT - BRASS NUT	01516 1	25	38 lbs.	
307PC	17GA POLISHED CHROME	99947 8	25	35 lbs.	
307LPC	17GA POLISHED CHROME WITH 12" WALL TUBE	92738 9	25	40 lbs.	
307PCDF	17GA POLISHED CHROME - DEEP FLANGE	99949 2	25	35 lbs.	
307PCBN	17GA POLISHED CHROME - BRASS NUTS	99948 5	25	35 lbs.	
P TRAPS - WITH CLEANOUT 1 1/2" X 1 1/4"					
310CP	20GA CHROME PLATED WITH REDUCING NUT	72003 4	25	50 lbs.	
310PC	20GA POLISHED CHROME WITH REDUCING NUT	92765 5	25	50 lbs.	
311PC	17GA POLISHED CHROME WITH REDUCING NUT	99959 1	25	38 lbs.	
REPAIR TRAPS - LESS CLEANOUT					
300RPC	1 1/4" X 1 1/4" 20GA POLISHED CHROME	92498 2	25	19 lbs.	
304RPC	1 1/2" X 1 1/2" 20GA POLISHED CHROME	92660 3	25	25 lbs.	
P TRAPS - LOW INLET					
291PC	1 1/4" X 1 1/4" 17GA POLISHED CHROME	92456 2	25	30 lbs.	
293PC	1 1/2" X 1 1/2" 17GA POLISHED CHROME	70093 7	25	30 lbs.	
ANTI-SIPHON P-TRAPS - ALL CAST BODY					
361XPCBNDF	1 1/4" X 1 1/4" 17GA POLISHED CHROME GROUND JOINT BRASS NUTS - DEEP FLANGE	72321 9	10	33 lbs.	
363XPCBNDF	1 1/2" X 1 1/2" 17GA POLISHED CHROME GROUND JOINT BRASS NUTS - DEEP FLANGE	70059 3	10	33 lbs.	
ANTI-SIPHON S-TRAPS - ALL CAST BODY					
367XPCBNDF	1 1/4" X 1 1/4" 17GA POLISHED CHROME GROUND JOINT BRASS NUTS - DEEP FLANGE	72323 3	1	3.12 lbs.	
369XPCBNDF	1 1/2" X 1 1/2" 17GA POLISHED CHROME GROUND JOINT BRASS NUTS - DEEP FLANGE	70059 0	1	4.30 lbs.	
INLET TUBES FOR ANTI-SIPHON TRAPS					
12360PC	1 1/4" X 6 1/2" 17GA POLISHED CHROME	91913 1	25	13 lbs.	
12362PC	1 1/2" X 6 1/2" 17GA POLISHED CHROME	91916 2	25	15 lbs.	
UTILITY P TRAPS - WITH DEEP FLANGE, MILWAUKEE STYLE 1 1/2" X 1 1/2"					
390PC	20GA POLISHED CHROME - LESS CLEANOUT BRASS NUTS	92923 9	25	43 lbs.	
397PCDC	17GA POLISHED CHROME - WITH CLEANOUT	73498 7	25	43 lbs.	
BRASS MASTERTRAP S TRAPS - LESS CLEANOUT - DEEP FLANGE - BRASS NUT GROUND JOINT WITH INDUSTRY EXCLUSIVE DURABOND SEAL					
325XPCBNDF	1 1/4" X 1 1/4" 20 1/2" 17GA CHROME PLATED	01181 1	25	53 lbs	
333XPCBNDF	1 1/2" X 1 1/2" 20 1/2" 17GA CHROME PLATED	01180 4	25	63 lbs	

BRASS TUBULAR



Part Num.	Item Description	UPC# 046224 +	Ctn Qty	Ctn Wt	Line Art
S TRAPS - LESS CLEANOUT 1 1/4" X 1 1/4"					
324CCP	20 1/2" 22GA CHROME PLATED	72006 5	25	31 lbs.	
324CP	20 1/2" 20GA CHROME PLATED	92786 0	25	36 lbs.	
325CP	20 1/2" 17GA CHROME PLATED	92802 7	25	50 lbs.	
325CPBN	20 1/2" 17GA CHROME PLATED - BRASS NUT	01521 5	25	55 lbs.	
325CPBNDF	20 1/2" 17GA CHROME PLATED BRASS NUTS - DEEP FLANGE	92803 4	25	53 lbs.	
325CPBN866	20 1/2" 17GA CHROME PLATED BRASS NUTS - BOX FLANGE	01693 9	25	55 lbs.	
S TRAPS- WITH CLEANOUT 1 1/4" X 1 1/4"					
328CPDF	17GA CHROME PLATED - DEEP FLANGE	01949 7	25	40 lbs.	
S TRAPS- LESS CLEANOUT 1 1/2" X 1 1/2"					
332CCP	20 1/2" 22GA CHROME PLATED	72009 6	25	38 lbs.	
332CP	20 1/2" 20GA CHROME PLATED	92823 2	25	40 lbs.	
332CPDF	20 1/2" 20GA CHROME PLATED - DEEP FLANGE	92828 7	25	40 lbs.	
333CP	20 1/2" 17GA CHROME PLATED	92848 5	25	60 lbs.	
333CPBNDF	20 1/2" 17GA CHROME PLATED BRASS NUTS - DEEP FLANGE	92849 2	25	63 lbs.	
333CPBN867	20 1/2" 17GA CHROME PLATED BRASS NUTS - BOX FLANGE	01691 5	25	60 lbs.	
SINK TRAPS - LESS CLEANOUT WITH CAST ELBOW-WASHER (BEADED CONNECTION) 1 1/4" X 1 1/4"					
487SN	22GA SATIN IPS	93133 1	25	22 lbs.	
SINK TRAPS - LESS CLEANOUT WITH CAST ELBOW-WASHER (BEADED CONNECTION) 1 1/2" X 1 1/2"					
488SN	22GA SATIN IPS	93136 2	25	25 lbs.	
454SN	20GA SATIN IPS	93025 9	25	27 lbs.	
455SN	17GA SATIN IPS	93039 6	25	28 lbs.	
GROUND JOINT SINK TRAPS - IPS OUTLET WITH SHALLOW FLANGE LESS CLEANOUT 1 1/2" X 1 1/2"					
454XFSN	20GA SATIN	93031 0	25	28 lbs.	
455XFSN	17GA SATIN	93044 0	25	28 lbs.	
455XFPC	17GA POLISHED CHROME	93042 6	25	28 lbs.	
GROUND JOINT SINK TRAPS - IPS OUTLET WITH SHALLOW FLANGE WITH CLEANOUT 1 1/2" X 1 1/2"					
461XFSN	17GA SATIN - IPS - BRASS NUTS	72342 4	25	30 lbs.	
461XFPC	17GA POLISHED CHROME - IPS - BRASS NUTS	99966 9	25	30 lbs.	
GROUND JOINT SINK TRAPS WITH 6" EXTENSION TUBE FOR 1 1/2" COPPER - 1 1/2" X 1 1/2"					
455XF-6PC	17GA POLISHED CHROME - LESS CLEANOUT BRASS NUTS	70351 8	25	39 lbs.	
461XF-6PC	17GA POLISHED CHROME - WITH CLEANOUT BRASS NUTS	93086 0	25	44 lbs.	

Part Num.	Item Description	UPC# 046224 +	Ctn Qty	Ctn Wt	Line Art
SINK TRAPS FOR CONNECTION TO ABS/PVC SCH 40 TUBE GROUND JOINT - 1 1/2" - BRASS NUTS					
455XPCPVC	1 1/2" 17GA POLISHED CHROME WITH PVC ADAPTER, LESS CLEANOUT, COVERING TUBE AND SHALLOW FLANGE	93049 5	25	30 lbs.	
461XPCPVC	1 1/2" 17GA POLISHED CHROME WITH PVC ADAPTER, WITH CLEANOUT COVERING TUBE AND SHALLOW FLANGE	99964 5	25	32 lbs.	
461XPBPVC	1 1/2" 17GA POLISHED BRASS WITH PVC ADAPTER, WITH CLEANOUT COVERING TUBE AND BOX FLANGE 	99911 9	25	32 lbs.	
WASHINGTON SINK TRAP - GROUND JOINT - DEEP FLANGE - BRASS NUTS - 1 1/2"					
471PC	1 1/2" 17GA CHROME PLATED - LESS CLEANOUT	93098 3	25	30 lbs.	
473PC	1 1/2" 17GA POLISHED CHROME - WITH CLEANOUT	70060 9	25	31 lbs.	
L.A. SINK TRAP - GROUND JOINT - BRASS NUTS - 1 1/2" X 1 1/4"					
451RB	17GA ROUGH BRASS 	70026 5	25	30 lbs.	
451PC	17GA POLISHED CHROME	93014 3	25	30 lbs.	
BATH TRAPS - LOW INLET - 1 1/2" X 1 1/2" - BRASS NUTS					
298SN	20GA SATIN- IPS CONNECTION	92461 6	25	24 lbs.	
299SN	17GA SATIN - IPS CONNECTION	92465 4	25	38 lbs.	
WASHING MACHINE TRAPS					
30SN	1 1/2" X 25 1/2" 22GA SATIN IPS CONNECTION	92473 9	25	50 lbs.	
62SN	1 1/2" X 25 1/2" 17GA SATIN IPS CONNECTION	93521 6	25	50 lbs.	
J BENDS - LESS CLEANOUT 1 1/4" X 1 1/4"					
10300CCP	22GA CHROME PLATED	71305 0	25	11 lbs.	
10300CP	20GA CHROME PLATED	91534 8	25	14 lbs.	
10300PC	20GA POLISHED CHROME	91540 9	25	14 lbs.	
10301CP	17GA CHROME PLATED	91546 1	25	15 lbs.	
10301PC	17GA POLISHED CHROME	70028 9	25	15 lbs.	
10301RB	17GA ROUGH BRASS	02063 9	25	15 lbs.	
J BEND - LESS CLEANOUT 1 1/2" X 1 1/2"					
10304CCP	22GA CHROME PLATED	71308 1	25	14 lbs.	
10304CP	20GA CHROME PLATED	91561 4	25	16 lbs.	
10304PC	20GA POLISHED CHROME	91567 6	25	15 lbs.	
10305CP	17GA CHROME PLATED	91575 1	25	20 lbs.	
10305PC	17GA POLISHED CHROME	91577 5	25	20 lbs.	
J BEND - WITH CLEANOUT 1 1/4" X 1 1/4"					
10302CP	20GA CHROME PLATED	71306 7	25	16 lbs.	
10303CP	17GA CHROME PLATED	71307 4	25	18 lbs.	
J BEND - WITH CLEANOUT 1 1/2" X 1 1/2"					
10306CP	20GA CHROME PLATED	71309 8	25	18 lbs.	
10307CP	17GA CHROME PLATED	71310 4	25	20 lbs.	

BRASS TUBULAR

J BENDS~SINK TRAP J BENDS

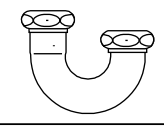
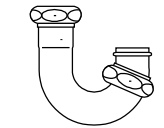
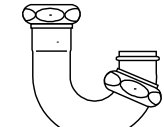
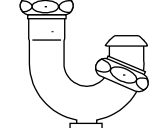
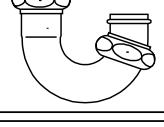
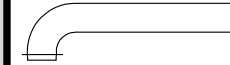
BRASS TUBULAR

Part Num.	Item Description	UPC# 046224 +	Ctn Qty	Ctn Wt	Line Art	
J BEND - LOW INLET - LESS CLEANOUT						
10291PC	1 1/4" X 1 1/4" 17GA POLISHED CHROME	91518 8	25	24 lbs.		
10293PC	1 1/2" x 1 1/2" 17GA POLISHED CHROME	91520 1	25	24 lbs.		
SINK TRAP J BENDS - LESS CLEANOUT - 1 1/4" X 1 1/4"						
10487SN	22GA SATIN	91694 9	25	13 lbs.		
10453PC	17GA POLISHED CHROME	91660 4	25	19 lbs.		
SINK TRAP J BENDS - LESS CLEANOUT - 1 1/2" X 1 1/2"						
10488SN	1 1/2" X 1 1/2" 22GA SATIN	70078 4	25	14 lbs.		
10454SN	1 1/2" X 1 1/2" 20GA SATIN	91668 0	25	16 lbs.		
10454PC	1 1/2" X 1 1/2" 20GA POLISHED CHROME	91664 2	25	16 lbs.		
10454XSN	1 1/2" X 1 1/2" 20GA SATIN GROUND JOINT	91672 7	25	16 lbs.		
10455SN	1 1/2" X 1 1/2" 17GA SATIN	91682 6	25	20 lbs.		
10455PC	1 1/2" X 1 1/2" 17GA POLISHED CHROME	91675 8	25	20 lbs.		
10455XRBBN	1 1/2" X 1 1/2" 17GA ROUGH BRASS GROUND JOINT					
	BRASS NUTS	91688 8	25	20 lbs.		
10455XSN	1 1/2" X 1 1/2" 17GA SATIN GROUND JOINT	91690 1	25	20 lbs.		
10455XPCBN	1 1/2" X 1 1/2" 17GA POLISHED CHROME GROUND JOINT					
	BRASS NUTS	72635 7	25	20 lbs.		
SINK TRAP J BEND - WITH CLEANOUT - BRASS NUTS - GROUND JOINT - 1 1/2" X 1 1/2"						
10461XPC	17GA POLISHED CHROME	71175 9	25	22 lbs.		
SINK TRAP J BENDS LOW INLET - 1 1/2" X 1 1/2" - LESS CLEANOUT						
10298SN	20GA SATIN	91523 2	25	12 lbs.		
10299SNBN	17GA SATIN - BRASS NUT	91527 0	25	16 lbs.		
WALLBENDS - 1 1/4"						
30300CCP	22GA CHROME PLATED	72301 1	25	13 lbs.		
30300LCCP	12" 22GA CHROME PLATED	71319 7	25	10 lbs.		
30300CP	20GA CHROME PLATED	72577 0	25	13 lbs.		
30300PC	20GA POLISHED CHROME	92569 9	25	13 lbs.		
30300LCP	12" 20GA CHROME PLATED	72307 3	25	13 lbs.		
30300L15PC	15" 20GA POLISHED CHROME	92567 5	25	14 lbs.		
30301CP	17GA CHROME PLATED	72304 2	25	15 lbs.		
30301PC	17GA POLISHED CHROME	92581 1	25	15 lbs.		
30301LCP	12" 17GA CHROME PLATED	72310 3	25	17 lbs.		
30301L15PC	15" 17GA POLISHED CHROME	72578 7	25	30 lbs.		
WALLBENDS - 1 1/2"						
30304CCP	22GA CHROME PLATED	71320 3	25	12 lbs.		
30304LCCP	12" 22GA CHROME PLATED	71321 0	25	13 lbs.		
30304PC	20GA POLISHED CHROME	92602 3	25	15 lbs.		
30304LCP	12" 20GA CHROME PLATED	72308 0	25	14 lbs.		



Part Num.	Item Description	UPC# 046224 +	Ctn Qty	Ctn Wt	Line Art
WALLBENDS - 1 1/2" - CONTINUED					
30305PC	17GA POLISHED CHROME	30305 3	25	20 lbs.	
30305LPC	12" 17GA POLISHED CHROME	92606 1	25	23 lbs.	
30305L15CP	15" 17GA CHROME PLATED	72559 6	25	30 lbs.	
30305L15PC	15" 17GA POLISHED CHROME	92609 2	25	30 lbs.	
REPLACEMENT ELBOWS FOR REPAIR TRAPS - 1 1/4"					
10897PC	20GA POLISHED CHROME	91787 8	25	10 lbs.	
REPLACEMENT ELBOWS FOR REPAIR TRAPS - 1 1/2"					
10898PC	20GA POLISHED CHROME	91789 2	25	11 lbs.	
FLOOR TUBES - 1 1/4"					
30324CCP	20 1/2" 22GA CHROME PLATED	72044 7	25	23 lbs.	
30324CP	20 1/2" 20GA CHROME PLATED	92627 6	25	26 lbs.	
30325PC	20 1/2" 17GA POLISHED CHROME	70473 7	25	34 lbs.	
FLOOR TUBES - 1 1/2"					
30332CP	20 1/2" 20GA CHROME PLATED	72316 5	25	30 lbs.	
30333PC	20 1/2" 17GA POLISHED CHROME	70575 8	25	40 lbs.	
CONTINUOUS WASTE - END OUTLET SLIP JOINT - CAST TEE					
4815SN	1 1/2" X 16" 22GA SATIN	70085 2	25	39 lbs.	
4815SNBN	1 1/2" X 16" 22GA SATIN - BRASS NUTS		25	39 lbs.	
4813SN	1 1/2" X 21" 22 GA SATIN	93116 4	25	44 lbs.	
1815SN	1 1/2" X 16" 20GA SATIN	92188 2	25	45 lbs.	
1813SN	1 1/2" X 21" 20GA SATIN	92168 4	25	50 lbs.	
4817RB	1 1/2" X 16" 20GA ROUGH BRASS LA STYLE WITH BAFFLE TEE - BRASS NUTS	70084 5	25	58 lbs.	
4817SN	1 1/2" X 16" 20GA SATIN LA STYLE WITH BAFFLE TEE - BRASS NUTS	 93132 4	25	58 lbs.	
1816SN	1 1/2" X 16" 17GA SATIN	92201 8	25	50 lbs.	
1814SN	1 1/2" X 21" 17GA SATIN	92175 2	25	56 lbs.	
CONTINUOUS WASTE - END OUTLET DIRECT CONNECT - CAST TEE					
4815ASN	1 1/2" X 16" 22GA SATIN	93122 5	25	34 lbs.	
4813ASN	1 1/2" X 21" 22GA SATIN	93112 6	25	39 lbs.	
1815ASN	1 1/2" X 16" 20GA SATIN	92180 6	25	40 lbs.	
1813ASN	1 1/2" X 21" 20GA SATIN	92164 6	25	43 lbs.	
1816ASN	1 1/2" X 16" 17GA SATIN	92195 0	25	50 lbs.	
1814ASN	1 1/2" X 21" 17GA SATIN	92172 1	25	56 lbs.	

BRASS TUBULAR



BRASS TUBULAR

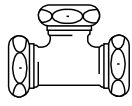
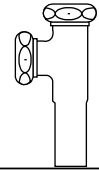

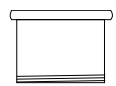
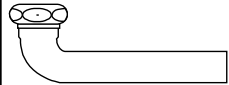
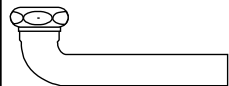
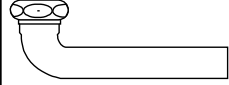
Part Num.	Item Description	UPC# 046224 +	Ctn Qty	Ctn Wt	Line Art
CONTINUOUS WASTE - CENTER OUTLET SLIP JOINT - CAST TEE					
4568SN	1 1/2" X 16" 22GA SATIN	71182 7	25	45 lbs.	
4566SN	1 1/2" X 21" 22GA SATIN	93065 5	25	45 lbs.	
1568SN	1 1/2" X 16" 20GA SATIN	92085 4	25	45 lbs.	
1566SN	1 1/2" X 21" 20GA SATIN	92073 1	25	50 lbs.	
1569SN	1 1/2" X 16" 17GA SATIN	92092 2	25	53 lbs.	
1567SN	1 1/2" X 21" 17GA SATIN	92076 2	25	55 lbs.	
CONTINUOUS WASTES - CENTER OUTLET DIRECT CONNECT - CAST TEE					
4568ASN	1 1/2" X 16" 22GA SATIN	93069 3	25	40 lbs.	
4566ASN	1 1/2" X 21" 22GA SATIN	93061 7	25	45 lbs.	
1568ASN	1 1/2" X 16" 20GA SATIN	92080 9	25	45 lbs.	
1566ASN	1 1/2" X 21" 20GA SATIN	92070 0	25	48 lbs.	
1569ASN	1 1/2" X 16" 17GA SATIN	92088 5	25	48 lbs.	
CONTINUOUS WASTE - WROUGHT TEE CENTER OUTLET - SLIP JOINT					
4568TTSN	1 1/2" X 16" 22GA SATIN	93076 1	25	35 lbs.	
CONTINUOUS WASTE WROUGHT TEE CENTER OUTLET - DIRECT CONNECT					
4568ATTSN	1 1/2" X 16" 22GA SATIN	93071 6	25	35 lbs.	
CONTINUOUS WASTE WROUGHT TEE END OUTLET - SLIP JOINT					
4815TTSN	1 1/2" X 16" 22GA SATIN	93131 7	25	31 lbs.	
CONTINUOUS WASTE - END OUTLET TRIPLE BOWL					
1560SN	1 1/2" X 24" 20GA SLIP JOINT	70001 2	25	59 lbs.	
1533SN	1 1/2" X 30" 22GA SLIP JOINT	01655 7	1	5 lbs.	
DISPOSER KIT WITH BAFFLE					
535SN	1 1/2" X 13" 20GA SATIN	70029 6	25	46 lbs.	
536SN	1 1/2" X 13" 17GA SATIN	93281 9	25	50 lbs.	
DISPOSER ELBOW					
30307CP	2" FLANGED 22GA - CHROME PLATED	01634 2	25	12 lbs.	
CAST TEES WITH TAILPIECE, NUTS AND WASHERS - CENTER OUTLET - 1 1/2"					
538SN	SATIN - SLIP JOINT	93287 1	6	6 lbs.	
538BSN	SATIN - SLIP JOINT WITH BAFFLE	93283 3	6	5 lbs.	
CAST TEES WITH TAILPIECE, NUTS AND WASHERS - END OUTLET - 1 1/2"					
540SN	SATIN SLIP JOINT	93313 7	12	5 lbs.	
540BSN	SATIN SLIP JOINT WITH BAFFLE	93306 9	12	5 lbs.	
540ASN	SATIN DIRECT CONNECT	93301 4	12	5 lbs.	

Part Num.	Item Description	UPC# 046224 +	Ctn Qty	Ctn Wt	Line Art
3 WAY OUTLET					
541SN	1 1/2" CAST SATIN 3 WAY SLIP TEE	93321 2	6	6 lbs.	
WROUGHT TEES-WITH TAILPIECE - END OUTLET					
540TTSN	1 1/2" SATIN SLIP JOINT	93318 2	6	3 lbs.	
540ATTSN	1 1/2" SATIN DIRECT CONNECT	93303 8	6	3 lbs.	
HI-WAY INSERT TAILPIECE - FLANGED - THREADED ONE END					
601815ASN	1 1/2" X 1" SATIN	93427 1	6	1 lbs.	
WASTE ARMS SLIP JOINT - 1 1/2" - BULK PACKED					
2517RB	7" 22GA ROUGH BRASS	92385 5	25	9 lbs.	
2517SN	7" 22GA SATIN	92386 2	25	9 lbs.	
2518RB	9 1/2" 22GA ROUGH BRASS	92393 0	25	11 lbs.	
2518SN	9 1/2" 22GA SATIN	92394 7	25	11 lbs.	
2519RB	11 1/2" 22GA ROUGH BRASS	92398 5	25	12 lbs.	
2519SN	11 1/2" 22GA SATIN	92400 5	25	12 lbs.	
2521RB	15" 22GA ROUGH BRASS	92409 8	25	15 lbs.	
2521SN	15" 22GA SATIN	92412 8	25	15 lbs.	
2522RB	20" 22GA ROUGH BRASS	92420 3	25	19 lbs.	
2522SN	20" 22GA SATIN	92422 7	25	19 lbs.	
2523RB	24" 22GA ROUGH BRASS	92426 5	25	21 lbs.	
2523SN	24" 22GA SATIN	92428 9	25	21 lbs.	
2524RB	29" 22GA ROUGH BRASS	92431 9	25	26 lbs.	
2524SN	29" 22GA SATIN	92433 3	25	26 lbs.	
2527SN	36" 22GA SATIN	01663 2	25	28 lbs.	
517RB	7" 20GA ROUGH BRASS	72384 4	25	12 lbs.	
517SN	7" 20GA SATIN	93203 1	25	12 lbs.	
518RB	9 1/2" 20GA ROUGH BRASS	94028 9	25	15 lbs.	
519RB	11 1/2" 20GA ROUGH BRASS	93214 7	25	16 lbs.	
519SN	11 1/2" 20GA SATIN	93217 8	25	16 lbs.	
521RB	15" 20GA ROUGH BRASS	93225 3	25	20 lbs.	
521SN	15" 20GA SATIN	93228 4	25	20 lbs.	
522RB	20" 20GA ROUGH BRASS	93235 2	25	25 lbs.	
522SN	20" 20GA SATIN	93238 3	25	25 lbs.	
523RB	24" 20GA ROUGH BRASS	93244 4	25	30 lbs.	
523SN	24" 20GA SATIN	93247 5	25	30 lbs.	
542SN	7" 17GA SATIN	93328 1	25	13 lbs.	
543SN	9 1/2" 17GA SATIN	93333 5	25	15 lbs.	
544SN	11 1/2" 17GA SATIN	00544 5	25	20 lbs.	
546SN	15" 17GA SATIN	93353 3	25	23 lbs.	
547SN	20" 17GA SATIN	93364 9	25	28 lbs.	
548SN	24" 17GA SATIN	93374 8	25	33 lbs.	
584SN	48" 17GA SATIN	02101 8	20	65 lbs.	

BRASS TUBULAR

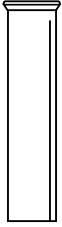

BRASS TUBULAR

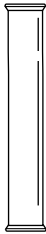
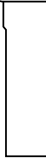
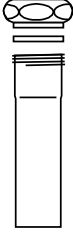
Part Num.	Item Description	UPC# 046224 +	Ctn Qty	Ctn Wt	Line Art
WASTE ARMS DIRECT CONNECT - 1 1/2" - BULK PACK					
2517ARB	7" 22GA ROUGH BRASS	92380 0	25	7 lbs.	
2517ASN	7" 22GA SATIN	92381 7	25	7 lbs.	
2518ARB	9 1/2" 22GA ROUGH BRASS	92389 3	25	9 lbs.	
2518ASN	9 1/2" 22GA SATIN	92390 9	25	9 lbs.	
2519ARB	11 1/2" 22GA ROUGH BRASS	92395 4	25	10 lbs.	
2519ASN	11 1/2" 22GA SATIN	92396 1	25	10 lbs.	
2521ARB	15" 22GA ROUGH BRASS	92402 9	25	12 lbs.	
2521ASN	15" 22GA SATIN	92403 6	25	12 lbs.	
2522ARB	20" 22GA ROUGH BRASS	92416 6	25	16 lbs.	
2522ASN	20" 22GA SATIN	92418 0	25	16 lbs.	
2523ARB	24" 22GA ROUGH BRASS	92424 1	25	20 lbs.	
2523ASN	24" 22GA SATIN	92425 8	25	20 lbs.	
WASTE ARMS DIRECT CONNECT - 2" - BULK PACK					
517ASN	7" 20GA SATIN	93199 7	25	8 lbs.	
518ASN	9 1/2" 20GA SATIN	93206 2	25	10 lbs.	
519ASN	11 1/2" 20GA SATIN	93212 3	25	13 lbs.	
521ASN	15" 20GA SATIN	93223 9	25	18 lbs.	
522ASN	20" 20GA SATIN	93233 8	25	20 lbs.	
523ASN	24" 20GA SATIN	93242 0	25	30 lbs.	
542ASN	7" 17GA SATIN	93325 0	25	13 lbs.	
543ASN	9 1/2" 17GA SATIN	93330 4	25	15 lbs.	
544ASN	11 1/2" 17GA SATIN	93338 0	25	18 lbs.	
546ASN	15" 17GA SATIN	93347 2	25	20 lbs.	
548ASN	24" 17GA SATIN	93370 0	25	33 lbs.	
DOUBLE END WASTE ARM - SLIP JOINT AND DIRECT CONNECT					
2525RB	1 1/2" X 24" DOUBLE END 22GA ROUGH BRASS	73787 2	25	26 lbs.	
SINK TAILPIECES - 1 1/4"					
160PC	4" 22GA CHROME	92099 1	24	2 lbs.	
161PC	6" 22GA CHROME	92100 4	24	3 lbs.	
161RB	6" 22GA ROUGH BRASS	01504 8	24	3 lbs.	
162PC	8" 22GA CHROME	92103 5	24	4 lbs.	
118PC	12" 22GA CHROME	72391 2	24	7 lbs.	
139PC	8" 17GA CHROME	01068 5	24	7 lbs.	
SINK TAILPIECES - 1 1/2"					
110RB	4" 22GA ROUGH BRASS	91799 1	48	6 lbs.	
110PC	4" 22GA CHROME	91796 0	48	6 lbs.	
111RB	6" 22GA ROUGH BRASS	91806 6	24	5 lbs.	
111PC	6" 22GA CHROME	91803 5	24	5 lbs.	
112RB	8" 22GA ROUGH BRASS	91812 7	24	6 lbs.	
112PC	8" 22GA CHROME	91808 0	24	6 lbs.	
113PC	10" 22GA CHROME	91819 6	24	8 lbs.	
114RB	12" 22GA ROUGH BRASS	91826 4	24	9 lbs.	

Part Num.	Item Description	UPC# 046224 +	Ctn Qty	Ctn Wt	Line Art
SINK TAILPIECES - 1 1/2" - CONTINUED					
114PC	12" 22GA CHROME	91822 6	24	9 lbs.	
120PC	18" 22GA CHROME	91877 6	24	14 lbs.	
210RB	4" 20GA ROUGH BRASS	92292 6	48	9 lbs.	
210PC	4" 20GA CHROME	92289 6	48	9 lbs.	
211RB	6" 20GA ROUGH BRASS	92296 4	24	6 lbs.	
211PC	6" 20GA CHROME	92294 0	24	6 lbs.	
212RB	8" 20GA ROUGH BRASS	92302 2	24	9 lbs.	
212PC	8" 20GA CHROME	92300 8	24	9 lbs.	
214RB	12" 20GA ROUGH BRASS	92312 1	24	13 lbs.	
214PC	12" 20GA CHROME	92309 1	24	13 lbs.	
140RB	4" 17GA ROUGH BRASS	92024 3	48	10 lbs.	
140PC	4" 17GA CHROME	92022 9	48	10 lbs.	
141RB	6" 17GA ROUGH BRASS	92028 1	24	9 lbs.	
141PC	6" 17GA CHROME	92026 7	24	9 lbs.	
142RB	8" 17GA ROUGH BRASS	92031 1	24	12 lbs.	
142PC	8" 17GA CHROME	92029 8	24	12 lbs.	
144RB	12" 17GA ROUGH BRASS	92049 6	24	17 lbs.	
144PC	12" 17GA CHROME	92047 2	24	17 lbs.	
SINK TAILPIECES - 2"					
153PC	6" 17GA CHROME	71076 9	25	13 lbs.	
154PC	8" 17GA CHROME	71005 9	25	17 lbs.	
155PC	12" 17GA CHROME	71006 6	25	20 lbs.	
SINK TAILPIECES - DOUBLE END FLANGED - 1 1/2"					
1149PC	12" 22GA CHROME	91830 1	24	7 lbs.	
1148PC	16" 22GA CHROME	91827 1	24	12 lbs.	
2149PC	12" 20GA CHROME	92317 6	24	16 lbs.	
2148PC	16" 20GA CHROME	92314 5	24	16 lbs.	
7149PC	12" 17GA CHROME	93712 8	24	19 lbs.	
7148PC	16" 17GA CHROME	93709 8	24	19 lbs.	
SINK TAILPIECES - REDUCING					
117PC	1 1/2" X 1 1/4" X 8" 22GA CHROME	91858 5	24	5 lbs.	
217PC	1 1/2" X 1 1/4" X 8" 20GA CHROME	92318 3	24	7 lbs.	
147PC	1 1/2" X 1 1/4" X 8" 17GA CHROME	92052 6	24	10 lbs.	
EXTENSION TUBES - SLIP JOINT - 1 1/4"					
1901PC	6" 22GA CHROME	92227 8	24	6 lbs.	
1669PC	8" 22GA CHROME	92104 2	24	7 lbs.	
1669PCBN	8" 22GA CHROME - BRASS NUT	92105 9	24	9 lbs.	
1903PC	12" 22GA CHROME	92231 5	24	9 lbs.	
235PC	6" 20 GA CHROME	92353 4	24	7 lbs.	
236PC	8" 20 GA CHROME	92355 8	24	9 lbs.	
238PC	12" 20GA CHROME	92358 9	24	12 lbs.	



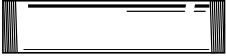
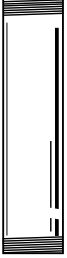
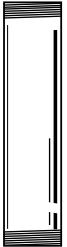

BRASS TUBULAR

Part Num.	Item Description	UPC# 046224 +	Ctn Qty	Ctn Wt	Line Art
EXTENSION TUBES - SLIP JOINT - 1 1/4" - CONTINUED					
7901PC	6" 17GA CHROME	93763 0	24	10 lbs.	
7669PC	8" 17GA CHROME	93735 7	24	12 lbs.	
7903PC	12" 17GA CHROME	93765 4	24	16 lbs.	
EXTENSION TUBES - SLIP JOINT - DOUBLE END - 1 1/4"					
1907PC	16" 22GA CHROME DOUBLE END	92246 9	24	15 lbs.	
1910PC	16" 20GA CHROME DOUBLE END	92258 2	25	19 lbs.	
1910RBBN	16" 20GA ROUGH BRASS DOUBLE END	01509 3	24	5 lbs.	
1977PC	16" 17GA CHROME DOUBLE END	92261 2	25	20 lbs.	
EXTENSION TUBES - SLIP JOINT - 1 1/2"					
1904PC	6" 22GA CHROME	92235 3	24	6 lbs.	
1904PCBN	6" 22GA CHROME - BRASS NUT	02198 8	24	6 lbs.	
1670PC	8" 22GA CHROME	92108 0	24	8 lbs.	
1670PCBN	8" 22GA CHROME - BRASS NUT		24	10 lbs.	
1906RB	12" 22GA ROUGH BRASS	92244 5	24	11 lbs.	
1906PC	12" 22GA CHROME	92240 7	24	11 lbs.	
231PC	6" 20GA CHROME	92341 1	24	7 lbs.	
232PC	8" 20GA CHROME	92344 2	24	11 lbs.	
234PC	12" 20GA CHROME	92348 0	24	15 lbs.	
7904PC	6" 17GA CHROME	93768 5	24	12 lbs.	
7670PC	8" 17GA CHROME	93739 5	24	14 lbs.	
7906RB	12" 17GA ROUGH BRASS	93773 9	24	19 lbs.	
7906RBBN	12" 17GA ROUGH BRASS - BRASS NUT	93774 6	24	19 lbs.	
7906PC	12" 17GA CHROME	93769 2	24	19 lbs.	
EXTENSION TUBES - SLIP JOINT - DOUBLE END - 1 1/2"					
1908PC	16" 22GA CHROME	92249 0	24	16 lbs.	
1909PC	16" 20GA CHROME	92254 4	25	18 lbs.	
1978PC	16" 17GA CHROME	92262 9	25	20 lbs.	
STRAIGHT BASIN WASTE - 1 1/4"					
757PC	24" 17GA CHROME	93726 5	25	31 lbs.	
STRAIGHT BASIN WASTE - 1 1/2"					
758PC	24" 17GA CHROME	93728 9	25	34 lbs.	
EXTENSION TUBES TO SOLDER - 1 1/4"					
126PC	6" 22GA CHROME	91962 9	24	5 lbs.	
127PC	8" 22GA CHROME	91968 1	24	5 lbs.	
129PC	12" 22GA CHROME	91975 9	24	7 lbs.	
227PC	8" 20GA CHROME	92335 0	24	7 lbs.	
229PC	12" 20GA CHROME	92338 1	24	12 lbs.	

Part Num.	Item Description	UPC# 046224 +	Ctn Qty	Ctn Wt	Line Art
EXTENSION TUBES TO SOLDER - 1 1/4" - CONTINUED					
1267PC	6" 17GA CHROME	91966 7	24	7 lbs.	
1277PC	8" 17GA CHROME	91971 1	24	10 lbs.	
1297PC	12" 17GA CHROME	91979 7	24	14 lbs.	
EXTENSION TUBES TO SOLDER - 1 1/2"					
121PC	6" 22GA CHROME	91889 9	24	5 lbs.	
122PC	8" 22GA CHROME	91903 2	24	6 lbs.	
124PC	12" 22GA CHROME	91919 3	24	9 lbs.	
221PC	6" 20GA CHROME	92323 7	24	6 lbs.	
222PC	8" 20GA CHROME	92327 5	24	8 lbs.	
224PC	12" 20GA CHROME	92331 2	24	13 lbs.	
1217PC	6" 17GA CHROME	91900 1	24	7 lbs.	
1227PC	8" 17GA CHROME	91910 0	24	12 lbs.	
1247PC	12" 17GA CHROME	91922 3	24	15 lbs.	
THREADED TUBES - THREADED BOTH ENDS - 1 3/8"					
1162RB	12" 20GA ROUGH BRASS	91844 8	24	12 lbs.	
1162PC	12" 20GA CHROME	91842 4	24	12 lbs.	
THREADED TUBES - THREADED BOTH ENDS - 1 1/4"					
1120PC	6" 20GA CHROME	91813 4	24	5 lbs.	
1160RB	8" 20GA ROUGH BRASS	70553 6	24	7 lbs.	
1160PC	8" 20GA CHROME	91835 6	24	7 lbs.	
1161RB	12" 20GA ROUGH BRASS	91841 7	24	11 lbs.	
1161PC	12" 20GA CHROME	91838 7	24	11 lbs.	
1771PC	6" 17GA CHROME	92134 9	24	7 lbs.	
1772PC	8" 17GA CHROME	92135 6	24	10 lbs.	
1773PC	12" 17GA CHROME	92138 7	24	14 lbs.	
1774PC	18" 17GA CHROME	70724 0	24	14 lbs.	
THREADED TUBES - THREADED BOTH ENDS - 1 1/2"					
1122RB	6" 20GA ROUGH BRASS	91818 9	24	6 lbs.	
1122PC	6" 20GA CHROME	91815 8	24	6 lbs.	
1163RB	8" 20GA ROUGH BRASS	91847 9	24	7 lbs.	
1163PC	8" 20GA CHROME	91845 5	24	7 lbs.	
1164RB	12" 20GA ROUGH BRASS	91852 3	24	14 lbs.	
1164PC	12" 20GA CHROME	91848 6	24	14 lbs.	
1776RB	12" 17GA ROUGH BRASS	92149 3	24	18 lbs.	
1776PC	12" 17GA CHROME	92146 2	24	18 lbs.	
1779RB	18" 17GA ROUGH BRASS	92154 7	24	24 lbs.	
1779PC	18" 17GA CHROME	92153 0	24	24 lbs.	



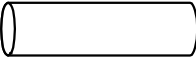
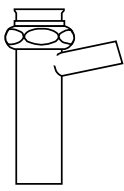
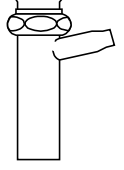
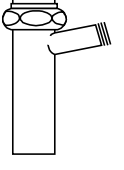
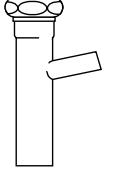
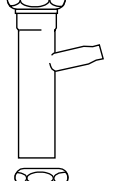
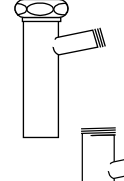

BRASS TUBULAR

BRASS TUBULAR

Part Num.	Item Description	UPC# 046224 +	Ctn Qty	Ctn Wt	Line Art
THREADED TUBES - THREADED ONE END - 1 1/4"					
2119PC	8" 17GA CHROME	70393 8	24	10 lbs.	
THREADED TUBES - THREADED ONE END - 1 1/2" X 1 1/4"					
1159PC	8" 20GA POLISHED CHROME - REDUCING	91832 5	24	8 lbs.	
TUBING - 1 1/2" X 2'					
1210PC	20GA POLISHED CHROME	00935 1	12	13 lbs.	
BRANCH TAILPIECES - 3/4" BRANCH (7/8" OD) PLAIN END - BRASS NUT FOR RUBBER HOSE AND CLAMP OR 3/4" SWEAT CONNECTION - DIRECT CONNECT					
48SN	1 1/2" X 6" 22GA. SATIN	93107 2	25	9 lbs.	
49SN	1 1/2" X 8" 22GA. SATIN	93148 5	25	13 lbs.	
47SN	1 1/2" X 8" 17GA SATIN	93095 2	25	13 lbs.	
51RB	1 1/2" X 12" 22GA ROUGH BRASS	10051 5	25	18 lbs.	
51SN	1 1/2" X 12" 22GA SATIN	72525 1	25	18 lbs.	
BRANCH TAILPIECES - 1/2" COPPER TUBE SWEAT CONNECTION - DIRECT CONNECT					
48SSN	1 1/2" X 6" 22GA. SATIN - BRASS NUT	93109 6	25	9 lbs.	
49SRB	1 1/2" X 8" 22GA. ROUGH BRASS - BRASS NUT	93152 2	25	13 lbs.	
49SSN	1 1/2" X 8" 22GA. SATIN - BRASS NUT	93156 0	25	13 lbs.	
47SSN	1 1/2" X 8" 17GA SATIN - BRASS NUT	93096 9	25	13 lbs.	
BRANCH TAILPIECE 3/4" THREADED HOSE CONNECTION OR 1/2" COPPER TUBE - DIRECT CONNECT					
49RSN	1 1/2" X 8" 22GA. SATIN - BRASS NUT	93145 4	25	14 lbs.	
BRANCH TAILPIECES - 3/4" BRANCH (7/8" OD) PLAIN END FOR RUBBER HOSE AND CLAMP OR 3/4" SWEAT CONNECTION - SLIP JOINT					
54RB	1 1/2" X 8" 22GA. ROUGH BRASS - PLAIN END BRANCH FOR HOSE CLAMP OR SWEAT	93290 1	25	13 lbs.	
54SN	1 1/2" X 8" 22GA. SATIN - PLAIN END BRANCH FOR HOSE CLAMP OR SWEAT	93293 2	25	13 lbs.	
BRANCH TAILPIECE 1/2" COPPER TUBE SWEAT CONNECTION - SLIP JOINT					
54SSN	1 1/2" X 8" 22GA. SATIN SLIP JOINT -1/2" COPPER TUBE SWEAT	93297 0	25	13 lbs.	
BRANCH TAILPIECE 1/2" COPPER TUBE OR 3/4" THREADED HOSE CONNECTION - SLIP JOINT					
54RSN	1 1/2" X 8" 22GA. SATIN - SLIP JOINT	93292 5	25	14 lbs.	
BRANCH TAILPIECES - 3/4" BRANCH (7/8" O.D.) PLAIN END - T.O.E.					
50SN	1 1/4" X 6" 22GA SATIN - HOSE CLAMP T.O.E.	70543 7	25	18 lbs.	

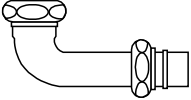
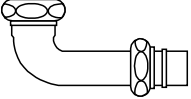
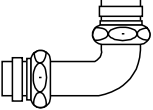
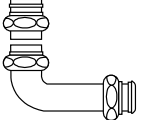
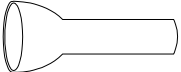

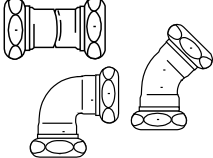
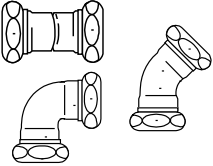
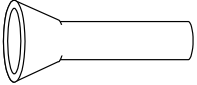



Part Num.	Item Description	UPC# 046224 +	Ctn Qty	Ctn Wt	Line Art
BRANCH TAILPIECES 1/2" COPPER TUBE SWEAT - T.O.E.					
53SSN	1 1/2" X 8" 22GA. SATIN	93259 8	25	13 lbs.	
BRANCH TAILPIECES 1/2" COPPER TUBE OR 3/4" THREADED HOSE - T.O.E.					
53RSN	1 1/2" X 8" 22GA. SATIN	93255 0	25	13 lbs.	
LONG NECK BRANCH TAILPIECE 5/16" OD - 1 1/2" - DIRECT CONNECT					
44RB	12" 22GA ROUGH BRASS - BRASS NUT	93006 8	25	14 lbs.	
41RB	12" 20GA ROUGH BRASS - BRASS NUT	92994 9	25	15 lbs.	
P.O. PLUGS - ONE PIECE P.O. PLUGS - 1 1/4"					
1681PC	5" 22GA POLISHED CHROME	92114 1	25	12 lbs.	
1682PC	6" 22GA POLISHED CHROME	72432 2	25	12 lbs.	
1683PC	8" 22GA POLISHED CHROME	92118 9	25	12 lbs.	
1685PC	12" 22GA POLISHED CHROME	92123 3	25	15 lbs.	
P O PLUGS - TWO-PIECE P.O. PLUGS - 1 1/4"					
1061PC	5" 22GA POLISHED CHROME	91746 5	25	9 lbs.	
1063PC	8" 22GA POLISHED CHROME	91748 9	25	12 lbs.	
1065PC	12" 22GA POLISHED CHROME	91751 9	25	15 lbs.	
1680-2PC	8" 20GA POLISHED CHROME	92113 4	25	39 lbs.	
1614PC	8" 17GA POLISHED CHROME	92101 1	25	20 lbs.	
3-PIECE P.O. PLUG CAST BRASS					
1695PC	3-PIECE P.O. PLUG CAST BRASS	72119 2	25	6 lbs.	
C.O. PLUG - ONE PIECE - 1 1/4"					
681PC	5" 22GA POLISHED CHROME - LESS OVERFLOW	93658 9	25	9 lbs.	
MECHANICAL POP-UP WITH 4" TAILPIECE - TWO PIECE - 1 1/4"					
1688PCBAG	POLISHED CHROME - BAGGED	01518 5	25	26 lbs.	
DOUBLE OFFSET - 1 PIECE - 1 1/4" X 1 1/4"					
1037RB	22GA ROUGH BRASS	91615 4	25	25 lbs.	
1037PC	22GA CHROME	91611 6	25	25 lbs.	
7037PC	17GA CHROME	93681 7	25	30 lbs.	
DOUBLE OFFSET - 1 1/2" X 1 1/2"					
1038RB	22GA ROUGH BRASS	91621 5	25	28 lbs.	
1038PC	22GA CHROME	91617 8	25	28 lbs.	
7038PC	17GA CHROME	93683 1	25	33 lbs.	
DOUBLE OFFSET - 2" X 1 1/2"					
7039PC	6" 17GA CHROME	01338 9	25	33 lbs.	



BRASS TUBULAR

Part Num.	Item Description	UPC# 046224 +	Ctn Qty	Ctn Wt	Line Art
SLIP JOINT ELBOWS - NUTS AND WASHERS - 1 1/4"					
900RB	4" 22GA ROUGH BRASS	93893 4	25	8 lbs.	
900PC	4" 22GA CHROME	93892 7	25	8 lbs.	
901RB	6" 22GA ROUGH BRASS	93896 5	25	10 lbs.	
901PC	6" 22GA CHROME	93894 1	25	10 lbs.	
902RB	8" 22GA ROUGH BRASS	70302 0	25	11 lbs.	
902PC	8" 22GA CHROME	93898 9	25	11 lbs.	
903LRB	12" 22GA ROUGH BRASS	93901 6	25	16 lbs.	
903LPC	12" 22GA CHROME	93899 6	25	16 lbs.	
SLIP JOINT ELBOWS - 1 1/2"					
906RB	7" 22GA ROUGH BRASS	72017 1	25	11 lbs.	
906PC	7" 22GA CHROME	72438 4	25	11 lbs.	
TANK ELBOWS - NUTS AND WASHERS					
775NPC	2" X 4" X 6" 22GA CHROME	93748 7	25	19 lbs.	
777NPC	2" X 5" X 7" 22GA CHROME	93751 7	25	21 lbs.	
779NPC	2" X 6" X 8" 22GA CHROME	93756 2	25	24 lbs.	
REPAIR TANK ELBOW - NUTS AND WASHERS					
772NPC	2" X 6" X 8" 22GA CHROME	70023 4	25	25 lbs.	
COVERING TUBES					
1041PC	WIDE BELL FLANGE - 2" X 6" POLISHED CHROME	91653 6	12	4 lbs.	
1045PC	COVERING TUBE 2" X 6" POLISHED CHROME FOR ABS/PVC SINK TRAPS	91657 4	25	11 lbs.	
REPAIR COUPLING - NUTS AND WASHERS - 1 1/4" X 1 1/4"					
669PC	CHROME STRAIGHT	93623 7	25	6 lbs.	
671PC	45° CHROME	93639 8	25	12 lbs.	
673PC	90° CHROME	93646 6	25	9 lbs.	
REPAIR COUPLING - NUTS AND WASHERS - 1 1/2" X 1 1/2"					
670PC	CHROME STRAIGHT	93634 3	25	7 lbs.	
672PC	45° POLISHED CHROME	93642 8	25	9 lbs.	
674PC	90° CHROME	93649 7	25	9 lbs.	
SINK FUNNEL					
1172SN	1 1/2" X 8" 22GA SATIN	91860 8	12	5 lbs.	
WASTE CONNECTIONS - GROUND JOINT WITH FRICTION RING AND CHROME NUT - 1 1/4"					
1186RB	1 1/4" SPS X 1 1/4" OD ROUGH BRASS - MALE	91863 9	10	3 lbs.	
1190RB	1 1/4" SPS X 1 1/4" OD ROUGH BRASS - FEMALE	91868 4	10	3 lbs.	

Part Num.	Item Description	UPC# 046224 +	Ctn Qty	Ctn Wt	Line Art
WASTE CONNECTIONS - 1 1/2"					
1189RB	1 1/2" SPS X 1 1/2" OD ROUGH BRASS - MALE	91866 0	10	4 lbs.	
1193CRB	1 1/2" COPPER SWEAT X 1 1/2" OD ROUGH BRASS - FEMALE	91871 4	10	4 lbs.	
1193RB	1 1/2" SPS X 1 1/2" OD ROUGH BRASS FEMALE	91873 8	10	5 lbs.	
WASTE CONNECTIONS - 1 1/2" X 1 1/4"					
1187RB	1 1/2" SPS X 1 1/4" OD ROUGH BRASS - MALE	91864 6	10	4 lbs.	
1191RB	1 1/2" SPS X 1 1/4" OD ROUGH BRASS - FEMALE	91870 7	10	4 lbs.	
1191CRB	1 1/2" COPPER SWEAT X 1 1/4" OD ROUGH BRASS - FEMALE	91869 1	10	4 lbs.	
SLIP JOINT DIE CAST NUTS WITH WASHERS					
40600DSN	1 3/8" SLIP JOINT DIE CAST NUT - BULK	92987 1	50	5 lbs.	
915DRB	1 1/4" X 1 1/4" ROUGH BRASS - BULK	72462 9	50	5 lbs.	
915DPC	1 1/4" X 1 1/4" POLISHED CHROME - BULK	93940 5	50	5 lbs.	
916DRB	1 1/2" X 1 1/4" ROUGH BRASS - BULK	70002 9	50	4 lbs.	
916DPC	1 1/2" X 1 1/4" POLISHED CHROME - BULK	93944 3	50	5 lbs.	
917DPC	1 1/2" X 1 3/8" POLISHED CHROME - BULK	93948 1	50	5 lbs.	
918DRB	1 1/2" X 1 1/2" ROUGH BRASS - BULK	93953 5	50	5 lbs.	
918DPC	1 1/2" X 1 1/2" POLISHED CHROME - BULK	93952 8	50	5 lbs.	
919DPC	2" X 2" POLISHED CHROME - BULK	93958 0	25	3 lbs.	
SLIP JOINT CAST BRASS NUTS WITH WASHERS					
915RB	1 1/4" X 1 1/4" ROUGH BRASS - BULK	93943 6	50	5 lbs.	
915PC	1 1/4" X 1 1/4" POLISHED CHROME - BULK	93941 2	50	5 lbs.	
916RB	1 1/2" X 1 1/4" ROUGH BRASS - BULK	93947 4	50	5 lbs.	
916PC	1 1/2" X 1 1/4" POLISHED CHROME - BULK	93945 0	50	5 lbs.	
917RB	1 1/2" X 1 3/8" ROUGH BRASS - BULK	93950 4	50	5 lbs.	
917PC	1 1/2" X 1 3/8" POLISHED CHROME - BULK	93949 8	50	5 lbs.	
918RB	1 1/2" X 1 1/2" ROUGH BRASS - BULK	93956 6	50	5 lbs.	
918PB	1 1/2" X 1 1/2" POLISHED BRASS - BULK	72464 3	50	5 lbs.	
918PC	1 1/2" X 1 1/2" POLISHED CHROME - BULK	93954 2	50	5 lbs.	
919RB	2" X 2" ROUGH BRASS - BULK	93960 3	25	5 lbs.	
919PC	2" X 2" POLISHED CHROME - BULK	93959 7	25	5 lbs.	
WASHERS					
50918RU	1 1/2" RUBBER SLIP JOINT WASHER	93189 8	100	5 lbs.	
50915TPRU	1 1/4" RED TAPERED THERMO PLASTIC RUBBER WASHER	01229 0	100	5 lbs.	
50918TPRU	1 1/2" RED TAPERED THERMO PLASTIC RUBBER WASHER	01238 2	100	5 lbs.	
1765TPRU	1 1/2" X 1 1/4" RED TAPERED REDUCING THERMO PLASTIC RUBBER WASHER	01239 9	100	5 lbs.	
FAUCET HOLE COVERS					
932PC	1 3/4" DIAMETER WITH FIXED POST FAUCET HOLE COVER	70754 7	25	3 lbs.	
935PC	1 3/4" DIAMETER X 1 3/4" LONG FAUCET HOLE COVER	93961 0	25	3 lbs.	
937PC	2" OD POLISHED CHROME	93962 7	25	3 lbs.	
939PC	SNAP IN FAUCET HOLE COVER	72531 2	25	3 lbs.	

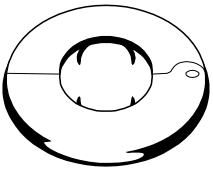
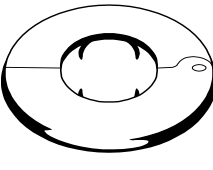
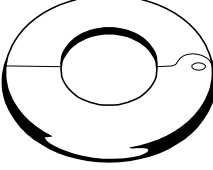
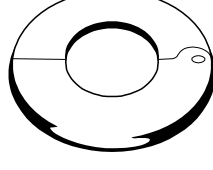

FLANGES

Part Num.	Item Description	UPC# 046224 +	Ctn Qty	Ctn Wt	Line Art
FLANGES - SURE GRIP SHALLOW - IPS					
850PC	3/8" IPS POLISHED CHROME	93832 3	25	1 lb.	
K850PB	3/8" IPS POLISHED BRASS	70667 0	25	1 lb.	
851PC	1/2" IPS POLISHED CHROME	93835 4	25	1 lb.	
K851PB	1/2" IPS POLISHED BRASS	71067 7	25	1 lb.	
882PC	3/4" IPS POLISHED CHROME	93888 0	25	1 lb.	
855PC	1 1/4" IPS POLISHED CHROME	93845 3	25	1 lb.	
1799PC	1 1/2" IPS POLISHED CHROME - SUPER FLANGE	73236 5	25	1 lb.	
856PC	1 1/2" IPS POLISHED CHROME	93846 0	25	1 lb.	
856PB	1 1/2" IPS POLISHED BRASS	72108 6	25	1 lb.	
873PC	2" IPS POLISHED CHROME	72459 9	25	1 lb.	
FLANGES - SURE GRIP SHALLOW - O.D.					
852PC	1 1/4" O.D. POLISHED CHROME	93837 8	25	1 lb.	
854PC	1 3/8" O.D. POLISHED CHROME	93842 2	100	4 lbs.	
853PC	1 1/2" O.D. POLISHED CHROME	93839 2	25	1 lb.	
1801PC	1 5/8" O.D. (1 1/2" O.D. COPPER) POLISHED CHROME	92157 8	25	1 lb.	
1800PC	1 3/4" O.D. POLISHED CHROME	92156 1	25	1 lb.	
SURE GRIP SHALLOW FLANGES - COPPER					
850CPC	1/2" COPPER POLISHED CHROME	93830 9	25	1 lb.	
884PB	1/2" COPPER POLISHED BRASS	93889 7	25	1 lb.	
851CPC	3/4" COPPER POLISHED CHROME	93834 7	25	1 lb.	
FLANGES - SURE GRIP DEEP - IPS					
860PC	3/8" IPS POLISHED CHROME	01395 2	25	3 lbs.	
861PC	1/2" IPS POLISHED CHROME	01396 9	25	1 lb.	
FLANGES - SURE GRIP DEEP - O.D.					
871PC	3/8" O.D. POLISHED CHROME	72460 5	25	1 lb.	
863PC	1/2" O.D. POLISHED CHROME	93856 9	25	1 lb.	
872PC	5/8" O.D. POLISHED CHROME	93870 5	25	1 lb.	
858PC	1 1/4" O.D. POLISHED CHROME	93848 4	25	1 lb.	
859PC	1 1/2" O.D. POLISHED CHROME	93850 7	25	1 lb.	
848PC	1 5/8" O.D. POLISHED CHROME	01965 7	25	1 lb.	
885PC	11/16" O.D. SMALL DEEP BELL FLANGE POLISHED CHROME	72461 2	25	1 lb.	
864PC	1.735" O.D. DEEP BELL FLANGE POLISHED CHROME	73174 0	10	1 lb.	
FLANGES - SURE GRIP BOX - IPS					
868PC	1 1/2" IPS POLISHED CHROME	93861 3	9	2 lbs.	
FLANGES - SURE GRIP BOX - O.D.					
866PC	1 1/4" O.D. POLISHED CHROME	93857 6	9	2 lbs.	
866PB	1 1/4" O.D. POLISHED BRASS	99909 6	9	2 lbs.	
867PC	1 1/2" O.D. POLISHED CHROME	93859 0	9	2 lbs.	
867PB	1 1/2" O.D. POLISHED BRASS	99910 2	9	2 lbs.	
869PC	2" O.D. POLISHED CHROME	93862 0	9	2 lbs.	

Part Num.	Item Description	UPC# 046224 +	Ctn Qty	Ctn Wt	Line Art
STAINLESS STEEL FLOOR & CEILING PLATES - IPS - SPRING LOADED					
102-3/8	3/8" IPS POLISHED CHROME	91493 8	12		
102-1/2	1/2" IPS POLISHED CHROME	91483 9	12		
102-3/4	3/4" IPS POLISHED CHROME	91491 4	12		
102-1	1" IPS POLISHED CHROME	91478 5	12		
102-1 1/4	1 1/4" IPS POLISHED CHROME	91481 5	12		
102-1 1/2	1 1/2" IPS POLISHED CHROME	91479 2	12		
102-2	2" IPS POLISHED CHROME	91486 0	12		
102-2 1/2	2 1/2" IPS POLISHED CHROME	91487 7	12		
102-3	3" IPS POLISHED CHROME	91489 1	12		
102-3 1/2	3 1/2" IPS POLISHED CHROME	91490 7	12		
102-4	4" IPS POLISHED CHROME	91496 9	12		
102-5	5" IPS POLISHED CHROME	91498 3	12		
102-6	6" IPS POLISHED CHROME	91499 0	12		
FLOOR & CEILING PLATES FOR COPPER TUBE - SPRING LOADED					
105-1/2	1/2" POLISHED CHROME 5/8" OPENING	91704 5	12	.5 lb.	
105-3/4	3/4" POLISHED CHROME 7/8" OPENING	91711 3	12	.5 lb.	
105-1	1" POLISHED CHROME 1 1/8" OPENING	91699 4	12	1 lb.	
105-1 1/4	1 1/4" POLISHED CHROME 1 3/8" OPENING	91702 1	12	1 lb.	
105-1 1/2	1 1/2" POLISHED CHROME 1 5/8" OPENING	91700 7	12	1 lb.	
105-2	2" POLISHED CHROME 2 1/8" OPENING	91707 6	12	1 lb.	
105-2 1/2	2 1/2" POLISHED CHROME 2 5/8" OPENING	91708 3	12	1 lb.	
105-3	3" POLISHED CHROME 3 1/8" OPENING	91710 6	12	2 lbs.	
FLOOR & CEILING PLATES SURE GRIP FOR IRON PIPE					
10238PC	3/8" IPS POLISHED CHROME	70014 2	12	.5 lb.	
10212PC	1/2" IPS POLISHED CHROME	70013 5	12	.5 lb.	
10234PC	3/4" IPS POLISHED CHROME	70012 8	12	.5 lb.	
1021PC	1" IPS POLISHED CHROME	70011 1	12	1 lb.	
102114PC	1 1/4" IPS POLISHED CHROME	70010 4	12	1 lb.	
102112PC	1 1/2" IPS POLISHED CHROME	70009 8	12	1 lb.	
1022PC	2" IPS POLISHED CHROME	70008 1	12	2 lbs.	
FLOOR & CEILING PLATES SURE GRIP FOR COPPER TUBE					
10512PC	1/2" POLISHED CHROME 5/8" OPENING	70007 4	12	.5 lb.	
10534PC	3/4" POLISHED CHROME 7/8" OPENING	70006 7	12	.5 lb.	
1051PC	1" POLISHED CHROME 1 1/8" OPENING	70005 0	12	1 lb.	
105114PC	1 1/4" POLISHED CHROME 1 3/8" OPENING	70004 3	12	1 lb.	
105112PC	1 1/2" POLISHED CHROME 1 5/8" OPENING	70003 6	12	1 lb.	
CAST BRASS FLANGES WITH SET SCREW					
1805PC	5/8" O.D. 1/2" COPPER	73218 1	25	3 lbs.	
1803PC	1 1/4" O.D.	92158 5	25	3 lbs.	
1804PC	1 1/2" O.D.	92159 2	25	3 lbs.	
FLANGE - SPRINKLER					
890PC	1/2" O.D.	73235 8	12		

FLANGES

FLANGES

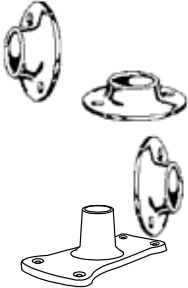
Part Num.	Item Description	UPC# 046224 +	Ctn Qty	Ctn Wt	Line Art
DEEP FLANGES - BULK					
13PVC	1 1/4" O.D. WHITE	91982 7	25	4 lbs.	
14PVC	1 1/2" O.D. WHITE	92020 5	25	4 lbs.	
14ABS	1 1/2" O.D. WHITE	92018 2	25	4 lbs.	
BOX FLANGES 1 1/2" - BULK					
18W	1 1/2" O.D. WHITE	92155 4	25	5 lbs.	
SHOWER ROD FLANGES					
1024PC	DIE CAST 1" O.D. ROUND	91511 9	25		
1020PC	DIE CAST POLISHED CHROME	91508 9	25		
1834PC	FLANGE WROT 1" O.D. ROUND	92206 3	25		
1025PC	DIE CAST 1" O.D. RECTANGLE	91512 6	25		

Part Num.	Item Description	UPC# 046224 +	Ctn Qty	Ctn Wt	Line Art
-----------	------------------	---------------	---------	--------	----------

SPECIFICATION DRAWINGS ~ COMMERCIAL ITEMS

Catalog No.	Dimensions				
	A	B	C	D	E
5700PC	2 ³ / ₁₆ "	1 ⁷ / ₁₆ "	1"	7 ³ / ₄ "	5"

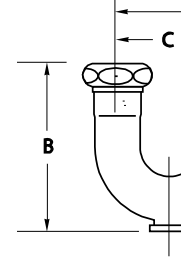
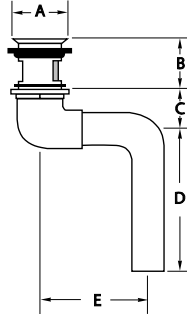
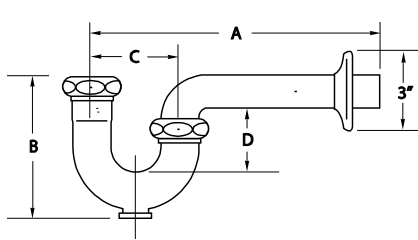

Catalog No.	Dimensions			
	A	B	C	D
5303	11"	5 ¹ / ₈ "	2 ¹ / ₂ "	1 ³ / ₄ "
5307-5311	12"	5 ¹ / ₄ "	2 ⁷ / ₈ "	2 ¹ / ₈ "

Catalog No.	Dimensions			
	A	B	C	D
5680PC	2 ³ / ₁₆ "	1 ¹ / ₂ "	4"	6 ³ / ₄ "
5682PC	2 ³ / ₁₆ "	1 ¹ / ₂ "	5 ³ / ₄ "	8 ¹ / ₄ "

- THE "COMMERCIAL LINE" MEANS QUALITY FOR PLUMBING PROFESSIONALS



- SEMI CAST PRODUCTS
- LOOSE KEY STOPS

COMMERCIAL LINE

CROSS REFERENCE

KEENEY CAT. NO.	Am. Std. Cat. No.	Crane Cat. No.	Eljer Cat. No.	Kohler Cat. No.	Mc Guire Cat. No.
5303PC	4401.014	8-5260	804-1180	K-8998	8872
5311PC	4402.012	8-5260	804-1185	K-8999	8902
5307PC	4403.010	8-5260	804-1190	K-9000	8912
5459XPC	4418.026	8-5272	804-1100	K-9004	8088
5463XPC	4420.030	8-5272	804-1105	K-8995	8090
5461XPC	4419.040	8-5272	804-1110	K-8996	8089
384PC	4429.015	8-5270	804-1125	K-9010	201
385PC	4430.013	8-5270	804-1130	K-9010	202
5680PC	2411.015	8-5222	803-0552	K-7715	155-A
5700PC	7723.018		803-0530	K-13885	155-WC

SEMI-CAST TRAPS WITH CLEANOUT - BRASS NUTS

5303PC	1 1/4" X 1 1/4" 17GA POLISHED CHROME		93263 5	25	38 lbs.
5311PC	1 1/4" X 1 1/2" 17GA POLISHED CHROME		93274 1	25	59 lbs.
5307PC	1 1/2" X 1 1/2" 17GA POLISHED CHROME		93272 7	25	58 lbs.

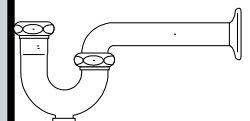

COMMERCIAL LINE

Part Num.	Item Description	UPC# 046224 +	Ctn Qty	Ctn Wt	Line Art
SEMI-CAST TRAPS WITH CLEANOUT - BRASS NUTS - CONTINUED					
5303PCDF	1 1/4" X 1 1/4" 17GA POLISHED CHROME - DEEP FLANGE	93264 2	25	38 lbs.	
5307PCDF	1 1/2" X 1 1/2" 17GA POLISHED CHROME - DEEP FLANGE	93270 3	25	58 lbs.	
5307XPC	1 1/2" X 1 1/2" 17GA POLISHED CHROME - GROUND JOINT	93273 4	25	58 lbs.	
5311XPC	1 1/4" X 1 1/2" 17GA POLISHED CHROME - GROUND JOINT	93279 6	25	59 lbs.	
SEMI-CAST TRAPS WITH CLEANOUT - DIE CAST NUTS					
5303PCDC	1 1/4" X 1 1/4" 17GA POLISHED CHROME	93262 8	25	44 lbs.	
5307PCDC	1 1/2" X 1 1/2" 17GA POLISHED CHROME	93268 0	25	58 lbs.	
5311PCDC	1 1/4" X 1 1/2" 17GA POLISHED CHROME	72533 6	25	60 lbs.	
CAST SWIVEL TRAP - BRASS NUTS					
5461XPC	1 1/2" X 1 1/2" POLISHED CHROME WITH CLEANOUT GROUND JOINT - IPS	93357 1	25	53 lbs.	
CAST BRASS LAVATORY GRID STRAINER					
5680PC	1 1/4" X 8" POLISHED CHROME WITH OPEN GRID STRAINER	70025 8	25	19 lbs.	
5681PC	1 1/4" x 8" POLISHED CHROME WITH OPEN GRID STRAINER (6" TAILPIECE)	93394 6	25	28 lbs.	
5682PC	1 1/4" x 1 1/2" X 6" POLISHED CHROME WITH OPEN GRID STRAINER	93396 0	25	19 lbs.	
CAST BRASS LAVATORY STRAINER FOR WHEEL CHAIR					
5700PC	1 1/4" POLISHED CHROME WITH STRAINER AND DRAIN ASSEMBLY - 17GA TAILPIECE FOR WHEELCHAIR	93400 4	25	38 lbs.	
LOOSE KEY STOPS - BRASS STEM - TAMPER PROOF					
7450PC	3/8" OD X 3/8" IPS ANGLE STOP - POLISHED CHROME	72596 1	25	2 lbs.	
7450KL12PC	3/8" OD X 1/2" LAVATORY SUPPLY KIT WITH 3/8" IPS ANGLE STOP X 12" SUPPLY TUBE AND FLANGES - POLISHED CHROME	70521 5	10	8 lbs.	
7451PC	3/8" OD X 1/2" NOM. INLET WITH 5" EXTENSION ANGLE STOP - POLISHED CHROME	70422 5	5	3 lbs.	
7451KL12PCDF	3/8" OD X 1/2" NOM. INLET X 12" LAVATORY KIT WITH 5" EXTENSION - ANGLE STOP - POLISHED CHROME	70517 8	10	8 lbs.	
7452PC	1/2" OD X 3/8" IPS - ANGLE STOP - POLISHED CHROME	70294 8	5	3 lbs.	
7453PC	3/8" OD X 1/2" IPS - ANGLE STOP - POLISHED CHROME	70423 2	5	3 lbs.	
7454PC	1/2" OD X 1/2" IPS - ANGLE STOP - POLISHED CHROME	70424 9	5	2 lbs.	
7400PC	KEY FOR LOOSE KEY STOPS	07400 7	5	4 lbs.	
URINAL STRAINER					
874PC	BEEHIVE URINAL STRAINER	71092 9	5	8 lbs.	

Part Num.	Item Description	UPC# 046224 +	Ctn Qty	Ctn Wt	Line Art
-----------	------------------	---------------	---------	--------	----------



- Attractive
- Easy to install
- Antimicrobial
- Easily cleaned
- Reinstallable
- Highly tamper resistant

Meets the following requirements:

- ADA articles 4.19.4
- ANSI A117.1
- California article P.1594B
- BOCA article P1203.4





Professional installation is fast and easy!

Measure to determine length of pipe to be covered, with scissors or tin shears, cut to length using cutlines on inside of cover, apply the integrally molded fasteners, press together to provide an easy seamless fit. Repeat to install second cover.

ADA COMPLIANT UNDERSINK PIPING COVERS

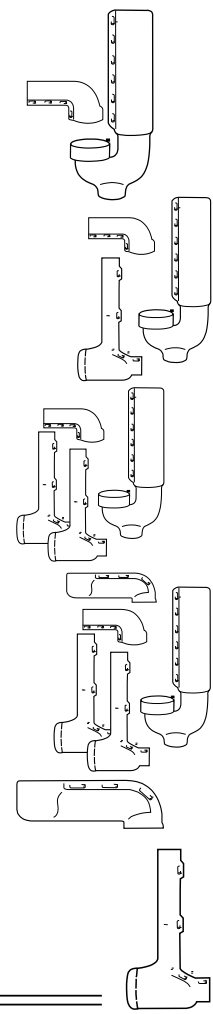
500KN	ONE P-TRAP COVER	00989 4	5	8 lbs.
501KN	ONE P-TRAP COVER, ONE ANGLE STOP, ONE SUPPLY COVER	00985 6	5	12 lbs.
502KN	ONE P-TRAP COVER, TWO ANGLE STOP, TWO SUPPLY COVERS	00986 3	5	15 lbs.
503KN	ONE P-TRAP COVER, TWO ANGLE STOP, TWO SUPPLY COVERS, ONE OFFSET COVER	00990 0	5	16 lbs.
505KN	ONE OFFSET COVER	00987 0	5	4 lbs.
599KN	ONE ANGLE STOP, ONE SUPPLY COVER	00991 7	5	6 lbs.





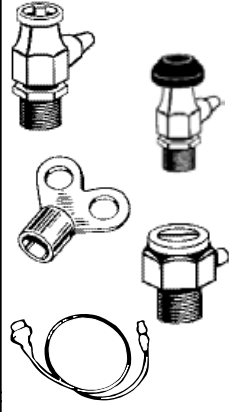

HEATING AIR VALVES

2KSN	SATIN LOOSE KEY AIR VALVE	92263 6	24	1 lb.
2WSN	SATIN WOOD WHEEL AIR VALVE	92264 3	24	1 lb.
3SN	SATIN AIR VALVE KEY	92466 1	50	10 lbs.
4SN	SATIN COIN AIR VALVE	92929 1	48	1 lb.
5SN	3/16" OD X 21" COIN AIR VALVE WITH TUBE	93161 4	6	1 lb.

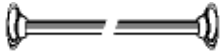

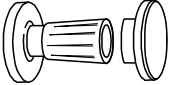
COMMERCIAL LINE & HEATING AIR VALVES

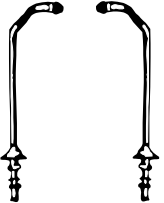
Part Num.	Item Description	UPC# 046224 +	Ctn Qty	Ctn Wt	Line Art
SHOWER RODS - STRAIGHT-WITH WROUGHT FLANGE					
1837PC	1" X 5' BRASS - POLISHED CHROME	92207 0	50	42 lbs.	
1837PB	1" X 5' BRASS - POLISHED BRASS	70235 1	1	8 lbs.	
1840PC	1" X 6' POLISHED STAINLESS STEEL	92215 5	50	50 lbs.	
SHOWER RODS - LESS FLANGE					
1838PCLF	1" X 5' STAINLESS STEEL ROD	92211 7	50	30 lbs.	
1845ALLF	1" X 5' ALUMINUM ROD	92218 6	50	26 lbs.	
1847ALLF	1" X 6' ALUMINUM ROD	92224 7	50	33 lbs.	
SHOWER ROD FLANGES					
1030PC	POLISHED CHROME JIFFY ADJUSTABLE (1 PAIR)	91533 1	50	5 lbs.	
1031PC	DIE CAST JIFFY	91597 3	25	30 lbs.	
SHOWER ARMS					
1819PC	6" POLISHED CHROME SHOWER ARM	92204 9	10	3 lbs.	
1005PC	8" POLISHED CHROME SHOWER ARM	91461 7	10	6 lbs.	
SHOWER ARM - CAST SET SCREW FLANGE					
1828PC	8" ARM POLISHED CHROME	71303 6	10	5 lbs.	
1820PC	6" ARM POLISHED CHROME	92205 6	10	3 lbs.	
SHOWER ACCESSORIES					
720PC	9/16" OFFSET BATH SUPPLIES (PAIR)	93713 5	25	37 lbs.	

SHOWER ACCESSORIES

Part Num.	Item Description	UPC# 046224 +	Ctn Qty	Ctn Wt	Line Art
-----------	------------------	---------------	---------	--------	----------

A Keeney Exclusive!

"MASTERTRAP"

ALL PVC 1-1/2" MASTERTRAP WITH DUAL USE MARVEL CONNECTOR (DESANCO) FOR CONNECTION TO COMPRESSION OR SOLVENT WELD APPLICATIONS

- Almost Gummy Washers - watertight installation
- Specially formulated plasticized bonding agent seals the ground joint connection
- Easier to cut • Can be glued to Desanco fitting

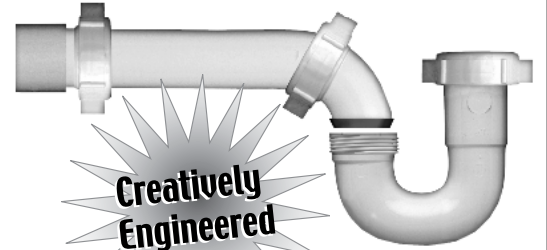

MASTERTRAPS P TRAPS - 1 1/2" - WITH INDUSTRY EXCLUSIVE DURABOND SEAL

400PVC	1 1/2" PVC WHITE WITH MARVEL CONN. AND NUTS - BOXED	00404 2	25	16.8 lbs.
400PVCB	1 1/2" PVC WHITE WITH ABS MARVEL CONN. AND COATED WALLBEND - NUTS - BOXED	01926 8	25	17 lbs.
400ABS	1 1/2" ABS BLACK WITH MARVEL CONN. AND NUTS - BOXED	00403 5	25	16.8 lbs.

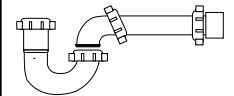

P TRAPS - 1 1/4"

200W2	1 1/4" WHITE - BAGGED	92278 0	25	6 lbs.
200W2DF	1 1/4" WHITE - DEEP FLANGE - BAGGED	92279 7	25	6 lbs.
200WRU2	1 1/4" WHITE - DEEP FLANGE WITH TPR WASHER - BAGGED	02218 3	25	6 lbs.

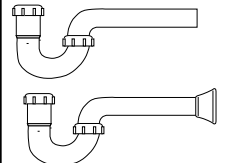

P TRAPS - WITH MARVEL CONNECTOR - 1 1/2"

400W	1 1/2" WHITE - BOXED	92976 5	25	13 lbs.
400B	1 1/2" BLACK - BOXED	92950 5	25	13 lbs.
400TTW	1 1/2" WHITE - BAGGED	92971 1	50	19.1 lbs.
400TTB	1 1/2" BLACK - BAGGED	92968 0	50	19.1 lbs.
400TTWRU	1 1/2" WHITE - WITH TPR WASHER - BAGGED	01034 0	50	19.6 lbs.
400WB2	1 1/2" WHITE WITH ABS MARVEL CONNECTION - BAGGED	92978 9	25	17.5 lbs.
400TTWDF	1 1/2" WHITE - DEEP FLANGE - BAGGED	92972 7	50	19.5 lbs.

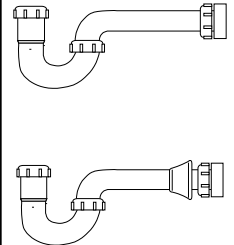

P TRAPS - LESS MARVEL CONNECTOR - 1 1/2"

403W2	1 1/2" WHITE - LOW INLET - BAGGED	92986 4	25	10 lbs.
400TTPRW	1 1/2" WHITE - BAGGED	92970 3	50	16 lbs.
400TTPRWU	1 1/2" WHITE - WITH TPR WASHER - BAGGED	02200 8	50	25 lbs.

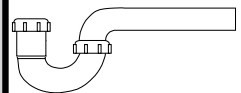

P TRAPS - WITH SOLVENT WELD CONNECTION - 1 1/2"

400SPVC	1 1/2" PVC - SOLVENT WELD CONNECTOR - BOXED	92961 1	25	14 lbs.
400SABS	1 1/2" ABS - SOLVENT WELD CONNECTOR - BOXED	92959 8	25	13 lbs.
400STTW	1 1/2" PVC - SOLVENT WELD CONNECTOR - BAGGED	92964 2	100	41 lbs.
400STTB	1 1/2" ABS - SOLVENT WELD CONNECTOR - BAGGED	92963 5	100	41 lbs.

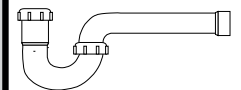

MASTERTRAP S TRAPS - 1 1/2" - WITH INDUSTRY EXCLUSIVE DURABOND SEAL



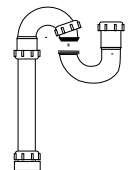







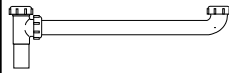





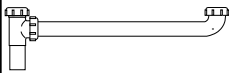

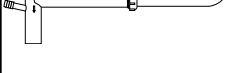
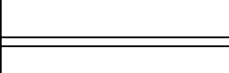







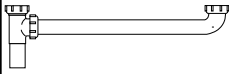







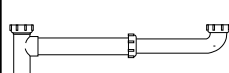



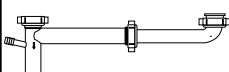



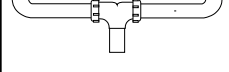

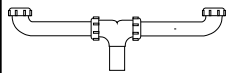
700PVC	1 1/2" WHITE WITH MARVEL CONN. AND NUTS - BOXED	00715 9	25	1 lb.
--------	---	---------	----	-------

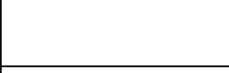

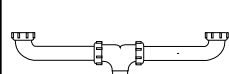
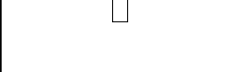

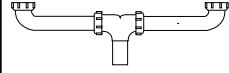









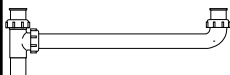

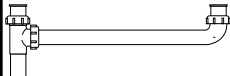
PLASTIC TUBULAR

Part Num.	Item Description	UPC# 046224 +	Ctn Qty	Ctn Wt	Line Art	
S TRAPS - 1 1/4"						
270W	1 1/4" WHITE - BOXED	92440 1	25	22 lbs.		
S TRAPS - 1 1/2"						
700W	1 1/2" WHITE WITH MARVEL CONN. AND NUTS - BOXED	93673 2	25	24 lbs.		
700B	1 1/2" BLACK WITH MARVEL CONN. AND NUTS - BOXED	93668 8	25	24 lbs.		
700W2	1 1/2" WHITE WITH MARVEL CONN. AND NUTS - BAGGED	93676 3	25	23 lbs.		
700WDF	1 1/2" WHITE WITH MARVEL CONNECTOR, NUTS - DEEP FLANGE	93674 9	25	29 lbs.		
700SPVC	1 1/2" PVC WITH SOLVENT WELD SCH. 40 CONN. - BOXED	93672 5	25	23 lbs.		
700TPRWRU	1 1/2" WHITE LESS MARVEL CONN. - NUTS TPR WASHER - BAGGED	02199 5	25	23 lbs.		
701PVC	1 1/2" PVC ONE PIECE FLOOR TUBE WITH MARVEL CONNECTOR - BOXED	93678 7	25	23 lbs.		
WASHING MACHINE TRAPS - 1 1/2"						
800PVC	1 1/2" PVC - SOLVENT WELD - BOXED	93778 4	25	17 lbs.		
801PVC	1 1/2" WHITE - IPS - BOXED	93782 1	25	17 lbs.		
MASTERTRAP SINK TRAPS - 1 1/2"						
500PVC	1 1/2" PVC SOLVENT WELD - BOXED	 L.A. APPROVED	93173 7	25	11 lbs.	
500ABS	1 1/2" ABS SOLVENT WELD - BOXED		93169 0	25	11 lbs.	
MASTERTRAP SINK TRAPS - 1 1/2"						
501PVC	1 1/2" WHITE - IPS - BOXED		93178 2	25	11 lbs.	
501ABS	1 1/2" BLACK - IPS - BOXED		93176 8	25	11 lbs.	
546W2	1 1/2" WITH 1 1/2 X 6" EXTENSION TUBE WHITE - BAGGED		93356 4	25	13 lbs.	
546B2	1 1/2" WITH 1 1/2 X 6" EXTENSION TUBE BLACK - BAGGED		93349 6	25	13 lbs.	
549W2	1 1/4" WITH 6" SLIP JOINT EXTENSION TUBE - BAGGED		93377 9	25	13 lbs.	
MASTERTRAP REPAIR TRAP - 1 1/2"						
600PVC	1 1/2" WHITE WITH SLIP JOINT CONN. ELBOW - BOXED		93415 8	25	12 lbs.	
600ABS	1 1/2" BLACK WITH SLIP JOINT CONN. ELBOW - BOXED		93413 4	25	12 lbs.	
J BENDS - 1 1/2"						
10400W	1 1/2" WHITE - BOXED		91642 0	25	8 lbs.	
10400B	1 1/2" BLACK - BOXED		91639 0	25	8 lbs.	
END OUTLET CONTINUOUS WASTES - WITH BAFFLE TEE - SLIP JOINT						
121W	1 1/2" WHITE ADJ. WASTE WITH TELESCOPIC TEE - BAGGED		91892 9	25	15 lbs.	
125-16W	1 1/2" X 16" WHITE - BOXED	 L.A. APPROVED	91930 8	25	13 lbs.	
125-16B	1 1/2" X 16" BLACK - BOXED		91926 1	25	13 lbs.	

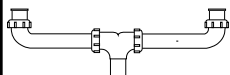
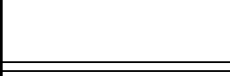
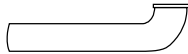

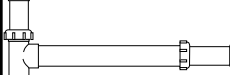

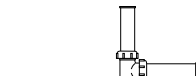

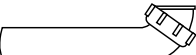
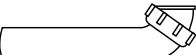
PLASTIC TUBULAR

Part Num.	Item Description	UPC# 046224 +	Ctn Qty	Ctn Wt	Line Art
END OUTLET CONTINUOUS WASTES - WITH BAFFLE TEE - SLIP JOINT - CONTINUED					
125-16TTW	1 1/2" X 16" WHITE - BAGGED	91929 2	25	13 lbs.	
125-16TTB	1 1/2" X 16" BLACK - BAGGED	91928 5	25	13 lbs.	
125-21W	1 1/2" X 21" WHITE - BOXED 	91935 3	25	15 lbs.	
125-21B	1 1/2" X 21" BLACK - BOXED 	91934 6	25	15 lbs.	
125-25W	1 1/2" X 25" WHITE - BOXED	91937 7	25	17 lbs.	
125-25B	1 1/2" X 25" BLACK - BOXED	91936 0	25	17 lbs.	
125-18W	1 1/2" X 16" WHITE - WITH 8" TAILPIECE - BOXED	91933 9	25	15 lbs.	
125-18B	1 1/2" X 16" BLACK - WITH 8" TAILPIECE - BOXED	91932 2	25	15 lbs.	
127W	1 1/2" WHITE - ADJ. WASTE WITH 1/2" BRANCH - BAGGED	70458 4	25	14 lbs.	
127B	1 1/2" BLACK - ADJ. WASTE WITH 1/2" BRANCH - BAGGED	70535 2	25	14 lbs.	
119W	1 1/2" - TELESCOPIC WASTE 3/4" BRANCH WHITE - BAGGED	70321 1	25	13 lbs.	
119B	1 1/2" - TELESCOPIC WASTE 3/4" BRANCH BLACK - BAGGED	72286 1	25	13 lbs.	
END OUTLET CONTINUOUS WASTES - WITH BAFFLE TEE - DIRECT CONNECT					
125A-16W	1 1/2" X 16" WHITE - BOXED   	91945 2	25	13 lbs.	
125A-16B	1 1/2" X 16" BLACK - BOXED   	91941 4	25	13 lbs.	
125A-16TTW	1 1/2" X 16" WHITE - BAGGED   	91944 5	25	13 lbs.	
125A-16TTB	1 1/2" X 16" BLACK - BAGGED   	91943 8	25	13 lbs.	
120AB	1 1/2" BLACK ADJUSTABLE - BAGGED	70375 4	25	18 lbs.	
120AW	1 1/2" WHITE ADJUSTABLE - BAGGED	70372 3	25	18 lbs.	
127AW	1 1/2" WHITE ADJ. WASTE WITH 1/2" BRANCH - BAGGED	91967 4	25	14 lbs.	
127AB	1 1/2" BLACK ADJ. WASTE WITH 1/2" BRANCH - BAGGED	70376 1	25	14 lbs.	
119AW	1 1/2" TELESCOPIC WASTE 3/4" BRANCH WHITE - BAGGED	70456 0	25	13 lbs.	
119AB	1 1/2" TELESCOPIC WASTE 3/4" BRANCH BLACK - BAGGED	70468 3	25	13 lbs.	
CENTER OUTLET CONTINUOUS WASTES - WITH BAFFLE TEE - SLIP JOINT					
130-16W	1 1/2" X 16" WHITE - BOXED 	91986 5	25	16 lbs.	
130-16B	1 1/2" X 16" BLACK - BOXED 	91983 4	25	16 lbs.	
130-21W	1 1/2" X 21" WHITE - BOXED	91989 6	25	18 lbs.	
130-21B	1 1/2" X 21" BLACK - BOXED	91988 9	25	18 lbs.	
130-25W	1 1/2" X 25" WHITE - BOXED	91991 9	25	20 lbs.	
130-25B	1 1/2" X 25" BLACK - BOXED	72202 1	25	20 lbs.	
CENTER OUTLET CONTINUOUS WASTES - WITH BAFFLE TEE - DIRECT CONNECT					
130A-16W	1 1/2" X 16" WHITE - BOXED 	91995 7	25	16 lbs.	
130A-16B	1 1/2" X 16" BLACK - BOXED 	91993 3	25	16 lbs.	
130A-21W	1 1/2" X 21" WHITE - BOXED	91998 8	25	18 lbs.	
130A-21B	1 1/2" X 21" BLACK - BOXED	91997 1	25	18 lbs.	

PLASTIC TUBULAR

Part Num.	Item Description	UPC# 046224 +	Ctn Qty	Ctn Wt	Line Art
MASTERWASTES - 1 1/2"					
120W	1 1/2" WHITE ADJ. DIRECT CONNECT OR SLIP JOINT CONNECTION TELESCOPIC TEE - BAGGED	 91879 0	25	18 lbs.	
120B	1 1/2" BLACK ADJ. DIRECT CONNECT OR SLIP JOINT CONNECTION - BAGGED	91876 9	25	18 lbs.	
122W	1 1/2" X 16" WHITE END OUTLET DIRECT CONNECT OR SLIP JOINT CONNECTION - BOXED	 91906 3	25	17 lbs.	
122B	1 1/2" X 16" BLACK END OUTLET DIRECT CONNECT OR SLIP JOINT CONNECTION - BOXED	91901 8	25	17 lbs.	
122TTW	1 1/2" WHITE END OUTLET DIRECT CONNECT OR SLIP JOINT CONNECT - BAGGED	72633 3	25	17 lbs.	
222W	1 1/2" X 16" WHITE CENTER OUTLET DIRECT CONNECT OR SLIP JOINT - BOXED	 92329 9	25	18 lbs.	
222B	1 1/2" X 16" BLACK CENTER OUTLET DIRECT CONNECT OR SLIP JOINT - BOXED	92325 1	25	18 lbs.	
222TTW	1 1/2" X 16" WHITE CENTER OUTLET DIRECT CONNECT OR SLIP JOINT - BAGGED	70328 0	25	13 lbs.	
DISPOSER ELBOWS - DIRECT CONNECT					
341W	1 1/2" X 4 3/4" CENTER TO END (IN-SINK-ERATOR) - BULK	92879 9	25	2 lbs.	
341B	1 1/2" X 4 3/4" CENTER TO END (IN-SINK-ERATOR) - BULK	92878 2	25	2 lbs.	
ADJUSTABLE DISPOSER KITS - DIRECT CONNECT					
335W	1 1/2" WHITE TELESCOPIC ADJUSTABLE 10" - 15" FOR IN-SINK-ERATOR - BAGGED	 92865 2	25	17 lbs.	
335B	1 1/2" BLACK TELESCOPIC ADJUSTABLE 10" - 15" FOR IN-SINK-ERATOR - BAGGED	92864 5	25	17 lbs.	
ADJUSTABLE DISPOSER KITS - DIRECT CONNECT					
338W	1 1/2" WHITE TELESCOPIC ADJUSTABLE 6" - 10" FOR IN-SINK-ERATOR - BAGGED	00297 0	25	17 lbs.	
338B	1 1/2" BLACK TELESCOPIC ADJUSTABLE 6" - 10" FOR IN-SINK-ERATOR - BAGGED	00126 3	25	17 lbs.	
MASTERKIT DISPOSER KITS - END OUTLET					
333W	1 1/2" WHITE - BOXED	92859 1	25	26 lbs.	
333B	1 1/2" BLACK - BOXED	92847 8	25	26 lbs.	
334W	1 1/2" WHITE LESS P-TRAP - BOXED	92862 1	25	15 lbs.	
334B	1 1/2" BLACK LESS P-TRAP - BOXED	92860 7	25	15 lbs.	
WASTE ARMS - 1 1/2" - DIRECT CONNECT - BULK					
101AW	1 1/2" X 7" WHITE	91464 8	25	3 lbs.	
101AB	1 1/2" X 7" BLACK	72204 5	25	3 lbs.	
102AW	1 1/2" X 9 1/2" WHITE	91502 7	25	7 lbs.	
102AB	1 1/2" X 9 1/2" BLACK	91501 0	25	7 lbs.	

PLASTIC TUBULAR

Part Num.	Item Description	UPC# 046224 +	Ctn Qty	Ctn Wt	Line Art	
WASTE ARMS - 1 1/2" - DIRECT CONNECT - BULK - CONTINUED						
103AW	1 1/2" X 11 1/2" WHITE	91530 0	25	6 lbs.		
103AB	1 1/2" X 11 1/2" BLACK	91529 4	25	6 lbs.		
104AW	1 1/2" X 15" WHITE	91628 4	25	6 lbs.		
104AB	1 1/2" X 15" BLACK	91624 6	25	6 lbs.		
105AW	1 1/2" X 20" WHITE	91716 8	25	11 lbs.		
105AB	1 1/2" X 20" BLACK	91715 1	25	11 lbs.		
106AW	1 1/2" X 24" WHITE	91739 7	25	10 lbs.		
106AB	1 1/2" x 24" BLACK	91737 3	25	10 lbs.		
WASTE ARMS - 1 1/2" - SLIP JOINT - BULK						
101W	1 1/2" X 7" WHITE	91467 9	25	4 lbs.		
101B	1 1/2" X 7" BLACK	91466 2	25	4 lbs.		
102W	1 1/2" X 9 1/2" WHITE	91505 8	25	6 lbs.		
102B	1 1/2" X 9 1/2" BLACK	91504 1	25	6 lbs.		
103W	1 1/2" X 11 1/2" WHITE	91532 4	25	7 lbs.		
103B	1 1/2" X 11 1/2" BLACK	91531 7	25	7 lbs.		
104W	1 1/2" X 15" WHITE	91634 5	25	7 lbs.		
104B	1 1/2" X 15" BLACK	91631 4	25	7 lbs.		
105W	1 1/2" X 20" WHITE	91718 2	25	9 lbs.		
105B	1 1/2" X 20" BLACK	91717 5	25	9 lbs.		
106W	1 1/2" X 24" WHITE	91742 7	25	12 lbs.		
106B	1 1/2" X 24" BLACK	91741 0	25	12 lbs.		
TEE AND TAILPIECE - WITH BAFFLE - BULK						
125AW	1 1/2" WHITE END OUTLET DIRECT CONNECT	91952 0	25	6 lbs.		
125AB	1 1/2" BLACK END OUTLET DIRECT CONNECT	91951 3	25	6 lbs.		
125W	1 1/2" WHITE END OUTLET SLIP JOINT	 91957 5	25	5 lbs.		
125B	1 1/2" BLACK END OUTLET SLIP JOINT	 91955 1	25	5 lbs.		
125-8W	1 1/2" WHITE END OUTLET WITH 8" TAILPIECE	91939 1	25	8 lbs.		
125-8B	1 1/2" BLACK END OUTLET TEE WITH 8" TAILPIECE SLIP JOINT	91938 4	25	8 lbs.		
130W	1 1/2" WHITE CENTER OUTLET SLIP JOINT	 92003 8	25	5 lbs.		
130B	1 1/2" BLACK END OUTLET SLIP JOINT	 92000 7	25	5 lbs.		
P.O. PLUG - ONE PIECE						
75SSABS	1 1/4" X 5" BLACK LAVATORY WITH CHAIN AND STOPPER AND STAINLESS STEEL RIM - BOXED	 93718 0	25	8 lbs.		
C.O. PLUG - ONE PIECE						
73SSABS	1 1/4" X 5" BLACK LAVATORY LIFT 'N LOK TOP AND STAINLESS STEEL RIM - BOXED	 93714 2	25	8 lbs.		
74SSABS	1 1/4" X 5" BLACK LAVATORY WITH CHAIN AND STOPPER AND STAINLESS STEEL RIM - BOXED	 93716 6	25	8 lbs.		

PLASTIC TUBULAR

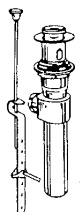
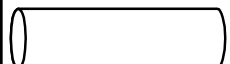
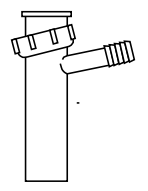
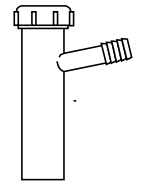
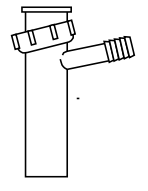
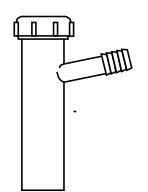
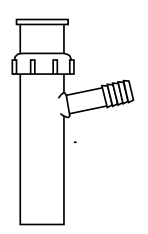
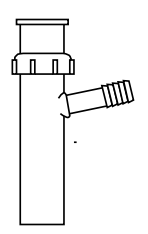
Part Num.	Item Description	UPC# 046224 +	Ctn Qty	Ctn Wt	Line Art
LAVATORY POP-UP					
78PL	CHROME PLATED PLASTIC LAVATORY ASSEMBLY WITH ROD AND STRAP - BOXED	93761 6	25	17 lbs.	
1687PCBAG	CHROME PLATED 2 PIECE 1-1/4 PLASTIC ABS/BRASS - BAGGED	01519 2	25	19 lbs.	
TUBING 1 1/2" - BULK					
100PVC	1 1/2" X 6' WHITE	91456 3	25	9 lbs.	
100ABS	1 1/2" X 6' BLACK	91455 6	25	9 lbs.	
PVC DISHWASHER BRANCH TAILPIECES - BULK					
30-12PVC	1 1/2" X 12" WHITE DIRECT CONNECT 3/4" BRANCH TAILPIECE (7/8" O.D.)	01333 4	25	6 lbs.	
31-12PVC	1 1/2" X 12" WHITE DIRECT CONNECT (5/8" O.D.)	01332 7	25	5 lbs.	
32-12PVC	1 1/2" X 12" WHITE SLIP JOINT (3/4" BRANCH 7/8" O.D.)	01343 3	25	7 lbs.	
33-12PVC	1 1/2" X 12" WHITE SLIP JOINT (5/8" O.D.)	01344 0	25	6 lbs.	
34-12PVC	1 1/2" X 12" WHITE SLIP JOINT (7/8" O.D.) DIRECT WITH MACHINE HOSE BRANCH	01346 4	25	6 lbs.	
DISHWASHER BRANCH TAILPIECES - BULK					
30-8W	1 1/2" X 8" WHITE DIRECT CONNECT 3/4" BRANCH TAILPIECE (7/8" O.D.)	92470 8	25	4 lbs.	
30-8B	1 1/2" X 8" BLACK DIRECT CONNECT 3/4" BRANCH TAILPIECE (7/8" O.D.)	92468 5	25	4 lbs.	
31-8W	1 1/2" X 8" WHITE DIRECT CONNECT (5/8" O.D.)	92763 1	25	4 lbs.	
31-8B	1 1/2" X 8" BLACK DIRECT CONNECT (5/8" O.D.)	92762 4	25	4 lbs.	
32-8W	1 1/2" X 8" WHITE SLIP JOINT (3/4" BRANCH 7/8" O.D.)	92784 6	25	4 lbs.	
32-8B	1 1/2" X 8" BLACK SLIP JOINT (3/4" BRANCH 7/8" O.D.)	92782 2	25	4 lbs.	
33-8W	1 1/2" X 8" WHITE SLIP JOINT (5/8" O.D.)	92820 1	25	4 lbs.	
33-8B	1 1/2" X 8" BLACK SLIP JOINT (5/8" O.D.)	92819 5	25	4 lbs.	
MASTER DISHWASHER BRANCH TAILPIECE - 1 1/2" - BULK					
34-8W	1 1/2" X 8" WHITE DIRECT CONNECT OR SLIP JOINT - WITH 7/8" O.D. BRANCH	92875 1	25	6 lbs.	
34-8B	1 1/2" X 8" BLACK DIRECT CONNECT OR SLIP JOINT - WITH 7/8" O.D. BRANCH	72208 3	25	6 lbs.	
35-8W	1 1/2" X 8" WHITE SLIP JOINT OR DIRECT CONNECT WITH (5/8" O.D.) BRANCH	92889 8	25	6 lbs.	
35-8B	1 1/2" X 8" BLACK SLIP JOINT OR DIRECT CONNECT WITH (5/8" O.D.) BRANCH	92887 4	25	6 lbs.	

PLASTIC TUBULAR

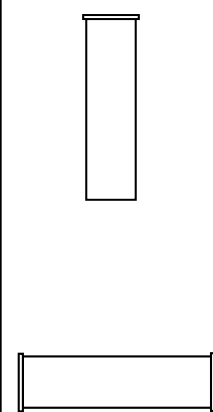
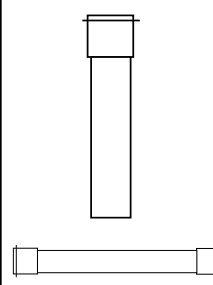
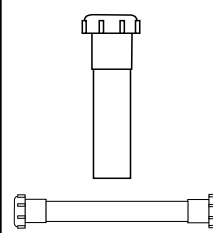
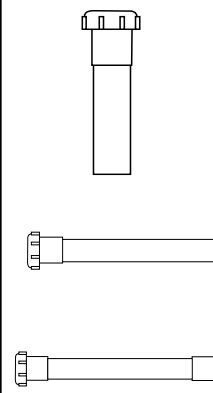
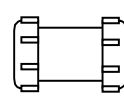



Part Num.	Item Description	UPC# 046224 +	Ctn Qty	Ctn Wt	Line Art	
SINK TAILPIECES - 1 1/2" - BULK						
10-4W	1 1/2" X 4" WHITE	91443 3	25	2 lbs.		
10-4B	1 1/2" X 4" BLACK	91441 9	25	2 lbs.		
10-6W	1 1/2" X 6" WHITE	91447 1	25	2 lbs.		
10-6B	1 1/2" X 6" BLACK	91446 4	25	2 lbs.		
10-8W	1 1/2" X 8" WHITE	91450 1	25	3 lbs.		
10-8B	1 1/2" X 8" BLACK	91449 5	25	3 lbs.		
10-10W	1 1/2" X 10" WHITE	91433 4	25	4 lbs.		
10-12W	1 1/2" X 12" WHITE	91437 2	25	4 lbs.		
10-12B	1 1/2" X 12" BLACK	91435 8	25	4 lbs.		
10-14W	1 1/2" X 14" WHITE	91440 2	25	6 lbs.		
11-16PVC	1 1/2" X 16" WHITE DOUBLE FLANGED	91793 9	25	7 lbs.		
11-16ABS	1 1/2" X 16" BLACK DOUBLE FLANGED	91791 5	25	7 lbs.		
EXTENSION TUBES - 1 1/2" - SOLVENT WELD - BULK						
20-6PVC	1 1/2" X 6" PVC	92273 5	25	4 lbs.		
20-8PVC	1 1/2" X 8" PVC	92276 6	25	5 lbs.		
20-8ABS	1 1/2" X 8" ABS	92275 9	25	5 lbs.		
20-12PVC	1 1/2" X 12" PVC	92269 8	25	7 lbs.		
20-12ABS	1 1/2" X 12" ABS	92267 4	25	7 lbs.		
21-16PVC	1 1/2" X 16" PVC DOUBLE END	92288 9	25	10 lbs.		
21-16ABS	1 1/2" X 16" ABS DOUBLE END	92287 2	25	10 lbs.		
EXTENSION TUBES - 1 1/4" - SLIP JOINT - BULK						
42-6W	1 1/4" X 6" WHITE	93000 6	25	4 lbs.		
42-8W	1 1/4" X 8" WHITE	93001 3	25	5 lbs.		
42-12W	1 1/4" X 12" WHITE	92995 6	25	8 lbs.		
42-16W	1 1/4" X 16" WHITE DOUBLE END	92998 7	25	10 lbs.		
EXTENSION TUBES - 1 1/2" - SLIP JOINT - BULK						
40-6W	1 1/2" X 6" WHITE	92937 6	25	5 lbs.		
40-6B	1 1/2" X 6" BLACK	92936 9	25	5 lbs.		
40-8W	1 1/2" X 8" WHITE	92944 4	25	6 lbs.		
40-8B	1 1/2" X 8" BLACK	92941 3	25	6 lbs.		
40-12W	1 1/2" X 12" WHITE	92932 1	25	9 lbs.		
40-12B	1 1/2" X 12" BLACK	92931 4	25	9 lbs.		
41-16PVC	1 1/2" X 16" WHITE DOUBLE END	92992 5	25	11 lbs.		
41-16ABS	1 1/2" X 16" BLACK DOUBLE END	92990 1	25	11 lbs.		
EXTENSION COUPLING - 1 1/2" - SLIP JOINT - BULK						
46PVC	1 1/2" WHITE STRAIGHT WITH 1 1/2" OR 1 1/4" POLY WASHER	93082 2	25	3 lbs.		
46ABS	1 1/2" BLACK STRAIGHT WITH 1 1/2" OR 1 1/4" POLY WASHER	93080 8	25	3 lbs.		









PLASTIC TUBULAR

Part Num.	Item Description	UPC# 046224 +	Ctn Qty	Ctn Wt	Line Art
DOUBLE SLIP ELBOW - 1 1/2" - BULK					
47PVC	1 1/2" X 1 1/2" 90° WHITE	93093 8	25	6 lbs.	
47ABS	1 1/2" X 1 1/2" 90° BLACK	93092 1	25	6 lbs.	
49PVC	1 1/2" X 1 1/2" 45° WHITE	93140 9	25	6 lbs.	
49B	1 1/2" X 1 1/2" 45° BLACK	93139 3	25	6 lbs.	
REDUCER COUPLINGS - BULK					
27PVC	1 1/4" O.D. X 1 1/2" WHITE SOLVENT WELD	92438 8	25	2 lbs.	
3 WAY SLIP TEE - 1 1/2" - BULK					
48PVC	1 1/2" WHITE	93102 7	25	10 lbs.	
48ABS	1 1/2" BLACK	93101 0	25	10 lbs.	
DOUBLE OFFSET - 1 1/2" - BULK					
44PVC	1 1/2" X 1 1/2" WHITE	93004 4	25	9 lbs.	
INSERTS - BULK					
15PVC	1 1/2" X 1" WHITE FLANGED DIRECT CONNECTION	92056 4	25	2 lbs.	
15ABS	1 1/2" X 1" BLACK FLANGED DIRECT CONNECTION	92054 0	25	2 lbs.	
SLIP JOINT NUTS AND WASHERS - BULK					
55W	1 1/2" X 1 1/2" WHITE - NO WASHER	93383 0	100	2 lbs.	
55B	1 1/2" X 1 1/2" BLACK - NO WASHER	93378 6	100	2 lbs.	
56W	1 1/4" X 1 1/4" WHITE - NO WASHER	93389 2	100	2 lbs.	
56B	1 1/4" X 1 1/4" BLACK - NO WASHER	93388 5	100	2 lbs.	
59W	1 1/2" X 1 1/2" WHITE SUPER NUT - NO WASHER	70691 5	100	2 lbs.	
59B	1 1/2" X 1 1/2" BLACK SUPER NUT - NO WASHER	70593 2	100	2 lbs.	
57	1 1/4" X 1 1/4" BEVELED POLYWASHER	93398 4	100	2 lbs.	
65	1 1/2" X 1 1/2" BEVELED POLYWASHER	93618 3	100	1 lb.	
66	1 1/2" X 1 1/4" BEVELED POLYWASHER	93621 3	100	1 lb.	
CONNECTORS - 1 1/2" - BULK					
99PVC	1 1/2" X 1 1/2" (TUBE SIZE) PVC SCH 40 SOLVENT WELD	93974 0	25	1 lb.	
95PVC	1 1/2" X 1 1/2" PVC SCH 40 SOLVENT WELD WITH TUBE COMPRESSION NUT AND WASHER	93967 2	25	3 lbs.	
95ABS	1 1/2" X 1 1/2" ABS SCH 40 SOLVENT WELD WITH TUBE COMPRESSION NUT AND WASHER	93966 5	25	3 lbs.	
95TTABSRU	1 1/2" COMP X 1 1/2" SCH 40 SOLVENT WELD WITH TPR WASHER	01507 9	200	18 lbs.	

PLASTIC TUBULAR

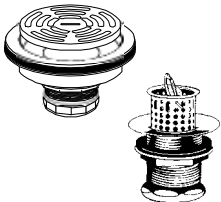

Part Num.	Item Description	UPC# 046224 +	Ctn Qty	Ctn Wt	Line Art
BRASS STRAINERS					
BRASS STRAINER- FOR 3 1/2" DIAMETER HOLE - 4 1/2" DIAMETER FLANGE - NEOPRENE STOPPER					
2431NPC	POLISHED CHROME - FIXED STICK POST BASKET	92364 0	25	25 lbs.	
2432PB	POLISHED BRASS - FIXED STICK POST BASKET	 70244 3	25	25 lbs.	
2433PC	POLISHED CHROME - FIXED STICK POST BASKET MADE IN THE U.S.A.	 70319 8	25	25 lbs.	
2433PCBNBL	POLISHED CHROME - FIXED STICK POST BASKET				
	BRASS NUT AND BRASS LOCKNUT - MADE IN THE U.S.A.	01681 6	25	29 lbs.	
2435PC	POLISHED CHROME - WITH 4 PRONG BASKET MADE IN THE U.S.A.	 74222 7	10	25 lbs.	
CAST BRASS STRAINER					
CAST BRASS STRAINER FOR 3 1/2" DIAMETER HOLE - METAL STOPPER "COMMERCIAL GRADE"					
1438PC	POLISHED CHROME - GROUND JOINT ADJ. DROP POST BASKET WITH O RING SEAL	 92044 1	10	50 lbs.	
STAINLESS STEEL STRAINERS					
ALL STAINLESS STEEL STRAINER FOR 3 1/2" DIAMETER HOLE - NEOPRENE STOPPER					
1431SSBX	BUFFED RIM - PLASTIC FIXED STICK POST BASKET	92033 5	10	24 lbs.	
ALL STAINLESS STEEL STRAINER - FOR 3 1/2" DIAMETER HOLE NEOPRENE STOPPER - BRASS NUT AND BRASS LOCKNUT					
1437SS	BUFFED RIM - STAINLESS STEEL SPRING STYLE BASKET	92043 4	10	18 lbs.	
1437SST	STRAINER WITH 4" TAILPIECE	01948 0	25	45 lbs.	
1437SSBNBL	BUFFED RIM - STAINLESS STEEL SPRING STYLE BASKET	01511 6	25	50 lbs.	
ALL STAINLESS STEEL STRAINER FOR 3 1/2" DIAMETER HOLE - METAL STOPPER					
1433SS	BUFFED RIM - "TURN 2 SEAL" TYPE BASKET	92039 7	10	24 lbs.	
ALL STAINLESS STEEL STRAINER - THUMB SCREW STYLE LOCK NUT FOR 3 1/2" DIAMETER HOLE - NEOPRENE STOPPER					
1441SS	BUFFED RIM - PLASTIC FIXED STICK POST BASKET	73317 7	10	22 lbs.	

Part Num.	Item Description	UPC# 046224 +	Ctn Qty	Ctn Wt	Line Art
STAINLESS STEEL LOCKING SHELL STRAINERS					
ALL STAINLESS STEEL STRAINER					
FOR 3 1/2" DIAMETER HOLE - NEOPRENE STOPPER					
1435SS	BUFFED RIM - SHORT SHANK FIXED STICK POST BASKET - LOCKING SHELL	92041 0	10	16.25 lbs.	
ALL STAINLESS STEEL STRAINER					
FOR 3 1/2" DIAMETER HOLE - NEOPRENE STOPPER					
1443SS	BUFFED RIM - SHORT SHANK - LOCKING SHELL SPRING STYLE BASKET	74223 4	10	16.25 lbs.	
ALL STAINLESS STEEL STRAINER - PLUMBER'S SPEC					
LOCKING SHELL FOR 3 1/2" DIAMETER HOLE - NEOPRENE STOPPER					
1436SSBN	BUFFED RIM - SPRING SNAP STYLE LOCKING BASKET DEEP CUP LOCKING SHELL - BRASS NUT	01514 7	10	9 lbs.	
ALL STAINLESS STEEL STRAINER - DEEP CUP					
LOCKING SHELL FOR 3 1/2" DIAMETER HOLE - NEOPRENE STOPPER					
1432SS	BUFFED RIM - LONG SHANK - FIXED STICK POST	92035 9	10	24 lbs.	
ALL STAINLESS STEEL STRAINER - DEEP CUP					
LOCKING SHELL FOR 3 1/2" DIAMETER HOLE - NEOPRENE STOPPER					
1434SS	BUFFED RIM - LONG SHANK - POWER BALL LOCK BASKET	70016 6	10	24 lbs.	
ALL STAINLESS STEEL STRAINER - DEEP CUP					
LOCKING SHELL FOR 3 1/2" DIAMETER HOLE - NEOPRENE STOPPER					
1440SSBN	BUFFED RIM - BRASS NUT - FIXED STICK POST MADE IN THE U.S.A.	70380 8	25	25 lbs.	
1440SSBNBL	FIXED STICK POST - BRASS LOCKNUT - BRASS NUT MADE IN THE U.S.A.	70698 4	25	25 lbs.	
MISCELLANEOUS STRAINERS					
WIDE FLANGE STRAINERS FOR 3 1/2" HOLE - 4 1/2" DIAMETER - STAINLESS STEEL					
1376PC	STAINLESS STEEL GRID	92014 4	25	21 lbs.	
WIDE FLANGE STRAINERS FOR 3 1/2" HOLE - 4 1/2" DIAMETER - BRASS BODY					
1377PC	CHROME PLATED STAINLESS STEEL GRID	92016 8	10	25.00	
BAR SINK STRAINER					
877PC	STAINLESS STEEL WITH LONG BASKET	70702 8	25	9 lbs.	
JR. DUO STRAINER FOR 2" - 2 1/2" HOLE - STAINLESS STEEL					
878PC	STAINLESS STEEL BASKET	93876 7	25	9 lbs.	



Part Num.	Item Description	UPC# 046224 +	Ctn Qty	Ctn Wt	Line Art
MASTER DUPLEX STRAINER FOR 2" - 2 1/2" HOLE - STAINLESS STEEL					
879PC	WITH NUTS, WASHERS, GRID AND RUBBER STOPPER	93879 8	25	15 lbs.	
JUNIOR DUO STRAINER - FOR 2" - 2 1/2" OPENINGS					
83SSABS	WITH BASKET - PLASTIC BODY	93811 8	25	5 lbs.	
TRAY PLUG - FOR 2" - 2 1/2" OPENINGS					
81SSABS	RUBBER STOPPER				
	PLASTIC BODY - STAINLESS STEEL RIM	93793 7	25	7 lbs.	
82SSABS	LIFT 'N LOK TOP				
	PLASTIC BODY - STAINLESS STEEL RIM	93804 0	25	7 lbs.	
"IMPERIAL" STRAINER - PLASTIC - NEOPRENE STOPPER - BOXED					
250SS	STAINLESS STEEL RIM AND BASKET FIXED STICK POST	92373 2	25	14 lbs.	
STRAINER-REPLACEMENT PARTS					
250-1SS	REPLACEMENT BASKET FOR 250SS	92374 9	25	1.5 lbs.	
260	REPLACEMENT BASKET WITH ADJUSTABLE POST - WHITE	92435 7	25	1.5 lbs.	
83-1	REPLACEMENT BASKET FOR 83SSABS	93810 1	25	1.5 lbs.	
82-1	LIFT 'N LOK TOP ONLY FOR STRAINER	93803 3	25	2.5 lbs.	
132430PC	STAINLESS STEEL ADJ. POST REPLACEMENT BASKET	92010 6	25	5 lbs.	
132431PC	STAINLESS STEEL BASKET WITH FIXED POST	92011 3	25	5 lbs.	
131434SS	STRAINER BASKET REPLACEMENT FOR 1434SS POWERBALL	00382 3	25	5 lbs.	
13877PC	STRAINER BASKET REPLACEMENT FOR 877	00381 6	25	5 lbs.	
1433-1SS	1433-BASKET ONLY	92038 0	25	1.5 lbs.	
1438-1PC	1438PC-BASKET ONLY	01327 3	25	1.5 lbs.	
501430RU	3 1/2" LARGE RUBBER WASHER	93181 2	100	2 lbs.	
501437RU	9/32" THICK JUMBO WASHER	71230 5	100	1.5 lbs.	
511430P	PAPER CRUMBCUP BODY WASHER	93195 9	100	1 lb.	
30879BL	1 1/2" CAST BRASS LOCKNUT	72245 8	100	5 lbs.	
601430SN	3 1/2" STRAINER LOCKNUT	93422 6	25	5 lbs.	

STRAINERS &
REPLACEMENT PARTS

REPLACEMENT PARTS

Part Num.	Item Description	UPC# 046224 +	Ctn Qty	Ctn Wt	Line Art
STRAINER-REPLACEMENT PARTS - CONTINUED					
50879PBU	PLASTIC TAILPIECE WASHER-BULK	93184 3	100	1 lb.	
50879TPRU	1 1/2" PLASTIC THERMO PLASTIC RUBBER TAILPIECE WASHER	01662 5	100	1 lb.	

REPLACEMENT PARTS

Part Num.	Item Description	Exposed Trim	UPC# 046224 +	Ctn Qty	Ctn Wt	Line Art
ROLLER BALL STOP - U.S. PATENT # 5,428,847						
595RB	1 1/2" 20GA ROUGH BRASS	POLISHED CHROME	70343 3	5	19 lbs.	
597RB	1 1/2" 17GA ROUGH BRASS	POLISHED CHROME	70344 0	5	20 lbs.	
CONNECTED WASTE & OVERFLOW FOR LEG TUBS						
600SN	1 3/8" 22GA SATIN	POLISHED CHROME	93417 2	5	15 lbs.	
601SN	1 3/8" 17GA SATIN	POLISHED CHROME	93420 2	5	18 lbs.	
TILED IN TUBS CHAIN & STOPPER						
602RB	1 3/8" 22GA ROUGH BRASS	POLISHED CHROME	93429 5	5	15 lbs.	
604RB	1 1/2" 22GA ROUGH BRASS	POLISHED CHROME	93432 5	5	19 lbs.	

BRASS BATH DRAINS

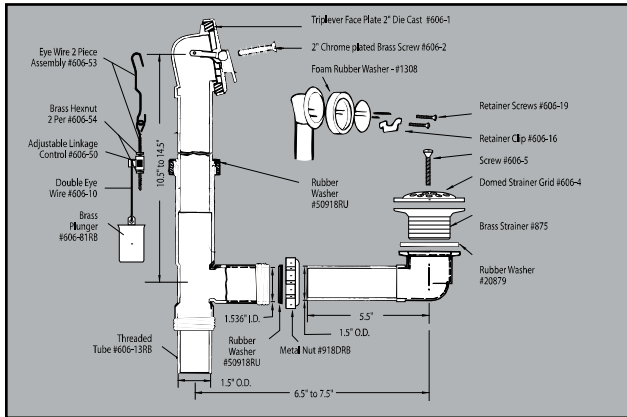

METAL BATH DRAIN BREAK DOWN

- FULL 1-1/2" CAST BRASS STRAINER FOR MAXIMUM DRAINAGE
- HIGH LUSTER FINISH ON EXPOSED PARTS
 - 4" OVERFLOW VERTICAL ADJUSTMENT
 - 2" WASTE SHOE HORIZONTAL ADJUSTMENT
 - 2" LONG BRASS FACE PLATE SCREWS
- ONE MAN INSTALLATION RETAINER CLIP
 - BAR CODED LABEL

TRIPLEVER

606RB	1 1/2" 20GA ROUGH BRASS	POLISHED CHROME	70037 1	5	19 lbs.	
606RBDS	1 1/2" 20GA ROUGH BRASS	PVD/POLISHED BRASS*	00262 8	5	19 lbs.	
607RB	1 1/2" 17GA ROUGH BRASS	POLISHED CHROME	93466 0	5	19 lbs.	

TRIPLEVER - WITH RETAINER CLIP

605RB	1 1/2" 20GA ROUGH BRASS	POLISHED CHROME	93437 0	5	19 lbs.	
605LARB	1 1/2" 20GA ROUGH BRASS	POLISHED CHROME	10736 3	5	19 lbs.	
605RBDS	1 1/2" 20GA ROUGH BRASS	PVD/POLISHED BRASS*	00255 0	5	19 lbs.	
608RB	1 1/2" 17GA ROUGH BRASS	POLISHED CHROME	93470 7	5	19 lbs.	

TRIPLEVER GARDEN TUB

609RB	1 1/2" 20GA ROUGH BRASS	POLISHED CHROME	93472 1	5	23 lbs.	
609RBDS	1 1/2" 20GA ROUGH BRASS	PVD/POLISHED BRASS*	00261 8	5	23 lbs.	
615RB	1 1/2" 17GA ROUGH BRASS	POLISHED CHROME	93492 9	5	24 lbs.	
615RBDS	1 1/2" 17GA ROUGH BRASS	PVD/POLISHED BRASS*	00258 1	5	24 lbs.	
615RBBN	1 1/2" 17GA ROUGH BRASS BRASS NUTS	POLISHED CHROME	00615 2	1	5.0 lbs.	

* "PVD" is a tarnish free product

BRASS BATH DRAINS

Part Num.	Item Description	Exposed Trim	UPC# 046224 +	Ctn Qty	Ctn Wt	Line Art
LIFT 'N TURN DIE CAST						
610ARB	1 1/2" 20GA ROUGH BRASS	POLISHED CHROME	93480 6	5	18 lbs.	
610ARBGT	1 1/2" 20GA ROUGH BRASS GARDEN TUB	POLISHED CHROME	01658 8	1	4 lbs.	
LIFT 'N TURN BRASS						
610RB	1 1/2" 20GA ROUGH BRASS	POLISHED CHROME	70038 8	5	19 lbs.	
610RBDS	1 1/2" 20GA ROUGH BRASS	PVD/POLISHED BRASS*	00231 4	5	19 lbs.	
611RB	1 1/2" 17GA ROUGH BRASS	POLISHED CHROME	93482 0	5	20 lbs.	
611RBDSGT	1 1/2" 17GA ROUGH BRASS GARDEN TUB	PVD/POLISHED BRASS*	01676 2	1	5 lbs.	
FOOT LOK STOP™						
612RB	1 1/2" 20GA ROUGH BRASS	POLISHED CHROME	70039 5	5	19 lbs.	
MECHANICAL POP-UP						
617RB	1 1/2" 20GA ROUGH BRASS	POLISHED CHROME	93499 8	5	19 lbs.	
TRIM KITS						
64-99PC	TRIPLEVER TRIM KIT	POLISHED CHROME	93600 8	10	5 lbs.	
64-99AN	TRIPLEVER TRIM KIT	ANTIQUE BRASS	00264 2	10	5 lbs.	
64-99DS	TRIPLEVER TRIM KIT	PVD/POLISHED BRASS*	93599 5	10	5 lbs.	
64-99WH	TRIPLEVER TRIM KIT	WHITE	72259 5	10	5 lbs.	
62-99PC	LIFT 'N TURN TRIM KIT WITH 2 HOLE FACEPLATE AND SCREWS	POLISHED CHROME	72071 3	10	5 lbs.	
62-99AN	LIFT 'N TURN TRIM KIT WITH 2 HOLE FACEPLATE AND SCREWS	ANTIQUE BRASS	93507 0	10	5 lbs.	
62-99DS	LIFT 'N TURN TRIM KIT WITH 2 HOLE FACE PLATE AND SCREWS	PVD/POLISHED BRASS*	00224 6	10	5 lbs.	
62-99WH	LIFT 'N TURN TRIM KIT WITH 2 HOLE FACE PLATE AND SCREWS	WHITE	72260 1	10	5 lbs.	
63-99PC	FOOT LOK STOP™ TRIM KIT WITH 2 HOLE FACE PLATE AND SCREWS	POLISHED CHROME	70751 6	10	5 lbs.	
63-99AN	FOOT LOK STOP™ TRIM KIT WITH 2 HOLE FACE PLATE AND SCREWS	ANTIQUE BRASS	93571 1	10	5 lbs.	
63-99DS	FOOT LOK STOP™ TRIM KIT WITH 2 HOLEFACE PLATE AND SCREWS	PVD/POLISHED BRASS*	00239 0	10	5 lbs.	
63-99WH	FOOT LOK STOP™ TRIM KIT WITH 2 HOLE FACE PLATE AND SCREWS	WHITE	72261 8	10	5 lbs.	
62-95PC	1 3/8" LIFT 'N TURN TRIM KIT WITH 2 HOLE FACEPLATE AND SCREWS WITH CONVERSION BUSHING	POLISHED CHROME	70746 2	10	5 lbs.	

Part Num.	Item Description	Exposed Trim	UPC# 046224 +	Ctn Qty	Ctn Wt	Line Art
TRIM KITS - CONTINUED						
62-95DS	1 3/8" LIFT 'N TURN TRIM KIT WITH 2 HOLE FACEPLATE AND SCREWS WITH CONVERSION BUSHING	PVD/POLISHED BRASS*	70747 9	10	5 lbs.	
62-95WH	1 3/8" LIFT 'N TURN TRIM KIT WITH 2 HOLE FACEPLATE AND SCREWS WITH CONVERSION BUSHING	WHITE	00251 2	10	5 lbs.	
65-99DS	ROLLERBALL TRIM KIT WITH 2 HOLE FACE PLATE AND SCREWS	PVD/POLISHED BRASS*	00253 6	10	5 lbs.	
66-99PC	ROLLERBALL TRIM KIT WITH SINGLE HOLE FACE PLATE AND SCREWS	POLISHED CHROME	73326 3	10	5 lbs.	
66-99DS	ROLLERBALL TRIM KIT WITH SINGLE HOLE FACE PLATE AND SCREWS	PVD/POLISHED BRASS*	00254 3	10	5 lbs.	
LINKAGE ASSEMBLY						
606-21	FOR TRIPLEVER 6" EYE WIRE, 10-32 BRASS EYE BOLT & BRASS CLEVIS PLUNGER		93451 6	25	8 lbs.	

TRIM KITS / PLASTIC BATH DRAINS

PLASTIC BATH DRAIN BREAK DOWN

- 1-1/2" IPS THREADED STRAINER
- ONE MAN INSTALLATION - TUB TACKS
- HIGH LUSTER FINISH ON EXPOSED PARTS
- 4-1/4" OVERFLOW VERTICAL ADJUSTMENT
- 2" WASTE SHOE HORIZONTAL ADJUSTMENT
- PRECISION MOLDED CONSTRUCTION
- 2" LONG BRASS FACE PLATE SCREWS
- BAR CODED LABEL

(ILLUSTRATION IS A 64 DELUXE TRIPLEVER (IN A 64, SUBSTITUTE A MOLDED PLASTIC STRAINER #82-W))

CHAIN & STOPPER						
61W	1 1/2" O.D. WHITE	POLISHED CHROME	93477 6	5	12 lbs.	
61CW	1 1/2" O.D. WHITE WITH CONDENSATE TUBE	POLISHED CHROME	72137 6	5	13 lbs.	
BRASS LIFT 'N TURN						
62W	1 1/2" O.D. WHITE	POLISHED CHROME	93517 9	5	8 lbs.	
62WDS	1 1/2" O.D. WHITE	PVD/POLISHED BRASS*	00222 2	5	8 lbs.	
62WDSBN	1 1/2" O.D. WHITE	PVD/BRUSHED NICKEL*	00997 9	5	8 lbs.	
62B	1 1/2" O.D. BLACK	POLISHED CHROME	93510 0	5	8 lbs.	
62BDS	1 1/2" O.D. BLACK	PVD/POLISHED BRASS*	00229 1	5	8 lbs.	

* "PVD" is a tarnish free product

PLASTIC BATH DRAINS

Part Num.	Item Description	Exposed Trim	UPC# 046224 +	Ctn Qty	Ctn Wt	Line Art
BRASS LIFT 'N TURN - CONTINUED						
62CW	1 1/2" O.D. WHITE WITH CONDENSATE TUBE	POLISHED CHROME	93516 2	5	8 lbs.	
62AW	1 1/2" O.D. WHITE	POLISHED CHROME	93514 8	5	8 lbs.	
62AB	1 1/2" O.D. BLACK	POLISHED CHROME	93509 4	5	8 lbs.	
62AW-8	1 1/2" O.D. WHITE WITH 8" TAILPIECE	POLISHED CHROME	71269 5	5	10 lbs.	
62ACW	1 1/2" O.D. WHITE WITH CONDENSATE TUBE	POLISHED CHROME	93513 1	5	9 lbs.	
FOOT LOK STOP™						
63W	1 1/2" O.D. WHITE	POLISHED CHROME	93575 9	5	8 lbs.	
63WDS	1 1/2" O.D. WHITE	PVD/POLISHED BRASS*	00236 9	5	8 lbs.	
63TTW	1 1/2" O.D. WHITE - BAGGED	POLISHED CHROME	01494 2	50	70 lbs.	
63B	1 1/2" O.D. BLACK	POLISHED CHROME	93573 5	5	8 lbs.	
63BDS	1 1/2" O.D. BLACK	PVD/POLISHED BRASS*	00240 6	5	8 lbs.	
TRIPLEVER - WITH STRAINER AND DOME GRID						
64W	1 1/2" O.D. WHITE PLASTIC STRAINER	POLISHED CHROME	93610 7	5	7 lbs.	
64WDS	1 1/2" O.D. WHITE - PLASTIC STRAINER	PVD/POLISHED BRASS*	00257 4	5	7 lbs.	
64WWH	1 1/2" O.D. WHITE - PLASTIC STRAINER	WHITE	72051 5	5	7 lbs.	
64B	1 1/2" O.D. BLACK - PLASTIC STRAINER	POLISHED CHROME	93601 5	5	7 lbs.	
64BDS	1 1/2" O.D. BLACK - PLASTIC STRAINER	PVD/POLISHED BRASS*	00256 7	5	7 lbs.	
64BWH	1 1/2" O.D. BLACK - PLASTIC STRAINER	WHITE	72141 3	5	7 lbs.	
64CW	1 1/2" O.D. WHITE WITH CONDENSATE TUBE - PLASTIC STRAINER	POLISHED CHROME	93608 4	5	8 lbs.	
64WDELUXE	1 1/2" O.D. WHITE - BRASS STRAINER	POLISHED CHROME	93616 9	5	8 lbs.	
64WDELUXDS	1 1/2" O.D. WHITE - BRASS STRAINER	PVD/POLISHED BRASS*	00259 8	5	8 lbs.	
64BDELUXE	1 1/2" O.D. BLACK - BRASS STRAINER	POLISHED CHROME	93606 0	5	8 lbs.	
MECHANICAL POP-UP						
67W	1 1/2" O.D. WHITE 	POLISHED CHROME	93632 9	5	8 lbs.	
67B	1 1/2" O.D. BLACK	POLISHED CHROME	93630 5	5	8 lbs.	
ROLLER BALL STOPS - U.S. PATENT # 5,428,847						
84W	1 1/2" O.D. WHITE	POLISHED CHROME	70310 5	5	8 lbs.	
84WDS	1 1/2" O.D. WHITE	PVD/POLISHED BRASS*	00243 7	5	8 lbs.	

Part Num.	Item Description	Exposed Trim	UPC# 046224 +	Ctn Qty	Ctn Wt	Line Art
-----------	------------------	--------------	---------------	---------	--------	----------

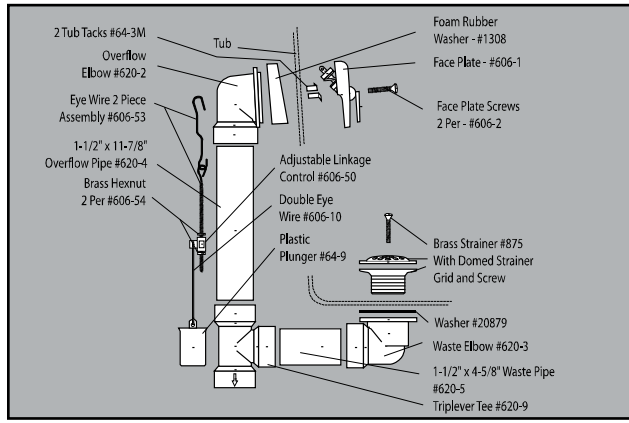

SCHEDULE 40 BATH DRAIN BREAK DOWN

- 1-1/2" IPS THREADED STRAINER
- HIGH LUSTER FINISH ON EXPOSED PARTS
- QUICK ADJUST LINKAGE ASSEMBLY
- ALL SCHEDULE 40 AVAILABLE LESS PIPE
- PRECISION MOLDED OVERFLOW, WASTE SHOE AND TEE
 - 2" LONG BRASS FACE PLATE SCREWS
- ONE MAN INSTALLATION - TUB TACKS
 - BAR CODED LABEL

(ILLUSTRATION IS A 640 TRIPLEVER - INDUSTRY EXCLUSIVE SCHEDULE 40 TRIPLEVER)

PLASTIC BATH DRAINS
SCHEDULE 40 DRAINS

SCH. 40 - BRASS LIFT 'N TURN - WITH PIPE & TEE						
620PVC	1 1/2" SCH 40 PVC	POLISHED CHROME	70053 1	5	13 lbs.	
620PVCDS	1 1/2" SCH 40 PVC	PVD/POLISHED BRASS*	00221 5	5	13 lbs.	
620PVCWH	1 1/2" SCH 40 PVC	WHITE	71273 2	5	13 lbs.	
620ABS	1 1/2" SCH 40 ABS	POLISHED CHROME	70041 8	5	13 lbs.	
620ABS	1 1/2" SCH 40 ABS	PVD/POLISHED BRASS*	00225 3	5	13 lbs.	

SCH. 40 - L.A. APPROVED - BRASS LIFT 'N TURN -WITH PIPE & TEE & ONE HOLE FACE PLATE						
620LAPVC	1 1/2" SCH 40 PVC	POLISHED CHROME	70499 7	5	13 lbs.	
620LAPVCWH	1 1/2" SCH 40 PVC	WHITE	70478 2	5	13 lbs.	
620LAABS	1 1/2" SCH 40 ABS	POLISHED CHROME	93535 3	5	13 lbs.	



SCH. 40 - METAL LIFT 'N TURN - WITH PIPE & TEE						
620APVC	1 1/2" SCH 40 PVC	POLISHED CHROME	93531 5	5	14 lbs.	
620AABS	1 1/2" SCH 40 ABS	POLISHED CHROME	70998 5	5	14 lbs.	
620ATTPVC	1 1/2" SCH 40 PVC - BAGGED	POLISHED CHROME	93534 6	10	14 lbs.	

SCH. 40 - L.A. APPROVED - METAL LIFT 'N TURN - WITH PIPE & TEE & ONE HOLE FACE PLATE						
620ALAPVC	1 1/2" SCH 40 PVC	POLISHED CHROME	00620 6	5	7 lbs.	

SCH. 40 - BRASS LIFT 'N TURN - HALF PAK LESS PIPE & TEE						
621PVC	1 1/2" SCH 40 PVC	POLISHED CHROME	93549 0	5	7 lbs.	
621PVCDS	1 1/2" SCH 40 PVC	PVD/POLISHED BRASS*	00220 8	5	7 lbs.	
621PVCWH	1 1/2" SCH 40 PVC	WHITE	71113 1	5	7 lbs.	
621ABS	1 1/2" SCH 40 ABS	POLISHED CHROME	93539 1	5	7 lbs.	
621ABS	1 1/2" SCH 40 ABS	PVD/POLISHED BRASS*	00227 7	5	7 lbs.	
621ABS	1 1/2" SCH 40 ABS	POLISHED CHROME	70561 1	5	7 lbs.	
621ABS	1 1/2" SCH 40 ABS	WHITE	70561 1	5	7 lbs.	

SCH. 40 - L.A. APPROVED - BRASS LIFT 'N TURN - LESS PIPE & TEE						
621LAPVC	1 1/2" SCH 40 PVC	POLISHED CHROME	93547 7	5	7 lbs.	
621LAPVCDS	1 1/2" SCH 40 PVC	PVD/POLISHED BRASS*	00232 1	5	7 lbs.	
621LAPVCWH	1 1/2" SCH 40 PVC	WHITE	72268 7	5	7 lbs.	
621LAABS	1 1/2" SCH 40 ABS	POLISHED CHROME	93545 2	5	7 lbs.	

Part Num.	Item Description	Exposed Trim	UPC# 046224 +	Ctn Qty	Ctn Wt	Line Art	
SCH. 40 - ZINC DIE CAST - LIFT 'N TURN HALF PAK - LESS PIPE & TEE							
621ACPVC	1 1/2" SCH 40 PVC WITH CONDENSATE TUBE	POLISHED CHROME	70615 1	5	7 lbs.		
621APVC	1 1/2" SCH 40 PVC	POLISHED CHROME	93544 5	5	7 lbs.		
621AABS	1 1/2" SCH 40 ABS	POLISHED CHROME	93538 4	5	7 lbs.		
621ALAPVC	1 1/2" SCH 40 PVC 1 HOLE FACEPLATE	POLISHED CHROME	93543 8	5	7 lbs.		
621ALAABS	1 1/2" SCH 40 ABS 1 HOLE FACEPLATE	POLISHED CHROME	93542 1	5	7 lbs.		
SCH. 40 - FOOT LOK STOP™ - WITH PIPE & TEE							
630PVC	1 1/2" SCH 40 PVC	POLISHED CHROME	70052 4	5	13 lbs.		
630PVCDS	1 1/2" SCH 40 PVC	PVD/POLISHED BRASS*	00237 6	5	13 lbs.		
630PVCWH	1 1/2" SCH 40 PVC	WHITE	71111 7	5	13 lbs.		
630ABS	1 1/2" SCH 40 ABS 	POLISHED CHROME	70040 1	5	13 lbs.		
630ABS DS	1 1/2" SCH 40 ABS	PVD/POLISHED BRASS*	00235 2	5	13 lbs.		
SCH. 40 - FOOT LOK STOP™ - WITH TEST PLUG							
630PVCTP	1 1/2" SCH 40 PVC	POLISHED CHROME	01581 9	1	3 lbs.		
630ABSTP	1 1/2" SCH 40 PVC	POLISHED CHROME	02105 6	1	3 lbs.		
SCH. 40 - L.A. APPROVED - FOOT LOK STOP™ - WITH PIPE & TEE & ONE HOLE FACE PLATE							
630LAPVC	1 1/2" SCH 40 PVC	POLISHED CHROME	70217 7	5	13 lbs.		
630LAPVCDS	1 1/2" SCH 40 PVC	PVD/POLISHED BRASS*	00275 8	5	13 lbs.		
630LAABS	1 1/2" SCH 40 ABS	POLISHED CHROME	93578 0	5	13 lbs.		
630LAABS DS	1 1/2" SCH 40 ABS	PVD/POLISHED BRASS*	00276 5	5	13 lbs.		
SCH. 40 - FOOT LOK STOP™ HALF PAK - LESS PIPE & TEE							
631PVC	1 1/2" SCH 40 PVC	POLISHED CHROME	93585 8	5	7 lbs.		
631PVCDS	1 1/2" SCH 40 PVC	PVD/POLISHED BRASS*	00234 5	5	7 lbs.		
631PVCWH	1 1/2" SCH 40 PVC	WHITE	72120 8	5	7 lbs.		
631ABS	1 1/2" SCH 40 ABS	POLISHED CHROME	93580 3	5	7 lbs.		
631ABS DS	1 1/2" SCH 40 ABS	PVD/POLISHED BRASS*	00238 3	5	7 lbs.		
SCH. 40 - L.A. APPROVED - FOOT LOK STOP™ HALF PAK - LESS PIPE & TEE							
631LAPVC	1 1/2" SCH 40 PVC	POLISHED CHROME	93583 4	5	7 lbs.		
631LAPVCDS	1 1/2" SCH 40 PVC	PVD/POLISHED BRASS*	00246 8	5	7 lbs.		
631LAABS DS	1 1/2" SCH 40 ABS	PVD/POLISHED BRASS*	00245 1	5	7 lbs.		

Part Num.	Item Description	Exposed Trim	UPC# 046224 +	Ctn Qty	Ctn Wt	Line Art
SCH. 40 - TRIPLEVER (SHOWN IN DETAIL ON PAGE 41) - WITH QUICK ADJUST LINKAGE						
640PVC	1 1/2" SCH 40 PVC	POLISHED CHROME	70241 2	5	13 lbs.	
640PVCDS	1 1/2" SCH 40 PVC	PVD/POLISHED BRASS*	00267 3	5	13 lbs.	
640ABS	1 1/2" SCH 40 ABS 	POLISHED CHROME	70341 9	5	13 lbs.	
640ABSDES	1 1/2" SCH 40 ABS	PVD/POLISHED BRASS*	00273 4	5	13 lbs.	
SCH. 40 - TRIPLEVER (SHOWN IN DETAIL ON PAGE 41) - WITH BRASS CLEVIS LINKAGE						
646PVC	1 1/2" SCH 40 PVC	POLISHED CHROME	02143 8	1	2 lbs.	
SCH. 40 - TRIPLEVER HALF PAK - LESS PIPE - QUICK ADJUST LINKAGE ADJUSTS FROM 14" TO 21 11/16"						
641PVC	1 1/2" SCH 40 PVC	POLISHED CHROME	70264 1	5	13 lbs.	
641PVCDS	1 1/2" SCH 40 PVC	POLISHED BRASS	00263 5	5	13 lbs.	
641ABS	1 1/2" SCH 40 ABS	POLISHED CHROME	70265 8	5	13 lbs.	
641ABSDES	1 1/2" SCH 40 ABS	PVD/POLISHED BRASS*	00274 1	5	13 lbs.	
SCH. 40 - ROLLER BALL STOP - U.S. PATENT # 5,428,847						
650PVC	1 1/2" SCH 40 PVC 	POLISHED CHROME	70340 2	5	11 lbs.	
650PVCDS	1 1/2" SCH 40 PVC	PVD/POLISHED BRASS*	00242 0	5	11 lbs.	
650PVCWH	1 1/2" SCH 40 PVC	WHITE	71127 8	5	11 lbs.	
650ABS	1 1/2" SCH 40 ABS	POLISHED CHROME	70495 9	5	11 lbs.	
SCH. 40 - ROLLER BALL STOP - U.S. PATENT # 5,428,847 - TWO HOLE FACE PLATE						
650PVCTP	1 1/2" SCH 40 PVC - WITH TEST PLUG	POLISHED CHROME	01580 2	1	2 lbs.	
650ABSTP	1 1/2" SCH 40 ABS - WITH TEST PLUG	POLISHED CHROME	02108 7	1	2 lbs.	
SCH. 40 - ROLLER BALL STOP - U.S. PATENT # 5,428,847 - ONE HOLE FACE PLATE						
653PVC	1 1/2" SCH 40 PVC	POLISHED CHROME	71000 4	5	11 lbs.	
653ABS	1 1/2" SCH 40 ABS	POLISHED CHROME	70999 2	5	11 lbs.	
SCH. 40 - ROLLERBALL STOP - U.S. PATENT # 5,428,847 - HALF PAK LESS PIPE & TEE						
651PVC	1 1/2" SCH 40 PVC	POLISHED CHROME	70368 6	5	7 lbs.	
651PVCDS	1 1/2" SCH 40 PVC	PVD/POLISHED BRASS*	00241 3	5	7 lbs.	
651PVCWH	1 1/2" SCH 40 PVC	WHITE	71294 7	5	7 lbs.	
651ABS	1 1/2" SCH 40 ABS	POLISHED CHROME	00651 0	5	7 lbs.	
SCH. 40 - ROLLERBALL STOP - U.S. PATENT # 5,428,847 - ONE HOLE FACE PLATE HALF PAK LESS PIPE & TEE						
652PVC	1 1/2" SCH 40 PVC	POLISHED CHROME	70336 5	5	10 lbs.	
652PVCDS	1 1/2" SCH 40 PVC	PVD/POLISHED BRASS*	00248 2	5	10 lbs.	
652PVCWH	1 1/2" SCH 40 PVC	WHITE	71272 5	5	10 lbs.	
652ABS	1 1/2" SCH 40 ABS	POLISHED CHROME	70749 3	5	10 lbs.	
652ABSDES	1 1/2" SCH 40 ABS	PVD/POLISHED BRASS*	00249 9	5	10 lbs.	

SCHEDULE 40 DRAINS

SEAL²TEST

Part Num.	Item Description	Exposed Trim	UPC# 046224 +	Ctn Qty	Ctn Wt	Line Art
-----------	------------------	--------------	---------------	---------	--------	----------

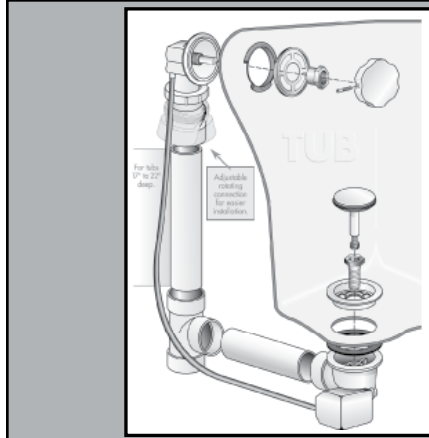

Reference below for product details

CABLE DRIVEN BATH DRAIN

- NO LINKAGE ADJUSTMENT NECESSARY
- INCLUDES OVERFLOW PROTECTION
- LARGE EASY-TO-TURN HANDLE FOR EASY OPENING AND CLOSING DRAIN
- ADJUSTABLE ROTATING CONNECTION FOR EASIER INSTALLATION
- AVAILABLE IN 6 POPULAR FINISHES

SCH. 40 - CABLE DRIVEN BATH DRAIN (SHOWN IN DETAIL ABOVE)

FITS MOST HOT TUBS, WHIRLPOOL TYPE & REGULAR BATHS 17" TO 22" DEEP

RECOMMENDED FOR USE ON FIBERGLASS, CAST IRON, ACRYLIC, MARBLE OR STEEL TUBS

645PVC	1 1/2" SCH 40 PVC	POLISHED CHROME	00645 9	5	13 lbs.
645PVCWH	1 1/2" SCH 40 PVC	WHITE	06451 0	5	13 lbs.
645PVCBN	1 1/2" SCH 40 PVC	BONE	06453 4	5	13 lbs.
645PVCBS	1 1/2" SCH 40 PVC	BISCUIT	06454 1	5	13 lbs.
645PVCDS	1 1/2" SCH 40 PVC	PVD/POLISHED BRASS*	01376 1	1	4 lbs.
645PVCDSBN	1 1/2" SCH 40 PVC	PVD/BRUSHED NICKEL*	01377 8	1	4 lbs.
645PVCDSPB	1 1/2" SCH 40 PVC	PVD/POLISHED BRASS*	01582 6	1	4 lbs.
645ABS	1 1/2" SCH 40 ABS	POLISHED CHROME	10645 6	5	13 lbs.
645ABSPB	1 1/2" SCH 40 ABS	POLISHED BRASS	02107 0	1	4 lbs.
645ABSDBN	1 1/2" SCH 40 ABS	PVD/BRUSHED NICKEL*	02106 3	1	4 lbs.

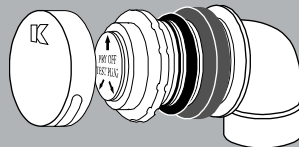
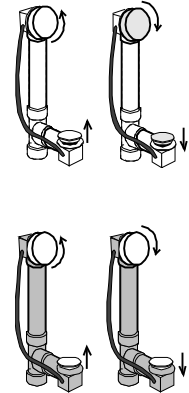

The screw on test cap allows for a one-man installation. Pry-Off the Overflow Test Plug with a knife or a screwdriver and Snap-on the decorative faceplate. Simple to Install... Simple to Test...

patent pending

SEAL²TEST BATH DRAIN

- CREATES A DOUBLE SEAL- INSIDE & OUTSIDE THE TUB WALL
- O-RING ENSURES "LEAK-FREE" TESTING
 - INSTALLS QUICKLY AND EASILY
- OVERFLOW OPENING REMAINS SEALED EVEN WHEN THE FACEPLATE IS REMOVED
- AVAILABLE IN PVC & ABS SCHEDULE 40
- AVAILABLE IN 11 POPULAR FINISHES

SEAL²TEST BATH DRAIN - OUR NEWEST IDEA IN THE FIGHT AGAINST LEAKS AND MOLD!

NEW OVERFLOW KITS WITH BATH DRAINS - LIFT 'N TURN (PATENT PENDING)

New

690PVC	1 1/2" SCH 40 PVC - POLISHED CHROME	00964 1	12	18 lbs.
690PVCWH	1 1/2" SCH 40 PVC - WHITE	01017 3	12	18 lbs..
690PVCDS	1 1/2" SCH 40 PVC - PVD/POLISHED BRASS*	01018 0	12	18 lbs.
690PVCDSBN	1 1/2" SCH 40 PVC - PVD/BRUSHED NICKEL*	02070 7	12	18 lbs.
690PVCSSN	1 1/2" SCH 40 PVC - PVD/SATIN NICKEL*	01035 7	12	18 lbs.

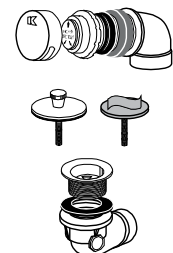

Part Num.	Item Description	Exposed Trim	UPC# 046224 +	Ctn Qty	Ctn Wt	Line Art
690PVCORB	1 1/2" SCH 40 PVC - OIL RUBBED BRONZE*		02034 9	1	2 lbs.	
690PVC PN	1 1/2" SCH 40 PVC - PVD/POLISHED NICKEL*		02028 8	1	2 lbs.	
690PVCSC	1 1/2" SCH 40 PVC - PVD/SATIN CHROME*		02016 5	1	2 lbs.	
690PVCSS	1 1/2" SCH 40 PVC - PVD/STAINLESS STEEL*		02021 9	1	2 lbs.	
690PVCVB	1 1/2" SCH 40 PVC - VENETIAN BRONZE*		02040 0	1	2 lbs.	
690PVCBSQ	1 1/2" SCH 40 PVC - BISCUIT		02069 1	12	18 lbs.	
690PVCDS PRN	1 1/2" SCH 40 PVC - PVD/PEARL NICKEL*		02068 4	12	18 lbs.	
690ABS	1 1/2" SCH 40 ABS - POLISHED CHROME		01047 0	12	18 lbs.	
690ABS WH	1 1/2" SCH 40 ABS - WHITE		01124 8	12	18 lbs.	
690ABS DS	1 1/2" SCH 40 ABS - PVD/POLISHED BRASS*		01130 9	12	18 lbs.	
690ABS DSBN	1 1/2" SCH 40 ABS - PVD/BRUSHED NICKEL*		02067 7	12	18 lbs.	
690ABS DSSN	1 1/2" SCH 40 ABS - PVD/SATIN NICKEL*		01254 2	12	18 lbs..	
690ABS ORB	1 1/2" SCH 40 ABS - OIL RUBBED BRONZE*		02035 6	1	2 lbs.	
690ABS PN	1 1/2" SCH 40 ABS - PVD/POLISHED NICKEL*		02029 5	1	2 lbs.	
690ABS SC	1 1/2" SCH 40 ABS - PVD/SATIN CHROME*		02017 2	1	2 lbs.	
690ABS SS	1 1/2" SCH 40 ABS - PVD/STAINLESS STEEL*		02022 6	1	2 lbs.	
690ABS VB	1 1/2" SCH 40 ABS - VENETIAN BRONZE*		02041 7	1	2 lbs.	
690ABS BSQ	1 1/2" SCH 40 ABS - BISCUIT		02065 3	12	18 lbs.	
690ABS DS PRN	1 1/2" SCH 40 ABS - PVD/PEARL NICKEL*		02066 0	12	18 lbs.	
SEAL²TEST BATH DRAIN - OUR NEWEST IDEA IN THE FIGHT AGAINST LEAKS AND MOLD!						
NEW OVERFLOW KITS WITH BATH DRAINS - ROLLER BALL (PATENT PENDING)						
691PVC	1 1/2" SCH 40 PVC - POLISHED CHROME		01257 3	12	18 lbs.	
691PVC WH	1 1/2" SCH 40 PVC - WHITE		01258 0	12	18 lbs.	
691PVC DS	1 1/2" SCH 40 PVC - PVD/POLISHED BRASS*		01259 7	12	18 lbs.	
691PVC DSBN	1 1/2" SCH 40 PVC - PVD/BRUSHED NICKEL*		02077 6	12	18 lbs.	
691PVC DSSN	1 1/2" SCH 40 PVC - PVD/SATIN NICKEL*		01260 3	12	18 lbs.	
691PVCORB	1 1/2" SCH 40 PVC - OIL RUBBED BRONZE*		02036 3	1	2 lbs.	
691PVC PN	1 1/2" SCH 40 PVC - PVD/POLISHED NICKEL*		02030 1	1	2 lbs.	
691PVCSC	1 1/2" SCH 40 PVC - PVD/SATIN CHROME*		02018 9	1	2 lbs.	
691PVCSS	1 1/2" SCH 40 PVC - PVD/STAINLESS STEEL*		02023 3	1	2 lbs.	
691PVCVB	1 1/2" SCH 40 PVC - VENETIAN BRONZE*		02042 4	1	2 lbs.	
691PVCBSQ	1 1/2" SCH 40 PVC - BISCUIT		02080 6	12	18 lbs.	
691PVCDS PRN	1 1/2" SCH 40 PVC - PVD/PEARL NICKEL*		02081 3	12	18 lbs.	
691ABS	1 1/2" SCH 40 ABS - POLISHED CHROME		01261 0	12	18 lbs.	
691ABS WH	1 1/2" SCH 40 ABS - WHITE		01262 7	12	18 lbs.	
691ABS DS	1 1/2" SCH 40 ABS - PVD/POLISHED BRASS*		01263 4	12	18 lbs.	
691ABS DSBN	1 1/2" SCH 40 ABS - PVD/BRUSHED NICKEL*		02078 3	12	18 lbs.	
691ABS DSSN	1 1/2" SCH 40 ABS - PVD/SATIN NICKEL*		01264 1	12	18 lbs.	
691ABS ORB	1 1/2" SCH 40 ABS - OIL RUBBED BRONZE*		02037 0	1	2 lbs.	
691ABS PN	1 1/2" SCH 40 ABS - PVD/POLISHED NICKEL*		02031 8	1	2 lbs.	
691ABS SC	1 1/2" SCH 40 ABS - PVD/SATIN CHROME*		02019 6	1	2 lbs.	
691ABS SS	1 1/2" SCH 40 ABS - PVD/STAINLESS STEEL*		02025 7	1	2 lbs.	
691ABS VB	1 1/2" SCH 40 ABS - VENETIAN BRONZE*		02043 1	1	2 lbs.	
691ABS BSQ	1 1/2" SCH 40 ABS - BISCUIT		02079 0	12	18 lbs.	
691ABS DS PRN	1 1/2" SCH 40 ABS - PVD/PEARL NICKEL*		02082 0	12	18 lbs.	

New

SPECIALTY DRAINS

SPECIALTY DRAINS

Part Num.	Item Description	Exposed Trim	UPC# 046224 +	Ctn Qty	Ctn Wt	Line Art
SEAL²TEST BATH DRAIN - OUR NEWEST IDEA IN THE FIGHT AGAINST LEAKS AND MOLD!						
NEW OVERFLOW KITS WITH BATH DRAINS - FOOT LOK STOP™ (PATENT PENDING)						
692PVC	1 1/2" SCH 40 PVC - POLISHED CHROME		01272 6	12	18 lbs.	
692PVCWH	1 1/2" SCH 40 PVC - WHITE		01273 3	12	18 lbs.	
692PVCDS	1 1/2" SCH 40 PVC - PVD/POLISHED BRASS*		01274 0	12	18 lbs.	
692PVCDSBN	1 1/2" SCH 40 PVC - PVD/BRUSHED NICKEL*		02072 1	12	18 lbs.	
692PVCDSN	1 1/2" SCH 40 PVC - PVD/SATIN NICKEL*		01278 8	12	18 lbs.	
692PVCORB	1 1/2" SCH 40 PVC - OIL RUBBED BRONZE*		02038 7	1	2 lbs.	
692PVCPCN	1 1/2" SCH 40 PVC - PVD/POLISHED NICKEL*		02032 5	1	2 lbs.	
692PVCSC	1 1/2" SCH 40 PVC - PVD/SATIN CHROME*		02020 2	1	2 lbs.	
692PVCSS	1 1/2" SCH 40 PVC - PVD/STAINLESS STEEL*		02026 4	1	2 lbs.	
692PVCVB	1 1/2" SCH 40 PVC - VENETIAN BRONZE*		02044 8	1	2 lbs.	
692PVCBSQ	1 1/2" SCH 40 PVC - BISCUIT		02071 4	12	18 lbs.	
692PVCDSPRN	1 1/2" SCH 40 PVC - PVD/PEARL NICKEL*		02073 8	12	18 lbs.	
692ABS	1 1/2" SCH 40 ABS - POLISHED CHROME		01317 4	12	18 lbs.	
692ABSWH	1 1/2" SCH 40 ABS - WHITE		01659 5	12	18 lbs.	
692ABSDES	1 1/2" SCH 40 ABS - PVDPOLISHED BRASS*		01660 1	12	18 lbs.	
692ABSDESBN	1 1/2" SCH 40 ABS - PVD/BRUSHED NICKEL*		02076 9	12	18 lbs.	
692ABSDESBN	1 1/2" SCH 40 ABS - PVD/SATIN NICKEL*		01661 8	12	18 lbs.	
692ABSORB	1 1/2" SCH 40 ABS - OIL RUBBED BRONZE*		02039 4	1	2 lbs.	
692ABSPN	1 1/2" SCH 40 ABS - PVD/POLISHED NICKEL*		02033 2	1	2 lbs.	
692ABSSC	1 1/2" SCH 40 ABS - PVD/SATIN CHROME*		02046 2	1	2 lbs.	
692ABSSS	1 1/2" SCH 40 ABS - PVD/STAINLESS STEEL*		02027 1	1	2 lbs.	
692ABSVB	1 1/2" SCH 40 ABS - VENETIAN BRONZE*		02045 5	1	2 lbs.	
692ABSBSQ	1 1/2" SCH 40 ABS - BISCUIT		02074 5	12	18 lbs.	
692ABSDESBN	1 1/2" SCH 40 ABS - PVD/PEARL NICKEL*		02075 2	12	18 lbs.	

New

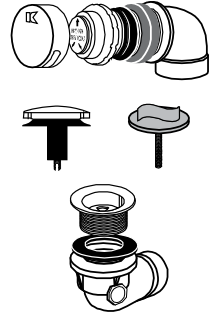

SEAL²TEST BATH DRAIN ROUGH IN PACK KIT

- CREATES A DOUBLE SEAL- INSIDE & OUTSIDE THE TUB WALL
- O-RING ENSURES "LEAK-FREE" TESTING
 - INSTALLS QUICKLY AND EASILY
- OVERFLOW OPENING REMAINS SEALED EVEN WHEN THE FACEPLATE IS REMOVED
 - AVAILABLE IN PVC SCHEDULE 40

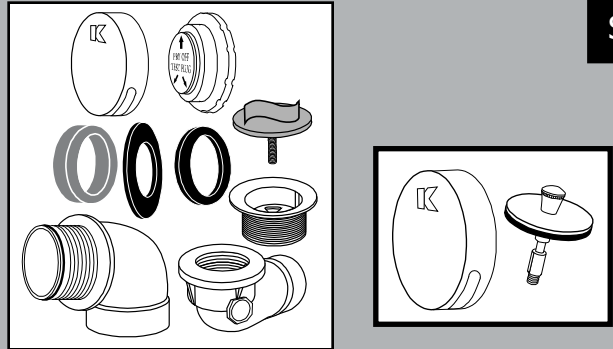

ROUGH IN PACK KITS - SCH. 40 BATH DRAIN WITH TEST PLUG KIT

New

LESS SCH. 40 TUBE AND TRIM FINISH						
690TKPVC	POLISHED CHROME TRIM FINISH KIT LIFT 'N TURN - BOXED		01959 6	10	9 lbs.	
690TKPVCDS	PVD/POLISHED BRASS TRIM FINISH* KIT LIFT 'N TURN - BOXED		02144 5	10	4 lbs.	
690RKPVC	PVC BATH DRAIN ROUGH N PACK KIT - BOXED		01958 9	10	9 lbs.	
690RKPVCDS	PVD/POLISHED BRASS TRIM FINISH* KIT LIFT 'N TURN - BOXED		02145 2	10	13 lbs.	
690RKABS	ABS BATH DRAIN ROUGH N PACK KIT - BOXED		02213 8	10	13 lbs.	

Part Num.	Item Description	Exposed Trim	UPC# 046224 +	Ctn Qty	Ctn Wt	Line Art
-----------	------------------	--------------	---------------	---------	--------	----------

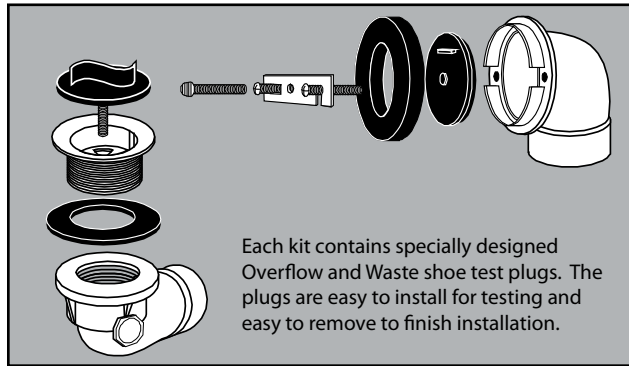

Each kit contains specially designed Overflow and Waste shoe test plugs. The plugs are easy to install for testing and easy to remove to finish installation.

BATH DRAIN ROUGH IN PACK KIT

PLUMBING CODES MAY REQUIRE DWV SYSTEMS BE PRESSURE TESTED TO ENSURE THAT THE INSTALLATION IS FREE OF LEAKS. THIS TEST INVOLVES PLUGGING ALL THE OPENINGS AND APPLYING HIGHER THAN NORMAL WORKING PRESSURE TO THE SYSTEM. THIS TYPE OF TESTING ENSURES THAT YOUR DWV SYSTEM IS PROPERLY INSTALLED WITHOUT THE POSSIBILITY OF WATER OR SEWER GASES ENTERING YOUR HOME.

SPECIALTY DRAINS

ROUGH IN KIT CONTRACTOR KITS - BAGGED - CONTAINS EVERYTHING NECESSARY FOR A SCH. 40 BATH DRAIN WITH TEST PLUG KIT - LESS SCH. 40 TUBE AND TRIM FINISH

New

ROUGHINKITPV	PVC - ROUGH N PACK KIT	POLISHED CHROME	01100 2	10	10 lbs.
ROUGHNKITPBN	PVC - ROUGH N PACK KIT	PVD/BRUSHED NICKEL*	01347 1	10	10 lbs.
ROUGHINKITPW	PVC - ROUGH N PACK KIT	WHITE	01340 2	10	10 lbs.
ROUGHINKITBS	PVC - ROUGH N PACK KIT	BISCUIT	01947 3	10	10 lbs.
ROUGHINKITAB	ABS - ROUGH N PACK KIT	POLISHED CHROME	01210 8	10	10 lbs.
LIFNTURNTRIM	TRIM FINISH KIT - LIFT N TURN	POLISHED CHROME	01098 2	10	5 lbs.
LIFNTURNTRBS	TRIM FINISH KIT - LIFT N TURN	BISCUIT	01946 6	10	4 lbs.
LIFNTURNTRBN	TRIM FINISH KIT - LIFT N TURN	BRUSHED NICKEL	01349 5	10	4 lbs.
LIFNTURNTRMW	TRIM FINISH KIT - LIFT N TURN	WHITE	01339 6	10	4 lbs.
PUSHNPULTRIM	TRIM FINISH KIT - PUSH N PULL	POLISHED CHROME	01099 9	10	5 lbs.
PUSHNPULTRBN	TRIM FINISH KIT - PUSH N PULL	PVD/BRUSHED NICKEL*	01348 8	10	4 lbs.

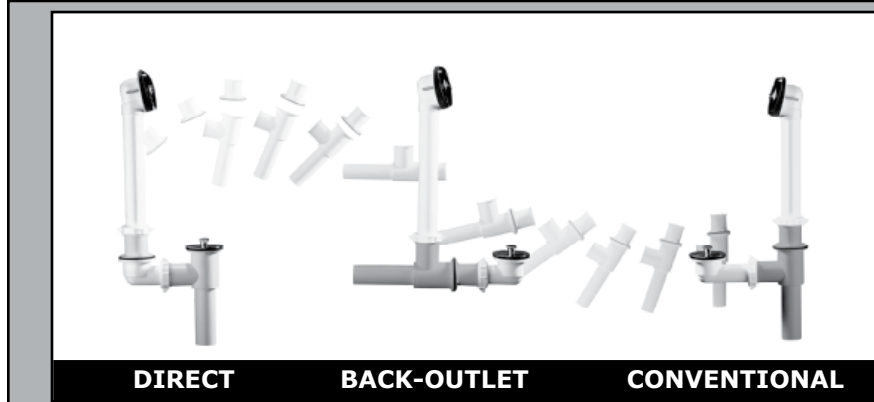
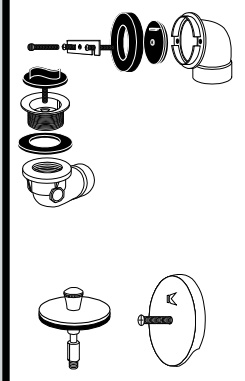

Transformation of a Triad

3 drains in 1!

THE "TRIAD" PROVIDES THREE SOLUTIONS TO EVERY BATH DRAIN INSTALLATION

TRIAD - U.S. PATENT # 4,920,582 - LIFT 'N TURN
THREE DRAINS IN ONE! - DIRECT, CONVENTIONAL, AND BACK-OUTLET DRAIN

70W	1 1/2" OD WHITE	POLISHED CHROME	93666 4	5	13 lbs.
70WDS	1 1/2" OD WHITE	PVD/POLISHED BRASS*	00228 4	5	13 lbs.

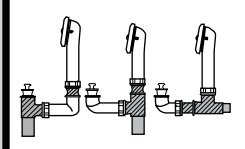

TRIAD - U.S. PATENT # 4,920,582 - FOOT LOCK STOP™

THREE DRAINS IN ONE! - DIRECT, CONVENTIONAL, AND BACK-OUTLET DRAIN

71W	1 1/2" WHITE	 POLISHED CHROME	93707 4	5	7 lbs.
-----	--------------	---	---------	---	--------

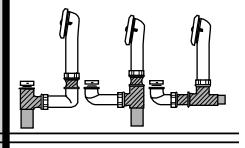

* "PVD" is a tarnish free product



SPECIALTY DRAINS

Part Num.	Item Description	Exposed Trim	UPC# 046224 +	Ctn Qty	Ctn Wt	Line Art
TRIAD - U.S. PATENT # 4,920,582 ROLLER BALL STOP - U.S. PATENT # 5,428,847						
THREE DRAINS IN ONE! - A DIRECT, CONVENTIONAL, AND BACK-OUTLET DRAIN						
86W	1 1/2" WHITE	POLISHED CHROME	70486 7	5	8 lbs.	
86WDS	1 1/2" WHITE	PVD/POLISHED BRASS*	00247 5	5	8 lbs.	
SIDE OUTLET BATHDRAIN - LIFT 'N TURN						
72W	1 1/2" WHITE	POLISHED CHROME	70224 5	5	8 lbs.	
SIDE OUTLET BATHDRAIN - FOOT LOK STOP™						
77W	1 1/2" WHITE	POLISHED CHROME	70225 2	5	8 lbs.	
SIDE OUTLET-ROLLER BALL - U.S. PATENT # 5,428,847						
87W	1 1/2" WHITE	POLISHED CHROME	70378 5	5	8 lbs.	
DIRECT OUTLET - FOOT LOK STOP™						
68W	1 1/2" WHITE	POLISHED CHROME	93653 4	5	8 lbs.	
DIRECT OUTLET - LIFT 'N TURN						
69W	1 1/2" OD WHITE	POLISHED CHROME	93662 6	5	6 lbs.	
69WDS	1 1/2" OD WHITE	PVD/POLISHED BRASS*	00230 4	5	6 lbs.	
FOOT LOK ASSEMBLIES						
63-1CF	5/16" THREADED SHAFT WITH STRAINER	POLISHED CHROME	93560 5	10	5 lbs.	
63-1CFAN	5/16" THREADED SHAFT WITH STRAINER	ANTIQUE BRASS	93561 2	10	5 lbs.	
63-1CFPB	5/16" THREADED SHAFT WITH STRAINER	POLISHED BRASS	93562 9	10	5 lbs.	
63-1F	CARTRIDGE ONLY	POLISHED CHROME	93563 6	10	2 lbs.	
63-1FAN	CARTRIDGE ONLY	ANTIQUE BRASS	93564 3	10	2 lbs.	
63-1FPB	CARTRIDGE ONLY	POLISHED BRASS	93565 0	10	2 lbs.	
63-50PC	WEST COAST CARTRIDGE - 3/8" THREADED SHAFT	POLISHED CHROME	93568 1	10	2 lbs.	
63-50AN	WEST COAST CARTRIDGE - 3/8" THREADED SHAFT	ANTIQUE BRASS	72247 2	10	2 lbs.	
63-50PB	WEST COAST CARTRIDGE - 3/8" THREADED SHAFT	POLISHED BRASS	70753 0	10	2 lbs.	
63-51PC	FOOT LOK WEST COAST STRAINER ONLY - 3/8" THREAD	POLISHED CHROME	93570 4	10	2 lbs.	

Part Num.	Item Description	Exposed Trim	UPC# 046224 +	Ctn Qty	Ctn Wt	Line Art
LIFT 'N TURN ASSEMBLY						
62-1CF	BRASS	POLISHED CHROME	93501 8	10	6 lbs.	
62-1CFPB	BRASS	POLISHED BRASS	93503 2	10	6 lbs.	
62-3F	LIFT N TURN WITH STRAINER	POLISHED CHROME	93504 9	10	6 lbs.	
ROLLER BALL STOP ASSEMBLY U.S. PATENT #5,428,847						
63-4PC	ROLLER BALL STOP ASSEMBLY	POLISHED CHROME	71002 8	10	2 lbs.	
63-4AN	ROLLER BALL STOP ASSEMBLY	ANTIQUE BRASS	72248 9	10	2 lbs.	
63-4WHT	ROLLER BALL STOP ASSEMBLY	WHITE	73302 7	10	2 lbs.	
MECHANICAL POP-UP ASSEMBLIES						
617-4	ROCKER ARM ASSEMBLY		93498 1	25	3 lbs.	
FACE PLATES						
620-10PC	SINGLE HOLE OVERFLOW	POLISHED CHROME	93525 4	25	4 lbs.	
606-2PC	FACE PLATE SCREW	POLISHED CHROME	93448 6	50	2 lbs.	
606-1PC	TRIPLEVER WITH SCREWS & COTTER PIN	POLISHED CHROME	93441 7	25	7 lbs.	
WASTE SHOES - WITH STRAINER						
616SN	1 3/8"		93495 0	6	5 lbs.	
614RB	1 1/2" ROUGH BRASS - FINE THREAD		93490 5	6	5 lbs.	
6141RB	1 1/2" ROUGH BRASS - COARSE THREAD		93491 2	6	7 lbs.	
PLASTIC WASTE SHOES						
64-6PVC	1 1/2" OD X 6 1/2" WHITE		93592 6	25	3 lbs.	
64-6ABS	1 1/2" OD X 6 1/2" BLACK		71025 7	25	3 lbs.	
LINKAGE ASSEMBLY FOR PLASTIC						
64-14PVC	FOR TRIPLEVER 6" EYE WIRE, 10-32 BRASS EYE BOLT & CLEVIS PLUNGER WHITE		93589 6	25	1 lb.	
64-14ABS	FOR TRIPLEVER 6" EYE WIRE, 10-32 BRASS EYE BOLT & CLEVIS PLUNGER BLACK		71053 0	25	1 lb.	

BATH DRAIN
ACCESSORIES

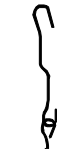
BATH DRAIN ACCESSORIES

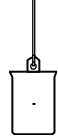
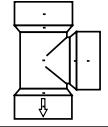
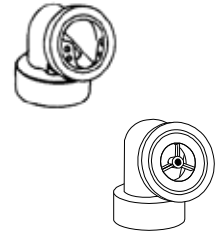
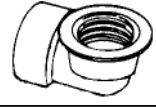
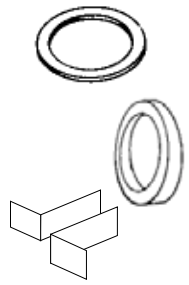
Part Num.	Item Description	Exposed Trim	UPC# 046224 +	Ctn Qty	Ctn Wt	Line Art
QUICK ADJUST LINKAGE ASSEMBLIES						
640-14W	FOR TRIPLEVER, 606-53 TWO PIECE EYE WIRE, 606-54 BRASS HEX NUTS (2), 64-9 PLASTIC PLUNGER, ADJ LINKAGE CONTROL 606-54, DBL. EYE WIRE 606-10,.. ADJ. FROM 11" TO 14 3/4" WHITE PLUNGER		71026 4	5	11 lbs.	
641-14W	FOR TRIPLEVER 1/2 PAK, 606-51 TOP EYE WIRE, 606-54 BRASS HEX NUTS (2), 64-9 PLASTIC PLUNGER, ADJ. LINKAGE CONTROL 606-50, DOUBLE EYE WIRE 606-55. ADJ. FROM 14" TO 21 11/16", WHITE PLUNGER		71031 8	5	11 lbs.	
641-14B	FOR TRIPLEVER 1/2 PAK, 606-51 TOP EYE WIRE, 606-54 BRASS HEX NUTS (2), 64-9 PLASTIC PLUNGER, ADJ. LINKAGE CONTROL 606-50, DOUBLE EYE WIRE 606-55. ADJ. FROM 14" TO 21 11/16", BLACK PLUNGER		71032 5	5	11 lbs.	
SCHEDULE 40 TRIPLEVER TEES						
620-9W	1 1/2" PVC SANITARY TRIPLEVER TEE		71034 9	25	8 lbs.	
620-9B	1 1/2" ABS SANITARY TRIPLEVER TEE		71033 2	25	8 lbs.	
SCHEDULE 40 OVERFLOWS						
620-2W	1 1/2" PVC - TWO HOLE		93528 5	25	5 lbs.	
620-2B	1 1/2" ABS - TWO HOLE		93526 1	25	5 lbs.	
620-2LAPVC	1 1/2" PVC - ONE HOLE		72175 8	25	5 lbs.	
620-2LAABS	1 1/2" ABS - ONE HOLE		72176 5	25	5 lbs.	
SCHEDULE 40 WASTE SHOES						
620-3W	1 1/2" PVC - THREADED		93530 8	25	6 lbs.	
620-3B	1 1/2" ABS - THREADED		93529 2	25	6 lbs.	
WASHERS						
622RU	RUBBER WASTE STRAINER WASHER		93552 0	100	1 lb.	
20879RU	WASTE SHOE WASHER		92286 5	100	1 lb.	
1308LRU	TUB OVERFLOW WASHER		92008 3	100	2 lbs.	
64-3M	TUB TACK		93590 2	100	1 lb.	

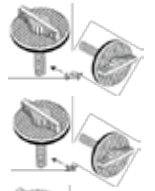
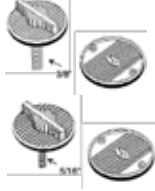
Part Num.	Item Description	Exposed Trim	UPC# 046224 +	Ctn Qty	Ctn Wt	Line Art
TEST PLUG KIT FOR SCH 40 BATHDRAINS						
620-7G	TEST PLUG FOR SINGLE HOLE OVERFLOW - GREY		00306 9	25	12 lbs.	
620-7B	TEST PLUG FOR SINGLE HOLE OVERFLOW - BLACK		00117 1	25	12 lbs.	
TEST PLUG KIT FOR SCH 40 BATHDRAINS - TWO HOLE						
620-8B	TEST PLUG FOR TWO HOLE OVERFLOW - BLACK		00208 6	25	12 lbs.	
620-8G	TEST PLUG FOR TWO HOLE OVERFLOW - GREY		00207 9	25	12 lbs.	

BATH DRAIN
ACCESSORIES

Part Num.	Item Description	Finish	UPC# 046224 +	Ctn Qty	Ctn Wt	List Price	Line Art
-----------	------------------	--------	---------------	---------	--------	------------	----------

QUARTER TURN VALVES



QUARTER TURN VALVES

All Keeneey Quarter Turn Valves feature:

- Solid Chrome Plated Brass Ball
- Brass Forged Body
- All valve bodies and components CNC Machined to our Engineering Tolerances & Specifications
- Solid Brass Stem
- Flow Rates 20% higher than ASME 112.18.1M Minimum Standard
- O-rings designed to be used at working temperatures ranging between -40° and 250°
- Teflon Seats - melting point of 621° Fahrenheit
- Valves made from Brass Alloy that complies with NSF61 Section 9
- Over 80 different configurations
- Color Coded Boxes
- 100% Pressure Leak Tested



Chrome Plated Brass Ball
Engineering precision in production of our CNC machined chrome plated brass ball, snugly matched with Teflon® seals to prevent seizing in any water condition ensures a long valve life, and your customer's satisfaction.



QUARTER TURN VALVES

F.I.P. X COMPRESSION - STRAIGHT QUARTER TURN VALVES - BOXED

2055PC	3/8" F.I.P. X 3/8" O.D.		CHROME	00185 0	24	12 lbs.
2055DS	3/8" F.I.P. X 3/8" O.D.		PVD/POLISHED BRASS*	00951 1	12	12 lbs.
2058PC	1/2" F.I.P. X 3/8" O.D.		CHROME	00182 9	24	8.4 lbs.
2058DS	1/2" F.I.P. X 3/8" O.D.		PVD/POLISHED BRASS*	00952 8	12	8.4 lbs.
2060PC	1/2" X 7/16" - 1/2" O.D.- SLIP JOINT		CHROME	00785 2	12	9.9 lbs.
2059PC	1/2" F.I.P. X 1/2" O.D.		CHROME	00784 5	12	9.5 lbs.

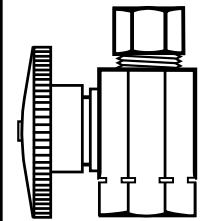

COMPRESSION X COMPRESSION - STRAIGHT QUARTER TURN VALVES - BOXED

2071PC	3/8" O.D. COMP. X 3/8" O.D.		CHROME	00793 7	24	8.8 lbs.
2102PC	1/2" O.D. (3/8" NOM. COPPER) X 3/8" O.D.		CHROME	00896 5	24	8.8 lbs.
2068PC	5/8" O.D. COMP. X 3/8" O.D.		CHROME	00186 7	24	9.5 lbs.
2068DS	5/8" O.D. COMP. X 3/8" O.D.		PVD/POLISHED BRASS*	00953 5	12	4.7 lbs.
2070PC	5/8" O.D. X 7/16" - 1/2" O.D.- SLIP JOINT		CHROME	00792 0	12	5.5 lbs.
2069PC	5/8" O.D. X 1/2" O.D.		CHROME	00791 3	12	3.9 lbs.
2041PC	5/8" O.D. COARSE THREAD X 3/8" O.D.		CHROME	00811 8	12	4.7 lbs.
2042PC	5/8" O.D. COARSE THREAD X 7/16" - 1/2" O.D.- SLIP JOINT		CHROME	00812 5	12	4.4 lbs.

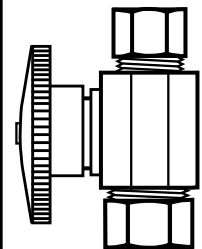

SWEAT X COMPRESSION - STRAIGHT QUARTER TURN VALVE - BOXED

2781PC	1/2" COPPER SWEAT X 3/8" O.D.		CHROME	00795 1	24	7.6 lbs.
--------	-------------------------------	--	--------	---------	----	----------

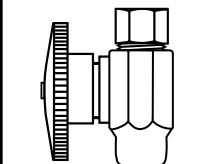

Part Num.	Item Description	Finish	UPC# 046224 +	Ctn Qty	Ctn Wt	List Price	Line Art	
CPVC X COMPRESSION - STRAIGHT QUARTER TURN VALVE - BOXED								
2881PC	1/2" NOM. X 3/8" O.D.	CHROME	00797 5	24	10.6 lbs.			
PEX X COMPRESSION - STRAIGHT QUARTER TURN VALVE - BOXED								
2883PC	1/2" NOM. X 3/8" O.D.	CHROME	00799 9	12	3.8 lbs.			
F.I.P. X F.I.P. - STRAIGHT QUARTER TURN VALVE - BOXED								
2057PC	1/2" F.I.P. X 1/2" F.I.P.	CHROME	00919 1	24	8.4 lbs.			
SWEAT INLET WITH 5" EXTENSION TUBE- STRAIGHT QUARTER TURN VALVE - BOXED								
2101PC	1/2" NOM. SWEAT W/ 5" EXT X 3/8" O.D. - DEEP FLANGE	CHROME	00921 4	12	6.9 lbs.			
F.I.P. X FLARE- STRAIGHT QUARTER TURN VALVES - BOXED								
2710PC	1/2" F.I.P. X 3/8" O.D. FLARE	CHROME	00939 9	12	4.2 lbs.			
2711PC	1/2" F.I.P. X 1/2" O.D. FLARE	CHROME	00942 9	24	8.4 lbs.			
F.I.P. X COMPRESSION - ANGLE QUARTER TURN VALVES - BOXED								
2047PC	3/8" F.I.P. X 3/8" O.D.	CHROME	00779 1	24	7.6 lbs.			
2047DS	3/8" F.I.P. X 3/8" O.D.	PVD/POLISHED BRASS*	00946 7	12	7.6 lbs.			
2046PC	1/2" F.I.P. X 1/4" O.D.	CHROME	00778 4	12	4 lbs.			
2048PC	1/2" F.I.P. X 3/8" O.D.	CHROME	00184 3	24	8.4 lbs.			
2048DS	1/2" F.I.P. X 3/8" O.D.	PVD/POLISHED BRASS*	00947 4	12	8.4 lbs.			
2051PC	1/2" F.I.P. X 7/16" O.D.	CHROME	00783 8	12	4.7 lbs.			
2050PC	1/2" F.I.P. X 7/16"-1/2" O.D. - SLIP JOINT	CHROME	00782 1	24	9.9 lbs.			
2050DS	1/2" F.I.P. X 7/16"-1/2" O.D. - SLIP JOINT	PVD/POLISHED BRASS*	00948 1	12	9.9 lbs.			
2049PC	1/2" F.I.P. X 1/2" O.D.	CHROME	00781 4	12	4.4 lbs.			
COMPRESSION X COMPRESSION - ANGLE QUARTER TURN VALVES - BOXED								
2621PC	3/8" O.D. X 3/8" O.D.	CHROME	00786 9	12	4.2 lbs.			
2053PC	1/2" O.D. (3/8" NOM. COPPER) X 3/8" O.D.	CHROME	00895 8	12	3.9 lbs.			
2626PC	5/8" O.D. X 1/4" O.D.	CHROME	00790 6	12	4.4 lbs.			
2622PC	5/8" O.D. X 3/8" O.D.	CHROME	00183 6	24	9.5 lbs.			
2622DS	5/8" O.D. X 3/8" O.D.	PVD/POLISHED BRASS*	00949 8	12	4.2 lbs.			
2625PC	5/8" O.D. X 7/16" O.D.	CHROME	00789 0	12	4.2 lbs.			
2623PC	5/8" O.D. X 7/16"-1/2" O.D.- SLIP JOINT	CHROME	00787 6	12	5.1 lbs.			
2624PC	5/8" O.D. X 1/2" O.D.	CHROME	00788 3	12	4.9 lbs.			
2659PC	5/8" O.D. COARSE THREAD X 3/8" O.D.	CHROME	00813 2	24	8.8 lbs.			
2670PC	5/8" O.D. COARSE THREAD X 7/16"-1/2" O.D.	CHROME	00814 9	12	4.7 lbs.			
SWEAT X COMPRESSION - ANGLE QUARTER TURN VALVE - BOXED								
2780PC	1/2" COPPER SWEAT X 3/8" O.D.	CHROME	00794 4	24	7.6 lbs.			
CPVC X COMPRESSION - ANGLE QUARTER TURN VALVE - BOXED								
2880PC	1/2" NOM. X 3/8" O.D.	CHROME	00185 0	24	10.2 lbs.			







QUARTER TURN VALVES

QUARTER TURN VALVES~ADD-A-TEE ADAPTERS~ADAPTERS

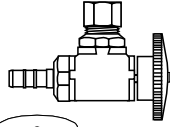
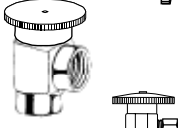
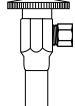
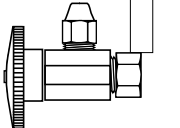
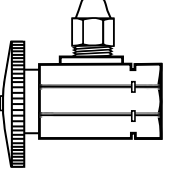

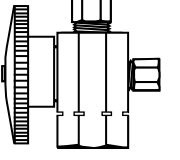
THE KEENEY MANUFACTURING COMPANY

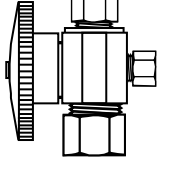
QUARTER TURN VALVES / ADAPTERS

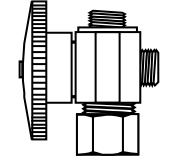
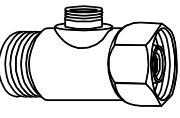
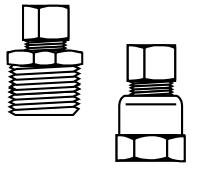
Part Num.	Item Description	Finish	UPC# 046224 +	Ctn Qty	Ctn Wt	List Price	Line Art
PEX X COMPRESSION - ANGLE QUARTER TURN VALVE - BOXED							
2882PC	1/2" NOM. X 3/8" O.D. 	CHROME	00798 2	24	8.4 lbs.		
F.I.P. X F.I.P. - ANGLE QUARTER TURN VALVE - BOXED							
2052PC	1/2" F.I.P. X 1/2" F.I.P.	CHROME	00918 4	24	8 lbs.		
SWEAT INLET WITH 5" EXTENSION TUBE - ANGLE QUARTER TURN VALVE - BOXED							
2100PC	1/2" NOM. SWEAT W/ 5" EXT. X 3/8" O.D. - DEEP FLANGE	CHROME	00920 7	12	6.9 lbs.		
COMPRESSION X FLARE - ANGLE QUARTER TURN VALVE - BOXED							
2722PC	5/8" O.D. (1/2" NOM. COPPER) X 3/8" O.D.	CHROME	00938 2	12	4.9 lbs.		
F.I.P. X FLARE - ANGLE QUARTER TURN VALVES - BOXED							
2720PC	3/8" F.I.P. X 3/8" O.D. FLARE	CHROME	00933 7	24	8 lbs.		
2723PC	3/8" F.I.P. X 1/2" O.D. FLARE	CHROME	00934 4	24	8 lbs.		
2721PC	1/2" F.I.P. X 3/8" O.D. FLARE	CHROME	00936 8	12	4.2 lbs.		
2724PC	1/2" F.I.P. X 1/2" O.D. FLARE	CHROME	00937 5	12	4.2 lbs.		
F.I.P. X COMPRESSION - 3 WAY QUARTER TURN VALVES - BOXED							
2902PC	1/2" F.I.P. X 3/8" O.D. X 1/4" O.D. 	CHROME	00801 9	12	4.4 lbs.		
2901PC	1/2" F.I.P. X 3/8" O.D. X 3/8" O.D. 	CHROME	00800 2	24	9.1 lbs.		
2909PC	1/2" F.I.P. X 1/2" O.D. X 3/8" O.D.	CHROME	00922 1	12	5.3 lbs.		
2910PC	1/2" F.I.P. X 7/16"-1/2" O.D. X 7/16"-1/2" SLIP JOINT	CHROME	00923 8	24	12.8 lbs.		
2911PC	1/2" F.I.P. X 1/2" O.D. X 1/2" O.D.	CHROME	00924 5	24	10.2 lbs.		
COMPRESSION X COMPRESSION - 3 WAY QUARTER TURN VALVES - BOXED							
2904PC	5/8" O.D. X 3/8" O.D. X 1/4" O.D. 	CHROME	00804 0	12	4.9 lbs.		
2903PC	5/8" O.D. X 3/8" O.D. X 3/8" O.D. 	CHROME	00803 3	24	8.8 lbs.		
2908PC	5/8" O.D. X 1/2" O.D. X 1/4" O.D.	CHROME	00926 9	24	10.2 lbs.		
2912PC	5/8" O.D. X 1/2" O.D. X 3/8" O.D.	CHROME	00927 6	12	5.1 lbs.		
2906PC	5/8" O.D. X 7/16" O.D. X 1/4" O.D.	CHROME	00928 3	24	10.6 lbs.		
2907PC	5/8" O.D. X 7/16" O.D. X 3/8" O.D.	CHROME	00929 0	24	10.6 lbs.		
2905PC	5/8" O.D. X 1/2" O.D. X 1/2" O.D.	CHROME	00931 3	24	11.3 lbs.		
COMPRESSION X M.I.P. - 3 WAY QUARTER TURN VALVE - BOXED							
2701PC	5/8" O.D. X 1/2" M.I.P. X 1/2" M.I.P.	CHROME	00932 0	24	10.9 lbs.		
ADD-A-TEE ADAPTERS							
K2037	3/8" X 8" X 1/4"		01826 1	CARD	1 lbs.	6	
K2038	3/8" X 3/8" X 3/8"		01827 8	CARD	2 lbs.	6	
K2040	1/2" SJ X 1/2 SJ X 3/8" COMP.		01829 2	CARD	2 lbs.	6	
K2039	1/2" SJ X 1/2" SJ X 1/4"		01828 5	CARD	2 lbs.	6	
ADAPTERS - STRAIGHT							
7077PC	3/8" MALE I.P.S. X 3/8" O.D.	CHROME	93688 6	25	5 lbs.		
7078PC	1/2" MALE I.P.S. X 3/8" O.D.	CHROME	93690 9	25	5 lbs.		

Part Num.	Item Description	Finish	UPC# 046224 +	Ctn Qty	Ctn Wt	List Price	Line Art
ADAPTERS - STRAIGHT							
7076PC	1/2" FEMALE I.P.S. X 3/8" O.D.	CHROME	93687 9	25	5 lbs.		
7074PC	1/2" NOM. COPPER X 3/8" O.D.	CHROME	93699 2	25	5 lbs.		
ANGLE							
7079PC	1/2" FEMALE I.P.S. X 3/8" O.D.	CHROME	93691 6	25	5 lbs.		

All Keeney Quarter Turn Repair Valves feature:

- Solid Chrome Plated Brass Ball
- Brass Forged Body
- Solid Brass Stem
- Teflon Seats - melting point of 621° Fahrenheit
- Captured Nut
- Compression Connection
- 100% Pressure Leak Tested

QUARTER TURN REPAIR VALVE

REPAIR VALVES

COMPRESSION X COMPRESSION - STRAIGHT REPAIR QUARTER TURN VALVES
 CONNECTS TO EXISTING VALVES - BOXED

2072PC	3/8" FEMALE COMP. SWIVEL X 3/8" O.D.	CHROME	01208 5	24	8.8 lbs.
2103PC	1/2" F.I.P. FEMALE SWIVEL X 3/8" O.D.	CHROME	01207 8	24	9.5 lbs.

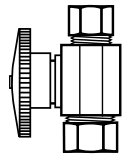

COMMERCIAL VALVE

Specially designed with the professional in mind. Keeney's new "Loose Key" valves are available in various sizes.

QUARTER TURN LOOSE KEY VALVES

The latest addition to the expansive Quarter Turn Ball valve offering includes an assortment of quarter turn loose key valves.

- Internal Quarter Turn Ball Valve
- Available with 5" Extension
- Key chain hole on Key for added convenience

QUARTER TURN LOOSE KEY VALVES

LOOSE KEY ANGLE STOPS - BOXED

2047PCLK	3/8" F.I.P. X 3/8" O.D.	CHROME	01154 5	12	4.3 lbs.
2452PCLK	3/8" F.I.P. X 1/2" O.D.	CHROME	01159 4	12	4.3 lbs.
2048PCLK	1/2" F.I.P. X 3/8" O.D.	CHROME	01155 6	12	4.8 lbs.
2049PCLK	1/2" F.I.P. X 1/2" O.D.	CHROME	01156 3	12	4.8 lbs.
2100PCLK	1/2" COPPER SWEAT WITH 5" EXTENSION X 3/8" O.D. - DEEP FLANGE	CHROME	01157 6	12	6.6 lbs.

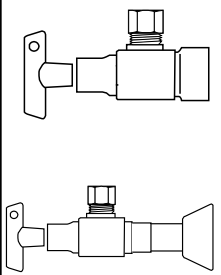

ADAPTERS / LOOSE KEY VALVES

MULTI-TURN VALVES



THE KEENEY MANUFACTURING COMPANY

MULTI-TURN VALVES

Part Num.	Item Description	Finish	UPC# 046224 +	Ctn Qty	Ctn Wt	List Price	Line Art
MULTI-TURN VALVES							
F.I.P. X COMPRESSION - STRAIGHT VALVES - BOXED							
PP20052	3/8" F.I.P. X 3/8" O.D.	CHROME	20052 9	25	5.8 lbs.		
7083PCMH	3/8" F.I.P. X 3/8" O.D. (METAL HANDLE)	CHROME	73919 7	5/25	7.3 lbs.		
PP20053	1/2" F.I.P. X 3/8" O.D.	CHROME	20053 6	25	5.5 lbs.		
7084PCMH	1/2" F.I.P. X 3/8" O.D. (METAL HANDLE)	CHROME	73918 0	5/25	8 lbs.		
7284PC	1/2" F.I.P. X 1/2" O.D.	CHROME	72468 1	25	5 lbs.		
7093PC	1/2" F.I.P. X 7/16" O.D. SJ OR 1/2" O.D. - STRAIGHT	CHROME	70301 3	25	4 lbs.		
COMPRESSION X COMPRESSION - STRAIGHT VALVES - BOXED							
7099PC	1/2" O.D. (3/8" NOM COPPER) X 3/8" O.D. (METAL HANDLE)	CHROME	70371 6	25	4 lbs.		
PP20063	5/8" O.D. (1/2" NOM COPPER) X 3/8" O.D.	CHROME	20063 5	15	4.1 lbs.		
7092PCMH	5/8" O.D. (1/2" NOM COPPER) X 3/8" O.D. (METAL HANDLE)	CHROME	73917 3	5/25	7.8 lbs.		
7092RB	5/8" O.D. (1/2" NOM COPPER) X 3/8" O.D. (METAL HANDLE)	ROUGH BRASS	70485 0	25	7 lbs.		
7292PC	5/8" O.D. X (1/2" NOM. COPPER) X 1/2" O.D. (METAL HANDLE)	CHROME	70370 9	25	5 lbs.		
SWEAT X COMPRESSION - STRAIGHT VALVES - BOXED							
PP20062	1/2" COPPER SWEAT X 3/8" O.D.	CHROME	20052 9	25	7.5 lbs.		
7087PC	1/2" COPPER SWEAT X 3/8" O.D. (METAL HANDLE)	CHROME	07087 7	5/25	7.8 lbs.		
CPVC X COMPRESSION - STRAIGHT VALVE - BOXED							
PP20322	1/2" NOM. X 3/8" O.D.	CHROME	20322 3	10	3.9 lbs.		
F.I.P. X COMPRESSION - ANGLE VALVES - BAGGED							
7282PC	1/2" F.I.P. X 1/4" O.D. (METAL HANDLE)	CHROME	72465 0	25	5 lbs.		
PP20050	3/8" F.I.P. X 3/8" O.D.	CHROME	20052 9	25	5 lbs.		
7085PCMH	3/8" F.I.P. X 3/8" O.D. (METAL HANDLE)	CHROME	73921 2	5/25	6.3 lbs.		
PP20051	1/2" F.I.P. X 3/8" O.D.	CHROME	20051 2	25	5.5 lbs.		
7086PCMH	1/2" F.I.P. X 3/8" O.D. (METAL HANDLE)	CHROME	73920 3	5/25	7.1 lbs.		
PP20054	1/2" F.I.P. X 7/16" O.D.	CHROME	20054 3	15	4.5 lbs.		
COMPRESSION X COMPRESSION - ANGLE VALVES - BAGGED							
7283PC	5/8" O.D. (1/2" NOM COPPER) X 1/4" O.D. (METAL HANDLE)	CHROME	70527 7	25	7 lbs.		
7283RB	5/8" O.D. (1/2" NOM COPPER) X 1/4" O.D. (METAL HANDLE)	ROUGH BRASS	71302 9	25	7 lbs.		
PP20061	5/8" O.D. (1/2" NOM COPPER) X 3/8" O.D.	CHROME	20061 1	15	3.3 lbs.		
7095PCMH	5/8" O.D. (1/2" NOM COPPER) X 3/8" O.D. (METAL HANDLE)	CHROME	73829 9	5/25	6.8 lbs.		
7095RB	5/8" O.D. (1/2" NOM COPPER) X 3/8" O.D. (METAL HANDLE)	ROUGH BRASS	70429 4	25	7 lbs.	12.68	
7288PC	5/8" O.D. (1/2" NOM COPPER) X 1/2" O.D.	CHROME	72469 8	25	3 lbs.		
7096PC	1/2" O.D. X 7/16" O.D. S J OR 1/2" O.D. - ANGLE	CHROME	93704 3	25	4 lbs.		
SWEAT X COMPRESSION - ANGLE VALVES - BAGGED							
PP20060	1/2" COPPER SWEAT X 3/8" O.D.	CHROME	20060 4	15	3.5 lbs.		
7088PC	1/2" COPPER SWEAT X 3/8" O.D. (METAL HANDLE)	CHROME	07088 2	5/25	6.5 lbs.		
7088RB	1/2" COPPER SWEAT X 3/8" O.D. (METAL HANDLE)	ROUGH BRASS	70430 0	25	3.0 lbs.		

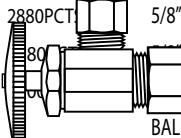
Part Num.	Item Description	Finish	UPC# 046224 +	Ctn Qty	Ctn Wt	List Price	Line Art
CPVC X COMPRESSION - ANGLE VALVE - BAGGED PP20321	1/2" NOM. X 3/8" O.D.	CHROME	20321 6	10	3.2 lbs.	\$16.40	
ONE PIECE LAVATORY CONNECTION KITS							
QUARTER TURN VALVE AND BRAIDED STAINLESS STEEL CONNECTOR LAVATORY/SINK KITS PACKED 2 PER BAG WITH FLANGE							
2622PCFSS12	5/8" O.D. X (1/2" NOM. COPPER) X 1/2" F.I.P.- 12"	CHROME & SS	01160 6	12	6.6 lbs.		
2622PCFSS16	5/8" O.D. X (1/2" NOM. COPPER) X 1/2" F.I.P.- 16"	CHROME & SS	01161 3	12	6.8 lbs.		
2622PCFSS20	5/8" O.D. X (1/2" NOM. COPPER) X 1/2" F.I.P.- 20"	CHROME & SS	01162 0	12	7.4 lbs.		
2880PCFSS12	5/8" O.D. X (1/2" NOM. CPVC) X 1/2" F.I.P.- 12"	CHROME & SS	01167 5	12	6.8 lbs.		
2880PCFSS16	5/8" O.D. X (1/2" NOM. CPVC) X 1/2" F.I.P.- 16"	CHROME & SS	01168 2	12	7.7 lbs.		
2880PCFSS20	5/8" O.D. X (1/2" NOM. CPVC) X 1/2" F.I.P.- 20"	CHROME & SS	01169 6	12	7.9 lbs.		
ONE PIECE TOILET CONNECTION KITS							
QUARTER TURN VALVE AND BRAIDED STAINLESS STEEL CONNECTOR TOILET KITS PACKED 1 PER BAG WITH FLANGE							
2622PCT5S9	5/8" O.D. X (1/2" NOM. COPPER) X 7/8" BALLCOCK- 9"	CHROME & SS	01165 1	24	12.1 lbs.		
2622PCT5S12	5/8" O.D. X (1/2" NOM. COPPER) X 7/8" BALLCOCK- 12"	CHROME & SS	01163 7	24	12.6 lbs.		
2622PCT5S16	5/8" O.D. X (1/2" NOM. COPPER) X 7/8" BALLCOCK- 16"	CHROME & SS	01164 4	24	13.2 lbs.		
2880PCT5S9	5/8" O.D. X (1/2" NOM. CPVC) X 7/8" BALLCOCK- 9"	CHROME & SS	01172 9	24	13.2 lbs.		
2880PCT5S12	5/8" O.D. X (1/2" NOM. CPVC) X 7/8" BALLCOCK- 12"	CHROME & SS	01170 5	24	13.7 lbs.		
2880PCT5S16	5/8" O.D. X (1/2" NOM. CPVC) X 7/8" BALLCOCK- 16"	CHROME & SS	01171 2	24	14.3 lbs.		
	COPPER SWEAT WITH 5" EXT. X 7/8" BALLCOCK- 9"- DEEP FLANGE	CHROME & SS	01158 3	12	6.8 lbs.		
MULTI-TURN LAVATORY/SINK SUPPLY KITS							
VALVE AND LAVATORY SUPPLY TUBES WITH FLANGE - BAGGED							
7095KL12PC	1/2" NOM. COMPRESSION X 3/8" O.D. X 12" LAVATORY SUPPLY KIT WITH FLANGES	CHROME	17095 2	10	8 lbs.		
7095KL12PB	1/2" NOM. COMPRESSION X 3/8" O.D. X 12" LAVATORY SUPPLY KIT WITH FLANGES	POLISHED BRASS	72473 5	10	8 lbs.		
MULTI-TURN CLOSET SUPPLY KITS							
VALVE AND CLOSET SUPPLY TUBES WITH FLANGE - BAGGED							
7085KC12PCZ	3/8" F.I.P. X 3/8" O.D. X 12" CLOSET SUPPLY KIT WITH FLANGES	CHROME	72466 7	10	8 lbs.		
7095KC12PC	1/2" NOM. COMPRESSION X 3/8" O.D. X 12" CLOSET SUPPLY KIT WITH FLANGES	CHROME	70377 8	10	8 lbs.		
7095KC12PB	1/2" NOM. COMPRESSION X 3/8" O.D. X 12" CLOSET SUPPLY KIT WITH FLANGES	POLISHED BRASS	72284 7	10	8 lbs.		

LAVATORY KITS / TOILET KITS

SELL KIT~MASTERVERVE™~PEX RISER TUBES



THE KEENEY MANUFACTURING COMPANY

Part Num.	Item Description	Finish	UPC# 046224 +	Ctn Qty	Ctn Wt	List Price	Line Art
LICENSE TO SELL KIT							
WATER SUPPLY SALESMAN SAMPLE KIT							
LICSELLWS	WATER SUPPLY SALESMAN SAMPLE KIT. ASSORTED SUPPLY LINES AND VALVES. QUARTER TURN DISPLAY.					\$46.49	
							

SUPPLY & RISER TUBES

The MASTERVERVE is versatile -it can be adapted to many different scenarios.

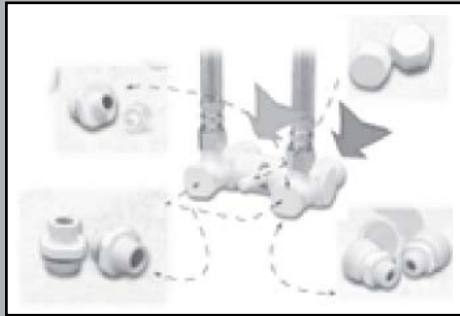

The MASTERVERVE valve provides multiple outlets for both hot and cold water hook ups for a kitchen or vanity faucet.



MASTERVERVE™

Additional outlets on the MASTERVERVE allow for vertical or horizontal hook up to the dishwasher or instant hot water or ice maker, and many other applications.

As per building or plumbing codes, only one outlet of either the hot or cold supply side may be used at once. Please check local building codes for application and use.

MASTERVERVE™

2343	1/2" F.I.P. X 1/4", 3/8", 3/4" MASTERVERVE	PLASTIC	BAG	00391 5	10	
2344	1/2" O.D. X 1/4", 3/8", 3/4" MASTERVERVE	CHROME	BAG	02344 0	-	
2345	1/2" F.I.P. X 1/2" M.I.P. AND 1/2" SWEAT INLET ADAPTER	CHROME	BAG	02345 0	-	
2346	1/2" O.D. X 1/2" M.I.P. AND 1/2" SWEAT INLET ADAPTER	CHROME	BAG	02346 0	-	

PATENT #: 6,206,028 AND D442,260



PEX RISER TUBES

LAVATORY

50-1	3/8" O.D. X 12"	93162 1	100	3.5 lbs.
50-2	3/8" O.D. X 15"	93163 8	100	4.5 lbs.
50-3	3/8" O.D. X 20"	93165 2	100	5.8 lbs.
50-4	3/8" O.D. X 30"	93166 9	100	8.1 lbs.
50-5	3/8" O.D. X 36"	93167 6	100	10.2 lbs.

CLOSET

51-1	3/8" O.D. X 12"	93190 4	100	3.7 lbs.
51-2	3/8" O.D. X 15"	93191 1	100	4.5 lbs.
51-3	3/8" O.D. X 20"	93193 5	100	5.9 lbs.

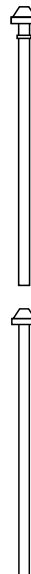

Part Num.	Item Description	Finish	UPC# 046224 +	Ctn Qty	Ctn Wt	List Price	Line Art
SUPPLY SMOOTH RISER TUBES							
LAVATORY							
107001RB	3/8" O.D. X 12"	ROUGH	91758 8	100	12 lbs.		
107001PC	3/8" O.D. X 12"	CHROME	91756 4	100	11.4 lbs.		
K107001PB	3/8" O.D. X 12"	POLISHED BRASS	70669 4	10	3 lbs.		
107002RB	3/8" O.D. X 20"	ROUGH	91762 5	100	18 lbs.		
107002PC	3/8" O.D. X 20"	CHROME	91760 1	100	19.1 lbs.		
K107002PB	3/8" O.D. X 20"	POLISHED BRASS	70668 7	10	5 lbs.		
107003RB	3/8" O.D. X 30"	ROUGH	91765 6	100	15 lbs.		
107003PC	3/8" O.D. X 30"	ROUGH	91764 9	100	15 lbs.		
107004RB	3/8" O.D. X 36"	ROUGH	91768 7	100	28 lbs.		
107004PC	3/8" O.D. X 36"	CHROME	91766 3	100	28 lbs.		
108001PC	1/2" O.D. X 12"	CHROME	91777 9	100	5 lbs.		
108002PC	1/2" O.D. X 20"	CHROME	91779 3	100	25 lbs.		
CLOSET							
107050PC	3/8" O.D. X 12"	CHROME	91772 4	100	11 lbs.		
K107050PB	3/8" O.D. X 12"	POLISHED BRASS	70338 9	10	1 lb.		
107051PC	3/8" O.D. X 20"	CHROME	91775 5	100	13 lbs.		
K107051PB	3/8" O.D. X 20"	POLISHED BRASS	07051 1	10	1 lb.		
108050PC	1/2" O.D. X 12"	CHROME	91782 3	100	14.5 lbs.		
COMPRESSION RISERS							
7216PC	3/8" COMPRESSION X 3/8" O.D. - 12"	CHROME	70474 4	100	16 lbs.		
7217PC	3/8" COMPRESSION X 3/8" O.D. - 20"	CHROME	70475 1	25	.5 lb.		

CONNECTORS

QUALITY

Keeney connectors are made of high quality materials, and are manufactured to our strict engineering tolerances and specifications. Keeney connectors are available in stainless steel and vinyl, in numerous configurations to meet all customers needs. Keeney connectors use only solid Brass Inserts and Nitrile Cone Washers.

WATER SUPPLY CONNECTORS

FAUCET SUPPLY TUBES

COMPRESSION INLET - VINYL							
PP23860	3/8" COMPRESSION X 1/2" F.I.P. - 12"		BULK WITH FLAG LABEL	23860 7	25	4 lbs.	
PP23861	3/8" COMPRESSION X 1/2" F.I.P. - 16"		BULK WITH FLAG LABEL	23861 4	25	5 lbs.	
PP23862	3/8" COMPRESSION X 1/2" F.I.P. - 20"		BULK WITH FLAG LABEL	23862 1	25	6 lbs.	

TOILET CONNECTORS



THE KEENEY MANUFACTURING COMPANY

CONNECTORS

Part Num.	Item Description	Packed	UPC# 046224 +	Ctn Qty	Ctn Wt	List Price	Line Art
COMPRESSION INLET - VINYL - CONTINUED							
PP23863	3/8" COMPRESSION X 1/2" F.I.P. - 36"	BULK WITH FLAG LABEL	23863 8	25	8 lbs.		
PP23869	3/8" COMPRESSION X 1/2" F.I.P. - 48"	BULK WITH FLAG LABEL	23869 0	25	9 lbs.		
PP23865	1/2" COMPRESSION X 1/2" F.I.P. - 12"	BULK WITH FLAG LABEL	23865 2	25	4 lbs.		
PP23866	1/2" COMPRESSION X 1/2" F.I.P. - 16"	BULK WITH FLAG LABEL	23866 9	25	5 lbs.		
PP23867	1/2" COMPRESSION X 1/2" F.I.P. - 20"	BULK WITH FLAG LABEL	23867 6	25	6 lbs.		
PP23868	1/2" COMPRESSION X 1/2" F.I.P. - 36"	BULK WITH FLAG LABEL	23868 3	25	8 lbs.		
F.I.P. INLET - VINYL							
PP23883	1/2" F.I.P. X 1/2" F.I.P. - 12"	BULK WITH FLAG LABEL	23883 6	25	4 lbs.		
PP23884	1/2" F.I.P. X 1/2" F.I.P. - 16"	BULK WITH FLAG LABEL	23884 3	25	5 lbs.		
PP23885	1/2" F.I.P. X 1/2" F.I.P. - 20"	BULK WITH FLAG LABEL	70572 7	25	6 lbs.		
PP23453	1/2" F.I.P. X 1/2" F.I.P. - 36"	BULK WITH FLAG LABEL	23453 1	25	8 lbs.		
PP23888	1/2" F.I.P. X 1/2" F.I.P. - 48"	BULK WITH FLAG LABEL	23888 1	25	9 lbs.		
TOILET SUPPLY TUBES							
COMPRESSION INLET - VINYL							
PP23870	3/8" COMPRESSION X 7/8" BALLCOCK - 9"	BULK WITH FLAG LABEL	23870 6	25	4 lbs.		
PP23871	3/8" COMPRESSION X 7/8" BALLCOCK - 12"	BULK WITH FLAG LABEL	23871 3	25	4 lbs.		
PP23873	3/8" COMPRESSION X 7/8" BALLCOCK - 16"	BULK WITH FLAG LABEL	23873 7	25	4 lbs.		
PP23872	3/8" COMPRESSION X 7/8" BALLCOCK - 20"	BULK WITH FLAG LABEL	23872 0	25	6 lbs.		
PP23874	1/2" COMPRESSION X 7/8" BALLCOCK - 9"	BULK WITH FLAG LABEL	23874 4	25	4 lbs.		
PP23875	1/2" COMPRESSION X 7/8" BALLCOCK - 12"	BULK WITH FLAG LABEL	23875 1	25	4 lbs.		
PP23877	1/2" COMPRESSION X 7/8" BALLCOCK - 16"	BULK WITH FLAG LABEL	23877 5	25	4 lbs.		
PP23876	1/2" COMPRESSION X 7/8" BALLCOCK - 20"	BULK WITH FLAG LABEL	23876 8	25	6 lbs.		
F.I.P. INLET - VINYL							
PP23882	1/2" F.I.P. X 7/8" BALLCOCK - 12"	BULK WITH FLAG LABEL	70571 0	25	4 lbs.		

LABELING

Easy to read, easy to use label attached to the product. Color coded for easy installation by type. Barcoded to aid in stocking and inventory.



VINYL

- Faucet connectors
- Faucet Connectors - Delta Style
- Toilet Connectors
- Dishwasher Connectors

QUALITY HOSE
A braided polyester yarn layer covers a PVC tube.

FLEXIBILITY
No knots, kinks or crimps.

CONNECTORS: VINYL



NUTS & INSERTS
Chrome Plated Brass Nuts, Solid Brass Inserts. Quick easy installation.

WASHERS NITRILE
Cone Washers

FAUCET SUPPLY TUBES							
COMPRESSION INLET X COMPRESSION OUTLET - STAINLESS STEEL							
PP23809	3/8" COMPRESSION X 3/8" COMPRESSION - 12"	BULK WITH FLAG LABEL	00733 3	25	4.9 lbs.		
PP23800	3/8" COMPRESSION X 3/8" COMPRESSION - 20"	BULK WITH FLAG LABEL	00734 0	25	7.7 lbs.		

Part Num.	Item Description	Packed	UPC# 046224 +	Ctn Qty	Ctn Wt	List Price	Line Art
COMPRESSION INLET - STAINLESS STEEL							
PP23801	3/8" COMPRESSION X 1/2" F.I.P. - 12"	BULK WITH FLAG LABEL	23801 0	25	5.5 lbs.		
PP23802	3/8" COMPRESSION X 1/2" F.I.P. - 16"	BULK WITH FLAG LABEL	23802 7	25	7.7 lbs.		
PP23803	3/8" COMPRESSION X 1/2" F.I.P. - 20"	BULK WITH FLAG LABEL	23803 4	25	9.3 lbs.		
PP23808	3/8" COMPRESSION X 1/2" F.I.P. - 30"	BULK WITH FLAG LABEL	23808 9	10	4.9 lbs.		
PP23815	3/8" COMPRESSION X 1/2" F.I.P. - 36"	BULK WITH FLAG LABEL	23815 7	10	11 lbs.		
PP23819	7/16" COMPRESSION X 1/2" F.I.P. - 12"	BULK WITH FLAG LABEL	23819 5	25	4.9 lbs.		
PP23824	7/16" COMPRESSION X 1/2" F.I.P. - 16"	BULK WITH FLAG LABEL	00735 4	25	8.2 lbs.		
PP23825	7/16" COMPRESSION X 1/2" F.I.P. - 20"	BULK WITH FLAG LABEL	00736 4	25	8.8 lbs.		
PP23810	1/2" COMPRESSION X 1/2" F.I.P. - 12"	BULK WITH FLAG LABEL	23810 2	25	6 lbs.		
PP23811	1/2" COMPRESSION X 1/2" F.I.P. - 16"	BULK WITH FLAG LABEL	23811 9	25	8.2 lbs.		
PP23840	1/2" COMPRESSION X 1/2" F.I.P. - 20"	BULK WITH FLAG LABEL	23840 9	25	9.3 lbs.		
PP23839	1/2" COMPRESSION X 1/2" F.I.P. - 30"	BULK WITH FLAG LABEL	00777 7	10	4.9 lbs.		
F.I.P. INLET - STAINLESS STEEL							
PP23816	1/2" F.I.P. X 1/2" F.I.P. - 12"	BULK WITH FLAG LABEL	23816 4	25	7.1 lbs.		
PP23817	1/2" F.I.P. X 1/2" F.I.P. - 16"	BULK WITH FLAG LABEL	23817 1	25	8.2 lbs.		
PP23818	1/2" F.I.P. X 1/2" F.I.P. - 20"	BULK WITH FLAG LABEL	23818 8	25	8.8 lbs.		
PP23799	1/2" F.I.P. X 1/2" F.I.P. - 30"	BULK WITH FLAG LABEL	00776 0	10	5.8 lbs.		
COMPRESSION INLET X DELTA STYLE - STAINLESS STEEL							
PP23850	3/8" COMPRESSION X DELTA STYLE - 12"	BULK WITH FLAG LABEL	23850 8	25	7.1 lbs.		
PP23852	3/8" COMPRESSION X DELTA STYLE - 16"	BULK WITH FLAG LABEL	00745 6	25	8.8 lbs.		
PP23851	3/8" COMPRESSION X DELTA STYLE - 20"	BULK WITH FLAG LABEL	23851 5	25	9.3 lbs.		
FINE THREAD FLARE INLET - STAINLESS STEEL							
PP23829	3/8" FINE THREAD FLARE X 1/2" F.I.P. - 12"	BULK WITH FLAG LABEL	00740 8	25	7.7 lbs.		
PP23841	3/8" FINE THREAD FLARE X 1/2" F.I.P. - 20"	BULK WITH FLAG LABEL	23841 6	25	8.2 lbs.		
PP23846	3/8" FINE THREAD FLARE X 1/2" F.I.P. - 30"	BULK WITH FLAG LABEL	00741 8	10	8.8 lbs.		
PP23847	1/2" FINE THREAD FLARE X 1/2" F.I.P. - 12"	BULK WITH FLAG LABEL	00742 5	25	7.7 lbs.		
PP23848	1/2" FINE THREAD FLARE X 1/2" F.I.P. - 20"	BULK WITH FLAG LABEL	00743 2	25	8.8 lbs.		
PP23849	1/2" FINE THREAD FLARE X 1/2" F.I.P. - 30"	BULK WITH FLAG LABEL	00744 9	10	9.3 lbs.		
FINE THREAD FLARE INLET X COMPRESSION OUTLET - STAINLESS STEEL							
PP23826	3/8" FINE THREAD FLARE X 3/8" COMPRESSION - 12"	BULK WITH FLAG LABEL	00737 1	25	7.7 lbs.		
PP23827	3/8" FINE THREAD FLARE X 3/8" COMPRESSION - 20"	BULK WITH FLAG LABEL	00738 8	25	8.2 lbs.		
PP23828	3/8" FINE THREAD FLARE X 3/8" COMPRESSION - 30"	BULK WITH FLAG LABEL	00739 5	10	8.8 lbs.		

CONNECTORS / HOSES

Part Num.	Item Description	Packed	UPC# 046224 +	Ctn Qty	Ctn Wt	List Price	Line Art
-----------	------------------	--------	---------------	---------	--------	------------	----------

CONNECTORS: STAINLESS STEEL



STAINLESS STEEL

- Faucet connectors
- Dishwasher Connectors
- Water Heater Connectors
- Ice Maker Connectors
- Toilet Connectors
- Faucet Connectors - Delta Style
- Washing Machine Connectors

FLEXIBILITY

.304 Stainless Steel Braid is tough, bends without kinking or crimping.

NUTS & WASHERS

Chrome Plated Brass Nuts, Solid Brass Inserts. Quick easy installation.

WASHERS NITRILE

Cone Washers.

QUALITY HOSE

.304 Stainless Steel Braid over on extruded tough durable EPDM tube.

TOILET SUPPLY TUBES

COMPRESSION INLET - STAINLESS STEEL

PP23804	3/8" COMPRESSION X 7/8" BALLCOCK - 9"		BULK WITH FLAG LABEL	23804 1	25	3.8 lbs.
PP23805	3/8" COMPRESSION X 7/8" BALLCOCK - 12"		BULK WITH FLAG LABEL	23805 8	25	6 lbs.
PP23807	3/8" COMPRESSION X 7/8" BALLCOCK - 16"		BULK WITH FLAG LABEL	23807 2	25	6.6 lbs.
PP23806	3/8" COMPRESSION X 7/8" BALLCOCK - 20"		BULK WITH FLAG LABEL	23806 5	25	7.7 lbs.
PP23853	7/16" COMPRESSION X 7/8" BALLCOCK - 12"		BULK WITH FLAG LABEL	00746 3	25	6.6 lbs.
PP23842	1/2" COMPRESSION X 7/8" BALLCOCK - 9"		BULK WITH FLAG LABEL	23842 3	25	3.8 lbs.
PP23843	1/2" COMPRESSION X 7/8" BALLCOCK - 12"		BULK WITH FLAG LABEL	23843 0	25	6 lbs.
PP23844	1/2" COMPRESSION X 7/8" BALLCOCK - 16"		BULK WITH FLAG LABEL	23844 7	25	7.1 lbs.
PP23845	1/2" COMPRESSION X 7/8" BALLCOCK - 20"		BULK WITH FLAG LABEL	23845 4	25	8.2 lbs.

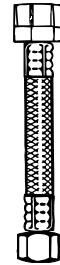

F.I.P. INLET - STAINLESS STEEL

PP23813	1/2" F.I.P. X 7/8" BALLCOCK - 9"		BULK WITH FLAG LABEL	23813 3	25	4.9 lbs.
PP23812	1/2" F.I.P. X 7/8" BALLCOCK - 12"		BULK WITH FLAG LABEL	23812 6	25	6 lbs.
PP23814	1/2" F.I.P. X 7/8" BALLCOCK - 16"		BULK WITH FLAG LABEL	23814 0	25	6.7 lbs.
PP23838	1/2" F.I.P. X 7/8" BALLCOCK - 20"		BULK WITH FLAG LABEL	00807 1	25	8.2 lbs.



FINE THREAD FLARE INLET - STAINLESS STEEL

PP23854	3/8" FINE THREAD FLARE X 7/8" BALLCOCK - 12"		BULK WITH FLAG LABEL	00747 0	25	6 lbs.
PP23855	3/8" FINE THREAD FLARE X 7/8" BALLCOCK - 20"		BULK WITH FLAG LABEL	00748 7	25	7.7 lbs.
PP23856	1/2" FINE THREAD FLARE X 7/8" BALLCOCK - 12"		BULK WITH FLAG LABEL	00749 4	25	15.1 lbs.
PP23857	3/8" FINE THREAD FLARE X 7/8" BALLCOCK - 20"		BULK WITH FLAG LABEL	00750 0	25	20.6 lbs.



WASHING MACHINE HOSES

COMPRESSION INLET - STAINLESS STEEL

PP23821	3/4" F.H.T. X 3/4" F.H.T. X 48"		BULK WITH FLAG LABEL	23821 8	10	7.1 lbs.
PP23832	3/4" F.H.T. X 3/4" F.H.T. X 60"		BULK WITH FLAG LABEL	00751 7	10	8.2 lbs.

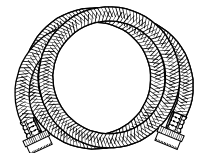

CONNECTORS / HOSES

Part Num.	Item Description	Packed	UPC# 046224 +	Ctn Qty	Ctn Wt	List Price	Line Art
DISHWASHER HOSES							
STAINLESS STEEL							
PP23833	3/8" COMPRESSION X 3/8" M.I.P. ELBOW X 60"	BULK WITH FLAG LABEL	00752 4	10	8.8 lbs.		
PP23834	3/8" COMPRESSION X 3/8" M.I.P. ELBOW X 72"	BULK WITH FLAG LABEL	00753 1	10	5.5 lbs.		
PP23835	3/8" COMPRESSION X 3/8" M.I.P. ELBOW X 84"	BULK WITH FLAG LABEL	00754 8	10	6 lbs.		
PP23836	1/2" F.I.P. X 3/8" M.I.P. ELBOW X 48"	BULK WITH FLAG LABEL	00755 5	10	7.7 lbs.		
PP23837	1/2" F.I.P. X 3/8" M.I.P. ELBOW X 60"	BULK WITH FLAG LABEL	00756 2	10	8.8 lbs.		
ICE MAKER							
COMPRESSION INLET - STAINLESS STEEL							
PP25523	1/4" COMPRESSION X 1/4" COMPRESSION X 60"	BULK WITH FLAG LABEL	00757 9	10	5.5 lbs.		
PP25529	1/4" COMPRESSION X 1/4" COMPRESSION X 120"	BULK WITH FLAG LABEL	00758 6	10	9.9 lbs.		
WATER HEATER							
STAINLESS STEEL							
PP888-1	3/4" F.I.P. X 3/4" F.I.P. X 12"	BULK WITH FLAG LABEL	88801 7	10	7.7 lbs.		
PP888-3	3/4" F.I.P. X 3/4" F.I.P. X 18"	BULK WITH FLAG LABEL	88803 1	10	8.2 lbs.		
PP888-4	3/4" F.I.P. X 3/4" F.I.P. X 24"	BULK WITH FLAG LABEL	88804 8	10	11 lbs.		
PP888-10	3/4" F.I.P. X 3/4" M.I.P. X 12"	BULK WITH FLAG LABEL	00808 8	10	8.2 lbs.		
PP888-11	3/4" F.I.P. X 3/4" M.I.P. X 18"	BULK WITH FLAG LABEL	00809 5	10	8.5 lbs.		
PP888-12	3/4" F.I.P. X 3/4" M.I.P. X 24"	BULK WITH FLAG LABEL	00810 1	10	11 lbs.		
WATER SUPPLY CONNECTOR DISPLAY							
CD6-7R	WATER SUPPLY CONNECTOR DISPLAY						
	25 - PP23801						
	3/8" COMPRESSION X 1/2" F.I.P. - 1/2"LAV						
	25 - PP23801						
	3/8" COMPRESSION X 1/2" F.I.P. - 1/2"LAV						
	25 - PP23801						
	3/8" COMPRESSION X 1/2" F.I.P. - 1/2"LAV						
	25 - PP23801						
	3/8" COMPRESSION X 1/2" F.I.P. - 1/2"LAV						
	25 - PP23801						
	3/8" COMPRESSION X 1/2" F.I.P. - 1/2"LAV						
	25 - PP23801						
	3/8" COMPRESSION X 1/2" F.I.P. - 1/2"LAV						
	25 - PP23801						
	3/8" COMPRESSION X 1/2" F.I.P. - 1/2"LAV						
	1 - COLOR CODED MERCHANDISING STRIP						
	1 - SELF LIQUIDATING RISER RACK						

HOSES / DISPLAY

WASHERS~FRICTION RINGS~FERRULE



THE KEENEY MANUFACTURING COMPANY

Part Num.	Item Description	Packed	UPC# 046224 +	Ctn Qty	Ctn Wt	List Price	Line Art
RUBBER CONE WASHERS							
PP810-31BU	3/8" I.D. X 22/32" O.D. X 3/8" O.D. LAVATORY	BULK	91131 9	100	1 lb.		
PP810-33BU	3/8" I.D. X 13/16" O.D. X 3/8" O.D. CLOSET	BULK	01788 2	100	1 lb.		
FERRULE							
50-9	3/8" PLASTIC FERRULE	BULK	93168 3	100	2.5 lbs.		
PLASTIC FLAT SEAT INSERT							
507050P	3/8" - 1/2" O.D. FORMED CLOSET TUBE	BULK	07050 4	25	1 lb.		

WASHERS / FRICTION RINGS / FERRULE

Part Num.	Item Description	UPC# 046224 +	Pkg	Ctn Wt	Ctn Qty	Line Art
-----------	------------------	---------------	-----	--------	---------	----------



THE KEENEY BY DESIGN COLLECTION

THE KEENEY BY DESIGN COLLECTION ASSEMBLES THE PRODUCTS AND COMPONENTS REQUIRED BY TODAY'S SHOWROOM & DESIGN CENTERS. THIS COLLECTION FEATURES BATHROOM AND KITCHEN PRODUCTS IN FINISHES MEETING THE DEMANDS OF CURRENT DECORATING TRENDS.

Keeney by Design products are specially packaged and suitable for showroom display.

Coming Soon...
Keeney's Special Finish
Special Order Program!

FOOT LOK STOP™							
K63WDSBN	1 1/2" O.D. PVD/BRUSHED NICKEL*	01575 8	CLAMSHELL	5 lbs.	3		
ROLLER BALL STOP - U.S. PATENT # 5,428,847							
K84WDSBN	1 1/2" O.D. PVD/BRUSHED NICKEL*	01577 2	CLAMSHELL	5 lbs.	3		
SCH. 40 - FOOT LOK STOP™ BATH DRAIN							
K630PVCDSDN	1 1/2" SCH 40 PVC - PVD/BRUSHED NICKEL*	01576 5	CLAMSHELL	8 lbs.	3		
K630PVCVB	1 1/2" SCH 40 PVC - VENETIAN BRONZE	01579 6	CLAMSHELL	8 lbs.	3		
K630ABSDBN	1 1/2" SCH 40 ABS - PVD/BRUSHED NICKEL*	02110 0	CLAMSHELL	8 lbs.	3		
SCH. 40 - ROLLER BALL STOP BATH DRAIN - U.S. PATENT # 5,428,847							
K650PVCDSDN	1 1/2" SCH 40 - PVD/BRUSHED NICKEL*	01578 9	CLAMSHELL	6 lbs.	3		
K650ABSDBN	1 1/2" SCH 40 - PVD/BRUSHED NICKEL*	02109 4	CLAMSHELL	6 lbs.	3		
ASSEMBLIES FOR FOOT LOK STOP™ - 5/16" THREADED SHAFT WITH STRAINER							
K826-20PC	POLISHED CHROME	01551 2	CLAMSHELL	2 lbs.	6		
K826-20DSBN	PVD/BRUSHED NICKEL*	01552 9	CLAMSHELL	1 lb.	3		
K826-20DSPB	PVD/POLISHED BRASS*	01553 6	CLAMSHELL	1 lb.	3		
FOOT LOK STOP™ REPLACEMENT CARTRIDGES							
K826-21PC	5/16" THREADED SHAFT - POLISHED CHROME	01572 7	CLAMSHELL	1 lb.	6		
K826-21DSBN	5/16" THREADED SHAFT - PVD/BRUSHED NICKEL*	01573 4	CLAMSHELL	1 lb.	3		
K826-21DSPB	5/16" THREADED SHAFT - PVD/POLISHED BRASS*	01574 1	CLAMSHELL	1 lb.	3		
K863-50PC	3/8" THREAD SHAFT - POLISHED CHROME	01563 5	CLAMSHELL	1 lb.	6		
K863-50DSBN	3/8" THREAD SHAFT - PVD/BRUSHED NICKEL*	01570 3	CLAMSHELL	1 lb.	3		
K863-50DSPB	3/8" THREAD SHAFT - PVD/POLISHED BRASS*	01566 6	CLAMSHELL	1 lb.	3		

KEENEY BY DESIGN COLLECTION











Part Num.	Item Description	UPC# 046224 +	Pkg	Ctn Wt	Ctn Qty	Line Art
ASSEMBLIES FOR LIFT & TURN - WITH STRAINER						
K62-3PC	POLISHED CHROME	01560 4	CARD	3 lbs.	6	
K62-3DSBN	PVD/BRUSHED NICKEL*	01561 1	CARD	1 lb.	3	
K62-3DSPB	PVD/POLISHED BRASS*	01562 8	CARD	1 lb.	3	
ASSEMBLIES FOR ROLLER BALL STOP - U.S. PATENT # 5,428,847						
K826-34PC	POLISHED CHROME	01547 5	CARD	4 lbs.	6	
K826-34DSBN	PVD/BRUSHED NICKEL*	01548 2	CARD	2 lbs.	3	
K826-34DSPB	PVD/POLISHED BRASS*	01549 9	CARD	2 lbs.	3	
STRAINER COVERS - DOME COVER WITH SCREW						
K5064PC	POLISHED CHROME	CARD	01543 7	1 lb.	6	
K5064DSBN	PVD/BRUSHED NICKEL*	CARD	01544 4	1 lb.	3	
K5064DSPB	PVD/POLISHED BRASS*	CARD	01545 1	1 lb.	3	
BATH DRAIN STRAINER COVERS - SNAP-IN STRAINER						
K820-56PC	FOR PRICE PFISTER STYLE CHROME PLATED	00436 3	CARD	1 lb.	6	
K820-56DSPB	FOR PRICE PFISTER STYLE PVD/POLISHED BRASS*	00437 0	CARD	1 lb.	3	
TRIPLEVER FACE PLATES - WITH SCREWS & PIN						
K826-1PC	POLISHED CHROME	01534 5	CARD	2 lbs.	6	
K826-1DSBN	PVD/BRUSHED NICKEL*	01535 2	CARD	1 lb.	3	
K826-1DSPB	PVD/POLISHED BRASS*	01536 9	CARD	1 lb.	3	
FACE PLATES - SINGLE HOLE - WITH SCREW						
K820-10PC	POLISHED CHROME	01540 6	CARD	1 lb.	6	
K820-10DSBN	PVD/BRUSHED NICKEL*	01541 3	CARD	1 lb.	3	
K820-10DSPB	PVD/POLISHED BRASS*	01542 0	CARD	1 lb.	3	
FACE PLATES - TWO HOLE - WITH SCREWS						
K826-11PC	POLISHED CHROME	01537 6	CARD	1 lb.	6	
K826-11DSBN	PVD/BRUSHED NICKEL*	01538 3	CARD	1 lb.	3	
K826-11DSPB	PVD/POLISHED BRASS*	01539 0	CARD	1 lb.	3	
FACE PLATE SCREWS						
K826-12PC	POLISHED CHROME	01569 7	CARD	1 lb.	6	
K826-12DSBN	PVD/BRUSHED NICKEL*	01570 3	CARD	1 lb.	3	
K826-12DSPB	PVD/POLISHED BRASS*	01571 0	CARD	1 lb.	3	
TRIM KITS FOR 1 3/8" OR 1 1/2" BATH DRAINS INCLUDES: TRIPLEVER FACE PLATE, STRAINER, CONVERSION BUSHING AND FACE PLATE CONVERTER						
K826-65PC	TRIPLEVER - POLISHED CHROME	01531 4	CLAMSHELL	4 lbs.	6	
K826-65VB	TRIPLEVER - VENETIAN BRONZE	01533 8	CLAMSHELL	2 lbs.	3	
K826-69DSBN	TRIPLEVER - PVD FINISH/BRUSHED NICKEL*	01532 1	CLAMSHELL	2 lbs.	3	

KEENEY BY DESIGN COLLECTION



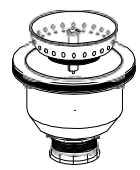
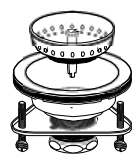

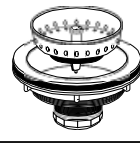
Part Num.	Item Description	UPC# 046224 +	Pkg	Ctn Wt	Ctn Qty	Line Art
TRIM KITS FOR 1 3/8" OR 1 1/2" BATH DRAINS INCLUDES: 1 HOLE FACE PLATE, STRAINER, CONVERSION BUSHING AND FACE PLATE CONVERTER						
K826-66BC	FOOT LOK STOP™ PVD FINISH/BRUSHED CHROME*	02014 1	CLAMSHELL	1 lb.	1	
K826-66FG	FOOT LOK STOP™ - FRENCH GOLD	02011 0	CLAMSHELL	1 lb.	1	
K826-66PC	FOOT LOK STOP™ - POLISH CHROME	01528 4	CLAMSHELL	1 lb.	1	
K826-66PL	FOOT LOK STOP™ - PLATINUM	01528 4	CLAMSHELL	4 lbs.	6	
K826-66ORB	FOOT LOK STOP™ OIL RUBBED BRONZE	02015 8	CLAMSHELL	1 lb.	1	
K826-66VB	FOOT LOK STOP™ - VENETIAN BRONZE	01530 7	CLAMSHELL	2 lbs.	3	
K826-66WI	FOOT LOK STOP™ - WROUGHT IRON	02013 4	CLAMSHELL	1 lb.	1	
K826-71DSBN	FOOT LOK STOP™ PVD FINISH/BRUSHED NICKEL*	01529 1	CLAMSHELL	2 lbs.	3	
TRIM KITS FOR 1 3/8" OR 1 1/2" BATH DRAINS INCLUDES: 1 HOLE FACE PLATE, STRAINER, CONVERSION BUSHING AND FACE PLATE CONVERTER						
K826-81PC	ROLLER BALL - POLISHED CHROME	01524 6	CLAMSHELL	4 lbs.	6	
K826-81BC	ROLLER BALL - PVD/BRUSHED CHROME*	02007 3	CLAMSHELL	1 lb.	1	
K826-81DSBN	ROLLER BALL - PVD/BRUSHED NICKEL*	01526 0	CLAMSHELL	2 lbs.	3	
K826-81FG	ROLLER BALL - PVD/FRENCH GOLD*	02007 3	CLAMSHELL	1 lb.	1	
K826-81ORB	ROLLER BALL - OIL RUBBED BRONZE	01984 8	CLAMSHELL	1 lb.	1	
K826-81PL	ROLLER BALL - PVD/PLATINUM*	02009 7	CLAMSHELL	1 lb.	1	
K826-81VB	ROLLER BALL - VENETIAN BRONZE	01527 7	CLAMSHELL	2 lbs.	3	
K826-81WI	ROLLER BALL - WROUGHT IRON	02007 3	CLAMSHELL	1 lb.	1	
LINKAGE ASSEMBLIES FOR TRIPLEVER						
K64-14W	6" EYEWIRE, 10-32 BRASS EYE BOLT, CLEVIS PLUNGER & COTTER PIN - PLASTIC	01558 1	CARD	1 lb.	6	
K606-22	6" EYEWIRE, 10-32 BRASS EYE BOLT, CLEVIS PLUNGER & COTTER PIN - BRASS	01559 8	CARD	1 lb.	6	
REPLACEMENT WASHERS						
K826-3	OVERFLOW WASHER - BEVELED TYPE	01557 4	CARD	1 lb.	6	
K826-22	RUBBER WASHER FOR 1 1/2" WASTE SHOE	01567 3	CARD	1 lb.	6	
K863-11	RUBBER WASHER FOR FOOT LOK STOP™	01568 0	CARD	1 lb.	6	
K821-39	RUBBER WASHER AND OVERFLOW WASHER CLIP ON	01554 3	CARD	1 lb.	6	
STRAINER - REPLACEMENT PARTS						
K22022	SPRING STYLE STRAINER WITH FIXED POST	01632 8	BAG	3 lbs.	15	
K820-22DSBN	SPRING STYLE WITH FIXED POST BRUSHED NICKEL	01617 5	CARD	1 lb.	3	
K820-22DSPB	SPRING STYLE WITH FIXED POST POLISHED BRASS	01618 2	CARD	1 lb.	3	

KEENEY BY DESIGN COLLECTION



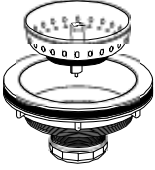

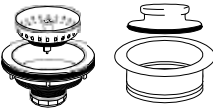
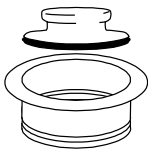
* "PVD" is a tarnish free product

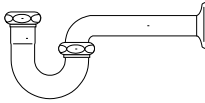
Part Num.	Item Description	UPC# 046224 +	Pkg	Ctn Wt	Ctn Qty	Line Art
STRAINER - REPLACEMENT PARTS - CONTINUED						
K820-50	SPRING STYLE STRAINER	01620 5	CARD	1 lb.	6	
K22025	SPRING STYLE STRAINER WITH ADJUSTABLE DROP POST - CHROME PLATED	01633 5	BAG	3 lbs.	15	
K1433-1	"TURN 2 SEAL" BASKET- STAINLESS STEEL	01619 9	CARD	1 lb.	6	
K1438-1	ADJ. POST BASKET - POLISHED CHROME	01621 2	CARD	2 lbs.	6	
K22013	STRAINER BASKET REPLACEMENT STICK POST	01627 4	BAG	4 lbs.	15	
K2082026	STRAINER BASKET REPLACEMENT - WHITE	01628 1	BAG	2 lbs.	15	
KITCHEN BASKET STRAINERS - 3 1/2" DIAMETER - PLASTIC						
K1442PC	DEEP CUP - CHROME	01611 3	CLAMSHELL	3 lbs.	6	
K1442WH	DEEP CUP - WHITE	01612 0	CLAMSHELL	2 lbs.	3	
K1442BLK	DEEP CUP - BLACK	01898 8	CLAMSHELL	2 lbs.	3	
K1442BSQ	DEEP CUP - BISCUIT	01613 7	CLAMSHELL	2 lbs.	3	
KITCHEN BASKET STRAINERS - "SCREW STYLE" - STAINLESS STEEL						
K5416	FIXED STICK POST BASKET THUMB SCREW LOCK NUT FOR EASY INSTALL	01609 0	CLAMSHELL	5 lbs.	6	
KITCHEN BASKET STRAINERS - "TURN 2 SEAL" - STAINLESS STEEL						
K5410	WATER SEAL "TURN 2 SEAL" TYPE BASKET METAL DROP POST & STOPPER	01511 6	CLAMSHELL	6 lbs.	6	
KITCHEN BASKET STRAINER - "LONG SHANK" - STAINLESS STEEL FOR 3 1/2" DIAMETER OPENING - FOR CAST IRON SINK						
K5412	STAINLESS STEEL LOCKING SHELL - DEEP CUP WITH ROLLED EDGE BASKET	01599 4	CLAMSHELL	6 lbs.	6	
KITCHEN BASKET STRAINERS - STAINLESS STEEL BODY WITH CUT THREADS FOR 3 1/2" DIAMETER OPENING - DIE CAST SLIP NUT & ROLLED EDGE BASKET						
K5414	WITH FIXED POST BASKET	01608 3	CLAMSHELL	4 lbs.	6	
K5414-2	WITH FIXED POST BASKET - 2 PACK	01622 9	CLAMSHELL	8 lbs.	6	
KITCHEN BASKET STRAINER - STAINLESS STEEL BODY ROLLED EDGE BASKET - FOR 3 1/2" DIAMETER OPENING						
K5419	"SPRING STYLE" - BASKET FOR TIGHT SEAL	01598 7	CLAMSHELL	6 lbs.	6	
BAR SINK STRAINER - STAINLESS STEEL						
K5420	WITH LONG BASKET	01596 3	CLAMSHELL	3 lbs.	6	

KEENEY BY DESIGN COLLECTION

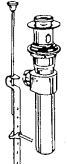
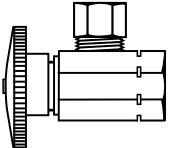
Part Num.	Item Description	UPC# 046224 +	Pkg	Ctn Wt	Ctn Qty	Line Art
JR. DUO STRAINERS - STAINLESS STEEL WITH 4 PRONG BASKET						
FOR 2 - 2 1/2" DIAMETER OPENING						
K5421	STAINLESS STEEL WITH BASKET	01607 6	CLAMSHELL	2 lbs.	6	
BRASS KITCHEN BASKET STRAINERS - "BRASS WORK HORSE" - FIXED CENTER POST BASKET						
FOR 3 1/2" DIAMETER OPENING						
K5435	CHROME PLATED BRASS BODY	01591 8	CLAMSHELL	6 lbs.	6	
K5435DSPB	PVD FINISH/POLISHED BRASS*	01593 2	CLAMSHELL	3 lbs.	3	
K5435DSBN	PVD/BRUSHED NICKEL*	01592 5	CLAMSHELL	3 lbs.	3	
K5435DSSS	PVD FINISH/SATIN STAINLESS*	01595 6	CLAMSHELL	3 lbs.	3	
K5435VB	VENETIAN BRONZE	01594 9	CLAMSHELL	3 lbs.	3	
K5435PL	PVD FINISH/PLATINUM	02002 8	CLAMSHELL	1 lb.	1	
K5435ORB	OIL RUBBED BRONZE	02000 4	CLAMSHELL	1 lb.	1	
K5435FG	PVD/FRENCH GOLD	01993 0	CLAMSHELL	1 lb.	1	
K5435WI	WROUGHT IRON	01987 9	CLAMSHELL	1 lb.	1	
CAST BRASS KITCHEN BASKET STRAINERS - "COMMERCIAL GRADE" - GROUND JOINT						
DROP POST BASKET - BRASS LOCKNUT & SLIP NUT - FOR 3 1/2" DIAMETER OPENING						
K5445	CHROME PLATED	01589 5	CLAMSHELL	9 lbs.	6	
K5445DSBN	PVD/BRUSHED NICKEL*	01590 1	CLAMSHELL	4 lbs.	3	
PLASTIC BODY KITCHEN BASKET STRAINER - STAINLESS STEEL RIM AND BASKET						
FOR 3 1/2" DIAMETER OPENING						
K5450	WITH FIXED POST	01610 6	CLAMSHELL	3 lbs.	6	
COMBO KITCHEN BASKET STRAINER AND STOPPER - FOR 3 1/2" DIAMETER OPENING						
THE "BRASS WORK HORSE" - FIXED CENTER POST BASKET AND THE DISPOSAL FLANGE SET						
K5475	POLISHED CHROME	01600 7	CLAMSHELL	8 lbs.	6	
K5475DSBN	PVD/BRUSHED NICKEL*	01601 4	CLAMSHELL	4 lbs.	3	
GARBAGE DISPOSAL REPLACEMENT FLANGE & STOPPER						
K5417	POLISHED CHROME	01602 1	CLAMSHELL	2 lbs.	6	
K5417BSQ	BISQUE	01606 9	CLAMSHELL	1 lb.	3	
K5417DSBN	PVD/BRUSHED NICKEL*	01603 8	CLAMSHELL	1 lb.	3	
K5417DSPB	PVD/POLISHED BRASS*	01604 5	CLAMSHELL	1 lb.	3	
K5417VB	VENETIAN BRONZE	01899 5	CLAMSHELL	1 lb.	3	
K5417WH	WHITE	01605 2	CLAMSHELL	1 lb.	3	
"POP-IN STOPPER" INSERT - COVERS STRAINER AND GARBAGE DISPOSAL OPENINGS						
K5451	POLISHED CHROME	01614 4	CLAMSHELL	1 lb.	6	
K5471	ALMOND	01616 8	CLAMSHELL	1 lb.	6	
K5461	WHITE	01615 1	CLAMSHELL	1 lb.	6	
P-TRAPS - LESS CLEANOUT - 1 1/4" X 1 1/4"						
K100PB	20 GAUGE - POLISHED BRASS	01887 2	CLAMSHELL	6 lbs.	6	
K100BN	20 GAUGE - BRUSHED NICKEL	01888 9	CLAMSHELL	6 lbs.	6	
K100VB	20 GAUGE - VENETIAN BRONZE	01886 5	CLAMSHELL	6 lbs.	6	

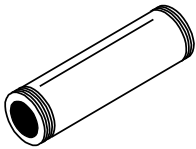
KEENEY BY DESIGN COLLECTION

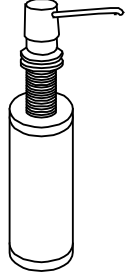
Part Num.	Item Description	UPC# 046224 +	Pkg	Ctn Wt	Ctn Qty	Line Art
MECHANICAL POP-UPS - 1 1/4" WITH 4" TAILPIECE						
K820-77BN	2 PIECE - BRUSHED NICKEL	01866 7	CARD	8 lbs.	6	
K820-77PB	2 PIECE - POLISHED BRASS	01867 4	CARD	8 lbs.	6	
K820-77VB	2 PIECE - VENETIAN BRONZE	01868 1	CARD	8 lbs.	6	
F.I.P. X COMPRESSION - ANGLE QUARTER TURN VALVES - BOXED						
K2048APB	1/2" F.I.P. X 3/8" O.D. - POLISHED BRASS	01831 5	CLAMSHELL	3 lbs.	6	
K2048ABN	1/2" F.I.P. X 3/8" O.D. - BRUSHED NICKEL	01830 8	CLAMSHELL	3 lbs.	6	
K2048AVB	1/2" F.I.P. X 3/8" O.D. - VENETIAN BRONZE	01832 2	CLAMSHELL	3 lbs.	6	
FLANGES - SHALLOW - 3/8"						
K90BN	SLIPS 3/8" I.P.S. - BRUSHED NICKEL	01833 9	CARD	1 lb.	6	
K90PB	SLIPS 3/8" I.P.S. - POLISHED BRASS	01834 6	CARD	1 lb.	6	
K90VB	SLIPS 3/8" I.P.S. - VENETIAN BRONZE	01835 3	CARD	1 lb.	6	
FLANGES - SHALLOW - 1/2"						
K91BN	SLIPS 1/2" I.P.S. - BRUSHED NICKEL	01836 0	CARD	1 lb.	6	
K91PB	SLIPS 1/2" I.P.S. - POLISHED BRASS	01864 3	CARD	1 lb.	6	
K91VB	SLIPS 1/2" I.P.S. - VENETIAN BRONZE	01865 0	CARD	1 lb.	6	
NIPPLES						
K33-10BN	3/8" I.P.S. X 3" - BRUSHED NICKEL	01894 0	BOX	1 lb.	6	
K33-10PB	3/8" I.P.S. X 3" - POLISHED BRASS	01893 3	BOX	1 lb.	6	
K33-10VB	3/8" I.P.S. X 3" - VENETIAN BRONZE	01892 6	BOX	1 lb.	6	
K33-40BN	1/2" I.P.S. X 4" - BRUSHED NICKEL	01891 9	BOX	2 lbs.	6	
K33-40PB	1/2" I.P.S. X 4" - POLISHED BRASS	01890 2	BOX	2 lbs.	6	
K33-40VB	1/2" I.P.S. X 4" - VENETIAN BRONZE	01889 6	BOX	2 lbs.	6	
SUPPLY SMOOTH RISER TUBES - LAVATORY						
K40-20PB	3/8" O.D. X 20" - POLISHED BRASS	01896 4	CARD	2 lbs.	6	
K40-20BN	3/8" O.D. X 20" - BRUSHED NICKEL	01897 1	CARD	2 lbs.	6	
K40-20VB	3/8" O.D. X 20" - VENETIAN BRONZE	01895 7	CARD	2 lbs.	6	
SUPPLY SMOOTH RISER TUBES - CLOSET						
K30-20PB	3/8" O.D. X 20" - POLISHED BRASS	01870 4	CARD	2 lbs.	6	
K30-20BN	3/8" O.D. X 20" - BRUSHED NICKEL	01869 8	CARD	2 lbs.	6	
K30-20VB	3/8" O.D. X 20" - VENETIAN BRONZE	01871 1	CARD	2 lbs.	6	
SOAP LOTION DISPENSERS						
K612DSBN	PREMIUM BRUSHED NICKEL	01585 7	CLAMSHELL	3 lbs.	3	
K612DSPB	PREMIUM POLISHED BRASS	01586 4	CLAMSHELL	3 lbs.	3	
K612DSSS	PREMIUM SATIN STAINLESS	01588 8	CLAMSHELL	3 lbs.	3	
K612PC	PREMIUM POLISHED CHROME	01584 0	CLAMSHELL	3 lbs.	3	
K612VB	PREMIUM VENETIAN BRONZE	01587 1	CLAMSHELL	3 lbs.	3	
K612WH	PREMIUM WHITE	01583 3	CLAMSHELL	3 lbs.	3	
K86011PC	POLISHED CHROME	01623 6	BAG	6 lbs.	7	
K86011WH	WHITE	01624 3	BAG	6 lbs.	7	

KEENEY BY DESIGN COLLECTION

Part Num.	Item Description	UPC# 046224 +	Pkg	Ctn Wt	Ctn Qty	List Price	Line Art
-----------	------------------	---------------	-----	--------	---------	------------	----------

Keeney Tubular Program Convenience Center

The Keeney Manufacturing Company, a recognized leader in the tubular brass and plastic products industry since 1923, has the Tubular Program Convenience Center.

Our extensive product offering ensures that your shelves are filled with products contractors need to complete their jobs, and the fully bar-coded line speeds up the check out process and allows inventory accuracy.

Customized Planograms available on request. Shelving not included.



Descriptive color coded labels



Product photographs



Quick accurate location of parts

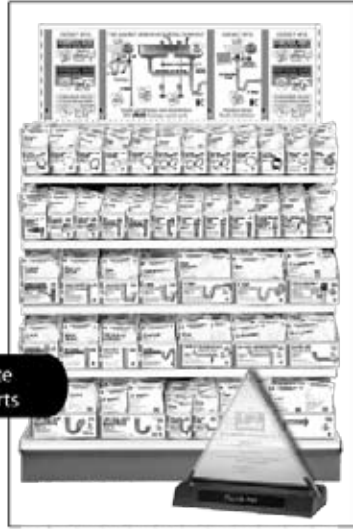

WE PUT TUBULAR PRODUCTS AT YOUR CUSTOMER'S FINGERTIPS!

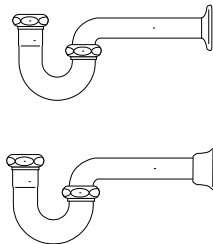
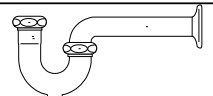
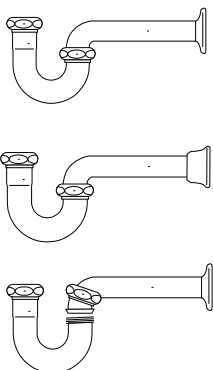

Labels
• Color coded • Product photos • Descriptive
Which ensure efficient customer product identification - the right part for the job, fast!

P TRAPS - LESS CLEANOUT - 1 1/4" X 1 1/4"							
300CK	22 GA CHROME PLATED	00587 2	BAG	6.3 lbs.	10		
300K	20 GA CHROME PLATED	00678 7	BOX	8.8 lbs.	10		
301K	17 GA CHROME PLATED	00676 3	BOX	10.8 lbs.	10		
301CPBNDFK	17GA CHROME PLATED WITH BRASS NUTS DEEP FLANGE	01781 3	BOX	11 lbs.	10		
301CPBN866K	17GA CHROME PLATED WITH BRASS NUTS BOX FLANGE	01973 2	BOX	11 lbs.	10		
6300K	20 GA POLISHED BRASS	00590 2	BOX	4.4 lbs.	5		
SEMI-CAST TRAPS WITH CLEANOUT AND BRASS NUTS - 1 1/4" X 1 1/4"							
5303K	17 GA SEMI CAST CHROME PLATED	00540 7	BAG	8.45 lbs.	5		
P TRAPS - LESS CLEANOUT - 1 1/2" X 1 1/2"							
304CK	22 GA CHROME PLATED	00588 9	BAG	7.9 lbs.	10		
304K	20 GA CHROME PLATED	00677 0	BOX	10.6 lbs.	10		
305K	17 GA CHROME PLATED	00675 6	BOX	13.4 lbs.	10		
305CPBNDFK	17GA CHROME PLATED WITH BRASS NUTS DEEP FLANGE	01779 0	BOX	14 lbs.	10		
305CPBN867K	17GA CHROME PLATED WITH BRASS NUTS BOX FLANGE	01972 5	BOX	14 lbs.	10		
305XBNK	17 GA CHROME PLATED GROUND JOINT WITH BRASS NUTS	00618 3	BOX	15 lbs.	10		



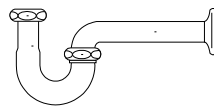
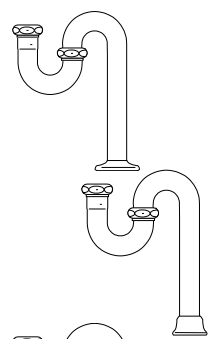
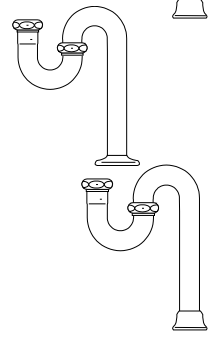
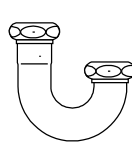
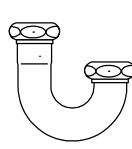
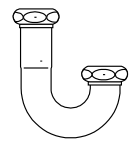
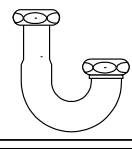
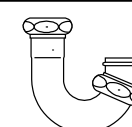
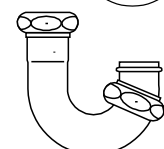

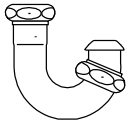
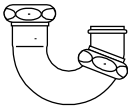
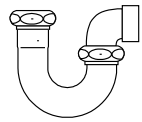
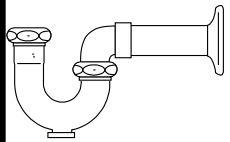
CONVENIENCE CENTER

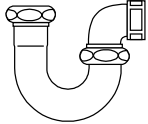
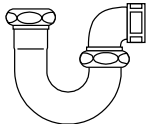
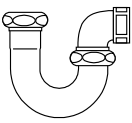
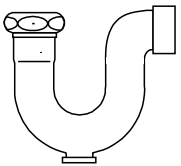
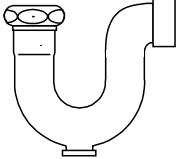
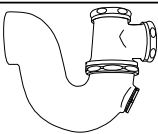
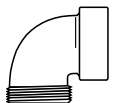
CONVENIENCE CENTER



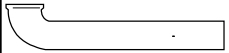
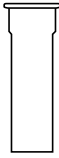
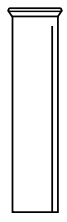

Part Num.	Item Description	UPC# 046224 +	Pkg	Ctn Wt	Ctn Qty	List Price	Line Art
P TRAPS - LESS CLEANOUT - 1 1/2" X 1 1/4" WITH REDUCED INLET							
318K	20 GA CHROME PLATED	00619 0	BOX	12 lbs.	10		
319K	17 GA CHROME PLATED	00621 3	BOX	15 lbs.	10		
319XK	17 GA CHROME PLATED - GROUND JOINT	02146 9	BOX	15 lbs.	10		
S TRAPS - LESS CLEANOUT - 1 1/4" X 1 1/4"							
324CK	22 GA CHROME PLATED	00586 5	BAG	5.35 lbs.	5		
324K	20 GA CHROME PLATED	00680 0	BOX	4.38 lbs.	3		
325K	17 GA CHROME PLATED	01780 6	BOX	6 lbs.	3		
325CPBNDFK	20 1/2" 17GA CHROME PLATED BRASS NUTS - DEEP FLANGE	01774 5	BOX	6 lbs.	3		
325CPBN866K	20 1/2" 17GA CHROME PLATED BRASS NUTS - BOX FLANGE	01970 1	BOX	6 lbs.	25		
S TRAPS - LESS CLEANOUT - 1 1/2" X 1 1/2"							
332CK	22 GA CHROME PLATED	00585 8	BAG	7.15 lbs.	5		
332K	20 GA CHROME PLATED	00679 4	BOX	4.95 lbs.	3		
333K	17GA CHROME PLATED	01775 2	BOX	7 lbs.	3		
333CPBNDFK	17GA CHROME PLATED BRASS NUTS - DEEP FLANGE	01776 9	BOX	7 lbs.	3		
333CPBN867K	17GA CHROME PLATED BRASS NUTS - BOX FLANGE	01969 5	BOX	7 lbs.	3		
J BENDS - LESS CLEANOUT - 1 1/4" X 1 1/4"							
10300CK	22 GA CHROME PLATED	00561 2	BAG	3.6 lbs.	10		
J BENDS - LESS CLEANOUT - 1 1/2" X 1 1/2"							
10304CK	22 GA CHROME PLATED	00564 3	BAG	4.8 lbs.	10		
10305K	17 GA CHROME PLATED	01782 0	BAG	7 lbs.	10		
J BENDS - HI INLET - 1 1/2" X 1 1/2"							
10404CK	22 GA CHROME PLATED	00617 6	BAG	5.25 lbs.	10		
10418CK	22 GA CHROME PLATED	02149 0	BOX	7 lbs.	10		
J BENDS - LESS CLEANOUT - 1 1/2" X 1 1/4" WITH REDUCED INLET							
10318K	20 GA CHROME PLATED	00627 5	BOX	5.3 lbs.	10		
10319K	17 GA CHROME PLATED	00628 2	BOX	6.4 lbs.	10		
SINK TRAP J-BEND - CLEANOUT - 1 1/4" X 1 1/4"							
10487K	22 GA CHROME PLATED	00559 9	BAG	2.65 lbs.	5		
SINK TRAP J-BENDS - LESS CLEANOUT - 1 1/2" X 1 1/2" - BRASS NUT							
10488K	22 GA CHROME PLATED	00569 8	BAG	3.2 lbs.	5		
10455XRBBNK	17 GA ROUGH BRASS GROUND JOINT	00610 7	BOX	9 lbs.	10		
10455XBNK	17 GA CHROME PLATED GROUND JOINT	00612 1	BOX	9 lbs.	10		

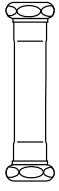
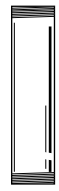
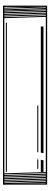

Part Num.	Item Description	UPC# 046224 +	Pkg	Ctn Wt	Ctn Qty	List Price	Line Art
SINK TRAP J-BENDS - LESS CLEANOUT - 1 1/2" X 1 1/2" - BRASS NUT							
10455XK	17 GA CHROME PLATED - GROUND JOINT	02147 6	BOX	4 lbs.	10		
10455BNK	17 GA CHROME PLATED	02148 3	BOX	8 lbs.	10		
SINK TRAP J-BEND - LOW INLET WITH BRASS NUT - LESS CLEANOUT - 1 1/2" X 1 1/2"							
10298K	20 GA CHROME PLATED	01748 6	BAG	2 lbs.	5		
SINK TRAP - LESS CLEANOUT WITH CAST ELBOW - WASHER (BEADED CONNECTION) - 1 1/4" X 1 1/4"							
454K	22 GA CHROME PLATED IPS	00599 5	BAG	4.8 lbs.	5		
SINK TRAP FOR CONNECTION TO ABS/PVC SCH 40 TUBE GROUND JOINT - 1 1/2"							
461XPCPVCK	17 GA 1 1/2" POLISHED CHROME WITH PVC ADAPTER WITH CLEANOUT COVERING TUBE AND SHALLOW FLANGE	00684 8	BOX	12.8 lbs.	10		
L.A. SINK TRAP - LESS CLEANOUT - CAST BRASS - 1 1/2" X 1 1/4"							
389CPK	17GA CHROME PLATED		01653 3	BOX	9 lbs.	5	
450K	17GA GROUND JOINT - BRASS NUT AND REDUCER WASHER		02211 4	BOX	12 lbs.	10	
L.A. SINK TRAP GROUND JOINT WITH BRASS NUTS - 1 1/2"							
451K	17 GA CHROME PLATED	00685 5	BOX	12 lbs.	10		
451RBK	17 GA ROUGH BRASS	00604 6	BOX	14 lbs.	10		
L.A. SINK TRAP - LESS CLEANOUT - CAST BRASS WITH BRASS NUTS - 2" X 1 1/2"							
382RBK	17GA ROUGH BRASS	01648 9	BOX	9 lbs.	5		
N.Y. SINK TRAP - WITH CLEANOUT - CAST BRASS - 1 1/2" X 1 1/4"							
386CPK	17 GA CHROME PLATED	01649 6	BOX	9 lbs.	5		
386RBK	17 GA ROUGH BRASS	01650 2	BOX	9 lbs.	5		
N.Y. SINK TRAP - WITH CLEANOUT - CAST BRASS - 2" X 1 1/2"							
387RBK	17 GA ROUGH BRASS	01651 9	BOX	9 lbs.	5		
N.Y. SINK TRAP - LESS CLEANOUT - CAST BRASS - 1 1/2" X 1 1/2"							
388RBK	17 GA ROUGH BRASS	01652 6	BOX	9 lbs.	5		
SWING TEE CAST BRASS SINK TRAP - CLEANOUT - 2" X 1 1/2" X 1 1/2"							
381RBK	ROUGH BRASS	01753 0	BOX	9 lbs.	5		
ELBOW CAST BRASS - 1 1/2"							
30455K	CHROME PLATED FOR IPS	00638 1	BAG	3.95 lbs.	5		



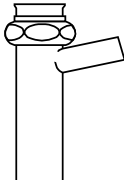
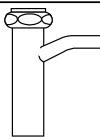
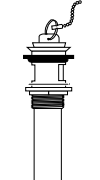

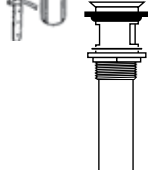
Part Num.	Item Description	UPC# 046224 +	Pkg	Ctn Wt	Ctn Qty	List Price	Line Art
WALLBENDS - 1 1/4"							
30300CK	22 GA 7" CHROME PLATED	00565 0	BULK	1.4 lbs.	5		
WALLBENDS - 1 1/2"							
30304CK	22 GA 7" CHROME PLATED	00566 7	BULK	2 lbs.	5		
30304CRBK	22 GA 7" ROUGH BRASS	01647 2	BULK	2 lbs.	5		
FLOOR TUBES - 1 1/4"							
30324CK	22 GA 20 1/2" CHROME PLATED	00567 4	BULK	3.8 lbs.	5		
FLOOR TUBES - 1 1/2"							
30332CK	22 GA 20 1/2" CHROME PLATED	00568 1	BULK	5 lbs.	5		
CONTINUOUS WASTE - END OUTLET SLIP JOINT - CAST TEE - 1 1/2"							
4815K	22 GA 16" CHROME PLATED	00598 8	BAG	6.15 lbs.	5		
CONTINUOUS WASTE - END OUTLET DIRECT CONNECT - CAST TEE - 1 1/2"							
4815AK	22 GA 16" CHROME PLATED	00642 8	BAG	5.8 lbs.	5		
CONTINUOUS WASTE - CENTER OUTLET SLIP JOINT - CAST TEE - 1 1/2"							
4568K	22 GA 16" CHROME PLATED	00597 1	BAG	6.4 lbs.	5		
CONTINUOUS WASTE - CENTER OUTLET DIRECT CONNECT - CAST TEE - 1 1/2"							
4568AK	22 GA 16" CHROME PLATED	00640 4	BAG	6.25 lbs.	5		
CAST TEES WITH TAILPIECE, NUTS AND WASHERS - CENTER OUTLET - 1 1/2"							
538BRBK	CHROME PLATED - SLIP JOINT	00624 4	BAG	3.25 lbs.	5		
538K	CHROME PLATED - SLIP JOINT	00577 3	BAG	2.35 lbs.	5		
CAST TEES WITH TAILPIECE, NUTS AND WASHERS - END OUTLET - 1 1/2"							
540AK	CHROME PLATED DIRECT CONNECT	00643 5	BAG	4.2 lbs.	5		
540BNSK	ROUGH BRASS - SLIP JOINT	00616 9	BAG	4.3 lbs.	5		
WROUGHT TEES - WITH TAILPIECE - END OUTLET - WITH BAFFLE - 1 1/2"							
540ATTK	ROUGH BRASS DIRECT CONNECT	00763 0	BAG	4.2 lbs.	5		
540TTK	CHROME PLATED SLIP JOINT	00576 6	BAG	2.8 lbs.	5		
WASTE ARMS SLIP JOINT - 1 1/2"							
2519RBK	22 GA 11-1/2" ROUGH BRASS	01644 1	BULK	2 lbs.	5		
2521K	22 GA 15" CHROME PLATED	00581 0	BAG	7.1 lbs.	10		
2521RBK	22 GA 15" ROUGH BRASS	00614 5	BAG	12.7 lbs.	10		
2528RBK	22 GA 18" ROUGH BRASS	01646 5	BULK	4 lbs.	5		
2523RBK	22 GA 24" ROUGH BRASS	01645 8	BULK	4 lbs.	5		
2527RBK	22 GA 36" ROUGH BRASS	01746 2	BULK	10 lbs.	10		

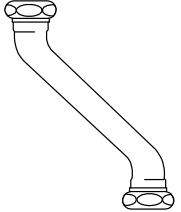
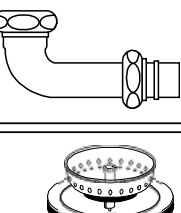
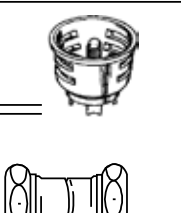
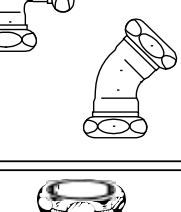
Part Num.	Item Description	UPC# 046224 +	Pkg	Ctn Wt	Ctn Qty	List Price	Line Art	
WASTE ARMS DIRECT CONNECT - 1 1/2"								
2521ARBK	22 GA 15" ROUGH BRASS	00636 7	BULK	6.2 lbs.	10			
2521AK	22 GA 15" CHROME PLATED	00635 0	BULK	3.81 lbs.	5			
2526AK	22 GA 21" CHROME PLATED	00637 4	BULK	3.81 lbs.	5			
SINK TAILPIECE - 1 1/2" X 1 1/4"								
117K	22 GA 8" CHROME PLATED - REDUCING	01960 2	BAG	1 lb.	5			
SINK TAILPIECES - 1 1/2"								
110K	22 GA 4" CHROME PLATED	00683 1	BULK	1.4 lbs.	10			
111K	22 GA 6" CHROME PLATED	00571 1	BULK	2.25 lbs.	10			
111RBK	22 GA 6" ROUGH BRASS	01642 7	BULK	2 lbs.	10			
112K	22 GA 8" CHROME PLATED	01961 9	BAG	1 lb.	5			
114K	22 GA 12" CHROME PLATED	00578 0	BULK	4.15 lbs.	10			
114RBK	22 GA 12" ROUGH BRASS	01643 4	BULK	4 lbs.	10			
120RBK	22 GA 18" ROUGH BRASS	01743 1	BULK	3 lbs.	5			
130RBK	22 GA 24" ROUGH BRASS	01744 8	BULK	4 lbs.	5			
214K	20 GA 12" CHROME PLATED	00682 4	BULK	5.4 lbs.	10			
140K	17 GA 4" CHROME PLATED	01784 4	BAG	1 lb.	5			
142K	17 GA 8" CHROME PLATED	01787 5	BAG	2 lbs.	5			
144K	17 GA 12" CHROME PLATED	00681 7	BULK	7.0 lbs.	10			
SINK TAILPIECES - DOUBLE END FLANGED - 1 1/2"								
1148K	22 GA 16" CHROME PLATED	02053 0	BAG	5 lbs.	10			
EXTENSION TUBES - SLIP JOINT - 1 1/4"								
1901K	22 GA 6" CHROME PLATED	00572 8	BAG	2.7 lbs.	10			
12PBK	22 GA 6" POLISHED BRASS	00591 9	BAG	1.65 lbs.	5			
1903K	22 GA 12" CHROME PLATED	00579 7	BAG	4.3 lbs.	10			
EXTENSION TUBES - SLIP JOINT - 1 1/2"								
1904K	22 GA 6" CHROME PLATED	00573 5	BAG	3.1 lbs.	10			
1906K	22 GA 12" CHROME PLATED	00580 3	BAG	5.1 lbs.	10			
EXTENSION TUBES - SLIP JOINT - DOUBLE ENDS - 1 1/4"								
1907K	16" 22GA CHROME	02054 7	BAG	6 lbs.	10			
EXTENSION TUBES - SLIP JOINT - DOUBLE END - 1 1/2"								
1908K	16" 22GA CHROME	02055 4	BAG	7 lbs.	10			
THREADED TUBES - THREADED BOTH ENDS - 1 1/4"								
1120K	20 GA 6" CHROME PLATED	00574 2	BULK	1.35 lbs.	5			
1161K	20 GA 12" CHROME PLATED	00630 5	BULK	4 lbs.	10			
1773K	17 GA 12" CHROME PLATED	00686 2	BULK	5.7 lbs.	10			

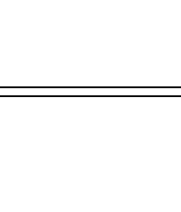

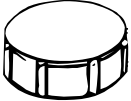



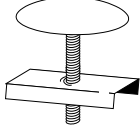

CONVENIENCE CENTER

Part Num.	Item Description	UPC# 046224 +	Pkg	Ctn Wt	Ctn Qty	List Price	Line Art
THREADED TUBES - THREADED BOTH ENDS - 1 3/8"							
1162RBK	20 GA 12" ROUGH BRASS	01749 3	BULK	4 lbs.	10		
1169RBK	20 GA 18" ROUGH BRASS	01751 6	BULK	5 lbs.	5		
THREADED TUBES - THREADED BOTH ENDS - 1 1/2"							
1122K	20 GA 6" CHROME PLATED	00575 9	BULK	1.65 lbs.	5		
1164K	20 GA 12" CHROME PLATED	00687 9	BULK	5.3 lbs.	10		
1164RBK	20 GA 12" ROUGH BRASS	01742 4	BULK	5 lbs.	10		
1168RBK	20 GA 18" ROUGH BRASS	01740 0	BULK	4 lbs.	5		
1166RBK	20 GA 24" ROUGH BRASS	01741 7	BULK	3 lbs.	5		
1775RBK	17 GA 8" ROUGH BRASS	01785 1	BAG	2 lbs.	5		
THREADED TUBES - THREADED ONE END - 1 1/2"							
2129RBK	22 GA 4" LA CODE APPROVED	 00634 3	BULK	4 lbs.	10		
BRANCH TAILPIECES - 3/4" BRANCH (7/8" O.D.) PLAIN END - 1 1/2"							
FOR RUBBER HOSE AND CLAMP OR 3/4" SWEAT CONNECTION - DIRECT CONNECT							
49K	22 GA 8" CHROME PLATED - BRASS NUT	00483 7	BAG	2.1 lbs.	5		
47SK	17 GA 8" CHROME PLATED - BRASS NUT	01772 1	BAG	4 lbs.	5		
BRANCH TAILPIECES - 3/4" BRANCH (7/8" O.D.) PLAIN END - 1 1/2"							
FOR RUBBER HOSE AND CLAMP OR 3/4" SWEAT CONNECTION - SLIP JOINT							
54K	22 GA 8" CHROME PLATED - PLAIN END	00596 4	BAG	2.5 lbs.	5		
LONG NECK BRANCH TAILPIECE 5/16" O.D. - 1 1/2"							
41RBK	20 GA 12" ROUGH BRASS DIRECT CONNECT BRASS NUT	00639 8	BAG	2.1 lbs.	5		
PO PLUG - ONE PIECE P.O. PLUG - 1 1/4"							
1681K	22 GA 5" CHROME PLATED	00570 4	BAG	3.2 lbs.	10		
CO PLUG - ONE PIECE - 1 1/4"							
681K	22 GA 5" CHROME PLATED - LESS OVERFLOW	00543 8	BAG	2.15 lbs.	5		
MECHANICAL POP-UP - WITH 4" TAILPIECE - TWO PIECE - 1 1/4"							
1688K	POLISHED CHROME	00542 1	BOX	10.35 lbs.	10		
1688DSK	PVD/POLISHED BRASS*	00771 5	BOX	10.6 lbs.	10		
1688DSBNK	PVD/POLISHED BRUSHED NICKEL*	00772 2	BOX	11 lbs.	10		
CAST BRASS LAVATORY GRID STRAINER							
5680K	1 1/4" X 6" CHROME PLATED WITH OPEN GRID STRAINER	00541 4	BAG	3.57 lbs.	5		

Part Num.	Item Description	UPC# 046224 +	Pkg	Ctn Wt	Ctn Qty	List Price	Line Art
DOUBLE OFFSET - 1 PIECE - 1 1/4" X 1 1/4"							
1037K	22 GA CHROME PLATED	00674 9	BAG	4.2 lbs.	10		
1037RBK	22 GA ROUGH BRASS	01639 7	BAG	4 lbs.	10		
DOUBLE OFFSET - 1 1/2" X 1 1/2"							
1038K	22 GA CHROME PLATED	00673 2	BAG	5.2 lbs.	10		
1038RBK	22 GA ROUGH BRASS	01640 3	BAG	5 lbs.	10		
SLIP JOINT ELBOWS WITH NUTS AND WASHERS - 1 1/4"							
900K	22GA 4" CHROME	01745 5	BAG	2 lbs.	5		
901K	22GA 6" CHROME	01747 9	BAG	2 lbs.	5		
903LK	22GA 12" CHROME	01752 3	BAG	3 lbs.	5		
ALL STAINLESS STEEL STRAINER							
LOCKING SHELL FOR 3 1/2" DIAMETER HOLE- NEOPRENE STOPPER							
1440SSBNK	BUFFED RIM - LOCKING SHELL - BRASS NUT - MADE IN THE U.S.A. FIXED STICK POST - DEEP CUP LOCKING SHELL	01786 8	BOX	15 lbs.	15		
STRAINER - REPLACEMENT PART							
20831K	REPLACEMENT BASKET FOR 83SSABS	01390 7	BAG	2 lbs.	25		
REPAIR COUPLINGS WITH NUTS AND WASHERS - 1 1/4" X 1 1/4"							
669K	STRAIGHT 22 GA CHROME PLATED	00672 5	BAG	1.1 lb.	5		
671K	45° 22 GA CHROME PLATED	00625 1	BAG	1.45 lbs.	5		
673K	90° 22 GA CHROME PLATED	00593 3	BAG	1.55 lbs.	5		
REPAIR COUPLINGS WITH NUTS AND WASHERS - 1 1/2" X 1 1/2"							
670K	STRAIGHT 22 GA CHROME PLATED	00595 7	BAG	1.5 lbs.	5		
672K	45° 22 GA CHROME PLATED	00592 6	BAG	1.7 lbs.	5		
674K	90° 22 GA CHROME PLATED	00594 0	BAG	1.8 lbs.	5		
WASTE CONNECTIONS - 1 1/2"							
1189RBK	MALE 1 1/2" SPS X 1 1/2" O.D. ROUGH BRASS	00632 9	BAG	3.5 lbs.	5		
WASTE CONNECTIONS - 1 1/2" X 1 1/4"							
1187RBK	MALE 1 1/2" SPS X 1 1/4" O.D. ROUGH BRASS	00631 2	BAG	3.5 lbs.	5		
1193RBK	FEMALE 1 1/2" SPS X 1 1/4" O.D. ROUGH BRASS	00633 6	BAG	3.5 lbs.	5		
SLIP JOINT DIE CAST NUTS WITH WASHERS							
915DK	1 1/4" X 1 1/4" CHROME PLATED	00582 7	BAG	1.5 lbs.	25		
915K	1 1/4" X 1 1/4" CAST BRASS CHROME PLATED	01769 1	BAG	5 lbs.	25		
916DK	1 1/2" X 1 1/4" CHROME PLATED	00584 1	BAG	2.05 lbs.	25		
917DK	1 1/2" X 1 3/8" CHROME PLATED	01408 9	BAG	3 lbs.	25		
918DK	1 1/2" X 1 1/2" CHROME PLATED	00583 4	BAG	4.55 lbs.	25		
919DK	2" X 2" CHROME PLATED	01411 9	BAG	1 lb.	10		





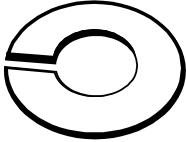
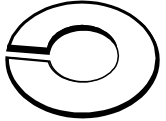
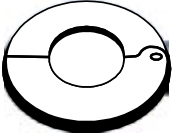
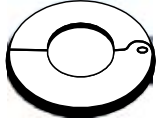
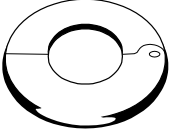
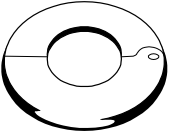

Part Num.	Item Description	UPC# 046224 +	Pkg	Ctn Wt	Ctn Qty	List Price	Line Art
SLIP JOINT CAST BRASS NUTS WITH WASHERS							
915RBK	1 1/4" X 1 1/4" CHROME PLATED	01406 5	BAG	3 lbs.	25		
916RBK	1 1/2" X 1 1/4" ROUGH BRASS	01407 2	BAG	3 lbs.	25		
918K	1 1/2" X 1 1/2" CHROME PLATED	01409 6	BAG	3 lbs.	25		
918RBK	1 1/2" X 1 1/2" ROUGH BRASS	01410 2	BAG	3 lbs.	25		
919RBK	2" X 2" ROUGH BRASS	01413 3	BAG	3 lbs.	25		
COVER NUT							
913DK	1 1/2" BRASS	01754 7	BAG	1 lb.	10		
RUBBER SLIP JOINT WASHERS							
50915K	1 1/4" TPR WASHER	00545 2	BAG	.40 lb.	25		
50918K	1 1/2" TPR WASHER	00546 9	BAG	.45 lb.	25		
501765K	1 1/2" X 1 1/4"	00613 8	BAG	.75 lb.	25		
SINK STRAINER WASHER							
85560K	SINK STRAINER WASHER - 1 3/4" O.D. X 1 3/8" ID	00623 7	BAG	.45 lb.	25		
RUBBER SLIP JOINT WASHER							
25513K	(2) 1 1/2", (2) 1 1/4", (2) 2"	00547 6	BAG	.90 lb.	25		
85522K	SLIP JOINT WASHERS SQUARE CUT - 1 1/2"	00622 0	BAG	.40 lb.	25		
BASIN GASKET							
1811K	MACK WASHER 1 1/4" FOR PO & CO PLUGS	00589 6	BAG	.60 lb.	15		
FAUCET HOLE COVER							
935K	1 3/4" DIAMETER X 1 3/4" LONG	01414 0	BAG	3 lbs.	25		
937K	2" O.D. POLISHED CHROME	01415 7	BAG	3 lbs.	25		

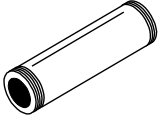

CONVENIENCE CENTER

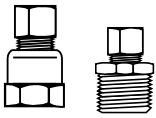
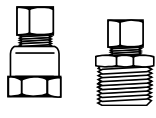
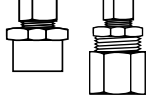
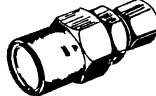
Part Num.	Item Description	UPC# 046224 +	Pkg	Ctn Wt	Ctn Qty	List Price	Line Art
FLANGES - SURE GRIP - SHALLOW - WHITE PLASTIC - IPS							
K20300	1/2" I.P.S.	01792 9	BAG	1 lb.	25		
K20882	3/4" I.P.S.	01813 1	BAG	1 lb.	5		
292WK	1 1/2" IPS	00468 4	BAG	1.3 lbs.	25		
20871K	2" IPS	00462 2	BAG	1.35 lbs.	25		
FLANGES - SURE GRIP - SHALLOW - WHITE PLASTIC - COPPER							
K21136	3/8"	01964 0	BAG	1 lb.	5		
K20884	1/2"	01793 6	BAG	1 lb.	25		
K20301	3/4"	01795 0	BAG	1 lb.	5		
FLANGES - SURE GRIP SHALLOW - METAL - IPS							
K20290	3/8" - CHROME	01790 5	BAG	1 lb.	25		
851K	1/2" - CHROME	01392 1	BAG	1 lb.	25		
882K	3/4" - CHROME	01405 8	BAG	1 lb.	25		
855K	1 1/4" - CHROME	01393 8	BAG	3 lbs.	25		
856K	1 1/2" - CHROME	00644 2	BAG	.30 lb.	10		
856PBK	1 1/2" - POLISHED BRASS	01394 5	BAG	3 lbs.	25		
873K	2" - CHROME	01404 1	BAG	1 lb.	25		
FLANGES - SURE GRIP - SHALLOW - METAL - O.D.							
852K	1 1/4" O.D. - CHROME	00626 8	BAG	.45 lbs.	10		
853K	1 1/2" O.D. - CHROME	00629 9	BAG	.45 lbs.	10		
FLANGES - SURE GRIP - SHALLOW - METAL - COPPER							
K20288	1/2" - CHROME	01794 3	BAG	1 lb.	10		
K20289	3/4" - CHROME	01796 7	BAG	1 lb.	10		
FLANGES - SURE GRIP - DEEP - METAL - IPS							
860K	3/8" - CHROME	01395 2	BAG	3 lbs.	25		
861K	1/2" - CHROME	01396 9	BAG	1 lb.	25		
FLANGES - SURE GRIP DEEP - O.D.							
871K	3/8" - CHROME	01403 4	BAG	3 lbs.	25		
863K	1/2" - CHROME	01397 6	BAG	3 lbs.	25		
858K	1 1/4" - CHROME	00646 6	BAG	.90 lb.	10		
859K	1 1/2" - CHROME	00647 3	BAG	.75 lb.	10		
FLANGES - SURE GRIP - METAL - BOX - IPS							
868K	1/2" - CHROME	01402 7	BAG	1 lb.	10		
FLANGES - SURE GRIP - METAL - BOX - O.D.							
866K	1 1/4" - CHROME	01398 3	BAG	1 lb.	10		
867K	1 1/2" - CHROME	01399 0	BAG	1 lb.	10		

Part Num.	Item Description	UPC# 046224 +	Pkg	Ctn Wt	Ctn Qty	List Price	Line Art
FLOOR & CEILING PLATES - PLASTIC - CHROME PLATED - ONE PIECE - SPLIT - IPS							
K20113	1/2"	20113 7	BAG	1 lb.	25		
K21135	3/4" - POLISHED CHROME	21135 8	BAG	1 lb.	10		
K21131	1"	21131 0	BAG	1 lb.	5		
21112K	1 1/2"	00605 3	BAG	1.15 lbs.	12		
21102K	2"	00606 0	BAG	1.3 lbs.	12		
FLOOR & CEILING PLATES - PLASTIC - CHROME PLATED - ONE PIECE - SPLIT - COPPER							
K20112	1/2"	01804 9	BAG	1 lb.	25		
K21134	3/4" - CHROME	21134 1	BAG	1 lb.	25		
K21110	1"	21110 5	BAG	1 lb.	5		
FLOOR AND CEILING PLATES - METAL - SURE GRIP - IPS							
K25702	3/8" - CHROME	01801 8	BAG	1 lb.	25		
K25701	1/2" - CHROME	01802 5	BAG	1 lb.	25		
K25703	3/4" - CHROME	01803 2	BAG	1 lb.	10		
22114K	1 1/4" - CHROME	01373 0	BAG	1 lb.	10		
22112K	1 1/2" - CHROME	01372 3	BAG	1 lb.	5		
21022K	2" - CHROME	01378 5	BAG	2 lb.	10		
FLOOR & CEILING PLATES - METAL - SURE GRIP - COPPER							
25114K	1 1/4" - CHROME	01387 7	BAG	1 lb.	10		
25112K	1 1/2" - CHROME	01386 0	BAG	1 lb.	10		
FLOOR & CEILING PLATES - METAL - SPRING LOADED - IPS							
20238K	3/8" - CHROME	01382 2	BAG	1 lb.	25		
20212K	1/2" - CHROME	01374 7	BAG	1 lb.	25		
20234K	3/4" - CHROME	01381 5	BAG	2 lbs.	25		
21021K	1" - CHROME	01371 6	BAG	2 lbs.	25		
22212K	2 1/2" - CHROME	01379 2	BAG	1 lb.	5		
21023K	3" - CHROME	01380 8	BAG	1 lb.	5		
20204K	4" - CHROME	01383 9	BAG	5 lbs.	25		
FLOOR & CEILING PLATES - METAL - SPRING LOADED - COPPER							
20512K	1/2" - CHROME	01388 4	BAG	1 lb.	25		
20534K	3/4" - CHROME	01389 1	BAG	1 lb.	25		
20501K	1" - CHROME	01384 6	BAG	2 lbs.	25		
20502K	2" - CHROME	01385 3	BAG	3 lbs.	25		

CONVENIENCE CENTER

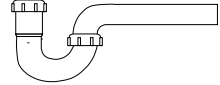
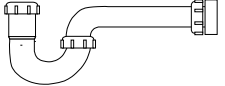
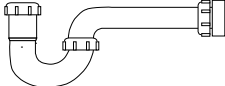
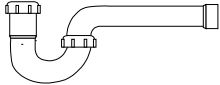
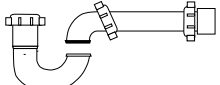
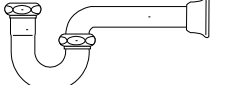
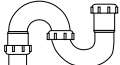

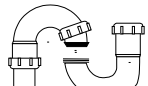
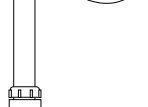
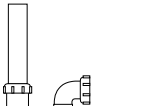
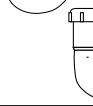
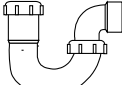
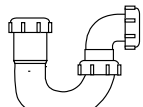
Part Num.	Item Description	UPC# 046224 +	Pkg	Ctn Wt	Ctn Qty	List Price	Line Art
NIPPLES							
K23310	3/8" I.P.S. X 3"	01797 4	BAG	1 lb.	5		
K23340	1/2" I.P.S. X 4"	01798 1	BAG	3 lbs.	10		
PIPE INSERTS							
K25525	1/4" O.D. PLASTIC	01816 2	BAG	1 lb.	5		
K25526	3/8" O.D. PLASTIC	01815 5	BAG	1 lb.	5		
STRAIGHT CONNECTORS							
K20071	3/8" F.I.P. X 3/8" O.D.	01821 6	BAG	1 lb.	5		
K20072	3/8" M.I.P. X 3/8" O.D.	01825 4	BAG	1 lb.	5		
K20073	1/2" F.I.P. X 3/8" O.D.	01799 8	BAG	1 lb.	10		
K20074	1/2" M.I.P. X 3/8" O.D.	01800 1	BAG	1 lb.	10		
K20079	1/2" SWEAT X 3/8" O.D.	01811 7	BAG	1 lb.	5		
K20080	1/2" NOM. COP 3/8" O.D.	01824 7	BAG	1 lb.	5		
STRAIGHT TRANSITION FITTING							
K23210	1/2" NOM.. CPVC X 3/8" O.D.	01817 9	BAG	1 lb.	5		
COMPRESSION NUTS WITH RINGS							
K20081	3/8" O.D. 2 RINGS AND 2 NUTS	01812 4	BAG	1 lb.	25		
COMPRESSION NUT KIT							
K20085	2- 7/16" - 1/2" WASHERS AND NUTS 2- 7/16" RINGS AND 2- 1/2" RINGS	01823 0	BAG	1 lb.	5		
CONE WASHERS							
K281033	CONE WASHER & RINGS 1/2" ID 3/4" O.D.	01820 9	BAG	1 lb.	5		
K281031	CONE WASHER & RINGS 3/8" ID 23/32" O.D.	01818 6	BAG	4 lb.	10		
K218136	CONE WASHER & RINGS 3/8" ID 23/32" O.D.	018094	BAG	1 lb.	15		
K218137	CONE WASHER & RING 1/2" ID	01810 0	BAG	1 lb.	5		

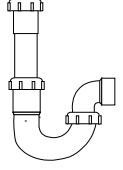
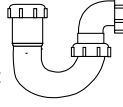
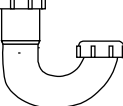
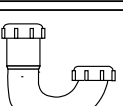
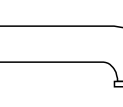
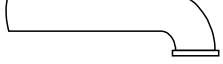
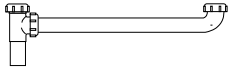
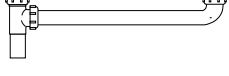
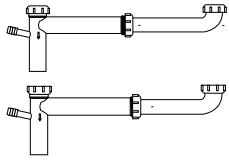
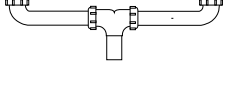
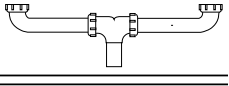
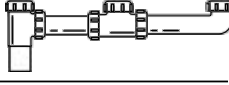
Part Num.	Item Description	UPC# 046224 +	Pkg	Ctn Wt	Ctn Qty	List Price	Line Art
P TRAPS - 1 1/4"							
200WK	1 1/4" WHITE	00460 8	BAG	7.5 lbs.	25		
P TRAPS - 1 1/2" - LESS MARVEL CONNECTOR							
400WK	1 1/2" X 1 1/2" OR 1 1/2" X 1 1/4" WHITE	00474 5	BAG	8.3 lbs.	25		
400BK	1 1/2" X 1 1/2" OR 1 1/2" X 1 1/4" BLACK	00529 2	BAG	8.85 lbs.	25		
P TRAPS - 1 1/2" - WITH MARVEL CONNECTOR AND NUTS							
400TTWK	1 1/2" WHITE - BAGGED	01777 6	BAG	13 lbs.	25		
400TTBK	1 1/2" BLACK - BAGGED	01773 8	BAG	13 lbs.	25		
P TRAPS - 1 1/2" - SOLVENT WELD CONNECTOR							
400SWK	1 1/2" X 1 1/2" OR 1 1/2" X 1 1/4" WHITE	00658 9	BAG	8.75 lbs.	25		
PROFESSIONAL GRADE P TRAP - 1 1/2" WITH INDUSTRY EXCLUSIVE DURABOND SEAL							
400PVCK	1 1/2" PVC WHITE WITH MARVEL CONNECTOR AND NUTS	00764 7	BAG	6.72 lbs.	10		
P TRAPS - LESS CLEANOUT - 1 1/2" X 1 1/2"							
400CPDFK	1 1/2" PVC CHROME PLATED - DEEP FLANGE	02083 7	BOX	8 lbs.	10		
S TRAP - 1 1/4"							
270WK	1 1/4" X 20 1/2" WHITE	00519 3	BAG	11.55 lbs.	20		
S TRAPS - 1 1/2"							
700WK	1 1/2" OR 1 1/4" X 1 1/2" WHITE	00518 6	BAG	9.3 lbs.	15		
PROFESSIONAL GRADE S TRAP - 1 1/2" WITH INDUSTRY EXCLUSIVE DURABOND SEAL							
700PVCK	1 1/2" MARVEL CONNECTOR - WHITE	00765 5	BOX	2.73 lbs.	3		
701PVCK	1 1/2" PVC ONE PIECE FLOOR TUBE MARVEL CONNECTOR	01771 4	BOX	3 lbs.	3		
701PVCruk	1 1/2" PVC ONE PIECE FLOOR TUBE MARVEL CONNECTOR - TPR WASHER	01950 3	BAG	3 lbs.	3		
WASHING MACHINE TRAPS - 1 1/2"							
801K	1 1/2" X 20 1/2" WHITE - IPS	00498 1	BAG	3 lbs.	5		
MASTERTRAP SINK TRAPS - 1 1/2"							
500K	1 1/2" PVC SOLVENT WELD	00484 4	BAG	3.2 lbs.	10		
MASTERTRAP SINK TRAPS - 1 1/2"							
501WK	1 1/2" WHITE - IPS	00485 1	BAG	1.95 lbs.	5		





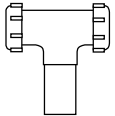

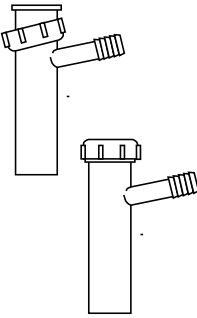
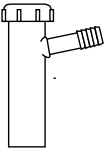
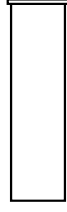
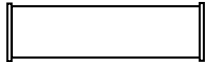
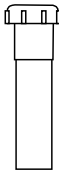

Part Num.	Item Description	UPC# 046224 +	Pkg	Ctn Wt	Ctn Qty	List Price	Line Art
MASTERTRAP SINK TRAPS - WITH SLIP JOINT EXTENSION TUBE							
549W2K	1 1/4" X 6" WHITE	00671 8	BAG	5 lbs.	10		
549WRUK	1 1/4" X 6" WHITE FOR SCH. 40 - TPR WASHER	01945 9	BAG	5 lbs.	10		
546W2K	1 1/2" X 6" WHITE	00660 2	BAG	5 lbs.	10		
546WRUK	1 1/2" X 6" WHITE - TPR WASHER	01944 2	BAG	5 lbs.	10		
MASTERTRAP REPAIR TRAP - 1 1/2"							
600K	1 1/2" WHITE WITH SLIP JOINT CONNECTION ELBOW	00494 3	BAG	1.85 lbs.	5		
J BENDS - 1 1/4"							
10200WK	1 1/4" X 1 1/4" WHITE	00446 2	BAG	2.05 lbs.	10		
J BENDS - 1 1/2"							
10400WK	1 1/2" OR 1 1/4" X 1 1/2" WHITE	00447 9	BAG	2.4 lbs.	10		
SINK TRAP J BEND - 1 1/2"							
10501WK	1 1/2" OR 1 1/4" 1 1/2"	00449 3	BAG	2.2 lbs.	10		
WALL TUBE							
30200WK	1 1/4" X 7	00469 1	BULK	.95 lbs.	5		
30400WK	1 1/2" X 7	00470 7	BULK	1.65 lbs.	10		
END OUTLET CONTINUOUS WASTES WITH BAFFLE TEE							
125-16WK	1 1/2" X 16" WHITE SLIP JOINT	00455 4	BAG	8.65 lbs.	15		
125-16WRUK	1 1/2" X 16" WHITE SLIP JOINT - TPR WASHERS	01953 4	BAG	9 lbs.	15		
125-21WK	1 1/2" X 21" WHITE SLIP JOINT	01778 3	BAG	4 lbs.	5		
END OUTLET CONTINUOUS WASTES WITH BAFFLE TEE - DIRECT CONNECT							
125A-16WK	1 1/2" X 16" WHITE	00536 0	BAG	7.5 lbs.	15		
125A-16WRUK	1 1/2" X 16" WITH TPR WASHERS	02203 9	BOX	9 lbs.	15		
TELESCOPING END OUTLET CONTINUOUS WASTES WITH 3/4" BRANCH TAILPIECE							
119WK	1 1/2" WHITE SLIP JOINT	00453 0	BAG	5.75 lbs.	10		
119AWK	1 1/2" WHITE DIRECT CONNECT	00452 3	BAG	5.85 lbs.	10		
CENTER OUTLET CONTINUOUS WASTES WITH BAFFLE TEE							
130-16WK	1 1/2" X 16" WHITE SLIP JOINT	00457 8	BAG	9.05 lbs.	15		
130-21WK	1 1/2" X 16" WHITE SLIP JOINT	01783 7	BAG	12 lbs.	15		
CENTER OUTLET CONTINUOUS WASTES WITH BAFFLE TEE - DIRECT CONNECT							
130A-16WK	1 1/2" X 16" WHITE	00539 1	BAG	11.55 lbs.	15		
TRIPLE BOWL CONTINUOUS WASTE - SLIP JOINT							
141WK	1 1/2" X 25" END OUTLET	00459 2	BAG	13.9 lbs.	15		

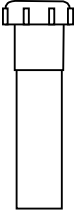
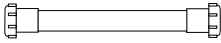
CONVENIENCE CENTER

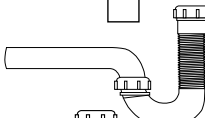
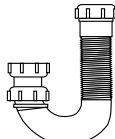



Part Num.	Item Description	UPC# 046224 +	Pkg	Ctn Wt	Ctn Qty	List Price	Line Art
MASTERWASTES - 1 1/2" - TPR WASHERS							
120WRUK	1 1/2" END OUTLET CONTINUOUS WASTE SLIP JOINT OR DIRECT CONNECT - ADJ. TEE	02113 1	BOX	6 lbs.	10		
127TTWRUK	1 1/2" WHITE - ADJ. WASTE WITH 1/2" BRANCH HI-WAY INSERT - TPR WASHERS	02112 4	BAG	2 lbs.	5		
122TTWK	1 1/2" X 16" SLIP JOINT OR DIRECT CONNECT	02216 9	BAG	8 lbs.	15		
122TTWRUK	1 1/2" X 16" SLIP JOINT OR DIRECT CONNECT TPR WASHERS	02103 2	BAG	10 lbs.	15		
222WRUK	1 1/2" X 16" CENTER OUTLET CONTINUOUS WASTE SLIP JOINT OR DIRECT CONNECT	02115 5	BOX	10 lbs.	15		
222TTWRUK	1 1/2" X 16" CENTER OUTLET CONTINUOUS WASTE SLIP JOINT OR DIRECT CONNECT	02104 9	BAG	10 lbs.	15		
222TTWK	1 1/2" X 16" CENTER OUTLET CONTINUOUS WASTE SLIP JOINT OR DIRECT CONNECT - WITH BAFFLE	02215 2	BAG	9 lbs.	15		
222-21WRUK	1 1/2" X 16" WHITE SLIP JOINT OR DIRECT CONNECT - TPR WASHERS	01968 8	BAG	13 lbs.	15		
ADJUSTABLE DISPOSER KITS - DIRECT CONNECTION - 10"-15" FOR IN-SINK-ERATOR							
335WK	1 1/2" WHITE TELESCOPIC ADJUSTABLE	00656 5	BAG	5.2 lbs.	10		
335BK	1 1/2" BLACK TELESCOPIC ADJUSTABLE	00655 8	BAG	5.1 lbs.	10		
MASTERKIT DISPOSER KITS - END OUTLET							
334WK	1 1/2" WHITE LESS P-TRAP	00654 1	BAG	5.9 lbs.	10		
334WRUK	1 1/2" WHITE LESS P-TRAP - TPR WASHERS	01927 5	BAG	6 lbs.	10		
334WRUBXK	1 1/2" WHITE LESS P-TRAP - TPR WASHERS	02114 8	BOX	9 lbs.	15		
334BK	1 1/2" BLACK LESS P-TRAP	00653 4	BAG	5.9 lbs.	10		
WASTE ARMS - 1 1/2" - DIRECT CONNECTION							
104AWK	1 1/2" X 15" WHITE	00535 3	BULK	3.6 lbs.	10		
104ABK	1 1/2" X 15" BLACK	00534 6	BULK	3.2 lbs.	10		
WASTE ARMS - 1 1/2" - SLIP JOINT							
104WK	1 1/2" X 15" WHITE	00448 6	BAG	3.55 lbs.	10		
104BK	1 1/2" X 15" BLACK	00521 6	BAG	3.25 lbs.	10		
106WK	1 1/2" X 24" WHITE	01641 0	BULK	2 lbs.	5		
END OUTLET TEE AND TAILPIECE WITH BAFFLE							
124WK	1 1/2" SLIP JOINT OR DIRECT CONNECT	02217 6	BAG	2 lbs.	10		
125AWK	1 1/2" WHITE DIRECT CONNECT	00538 4	BAG	2.4 lbs.	10		
125ABK	1 1/2" BLACK DIRECT CONNECT	00537 7	BAG	2.4 lbs.	10		
125WK	1 1/2" WHITE SLIP JOINT CONNECT	00456 1	BAG	2.55 Lbs.	10		
125BK	1 1/2" BLACK SLIP JOINT CONNECT	00523 0	BAG	2.65 Lbs.	10		



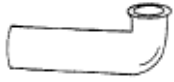
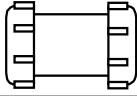
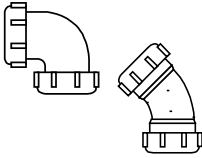
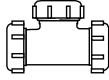
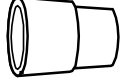
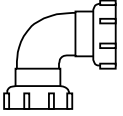
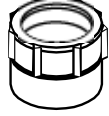

Part Num.	Item Description	UPC# 046224 +	Pkg	Ctn Wt	Ctn Qty	List Price	Line Art
CENTER OUTLET TEE AND TAILPIECE							
130WK	1 1/2" WHITE SLIP JOINT CONNECTION	00458 5	BAG	1 lb.	5		
130BK	1 1/2" BLACK SLIP JOINT CONNECTION	00524 7	BAG	1.15 lb.	5		
HIGHWAY INSERT TAILPIECE - FLANGED							
15K	1 1/2" X 1" - PLASTIC	01962 6	BAG	2 lbs.	20		
DISHWASHER BRANCH TAILPIECE - 1 1/2" X 8"							
30-8WK	WHITE DIRECT CONNECT 3/4" BRANCH TAILPIECE (7/8" O.D.)	00526 1	BAG	.85 lbs.	5		
30-8WRUK	WHITE DIRECT CONNECT 3/4" BR. TAILPIECE (7/8" O.D.) - TPR WASHER	01952 7	BAG	1 lb.	5		
31-8WK	WHITE DIRECT CONNECT (5/8" O.D.)	00652 7	BAG	.80 lb.	5		
31-8WRUK	WHITE DIRECT CONNECT (5/8" O.D.) TPR WASHER	01951 0	BAG	1 lb.	5		
31-8BK	BLACK DIRECT CONNECT (5/8" O.D.)	00649 7	BAG	.80 lb.	5		
33-8WK	WHITE SLIP JOINT CONNECT (5/8" O.D.)	00657 2	BAG	.75 lb.	5		
DISHWASHER BRANCH TAILPIECE - 1 1/2"							
32-8WK	1 1/2" X 8" WHITE DIRECT CONNECT OR SLIP JOINT - WITH 7/8" O.D. BRANCH	00472 1	BAG	5.6 lbs.	25		
35-8WK	1 1/2" X 8" WHITE DIRECT CONNECT OR SLIP JOINT - WITH 5/8" O.D. BRANCH	00219 0	BAG	1 lb.	5		
SINK TAILPIECES - 1 1/2"							
10-4WRUK	4" WHITE - TPR WASHER	01957 2	BAG	2 lbs.	25		
10-6WK	6" WHITE	00450 9	BULK	2.95 lbs.	25		
10-6WRUK	6" WHITE - TPR WASHER	01956 5	BAG	3 lbs.	25		
10-6BK	6" BLACK	00522 3	BULK	2.5 lbs.	25		
10-8WRUK	8" WHITE - TPR WASHER	01955 8	BAG	1 lb.	5		
10-12WK	12" WHITE	00445 5	BULK	4.65 lbs.	25		
10-12BK	12" BLACK	00520 9	BULK	4.65 lbs.	25		
SINK TAILPIECES - 1 1/2" - DOUBLE FLANGED							
11-16WK	16" WHITE	00451 6	BULK	2.65 lbs.	10		
11-16WRUK	16" WHITE - TPR WASHER	01954 1	BAG	3 lbs.	10		
11-16BK	16" BLACK	00648 0	BULK	3.1 lbs.	10		
EXTENSION TUBES - 1 1/4" - SLIP JOINT							
42-6WK	6" WHITE	00479 0	BAG	2.9 lbs.	25		
42-12WK	12" WHITE	00478 3	BAG	4.6 lbs.	25		

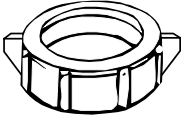
CONVENIENCE CENTER

Part Num.	Item Description	UPC# 046224 +	Pkg	Ctn Wt	Ctn Qty	List Price	Line Art
EXTENSION TUBES - 1 1/2" - SLIP JOINT							
40-6WK	6" WHITE	00476 9	BAG	3.3 lbs.	25		
40-6BK	6" BLACK	00531 5	BAG	2.65 lbs.	25		
40-8WRUK	8" WHITE - TPR WASHER	01928 2	BAG	4 lb.	25		
40-12WK	12" WHITE	00475 2	BAG	5.45 lbs.	25		
40-12WRUK	12" WHITE - TPR WASHER	01937 4	BAG	5 lbs.	25		
40-12BK	12" BLACK	00530 8	BAG	5.6 lbs.	25		
EXTENSION TUBES - 1 1/2" - DOUBLE END - SLIP JOINT							
41-16WK	16" WHITE	00477 6	BAG	3.45 lbs.	10		
41-16WRUK	16" WHITE - TPR WASHER	01939 8	BAG	3 lbs.	10		
41-16BK	16" BLACK	00659 6	BAG	2.9 lbs.	10		
EXTENSION TUBES - 1 1/2" - SOLVENT WELD							
20-6WK	6" PVC	00463 9	BAG	.95 lbs.	5		
20-12WK	12" PVC	00461 5	BAG	1.55 lbs.	5		
P TRAP FLEX 'N FIX							
81240K	P TRAP FLEX & FIX 1 1/2"	00499 8	BAG	1.9 lbs.	5		
J BEND FLEX 'N FIX							
91250K	FLEX/FIX 1 1/2" OR 1 1/4"	00512 4	BAG	1.2 lbs.	5		
SINK TAILPIECE FLEX 'N FIX							
9121K	FLEX/FIX DIRECT CONNECT 1 1/2" X 12"	00510 0	BAG	1.9 lbs.	10		
DOUBLE SLIP COUPLING FLEX 'N FIX							
91215K	DOUBLE SLIP JOINT COUPLING FLEX/FIX 1 1/2" X 1 1/2"	00509 4	BAG	1.8 lbs.	10		
EXTENSION TUBE FLEX 'N FIX - SLIP JOINT							
9125K	1 1/4" X 9"	00513 1	BAG	3.2 lbs.	25		
9126K	1 1/2" X 12"	00514 8	BAG	2.2 lbs.	10		
DISHWASHER AIR GAP							
85570K	DISHWASHER AIR GAP	00508 7	BAG	5.1 lbs.	25		
DISHWASHER/DISPOSAL CONNECTOR							
85575K	DISHWASHER/DISPOSAL CONNECTOR	00548 3	BAG	2 lbs.	10		
DISPOSER GASKET WITH FRICTION RING							
25576K	FOR WASTE KING	00466 0	BAG	.50 lbs.	15		

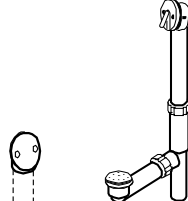
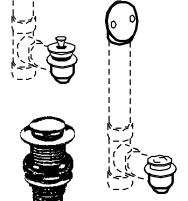
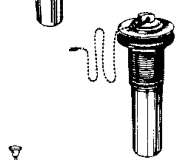
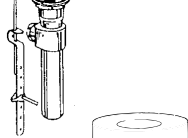
CONVENIENCE CENTER

Part Num.	Item Description	UPC# 046224 +	Pkg	Ctn Wt	Ctn Qty	List Price	Line Art
TAILPIECE - IN-SINK-ERATOR - 1 1/2"							
85580K	IN-SINK-ERATOR TAILPIECE PVC	00533 9	BAG	1.3 lbs.	5		
DISPOSAL ELBOW - 1 1/2"							
341B8K	DISPOSAL ELBOW FOR IN-SINK-ERATOR BLACK	00527 8	BAG	.55 lbs.	5		
341W9K	DISPOSAL ELBOW FOR IN-SINK-ERATOR WHITE	00473 8	BAG	.55 lbs.	5		
342B8K	DISPOSAL ELBOW FOR WASTE KING BLACK	00528 5	BAG	.62 lbs.	5		
EXTENSION COUPLING - 1 1/2" - SLIP JOINT							
46WK	1 1/2" WHITE STRAIGHT WITH 1 1/2" & 1 1/4" POLYWASHERS	00480 6	BAG	1.8 lbs.	10		
DOUBLE SLIP ELBOW - 1 1/2"							
47WK	1 1/2" X 1 1/2" 90° WHITE	00481 3	BAG	1.95 lbs.	10		
49PVCK	1 1/2" X 1 1/2" 45° WHITE	00768 5	BAG	1 lb.	5		
3-WAY SLIP TEE - 1 1/2"							
48WK	1 1/2" WHITE	00482 0	BAG	1.35 lbs.	5		
REDUCER COUPLING							
28WK	SLIP JOINT 1 1/2" X 1 1/4"	00467 7	BAG	.65 lb.	5		
ELBOW							
30501WK	90° 1 1/2" IPS THREAD	00471 4	BAG	1.05 lbs.	5		
MARVEL CONNECTOR							
95K	CONNECTOR 1 1/2" COMP X 1 1/2"	00516 2	BAG	2.2 lbs.	20		
CONNECTOR - SOLVENT WELD							
99K	1 1/2" X 1 1/2"	02220 6	BAG	1 lb.	5		
SLIP JOINT NUTS AND WASHERS							
56WK	1 1/4" X 1 1/4" WHITE WING NUT	00491 2	BAG	.95 lb.	25		
56-5WK	1 1/4" X 1 1/4" WHITE WING NUT CONTRACTORS PAK (5)	00490 5	BAG	.80 lb.	5		
55WK	1 1/2" X 1 1/2" WHITE	00489 9	BAG	.85 lb.	25		
55-5WK	1 1/2" X 1 1/2" WHITE CONTRACTORS PAK (5)	00488 2	BAG	3.7 lbs.	25		
TAILPIECE WASHER							
50879K	1 1/2"	00487 5	BAG	.25 lb.	25		
50879-5K	1 1/2" - CONTRACTORS PAK (5)	00486 8	BAG	.70 lb.	25		

Part Num.	Item Description	UPC# 046224 +	Pkg	Ctn Wt	Ctn Qty	List Price	Line Art
POLYWASHERS							
57WK	1 1/4" X 1 1/4" BEVELED POLYWASHER	00493 6	BAG	.35 lb.	25		
57-5WK	1 1/4" X 1 1/4" BEVELED POLYWASHER CONTRACTORS PAK (5)	00492 9	BAG	.65 lb.	25		
65K	1 1/2" X 1 1/2" BEVELED POLYWASHER	00496 7	BAG	.55 lb.	25		
65-5K	1 1/2" X 1 1/2" BEVELED POLYWASHER CONTRACTORS PAK (5)	00495 0	BAG	.80 lb.	25		
965K	1 1/2" X 1 1/4" BEVELED POLYWASHER	00517 9	BAG	.50 lbs.	25		
TRIPLEVER BATH DRAIN							
64WK	TRIPLEVER STYLE WITH DOME STRAINER	00464 6	BAG	11.9 lbs.	10		
SCH. 40 - BRASS LIFT 'N TURN HALF PAK LESS PIPE & TEE							
621PVCK	1 1/2" SCH 40 PVC POLISHED CHROME	01770 7	BOX	6 lbs.	5		
SCH. 40 - FOOT LOK STOP™ HALF PAK LESS PIPE & TEE							
631PVCK	1 1/2" SCH 40 PVC POLISHED CHROME	01768 4	BOX	6 lbs.	5		
PO PLUG - 1 1/2" WITH STAINLESS STEEL RIM							
76K	1 PIECE 5" LIFT/LOCK	00497 4	BAG	2.35 lbs.	10		
TRAY PLUG WITH STAINLESS STEEL RIM							
81K	PLASTIC WITH RUBBER STOPPER FOR 2" TO 2 1/2" OPENINGS	00504 9	BAG	1.3 lbs.	5		
POP UP ASSEMBLY COMPLETE WITH LIFT ROD PLUNGER & LINKAGE							
22070K	1 1/4" - CHROME PLATED	00465 3	BAG	5.3 lbs.	10		
82070PBK	1 1/4" - POLISHED BRASS	00505 6	BAG	5.35 lbs.	10		
812-70K	FLEX & FIX 1 1/4" - CHROME PLATED	00502 5	BAG	12.35 lbs.	20		
STUDOR MINIVENT							
82678K	STUDOR MINIVENT AIR ADMITTANCE	00506 3	BAG	2.65 lbs.	5		
MECHANICAL PLUMBING VENT							
85536K	MECHANICAL PLUMBING VENT 1/2" O.D. CONNECTION CHROME PLATED	00532 2	BAG	1.41 lbs.	5		
85539K	MECHANICAL PLUMBING VENT 1 1/2" O.D. - BLACK	00507 0	BAG	1.25 lbs.	10		

CONVENIENCE CENTER

Part Num. Item Description UPC# 046224 + Ctn Qty Ctn Wt Line Art





INTERLOCK HANDLEBAR™ SYSTEM

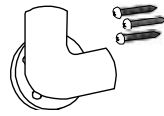

Custom build A Safety Grab Bar System!

- AHMA Recognized Award Winning Packaging!
- Made in the U.S.A.
- 3 Colors; White, Almond, Black

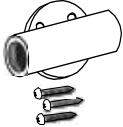

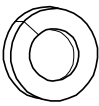
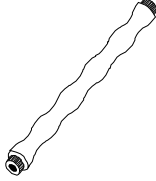
Part Num.	Item Description	UPC# 046224 +	Ctn Qty	Ctn Wt	Line Art
"A" 90° CORNER CONNECTION					
PP19904	"A" 90° CORNER CONNECTION, WHITE	19904 5	6	2.25 lbs.	
PP19914	"A" 90° CORNER CONNECTION, ALMOND	19914 4	6	2.25 lbs.	
"B" END ELBOW CONNECTION					
PP19903	"B" END ELBOW CONNECTION, WHITE	19903 8	6	2 lbs.	
PP19913	"B" END ELBOW CONNECTION, ALMOND	19913 7	6	2 lbs.	
PP19923	"B" END ELBOW CONNECTION, BLACK	19923 6	6	2 lbs.	
"C" INSIDE WALL CONNECTION					
PP19902	"C" INSIDE WALL CONNECTION, WHITE	19902 1	6	2 lbs.	
PP19912	"C" INSIDE WALL CONNECTION, ALMOND	19912 0	6	2 lbs.	
PP19922	"C" INSIDE WALL CONNECTION, BLACK	19922 9	6	2 lbs.	
"D" EXTENSION TEE					
PP19901	"D" EXTENSION TEE, WHITE	19901 4	6	2.15 lbs.	
PP19911	"D" EXTENSION TEE, ALMOND	19911 3	6	2.15 lbs.	
"E" FLANGED WALL CONNECTION					
PP19905	"E" FLANGED WALL CONNECTION, WHITE	19905 2	6	1.75 lbs.	
PP19915	"E" FLANGED WALL CONNECTION, ALMOND	19915 1	6	1.75 lbs.	
"F" COVERING FLANGE					
PP19906	"F" COVERING FLANGE, WHITE	19906 9	6	.75 lb.	
PP19916	"F" COVERING FLANGE, ALMOND	19916 8	6	.75 lb.	
PP19926	"F" COVERING FLANGE, BLACK	19926 7	6	.75 lb.	
16" INTERLOCK BAR					
PP19900	16" INTERLOCK BAR, WHITE	19900 7	6	4 lbs.	
PP19910	16" INTERLOCK BAR, ALMOND	19910 6	6	4 lbs.	
PP19920	16" INTERLOCK BAR, BLACK	19920 5	6	4 lbs.	

"INDEPENDENCE"
BATH SAFETY

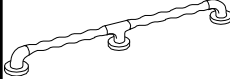
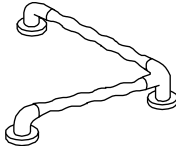

Part Num.	Item Description	UPC# 046224 +	Ctn Qty	Ctn Wt	Line Art
16" STRAIGHT INTERLOCK BAR KIT					
PP19950	16" STRAIGHT INTERLOCK BAR KIT, WHITE	19950 2	3	5.25 lbs.	
PP19951	16" STRAIGHT INTERLOCK BAR KIT, ALMOND	19951 9	3	5.25 lbs.	
PP19952	16" STRAIGHT INTERLOCK BAR KIT, BLACK	19952 6	3	5.25 lbs.	
32" STRAIGHT INTERLOCK BAR KIT					
PP19960	32" STRAIGHT INTERLOCK BAR KIT, WHITE	19960 1	3	7.25 lbs.	
PP19961	32" STRAIGHT INTERLOCK BAR KIT, ALMOND	19961 8	3	7.25 lbs.	
CORNER BAR KIT					
PP19975	CORNER BAR KIT, WHITE	19975 5	3	7.25 lbs.	
PP19976	CORNER BAR KIT, ALMOND	19976 2	3	7.25 lbs.	
INTERLOCK DISPLAYS ~ GONDOLA NOT INCLUDED					
PP19980-2	2' WHITE INTERLOCK DISPLAY ~ SHOWN BELOW & ON FRONT SIDE OF FORM #029				
PP19982-2	2' BLACK INTERLOCK DISPLAY				

"INDEPENDENCE"
BATH SAFETY

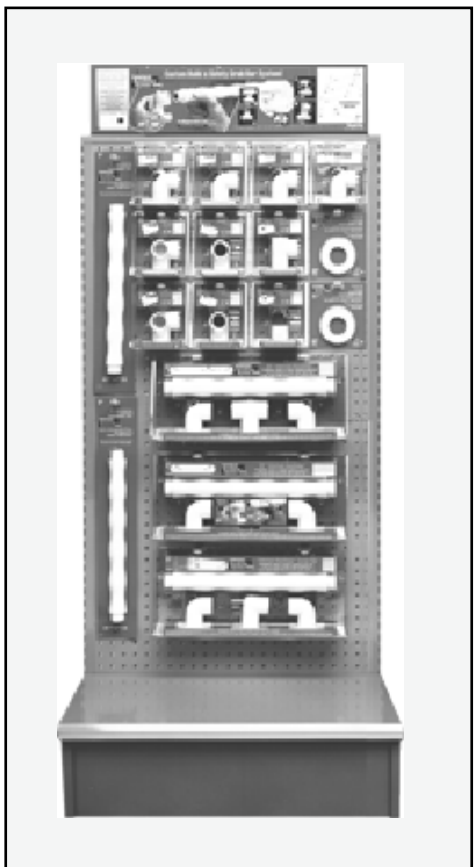

**2' "INTERLOCK"
HANDLEBAR
DISPLAY
MERCHANDISER**

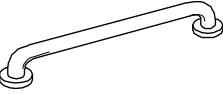
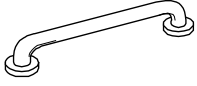
PP19980-2



Part Num.	Item Description	UPC# 046224 +	Ctn Qty	Ctn Wt	Line Art
POLISHED HANDLEBARS™ 1 1/4" WITH CONCEALED SCREWS					
PP1900	12" STRAIGHT, POLISHED CHROME	01900 8	3	3.5	
PP1901	16" STRAIGHT, POLISHED CHROME	01901 5	3	3.5	
PP1902	24" STRAIGHT, POLISHED CHROME	01902 2	3	4	
PP1903	36" CORNER, POLISHED CHROME	01903 9	2	5	
PP1920	12" STRAIGHT, POLISHED CHROME & BRASS	01920 6	3	3.5	
PP1921	16" STRAIGHT, POLISHED CHROME & BRASS	01921 3	3	3.5	
PP1922	24" STRAIGHT, POLISHED CHROME & BRASS	01922 0	3	4	
PP1923	36" CORNER, POLISHED CHROME & BRASS	01923 7	2	5	
PP1940	12" STRAIGHT, POLISHED BRASS	01940 4	3	3.5	
PP1941	16" STRAIGHT, POLISHED BRASS	01941 1	3	3.5	
PP1942	24" STRAIGHT, POLISHED BRASS	01942 8	3	4	
PP1943	36" CORNER, POLISHED BRASS	01943 5	2	5	
DECORATOR HANDLEBARS™ 1 1/4" WITH CONCEALED SCREWS					
PP2911	16", WHITE	02911 3	7	8.5	
PP2921	16", ALMOND	02921 2	7	8.5	
PP2931	16", GREY	02931 1	7	8.5	
PP2941	16", BLACK	02941 0	7	8.5	
PP2951	16", NAVY	02951 9	7	8.5	
PP2961	16", TEAL	02961 8	7	8.5	
PP2971	16", RED	02971 7	7	8.5	
PP2982	16", BISQUE	02982 3	7	8.5	
STAINLESS STEEL HANDLEBARS™ 1 1/4", 18 GAUGE, 304 STAINLESS STEEL TUBING, EXPOSED SCREWS					
PP19340	12" EXPOSED SCREWS	19340 1	1	1.1	
PP19340SG	12" EXPOSED SCREWS, WITH SAFETY GRIP	79340 3	1	1.1	
PP19341	16" EXPOSED SCREWS	19341 8	1	1.3	
PP19341SG	16" EXPOSED SCREWS, WITH SAFETY GRIP	79341 0	1	1.3	
PP19342	18" EXPOSED SCREWS	19342 5	1	1.5	
PP19342SG	18" EXPOSED SCREWS, WITH SAFETY GRIP	79342 7	1	1.5	
PP19343	24" EXPOSED SCREWS	19343 2	1	2	
PP19343SG	24" EXPOSED SCREWS, WITH SAFETY GRIP	79343 4	1	2	
PP19348	30" EXPOSED SCREWS	19348 7	1	2.2	
PP19348SG	30" EXPOSED SCREWS, WITH SAFETY GRIP	79348 9	1	2.2	
PP19344	32" EXPOSED SCREWS	19344 9	1	2.3	
PP19344SG	32" EXPOSED SCREWS, WITH SAFETY GRIP	79344 1	1	2.3	
PP19345	36" EXPOSED SCREWS	19345 6	1	2.5	
PP19345SG	36" EXPOSED SCREWS, WITH SAFETY GRIP	79345 8	1	2.5	
PP19346	42" EXPOSED SCREWS	19346 3	1	2.9	
PP19346SG	42" EXPOSED SCREWS, WITH SAFETY GRIP	79346 5	1	2.9	

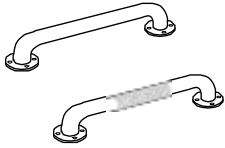

"INDEPENDENCE"
BATH SAFETY

Part Num.	Item Description	UPC# 046224 +	Ctn Qty	Ctn Wt	Line Art
STAINLESS STEEL HANDLEBARS™ 1 1/4", 18 GAUGE, 304 STAINLESS STEEL TUBING, EXPOSED SCREWS- CONTINUED					
PP19347	48" EXPOSED SCREWS	19347 0	1	3.2	
PP19347SG	48" EXPOSED SCREWS, WITH SAFETY GRIP	79347 2	1	3.2	
STAINLESS STEEL HANDLEBARS™ 1 1/4", 18 GAUGE, 304 SS TUBING, CONCEALED SCREWS					
PP19360	12" CONCEALED SCREWS	19360 9	1	1.3	
PP19360SG	12" CONCEALED SCREWS, WITH SAFETY GRIP	79360 1	1	1.3	
PP19361	16" CONCEALED SCREWS	19361 6	1	1.5	
PP19361SG	16" CONCEALED SCREWS, WITH SAFETY GRIP	79361 8	1	1.5	
PP19362	18" CONCEALED SCREWS	19362 3	1	1.7	
PP19362SG	18" CONCEALED SCREWS, WITH SAFETY GRIP	79362 5	1	1.7	
PP19363	24" CONCEALED SCREWS	19363 0	1	2.2	
PP19363SG	24" CONCEALED SCREWS, WITH SAFETY GRIP	79363 2	1	2.2	
PP19368	30" CONCEALED SCREWS	19368 5	1	2.4	
PP19368SG	30" CONCEALED SCREWS, WITH SAFETY GRIP	79368 7	1	2.4	
PP19364	32" CONCEALED SCREWS	19364 7	1	2.5	
PP19364SG	32" CONCEALED SCREWS, WITH SAFETY GRIP	79364 9	1	2.5	
PP19365	36" CONCEALED SCREWS	19365 4	1	2.7	
PP19365SG	36" CONCEALED SCREWS, WITH SAFETY GRIP	79365 6	1	2.7	
PP19366	42" CONCEALED SCREWS	19366 1	1	3.1	
PP19366SG	42" CONCEALED SCREWS, WITH SAFETY GRIP	79366 3	1	3.1	
PP19367	48" CONCEALED SCREWS	19367 8	1	3.4	
PP19367SG	48" CONCEALED SCREWS, WITH SAFETY GRIP	79367 0	1	3.4	
STAINLESS STEEL HANDLEBARS™ 1 1/2", 18 GAUGE, 304 SS TUBING, EXPOSED SCREWS					
PP19330	12" EXPOSED SCREWS	19330 2	1	1.3	
PP19330SG	12" EXPOSED SCREWS, WITH SAFETY GRIP	71330 2	1	1.3	
PP19331	16" EXPOSED SCREWS	19331 9	1	1.6	
PP19331SG	16" EXPOSED SCREWS, WITH SAFETY GRIP	71331 9	1	1.6	
PP19332	18" EXPOSED SCREWS	19332 6	1	1.7	
PP19332SG	18" EXPOSED SCREWS, WITH SAFETY GRIP	71332 6	1	1.7	
PP19333	24" EXPOSED SCREWS	19333 3	1	2.2	
PP19333SG	24" EXPOSED SCREWS, WITH SAFETY GRIP	71333 3	1	2.2	
PP19338	30" EXPOSED SCREWS	19338 8	1	2.6	
PP19338SG	30" EXPOSED SCREWS, WITH SAFETY GRIP	79338 0	1	2.6	
PP19334	32" EXPOSED SCREWS	19334 0	1	2.7	
PP19334SG	32" EXPOSED SCREWS, WITH SAFETY GRIP	71334 0	1	2.7	
PP19335	36" EXPOSED SCREWS	19335 7	1	3	
PP19335SG	36" EXPOSED SCREWS, WITH SAFETY GRIP	71335 7	1	3	
PP19336	42" EXPOSED SCREWS	19336 4	1	3.4	
PP19336SG	42" EXPOSED SCREWS, WITH SAFETY GRIP	71336 4	1	3.4	
PP19337	48" EXPOSED SCREWS	19337 1	1	3.9	
PP19337SG	48" EXPOSED SCREWS, WITH SAFETY GRIP	71337 1	1	3.9	

"INDEPENDENCE"
BATH SAFETY

Part Num.	Item Description	UPC# 046224 +	Ctn Qty	Ctn Wt	Line Art	
STAINLESS STEEL HANDLEBARS™ 1 1/2", 18 GAUGE, 304 SS TUBING, CONCEALED SCREWS						
PP1930	12" CONCEALED SCREWS	01930 5	1	1.5		
PP1930SG	12" CONCEALED SCREWS, WITH SAFETY GRIP	71930 4	1	1.5		
PP1931	16" CONCEALED SCREWS	01931 2	1	1.8		
PP1931SG	16" CONCEALED SCREWS, WITH SAFETY GRIP	71931 1	1	1.8		
PP1929	18" CONCEALED SCREWS	01929 9	1	1.9		
PP1929SG	18" CONCEALED SCREWS, WITH SAFETY GRIP	71929 8	1	1.9		
PP1932	24" CONCEALED SCREWS	01932 9	1	2.4		
PP1932SG	24" CONCEALED SCREWS, WITH SAFETY GRIP	71932 8	1	2.4		
PP1938	30" CONCEALED SCREWS	01938 1	1	2.8		
PP1938SG	30" CONCEALED SCREWS, WITH SAFETY GRIP	71938 0	1	2.8		
PP1933	32" CONCEALED SCREWS	01933 6	1	2.9		
PP1933SG	32" CONCEALED SCREWS, WITH SAFETY GRIP	71933 5	1	2.9		
PP1934	36" CONCEALED SCREWS	01934 3	1	3.2		
PP1934SG	36" CONCEALED SCREWS, WITH SAFETY GRIP	71934 2	1	3.2		
PP1935	42" CONCEALED SCREWS	01935 0	1	3.6		
PP1935SG	42" CONCEALED SCREWS, WITH SAFETY GRIP	71935 9	1	3.6		
PP1936	48" CONCEALED SCREWS	01936 7	1	4.1		
PP1936SG	48" CONCEALED SCREWS, WITH SAFETY GRIP	71936 6	1	4.1		
UNIVERSAL STAINLESS STEEL HANDLEBARS™ WITH EXPOSED SCREWS						
PP19354	1 1/2" - 2" X 20" UNIVERSAL	19354 8	1	3.8		
PP19354SG	1 1/2" - 20" X 20" UNIVERSAL, WITH SAFETY GRIP	79378 6	1	3.8		
LEFT & RIGHT HANDED STAINLESS STEEL HANDLEBARS™ WITH EXPOSED SCREWS						
PP19350	1 1/2" - 16" X 32" LEFT HANDED	79369 4	1	4.5		
PP19350SG	1 1/2" - 16" X 32" LEFT HANDED, SAFETY GRIP	79374 8	1	4.5		
PP19351	1 1/2" - 16" X 32" RIGHT HANDED	79370 0	1	4.5		
PP19351SG	1 1/2" - 16" X 32" RIGHT HANDED, SAFETY GRIP	79375 5	1	4.5		
PP19352	1 1/2" - 18" X 32" LEFT HANDED	79371 3	1	4.6		
PP19352SG	1 1/2" - 18" X 32" LEFT HANDED, SAFETY GRIP	79376 2	1	4.6		
PP19353	1 1/2" - 18" X 32" RIGHT HANDED	79372 4	1	4.6		
PP19353SG	1 1/2" - 18" X 32" RIGHT HANDED, SAFETY GRIP	79337 3	1	4.6		

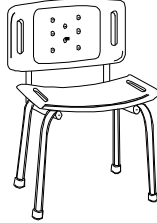
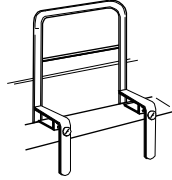
"INDEPENDENCE"
BATH SAFETY

Part Num.	Item Description	UPC# 046224 +	Ctn Qty	Ctn Wt	Line Art
BATH SAFETY SEATS					
PP1985	15" H X 19" W X 12" D, BLOW MOLDED POLYETHYLENE MULTIPLE DRAINAGE HOLES, CHROME FINISH LEGS HAVE NON-SKID RUBBER TIPS	01985 5	1	-	
PP1986	15" H X 19" W X 12" D, BLOW MOLDED POLYETHYLENE MULTIPLE DRAINAGE HOLES, CHROME FINISH LEGS HAVE NON-SKID RUBBER TIPS, ERGONOMICALLY CORRECT BACK REST	01986 2	1	-	
TUB RAILS					
PP1981	18" H X 12" W, RUBBER PROTECTION ON CONTACT POINTS, 1" IN DIAMETER TUB RAIL, POLISHED CHROME, FITS MOST TUBS INCLUDING MODERN MOLDED TUBS, EASY TO ADJUST STEEL CLAMPS	01981 7	1	-	
ADJUSTABLE TOILET GUARD RAIL					
PP1989	ADJUSTABLE LEGS HAVE 5 HEIGHT INCREMENTS FROM 26" TO 30" IN ONE INCH INCREMENTS COMFORTABLE ARM RESTS, RUBBER TIPPED LEGS	01989 3	1	-	
ELEVATED TOILET SEAT					
PP1988	BLOW AND INJECTION MOLDED PLASTIC CONTOURED SEAT, 15 3/4"W X 15 1/2"D X 7 1/2"H, 1 3/4" SPLASH GUARD	01988 6	1	-	

"INDEPENDENCE"
BATH SAFETY



1005PC.....24	1038RBK.....77	107002RB.....59	1193RBK.....77	130-21W.....27	1669PC.....11
100ABS.....30	103AB.....29	107003PC.....59	119AB.....27	130-21WK.....83	1669PCBN.....11
100PVC.....30	103AW.....29	107003RB.....59	119AW.....27	130-25B.....27	1670PC.....12
10-10W.....31	103B.....29	107004PC.....59	119AWK.....83	130-25W.....27	1670PCBN.....12
10-12B.....31	103W.....29	107004RB.....59	119B.....27	1308LRU.....50	1680-2PC.....15
10-12BK.....85	10400B.....26	107050PC.....59	119W.....27	130A-16B.....27	1681K.....76
10-12W.....31	10400W.....26	107051PC.....59	119WK.....83	130A-16W.....27	1681PC.....15
10-12WK.....85	10400WK.....83	108001PC.....59	120AB.....27	130A-16WK.....83	1682PC.....15
10-14W.....31	10404CK.....72	108002PC.....59	120AW.....27	130A-21B.....27	1683PC.....15
101AB.....28	10418CK.....72	108050PC.....59	120B.....28	130A-21W.....27	1685PC.....15
101AW.....28	1041PC.....16	10897PC.....7	120PC.....11	130B.....29	1687PCBAG.....30
101B.....29	10453PC.....6	10898PC.....7	120RBK.....75	130BK.....85	1688DSBNK.....76
101W.....29	10454PC.....6	10-8B.....31	120W.....28	130RBK.....75	1688DSK.....76
10200WK.....83	10454SN.....6	10-8W.....31	120WRUK.....84	130W.....29	1688K.....76
1020PC.....20	10454XSN.....6	10-8WRUK.....85	1210PC.....14	130WK.....85	1688PCBAG.....15
102-1.....19	10455BNK.....73	110K.....75	1217PC.....13	131434SS.....35	1695PC.....15
102-1 1/2.....19	10455PC.....6	110PC.....10	121PC.....13	132430PC.....35	1765TPRU.....17
102-1 1/4.....19	10455SN.....6	110RB.....10	121W.....26	132431PC.....35	1771PC.....13
102-1/2.....19	10455XBNK.....72	11-16ABS.....31	1227PC.....13	1376PC.....34	1772PC.....13
102112PC.....19	10455XK.....73	11-16BK.....85	122B.....28	1377PC.....34	1773K.....75
102114PC.....19	10455XPCBN.....6	11-16PVC.....31	122PC.....13	13877PC.....35	1773PC.....13
10212PC.....19	10455XRBBN.....6	11-16WK.....85	122TTW.....28	139PC.....10	1774PC.....13
1021PC.....19	10455XRBBNK.....72	11-16WRUK.....85	122TTWK.....84	13PVC.....20	1775RBK.....76
102-2.....19	10455XSN.....6	111K.....75	122TTWRUK.....84	140K.....75	1776PC.....13
102-2 1/2.....19	1045PC.....16	111PC.....10	122W.....28	140PC.....11	1776RB.....13
1022PC.....19	10461XPC.....6	111RB.....10	12360PC.....3	140RB.....11	1779PC.....13
102-3.....19	10487K.....72	111RBK.....75	12362PC.....3	141PC.....11	1779RB.....13
102-3 1/2.....19	10487SN.....6	1120K.....75	1247PC.....13	141RB.....11	1799PC.....18
102-3/4.....19	10488K.....72	1120PC.....13	124PC.....13	141WK.....83	1800PC.....18
102-3/8.....19	10488SN.....6	1122K.....76	124WK.....84	142K.....75	1801PC.....18
10234PC.....19	104AB.....29	1122PC.....13	125-16B.....26	142PC.....11	1803PC.....19
10238PC.....19	104ABK.....84	1122RB.....13	125-16TTB.....27	142RB.....11	1804PC.....19
102-4.....19	104AW.....29	112K.....75	125-16TTW.....27	1431SSBX.....33	1805PC.....19
1024PC.....20	104AWK.....84	112PC.....10	125-16W.....26	1432SS.....34	1811K.....78
102-5.....19	104B.....29	112RB.....10	125-16WK.....83	1433-1SS.....35	1813ASN.....7
1025PC.....20	104-4B.....31	113PC.....10	125-16WRUK.....83	1433SS.....33	1813SN.....7
102-6.....19	104BK.....84	1148K.....75	125-18B.....27	1434SS.....34	1814ASN.....7
10291PC.....6	104W.....29	1148PC.....11	125-18W.....27	1435SS.....34	1814SN.....7
10293PC.....6	10-4W.....31	1149PC.....11	125-21B.....27	1436SSBN.....34	1815ASN.....7
10298K.....73	104WK.....84	114K.....75	125-21W.....27	1437SS.....33	1815SN.....7
10298SN.....6	10-4WRUK.....85	114PC.....11	125-21WK.....83	1437SSBNBL.....33	1816ASN.....7
10299SNBN.....6	10501WK.....83	114RB.....10	125-25B.....27	1437SST.....33	1816SN.....7
102AB.....28	105-1.....19	114RBK.....75	125-25W.....27	1438-1PC.....35	1819PC.....24
102AW.....28	105-1 1/2.....19	1159PC.....14	125-8B.....29	1438PC.....33	1820PC.....24
102B.....29	105-1 1/4.....19	1160PC.....13	125-8W.....29	1440SSBN.....34	1828PC.....24
102W.....29	105-1/2.....19	1160RB.....13	125A-16B.....27	1440SSBNBL.....34	1834PC.....20
10300CCP.....5	105112PC.....19	1161K.....75	125A-16TTB.....27	1440SSBNK.....77	1837PB.....24
10300CK.....72	105114PC.....19	1161PC.....13	125A-16TTW.....27	1441SS.....33	1837PC.....24
10300CP.....5	10512PC.....19	1161RB.....13	125A-16W.....27	1443SS.....34	1838PCLF.....24
10300PC.....5	1051PC.....19	1162PC.....13	125A-16WK.....83	144K.....75	1840PC.....24
10301CP.....5	105-2.....19	1162RB.....13	125A-16WRUK.....83	144PC.....11	1845ALLF.....24
10301PC.....5	105-2 1/2.....19	1162RBK.....76	125AB.....29	144RB.....11	1847ALLF.....24
10301RB.....5	105-3.....19	1163PC.....13	125ABK.....84	147PC.....11	18W.....20
10302CP.....5	105-3/4.....19	1163RB.....13	125AW.....29	14ABS.....20	1901K.....75
10303CP.....5	10534PC.....19	1164K.....76	125AWK.....84	14PVC.....20	1901PC.....11
10304CCP.....5	105AB.....29	1164PC.....13	125B.....29	1533SN.....8	1903K.....75
10304CK.....72	105AW.....29	1164RB.....13	125BK.....84	153PC.....11	1903PC.....11
10304CP.....5	105B.....29	1164RBK.....76	125W.....29	154PC.....11	1904K.....75
10304PC.....5	105W.....29	1166RBK.....76	125WK.....84	155PC.....11	1904PC.....12
10305CP.....5	1061PC.....15	1168RBK.....76	1267PC.....13	1560SN.....8	1904PCBN.....12
10305K.....72	1063PC.....15	1169RBK.....76	126PC.....12	1566ASN.....8	1906K.....75
10305PC.....5	1065PC.....15	1172SN.....16	1277PC.....13	1566SN.....8	1906PC.....12
10306CP.....5	106AB.....29	117K.....75	127AB.....27	1567SN.....8	1906RB.....12
10307CP.....5	106AW.....29	117PC.....11	127AW.....27	1568ASN.....8	1907K.....75
1030PC.....24	106B.....29	1186RB.....16	127B.....27	1568SN.....8	1907PC.....12
10318K.....72	10-6B.....31	1187RB.....17	127PC.....12	1569ASN.....8	1908K.....75
10319K.....72	10-6BK.....85	1187RBK.....77	127TTWRUK.....84	1569SN.....8	1908PC.....12
1031PC.....24	106W.....29	1189RB.....17	127W.....27	15ABS.....32	1909PC.....12
1037K.....77	10-6W.....31	1189RBK.....77	1297PC.....13	15K.....85	1910PC.....12
1037PC.....15	106WK.....84	118PC.....10	129PC.....12	15PVC.....32	1910RBBN.....12
1037RB.....15	10-6WK.....85	1190RB.....16	12PBK.....75	160PC.....10	1977PC.....12
1037RBK.....77	10-6WRUK.....85	1191CRB.....17	130-16B.....27	1614PC.....15	1978PC.....12
1038K.....77	107001PC.....59	1191RB.....17	130-16W.....27	161PC.....10	200W2.....25
1038PC.....15	107001RB.....59	1193CRB.....17	130-16WK.....83	161RB.....10	200W2DF.....25
1038RB.....15	107002PC.....59	1193RB.....17	130-21B.....27	162PC.....10	200WK.....82



200WUJ2.....25	22070K.....88	260.....35	301CPBN866K.....71	305PXCPCBNDF.....1	334W.....28
20-12ABS.....31	22112K.....80	2621PC.....53	301CPBNDF.....1	305RB.....1	334WK.....84
20-12PVC.....31	22114K.....80	2622DS.....53	301CPBNDFK.....71	305XBNK.....71	334WRUBXK.....84
20-12WK.....86	221PC.....13	2622PC.....53	301CPDF.....1	305XCP.....2	334WRUK.....84
20204K.....80	22212K.....80	2622PCFSS12.....57	301K.....71	305XCPBN.....2	335B.....28
20212K.....80	222-21WRUK.....84	2622PCFSS16.....57	301LCP.....1	305XPC.....2	335BK.....84
20234K.....80	222B.....28	2622PCFSS20.....57	301LLSN.....1	305XPCBN.....2	335W.....28
20238K.....80	222PC.....13	2622PCTSS12.....57	301PC.....1	305XPCBNDF.....2	335WK.....84
2041PC.....52	222TTW.....28	2622PCTSS16.....57	301PCBN.....1	305XRBBN.....2	338B.....28
2042PC.....52	222TTWK.....84	2622PCTSS9.....57	301PXCPCBNDF.....1	306CP.....2	33-8B.....30
2046PC.....53	222TTWRUK.....84	2623PC.....53	301XCP.....1	306CPDF.....2	338W.....28
2047DS.....53	222W.....28	2624PC.....53	301XCPBN.....1	306PC.....2	33-8W.....30
2047PC.....53	222WRUK.....84	2625PC.....53	30200WK.....83	307CP.....2	33-8WK.....85
2047PCLK.....55	224PC.....13	2626PC.....53	302CP.....2	307LPC.....3	34-12PVC.....30
2048DS.....53	227PC.....12	2659PC.....53	302PC.....2	307PC.....3	341B.....28
2048PC.....53	229PC.....12	2670PC.....53	30300CCP.....6	307PCBN.....3	341B8K.....87
2048PCLK.....55	231PC.....12	2701PC.....54	30300CK.....74	307PCDF.....3	341W.....28
2049PC.....53	232PC.....12	270W.....26	30300CP.....6	307XCPBN.....3	341W9K.....87
2049PCLK.....55	2343.....58	270WK.....82	30300L15PC.....6	30879BL.....35	342B8K.....87
20501K.....80	2344.....58	2710PC.....53	30300LCCP.....6	30-8B.....30	34-8B.....30
20502K.....80	2345.....58	2711PC.....53	30300LCP.....6	308CCP.....2	34-8W.....30
2050DS.....53	2346.....58	2720PC.....54	30300PC.....6	308CP.....2	35-8B.....30
2050PC.....53	234PC.....12	2721PC.....54	30301CP.....6	30-8W.....30	35-8W.....30
20512K.....80	235PC.....11	2722PC.....54	30301L15PC.....6	30-8WK.....85	35-8WK.....85
2051PC.....53	236PC.....11	2723PC.....54	30301LCP.....6	30-8WRUK.....85	361XPCBNDF.....3
2052PC.....54	238PC.....11	2724PC.....54	30301PC.....6	309CP.....2	363XPCBNDF.....3
20534K.....80	2431NPC.....33	2780PC.....53	30304CCP.....6	30SN.....5	367XPCBNDF.....3
2053PC.....53	2432PB.....33	2781PC.....52	30304CK.....74	310CP.....3	369XPCBNDF.....3
2055DS.....52	2433PC.....33	27PVC.....32	30304CRBK.....74	310PC.....3	381RBK.....73
2055PC.....52	2433PCBNBL.....33	2880PC.....53	30304LCCP.....6	31-12PVC.....30	382RBK.....73
2057PC.....53	2435PC.....33	2880PCFSS12.....57	30304LCP.....6	311PC.....3	386CPK.....73
2058DS.....52	2452PCLK.....55	2880PCFSS16.....57	30304PC.....6	31-8B.....30	386RBK.....73
2058PC.....52	250-1SS.....35	2880PCFSS20.....57	30305L15CP.....7	31-8BK.....85	387RBK.....73
2059PC.....52	250SS.....35	2880PCTSS12.....57	30305L15PC.....7	318K.....72	388RBK.....73
2060PC.....52	25112K.....80	2880PCTSS16.....57	30305LPC.....7	31-8W.....30	389CPK.....73
2068DS.....52	25114K.....80	2880PCTSS9.....57	30305PC.....7	31-8WK.....85	390PC.....3
2068PC.....52	2517ARB.....10	2881PC.....53	30307CP.....8	31-8WRUK.....85	397PCDC.....3
2069PC.....52	2517ASN.....10	2882PC.....54	30324CCP.....7	319CP.....2	3SN.....23
20-6PVC.....31	2517RB.....9	2883PC.....53	30324CK.....74	319K.....72	400ABS.....25
20-6WK.....86	2517SN.....9	28WK.....87	30324CP.....7	319XCPBN.....2	400B.....25
2070PC.....52	2518ARB.....10	2901PC.....54	30325PC.....7	319XK.....72	400BK.....82
2071PC.....52	2518ASN.....10	2902PC.....54	30332CK.....74	32-12PVC.....30	400CPDFK.....82
2072PC.....55	2518RB.....9	2903PC.....54	30332CP.....7	324CCP.....4	400PVC.....25
20831K.....77	2518SN.....9	2904PC.....54	30333PC.....7	324CK.....72	400PVCB.....25
20871K.....79	2519ARB.....10	2905PC.....54	3033CP.....2	324CP.....4	400PVCK.....82
20879RU.....50	2519ASN.....10	2906PC.....54	303CPDF.....2	324K.....72	400SABS.....25
20-8ABS.....31	2519RB.....9	2907PC.....54	303LLPC.....2	325CP.....4	400SPVC.....25
20-8PVC.....31	2519RBK.....74	2908PC.....54	303PC.....2	325CPBN.....4	400STTB.....25
2100PC.....54	2519SN.....9	2909PC.....54	303PCBN.....2	325CPBN866.....4	400STTW.....25
2100PCLK.....55	2521AK.....75	2910PC.....54	303PCDF.....2	325CPBN866K.....72	400SWK.....82
2100PCTSS9.....57	2521ARB.....10	2911PC.....54	30400WK.....83	325CPBNDF.....4	400TTB.....25
2101PC.....53	2521ARBK.....75	2912PC.....54	30455K.....73	325CPBNDFK.....72	400TTBK.....82
21021K.....80	2521ASN.....10	291PC.....3	304CCP.....1	325K.....72	400TTPRW.....25
21022K.....80	2521K.....74	292WK.....79	304CCPDF.....1	325PXCPCBNDF.....3	400TTPRWU.....25
21023K.....80	2521RB.....9	293PC.....3	304CK.....71	32-8B.....30	400TTW.....25
2102PC.....52	2521RBK.....74	298SN.....5	304CLCP.....1	328CPDF.....4	400TTWDF.....25
2103PC.....55	2521SN.....9	299SN.....5	304CP.....1	32-8W.....30	400TTWK.....82
210PC.....11	2522ARB.....10	2KSN.....23	304CRB.....1	32-8WK.....85	400TTWRU.....25
210RB.....11	2522ASN.....10	2WSN.....23	304K.....71	33-12PVC.....30	400W.....25
21102K.....80	2522RB.....9	300CCP.....1	304PC.....1	332CCP.....4	400WB2.....25
21112K.....80	2522SN.....9	300CCPDF.....1	304RB.....1	332CK.....72	400WK.....82
21-16ABS.....31	2523ARB.....10	300CK.....71	304RPC.....3	332CP.....4	40-12B.....31
21-16PVC.....31	2523ASN.....10	300CLCP.....1	30501WK.....87	332CPDF.....4	40-12BK.....86
2119PC.....14	2523RB.....9	300CP.....1	305CP.....1	332K.....72	40-12W.....31
211PC.....11	2523RBK.....74	300CPBNDF.....1	305CPBN867.....2	333B.....28	40-12WK.....86
211RB.....11	2523SN.....9	300CPDF.....1	305CPBN867K.....71	333CP.....4	40-12WRUK.....86
2129RBK.....76	2524RB.....9	300K.....71	305CPBNDF.....2	333CPBN867.....4	403W2.....25
212PC.....11	2524SN.....9	300LPC.....1	305CPBNDFK.....71	333CPBN867K.....72	40600DSN.....17
212RB.....11	2525RB.....10	300PC.....1	305CPDF.....2	333CPBNDF.....4	40-6B.....31
2148PC.....11	2526AK.....75	300PCBN.....1	305K.....71	333CPBNDFK.....72	40-6BK.....86
2149PC.....11	2527RBK.....74	300PCDF.....1	305LCP.....1	333K.....72	40-6W.....31
214K.....75	2527SN.....9	300RPC.....3	305LLSN.....1	333PXCPCBNDF.....3	40-6WK.....86
214PC.....11	2528RBK.....74	30-12PVC.....30	305PC.....2	333W.....28	40-8B.....31
214RB.....11	25513K.....78	301CP.....1	305PCBN.....2	334B.....28	40-8W.....31
217PC.....11	25576K.....86	301CPBN866.....1	305PCDF.....2	334BK.....84	40-8WRUK.....86



41-16ABS	31	49SN	14	53RSN	15	606RBD	37	62ACW	40	645PVC	44
41-16BK	86	49SRB	14	53SSN	15	607RB	37	62AW	40	645PVCBN	44
41-16PVC	31	49SSN	14	540AK	74	608RB	37	62AW-8	40	645PVCBS	44
41-16WK	86	4SN	23	540ASN	8	609RB	37	62B	39	645PVCDS	44
41-16WRUK	86	500ABS	26	540ATTK	74	609RBD	37	62BDS	39	645PVCDSBN	44
41RB	15	500K	82	540ATTSN	9	610ARB	38	62CW	40	645PVCDSPB	44
41RBK	76	500KN	23	540BNSK	74	610ARBGT	38	62SN	5	645PVCWH	44
42-12W	31	500PVC	26	540BSN	8	610RB	38	62W	39	64-6ABS	49
42-12WK	85	50-1	58	540SN	8	610RBD	38	62WDS	39	646PVC	43
42-16W	31	501430RU	35	540TTK	74	611RB	38	62WDSBN	39	64-6PVC	49
42-6W	31	501437RU	35	540TTSN	9	611RBD	38	6300	1	64-99AN	38
42-6WK	85	501765K	78	541SN	9	612RB	38	6300K	71	64-99DS	38
42-8W	31	501ABS	26	542ASN	10	6141RB	49	6301	1	64-99PC	38
44PVC	32	501KN	23	542SN	9	614RB	49	6301PB866	1	64-99WH	38
44RB	15	501PVC	26	543ASN	10	615RB	37	6305	2	64B	40
450K	73	501WK	82	543SN	9	615RBBN	37	6305PB867	2	64BDELUXE	40
451K	73	50-2	58	544ASN	10	615RBD	37	630ABS	42	64BDS	40
451PC	5	502KN	23	544SN	9	616SN	49	630ABSDS	42	64BWH	40
451RB	5	50-3	58	5461XPC	22	617-4	49	630ABSTP	42	64CW	40
451RBK	73	503KN	23	546ASN	10	617RB	38	630LAABS	42	64W	40
454K	73	50-4	58	546B2	26	61CW	39	630LAABSDS	42	64WDELUXDS	40
454SN	4	50-5	58	546SN	9	61W	39	630LAPVC	42	64WDELUXE	40
454XFSN	4	505KN	23	546W2	26	620-10PC	49	630LAPVCDS	42	64WDS	40
455SN	4	507050P	64	546W2K	83	620-2B	50	630PVC	42	64WK	88
455XF-6PC	4	50879-5K	87	546WRUK	83	620-2LAABS	50	630PVCDS	42	64WWH	40
455XFPC	4	50879K	87	547SN	9	620-2LAPVC	50	630PVCTP	42	65	32
455XFSN	4	50879PBU	36	548ASN	10	620-2W	50	630PVCWH	42	650ABS	43
455XPCPVC	5	50879TPRU	36	548SN	9	620-3B	50	631ABS	42	650ABSTP	43
4566ASN	8	50-9	64	549W2	26	620-3W	50	631ABSDS	42	650PVC	43
4566SN	8	50915K	78	549W2K	83	620-7B	51	63-1CF	48	650PVCDS	43
4568AK	74	50915TPRU	17	549WRUK	83	620-7G	51	63-1CFAN	48	650PVCTP	43
4568ASN	8	50918K	78	54K	76	620-8B	51	63-1CFPB	48	650PVCWH	43
4568ATTSN	8	50918RU	17	54RB	14	620-8G	51	63-1F	48	651ABS	43
4568K	74	50918TPRU	17	54RSN	14	620-9B	50	63-1FAN	48	651PVC	43
4568SN	8	50SN	14	54SN	14	620-9W	50	63-1FPB	48	651PVCDS	43
4568TTSN	8	51-1	58	54SSN	14	620AABS	41	631LAABSDS	42	651PVCWH	43
461XF-6PC	4	511430P	35	55-5WK	87	620ABS	41	631LAPVC	42	652ABS	43
461XFPC	4	51-2	58	55B	32	620ABSDS	41	631LAPVCDS	42	652ABSDS	43
461XFSN	4	51-3	58	55W	32	620ALAPVC	41	631PVC	42	652PVC	43
461XPBPVC	5	517ASN	10	55WK	87	620APVC	41	631PVCDS	42	652PVCDS	43
461XPCPVC	5	517RB	9	56-5WK	87	620ATTPVC	41	631PVCK	88	652PVCWH	43
461XPCPVCK	73	517SN	9	5680K	76	620LAABS	41	631PVCWH	42	653ABS	43
46ABS	31	518ASN	10	5680PC	22	620LAPVC	41	63-4AN	49	653PVC	43
46PVC	31	518RB	9	5681PC	22	620LAPVCWH	41	63-4PC	49	65-5K	88
46WK	87	519ASN	10	5682PC	22	620PVC	41	63-4WHT	49	65-99DS	39
471PC	5	519RB	9	56B	32	620PVCDS	41	63-50AN	48	65K	88
473PC	5	519SN	9	56W	32	620PVCWH	41	63-50PB	48	66	32
47ABS	32	51RB	14	56WK	87	621AABS	42	63-50PC	48	66-99DS	39
47PVC	32	51SN	14	57	32	621ABS	41	63-51PC	48	66-99PC	39
47SK	76	521ASN	10	5700PC	22	621ABSDS	41	63-99AN	38	669K	77
47SN	14	521RB	9	57-5WK	88	621ABSWH	41	63-99DS	38	669PC	16
47SSN	14	521SN	9	57WK	88	621ACPVC	42	63-99PC	38	670K	77
47WK	87	522ASN	10	584SN	9	621ALAABS	42	63-99WH	38	670PC	16
4813ASN	7	522RB	9	595RB	37	621ALAPVC	42	63B	40	671K	77
4813SN	7	522SN	9	597RB	37	621APVC	42	63BDS	40	671PC	16
4815AK	74	523ASN	10	599KN	23	62-1CF	49	63TTW	40	672K	77
4815ASN	7	523RB	9	59B	32	62-1CFPB	49	63W	40	672PC	16
4815K	74	523SN	9	59W	32	621LAABS	41	63WDS	40	673K	77
4815SN	7	5303K	71	5SN	23	621LAPVC	41	640-14W	50	673PC	16
4815SNBN	7	5303PC	21	600ABS	26	621LAPVCDS	41	640ABS	43	674K	77
4815TTSN	8	5303PCDC	22	600K	83	621LAPVCWH	41	640ABSDS	43	674PC	16
4817RB	7	5303PCDF	22	600PVC	26	621PVC	41	640PVC	43	67B	40
4817SN	7	5307PC	21	600SN	37	621PVCDS	41	640PVCDS	43	67W	40
487SN	4	5307PCDC	22	601430SN	35	621PVCK	88	641-14B	50	681K	76
488SN	4	5307PCDF	22	601815ASN	9	621PVCWH	41	641-14W	50	681PC	15
48ABS	32	5307XPC	22	601SN	37	622RU	50	64-14ABS	49	68W	48
48PVC	32	5311PC	21	602RB	37	62-3F	49	64-14PVC	49	690ABS	45
48SN	14	5311PCDC	22	604RB	37	62-95DS	39	641ABS	43	690ABSBSQ	45
48SSN	14	5311XPC	22	605LAR	37	62-95PC	38	641ABSDS	43	690ABSDS	45
48WK	87	535SN	8	605ARB	37	62-95WH	39	641PVC	43	690ABSDSBN	45
49B	32	536SN	8	605RB	37	62-99AN	38	641PVCDS	43	690ABSDSPRN	45
49K	76	538BRBK	74	606-1PC	49	62-99DS	38	64-3M	50	690ABSDSSN	45
49PVC	32	538BSN	8	606-21	39	62-99PC	38	645ABS	44	690ABSORB	45
49PVCK	87	538K	74	606-2PC	49	62-99WH	38	645ABSDSBN	44	690ABSPN	45
49RSN	14	538SN	8	606RB	37	62AB	40	645ABSPB	44	690ABSSC	45



690ABSSS.....	45	700W.....	26	7906RB.....	12	884PB.....	18	K1442BLK.....	68	K5419.....	68
690ABSVB.....	45	700W2.....	26	7906RBBN.....	12	885PC.....	18	K1442BSQ.....	68	K5420.....	68
690ABSWH.....	45	700WDF.....	26	800PVC.....	26	890PC.....	19	K1442PC.....	68	K5421.....	69
690PVC.....	44	700WK.....	82	801K.....	82	900K.....	77	K1442WH.....	68	K5435.....	69
690PVCBSQ.....	45	701PVC.....	26	801PVC.....	26	900PC.....	16	K20071.....	81	K5435DSBN.....	69
690PVCDS.....	44	701PVCK.....	82	81240K.....	86	900RB.....	16	K20072.....	81	K5435DSPB.....	69
690PVCDSBN.....	44	701PVCruk.....	82	812-70K.....	88	901K.....	77	K20073.....	81	K5435DSSS.....	69
690PVCDSPRN.....	45	7037PC.....	15	81K.....	88	901PC.....	16	K20074.....	81	K5435FG.....	69
690PVCDSRN.....	44	7038PC.....	15	81SSABS.....	35	901RB.....	16	K20079.....	81	K5435ORB.....	69
690PVCORB.....	45	7039PC.....	15	82070PBK.....	88	902PC.....	16	K20080.....	81	K5435PL.....	69
690PVCPCN.....	45	7074PC.....	55	82-1.....	35	902RB.....	16	K20081.....	81	K5435VB.....	69
690PVCSC.....	45	7076PC.....	55	82678K.....	88	903LK.....	77	K20085.....	81	K5435WI.....	69
690PVCSS.....	45	7077PC.....	54	82SSABS.....	35	903LPC.....	16	K20112.....	80	K5445.....	69
690PVCVB.....	45	7078PC.....	54	83-1.....	35	903LRB.....	16	K20113.....	80	K5445DSBN.....	69
690PVCWH.....	44	7079PC.....	55	83SSABS.....	35	906PC.....	16	K20288.....	79	K5450.....	69
690RKABS.....	46	7083PCMH.....	56	848PC.....	18	906RB.....	16	K20289.....	79	K5451.....	69
690RKAPVC.....	46	7084PCMH.....	56	84W.....	40	91215K.....	86	K20290.....	79	K5461.....	69
690RKAPVCDS.....	46	7085KC12PCZ.....	57	84WDS.....	40	9121K.....	86	K20300.....	79	K5471.....	69
690TKPVC.....	46	7085PCMH.....	56	850CPC.....	18	91250K.....	86	K20301.....	79	K5475.....	69
690TKPVCDS.....	46	7086PCMH.....	56	850PC.....	18	9125K.....	86	K2037.....	54	K5475DSBN.....	69
691ABS.....	45	7087PC.....	56	851CPC.....	18	9126K.....	86	K2038.....	54	K606-22.....	67
691ABSBSQ.....	45	7088PC.....	56	851K.....	79	913DK.....	78	K2039.....	54	K612DSBN.....	70
691ABSDS.....	45	7088RB.....	56	851PC.....	18	915DK.....	77	K2040.....	54	K612DSPB.....	70
691ABSDSBN.....	45	7092PCMH.....	56	852K.....	79	915DPC.....	17	K2048ABN.....	70	K612DSSS.....	70
691ABSDSPRN.....	45	7092RB.....	56	852PC.....	18	915DRB.....	17	K2048APB.....	70	K612PC.....	70
691ABSDSSN.....	45	7093PC.....	56	853K.....	79	915K.....	77	K2048AVB.....	70	K612VB.....	70
691ABSORB.....	45	7095KC12PB.....	57	853PC.....	18	915PC.....	17	K2082026.....	68	K612WH.....	70
691ABSPN.....	45	7095KC12PC.....	57	854PC.....	18	915RB.....	17	K20882.....	79	K62-3DSBN.....	66
691ABSSC.....	45	7095KL12PB.....	57	85522K.....	78	915RBK.....	78	K20884.....	79	K62-3DSPB.....	66
691ABSSS.....	45	7095KL12PC.....	57	85536K.....	88	916DK.....	77	K21110.....	80	K62-3PC.....	66
691ABSVB.....	45	7095PCMH.....	56	85539K.....	88	916DPC.....	17	K21131.....	80	K630ABSDSBN.....	65
691ABSWH.....	45	7095RB.....	56	85560K.....	78	916DRB.....	17	K21134.....	80	K630PVCDSBN.....	65
691APVC.....	45	7096PC.....	56	85570K.....	86	916PC.....	17	K21135.....	80	K630PVCVB.....	65
691APVCBSQ.....	45	7099PC.....	56	85575K.....	86	916RB.....	17	K21136.....	79	K63WDSBN.....	65
691APVCDS.....	45	70W.....	47	85580K.....	87	916RBK.....	78	K218136.....	81	K64-14W.....	67
691APVCDSBN.....	45	70WDS.....	47	855K.....	79	917DK.....	77	K218137.....	81	K650ABSDSBN.....	65
691APVCDSPRN.....	45	7148PC.....	11	855PC.....	18	917DPC.....	17	K22013.....	68	K650PVCDSBN.....	65
691APVCDSRN.....	45	7149PC.....	11	856K.....	79	917PC.....	17	K22022.....	67	K820-10DSBN.....	66
691APVCORB.....	45	71W.....	47	856PB.....	18	917RB.....	17	K22025.....	68	K820-10DSPB.....	66
691APVCPN.....	45	720PC.....	24	856PBK.....	79	918DK.....	77	K23210.....	81	K820-10PC.....	66
691APVCSC.....	45	7216PC.....	59	856PC.....	18	918DPC.....	17	K23310.....	81	K820-22DSBN.....	67
691APVCSS.....	45	7217PC.....	59	858K.....	79	918DRB.....	17	K23340.....	81	K820-22DSPB.....	67
691APVCVB.....	45	7282PC.....	56	858PC.....	18	918K.....	78	K25525.....	81	K820-50.....	68
691APVCWH.....	45	7283PC.....	56	859K.....	79	918PB.....	17	K25526.....	81	K820-56DSPB.....	66
692ABS.....	46	7283RB.....	56	859PC.....	18	918PC.....	17	K25701.....	80	K820-56PC.....	66
692ABSBSQ.....	46	7284PC.....	56	860K.....	79	918RB.....	17	K25702.....	80	K820-77BN.....	70
692ABSDS.....	46	7288PC.....	56	860PC.....	18	918RBK.....	78	K25703.....	80	K820-77PB.....	70
692ABSDSBN.....	46	7292PC.....	56	861K.....	79	919DK.....	77	K281031.....	81	K820-77VB.....	70
692ABSDSPRN.....	46	72W.....	48	861PC.....	79	919DPC.....	17	K281033.....	81	K821-39.....	67
692ABSDSSN.....	46	73SSABS.....	29	863K.....	79	919PC.....	17	K30-20BN.....	70	K826-11DSBN.....	66
692ABSORB.....	46	7400PC.....	22	863PC.....	18	919RB.....	17	K30-20PB.....	70	K826-11DSPB.....	66
692ABSPN.....	46	7450KL12PC.....	22	864PC.....	18	919RBK.....	78	K30-20VB.....	70	K826-11PC.....	66
692ABSSC.....	46	7450PC.....	22	866K.....	79	932PC.....	17	K33-10BN.....	70	K826-12DSBN.....	66
692ABSSS.....	46	7451KL12PCDF.....	22	866PB.....	18	935K.....	78	K33-10PB.....	70	K826-12DSPB.....	66
692ABSVB.....	46	7451PC.....	22	866PC.....	18	935PC.....	17	K33-10VB.....	70	K826-12PC.....	66
692ABSWH.....	46	7452PC.....	22	867K.....	79	937K.....	78	K33-40BN.....	70	K826-1DSBN.....	66
692APVC.....	46	7453PC.....	22	867PB.....	18	937PC.....	17	K33-40PB.....	70	K826-1DSPB.....	66
692APVCBSQ.....	46	7454PC.....	22	867PC.....	18	939PC.....	17	K33-40VB.....	70	K826-1PC.....	66
692APVCDS.....	46	74SSABS.....	29	868K.....	79	95ABS.....	32	K40-20BN.....	70	K826-20DSBN.....	65
692APVCDSBN.....	46	757PC.....	12	868PC.....	18	95K.....	87	K40-20PB.....	70	K826-20DSPB.....	65
692APVCDSPRN.....	46	758PC.....	12	869PC.....	18	95PVC.....	32	K40-20VB.....	70	K826-20PC.....	65
692APVCDSRN.....	46	75SSABS.....	29	86W.....	48	95TTABSRU.....	32	K5064DSBN.....	66	K826-21DSBN.....	65
692APVCORB.....	46	7669PC.....	12	86WDS.....	48	965K.....	88	K5064DSPB.....	66	K826-21DSPB.....	65
692APVCPN.....	46	7670PC.....	12	871K.....	79	99K.....	87	K5064PC.....	66	K826-21PC.....	65
692APVCSC.....	46	76K.....	88	871PC.....	18	99PVC.....	32	K5410.....	68	K826-22.....	67
692APVCSS.....	46	772NPC.....	16	872PC.....	18	CD6-7R.....	63	K5412.....	68	K826-3.....	67
692APVCVB.....	46	775NPC.....	16	873K.....	79	K100BN.....	69	K5414.....	68	K826-34DSBN.....	66
692APVCWH.....	46	777NPC.....	16	873PC.....	18	K100PB.....	69	K5414-2.....	68	K826-34DSPB.....	66
69W.....	48	779NPC.....	16	874PC.....	22	K100VB.....	69	K5416.....	68	K826-34PC.....	66
69WDS.....	48	77W.....	48	877PC.....	34	K107001PB.....	59	K5417.....	69	K826-65PC.....	66
700B.....	26	78PL.....	30	878PC.....	34	K107002PB.....	59	K5417BSQ.....	69	K826-65VB.....	66
700PVC.....	25	7901PC.....	12	879PC.....	35	K107050PB.....	59	K5417DSBN.....	69	K826-66CB.....	67
700PVCK.....	82	7903PC.....	12	87W.....	48	K107051PB.....	59	K5417DSPB.....	69	K826-66FG.....	67
700SPVC.....	26	7904PC.....	12	882K.....	79	K1433-1.....	68	K5417VB.....	69	K826-66ORB.....	67
700TTPRWUR.....	26	7906PC.....	12	882PC.....	18	K1438-1.....	68	K5417WH.....	69	K826-66PC.....	67



K826-66PL.....67	PP19342SG.....91	PP19950.....90	PP23860.....59
K826-66VB.....67	PP19343.....91	PP19951.....90	PP23861.....59
K826-66WI.....67	PP19343SG.....91	PP19952.....90	PP23862.....59
K826-69DSBN.....66	PP19344.....91	PP19960.....90	PP23863.....60
K826-71DSBN.....67	PP19344SG.....91	PP19961.....90	PP23865.....60
K826-81BC.....67	PP19345.....91	PP19975.....90	PP23866.....60
K826-81DSBN.....67	PP19345SG.....91	PP19976.....90	PP23867.....60
K826-81FG.....67	PP19346.....91	PP19980-2.....90	PP23868.....60
K826-81ORB.....67	PP19346SG.....91	PP19982-2.....90	PP23869.....60
K826-81PC.....67	PP19347.....92	PP20050.....56	PP23870.....60
K826-81PL.....67	PP19347SG.....92	PP20051.....56	PP23871.....60
K826-81VB.....67	PP19348.....91	PP20052.....56	PP23872.....60
K826-81WI.....67	PP19348SG.....91	PP20053.....56	PP23873.....60
K84WDSBN.....65	PP1934SG.....93	PP20054.....56	PP23874.....60
K850PB.....18	PP1935.....93	PP20060.....56	PP23875.....60
K851PB.....18	PP19350.....93	PP20061.....56	PP23876.....60
K86011PC.....70	PP19350SG.....93	PP20062.....56	PP23877.....60
K86011WH.....70	PP19351.....93	PP20063.....56	PP23882.....60
K863-11.....67	PP19351SG.....93	PP20321.....57	PP23883.....60
K863-50DSBN.....65	PP19352.....93	PP20322.....56	PP23884.....60
K863-50DSPB.....65	PP19352SG.....93	PP23453.....60	PP23885.....60
K863-50PC.....65	PP19353.....93	PP23799.....61	PP23888.....60
K90BN.....70	PP19353SG.....93	PP23800.....60	PP25523.....63
K90PB.....70	PP19354.....93	PP23801.....61	PP25529.....63
K90VB.....70	PP19354SG.....93	PP23802.....61	PP2911.....91
K91BN.....70	PP1935SG.....93	PP23803.....61	PP2921.....91
K91PB.....70	PP1936.....93	PP23804.....62	PP2931.....91
K91VB.....70	PP19360.....92	PP23805.....62	PP2941.....91
LICSELLWS.....58	PP19360SG.....92	PP23806.....62	PP2951.....91
LIFNTURNTRBN.....47	PP19361.....92	PP23807.....62	PP2961.....91
LIFNTURNTRBS.....47	PP19361SG.....92	PP23808.....61	PP2971.....91
LIFNTURNTRIM.....47	PP19362.....92	PP23809.....60	PP2982.....91
LIFNTURNTRMW.....47	PP19362SG.....92	PP23810.....61	PP810-31BU.....64
PP1900.....91	PP19363.....92	PP23811.....61	PP810-33BU.....64
PP1901.....91	PP19363SG.....92	PP23812.....62	PP888-1.....63
PP1902.....91	PP19364.....92	PP23813.....62	PP888-10.....63
PP1903.....91	PP19364SG.....92	PP23814.....62	PP888-11.....63
PP1920.....91	PP19365.....92	PP23815.....61	PP888-12.....63
PP1921.....91	PP19365SG.....92	PP23816.....61	PP888-3.....63
PP1922.....91	PP19366.....92	PP23817.....61	PP888-4.....63
PP1923.....91	PP19366SG.....92	PP23818.....61	PUSHNPULTRBN.....47
PP1929.....93	PP19367.....92	PP23819.....61	PUSHNPULTRIM.....47
PP1929SG.....93	PP19367SG.....92	PP23821.....62	ROUGHINKITAB.....47
PP1930.....93	PP19368.....92	PP23824.....61	ROUGHINKITBS.....47
PP1930SG.....93	PP19368SG.....92	PP23825.....61	ROUGHINKITPV.....47
PP1931.....93	PP1936SG.....93	PP23826.....61	ROUGHINKITPW.....47
PP1931SG.....93	PP1938.....93	PP23827.....61	ROUGHINKITPBN.....47
PP1932.....93	PP1938SG.....93	PP23828.....61	
PP1932SG.....93	PP1940.....91	PP23829.....61	
PP1933.....93	PP1941.....91	PP23832.....62	
PP19330.....92	PP1942.....91	PP23833.....63	
PP19330SG.....92	PP1943.....91	PP23834.....63	
PP19331.....92	PP1981.....94	PP23835.....63	
PP19331SG.....92	PP1985.....94	PP23836.....63	
PP19332.....92	PP1986.....94	PP23837.....63	
PP19332SG.....92	PP1988.....94	PP23838.....62	
PP19333.....92	PP1989.....94	PP23839.....61	
PP19333SG.....92	PP19900.....89	PP23840.....61	
PP19334.....92	PP19901.....89	PP23841.....61	
PP19334SG.....92	PP19902.....89	PP23842.....62	
PP19335.....92	PP19903.....89	PP23843.....62	
PP19335SG.....92	PP19904.....89	PP23844.....62	
PP19336.....92	PP19905.....89	PP23845.....62	
PP19336SG.....92	PP19906.....89	PP23846.....61	
PP19337.....92	PP19910.....89	PP23847.....61	
PP19337SG.....92	PP19911.....89	PP23848.....61	
PP19338.....92	PP19912.....89	PP23849.....61	
PP19338SG.....92	PP19913.....89	PP23850.....61	
PP1933SG.....93	PP19914.....89	PP23851.....61	
PP1934.....93	PP19915.....89	PP23852.....61	
PP19340.....91	PP19916.....89	PP23853.....62	
PP19340SG.....91	PP19920.....89	PP23854.....62	
PP19341.....91	PP19922.....89	PP23855.....62	
PP19341SG.....91	PP19923.....89	PP23856.....62	
PP19342.....91	PP19926.....89	PP23857.....62	

TERMS

1. Prices are subject to change without notice and we reserve the right to invoice all orders at prevailing prices at time of shipment. If any changes, additions, or deletions are made to prices, items, or details in our list price, they will take precedence over our current illustrated catalog.
2. 2% 10th Prox net end of month from invoice date.
3. A service charge of 18% per annum may be assessed against accounts that are 30 days past due.
4. No invoice will be rendered for less than \$100.00.
5. Product availability may be subject to our ability to obtain supplies and raw materials which may be limited by U.S. Government restriction.
6. Contracts and agreements are subject to strikes, fires, accidents or other causes beyond our control.

RETURNED GOODS

No goods will be accepted without a written returned goods authorization issued from Keeney's Customer Service Department. Subject to the terms of any applicable warranty, Keeney will replace defective parts without charge if authorization to return has first been properly granted. Where the nature of the return is other than for defective parts, a 25% handling charge will be assessed. Credit will be issued on authorized returns at invoiced price or current price based on Keeney list as of the date of return, whichever is lower, less any applicable Invoice Allowances.

BROKEN CARTONS

Broken cartons are not allowed for Keeney or Duracraft Plastics items which should be ordered in multiples of the standard pack. Product orders for less than standard packs will be increased to standard carton quantities.

CLAIMS

Subject to the terms of any applicable warranty, Keeney guarantees its products to be free from defects in material and workmanship, and shall replace, free of charge, any parts proving defective in material or workmanship. Damages or charges for labor in repairing or replacing material claimed or asserted by Customer will not be allowed. Credit will be granted at invoiced price or current price based on Keeney list as of the date of claim. All claims for product shortages must be submitted within five (5) days after receipt of shipment in order to be considered.

FREIGHT ALLOWANCE

Any combination of Keeney, Duracraft Plastics, and/or Plumb Pak materials sold with a net invoice total of \$1,500.00 or greater will ship F.O.B. Destination, Freight Prepaid, to one destination within the Continental United States. Shipments outside the Continental United States are shipped prepaid to a Freight Forwarder and expenses to the final destination are the responsibility of the customer. Express Shipments will ship at customer's expense, Prepay and Charge. The Keeney Manufacturing Company reserves the right to select carrier, method of shipment, and to ship at the lowest available rate. The Keeney Manufacturing Company will ship via a customer requested carrier, with expenses in excess of the lowest available rate, Prepay and Charge at the customer's expense. Title passes on delivery to carrier.

ADDITIONAL CHARGES

Federal or state taxes now and hereafter for which we may become liable shall be charged to, and paid by the buyer.

The Keeney Manufacturing Company & Duracraft Plastics



1170 Main Street, Newington, CT 06111
995 South McCarran Blvd #101, Sparks, NV 89431
Best Friend Court, Norcross, GA 30071



Telephone: (860) 666-3342 • Toll Free: 1-800-243-0526 • Fax (860) 665-0374

Product Catalog #106 Copyright ©2006

THE KEENEY MANUFACTURING COMPANY

The Keeney Manufacturing Company, DBA Keeney Mfg., Duracraft Plastics, Plumb Pak and United Plumbing Technologies