



# SLOPE CEILING IC HOUSING

Project: \_\_\_\_\_

Fixture Type: \_\_\_\_\_

Location: \_\_\_\_\_

Contact/Phone: \_\_\_\_\_

STANDARD SLOPE:

2/12 to 6/12 PITCH (9° to 27°)

INCANDESCENT LAMPS

**IC926**

## PRODUCT DESCRIPTION

Slope ceiling IC Housing "Air-Loc"® • Energy efficient, sealed inner housing • Double wall housing construction • Can be completely covered with insulation • When used with Air-Loc Gasket (see accessories), stops infiltration and exfiltration of air, reducing heating and cooling costs.

## PRODUCT SPECIFICATIONS

**Lamp** Lamp ratings based on trim selected – see reverse.

**Socket** Medium base porcelain with nickel-plated copper screw shell • Adjustable to position lamp perpendicular to floor.

**Trims** Trim selection shown on reverse.

**Labels** U.L. listed for through-branch wiring, damp locations and IP • Product thermally protected against improper use of lamps • Union made • UL Listed/CSA certified • Trim No. 610 is wet location approved for covered ceiling applications.

**Testing** All reports are based on published industry procedures; field performance may differ from laboratory performance.

Product specifications subject to change without notice.

## INSTALLATION

**Real Nail 3 Bar Hangers** Telescoping, patent-pending Real Nail 3 system permits quick placement of housing anywhere within 24" O.C. joists or suspended ceilings • Integral T-bar notch and clip secures housing in suspended ceiling grid – no accessory clips required • 24" expansion stop allows quick placement of fixture in standard grid spacing • Bars scored in two locations for fast, clean breaking, allowing housing installation in tight applications • Bars captive to mounting frame • Edge-mounted for extra strength • Captive bugle-headed ring shank nail for quick one-step installation and easy removal with claw hammer for fixture relocation • Quick-Loc slot and oversized locking set screw lock fixture in position • Bar hanger foot contoured to align to bottom of construction joist • Alternate mounting holes included.

**Junction Box** Pre-wired junction box provided with (5) 1/2" and (1) 3/4" knockouts, (4) Non-metallic sheathed cable connectors and ground wire, U.L. listed/CSA certified for through-branch wiring, maximum 8 No. 12 AWG 90° C branch circuit conductors (4 in, 4 out) • Junction box provided with removable access plates • Knockouts equipped with pryout slots.

**Mounting Frame** 22-gauge die-formed galvanized steel mounting frame • Rough-in section (junction box, mounting frame, housing and bar hangers) fully assembled for ease of installation.

**Housing** IC housing, .032" aluminum sealed for Air-Loc Compliance • Access door for junction box accessibility • Inner housing is vertically adjustable to accommodate up to a 1" ceiling thickness • Designed to fit into 2 x 8 construction.

## PRODUCT CODES

Catalog Number	Input Voltage	Lamp Rating (max.)
IC926	120V	A19/MR16/BR30/R30/PAR30/PAR30L/PAR38

## DIMENSIONS

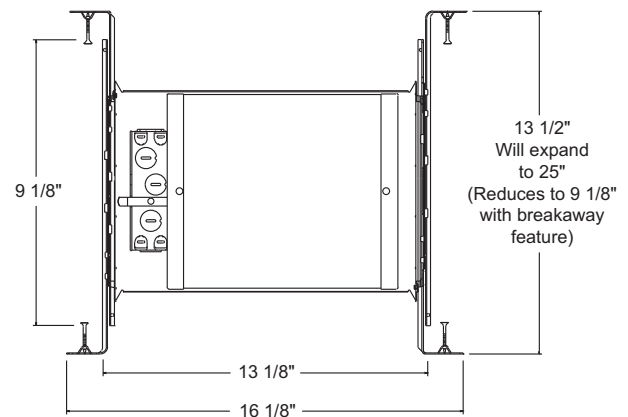
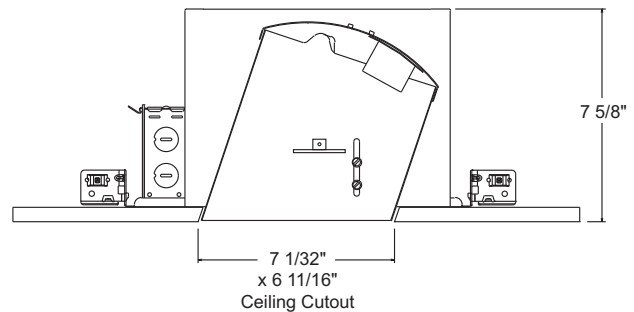

## ACCESSORIES

Catalog No.	Description
ALG926	Air-Loc Gasket

To order, specify catalog number.

# SLOPE CEILING IC HOUSING







STANDARD SLOPE:

2/12 to 6/12 PITCH (9° to 27°)

INCANDESCENT LAMPS

## IC926

### TRIMS/LAMPS

	Cat. No.	Description	Max. Lamp Rating
	<b>610B-WH</b> ◆	Lensed Abalite Black Baffle	50W PAR30
	<b>610W-WH</b> ◆	Lensed Abalite White Baffle	
	<b>612C-WH</b>	Multiplier Cone - Clear Alzak®	75W PAR30, 90W PAR38, 65W BR30
	<b>612G-WH</b>	Multiplier Cone - Gold Alzak®	
	<b>612B-WH</b>	Multiplier Cone - Black Alzak®	
	<b>612HZ-WH</b>	Multiplier Cone - Haze	
	<b>612HZ-SC</b>	Multiplier Cone - Haze	
	<b>612W-WH</b>	Multiplier Cone - White	
	<b>614B-WH</b>	Downlight with Black Baffle	90W PAR38
	<b>614B-SC</b>	Downlight with Black Baffle	
	<b>614B-ABZ</b>	Downlight with Black Baffle	
	<b>614B-BL</b>	Downlight with Black Baffle	
	<b>614W-WH</b>	Downlight with White Baffle	
	<b>616B-WH</b>	Black Cylinder Spotlight with Black Baffle	60W PAR16
	<b>616W-WH</b>	White Cylinder Spotlight with White Baffle	
	<b>617W-WH</b>	White Spotlight with White Baffle	35W MR16 supplied with magnetic transformer
	<b>619B-WH</b>	Eyeball in Black Baffle	85W BR30
	<b>619W-WH</b>	Eyeball in White Baffle	

Trim Size: 7<sup>5</sup>/<sub>8</sub>" O.D. (except Cat. Nos. 612 and 614 - 7<sup>3</sup>/<sub>8</sub>" O.D.).

Trim Finish: ABZ - Classic Aged Bronze, BL - Black, GP - Graphite,

PW - Plastic White (Polycarbonate material shower trim), SC - Satin Chrome, SL - Silver, WH - White.

Note: In Canada when insulation is present, Type IC fixtures must be used.

◆ UL Listed for use in wet location.