



# Owner's Manual

## TABLE OF CONTENTS

	PAGE
A NOTE ABOUT SAFETY .....	2
GENERAL .....	2
PART NAMES .....	3
WIRELESS REMOTE CONTROL .....	4
REMOTE CONTROL .....	6
REMOTE CONTROL FUNCTIONS .....	7
CLEANING, MAINTENANCE, AND TROUBLESHOOTING .....	12
TROUBLESHOOTING .....	14

### NOTE TO EQUIPMENT OWNER:

Please read this Owner's Information Manual carefully before installing and using this appliance and keep this manual for future reference.

For your convenience, please record the model and serial numbers of your new equipment in the spaces provided. This information, along with the installation data and dealer contact information, will be helpful should your system require maintenance or service.

#### UNIT INFORMATION

Model # \_\_\_\_\_

Serial # \_\_\_\_\_

#### INSTALLATION INFORMATION

Date Installed \_\_\_\_\_

#### DEALERSHIP CONTACT INFORMATION

Company Name: \_\_\_\_\_

Address: \_\_\_\_\_

Phone Number: \_\_\_\_\_

Technician Name: \_\_\_\_\_

## A NOTE ABOUT SAFETY

Any time you see this symbol  in manuals, instructions and on the unit, be aware of the potential for personal injury. There are three levels of precaution:

**DANGER** identifies the most serious hazards which will result in severe personal injury or death.

**WARNING** signifies hazards that could result in personal injury or death.

**CAUTION** is used to identify unsafe practices which could result in minor personal injury or product and property damage.

**NOTE** is used to highlight suggestions which will result in enhanced installation, reliability, or operation.

 **WARNING**

**PERSONAL INJURY, DEATH AND / OR PROPERTY DAMAGE HAZARD**

Failure to follow this warning could result in personal injury, death or property damage.

Improper installation, adjustment, alteration, service, maintenance, or use can cause explosion, fire, electrical shock, or other conditions which may cause personal injury or property damage. Consult a qualified installer, service agency, or your distributor or branch for information or assistance. The qualified installer or service agency must use factory-authorized kits or accessories when modifying this product.

Read and follow all instructions and warnings, including labels shipped with or attached to unit before operating your new air conditioner.

## GENERAL

The high wall fan coil unit provides quiet, maximum comfort. In addition to cooling and/or heating, the high wall fan coil unit matched with an outdoor condensing unit filters and dehumidifies the air in the room to provide maximum comfort.

**IMPORTANT:** The high wall fan coil unit should be installed by authorized personnel only; using approved tubing and accessories. If technical assistance, service or repair is needed, contact the installer.

The high wall fan coil unit can be set up and operated from the remote control (provided). **If the remote is misplaced, the system can be operated from the “Auto” setting on the unit.**

### Operating Modes:

The high wall fan coil unit has five operating modes:

- FAN Only
- AUTO
- HEATING (heat pump models only)
- COOLING
- DEHUMIDIFICATION (DRY)

#### Fan Only

In the **FAN Only** mode, the system filters and circulates the room air without changing room air temperature.

#### Auto

In the **AUTO** mode, the system automatically cools or heats the room according to the user-selected set point. mode, the system automatically cools or heats the room according to the user-selected set point.

**NOTE: AUTO mode is recommended for use on Single Zone applications only. Using AUTO changeover on multi-zone applications could set an indoor unit to STANDBY mode, indicated with two dashes (--) on the display, which will turn off the indoor unit until all the indoor units are in the same mode (COOLING or HEATING). HEATING is the system's priority mode. Simultaneous HEATING and COOLING is not allowed.**

#### Heating

In the **HEATING** mode, the system heats and filters the room air.

#### Cooling

In the **COOLING** mode, the system cools, dries and filters the room air.

#### Dehumidification (DRY)

In the **DEHUMIDIFICATION** mode, the system dries, filters and slightly cools the room air temperature. This mode prioritizes air dehumidification but it does not take the place of a dehumidifier.

### Wireless Remote Control

The remote control transmits commands to set up and operate the system. The control has a window display panel that displays the current system status. The control can be secured to a surface when used with the mounting bracket provided.

### Wired Remote Control (Optional)

Refer to the Wired Controller manual.

### 24V Interface (Optional)

Allows the control of the Ductless System with a third party thermostat.

## PART NAMES

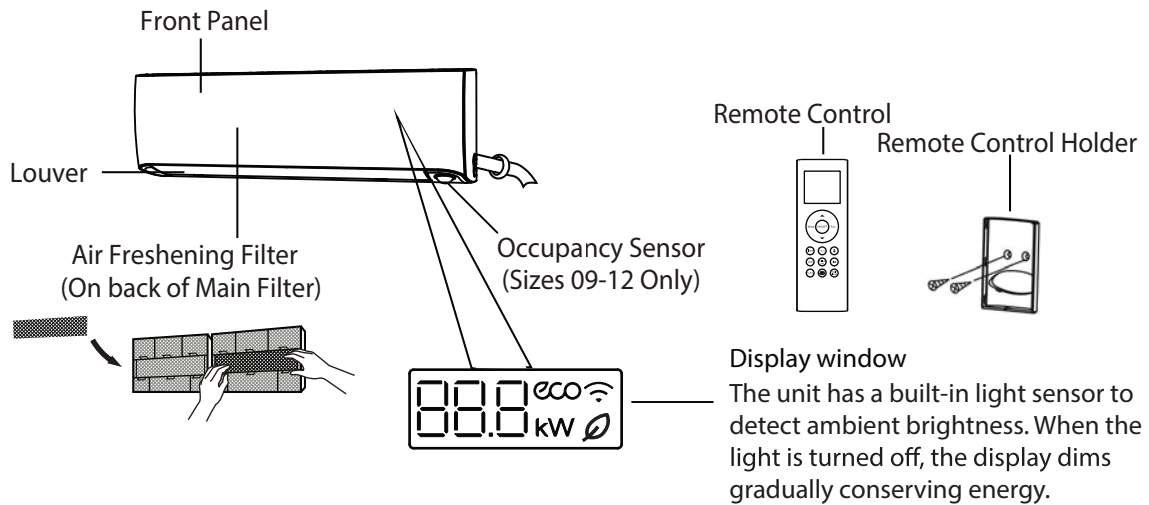

**Fig. 1 — Indoor Unit**

## Indoor Unit Display Indicator

"88 8" Displays temperature, operation feature and error codes:

"07" for 3 seconds when:

- TIMER ON is set
- FRESH, SWING, TURBO, or SILENCE features are turned on

"0F" for 3 seconds when:

- TIMER OFF is set
- FRESH, SWING, TURBO, or SILENCE features are turned off

"dF" when defrosting

"SC" when unit is self-cleaning

"FP" when 46°F(8°C) or 54°F(12°C) heating mode is turned on

"" when the fresh feature is turned on (Not available on these systems)

"" when the ECO feature is activated

"" when the Wi-Fi® wireless control feature is activated

"kW" indicates the current operation power (Not available on these systems)

Display Code  
Legend

In Fan mode, the unit displays the room temperature.

In other modes, the unit displays your temperature setting.

Press LED on the remote control 7 times continuously within 3 minutes until AP appears on the display of the indoor unit to turn ON the Wi-Fi® signal.

Refer to the Wi-Fi® installation and operation instructions for details on how to activate and use the integrated Wi-Fi® functionality.

**Fig. 2 — Indoor Unit Display Indicator**

# WIRELESS REMOTE CONTROL

Before you begin using your new air conditioner, make sure to familiarize yourself with the remote control. The following is a brief introduction to the remote control.

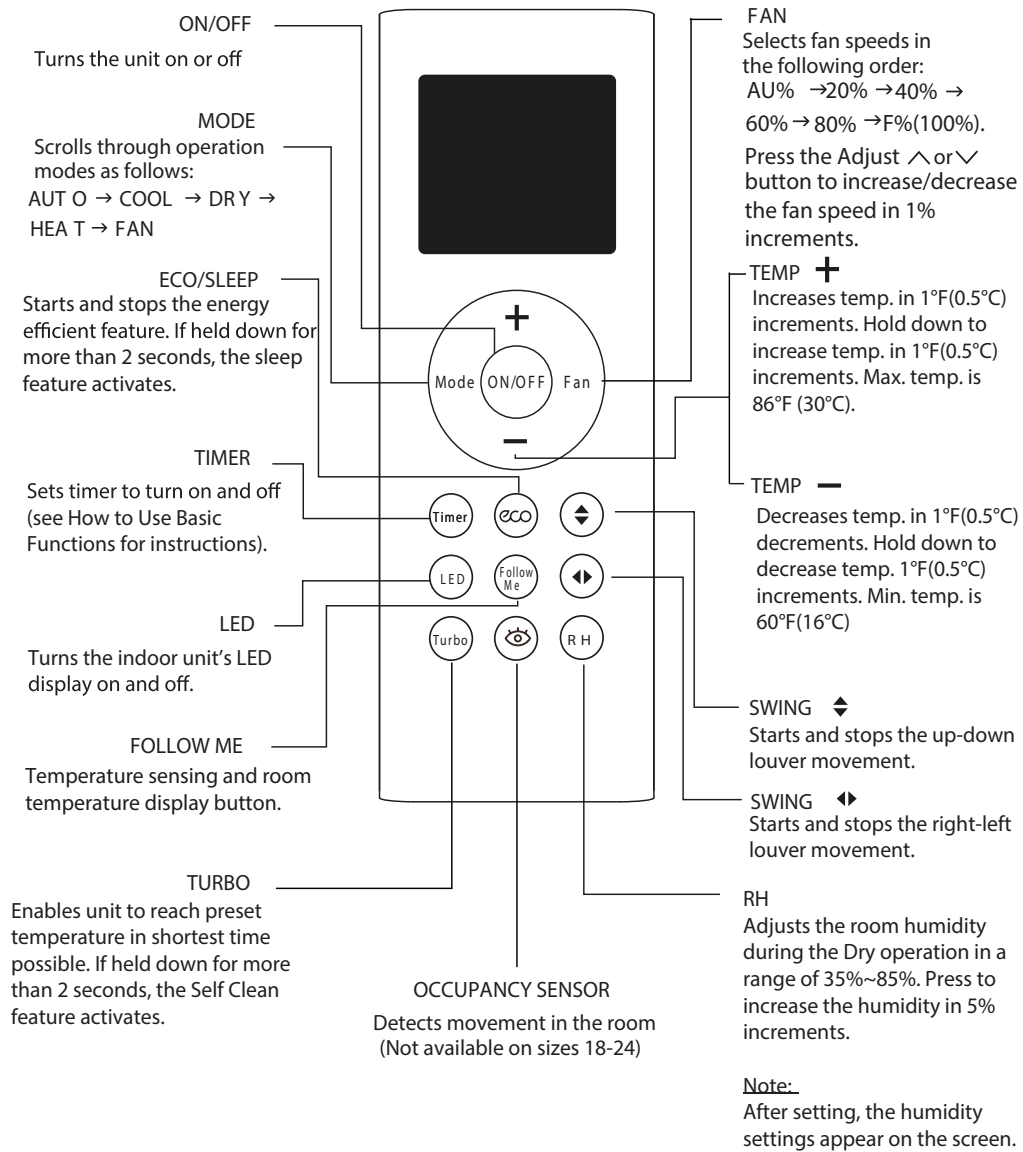

**Fig. 3 —Remote Controller**

**NOTE:** For advanced functions, refer to the RG66B9(2H)/BGEFU1 Wireless Remote Controller's service manual.

# Remote LCD Screen Indicators

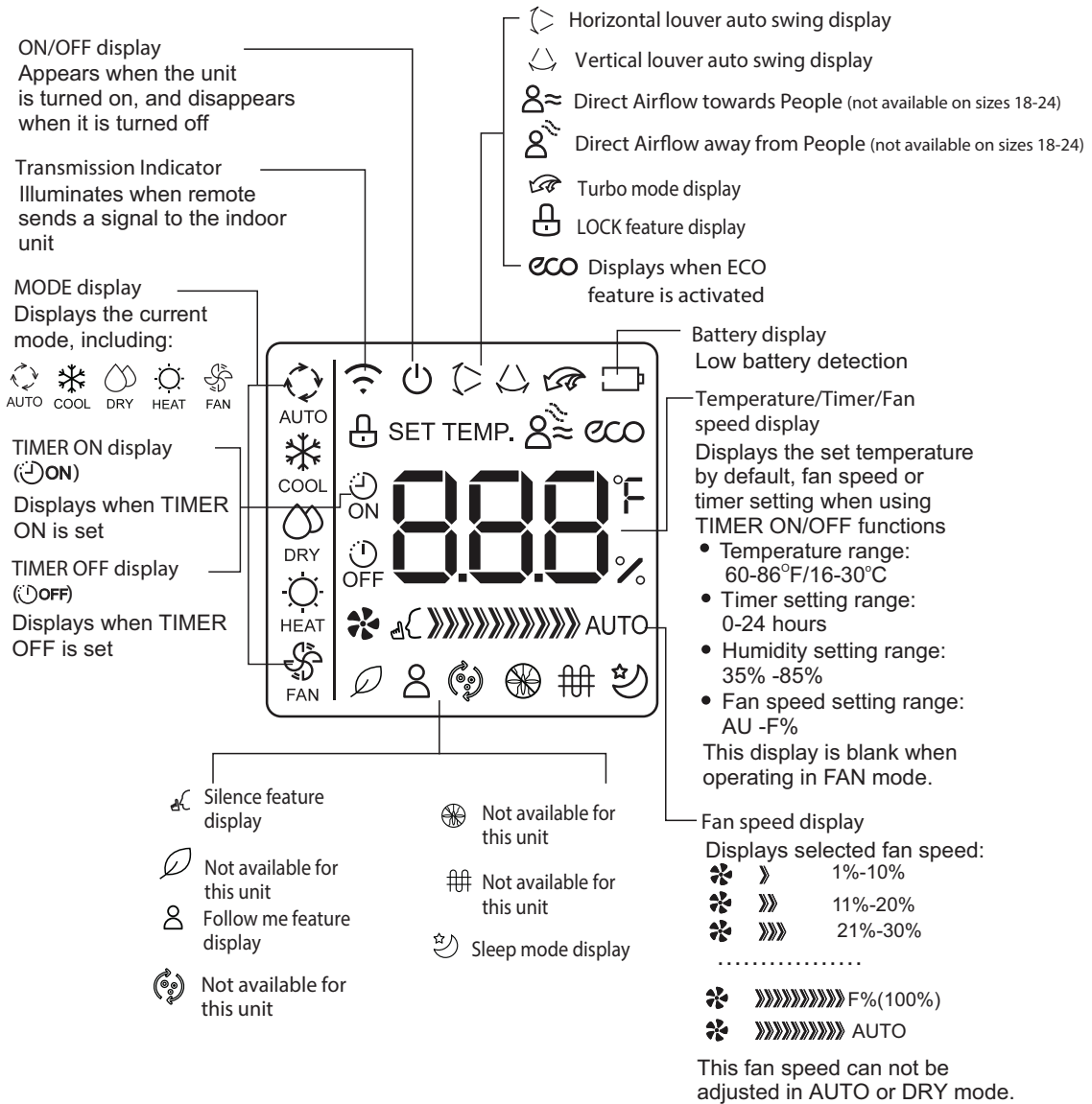

**Fig. 4 —Unit Display**

## REMOTE CONTROL

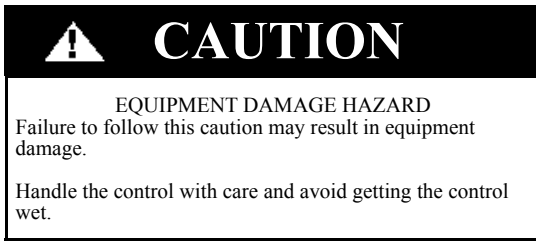

**IMPORTANT:** The remote control can operate the unit from a distance of up to 26 ft. (8 m) as long as there are no obstructions. When the timer function is used, the remote control should be kept in the vicinity of the fan coil (within 26 ft. / 8 m).

The remote control can perform the following basic functions:

- Turn the system **ON** and **OFF**
- Select operating mode
- Adjust room air temperature set point and fan speed
- Adjust right-left airflow direction

Refer to the *Remote Control Function* section for a detailed description of all the capabilities of the remote control.

### Battery Installation

Two AAA 1.5v alkaline batteries (included) are required for operation of the remote control.

### To install or replace batteries:

1. Slide the back cover off the control to open the battery compartment.
2. Insert the batteries. Follow the polarity markings inside the battery compartment.
3. Replace the battery compartment cover.

### NOTES:

1. When replacing batteries, do not use old batteries or a different type battery. This may cause the remote control to malfunction.
2. If the remote is not going to be used for several weeks, remove the batteries. Otherwise, battery leakage may damage the remote control.
3. The average battery life under normal use is about 6 months.
4. Replace the batteries when there is no audible beep from the indoor unit or if the Transmission Indicator fails to light.
5. When batteries are removed, the remote control erases all programmed settings. The control must be reprogrammed after insertion of new batteries.

## Remote Control Operation - Quick Start

**NOTE:** When transmitting a command from the remote control to the unit, be sure to point the control toward the right side of the unit. The unit confirms receipt of a command by sounding an audible beep.

1. Turn the unit on by pushing **ON/OFF**.
2. If there is a preference for °C rather than °F (default), press and hold the **+** and **-** temperature set point buttons together for approximately 3 seconds.
3. Select the desired mode by pushing **MODE**.



**Fig. 5 —Modes**

4. Select the temperature set point by pointing the control toward the unit and pressing the increase/decrease temperature set point buttons until the desired temperature appears on screen.
5. Press **FAN** to select the desired fan speed.

**NOTE:** If the unit is operating in **DRY** or **AUTO** mode, the fan speed will be automatically set.

6. Set the airflow direction. When the unit is turned on, the louvers default to the cooling or heating position. The user can adjust the louver position or initiate continuous louver movement by pressing **UP-DOWN Louver SWING**. See Fig. 3 — on page 4).

### Manual Control

If the remote control is lost, damaged, or the batteries are exhausted, **MANUAL CONTROL** can be used to run the unit. When **MANUAL CONTROL** is pressed once, the **AUTO** mode takes affect (heat or cool). When this button is pressed twice, the system enters the **TEST** mode and runs for 30 minutes in the **COOLING** mode (it will run in the **AUTO** mode afterward). When pressed three times, the system turns off.

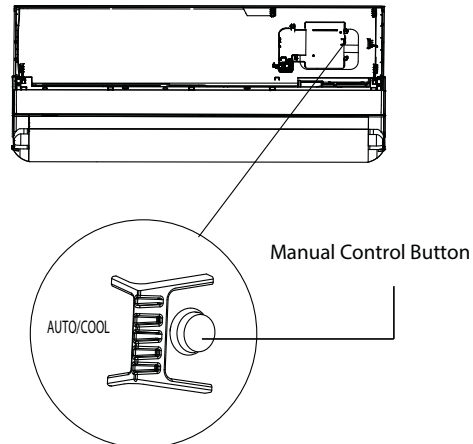

**Fig. 6 —Manual Control Button**

The set conditions of manual operation are as follows:

- Preset set point: 76°F (24°C)
- Fan speed: **AUTO**
- Discharge air direction: Pre-set position based on operation in “Cool” or “Heat” mode.

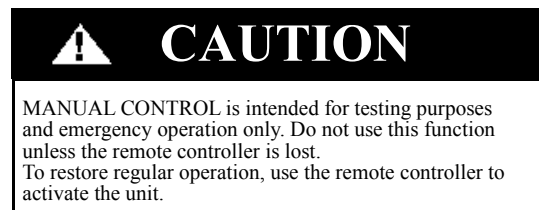

# REMOTE CONTROL FUNCTIONS

## Pressing ON/OFF

When the air conditioner is not in operation, the remote control displays the last set point and mode.

- Press **ON/OFF** to start the unit.
  - The unit starts in the last operating mode and set point. The **ON/OFF** indicator appears.
- Press **ON/OFF** to stop the unit.
  - All the indicator lights on the unit go out, and the remote control displays the set point and mode.

**NOTE: If ON/OFF is pressed too soon after a stop, the compressor will not start for 3 to 4 minutes due to the inherent protection against frequent compressor cycling. The unit only emits an audible beep when the signals are received correctly.**

## Selecting an Operating Mode

Use **MODE** to select one of the available modes.



**Fig. 7 —Operating Modes**

## AUTO Mode

In **AUTO** mode, the unit automatically selects the **COOL**, **FAN**, **HEAT** or **DRY** mode based on the set temperature.

1. Press **MODE** to select **AUTO** mode.
2. Set your desired temperature using Temp **+** or Temp **-**.
3. Press **ON/OFF** to start the unit.

**NOTE: FAN SPEED can not be set in AUTO mode.**

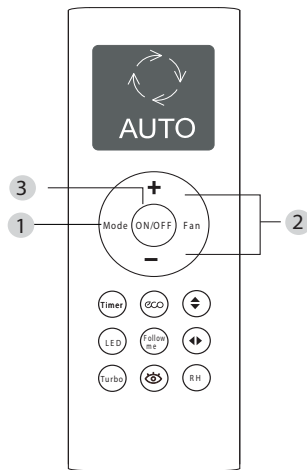

**Fig. 8 —Auto Mode**

## COOL Mode

1. Press **MODE** to select the **COOL** mode.
2. Set your desired temperature using Temp **+** or Temp **-**.
3. Press **FAN** to select the fan speed in a range of Au%-F% (Auto to Full speed), in conjunction with Temp **+** or Temp **-**.
4. Press **ON/OFF** to start the unit.

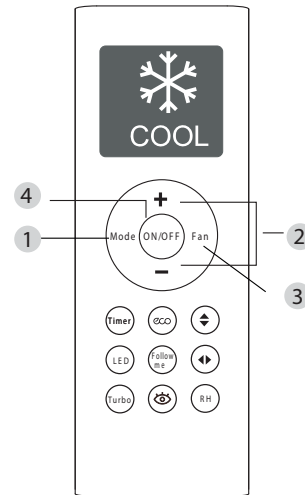
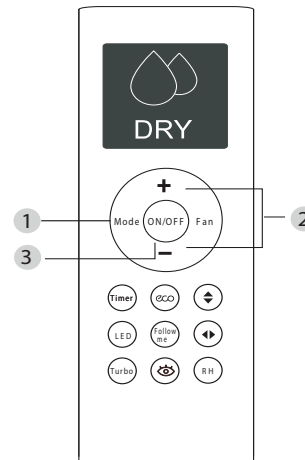

**Fig. 9 —Cool Mode**

## DRY Mode (Dehumidifying)

1. Press **MODE** to select the **DRY** mode.
2. Set your desired temperature using Temp **+** or Temp **-**.
3. Set the desired room humidity using **RH** in a range of 35%~85%.
4. Press **ON/OFF** to start the unit.

**NOTE: FAN SPEED can not be set in DRY mode.**

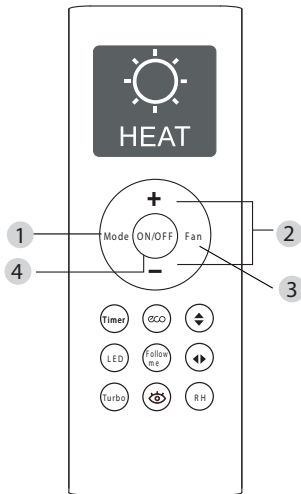

**Fig. 10 —Dry Mode**

## Heat Mode

1. Press **MODE** to select the **HEAT** mode.
2. Set your desired temperature using Temp **+** or Temp **-**.
3. Press **FAN** to select a fan speed in a range of Au%-F% (Auto to Full speed), in conjunction with Temp **+** or Temp **-**.
4. Press **ON/OFF** to start the unit.

**NOTE:** As the outdoor temperature drops, the unit's **HEAT** function performance may be affected. In such instances, we recommend using this air conditioner in conjunction with an additional heating appliance.

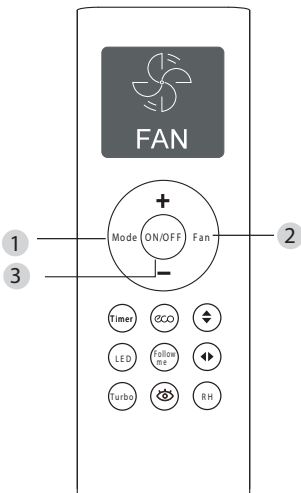

**Fig. 11 —Heat Mode**

## FAN Mode

1. Press **MODE** to select the **FAN** mode.
2. Press **FAN** to select a fan speed in a range of Au%-F% (Auto to Full speed), in conjunction with Temp **+** or Temp **-**.
3. Press **ON/OFF** to start the unit.

**NOTE:** The temperature cannot be set while in **FAN** mode. As a result, the remote controls LCD screen will not display the temperature.



**Fig. 12 —Fan Mode**

**NOTE:** Do not move the louver by hand. This will set the louver out of sync. If this occurs, turn off the unit and unplug it for a few seconds, then restart the unit. This resets the louver.

## Setting the Room Temperature Set Point

Press the increase temperature set point **+** and decrease **-** buttons to raise or lower the temperature. The unit confirms the signal receipt with a beep and the value of the set temperature appears on the display and changes accordingly. The temperature can be set between 62°F (17°C) and 86°F (30°C) in increments of 1°F or 1°C.

**NOTE:** In the **COOLING** mode, if the temperature selected is higher than the room temperature, the unit will not start. The same applies for the **HEATING** mode if the selected temperature is lower than the room temperature.

## Selecting the Fan Speed

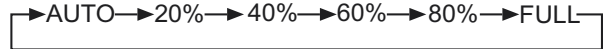

**Fig. 13 —Fan Speeds**

The fan speed can be selected by pressing **FAN**. Press Adjust **+** or **-** to increase/decrease the fan speed in 1% increments.

**NOTE:** When the unit is on, the fan runs continuously in **COOLING** or **HEATING**. When in the **HEATING** mode, there may be situations where the fan will slow down or shut off to prevent cold blow.

## Up-Down Louver Position

While the unit is on, use **SWING**  $\updownarrow$  (up-down airflow) to set the airflow direction.

1. Press **SWING**  $\updownarrow$  (up-down airflow) on the remote control once to activate the louver. Each time you press **SWING**  $\updownarrow$  the louver adjusts by 6 degrees. Press **SWING**  $\updownarrow$  until the preferred direction is reached (see Fig. 14).

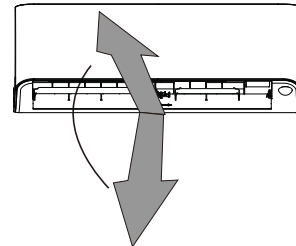

**Fig. 14 —Up-Down Louver Position**

2. To swing the louver up and down continuously, press and hold **SWING**  $\updownarrow$  (up-down airflow) for 2 seconds. Press **SWING**  $\updownarrow$  again to stop the automatic function.

## Right - Left Louver Position

While the unit is on, press **SWING**  $\leftrightarrow$  (right-left airflow) to set the airflow direction.

1. Press **SWING**  $\leftrightarrow$  (right-left airflow) on the remote control once to activate the louver. Every time you press **SWING**  $\leftrightarrow$  (right-left airflow), the louver adjusts by 6 degrees. Press **SWING**  $\leftrightarrow$  until the preferred direction is reached (see Fig. 15).

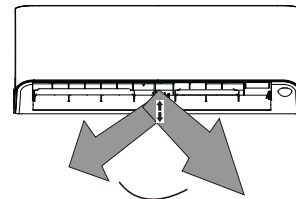

**Fig. 15 —Right-Left Louver Positions**

2. To swing the louver left and right continuously, press and hold **SWING**  $\leftrightarrow$  (right-left airflow) for 2 seconds. Press again to stop the automatic function.



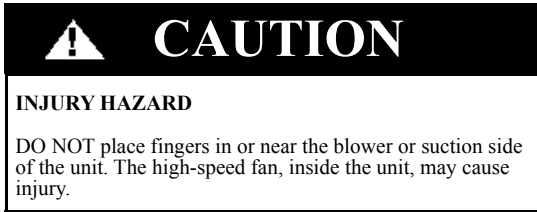

### Timer Function

**TIMER ON** (to start the unit) and **TIMER OFF** (to stop the unit) can be used separately or together.

#### Timer ON only

This function allows the unit to start automatically at the set time. The **TIMER ON** function can be set while the unit is on or off.

1. Press **TIMER** and the **TIMER ON** indicator appears and flashes. By default, the last user set time period along with the letter “h” (indicating hours) appears on the display.

**NOTE: This number indicates the amount of time after the current time that you want the unit to turn on. For example, if you set TIMER ON for 2.5 hours, “2.5h” appears on the display, and the unit turns on after 2.5 hours.**

2. Press **TEMP +** or **TEMP -** repeatedly to set the time when you want the unit to turn on.
3. Wait 3 seconds and the **TIMER ON** function activates. The digital display on your remote controller reverts to the temperature display. The indicator remains on and the function activates.

#### Timer OFF only

This function allows the unit to stop automatically at the set time. The timer can be set while the unit is on or off.

1. Press **TIMER**, the **TIMER OFF** indicator appears and flashes. By default, the last user set time period and an “h” (indicating HOURS) appears on the display.

**NOTE: This number indicates the amount of time after the current time that you want the unit to turn off. For example, if you set TIMER OFF for 5 hours, “5.0” appears on the display, and the unit turns off after 5 hours.**

2. Press **TEMP +** or **TEMP -** repeatedly to set the time when you want the unit to turn on.
3. Wait 3 seconds and the **TIMER OFF** function activates. The digital display on the remote controller reverts to the temperature display. The indicator remains on and the function activates.

### TIMER ON and TIMER OFF

Use both functions to program the unit to turn on and shut off at specified times.

- a. Set **TIMER ON** as previously described.
- b. Set **TIMER OFF** as previously described. The unit starts automatically at the set **TIMER ON** and turns off at the set **TIMER OFF** .

**EXAMPLE: Setting the unit to turn after 6 hours, operate for 2 hours then turn off (see Fig. 16).**

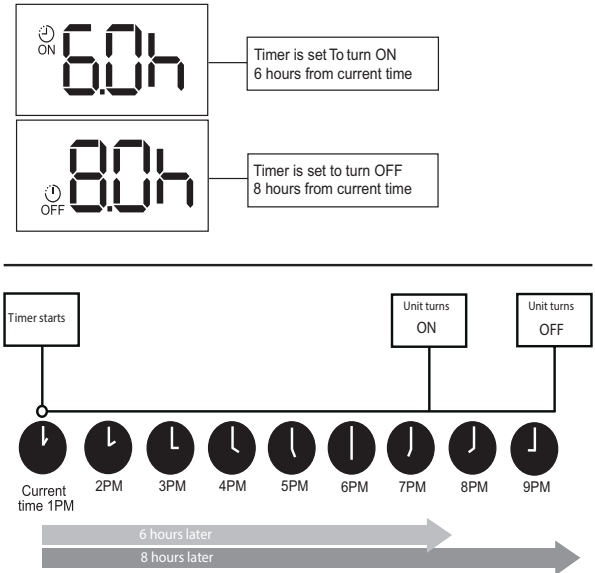

**Fig. 16 —Set both Timer ON and Timer OFF**

## ECO Mode

**NOTE: This function is only available under the COOLING mode.**

Use to enter the **ENERGY EFFICIENT** mode. Under the **COOLING** mode, press **ECO** and the remote controller adjusts the temperature automatically to 75°F (24°C) and selects the **AUTO** fan speed to conserve energy (only if the set temperature is less than 75°F (24°C)). If the set temperature is above 75°F (24°C), press **ECO**, the fan speed switches to **AUTO**, and the set temperature remains the same.

## Sleep Mode

**SLEEP** mode is used to conserve energy while sleeping (and do not need the same temperature settings to stay comfortable) Sleep mode can be used when the unit is in the **COOL**, **HEAT** or **AUTO** mode only.

## Cool Mode

Press **ECO** for 2 seconds. After 1 hour the set point raises by 2°F (1°C). After another hour, the set point raises by another 2°F (1°C) and the fan runs in a low speed. The unit shuts off 6 hours after setting the **SLEEP** mode. The **SLEEP** mode cancels if either “**Mode**”, “**Fan**”, or “**On/Off**” on the remote control is pressed.

## Heat Mode

Same as the **COOLING** mode however the set points are lowered by 2 °F (1°C).

## Follow Me Mode

The **Follow ME** function enables the remote controller to measure the temperature at its current location and send this signal to the air conditioner every 3 minutes. When using the **AUTO**, **COOL**, or **HEAT** modes, measuring ambient temperature from the remote control (instead of from the indoor unit itself) enables the air conditioner to optimize the temperature around the user and ensure maximum comfort.

**NOTE: This function is not available for DRY or FAN modes.**

## Turbo Mode

Use the **TURBO** mode to cool or heat the room rapidly. Press **TURBO**. An audible “beep” is heard if the indoor unit supports this function. The fan runs on super high speed. **TURBO** mode terminates automatically 20 minutes after pressing **TURBO**. The mode can be terminated immediately by pressing **TURBO** again. When the **TURBO** mode is terminated, the unit reverts to the original setting.

## Relative Humidity

The relative humidity can be adjusted in 5% increments in a range of 35%–85% during **DRY** mode by pressing **RH** on the wireless remote controller.

## Occupancy Sensor (Only sizes 9-12)

The system may be controlled intelligently under **OCCUPANCY SENSOR** mode. The **OCCUPANCY SENSOR** can detect activity in the room and adjust the horizontal angle of airflow to implement the **Direct Airflow towards People** feature and **Direct Airflow Away from People** feature.

When the **OCCUPANCY SENSOR** does not detect movement for 30 minutes, the unit automatically lowers the frequency to save energy. The compressor operates in a lower frequency if the unit does not detect movement in the room for 120 minutes, and resumes automatically when the unit detects movement again, which helps saving energy. However, this function is disabled when the light sensor detects the light is turned off. When the room temperature is between 90°F to 104°F (32°C to 40°C), the **Direct Airflow towards People** feature is disabled.

While the unit is on, press **OCCUPANCY SENSOR** on the remote control to select the **Direct Airflow towards People** feature or **Direct Airflow Away from People** feature and the **AUTO SWING** feature activates.

**NOTE: The Direct Airflow towards People feature is only available for a single person area. The OCCUPANCY SENSOR function will stop if the ON/OFF, Mode, and Swing buttons are pressed while under the 46°F(8°C) HEATING mode or SELF CLEAN mode.**

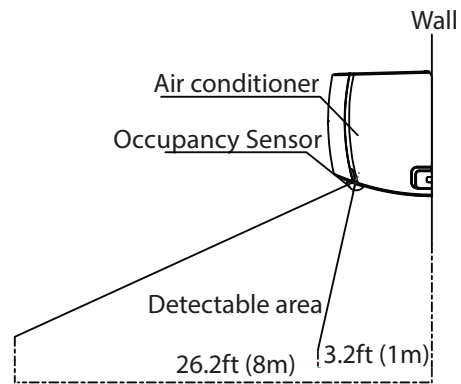

**Fig. 17 —Occupancy Sensor Detectable Range**

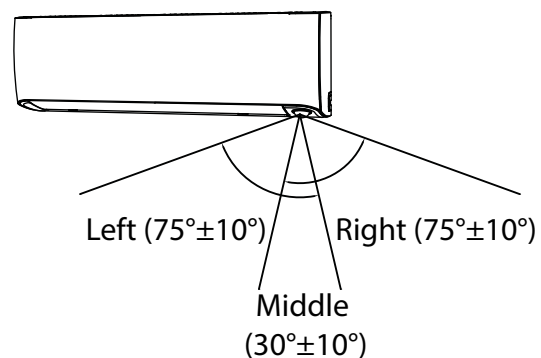

**Fig. 18 —Occupancy Sensor Detectable Range**

## Silence Mode

To initiate the **SILENCE** function, hold down **FAN** for 2 seconds to activate or cancel the **SILENCE** mode. Due to the low frequency operation of the compressor, it may result in insufficient cooling and heating capacity (only available on air conditioners with the **SILENCE** feature).

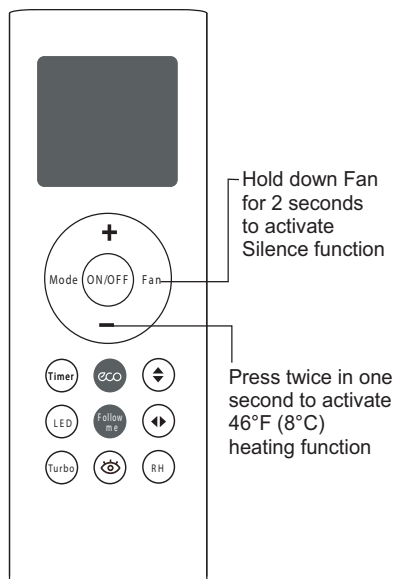

Fig. 19 —Silence

## Freeze Protection Mode

When the air conditioner operates under the **HEATING** mode with the set temperature of 60°F (16°C), press **TEMP** twice in one second to activate the 46°F(8°C) heating function. The unit operates at a set temperature of 46°F(8°C). The indoor unit display shows **FP**. For some units, pressing this button activates the 54°F(12°C) heating feature, please refer the air conditioner's owner's manual.

**NOTE: This function is only available in the HEATING mode. Under this function, the unit operates at a high fan speed and the coil temperature automatically sets to 46°F (8°C) or 54°F (12°C). This mode can also be deactivated by pressing "On/Off", "Mode", "Fan", or either "TEMP".**

## Lock Function

Press **TURBO** and **RH** simultaneously for one second to lock or unlock the keyboard.

## Self Clean Mode

Press and hold **TURBO** for 2 seconds to activate the **SELF CLEAN** mode. Under this mode, the air conditioner automatically cleans and dries the evaporator. The cleaning cycle takes 16 minutes, after which the unit turns off automatically. Press **CLEAN** in the middle of the cycle to cancel the operation and turn off the unit. This function can be activated only in the **COOL** or **DRY** mode.

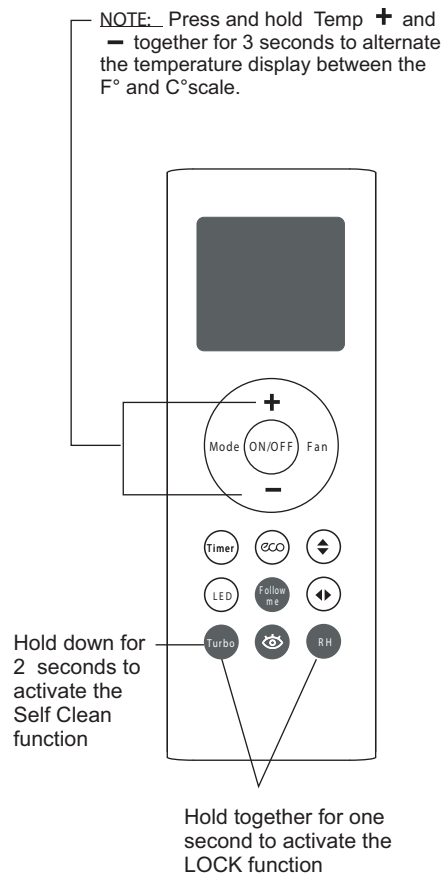

Fig. 20 —Remote Controller

## LED Light

Press **LED** to turn the display light on and off.

## Resetting the Remote Control

If the batteries in the remote control are removed, the current settings will be canceled and the control returns to the initial settings and will be in standby mode. Press **ON/OFF** to activate it.

## Time Delay

If **ON/OFF** is pressed too soon after a stop, the compressor will not start for 3 to 4 minutes due to the inherent protection against frequent compressor cycling. The unit only emits an audible beep when the signals are received correctly.

## Heating Features

If the unit is in the heating mode, there is a delay when the fan starts. The fan starts only after the coil is warmed up to prevent cold blow.

## Auto Defrost Operation

In **HEATING** mode, if the outdoor coil is frosted, the indoor fan and outdoor fan turns off while the system removes the frost on the outdoor coil. The system automatically reverts to normal operation when frost is removed from the outdoor unit.

## Auto Start

If the power fails while the unit is operating, the unit stores the operating condition, and it will start operation automatically under those conditions when the power is restored.

## Refrigerant Leakage Detection

The indoor unit displays "**EC**" when it detects a refrigerant leak.

# CLEANING, MAINTENANCE, AND TROUBLESHOOTING

**⚠ CAUTION**

**ELECTRICAL SHOCK HAZARD**  
Failure to follow this caution may result in personal injury or death.  
Always turn off power to the system before performing any cleaning or maintenance to the system. Turn off the outdoor disconnect switch located near outdoor unit. Be sure to disconnect indoor unit if on a separate switch.

**⚠ CAUTION**

**EQUIPMENT DAMAGE/OPERATION HAZARD**  
Failure to follow this caution may result in equipment damage or improper unit operation.  
Operating the system with dirty air filters may damage the indoor unit and could cause reduced cooling performance, intermittent system operation, frost build-up on indoor coil or blown fuses.

## Periodic Maintenance

Periodic maintenance is recommended to ensure proper operation of the unit. Recommended maintenance intervals may vary depending on the installation environment, e.g., dusty zones, etc (see Table 1 on page 14).

**⚠ CAUTION**

**CUT HAZARD**  
Failure to follow this caution may result in personal injury. The coil fins are very sharp. Use caution when cleaning. Always wear safety protection.

**⚠ CAUTION**

Only use a soft, dry cloth to wipe the unit clean. If the unit is especially dirty, use a cloth soaked in warm water to wipe clean. Do not use chemicals or chemically treated cloths to clean the unit. Do not use benzene, paint thinner, polishing powder or other solvents to clean the unit. They can cause the plastic surface to crack or deform. Do not use water hotter than 104°F (40°C) to clean the front panel. This can deform or discolor the panel.

## Cleaning the Coil

Clean the coil at the beginning of each cooling season, or when necessary. Use a vacuum cleaner or a long-bristle brush to avoid damage to the coil fins.

## Air Filters

Remove and clean the air filters once a month. A clogged air conditioner can reduce the cooling efficiency of your unit, and can also be bad for your health.

**NOTE: If air filters show signs of excessive wear or are torn, they must be replaced. Contact your local dealer for replacement filters.**

1. Lift the front panel of the indoor unit.
2. Press the tab on the end of filter to loosen the buckle, lift it up, then pull it towards you.
3. Pull the filter out.
4. If your filter has a small air freshening filter, un-clip it from the larger filter. Clean the air freshening filter with a hand-held vacuum.
5. Clean the large air filter with warm, soapy water. Be sure to use a mild detergent.
6. Rinse the filter with fresh water, then shake off excess water.
7. Dry it in a cool, dry place, and refrain from exposing it to direct sunlight.
8. When dry, re-clip the air freshening filter to the larger filter, then slide it back into the indoor unit.
9. Close the front panel of the indoor unit.

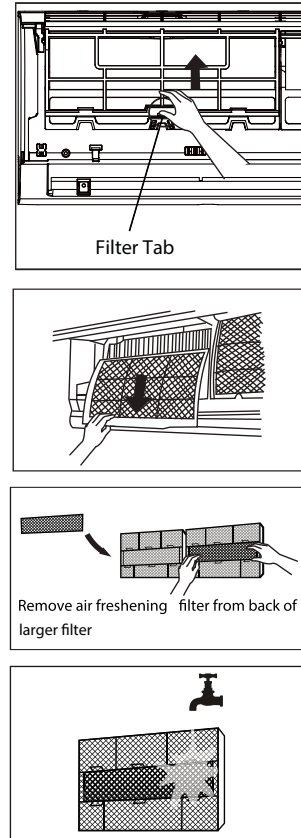

Fig. 21 —Filter Cleaning

**CAUTION**



**EQUIPMENT DAMAGE HAZARD**  
 Failure to follow this caution may result in equipment damage.  
 When cleaning the front panel, do not use water hotter than 105°F (40.6°C) and do not pour water onto the fan coil.  
 Do not use abrasive or petroleum based cleaners as they may damage the front panel.

**Indoor Unit Front Panel**

To clean the front panel on the indoor unit, wipe the outside with a soft, dry cloth.

**Preparing for Extended Shutdown Period**

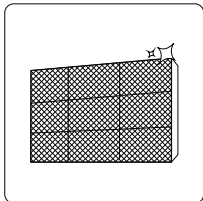
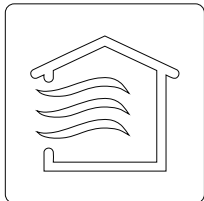

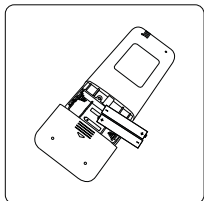

Clean the filters and reposition them in the unit. Operate the unit in **FAN ONLY** mode for 12 hours to dry all internal parts. Turn main power supply off and remove batteries from the remote control.

	
Clean all filters	Turn on FAN function until unit dries out completely
	
Turn off the unit and disconnect the power	Remove batteries from remote control

**Fig. 22 —Extended Shutdown Period Steps**

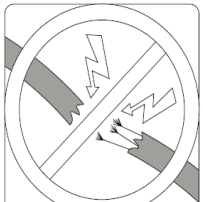
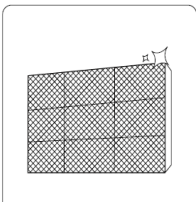
**Pre-Season Inspection**

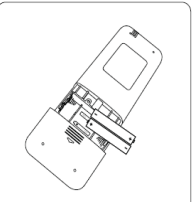
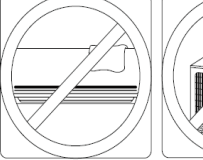
After long periods of non-use, or before periods of frequent use, perform the following steps:

	
Check for damaged wires	Clean all filters
	
Check for leaks	Replace batteries
	

Make sure nothing is blocking all air inlets and outlets

**Fig. 23 —Pre-Season Inspection**

**System Operation Recommendations**

The items outlined in the following list help to assure proper system operation:

- Replace both remote control batteries at the same time.
- Point the remote control toward the unit display panel when transmitting a command.
- Keep doors and windows closed while unit is operating.
- Contact an authorized service representative if a problem arises that cannot be easily resolved.
- Do not perform cleaning or maintenance activities while the unit is on.
- Keep the display panel on the unit away from direct sunlight and heat as this may interfere with remote control transmissions.
- Do not block air intakes and outlets on the indoor or outdoor units.

**Energy Saving Recommendations**

The following recommendations will add greater efficiency to the ductless system:

- Select a comfortable thermostat setting and leave it at chosen setting.
- Avoid continually raising and lowering the setting.
- Keep the filter clean. Frequent cleaning may be necessary depending on indoor air quality.
- Use drapes, curtains or shades to keep direct sunlight from heating the room on very hot days.
- Limit the unit's run time by using the **TIMER** function.
- Do not obstruct the air intake on the front panel.
- Turn on the air conditioning unit before the indoor air becomes too uncomfortable.

# TROUBLESHOOTING

Refer to Table 3 before contacting your local dealer.

**Table 1 — Periodic Maintenance**

INDOOR UNIT	EVERY MONTH	EVERY MONTH	EVERY YEAR
Clean Air Filter*	•		•
Replace Carbon Filter		•	•
Change Remote Control Batteries			
OUTDOOR UNIT	EVERY MONTH	EVERY MONTH	EVERY YEAR
Clean Outdoor Coil from Outside		•	
Clean Outdoor Coil from Inside†			•
Blow Air Over Electric Parts†			•
Check Electric Connection Tightening†			•
Clean Fan Wheel†			•
Check Fan Tightening†			•
Clean Drain Pans†			•

\* Increase frequency in dusty zones.

† Maintenance to be carried out by qualified service personnel. Refer to the Installation Manual.

**Table 2 — Common Issues**

ISSUE	Possible Causes
Unit does not turn on when pressing <b>ON/OFF</b>	The unit has a 3-minute protection feature that prevents the unit from overloading. The unit cannot restart within three minutes of being turned off.
The unit changes from <b>COOL/HEAT</b> mode to <b>FAN</b> mode	The unit may change its setting to prevent frost from forming on the unit. Once the temperature increases, the unit starts operating in the previously selected mode again.
	The set temperature has been reached, at which point the unit turns off the compressor. The unit continues operating when the temperature fluctuates again.
The indoor unit emits white mist	In humid regions, a large temperature difference between the room's air and the conditioned air can cause white mist.
Both the indoor and outdoor units emit white mist	When the unit restarts in <b>HEAT</b> mode after defrosting, white mist may be emitted due to moisture generated from the defrosting process.
The indoor unit makes noises	A rushing air sound may occur when the louver resets its position.
	A squeaking sound may occur after running the unit in <b>HEAT</b> mode due to expansion and contraction of the unit's plastic parts.
Both the indoor unit and outdoor unit make noises	Low hissing sound during operation: This is normal and is caused by refrigerant gas flowing through both indoor and outdoor units.
	Low hissing sound when the system starts, has just stopped running, or is defrosting: This noise is normal and is caused by the refrigerant gas stopping or changing direction.
	Squeaking sound: Normal expansion and contraction of plastic and metal parts caused by temperature changes during operation can cause squeaking noises.
The outdoor unit makes noises	The unit makes different sounds based on its current operating mode.
Dust is emitted from either the indoor or outdoor unit	The unit may accumulate dust during extended periods of non-use, which will be emitted when the unit is turned on. This can be mitigated by covering the unit during long periods of inactivity.
The unit emits a bad odor	The unit may absorb odors from the environment (such as furniture, cooking, cigarettes, etc.) which will be emitted during operations.
	The unit's filters have become moldy and should be cleaned.
The outdoor unit's fan does not operate	During operation, the fan speed is controlled to optimize product operation.
Operation is erratic, unpredictable, or unit is unresponsive	Interference from cell phone towers and remote boosters may cause the unit to malfunction. In this case, try the following: <ul style="list-style-type: none"> <li>• Disconnect the power, then reconnect.</li> <li>• Press <b>ON/OFF</b> on remote control to restart operation.</li> </ul>

**NOTE: If an issue persists, contact a local dealer or your nearest customer service center. Provide them with a detailed description of the unit malfunction as well as your model number and serial number.**

**Table 3 — Troubleshooting**

<b>PROBLEM</b>	<b>POSSIBLE CAUSE</b>	<b>SOLUTION</b>
Unit/System Does Not Work	The circuit breaker has tripped or a fuse has blown.	Reset the circuit breaker or replace the fuse with the specified replacement fuse.
	Power Failure	Restart operation when the power is restored.
	Diagnostic lights illuminate*	Call your service representative.
	Voltage is too low	Call your service representative.
Cooling is Not Working Properly	The filter is blocked by dust	Clean the air filter.
	Temperature is not set properly	Check the temperature and reset if necessary.
	A window or door is open	Close the window or door.
	The outdoor unit is obstructed	Remove the obstruction.
	The fan speed is too low	Change the fan speed selection.
	The operation mode is in Fan instead of Cool	Change the operating mode to Cool or reset the unit.
Heating is Not Working Properly	The filter is blocked with dust.	Clean the air filter.
	Temperature is set too low	Check the temperature and reset if necessary.
	A window or door is open	Close the window or door.
	The outdoor unit is obstructed	Remove the obstruction.
Unit Stops During Operation	The Off timer is not operating correctly	Restart the operating mode.
	Diagnostic lights illuminate.*	Call your service representative.
Indicator lamps continue flashing		
Error code appears in the indoor unit window display: • E0, E1, E2... • P1, P2, P3... • F1, F2, F3...	The unit may stop operation or continue to run safely. If the indicator lamps continue to flash or error codes appear, wait for about 10 minutes. The problem may resolve itself. If not, disconnect the power, then connect it again. Turn the unit on. If the problem persists, disconnect the power and contact your nearest customer service center.	

\*Diagnostic lights are a combination of lights that will illuminate in the display area on the unit. They are a combination of the lights you see during normal operation.

