

40MBAA

Air Handler Unit Ductless System
Sizes 24 to 48



Product Data

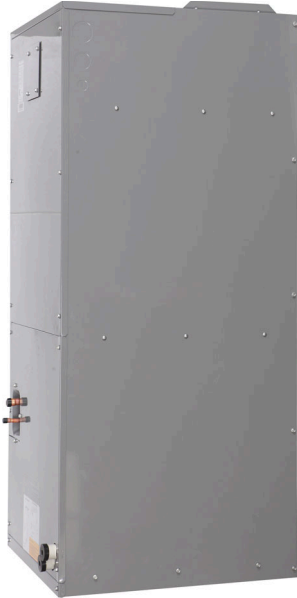

Fig. 1 — Sizes 24 to 48

NOTE: Images are for illustration purposes **only**. Actual models may differ slightly.

INDUSTRY LEADING FEATURES / BENEFITS

A PERFECT BALANCE BETWEEN BUDGET LIMITS, ENERGY SAVINGS AND COMFORT

The **40MBAA** series Air Handler unit ductless systems are a matched combination of an outdoor condensing unit and an indoor fan coil unit connected only by refrigerant tubing and wires. The fan coil is mounted in the ceiling.

This selection of fan coils permits creative solutions to design problems such as:

- Add-ons to current space (an office or family room addition)
- Special space requirements
- When changes in the load cannot be handled by the existing system
- Historical renovations or any application where preserving the look of the original structure is essential.

These compact indoor fan coil units take up very little space above the ceiling. Advanced system components incorporate innovative technology to provide reliable cooling performance at low sound levels.

TABLE OF CONTENTS

INDUSTRY LEADING FEATURES / BENEFITS.....	1
MODEL NUMBER NOMENCLATURE	3
STANDARD FEATURES AND ACCESSORIES	4
DIMENSIONS	5
CLEARANCES.....	6
SPECIFICATIONS	7
COMPATIBILITY.....	7
APPLICATION DATA	8
WIRING	8
CONTROL SYSTEM	9
WIRELESS REMOTE CONTROLLER	9
AIR FLOW DATA	10
SOUND PRESSURE	10
SOUND PRESSURE IN OCTAVE BANDS	10
SOUND PRESSURE TESTING METHOD	10
FAN AND MOTOR SPECIFICATIONS.....	11
SETTING STATIC PRESSURE AND AIRFLOW	12
FAN PERFORMANCES AT VARYING STATIC PRESSURES .	13
WIRING DIAGRAMS.....	16
GUIDE SPECIFICATIONS.....	20

LOW SOUND LEVELS

When noise is a concern, the ductless systems are the answer. The indoor units are whisper quiet. There are no compressors indoors, either in the conditioned space or directly over it, and there is none of the noise usually generated by air being forced through ductwork.

SECURE OPERATION

If security is an issue, outdoor and indoor units are connected only by refrigerant piping and wiring to prevent intruders from crawling through the ductwork. In addition, since outdoor units can be installed close to an outside wall, coils are protected from vandals and severe weather.

FAST INSTALLATION

This compact ductless system is simple to install. A mounting bracket and duct work is needed for the indoor units, and only wire and piping need run between the indoor and outdoor units. These units are fast and easy to install ensuring minimal disruption to customers in the home or workplace. This makes the air handler systems the equipment of choice, especially in retrofit situations.

SIMPLE SERVICING AND MAINTENANCE

Removing the top panel on the outdoor units provides immediate access to the control compartment, providing a service technician access to check unit operation. In addition, the draw-thru design of the outdoor section means that dirt accumulates on the outside surface of the coil. Coils can be cleaned quickly from the inside using a pressure hose and detergent.

On all indoor units, service and maintenance expense is reduced due to easy accessible service panels. In addition, these air handler systems have extensive self-diagnostics to assist in troubleshooting.

BUILT-IN RELIABILITY

The air handler ductless system indoor and outdoor units are designed to provide years of trouble-free operation.

The air handler indoor units include protection against freeze-up and high evaporator temperatures on heat pumps.

The condensing units on the heat pumps are protected by a three minute delay that provides over-current protection and high temperature protection prior to the start of the compressor.

INDIVIDUAL ROOM COMFORT

Maximum comfort is provided because each space can be controlled individually based on the usage pattern. The provided air sweep feature permits optimal room air mixing to eliminate hot and cold spots for occupant comfort. In addition, year-round comfort can be provided with heat pumps.

ECONOMICAL OPERATION

The air handler ductless system design allows individual or multi-room heating or cooling when required. There is no need to run large supply-air fans or chilled water pumps to handle a few spaces with unique load patterns.

EASY-TO-USE CONTROLS

The air handler units have microprocessor-based controls to provide the ultimate in comfort and efficiency. The user-friendly wired and wireless remote control provides the interface between the user and the unit.

MULTI-POISE INSTALLATION

Designed for maximum installation flexibility. The secondary drain built-in allows the unit to be mounted in an upflow, downflow, left or right installation depending on existing conditions.

24V INTERFACE

The built-in 24V Interface allows users to control the ductless system with a third party thermostat.

AGENCY LISTINGS

All systems are listed with AHRI (Air Conditioning, Heating & Refrigeration Institute), and ETL (Size 24) and CSA (Sizes 36-48).

STANDARD FEATURES AND ACCESSORIES

Ease Of Installation	
Low Voltage Controls	S
Comfort Features	
Microprocessor Controls	S
24V Interface built-in for third party thermostat controls	S
Wireless Remote Controller	S
Auto Restart Function	S
Cold Blow Protection on Heat Pumps	S
Freeze Protection Mode on Heat Pumps	S
Turbo Mode	S
Auto Changeover on Heat Pumps	S
Safety And Reliability	
Indoor Coil Freeze Protection	S
Aluminum Hydrophilic pre-coated fins	S
Indoor Coil High Temp Protection in Heating Mode	S
Ease Of Service And Maintenance	
Cleanable Filters	S
Diagnostics	S
Liquid Line Pressure Taps	S
Application Flexibility	
Multi-poise Installation	S

Legend

S - Standard

A - Accessory

ACCESSORIES

ORDERING NO.	DESCRIPTION	FOR MODELS
EHKMA05KN	Electric Heater Kit 5 Kw	Sizes 24, 36, 48
EHKMA10KN	Electric Heater Kit 10Kw	Sizes 24, 36, 48
EHKMA15KN	Electric Heater Kit 15Kw	Sizes 36, 48
EHKMA20KN	Electric Heater Kit 20Kw	Size 48

MULTI-POISE INSTALLATION

Designed for maximum installation flexibility. The secondary drain built-in allows the unit to be mounted in an upflow, downflow, left or right installation depending on existing conditions.

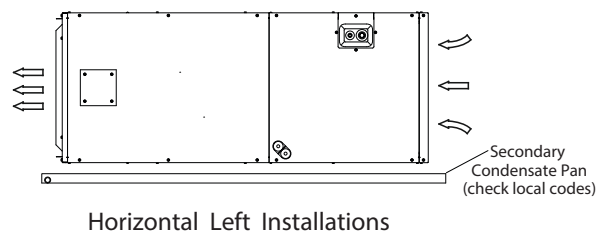
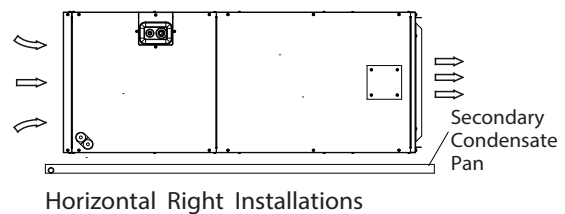
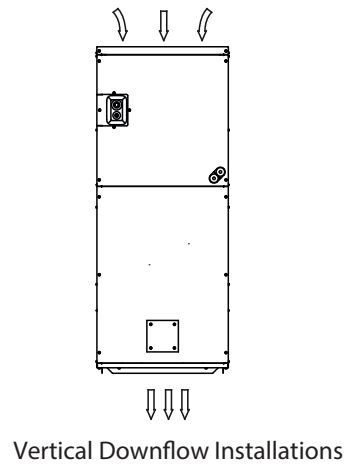
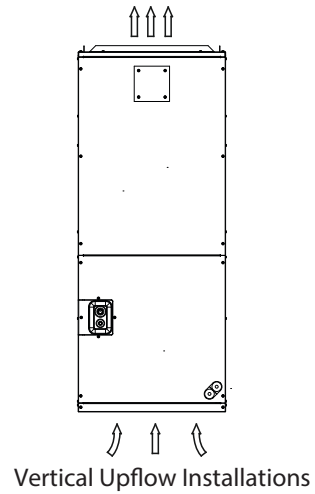

Fig. 2 — Multi-poise installation

DIMENSIONS

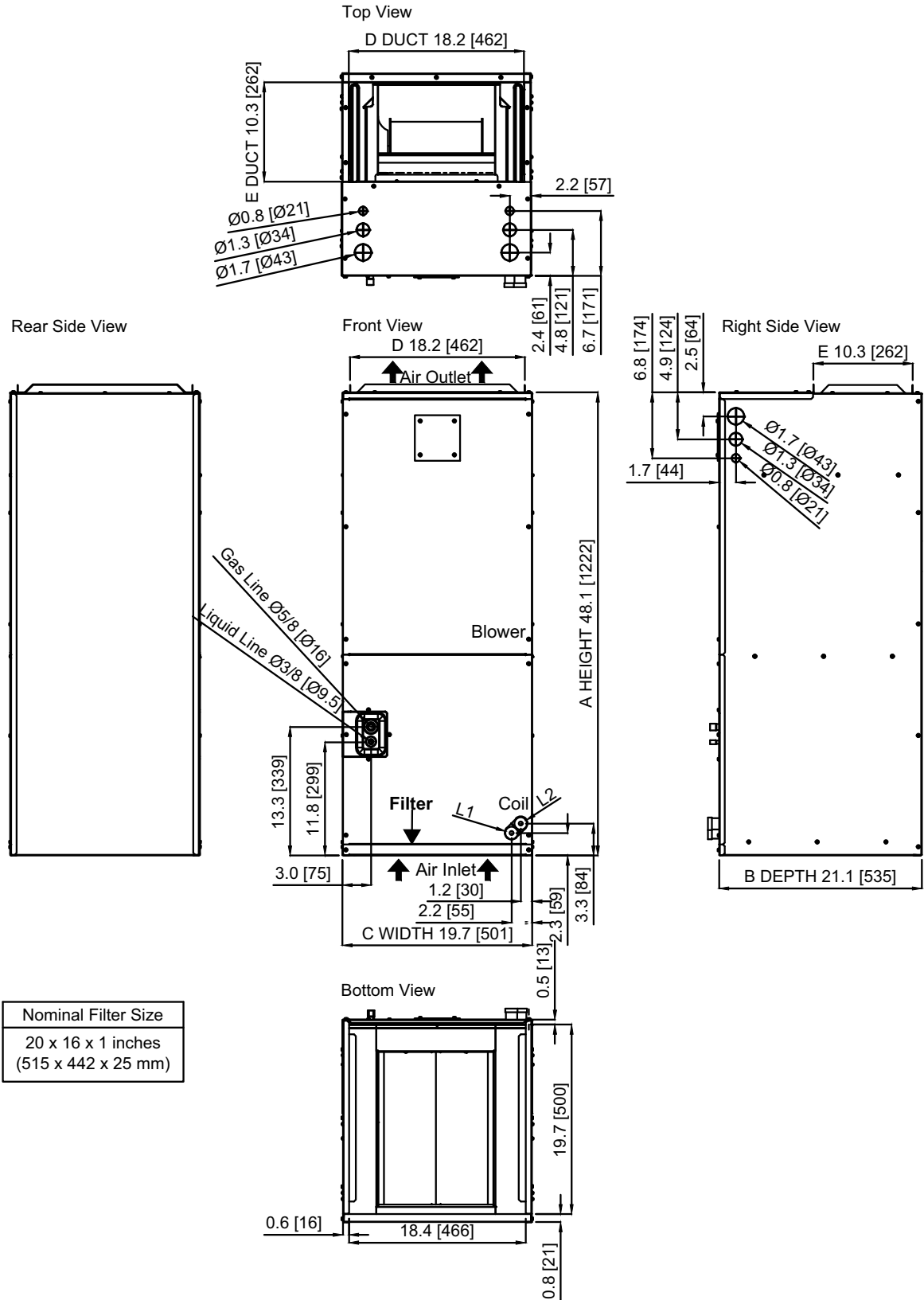

Fig. 3 — Dimensions

Table 1 — Indoor Unit Dimensions

SIZES	HEIGHT	DEPTH	WIDTH	DUCT WIDTH	DUCT DEPTH
24-48	48.2in (1,224mm)	21in (533mm)	19.6in (498mm)	18.2in (461mm)	10.3in (261mm)

CLEARANCES

Allow a minimum of 24in (60.9 cm) clearance from the access panels.

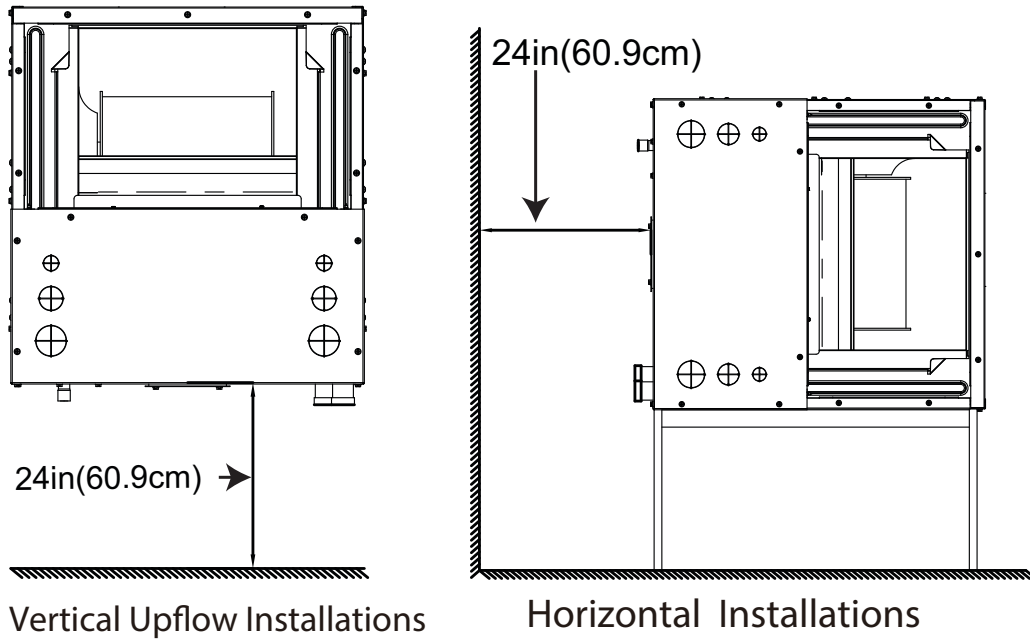

Vertical Upflow Installations

Horizontal Installations

Fig. 4 — Clearances

SPECIFICATIONS

Table 2 — Specifications

HEAT PUMP					
SYSTEM	Size		24	36	48
	Indoor Model		40MBAAQ24XA3	40MBAAQ36XA3	40MBAAQ48XA3
ELECTRICAL	Voltage, Phase, Cycle	V/Ph/Hz	208/230-1-60	208/230-1-60	208/230-1-60
	Power Supply		Indoor unit powered from outdoor unit	Indoor unit powered from outdoor unit	Indoor unit powered from outdoor unit
	MCA	A.	6	6	6
CONTROLS	Wireless Remote Controller (°F/°C Convertible)		Standard	Standard	Standard
	Built-in 24V interface for third party thermostat		Standard	Standard	Standard
OPERATING RANGE	Cooling Indoor DB Min - Max	°F (°C)	62~90 (17~32)	62~90 (17~32)	62~90 (17~32)
	Heating Indoor DB Min - Max	°F (°C)	32~86 (0~30)	32~86 (0~30)	32~86 (0~30)
PIPING	Pipe Connection Size - Liquid	in (mm)	3/8 (9.52)	3/8 (9.52)	3/8 (9.52)
	Pipe Connection Size - Suction	in (mm)	5/8 (16)	5/8 (16)	5/8 (16)
INDOOR COIL	Face Area	Sq. Ft.	3.38	3.38	3.38
	No. Rows		2	4	4
	Fins per inch		20	20	20
	Circuits		4	8	8
INDOOR	Unit Width	in (mm)	19.6 (498)	19.6 (498)	19.6 (498)
	Unit Height	in (mm)	48.8 (1,240)	48.8 (1,240)	48.8 (1,240)
	Unit Depth	in (mm)	21.0 (533)	21.0 (533)	21.0 (533)
	Net Weight	lbs (kg)	141.1 (64)	144.8 (65.7)	144.8 (65.7)
	Number of Fan Speeds		3	3	3
	Airflow (lowest to highest)	CFM	588/765/882	824/1,000/1,176	1,176/1,294/1,412
	Sound Pressure - Cooling (lowest to highest)	dB(A)	37.2/40.4/43/45.2	37.2/40.4/43/45.2	37.2/40.4/43/45.2
	Sound Pressure - Heating (lowest to highest)		35.8/38.7/41.7	37.9/43/46.5/48	50/51.9/53.9/54.9
	Max Static Pressure	In.WG.	0.80	0.80	0.80
Field Drain Pipe Size O.D.	in (mm)	3/4 (19.1)	3/4 (19.1)	3/4 (19.1)	

*Performance may vary based on the compatible outdoor units. See respective pages for performance data.

COMPATIBILITY

Table 3 — Compatibility

INDOOR UNIT	40MBAAQ24XA3	40MBAAQ36XA3	40MBAAQ48XA3
Outdoor Unit Single Zone	38MAQB24R--3	38MBRBQ36AA3	38MBRBQ48AA3
Outdoor Unit Multi-zone	38MGRQ30D--3		
	38MGRQ36D--3		
	38MGRQ48E--3		

APPLICATION DATA

UNIT SELECTION

Select equipment to either match or that can handle slightly less than the anticipated peak load. This provides better humidity control, fewer unit cycles, and less part-load operation.

For units used in spaces with high sensible loads, base equipment selection on unit sensible load, not on a total anticipated load. Adjust for anticipated room wet bulb temperature to avoid undersizing equipment.

UNIT MOUNTING (INDOOR)

Refer to the unit's installation instructions for further details.

Unit leveling - For reliable operation, units should be level in all planes.

Clearance - Provide adequate clearance for airflow (see Fig. 4 — on page 6).

Unit location - Select a location which provides the best air circulation for the space.

UNIT MOUNTING (OUTDOOR)

Refer to the unit's installation instructions for further details.

Do not install the indoor or outdoor units in a location with special environmental conditions. For those applications, contact your ductless representative.

SUPPORT

Adequate support must be provided to support the weight of all fan coils. Refer to the "SPECIFICATIONS" on page 7 for fan coil weights. Refer to "DIMENSIONS" on page 5 for the base unit dimensional drawings which contain the location of the mounting brackets.

SYSTEM OPERATING CONDITIONS

OPERATING RANGE MIN/MAX °F (°C)		
	Cooling	Heating
Indoor DB	63 / 90 (17 / 32)	32 / 86 (0 / 30)
Indoor WB	59 / 84 (15 / 29)	

NOTE: Reference the unit's installation instructions for more information.

DRAIN CONNECTIONS

Install the drains in compliance with the local sanitation codes.

WIRING

Size all wires per the NEC (National Electrical Code) or CEC (Canadian Electrical Code) and local codes. Use the electrical data from the outdoor unit (MCA - minimum circuit amps and MOCP - maximum over current protection), to correctly size the wires and the disconnect fuse or breakers respectively.

SIZE 24 RECOMMENDED CONNECTION METHOD FOR POWER AND COMMUNICATION WIRING

Power and Communication Wiring: The main power is supplied to the outdoor unit. The field supplied 14/3 power/communication wiring, from the outdoor unit to the indoor unit, consists of four (4) wires and provides the power for the indoor unit. Two wires are high voltage AC power, one is communication wiring and the other is a ground wire.

To minimize communication interference: If installed in a high Electromagnetic field (EMF) area and communication issues arise, a 14/2 stranded shielded cable can be used to replace L2 and (S) between the outdoor and indoor units - landing the shield onto the ground in the outdoor unit only.

Table 4 — Wiring Size 24

CABLE	CABLE SIZE	REMARKS
Connection Cable	14AWG	3 wire + Ground 1 ϕ 208/230 V (Stranded wire is recommended)

SIZES 36-48 RECOMMENDED CONNECTION METHOD FOR POWER AND COMMUNICATION WIRING

Power and Communication Wiring: The main power is supplied to the outdoor unit. The field supplied power wiring from the outdoor unit to the indoor unit consists of three (3) wires and provides the power for the indoor unit. Two wires are high voltage AC power and one is a ground wire. To minimize voltage drop, the factory recommended wire size is 14/2 power stranded with a ground.

Communication Wiring: A separate 2-wire cable (stranded, shielded, copper conductor), with a 600 volt rating and double insulated copper wire, must be used as the communication wire from the outdoor unit to the indoor unit. Use a separate shielded 16AWG stranded control wire.

Table 5 — Wiring Sizes 36-48

CABLE	CABLE SIZE	REMARKS
Power Connection Cable	14AWG	2 wire + Ground 1 ϕ 208/230 V
Communication Cable	16AWG	2 wire stranded shielded control wire

NOTE: The main power is supplied to the outdoor unit. When disconnecting the power to the outdoor unit, the indoor unit loses power. A disconnect switch may be required for the indoor unit. Check local codes. A 3 pole disconnect may be used for extra protection between the indoor and outdoor unit. Separate power is required for an Auxiliary Electric Heater.



CAUTION

EQUIPMENT DAMAGE HAZARD

Comply with local codes while running wire from the indoor unit to the outdoor unit. Every wire must be connected firmly. Loose wiring may cause the terminal to overheat or result in a unit malfunction. A fire hazard may also exist. Ensure all wiring is tightly connected.

No wire should touch the refrigerant tubing, compressor or any moving parts.

Disconnecting means must be provided and located within sight and readily accessible from the system. Route the connecting cable with conduit through the hole in the conduit panel.

CONTROL SYSTEM

The indoor unit is equipped with a microprocessor control to perform two functions:

1. Provide safety for the system
2. Control the system and provide optimum levels of comfort and efficiency.

The main microprocessor is located on the control board of the fan coil unit (outdoor units have a microprocessor also) with thermistors located in the fan coil air inlet and on the indoor coil. Heat pump units have a thermistor on the outdoor coil. These thermistors monitor the system's operation to keep the unit within acceptable parameters and control the operating mode.

WIRELESS REMOTE CONTROLLER

1. A wireless remote controller is supplied for setting airflow. Please refer to the installation manual in HVAC Partners for setting airflow.
2. The Infrared receiver is located inside the control box of the indoor Air Handler and can be relocated if necessary.



Fig. 5 — Wireless Remote Controller

24 VOLT INTERFACE

The indoor unit comes equipped with a 24V interface that provides further flexibility, functionality and control allowing it to be controlled by any 3rd party single-stage conventional thermostat (field supplied).

NOTE: A conventional 5-wire thermostat is required. A 2 heat/1 cool thermostat is required for electric heat applications.



Fig. 6 — Air Handler

AIR FLOW DATA

Table 6 — Air Flow Data

SYSTEM SIZE		24K (208/230V)	36K (208/230V)	48K (208/230V)
Airflow** (CFM)	High	882	1,176	1,412
	Medium	765	1,000	1,294
	Low	588	824	1,176

Airflow values obtained at AHRI 210/240 rating conditions.

**Measured at rates static pressure:

24K: 0.1 in. WG (25pa)

36K: 0.15 in. WG (37pa)

48K: 0.2 in. WG (50pa)

SOUND PRESSURE

Table 7 — Sound Pressure

AIR HANDLER INDOOR		24K (208/230V)	36K (208/230V)	48K (208/230V)
**Cooling operation Indoor Sound Pressure	dBA at (High / Med /Low CFM)	43/40.4/37.2	46.5/43/37.9	53.9/51.9/50
**Heating operation Indoor Sound Pressure	dBA at (High / Med /Low CFM)	41.7/38.7/35.8	46.1/42.2/37.6	53.6/51.5/49.5

SOUND PRESSURE IN OCTAVE BANDS

Table 8 — Sound Pressure In Octave Bands

SIZE	FREQUENCY (HZ)	63	125	250	500	1,000	2,000	4,000	8,000
24K	Cooling dB(A)	52.8	57.1	56.8	53.4	48.8	42.2	37.4	34
	Heating dB(A)	60.1	55.7	54.2	50.7	46.9	42.3	36.1	31.5
36K	Cooling dB(A)	61.0	68.1	63.7	57.1	56.3	51.6	48.8	44.5
	Heating dB(A)	65.0	69.3	65.5	58.0	58.8	55.1	51.6	46.8
48K	Cooling dB(A)	69	63.4	59.4	59.5	59.7	52.2	46.4	42
	Heating dB(A)	71	64.9	62.1	60.9	60.5	54.6	48.6	45.5

SOUND PRESSURE TESTING METHOD

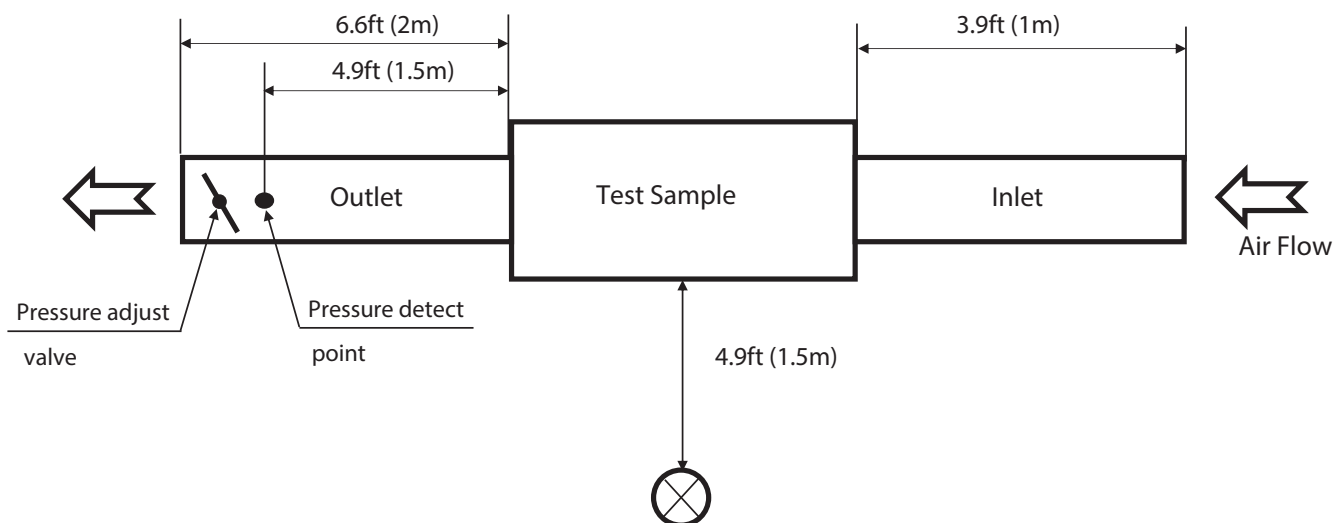

Fig. 7 — Sound Pressure Testing Method

FAN AND MOTOR SPECIFICATIONS

Table 9 — Fan and Motor Specifications

SIZE		24K	36K	48K
		(208/230 V)	(208/230 V)	(208/230 V)
INDOOR FAN	Material	Metal	Metal	Metal
	Type	LX-282*245*12.7-49J-B	LX-282*245*12.7-49J-B	LX-282*245*12.7-49J-B
	Diameter	inch	11.1	11.1
	Height	inch	9.65	9.65
INDOOR FAN MOTOR	Model	ZKFN-600-10-1	ZKFN-600-10-1	ZKFN-600-10-1
	Volts	V	208/230	208/230
	Type		DC	DC
	Phase		3	3
	FLA		5	5
	Insulation class		B	B
	Safe class		IP20	IP20
	Input	W	150	320
	Output	W	120	250
	Range of current	Amps	1.2±10%	2.4±10%
	Rated current	Amps	1.2	2.4
	Capacitor	μF		NA
	Rated HP	HP	0.20	0.42
	Rated Power High/Medium/Low	W	148/107/75	315/191/138
	Speed High/Medium/Low	rev/min	720/640/550	900/800/700
	Rated RPM	rev/min	720	900
Max. input	W	325	483	

SETTING STATIC PRESSURE AND AIRFLOW

The indoor fan coil units can be programmed to have different static pressures settings or airflows; the factory default setting is SP1. Follow the next steps to set the **static pressure** or **Automatic Airflow** using the Wireless Remote Controller according to the installation conditions.

- The external static pressure can be manually changed to the fan curves SP1, SP2, SP3, SP4.
- Choose the Automatic Airflow “AF” adjustment function to automatically identify the static pressure and regulate the airflow amount.

Follow these instructions to configure:

1. Ensure the test run is done with a dry coil. If the coil is not dry, run the unit for 2 hours in the **FAN ONLY** mode to dry the coil.
2. Check that both the power supply wiring and the duct installation have been completed. Check that the air vent is properly positioned. Check that the air filter is properly attached to the air return side passage of the unit.
3. If there is more than one air inlet and/or outlet, adjust the dampers so that the airflow rate of each air inlet and outlet conforms to the designed airflow rate. Ensure the unit is in **FAN ONLY** mode.

The wireless remote controller is required to setup the static pressure of the indoor air handler units.

NOTE: When a system is using the 24V interface built-in, the indoor unit’s fan speed defaults to **AUTO** with the indoor unit’s default logic.

The external static pressure should be selected using the wireless remote controller (RG57F3(B)/BGEFU1), included with the indoor unit, by pointing it toward the indoor unit’s Infrared Receiver typically located inside the control box.

- a. Before using the service functions of the remote, turn OFF the indoor unit with the remote.
- b. Turn off the power to the indoor and outdoor units for 3 minutes.
- c. Turn the power back on.
- d. Remove the batteries from the RG57 wireless remote controller and wait for the remote screen to clear or press any button and the screen clears.
- e. Reinstall the batteries.
- f. Within 30 seconds of replacing the batteries, simultaneously press **MODE** and **TIMER ON** for five (5) seconds. You are now in the **SERVICE FUNCTION** mode – and the remote display reads **F1**.
- g. Manual static pressure or Automatic Airflow adjustment selection:
 1. For manual static pressure selection, press the **DOWN** arrow in the center of the remote (labeled **TEMP**) to display **E9**. Press **MODE** to set the external static pressure/airflow rate in the range of 1~4 (airflow increases quickly). Press **TIMER ON** to confirm. The values on the remote controller (1,2,3,4) correlate directly to the static pressure curves SP1, SP2, SP3, SP4 (see “FAN PERFORMANCES AT VARYING STATIC PRESSURES” on page 13).
 2. If choosing the **AUTOMATIC AIRFLOW ADJUSTMENT** function, with **F1** in the remote display, press the **DOWN** arrow once and **d4** appears. Press **TIMER ON** to confirm. **AF** appears in the unit’s LED display. The system starts the fan for the airflow automatic adjustment. The **ON** indicator flashes when the fan runs during the **AUTOMATIC AIRFLOW ADJUSTMENT**. After 3 to 6 minutes, the system stops operating once the **AUTOMATIC AIRFLOW ADJUSTMENT** is complete.
- h. Remove the remote controller battery, and then re-insert the battery after the remote controller screen goes blank. The remote controller exits the **SERVICE FUNCTION** mode.

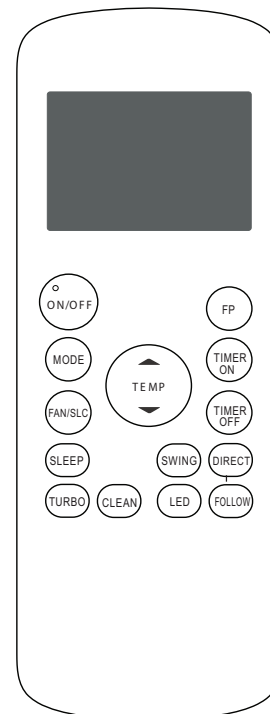

Fig. 8 — Remote Controller

FAN PERFORMANCES AT VARYING STATIC PRESSURES

Table 10 — Static Pressure at the Rated Point and Static Pressure Range

AHU		FAN COIL BLOWER PERFORMANCE CFM (DRY COIL WITHOUT FILTER OR ELECTRIC HEAT)									
Model Number	Static Pressure	Speed	EXTERNAL STATIC PRESSURE (in.w.c.)								
			0	0.1	0.2	0.3	0.4	0.5	0.6	0.7	0.8
24	SP1	High	1,076	975	853	675	502	200	/	/	/
		Medium	942	822	658	465	184	/	/	/	/
		Low	797	648	437	100	/	/	/	/	/
	SP2	High	1,250	1,175	1,075	965	815	650	475	200	/
		Medium	1,185	1,095	996	855	685	512	291	/	/
		Low	1,100	1,005	892	712	558	322	/	/	/
	SP3	High	1,490	1,415	1,334	1,250	1,156	1,028	880	750	600
		Medium	1,375	1,294	1,206	1,100	988	822	676	500	284
		Low	1,285	1,200	1,105	995	845	685	525	252	/
	SP4	High	1,825	1,756	1,670	1,592	1,515	1,450	1,360	1,250	1,120
		Medium	1,630	1,556	1,480	1,400	1,310	1,215	1,105	950	825
		Low	1,525	1,450	1,372	1,280	1,190	1,074	935	785	650
36	SP1	High	1,335	1,270	1,165	1,062	950	810	645	450	240
		Medium	1,185	1,100	990	845	685	520	335	/	/
		Low	1,020	915	775	600	405	/	/	/	/
	SP2	High	1,475	1,405	1,320	1,230	1,125	990	855	715	570
		Medium	1,340	1,260	1,172	1,055	920	775	630	460	275
		Low	1,205	1,115	1,011	870	715	555	380	/	/
	SP3	High	1,648	1,585	1,515	1,440	1,354	1,235	1,125	990	875
		Medium	1,510	1,440	1,362	1,275	1,168	1,040	910	780	645
		Low	1,385	1,305	1,215	1,115	986	855	727	580	421
	SP4	High	1,815	1,733	1,663	1,605	1,528	1,435	1,346	1,235	1,130
		Medium	1,668	1,606	1,539	1,465	1,380	1,275	1,178	1,050	941
		Low	1,558	1,481	1,406	1,350	1,219	1,100	986	875	748
48	SP1	High	1,611	1,530	1,462	1,375	1,276	1,170	1,052	925	831
		Medium	1,498	1,417	1,333	1,225	1,125	998	900	775	631
		Low	1,375	1,297	1,212	1,110	994	860	716	558	389
	SP2	High	1,774	1,701	1,642	1,570	1,504	1,420	1,313	1,202	1,081
		Medium	1,662	1,595	1,531	1,460	1,366	1,275	1,161	1,040	915
		Low	1,558	1,481	1,406	1,323	1,220	1,110	986	880	748
	SP3	High	1,868	1,805	1,736	1,675	1,604	1,532	1,433	1,330	1,211
		Medium	1,781	1,709	1,649	1,582	1,511	1,420	1,308	1,208	1,081
		Low	1,662	1,595	1,531	1,460	1,366	1,275	1,161	1,040	915
	SP4	High	2,024	1,974	1,919	1,850	1,795	1,726	1,652	1,560	1,466
		Medium	1,942	1,872	1,818	1,765	1,697	1,620	1,534	1,455	1,345
		Low	1,825	1,770	1,708	1,648	1,578	1,492	1,400	1,295	1,180

>300CFM	<450CFM
---------	---------

NOTES:

1. Airflow based upon dry coil at 230v without filter or electric heater.
2. To avoid potential for condensate blowing out of drain pan prior to making drain trap:
Return static pressure must be less than 0.40 in wc.
Horizontal applications of 48 size must have supply static greater than 0.20 in wc.
3. Airflow above 400 cfm/ton could result in condensate blowing off coil or splashing out of drain pan.

FAN PERFORMANCES AT VARYING STATIC PRESSURES (CONT)

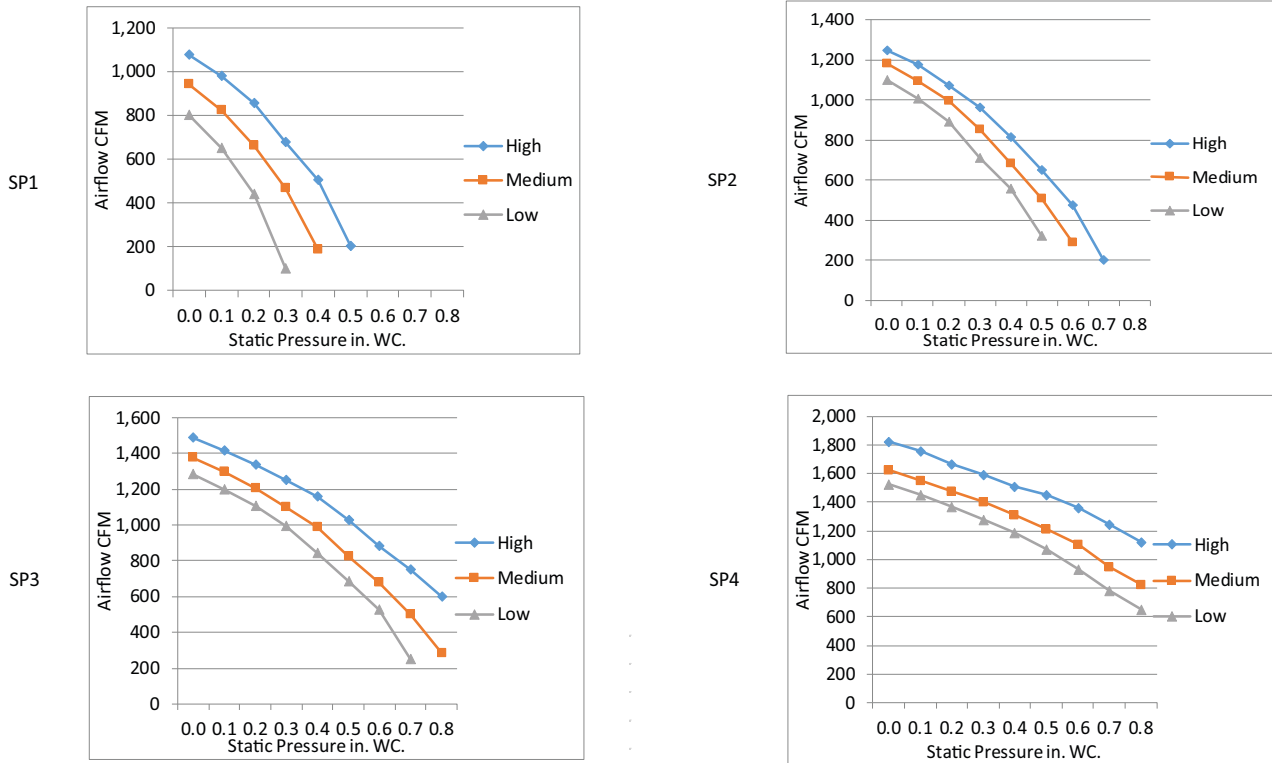

Fig. 9 — Fan Performance - 24K

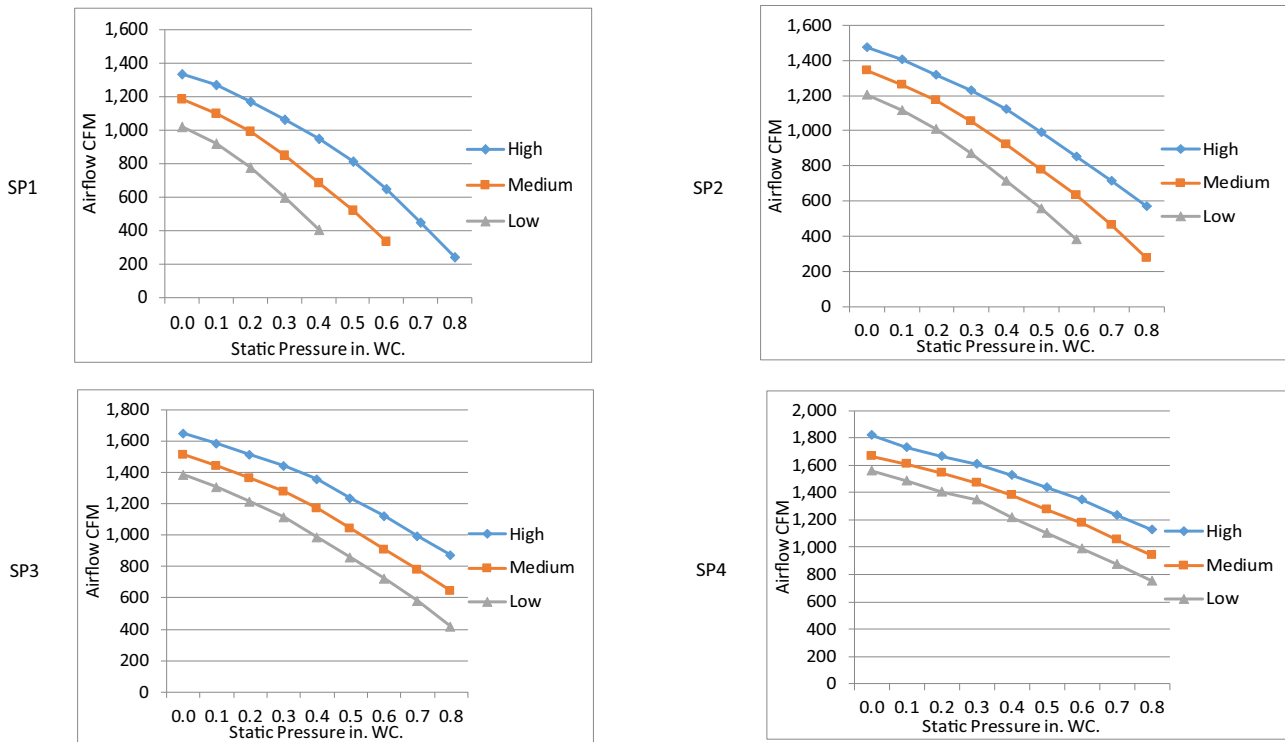

Fig. 10 — Fan Performance - 36K

FAN PERFORMANCES AT VARYING STATIC PRESSURES (CONT)

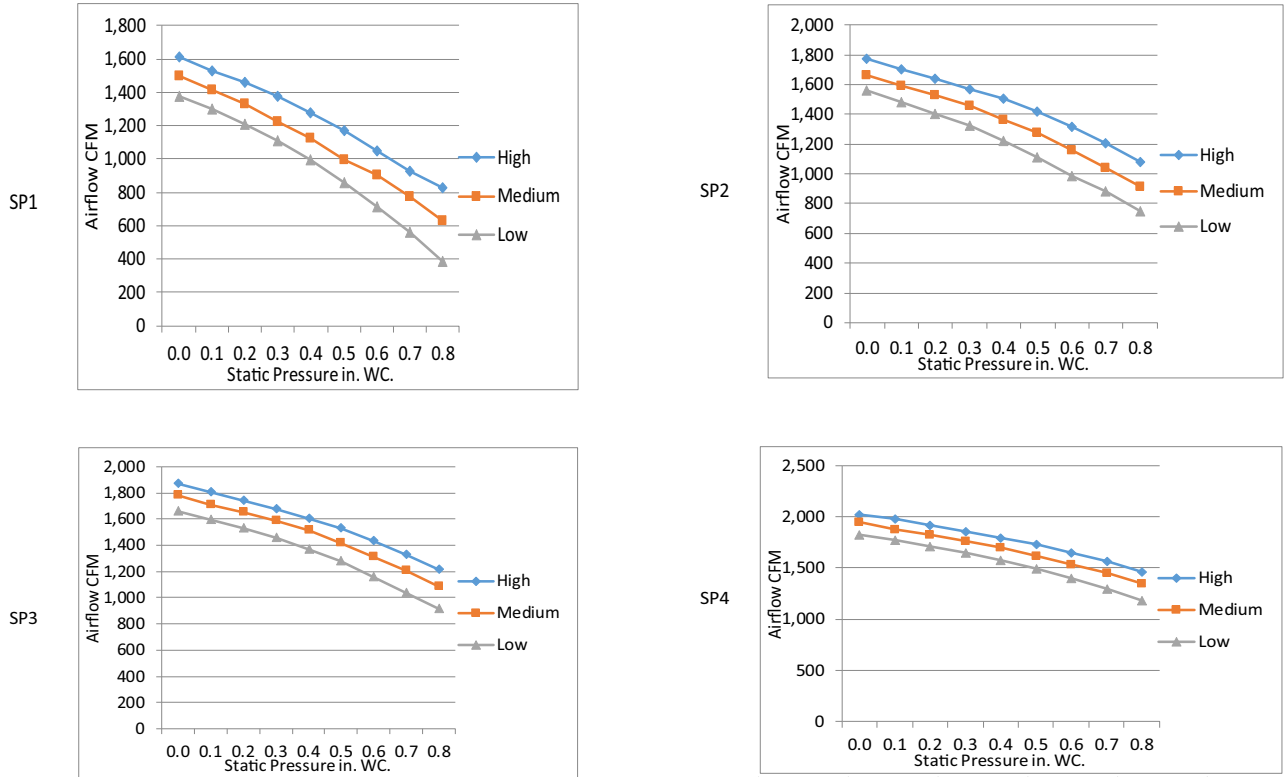

Fig. 11 — Fan Performance - 48K

WIRING DIAGRAMS

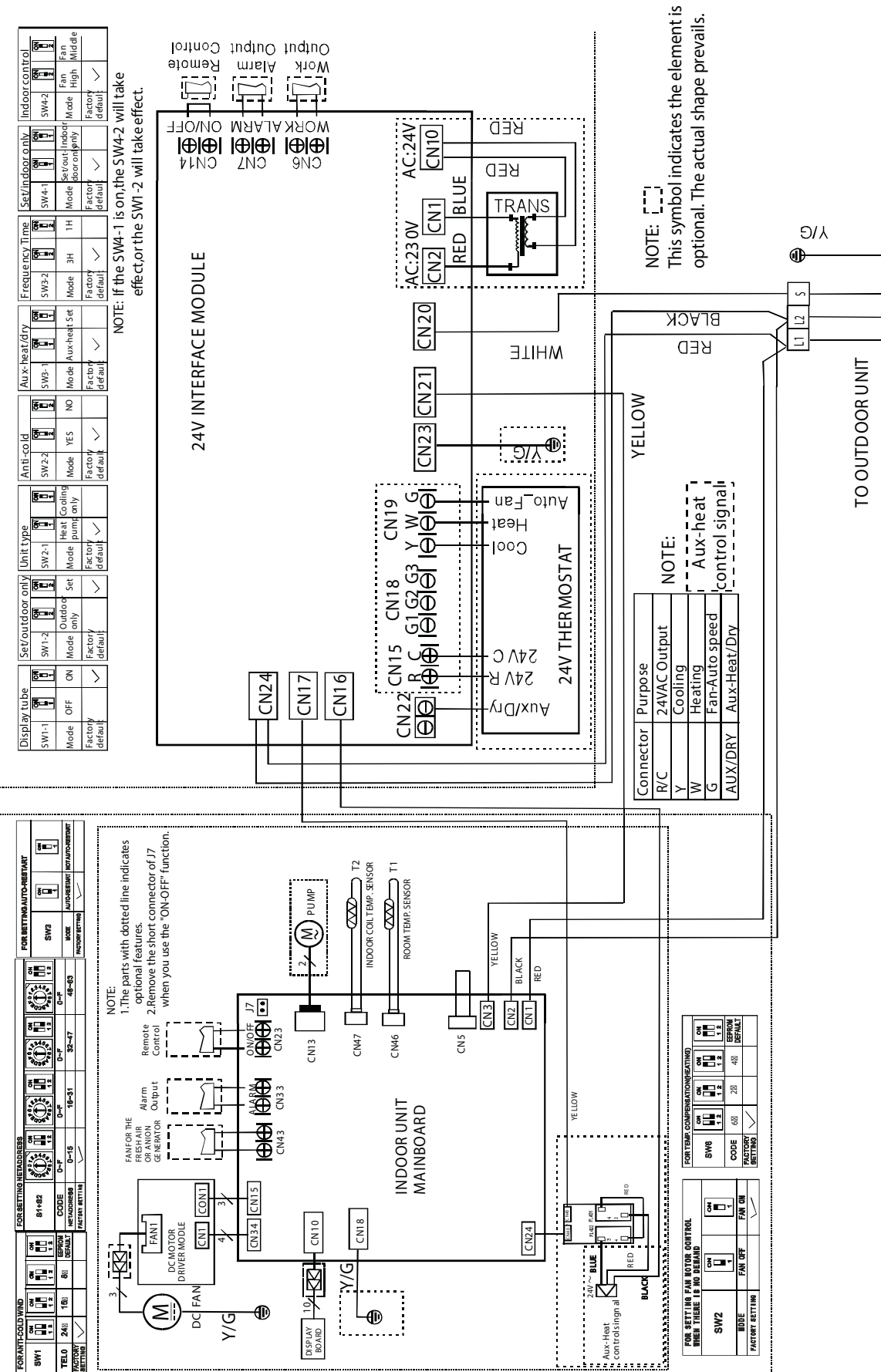

Fig. 12 — Wiring Diagram Size 24K

WIRING DIAGRAMS (CONT)

Table 11 — Wiring Diagram Size 24K

CODE	INDOOR UNIT MAINBOARD CONNECTION
CN1	input: 230VAC High voltage
CN2	input: 230VAC High voltage
CN3	communication: 230VAC High voltage
CN5	output: 0-5VDC water level switch connection
CN10	output: 12VDC display board connection
CN13	output: 220V AC for the pump
CN15	output: 220V AC for the fan
CN18	output: 0V connection to the ground
CN23	output: 12VDC for the remote controller
CN24	output: 12VDC for the heater control board
CN33	output: 0V for the alarm
CN34	output: 15V DC for the driver board (danger)
CN43	output: 220VAC for the fresh air fan
CN46	input: 5V DC for the T1
CN47	input: 5V DC for the T2

Table 12 — Wiring Diagram Size 24K

CODE	24 VOLT INTERFACE CONNECTION
CN1	input: 230VAC High voltage
CN2	input: 230VAC High voltage
CN6	output: 0V for the work
CN7	output: 0V for the alarm
CN10	input: 24V for the 24V interface board
CN14	output: 12VDC for the remote controller
CN15	output: 24VAC for the 24V thermostat
CN16	output: 24VAC for the heater control
CN17	output: 25VAC for the heater control
CN18	input: 24VAC for the fan control
CN19	input: 24VAC for the mode control
CN20	communication: 230VAC High voltage
CN21	communication: 230VAC High voltage
CN22	input: 24VAC for the AUX
CN23	output: 0V connection to the ground
CN24	input: 230VAC High voltage

WIRING DIAGRAMS (CONT)

Table 13 — Wiring Diagram Sizes 36K - 48K

CODE	INDOOR UNIT MAINBOARD CONNECTION
CN1	input: 230VAC High voltage
CN2	input: 230VAC High voltage
CN5	output: 0-5VDC water level switch connection
CN10	output: 12VDC display board connection
CN13	output:220V AC for pump
CN15	output:220V AC for fan
CN16	communication: 5VDC for the 24V interface board
CN18	output:0V connection to the ground0
CN23	output: 12 VDC for the heater control board
CN24	output: 12VDC for the heater control board
CN33	output: 0V for the alarm
CN34	output: 15V DC for the driver board (danger)
CN43	output: 220VAC for the fresh air fan
CN46	input: 5V DC for the T1
CN47	input 5V for the T2

Table 14 — Wiring Diagram Sizes 36K - 48K

CODE	24 VOLT INTERFACE CONNECTION
CN1	input:230VAC High voltage
CN2	input:230VAC High voltage
CN6	output: 0V for the work
CN7	output: 0V for the alarm
CN9-2	communication:5VDC for the main board
CN10	input:24V for the 24V interface board
CN14	output:12VDC for the remote controller
CN15	output:24VAC for the 24V thermostat
CN16	output:24VAC for the heater control
CN17	output:25VAC for the heater control
CN18	input: 24VAC for the fan control
CN19	input: 24VAC for the mode control
CN20	communication: 230VAC High voltage
CN21	communication: 230VAC High voltage
CN22	input:24VAC for the AUX
CN23	output:0V connection to the ground
CN24	input:230VAC High voltage

GUIDE SPECIFICATIONS

INDOOR AIR HANDLER DUCTLESS SYSTEMS

Size Range: 2 to 4 Ton Nominal Cooling and Heating Capacity Model
Number: 40MBAA

Part 1 - GENERAL

1.01 System Description

Indoor, air handler, direct-expansion fan coils are matched with a heat pump outdoor unit.

1.02 Agency Listings

Unit is rated per AHRI Standards 210/240 and listed in the AHRI directory as a matched system.

1.03 Delivery, Storage, And Handling

Units are stored and handled per the unit manufacturer's recommendations.

1.04 Warranty (For Inclusion By Specifying Engineer)

Part 2 - PRODUCTS

2.01 Equipment

A. General:

Indoor, direct-expansion, ceiling-mounted fan coil. The unit is complete with cooling/heating coil, fan, fan motor, piping connectors, electrical controls, microprocessor control system, and integral temperature sensing.

B. Unit Cabinet:

Unit cabinet is constructed of galvanized steel. The cabinet is fully insulated for improved thermal and acoustic performance.

C. Fans:

The fan is the tangential direct-drive blower type with air intake at the rear or bottom of the unit and discharge at the front.

D. Coil:

The coil is a copper tube with aluminum fins and galvanized steel tube sheets. The fins are bonded to the tubes by mechanical expansion and specially hydrophilic pre-coated for enhanced wet-ability. A drip pan under the coil has a factory installed condensate pump and drain connection for hose attachment to remove condensate.

E. Motors:

The motors have an open drip-proof, permanently lubricated ball bearing with inherent overload protection. Fan motors are 3-speed.

F. Controls:

The controls consist of a microprocessor-based control system which controls the space temperature, determines optimum fan speed, and runs self diagnostics.

The unit has the following functions (at a minimum):

1. An automatic restart, after a power failure, which sets the unit back to the same operating conditions it operated under at time of failure.
2. A timer function to provide a minimum 24-hour timer cycle for system Auto Start/Stop.
3. Temperature-sensing controls sense return air temperature.
4. Indoor coil freeze protection.
5. Wireless infrared remote controller to enter set points and operating conditions.
6. **DEHUMIDIFICATION** mode provides increased latent removal capability by modulating system operation and set point temperature. Applicable **only** with third party thermostats that have the dehumidification option.
7. **FAN-ONLY** operation to provide room air circulation when cooling is not required.
8. Diagnostics provide continuous checks of unit operation and warns of possible malfunctions. Error messages appear on the unit.
9. The fan speed control is user-selectable: high, medium, low, or microprocessor controlled automatic operation during all operating modes.
10. Automatic heating-to-cooling changeover in the **HEAT** pump mode. The control includes deadband to prevent rapid mode cycling between heating and cooling.
11. Indoor coil high temperature protection is provided to detect an excessive indoor discharge temperature when the unit is in the **HEAT** pump mode.

G. Electrical Requirements:

The indoor fan motor operates on 208-230V. Power is supplied from the outdoor unit.

H. Operating Characteristics:

The Air Handler system has a minimum SEER (Seasonal Energy Efficiency Ratio) and HSPF at AHRI conditions, as listed on the specifications table.

I. Refrigerant Lines:

All units have refrigerant lines that can be oriented to connect from the side of the unit. Both refrigerant lines must be insulated.