

FIGURE 812 - 832

RESILIENT-SEATED BUTTERFLY VALVES



INTRODUCTION

FNW resilient-seated butterfly valves have been designed and manufactured for fluid control handling in suitable mechanical systems. This instruction manual includes installation, operation and maintenance information for the FNW resilient-seated butterfly valve. It is important to read and understand the following instructions to ensure safe and trouble-free operation. Failure to follow these instructions may result in reduced valve performance and void the manufacturer's warranty. This manual addresses manually operated valves, including lever and gear operated only. For complete actuation, options and accessories information, consult the specific device's manual.

TABLE OF CONTENTS

General Safety	2
General Information.....	2
Transportation.....	2
Packing and Unpacking.....	2
Storage.....	3
Pre-Installation	3–5
Installation Considerations in Piping.....	6
Installation	7–9
Operation	10
Maintenance	10
Troubleshooting.....	11-12
Part Information	13
Inspection.....	14
Butterfly Valve Assembly.....	15–16
Precautions Before Disassembling the Valve from the Line.....	17
Removal of Valve from Piping	17
Butterfly Valve Disassembly.....	17
Warranty	18

SCOPE:
The purpose of this manual is to ensure that the valves supplied are properly installed, handled, operated and maintained to give trouble-free performance. This manual covers FNW resilient-seated butterfly valves.

NOTES:

- Read the manual carefully before removal, installation, maintenance or operation of the valve.
- Refer to general arrangement drawings to identify the design, as valves may vary in features and parts.
- Pay attention to warnings and illustrations carefully.

FIGURE 812 - 832

RESILIENT-SEATED BUTTERFLY VALVES



GENERAL NOTES

1. GENERAL SAFETY

At all times, personal safety equipment, safety glasses, safety boots with crush-resistant toe caps, hard hat and gloves should be worn for pinch protection and while handling valves exposed to chemicals.



WARNING:

Warns against an unsafe situation or practice that, if not avoided, could result in damage or injury.

2. GENERAL INFORMATION

The selection of the valve design and materials of construction as related to the specific service application is the sole responsibility of the end user. All FNW BFV have an identification mark (casting or information tag) casted or attached on valve body. Important information, including valve size, class, materials of construction and pressure ratings, are shown. Before installing, review corrosive effects of the media to be used in the valve and ensure it is compatible with the valve materials of construction. Do not install the valve where the pressure/temperature ratings can be exceeded. Valve should be regularly maintained as mentioned in Maintenance Section. Valves used in services where erosion or other detrimental situations can occur should be inspected on a regular basis.

3. TRANSPORTATION

- Valves weighing over 20 kgs should be transported using equipment or a machine, not manpower alone. Please refer to product catalogue for details of valve unit weight.
- Protect the valve sufficiently before transportation to avoid damage. Damage may cause leakage or corrosion.
- Use containers for ocean transport. Use a covered vehicle for inland transportation to avoid exposure to wind and rain. If an uncovered vehicle is used, cover the product with a protective waterproof cover.
- Do not throw the product and do not apply a heavy load.
- The valves should be secured during transport from shifting or falling and stored without heavy loads on top to avoid damage, especially to the valve seat and disc.

4. PACKING AND UNPACKING

- All FNW resilient-seated BFV are shipped open about 10 degrees from their closed position.
- All valves are packed with bubble wrap and carton box protection around the main valve body for valves up to 12" and bubble wrap and plywood protection for sizes 14"–24". Be careful not to damage the edge of disc and seat. Individual carton box protection packing includes information such as the pressure class, nominal size and materials.
- The bubble wrap or plywood protection cover on the face and carton box packing cover should remain on the valve until actual installation into piping.
- Do not leave the valve unpacked for long periods of time to prevent adherence of dust and harmful substances, as well as deterioration.
- Be careful not to damage the product with a cutter when unpacking.

FIGURE 812 - 832

RESILIENT-SEATED BUTTERFLY VALVES



STORAGE & PRE-INSTALLATION

5. STORAGE

- Storage condition is very important to prevent degradation in performance, contamination and discoloration, and material deterioration.
- Valves must be stored in a dry environment with no dust or water droplets, while avoiding direct sunlight, low and high temperatures and humidity. Protect valves from temperature extremes and possibility of damage. Recommend to store indoors in room temperature range with humidity 60% or less without removing the bubble wrap & carton box packaging or the protective material attached to the valve.
- High humidity may reduce the strength of the carton box and the packaging may be broken, which may result in damage of the product. Be careful not to get the packing wet.
- If the valves are to be stored long-term, they should be operated open/close once every three months.
- The valve body is made from epoxy-coated cast iron, ductile iron or stainless steel, and rust can appear on inside surface. This will not affect valve performance. Special care should be taken to prevent damage to the disc edge and sealing surface.
- Do not drop, overturn or vibrate the valve, and do not apply a heavy load to the product during storage.

6. PRE-INSTALLATION

The following should be read and understood prior to the installation of the valve.

- Determine valve orientation. The valve is bi-directional shut-off and can be installed in any position or direction. The normal installation position is with the valve stem in the vertical position and the actuator mounted vertically directly above the valve. However, valves in elevated positions with gear operator and chain wheels should be installed with the valve stem pointing down so that the open/close position indicator is visible from the ground and chain hangs freely, clearing the pipe. For the slurries, sludge, mine tailing, pulp stock, dry cement and any media with sediment or particles, we recommend the resilient seated with the stem in the horizontal position with the lower disc edge opening in the down stream direction.
- Figure 812 & 832 valves mounted in dead-end service are limited to the following differential pressures based on disc material and valve size for EPDM, BUNA-N (NBR) or Viton seats. This configuration is for liquid services only and not recommended for gas/air applications.
 - Figure 832: 255 PSI (2"–12")
 - Figure 832: 188 PSI (14"–24")
 - Figure 812: 200 PSI (2"–12")
 - Figure 812: 150 PSI (14"–24")
- Dry service conditions, including vacuum service, will result in higher torques and seat wear.
- Prior to installation, make sure that levers, gear operators and actuators are properly installed and that the stops are properly set for open and close positions.
- Before installing the valve, ensure that the lever or gear operator is installed such that the position indication matches the position of the valve disc. For lever operated valve, the lever should be in parallel with the disc. For gear operated valves, the dial indicator on the gear should match the position of the valve disc.



WARNING:

Personal injury or property damage may result if the valve is installed where service conditions could exceed the valve ratings.

FIGURE 812 - 832

RESILIENT-SEATED BUTTERFLY VALVES



PRE-INSTALLATION

- Before installing the valve, inspect the valve body port and associated equipment for any damage that may have occurred and for any foreign matter that may have collected in shipping or storage. Make certain the body interior is clean and that the seat facings and disc edge surface are undamaged.
- Make sure the valve rating & materials are sufficient for the service which the valve will be installed for.
- Before installing the valve, inspect the piping and remove all dirt, welding slag, rust and scale from the piping and flange faces that could cause leakage. It is advisable to install a strainer upstream of the valve to prevent contamination from entering the valve. It is very important for long trouble-free service to keep the valve free of all contamination that may damage the sealing surface.
- Ensure that the pipe line and mating flanges are properly aligned. Align the primary side pipe with the secondary side pipe properly and make sure the pipes are parallel and there is no distortion. If the alignment is not proper, external leakage, seat leakage or faulty operation may occur.

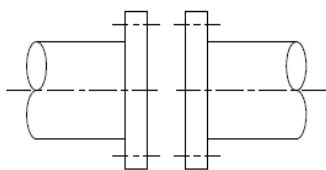

Properly Aligned

O

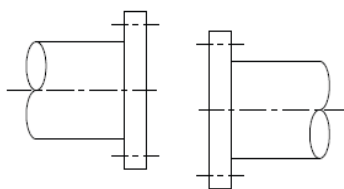

Poor Centering Alignment of the Pipe

X

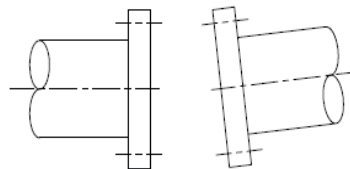

Poor Parallel Alignment

X

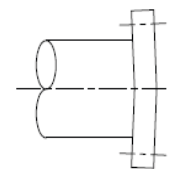

Distortion

X

- When installing, do not stand on the valve or insert the valve by forcing or heating it. Allow at least 6–10mm extra space above the valve face-to-face dimension when installing valve between flanges for proper clearance to avoid damage to seat.
- Heating or welding of pipe shall not be done while the valve is installed as the heat may transfer to the valve, causing damage to the body or seat.
- When installing the valve, actuator facing upward is preferred. Note stem direction carefully when installing at a pump outlet, at an elbow or reducer or when combining a control valve and stop valve. See illustration on next page.
- No gasket required.

FIGURE 812 - 832

RESILIENT-SEATED BUTTERFLY VALVES



PRE-INSTALLATION: PIPING CONSIDERATIONS

Installing a valve at a pump outlet

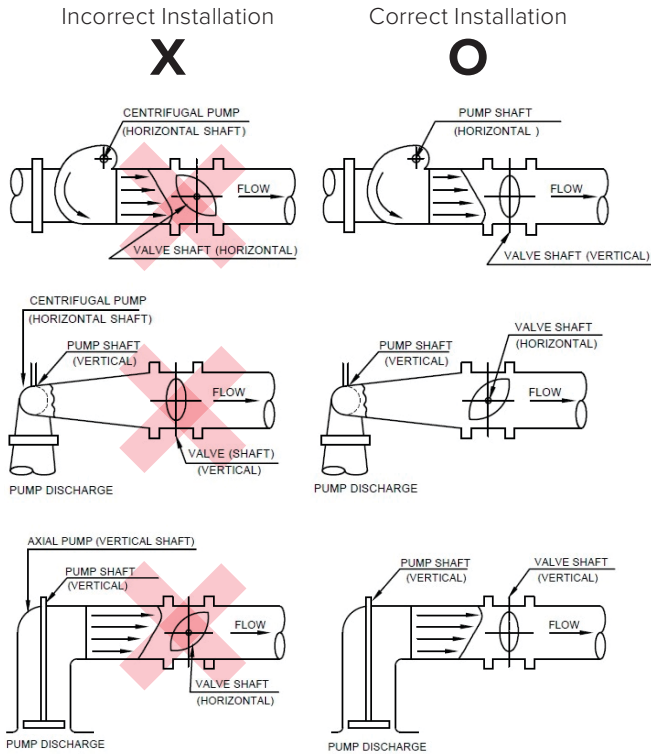

Installing at an elbow or a reducer

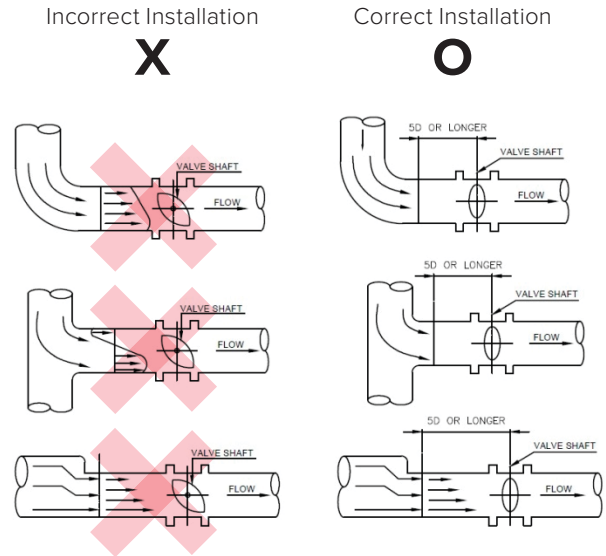

Combination of a control valve and stop valve

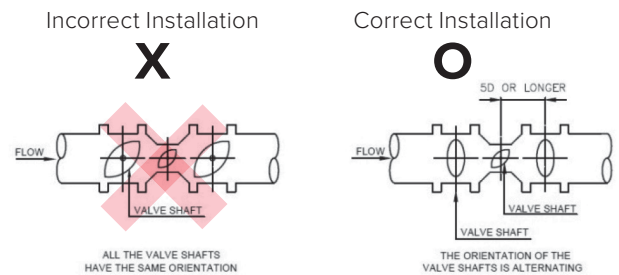

WARNING:

Do not remove the locking lever, gear or other actuators while the valve is under pressure.

FIGURE 812 - 832

RESILIENT-SEATED BUTTERFLY VALVES



PIPING CONSIDERATIONS

7. INSTALLATION CONSIDERATIONS IN PIPING

It is important to make sure the ID of the pipe and pipe flanges is large enough to allow the disc edge to swing into the opening without interference. Damage to the disc edge can severely affect the performance of the valve. Information below shows probable compatibility to various flanges and pipe types; however, due to manufacturing tolerances, the valve disc should always be checked for proper clearance once installed.

Metal Flange

Resilient-seated butterfly valves are designed to meet many different types of flange standards, including ASME, DIN, JIS and other international flange standards. Whether flat faced, raised faced, slip-on, welding-neck, etc., proper alignment of any butterfly valve between flanges is critical to good performance of the valve. The flange bolts must be evenly tightened around the valve, providing consistent flange compression of the molded O-ring in the seat face. See piping bolt pattern in section 8 when tightening bolts.

A uniform flange face is critical to proper valve sealing. Most welding-neck and slip-on flanges conforming to ASME specifications have an appropriate flange face. Type A and B butt-weld stub-end flanges also provide a suitable mating surface for the molded O-ring in butterfly valve seat. Buyer is to ensure that the face of the flange selection creates a proper sealing contact with the valve seat face.

It should be noted that Type C butt-weld stub-end flanges have an “as formed” flange face. The varying surface of this flange face can create sealing problems between any resilient-seated butterfly valve and the flange face. For this reason, Type C flanges are not recommended for use with resilient-seated butterfly valve.

The seat ring might become damaged or the flange may leak if the flange faces contact the valve seat ring as below.

- Excessive weld – The resulting oversized inner pipe diameter may cause a flange leak.
- Sharp edge – Flange face with sharp edge may cause damage to the seat ring.
- Rough surface from grinding on flange face also may cause flange leak.

Make sure that there is no distortion to the flange and that there is no damage, such as scratches or uneven surfaces, in flange faces.

Non-Metal Flange (PVC/Plastic Flange)

When non-metallic flanges, such as plastic or PVF, are used with resilient-seated butterfly valves, be careful not to overtighten the flange bolts. The inherent flexibility of non-metallic flanges allows them to be overtightened relatively easily. Flexing caused by this overtightening can actually reduce the compression of the valve between flanges, causing leaks between the valve and the flange face. Proper alignment and firm even, but not excessive tightening, of flange bolts is especially important with non-metallic flanges. In some cases, non-metallic flanges of low quality will not mate tightly with butterfly valves regardless of the care taken during installation.

Valve Orientation

FNW recommends valve be installed with the stem in vertical position and the actuator mounted vertically directly above the valve. When space restrictions do not allow, valve can be installed in upside-down position. There are special applications where stem should be horizontal. For slurries, sludge, mine, pump stock, dry cement and any other media with sediment or particles, it is recommended that you install with stem in the horizontal position with the lower disc opening in the downstream direction.

FIGURE 812 - 832

RESILIENT-SEATED BUTTERFLY VALVES



INSTALLATION

8. INSTALLATION

Before installation, read “Pre-Installation” in section 6 thoroughly and then perform installation in accordance with the following procedure.



HAZARD/CAUTION:

When installing a non-return valve, pump or flexible joint made of rubber with this product, insert a short pipe between the part and this product. Otherwise, the disc may make contact with the other device during operation, resulting in faulty operation and leakage.



WARNING:

Personnel should take precautions to wear the appropriate personal protection equipment, such as safety shoes with toe protection, gloves, safety glasses and a hard hat. Personnel installing the valves should have the mechanical and handling training for such equipment, including rigging and hoisting techniques. Any process in the pipe lines should be identified to be safe for work prior to starting. The line should be depressurized and drained before installing the valves.

- Clean the flange face that will make contact with valve.
- Remove foreign material from the piping completely before connecting valve to the piping.
- Before installation or removal work, set the valve disc.
- After aligning both flanges, insert the piping bolts and secure the product to prevent it from dropping.
- Insert jack bolts in the position to widen the distance between the flanges. Push the flanges and make the distance between the flanges 6 to 10mm longer than the valve face-to-face dimension. Do not remove the jack bolts until all the piping bolts are installed.



NOTICE:

Do not suspend this product by hanging on hook, etc., or by the handle. Suspend the product by tying down a well-balanced position, such as the neck section of the product, with material that does not damage the body, such as a nylon sling.

- When inserted completely, insert the piping bolts to support the alignment. Follow Piping Bolt Tightening Procedure.
- After all the piping bolts are installed, remove the jack bolts.
- Align the flanges with the product accurately. Tighten the piping bolts with the following procedures so as not to tighten the bolts on one side too much or too little. For this product, fluid is sealed by the seat ring compressed with the force as a result of the pipe flange compressing the seat ring. When connecting the product to the piping, align the center of this product with the center of the flange to press the seat ring accurately. If this product is operated while the centers are not aligned, breakage, faulty operation, external leakage or seat leakage may occur. See illustration on next page.

FIGURE 812 - 832

RESILIENT-SEATED BUTTERFLY VALVES



INSTALLATION

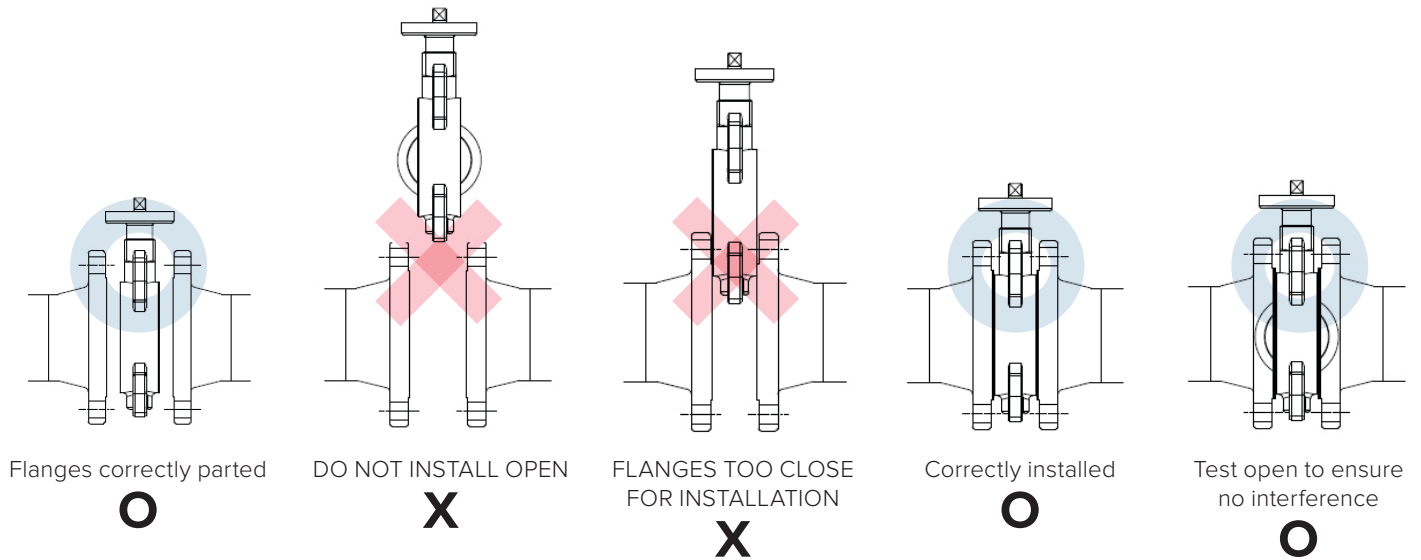

- For accurate alignment between the flanges and valve, tighten the flanges at both sides.
- After installation, open and close the valve to verify that operations from/to full-open to/from full-close are smooth and disc is not binding or making contact with inside of pipe.

FIGURE 812 - 832

RESILIENT-SEATED BUTTERFLY VALVES



INSTALLATION: BOLT TIGHTENING

Piping Bolt Tightening Procedure

- Clean the bolts and nuts and apply lubricant to them.
- Do not use rusty or damaged bolts and nuts.
- Tighten the bolts and nuts by hand. Tighten the bolts and nuts in any desired order with approx. 20% of specified tightening torque.
- Tighten the bolts and nuts, alternate diagonally with approx. 70% of the specified tightening torque.
- Tightening the bolts and nuts, alternate diagonally with approx. 100% of the specified tightening torque.
- Bolts that are tightened once may become loose due to stress relaxation of the piping gaskets. Be sure to perform re-tightening repeatedly until the bolts and nuts are tightened evenly.

RECOMMENDED BOLT TIGHTENING TORQUE (CLASS 150) FOR METAL FLANGE

Size of Valve	Size of Bolt	Recommended Torque (ft/lb)
2"	5/8"-11 UNC	40
2-1/2"	5/8"-11 UNC	40
3"	5/8"-11 UNC	40
4"	5/8"-11 UNC	40
5"	3/4"-10 UNC	50
6"	3/4"-10 UNC	50
8"	3/4"-10 UNC	50
10"	7/8"-9 UNC	80
12"	7/8"-9 UNC	80
14"	1"-8 UNC	120
16"	1"-8 UNC	120
18"	1-1/8"-7 UNC	200
20"	1-1/8"-7 UNC	200
24"	1-1/4"-7 UNC	260
28"	1-1/4"-7 UNC	260
30"	1-1/4"-7 UNC	260
32"	1-1/2"-6 UNC	440
36"	1-1/2"-6 UNC	440
40"	1-1/2"-6 UNC	440
42"	1-1/2"-6 UNC	440
48"	1-1/2"-6 UNC	440

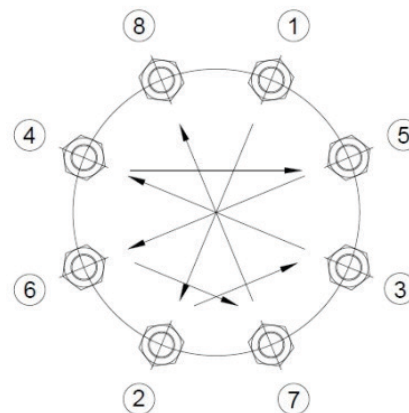

NOTICE:

The values above are for the class 150 Metal Flange only and it is recommended to use the minimum torque as higher torque can increase the compression on the valve seat. If using thermoplastic flange such as PVC, refer to the thermoplastic manufacturer's recommended bolt torque value.

FIGURE 812 - 832

RESILIENT-SEATED BUTTERFLY VALVES



OPERATION & MAINTENANCE

9. OPERATION

Lever Operated

- Valves are typically supplied with a locking lever plate. Squeeze the handle and locking lever together to disengage the locking lever plate. Open and close the valve by turning the handle one-quarter turn (90°).
- The valve is in the open position when the handle is parallel to the pipe. The valve is in the closed position when the handle is perpendicular to the pipe.

Gear Operated

- The valve is operated by turning the hand wheel in the desired direction. Typically, counter clockwise is towards open, and clockwise is towards closed.
- Position is indicated by the pointer on the top of the gear operator.

Actuator

- Please refer to each Actuator's manual on operation.

10. MAINTENANCE

Typical maintenance consists of periodic inspection and exercising cycling of the valve to ensure proper function. Valve parts are subject to normal wear and should be inspected and replaced as necessary. Inspection and maintenance frequency depends on the severity of the service conditions. The following periodic preventative maintenance practices are recommended:

- Operate the valve from full open to full close to ensure operability.
- Check flange bolting for evidence of loosening and correct as needed.
- Inspect the valve surrounding area for previous or existing leakage at flange faces or stem.
- Check piping and/or wiring to actuator and related equipment for looseness and correct as needed.



WARNING:

To avoid personal injury to yourself, fellow workers or damage to property, prior to any maintenance, verify the following conditions:

- Be sure the line is depressurized and drained.
- Be sure of the pipe line media. Proper care should be taken for protection against toxic and/or flammable fluids.
- Never remove the valve without an operator (manual or automatic) already attached to the valve shaft.
- Never remove the operator from the valve while the valve is in the pipeline under pressure.
- Always be sure disc is in the near closed position before removing the valve.

FIGURE 812 - 832

RESILIENT-SEATED BUTTERFLY VALVES



TROUBLESHOOTING INFORMATION

11. TROUBLESHOOTING

Trouble	Probable Cause	Countermeasure/Remedy
Leakage from between the body and piping flange faces	The piping bolts are loose or they were not tightened evenly.	After reducing the pressure, loosen the piping bolts, and then re-tighten them by diagonal sequence. (Refer to “Piping bolt tightening procedures”.)
	The piping flange face is scratched or there is waste material or other foreign material adhering.	Remove the valve. Repair and clean the piping flange face. After cleaning, install the valve again.
	The flanges or pipes are misaligned.	Remove the valve. Align the flange/pipes and make the flanges/ pipes parallel.
	Torn or damaged seat	Remove the valve body and check the seat for signs of tearing or other damage. If any damage is observed, replace the valve with new one.
Leakage from the bottom plug or plate	The bottom plug or plate installation bolts are loose.	Retighten the bottom cover installation bolts.
	The valve is misaligned.	Loosen the bolts and realign the valve correctly.
	Torn or damaged seat	Remove the valve body and check the seat for signs of tearing or other damage. If any damage observed, replace the valve.
Valve seat leakage	Wrong material was selected for the fluid application and the parts are corroded.	Replace the valve with one made of the proper material. For details, please contact us regarding seat selection.
	Movement of disc in the fully closed position	Adjust the fully closed position of the disc.
	The disc cannot fully close due to insufficient output from the actuator.	Refer to the actuator selection table for correction. Check Actuator Supplier’s Manual.
	Fluid specification is not compatible with valve specification.	Re-check the specifications.
	Torsion of stem due to an unusual increase in opening/closing torque	Replace the valve body.
	Movement of disc in fully closed position due to loose actuator installation bolts	Re-adjust the fully closed disc position by retightening the installation bolts.
	Uneven connection between seat and disc due to unequal tightening	Loosen the piping bolts and then retighten them.
Wearing and deterioration of the seat due to long period of use or high frequency of opening and closing operations	Replace the valve.	

FIGURE 812 - 832

RESILIENT-SEATED BUTTERFLY VALVES



TROUBLESHOOTING INFORMATION

Problem	Main Cause	Countermeasure/Remedy
The valve does not work. Faulty operation	The disc interferes with the piping or other devices.	Insert a short pipe or spacer between the valve and flange to avoid interference. (Section 8) In this case, remove and check the disc sealing part because there is a high possibility that it is damaged.
	The valve is deformed or damaged.	Check the appearance of the body, disc and shaft to ensure that there is no deformation, dent, damage, corrosion, etc. If any of these are observed, replace the valve.
	Actuator parts are damaged.	For details, refer to the instruction manual of the actuator.
	The piping bolts are loose or tightened unevenly. The valve is misaligned. The pipe flanges are misaligned, not parallel, or distorted.	If tightening force of the bolts is uneven or the contact areas are not equal, the valve seat compression is uneven and the torque may increase. Loose the bolts and retighten them by diagonal sequence. (Refer to "Piping bolt tightening procedures".)
	Increased torque due to presence of foreign material in the piping	Set the valve to the full-open position and flush the foreign material out to remove it. In this case, remove and check the disc sealing part because there is a high possibility that it is damaged.
	Powdered foreign material inside the piping enters the bearings	If rust powder or powdered foreign material is inside the piping, any foreign material which entered the bearings may interfere with the shaft rotation. If there is a possibility of this, remove the valve and clean it.
	The product specifications do not conform to the fluid specifications	For automatic valves, the actuator size is selected in accordance with the working conditions (temperature, pressure, flow rate, fluid type). If the working conditions are changed, the valve may not work due to insufficient actuator torque. Please contact our sales department.
	The actuator rated output is not available (For automatic valves)	For cylinders, check the following items: <ul style="list-style-type: none"> • The rated supply pneumatic pressure and the supply amount are secure. • The bypass valve is closed. • The operation air stop valve is open. • The speed controller is open properly. • The exhaust port plug has been removed. For motors, check the following items: <ul style="list-style-type: none"> • The rated power voltage is supplied. • Voltage is applied to the motor properly. • The thermal protector, etc. is not activated. • Two or more actuators are not operated with one switch. • No water is inside the motor. For details, refer to the instruction manual of each actuator.
	The valve body is deformed because abnormal force is applied	If a support is installed to the valve neck section or actuator, the support may produce a force that deforms the valve. Remove the support member and check the valve.
	Abnormal interference of the disc due to damage or deformation of the seat	Replace the seat. If any abnormality is observed on the disc edge, replace the valve.
Parts, such as the disc, shaft, body and joint, are damaged	If none of the above is applicable, the valve parts may be damaged and replacement of the parts may be required. Please contact our sales department.	

FIGURE 812 - 832

RESILIENT-SEATED BUTTERFLY VALVES



PART INFORMATION

12. PART INFORMATION

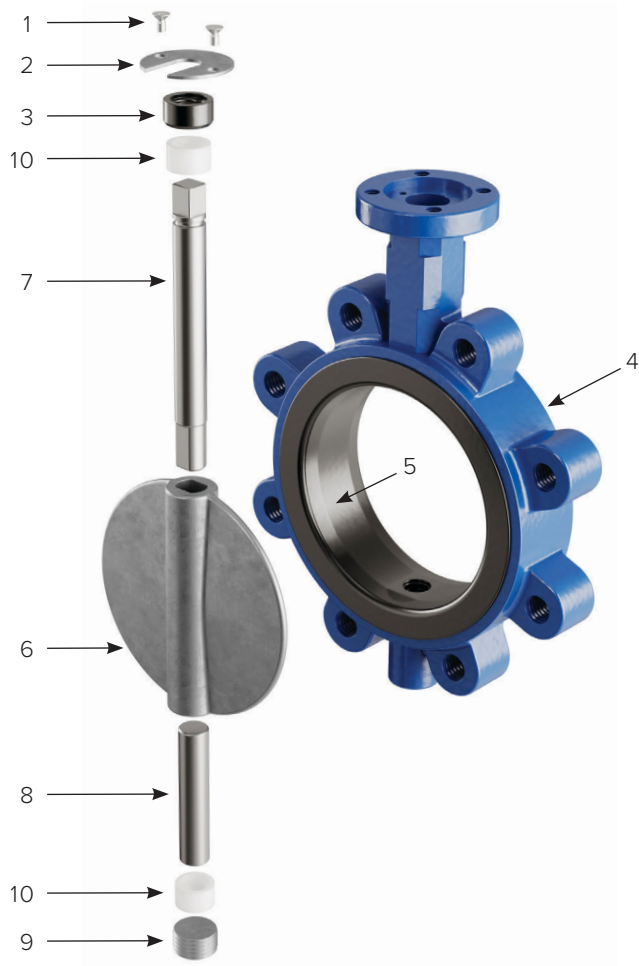

PART MATERIALS & QUANTITY

Ref #	Description	Material
1	Top Retainer Bolt	Zinc Plated Carbon Steel, A36
2	Retaining Plate	Zinc Plated Carbon Steel, A36
3	Ingress Seal	EPDM, Buna-N or Viton
4	Body	Ductile Iron, A536
5	Seat	EPDM Buna-N (NBR) Viton
6	Disc	Stainless Steel, CF8M Aluminum Bronze, B148
7	Upper Stem	Stainless Steel 316
8	Lower Stem	Stainless Steel 316
9	Plug	Zinc Plated Carbon Steel, A36
10	Bushing	PTFE

FIGURE 812 - 832

RESILIENT-SEATED BUTTERFLY VALVES



INSPECTION

Inspection Descriptions	Inspection Points	Inspection Procedure	Countermeasure
Fluid external leakage	Pipe joints	Visual check	Retightening the piping bolt and nuts. Align the valve center with the pipe center and retighten the piping bolts.
	Bottom & valve surface	Visual check	Disassembly and maintenance. Spare part replacement if required. Valve replacement.
Abnormal noise, vibration	Appearance of the valve and actuator, piping around the valve bolts and nuts	Listening Check by touch	Change the valve opening. Review the flow rate and pressure. Retightening the bolts and nuts. Remove the source of vibrations. Disassembly and maintenance. Check for damage of the parts.
Looseness of the bolts and nuts	Bolts and nuts	Visual check Check by touch	Retighten the bolts and nuts. Retighten the pressure part after reducing pressure.
Seat leakage	Presence or absence of leakage from the secondary side (Flow meter, pressure gauge, drain)	Listening, visual check, measurement	Check the opening and closing positions are correct with the indicator. Remove foreign material. Remove the valve from the piping and perform check and cleaning. Replace spare parts.
Valve operation check	Check of opening and closing positions	Visual check Operation check	Check that the opening and closing positions are correct with the indicator.

If repair parts or service information is required, please locate valve identification information and supply following information:

- Valve figure number
- Valve size/class
- Manufacturer date/valve serial number

BOTTOM PLUG SIZE & RECOMMENDED TIGHTENING TORQUE

Size of Valve	Plug Size	Length of Plug	Recommended Torque (ft/lb)
2"-3"	7/8"-9 UNC	15mm	80
4"	1"-8 UNC	15mm	120
5"-6"	1-1/8"-7 UNC	15mm	200
8"	1-1/4"-7 UNC	15mm	260
10"-14"	1-1/2"-6 UNC	15mm	440
16"	2"-4 UNC	25mm	1180

FIGURE 812 - 832

RESILIENT-SEATED BUTTERFLY VALVES



ASSEMBLY INSTRUCTIONS

13. BUTTERFLY VALVE ASSEMBLY



1. Prepare all the requested parts and check the condition before start assembling process.



2. Insert bushing(s) into the lower stem hole. Check the valve's bill of materials for correct quality and type of bushings.



3. With lubricant, insert the lower stem into the body. Push the stem so that just the tip comes through the seat.



4. Insert the bottom of the disc into the seat over the lower stem. With the disc in the partially open position, push or tap the top of the disc to align with the upper stem hole.



5. Insert the lower stem into the disc by pushing the valve body and disc assembly down onto the stem. Then tap the lower stem further in beneath the internal threads in the body.

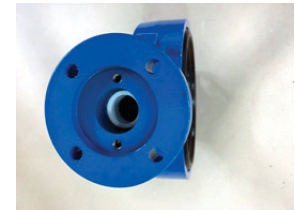

6. Insert bushings(s) into the upper stem hole, Note that 14" and larger valves have a long bushing that should be installed first.

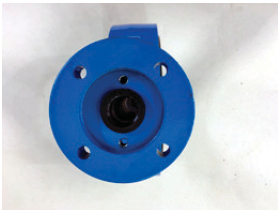

7. Insert O-ring packing. Note that on 14" and larger valves, the O-ring is installed between the upper two bushings.



8. With lubricant, insert the upper stem almost all the way into the body. Make sure the stem flats are aligned with the receiving hole in the disc.



9. If necessary, drive the upper stem into the disc with a rubber mallet. If there is much resistance, make sure the stem flats are aligned appropriately to the disc.



10. Slide the retaining plate onto the groove located just below the square drive of the stem. Align the screw holes with the holes in the body's top flange.



11. With a rubber mallet, tap the upper stem the remainder of the way into the stem. Secure the retainer plate with flat head counter-sunk screws.



12. Insert the lower stem plug by first applying pipe dope such as Loctite® or an equivalent product to secure the plug.

FIGURE 812 - 832

RESILIENT-SEATED BUTTERFLY VALVES



ASSEMBLY INSTRUCTIONS



13. Screw the lower stem plug in place using a hex wrench. Do not overtighten the plug on lower stem.



14. If facilities are available, test the valve for torque and shutoff.



15. The valve is now complete and ready for installation of hand lever or gear operator.

16. Lever

- Install the locking plate indicated over the stem. Friction tab may need to be slightly twisted for a new hold.
- Install lever over stem and tighten set screw.
- For 2" to 8" valves, install the lever washer and bolt.
- Ensure that the close position of the lever closes the valve and tighten all bolts.

17. Gear

- The hand wheel shaft should be perpendicular to the pipe after installation.
- Make sure the gear position matches the position of the valve. Position is indicated on the top plate of the gear.
- If there is a make-up sleeve for the stem, place it over the stem at this time.
- Set the gear on the stem and secure with bolts and lock washers.
- Ensure that the disc is fully closed when the gear-operator is in the closed position. Adjust as needed.

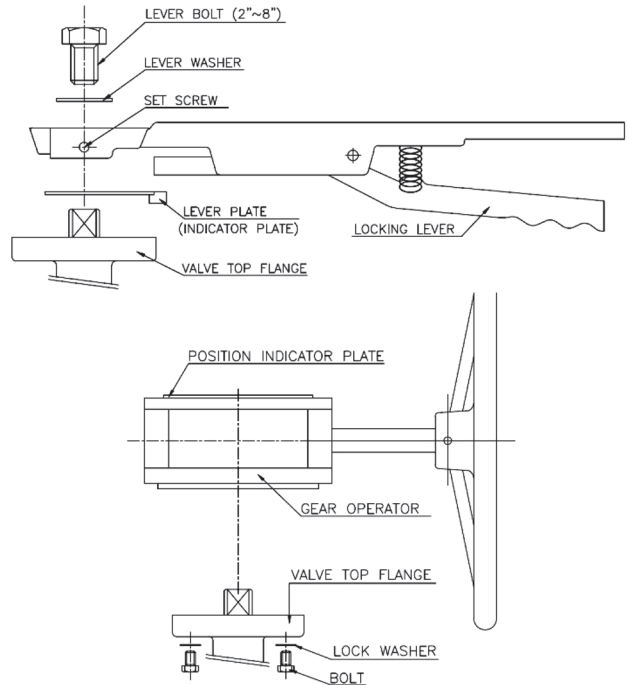

FIGURE 812 - 832

RESILIENT-SEATED BUTTERFLY VALVES



VALVE DISASSEMBLY

14. PRECAUTIONS BEFORE DISASSEMBLING THE VALVE FROM THE LINE

- Fluid flowing in a pipe could be corrosive, toxic, flammable or contaminated. Before removing valve, inspect that no pressure is present in line, either upstream or downstream of the valve. Be sure the line is depressurized and drained.
- Be sure of the pipe line and media. Proper care should be taken for protection against toxic and/or flammable fluids.
- Never remove the operator from the valve while the valve is in the pipeline under pressure.
- The following safety precautions are recommended when repairing the valve.
 - Always wear protective glasses or eye shields.
 - Always wear gloves and protective footwear.
 - Ensure easy availability of running water.
 - Have ready an adequate fire extinguisher if media is flammable.

15. REMOVAL OF VALVE FROM PIPING

- Check to confirm piping has been depressurized and drained.
- Actuate valve until in full closed position.
- Attach appropriate lifting strap or sling to valve neck. Attach other end of strap or sling to secure point weight capable of supporting valve.
- Shut almost completely the disc. Remove all nuts and all bolts with the exception of the two lowest sustaining the valve.
- Spread the flanges with proper tools and remove valve to substitute seat and disc. (Do not use the valve to spread flanges, because seat damage might be the result.)

16. BUTTERFLY VALVE DISASSEMBLY

The valve can be disassembled in the reverse order of the assembly instructions. Note the following to ease disassembly and to help protect valve components.

- Materials and number of parts can vary by size and configuration.
- Use of a lubricant is recommended for disassembly of disc from seat. Make sure the lubricant used is compatible with the valve materials and the service the valve is used in.
- Component tolerance can be rather tight. It may be necessary, depending on the size of valve, to use mechanical means to remove all components.
- Make sure a clean area is available to work in and to place disassembled parts.
- Parts should be protected from dirt, dust and possible damage.

FIGURE 812 - 832

RESILIENT-SEATED BUTTERFLY VALVES



WARRANTY INFORMATION

17. WARRANTY

LIMITED WARRANTY:

Subject to the limitations expressed herein, Seller warrants that products manufactured by Seller shall be free from defects in design, material and workmanship under normal use for a period of one (1) year from installation but in no case shall the warranty period extend longer than eighteen months from the date of sale. This warranty is void for any damage caused by misuse, abuse, neglect, acts of God or improper installation. For the purpose of this section, "Normal Use" means in strict accordance with the installation, operation and maintenance manual. The warranty for all other products is provided by the original equipment manufacturer.

REMEDIES:

Seller shall repair or replace, at its option, any non-conforming or otherwise defective product, upon receipt of notice from Buyer during the Manufacturer's warranty period at no additional charge. SELLER HEREBY DISCLAIMS ALL OTHER EXPRESSED OR IMPLIED WARRANTIES, INCLUDING, WITHOUT LIMITATION, ALL IMPLIED WARRANTIES OF MERCHANTABILITY AND FITNESS OR FITNESS FOR A PARTICULAR PURPOSE.

LIMITATION OF LIABILITY:

UNDER NO CIRCUMSTANCES SHALL EITHER PARTY BE LIABLE TO THE OTHER FOR INCIDENTAL, PUNITIVE, SPECIAL OR CONSEQUENTIAL DAMAGES OF ANY KIND. BUYER HEREBY ACKNOWLEDGES AND AGREES THAT UNDER NO CIRCUMSTANCES, AND IN NO EVENT, SHALL SELLER'S LIABILITY, IF ANY, EXCEED THE NET SALES PRICE OF THE DEFECTIVE PRODUCT(S) PURCHASED DURING THE PREVIOUS CONTRACT YEAR.

LABOR ALLOWANCE:

Seller makes NO ADDITIONAL ALLOWANCE FOR THE LABOR OR EXPENSE OF REPAIRING OR REPLACING DEFECTIVE PRODUCTS OR WORKMANSHIP OR DAMAGE RESULTING FROM THE SAME.

RECOMMENDATIONS BY SELLER:

Seller may assist Buyer in selection decisions by providing information regarding products that it manufactures and those manufactured by others. However, Buyer acknowledges that Buyer ultimately chooses the product's suitability for its particular use, as normally signified by the signature of Buyer's technical representative. Any recommendations made by Seller concerning the use, design, application or operation of the products shall not be construed as representations or warranties, expressed or implied. Failure by Seller to make recommendations or give advice to Buyer shall not impose any liability upon Seller.

EXCUSED PERFORMANCE:

Seller will make a good faith effort to complete delivery of the products as indicated by Seller in writing, but Seller assumes no responsibility or liability and will accept no back-charge for loss or damage due to delay or inability to deliver, caused by acts of God, war, labor difficulties, accidents, inability to obtain materials, delays of carriers, contractors or suppliers or any other causes of any kind whatever beyond the control of Seller. Under no circumstances shall Seller be liable for any special, consequential, incidental, or indirect damages, losses, or expense (whether or not based on negligence) arising directly or indirectly from delays or failure to give notice of delay.