

Installation and Owner's Manual WIRED PROGRAMMABLE THERMOSTAT

DRSTAT101

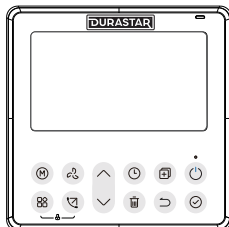

Model Number:

Serial Number:

Purchase Date:

Installing Contractor Company Name:

TIP



Capture relevant information about your Durastar mini-split equipment before it is installed and write it above for future reference.

TABLE OF CONTENTS

COMPATIBILITY CHART	3
INTRODUCTION	4
SAFETY WARNINGS	5
FCC COMPLIANCE STATEMENT	8
INCLUDED ACCESSORIES	10
DIMENSIONS	12
INSTALLATION CONSIDERATIONS.....	12
MOUNTING THE THERMOSTAT	14
WIRING THE THERMOSTAT	18
LCD DISPLAY	26
BUTTON DESCRIPTIONS	27
INITIAL SETUP.....	30
OPERATING MODES	32
FUNCTIONS	35
TIMER FUNCTIONS.....	46
QUERIES AND SETTINGS	59
LED DISPLAY INDICATORS	67
TROUBLESHOOTING.....	68
LIMITED WARRANTY - PARTS.....	70

COMPATIBILITY CHART

This chart shows the compatibility and connection method of the DRSTAT101 with various indoor units.

	MODEL TYPE	COMPATIBILITY	CONNECTION METHOD
R-410A UNITS	DRAW_F1A	No	--
	DRAW_F1B	Yes	XYE/12V via DRPDRAWMFB1
	DRAC_F1A, DRAC_F1B	Yes	4-pin cable
	DRAL_F1A	Yes	4-pin cable
	DRAF_F1A	Yes	4-pin cable
	DRAS12F1A, DRAS12F1B	No	--
	DRAD_F1A	Yes	4-pin cable
	DRAM_F1A	Yes	4-pin cable or HA/HB
R-454B UNITS	DRAW_F2A	Yes	XYE/12V
	DRAC_F2A	Yes	HA/HB
	DRAL_F2A	Yes	HA/HB
	DRAF_F2A	Yes	HA/HB
	DRAS_F2A	Yes	4-pin cable
	DRAD_F2A	Yes	HA/HB
	DRAM_F2A	Yes	HA/HB
	DRUM_S2A	Yes	HA/HB

**NOTE**

Please note that for connection to a DRAW_F1B wall unit, part number DRPDRAWMFB1 **must be ordered separately.**

For the DRAW_F2A wall unit the DRPDRAWMFB1 used for XYE/12V connection is included in the unit.

INTRODUCTION

To better serve you, please do the following before contacting customer service:

- If you received a damaged product, immediately contact the retailer or dealer that sold you the product.
- Read and follow this manual carefully to help you install and use your thermostat.
- The troubleshooting section at the end of the manual may solve common problems. Contact a trained service provider if errors persist.
- Visit us on the web at www.durastar.com to download product guides and up-to-date information.
- If you need warranty service, our friendly customer service representatives are available via email at questions@durastar.com or by telephone at 1-888-320-0706.



SAFETY WARNINGS

- It is recommended that a professional install this thermostat. Improper installation could lead to abnormal operation, electric shock, or fire.
- Use the wiring specified in this manual.
- The shielded wire must be grounded.
- The 4-pin connecting cable should not be longer than 65.5' (20m).
- The thermostat operates on a low voltage circuit loop. DO NOT connect a 115V, 220V or 380V cable to the circuit loop.
- DO NOT randomly uninstall the thermostat, this may lead to abnormal operation, heating or fire.
- DO NOT use an ohmmeter to detect the insulation after wiring the thermostat.
- DO NOT install the thermostat near flammable liquids or gases. Doing so creates a fire hazard.
- DO NOT operate the unit with wet hands, as this could lead to electrical shock.
- DO NOT remove the cover or touch the interior parts of the remote control.
- DO NOT use sharp or pointed objects to press the remote control buttons.

**BATTERY WARNING**

Battery type: CR2032
 Battery power supply: 3.0V



WARNING: Contains coin battery.

⚠ WARNING

INGESTION HAZARD: This product contains a button cell or coin battery.

• BATTERY WARNING: KEEP OUT OF REACH OF CHILDREN;

- If the battery compartment (if applicable) does not close securely, stop using the product and keep it away from children;
- If you think batteries might have been swallowed or placed inside any part of the body, seek immediate medical attention.

**BATTERY WARNING****KEEP OUT OF REACH OF CHILDREN.**

Swallowing can lead to chemical burns, perforation of soft tissue, and death. Severe burns can occur within 2 hours of ingestion. Seek medical attention immediately.

**WARNING**

INGESTION HAZARD: This product contains a button cell or coin battery. **DEATH** or serious injury can occur if ingested.

A swallowed button cell or coin battery can cause **INTERNAL CHEMICAL BURNS** in as little as 2 hours.

KEEP new and used batteries **OUT OF REACH OF CHILDREN**

Seek immediate medical attention if a battery is suspected to be swallowed or inserted inside any part of the body.



Button Battery Warnings

- Remove and immediately recycle or dispose of used batteries or batteries not in use for an extended time, according to local regulations. Do NOT dispose of batteries in household trash or incinerate.
- Even used batteries may cause severe injury or death.
- Non-rechargeable batteries are not to be recharged.
- Do not force discharge or recharge, disassemble, operate outside temperature range -4°F - 158°F (-20° - 70°C), or incinerate. Doing so may result in injury due to venting, leakage, or explosion resulting in chemical burns.
- Ensure the batteries are installed correctly according to polarity (+ and -).
- Do not mix old and new batteries, or different brands or types of batteries, such as alkaline, carbon-zinc, or rechargeable batteries.
- Remove and immediately recycle or dispose of batteries from equipment not used for an extended period of time according to local regulations.
- Always completely secure the battery compartment. If the battery compartment does not close securely, stop using the product, remove the batteries, and keep them away from children.

FCC COMPLIANCE STATEMENT

This thermostat complies with part 15 of the FCC Rules for Class B digital devices per the declaration of conformity below. These guidelines are meant to prevent against harmful interference in residential applications. This equipment generates a radio frequency that can interfere with radio communications if the unit is not installed in accordance with the installation manual provided and used in accordance with the owners manual provided. As mentioned in the installation manual, do not run the equipment's power and communication cables in parallel with antenna cables. If interference does occur, you are encouraged to try relocating the antenna or receiver and increasing the distance between the antenna and the equipment.

**NOTE**

This device complies with CAN ICES-3(B)/NMB-3(B) for sale in Canada.

**Supplier's Declaration of Conformity
Per FCC Part 2 Section 2.1077**

Unique Identifier: DRSTAT101

Responsible Party – U.S. Contact Information

Company name: Ferguson Enterprises LLC

Street Address: 751 Lakefront Commons

City, State: Newport News, VA

Postal Code: 23606

Telephone number or internet contact information: Durastar.com

FCC Compliance Statement

This device complies with Part 15 of the FCC Rules. Operation is subject to the following two conditions: (1) This device may not cause harmful interference, and (2) this device must accept any interference received, including interference that may cause undesired operation.

INCLUDED ACCESSORIES

The following items are included in the kit:

ACCESSORY	QTY	NOTES
Installation and Owner's Manual	1	----
DRSTAT101 Thermostat	1	----
M4 x 25 Mounting Screws	3	Used to mount the thermostat
Wall Anchors	3	----
Plastic Screw Bars	2	----
Battery	1	Optional (used for the clock)
M4x8 Screw	1	For grounding the DRPDRSTATEXT1 wire
DRPDRSTATEXT1	1	4-pin 20ft shielded wire extension
DRPDRSTATXYE	1	Used for connecting to DRPDRAWMFB1 board
DRPDRSTATADPT1	1	Blue plug wire that connects to the thermostat
DRPDRSTATADPT2	1	Red plug adapter that connects between 20ft wire extension and board (only some units)

Field Supplied Installation Accessories

The following installation accessories are required and must be purchased separately.

- Switch box
- Wiring Tube(Insulating Sleeve and Tightening Screw)
- DRPDRAWMFB1 (if installing with a DRAWxxF1B indoor unit)

Optional Accessories

The following installation accessories are optional and can be purchased separately.

- Putty

Tools Needed

The following tools are required for installation.

- Phillips screwdriver
- Flat head thermostat screwdriver
- Drill

DIMENSIONS

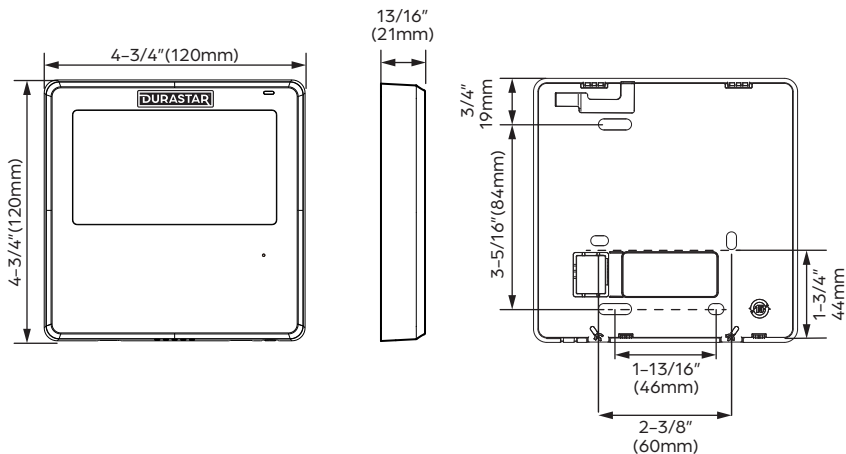

INSTALLATION CONSIDERATIONS

Before installing the thermostat, consider the following requirements.

DO mount the thermostat:

- On a wall without water or drainage pipes
- At a height approximately 48 in. from the floor.

DO NOT mount the thermostat:

- Near heat sources, like electrical devices, dimmer switches, heaters, or direct sunlight
- Close to windows, on outside walls, or by doors leading outside
- Near curtains or shelves that might restrict air movement
- Where the unit's discharge airflow will blow on the thermostat

WARNING

Electrical shock can cause personal injury or death. Before installing the thermostat, shut off all power to this equipment. There may be more than one power disconnect. Tag all disconnect locations to alert others not to restore power until work is completed.

CAUTION

Failure to follow this caution may result in equipment damage or improper operation. Improper wiring or installation may damage the thermostat. Check to make sure wiring is correct before proceeding with installation or turning on unit.

MOUNTING THE THERMOSTAT

Review the steps to connect the thermostat to help determine placement.



NOTE

The thermostat can be surface mounted with an exposed wire or mounted to an electrical box with the wire embedded. Follow NEC and local codes for your area.

Embedded Electrical Box Wiring

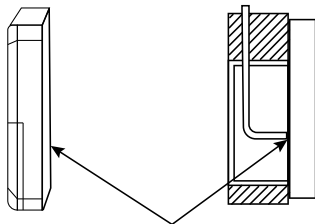

Wiring Hole

Surface Mounting Through The Wall

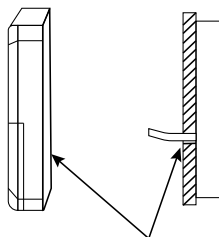

Diameter of Wall Hole $\Phi 3/4$ in (2cm)

1. Remove the top panel of the thermostat by inserting a screwdriver into the two slots on the bottom and twisting. Be careful not to break the tabs on the cover and do not pry up and down with the screwdriver.

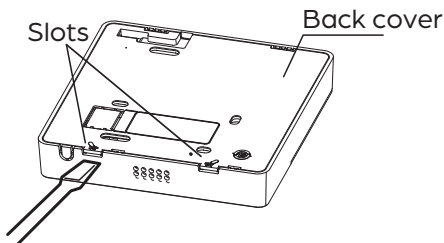
**WARNING**

Over-tightening the screw will cause deformation to the rear cover and LCD damage.

2. Mount the back plate of the thermostat to the wall or the electrical box with three (3) M4 screws. Use anchors provided if necessary. Do not over-tighten.

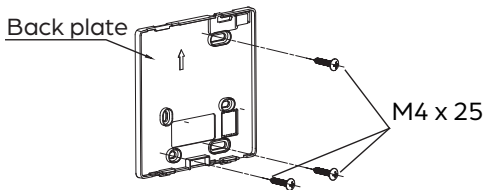
**CAUTION**

Over-tightening the screw will cause deformation to the rear cover and LCD damage.

3. Thread the wire through the wall hole and wire the thermostat depending on your connection method. See *Wiring the Thermostat*.

NOTE

In order to prevent water or condensation getting into the thermostat, we recommend making a loop with the wire or using putty.

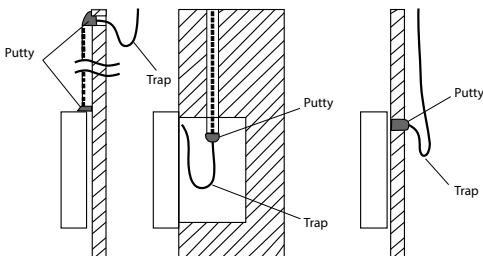

4. Button Battery Installation (Optional)

Battery type: CR2032

Battery power supply: 3.0V

On a flat surface, insert the battery into the top panel of the thermostat. Make sure to match polarity symbols. When the unit is operational, set the correct time. The battery will keep the time, even if the wired power fails. If the time displayed after a power failure is incorrect, the battery is dead and needs to be replaced.

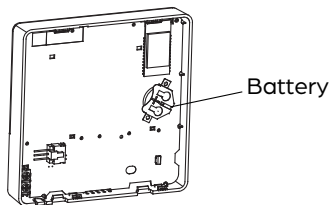

5. Reattach the top panel of the thermostat.

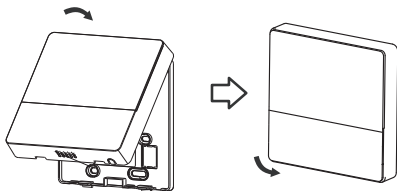

WIRING THE THERMOSTAT

WIRE SPECIFICATIONS	
Input Voltage	DC 12V
Ambient Temperature	32-110°F (0-43°C)
Ambient Humidity	40-90% RH
4-Pin Connection Max Length	65 ft (20m)
Non-Polar 2-Conductor Wire Gauge	16 AWG - 20 AWG*
HA/HB Non-Polar 2-Conductor Wire Max Length	65 ft (20m) to first unit in series, 65ft between units

*On new installations or if you experience communication interference, it is strongly suggested to use 16 AWG stranded, shielded wire.

Using Provided 4-Pin Connecting Cables

Using the wires and adapters provided, connect the thermostat to the indoor unit's board. Connection methods will differ depending on the indoor unit model. Reference the chart on page 3 to determine which method to use.

NOTE



Only two additional 20' DRPDRSTATEXT1 can be linked to the cable provided for a maximum length of 65' (20m).

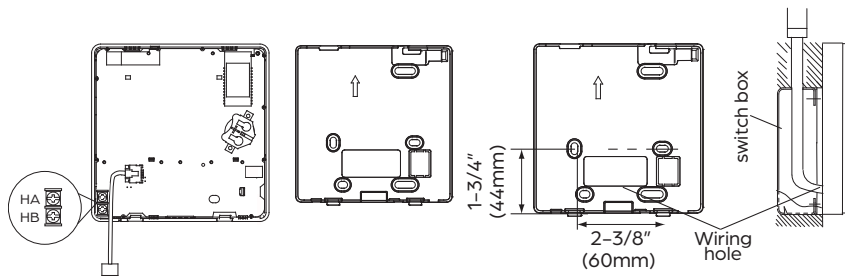

4-pin Cable Connection Method

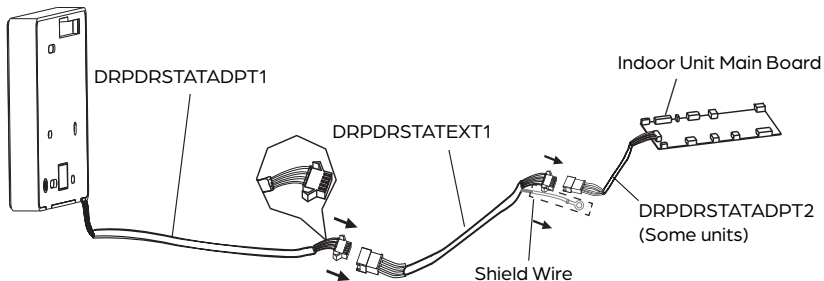

XYE/12V Connection Method for DRAW_F1B High Wall Indoor Units (DRPDRAWMFB1 purchased separately) and DRAW_F2A High Wall (DRPDRAWMFB1 included)

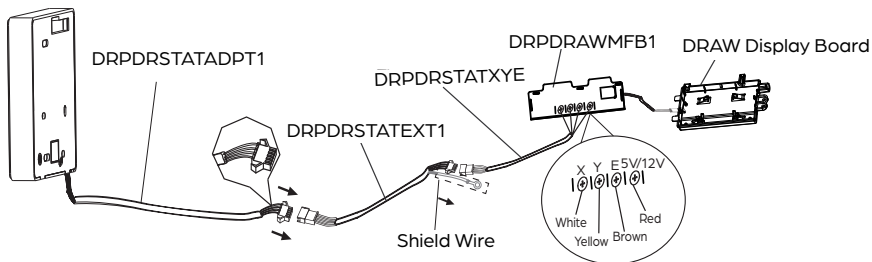

Installing the DRPDRAWMFB1 Multifunction Board (For DRAWxxF1B units)

Included Parts

- DRPDRAWMFB1
- 2-wire cable
- 7-wire branching cable (7-pin plug to a 3-pin plug and 4-pin plug)

Wiring Diagram

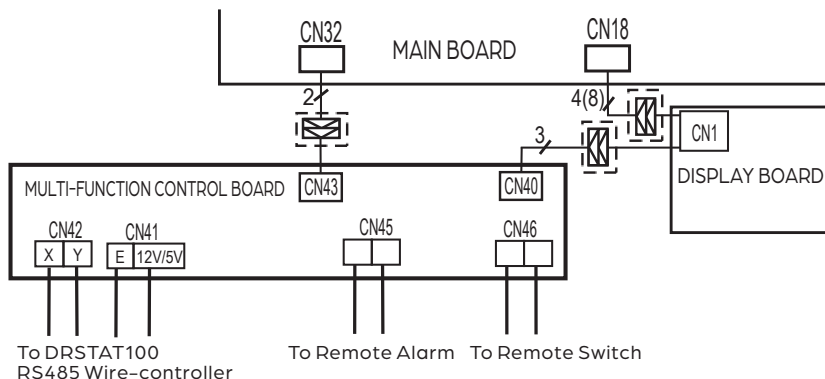

Installation Steps

1. Open the front cover of the unit.
2. Mount the multifunction board to mounting location built into the inside of the front cover of the wall unit.
3. Unplug and remove the 7-pin (4-wire) cable from CN1 on the display board to the 4-pin connecting jack. Leave the wire coming from the main control board in place. The wire that was removed can be discarded.
4. Using the branching cable provided, plug the 7-pin plug coming into CN1 on the display board. Plug the 3-wire plug into CN40 on the multifunction board into the display board. Plug the male 4-wire plug into the female 4-wire cable leading to the main control board.
5. Plug the 2-wire cable provided into the 2-pin (yellow/brown) wire coming from port CN32 on the main board and then into port CN43 on the multifunction board.
6. Feed the wires through the channels on the indoor unit to avoid crimping the wires when closing the front cover.

Using the Non-polar 2-Wire Connection (HA/HB)

This method can be used on models with HA/HB ports included on the indoor board. Use field supplied wire according to the specifications listed in the Wire Specifications chart. Connect the HA/HB ports on the thermostat to the HA/HB ports on the indoor unit depending on your chosen application. The HA/HB ports do not have polarity.

One Thermostat Controlling One Indoor Unit

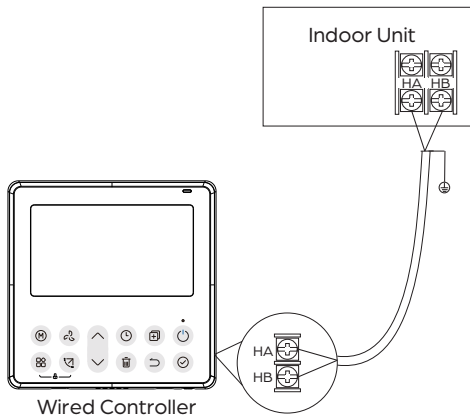

Two Thermostats Controlling One Indoor Unit

**NOTE**

Thermostats with wireless capability do not have this function.

**NOTE**

Only one DRSTAT101 is included. A second will need to be purchased. The address (Adr) of the thermostats will need to be changed. Refer to the Changing the Thermostat Address section.

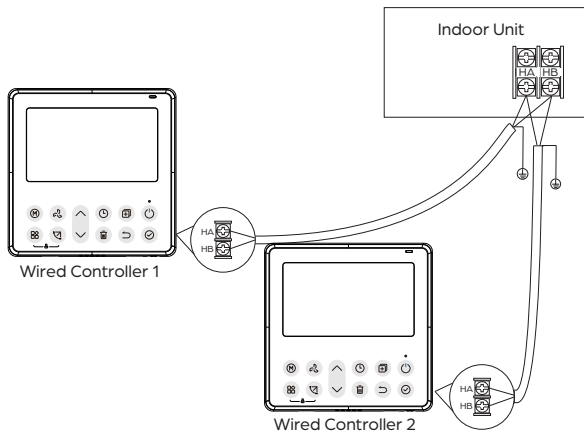

One Thermostat Controlling Multiple Indoor Units

For some units, one (1) wired controller can support multiple units (a maximum of 16 units). In this case, the thermostat and unit need to be connected to the HA and HB ports at the same time. In group control, there will be no error displayed on the wired controller .

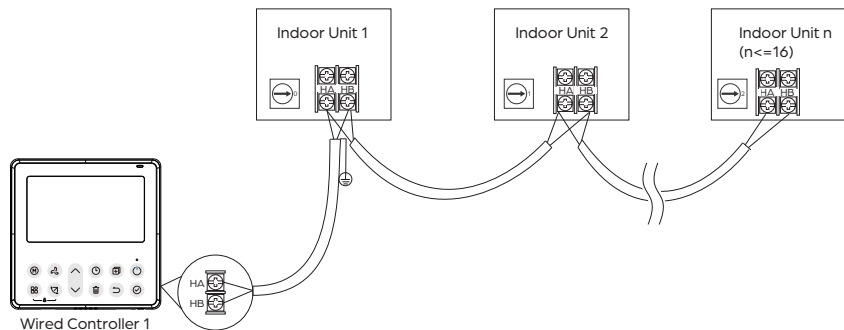

NOTE

The suggested length between the DRSTAT101 and indoor unit 1 is 19ft (6m). The maximum is 65ft (20m). The maximum between each successive unit is 65ft (20m). For the best communication, use 16 AWG stranded shielded wire, grounding the shield as seen above.

LCD DISPLAY

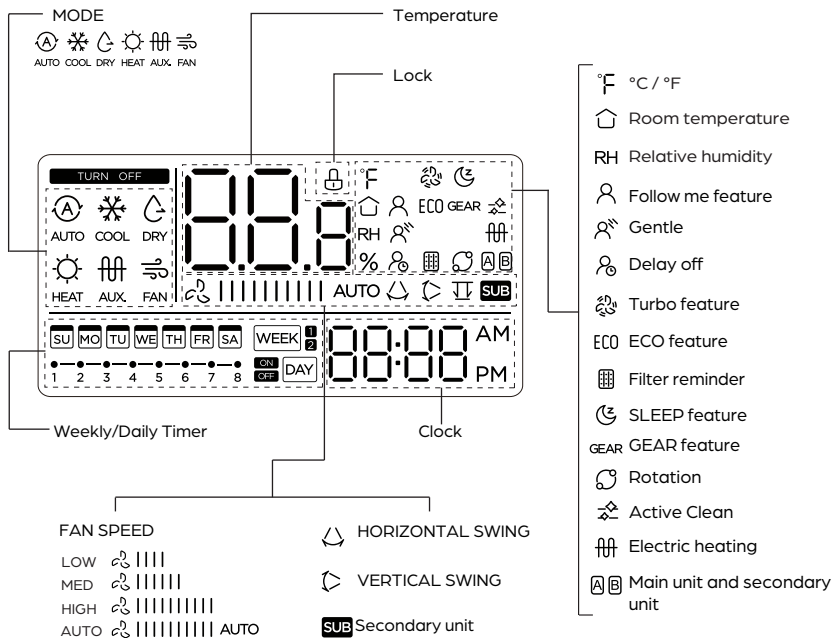

NOTE

 Please note that not all features are available on every indoor unit. Refer to your unit's owner's manual for unit specific features. The thermostat will default to show the applicable features of the indoor unit

BUTTON DESCRIPTIONS

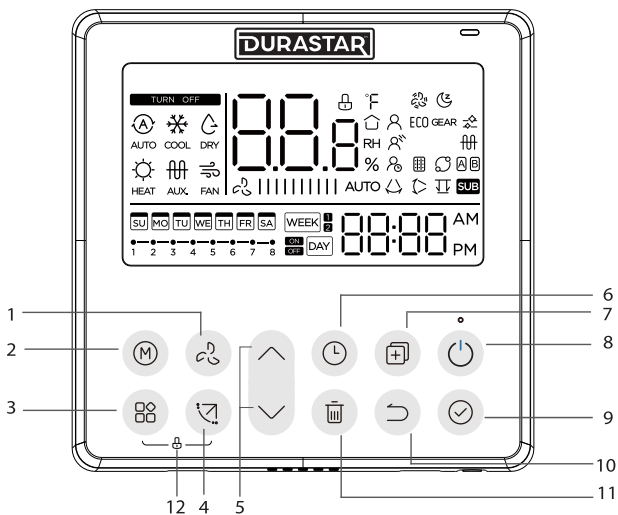

1. FAN SPEED Button

Press to cycle through the following options.

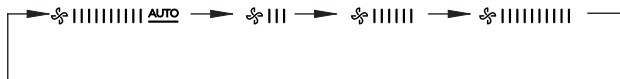

*The Fan Speed button is not available in AUTO or DRY mode.

2. MODE Button

Press to select the operating mode.

See "Operating Modes" for more information.

3. FUNC Button

Press to select different functions.

See "Functions" for more information.

4. SWING Button

Press to adjust louvers on indoor units See "Setting the Swing Function" for more information.

5. UP/DOWN Buttons

The up and down buttons are used for a variety of thermostat functions.

For Setting the temperature:

The temperature range will differ in cool, heat, and dry modes, depending on the unit setting. You can increase or decrease the set temperature in 1°F (1°C) increments, using the up and down buttons.

Press and hold the up and down buttons together for 3 seconds to switch between °C and °F.

6. TIMER Button

See "Timer Functions" for more information.

7. COPY Button

See "Copying the Setting From One (1) Day Into Another in the Weekly Timer" for more information.

8. ON/OFF Button

Press to turn the unit ON and OFF.

9. SELECT Button

Press to select a function or setting.

10. BACK Button

Press to return to the previous step, for some functions.

11. DELETE Button

Press to Delete settings, for some functions.

12. CHILD LOCK Button

The child lock button locks all buttons on thermostat. If locked, you cannot operate the remote control.



INITIAL SETUP

Setting the Current Date and Time

- 

Press the **TIMER** button for two (2) seconds or more. The timer display will flash.
- 

Press the up and down arrow buttons to scroll through the dates. The selected date will flash.

- 

Press the **SELECT** button to confirm the date selected and to move on to setting the time.

*If no button is pressed for 10 seconds, the date will remain set to the last date selected and the display will move on to setting the time.
- 



Press the up and down arrow buttons to set the current time. Press repeatedly to adjust the time in one (1) minute increments or hold the button down until the desired time is reached.



ex. Monday 11:20

5.  Press the SELECT button to confirm the time selected.
*If no button is pressed for 10 seconds, the time will remain set at the time showing.

NOTE

 To change the time scale between 12h and 24h, press the TIMER  and DELETE  buttons together for two (2) seconds.

Turning On/Off the Keypad Tone

The thermostat has a keypad tone that sounds when buttons are pushed. To turn on or off the keypad tone, press and hold the MODE and FAN SPEED buttons  simultaneously for three (3) seconds.

Turning On/Off the Child Lock

To activate/deactivate the Child Lock function, press the FUNCTION and SWING buttons  simultaneously for three (3) seconds.

When the lock is activated, the  mark appears.

OPERATING MODES



Press the ON/OFF button to turn the unit on.



To set the operating mode, press the MODE button.

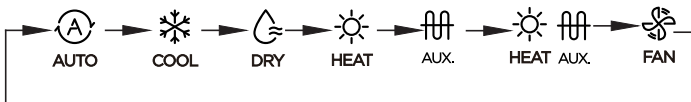

Auto Mode

In AUTO mode, the unit will automatically select the COOL, FAN, HEAT, or DRY modes to maintain the set temperature.

- Press the MODE button and select AUTO.
- Set your desired temperature using the up and down arrow buttons.

Cool Mode

- Press the MODE button and select COOL.
- Set your desired temperature using the up and down arrow buttons.
- Press the FAN SPEED button to select the fan speed: AUTO, LOW, MED or HIGH.

Dry Mode (Dehumidify)

- Press the MODE button and select DRY.
- Set your desired temperature using the up and down arrow buttons.

Heat Mode

- Press the MODE button and select HEAT.
- Set your desired temperature using the up and down arrow buttons.
- Press the FAN SPEED button to select the fan speed: AUTO, LOW, MED or HIGH.

NOTE

Two or more indoor units can be operated by one outdoor unit.



When several indoor units are operated simultaneously, cooling/dry/fan and heating operations cannot be done at the same time. When COOL/DRY/FAN is selected with one unit and HEAT with another or vice versa, the unit selected last goes into standby mode.

Fan Mode

- Press the MODE button and select FAN.
- Press the FAN SPEED button to select the fan speed: AUTO, LOW, MED or HIGH.
- Press the ON/OFF button to start the unit.

NOTE

As outdoor temperature drops, the performance of your unit's HEAT function may be affected and using the auxiliary electric heat module (AUX) may be necessary. Not all units have an Aux (electric heat) function.

Aux Mode: For Electric Heat Only

- Press the MODE button and select AUX.
- In AUX mode, the fan speed is Auto but you can adjust the fan speed. The Sleep, 46-Degree Heating, Turbo, and Rotation functions are not available.

Heat Aux: Heat pump + Electric Heat Assists As Needed

When both Heat and AUX   are chosen, and you can adjust the fan speed. The Turbo and Rotation functions are not available.

46-Degree Heating

When the temperature is set at the minimum temperature in heating mode, press the down button twice within one second to turn on this function. The unit will operate in heating when the indoor temperature reaches 46°F (8°C). When this function is enabled, Follow Me, SLEEP, Turbo and Daily Timer features are cancelled.

FUNCTIONS

Function availability varies with different indoor units. Functions are not visible when they are inactive or are unavailable for a given unit.

Activating Functions



Press the FUNC button to scroll through operation functions. The function icons will flash. Only functions available for your given unit will be visible as you scroll.



You must press the SELECT button to activate functions. If the function is active, its icon will stop flashing.

Deactivating/Exiting Functions



Press the FUNC button. The function icon will flash again.



Press the Select button to deactivate/exit the function. The icon will disappear.

Turbo

The Turbo function enables the unit to reach the set temperature in the shortest time by increasing the fan speed to a level slightly above high.

In COOL or HEAT mode, press the FUNC button and select the Turbo icon to activate/deactivate the Turbo function. When the Turbo function is activated, the Turbo icon "  " is visible.

*NOTE: Changing the fan speed will deactivate the Turbo function.

Sleep

The Sleep function is designed to decrease energy use while you sleep. The Sleep function is not available in FAN or DRY mode.

Press the FUNC button and select the Sleep icon to activate/deactivate the Sleep function. When the Sleep function is activated, the Sleep icon "  " is visible.

- In COOL mode, the unit will increase the temperature by 2°F (1°C) after one (1) hour, and will increase an additional 2°F (1°C) after another hour.
- In HEAT mode, the unit will decrease the temperature by 2°F (1°C) after one (1) hour, and will decrease an additional 2°F (1°C) after another hour.

The SLEEP feature will turn off after eight hours and the system will return to normal functioning.

Active Clean



This function washes away dust, mold, and grease that may cause odors by freezing then rapidly thawing condensation on the indoor unit coil. The display window on the unit will show CL when the function is on. After 20–45 minutes, the unit will turn off automatically. You can only activate the this function in COOL or DRY modes. This feature is not available in multi-zone configurations.

Follow Me



This function uses the temperature at the thermostat's location, instead of the indoor unit's location, to optimize the temperature around you and ensure maximum comfort.

Press the FUNC button and select the Follow Me icon to activate/deactivate the Follow Me function. When the Follow Me icon "  " is visible, the room temperature is detected by the thermostat.

NOTE



In AUX mode, only the Follow Me function is available. In addition, you cannot control fan speed.

ECO

ECO The ECO function a lower level of energy consumption to change the cooling capacity of your unit and save energy.

While the unit is in COOL mode, press the FUNC button and select the ECO icon. When the ECO function is activated, the ECO icon "ECO" is visible.

If the set temperature is above 75°F (24°C) the FAN speed will be set to AUTO. If the set temperature is below 75°F (24°C) it will automatically be adjusted to 75°F (24°C) and the FAN speed will be set to AUTO. When functioning in this mode, the unit can reduce its energy consumption up to 10%.

Gear

GEAR The GEAR function provides two lower levels of energy consumption to change the cooling capacity of your unit and save energy.

In the cooling mode, press the FUNC button and select the Gear icon. The current GEAR status will display and the GEAR icon "GEAR" is visible.

- To adjust the GEAR status, press the up and down arrow buttons.
The setting range is 50%-->75%-->OFF. GEAR adjustment will stop after five (5) seconds of inactivity. The set temperature will then display.
- To adjust the temperature, press the up and down arrow buttons

Exit the GEAR function by selecting the GEAR icon. The GEAR icon will be extinguished. The GEAR function does not operate if Sleep, ECO, Turbo, or Clean functions are selected.

Humidity

RH

Some indoor units have a dual control function for humidity and temperature.

In the Dry(dehumidification) operating mode, press the FUNC button and select the Humidity icon to activate/deactivate this dual control humidity and temperature function.

When the Humidity function is activated, the Humidity icon "RH" is visible and flashes.

- To adjust the humidity, press the up and down arrow buttons. The setting range is from 35% – 85% in 5% increments. Humidity adjustment will stop after five (5) seconds of inactivity. The set temperature will then display.
- To adjust the temperature, press the up and down arrow buttons. Temperature adjustment will stop after five (5) seconds of inactivity, and the display will revert to the set humidity display.

After changing the humidity and temperature settings, exit the Humidity function by pressing the select button. 

Gentle



If the air flow from the unit becomes uncomfortable because it is too intense or blowing directly on you, simply press the FUNC button and select the Gentle icon "" to slow the unit and divert the air flow away from you.

Press the GENTLE icon again to turn this feature off. This feature is only available in COOL, DRY, and FAN modes. This feature is only available on some units. This feature is not available in multiple zone configurations.

Delay Off



The Delay Off function allows users to extend the running time of the unit and only works in the weekly timer mode. See Timer Functions > Delaying Unit Turn Off When the Weekly Timer is Activated.

Filter Cleaning



The Filter Cleaning icon "  " will become visible when it is time to clean the filter.

Press the FUNC button and select the Filter Cleaning icon to turn off and reset the filter cleaning/changing function. The icon will be extinguished. This feature is only available on some units.

Rotation and Backup



NOTE



This function is only available when one DRSTAT100 is controlling two units using the 2-wire non-polar connection method.

Rotation and Backup



When there are two (2) units, press the FUNC button and select the rotating icon to activate/deactivate the Rotation and Backup function. The Rotation and Backup function allows for setting a timed rotation between two (2) units and for setting a backup unit if one (1) fails.

The time setting will appear first. The time setting determines how many hours the first unit will run, before switching to the other unit.

- To adjust the rotating time, press the up and down arrow buttons. The setting range is 1 ~ 99h. (Default time is 10 hours). Press the SELECT button to confirm the time and move on to setting the high temperature.

If no button is pressed for five (5) seconds, the time will remain set to the last time selected and the display will move on to setting the high temperature.

- To set the high temperature, press the up and down arrow buttons. The high temperature range is 78~90°F (26~32°C).

- When the ambient temperature is greater than or equal to the set high temperature, both units will run at 75°F (24°C) in COOL mode. Press the SELECT button to confirm the high temperature and move on to setting the low temperature.

If no button is pressed for five (5) seconds, the high temperature will remain set to the last temperature selected and the display will move on to setting the low temperature.

- To set the low temperature, press the up and down arrow buttons. The low temperature range is 41~59°F (5~15°C). When the ambient temperature is greater than or equal to the set low temperature, both units will run at 75°F (24°C) in HEATING mode. Press the SELECT button to confirm the low temperature and move on to setting which machine will run first.

If no button is pressed for five (5) seconds, the low temperature will remain set to the last temperature selected and the display will move on to setting which machine will run first.

- To choose which runs first, select A or B.

NOTE

While the Rotation and Backup function is selected, the system will automatically turn on another unit and turn off the current unit based on the time setting. The thermostat will automatically switch to another unit when the time is up or when one of the units fail. Press the POWER button to switch to another machine immediately. Either the A or B icon is displayed on the screen.

Setting the Swing Function

For units with horizontal & vertical swing features only

Vertical Swing



To start and stop the vertical swing function, press the SWING button. When the vertical swing function is activated, the "◁" mark appears.

Horizontal Swing



x 2 sec

To start and stop the horizontal swing function, press the SWING button for two (2) seconds.

When the horizontal swing function is activated, the "△" mark appears.

For units with airflow direction control and auto-swing

Vertical Airflow Direction



To adjust the vertical airflow direction, press the SWING button.

Each press of the SWING button will adjust the louver angle by six (6) degrees.

Auto-Swing Function



x 2 sec

To start or stop the auto-swing function, press and hold the SWING button for two (2) seconds.

For units with four louvers

Vertical Airflow Direction



To activate the vertical airflow function for individual louvers, press the SWING button.

The "◁" mark will flash. (Only available on some units).

To select an individual louver, press the up and down arrow buttons. Each press will cycle through five (5) options. The option selects all four (4) louvers to move at the same time.

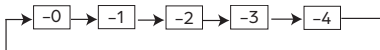





After the correct louver(s) is chosen, press the SWING button to adjust the vertical airflow direction. Each press of the SWING button will adjust the louver angle by six (6) degrees.

TIMER FUNCTIONS

There are multiple timer functions available, depending on your desired schedule.

ON DAY	On Day Timer The On Day Timer function only sets the time the unit starts within a 24-hour period.
OFF DAY	Off Day Timer The Off Day timer only sets the time the unit stops within a 24-hour period

	<p>On/Off Day Timer</p> <p>The On and Off Day Timer function only sets the period of time when the unit starts and stops within a 24-hour period.</p>
	<p>Weekly Timer</p> <p>The Weekly Timer function sets operating times for each day of the week. Two (2) Weekly Timers can be saved and set at different times. They cannot be used at the same time or used with the On Day Timer, Off Day Timer, or the On/Off Day Timer.</p> <p> Week 1 Timer</p> <p>The Week 1 Timer function only turns the unit on/off. You can choose up to four (4) different settings for each day and you can set different times for every day.</p> <p> Week 2 Timer</p> <p>The Week 2 Timer function can have different settings for mode, temperature, fan speed, and switching on/off. You can choose up to eight (8) different settings for each day and you can set different times for every day.</p>

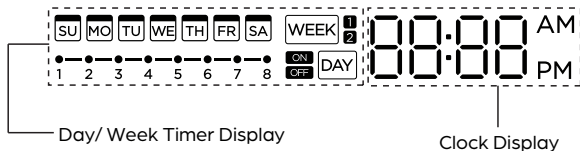

NOTE



Only the primary controller can set the timers. This is determined by the address of the thermostat. See *Changing the Thermostat Address* section.

Setting the On or the Off Day Timer

NOTE



On any step, if no buttons are pressed for 10 seconds, the current setting will be restored and the function will be exited.

- 

Press the TIMER button to scroll to the On Day  or Off Day  timer icon.



- 



Press the Select button to choose the function. The Timer display will flash.

3.  Press the up and down arrow buttons to set the timer duration in half-hour increments.



4.  Press the SELECT button to confirm the time selected. The Timer display quits flashing.

Setting the On/Off Day Timer

1.  Press the TIMER button to scroll to the On Day or Off Day  timer icon.



2.  Press the Select button to choose the function. The "On" icon will flash.

3.  Press the up and down arrow buttons to set the duration of the On Timer first in half-hour increments.

4.  Press the Select button to confirm the On time. Then the "Off" icon will flash.

5.  Press the up and down arrow buttons to set the duration of the Off Timer in half-hour increments.



6.  Press the Select button to finish setting the On/Off timer. The timer display quits flashing.

Setting the Weekly Timer (Week 1)

NOTE



On any step, if no buttons are pressed for 30 seconds, the current setting will be restored and the function will be exited.

1.  Press the TIMER button, scroll to the Week 1  timer icon, and select it. 

2.  Press the up and down arrow buttons to choose the **day of the week**, and select it.



3.



Press the up and down arrow buttons to set the **On time**, and select it.

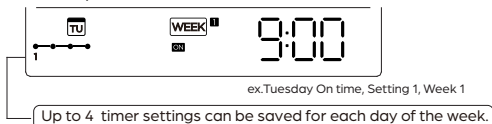



4.



Press the up and down arrow buttons to set the **Off time**, and select it.

- Different timer settings can be made for each day, by repeating steps three (3) to four (4).
- Other days in the week can be set, by repeating steps two (2) to four (4).

NOTE

- The Weekly Timer can be returned to the previous step by pressing the Back  button.
- The time of the Weekly Timer can be deleted by pressing the Delete  button.

Setting the Weekly Timer (Week 2)

NOTE



On any step, if no buttons are pressed for 30 seconds, the current setting will be restored and the function will be exited.

- 

Press the TIMER button, scroll to the Week 2 timer icon  and select it. 

A day of the week flashes.

- 

Press the up and down arrow buttons to choose the **day of the week**, and select it.

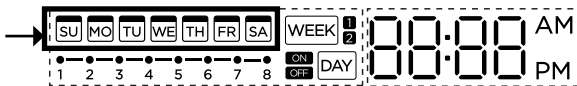

- 

Press the up and down arrow buttons to set the **On time**, and select it.

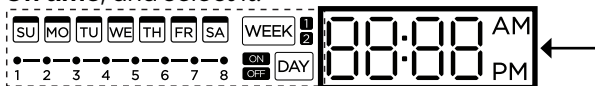

4.  Press the up and down arrow buttons to set the **Off time**, and select it.

5.  Press the up and down arrow buttons to set the **operation mode**, and select it.



6.  Press the up and down arrow buttons to set the **room temperature**, and select it.

NOTE



This setting is unavailable in the FAN or OFF modes.

7.  Press the up and down arrow buttons to set the **fan speed**, and select it.

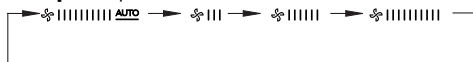



NOTE



This setting is unavailable in the AUTO, DRY, or OFF modes.

- Different scheduled events can be set for the day selected by repeating steps three (3) through seven (7).
- Additional days in a one (1) week period can be set by repeating steps two (2) through seven (7).

Activating/Deactivating the Weekly Timer 1 or 2

1.  **To activate**, press the TIMER button and choose Week 1 or 2. The timer starts automatically.
2.  **To deactivate**, change the TIMER mode
or
Press the power button for two (2) seconds.

Copying the Setting From One Day Into Another in the Weekly Timer

- 
 With the Weekly Timer icon illuminated, press the Select button.

- 
 Press the up and down arrow buttons to choose the day to copy from.

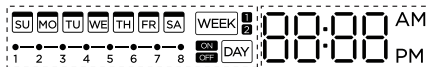

- 
 Press the Copy button. "CY" will be visible on the LCD screen.

- 
 Press the up and down arrow buttons to choose the day to copy to.

- 
 Press the Copy button to copy the settings to the selected day.

The **WE** mark flashes quickly

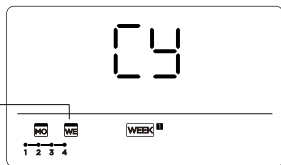

ex. Copy the setting of Monday to Wednesday

6.  Press the Select button to confirm the settings.

7.  Press the Back button to return to the Weekly timer.

- Other days can be copied to, by repeating step four (4) to step six (6).

Turning the Unit Off When the Weekly Timer is Activated



To turn the unit off temporarily when the Weekly timer is activated, press and release the Power button. The unit will resume operation at the next set On time.

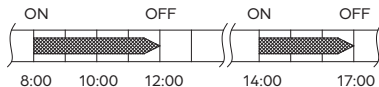

ex. If the Power button is pressed once and quickly at 10:00, the air conditioner will turn on at 14:00.



x 2 sec

To turn the unit off completely and cancel the Weekly timer, press and hold the Power button for two (2) seconds.

Canceling a Day When the Weekly Timer is Activated



NOTE

Only cancels the day for one (1) instance/week. To change the days of the Weekly Timer, see *Setting the Weekly Timer*.

- 

With the Weekly Timer icon illuminated, press the Select button.
- 

Press the up and down arrow buttons to select the day of the week you wish to cancel.

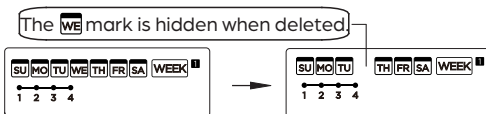

3.  Press the Delete button to cancel the chosen day from the Weekly timer.



4.  To return to the Weekly timer, press the Back button or do nothing for 30 seconds.

- Other days in the week can be canceled, by repeating steps two (2) and three (3).

Delaying Unit Turn Off When the Weekly Timer is Activated

1.  Press the Function button and scroll to the Delay Off "  " button and select it. 

-  Press the Select button to scroll through the options. Only one (1) option at a time is displayed.

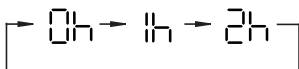

The chosen hour option will flash for a few seconds, then disappear, and the Delay Off icon will remain.

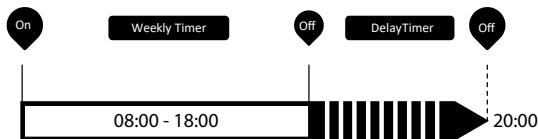

For example: If you chose "2h" at 18:05, the unit will turn off at 20:05.

QUERIES AND SETTINGS

CAUTION



These settings should only be adjusted by a trained HVAC professional during installation or troubleshooting. Adjusting these settings could result in unit malfunctions or damage.

NOTE



The unit may need to be turned off depending on the setting being adjusted. Please follow the instructions for each setting below.

Opening the query function:



x 3 sec

Press and hold the Copy button for three (3) seconds.



If the thermostat is connected to an indoor unit, the thermostat will display "P.00." If multiple indoor units are connected to the thermostat, press the up and down arrow buttons to navigate to the correct indoor unit (P.00, P.01, etc.).



Press the Select button to choose the correct unit.

Exiting the query function:



Press the back button

or



Press the On/Off button

or



Do nothing (Press no keys) for fifteen seconds).

Querying Thermistor (Tn) and Fan Faults (CF)



Press the up and down arrow buttons to cycle through thermistor readings and faults that are applicable to the indoor unit."

Adjusting The Static Pressure:



1. Make sure the air conditioner is turned off.
2.  Once in query, press the up and down arrow buttons to find SP and select it. 



SP
 50
 ❖ |||||
3.  Press the up and down arrow buttons to adjust the SP, then select it.



Using the Automatic Airflow Adjustment Function:

This function automatically adjusts the fan speed for proper airflow based on the static pressure of your ductwork system.

1. Make sure the air conditioner is turned off.
2.  Press the up and down arrow buttons to find AF, then select it. 
AF
*|||||||
3. The AF test runs for three (3) to six (6) minutes and exits the AF function automatically when finished.



Setting Follow Me Temperature Compensation

This function allows you to adjust the temperature compensation based on where the thermostat is mounted in the room.

1. Make sure the air conditioner is turned off.
2.  Press the up and down arrow buttons to find tF, then select it. 
tF





3.  Press the up and down arrow buttons to choose the temperature, then select it. The compensation temperature range is -5°F ~ 5°F (-5°C ~ 5°C).

Setting the Possible Operating Modes:



1. Make sure the air conditioner is turned off.
2.  Press the up and down arrow buttons to find type, then select it.  **TYPE**
3.  Press the up and down arrow buttons to choose the type and select it. There are four operating mode types, shown below.







To Turn On/Off Remote Control Operation:



1. Make sure the air conditioner is turned off.
2.  Press the up and down arrow buttons to find reC, then select it. 

ON or OFF will be displayed.
When OFF, the thermostat does not process remote control signals.
3.  Press the up and down arrow buttons to choose ON or OFF, and select it.

Setting the High and Low Temperature Values:

1. Make sure the air conditioner is turned off.
2.  Press the up and down arrow buttons to find tHI, then select it. 
 : Highest value setting function.

3.  Press the up and down arrow buttons to choose the temperature and select it.
The high temperature range is 77°F~86°F (25°C~30°C).
4.  Press the up and down arrow buttons to find tLO and select it.   : Minimum value setting function.
5.  Press the up and down arrow buttons to choose the temperature and select it.
The low temperature range is 63°F~75°F (17°C ~ 24°C).





Changing The Thermostat Address

1. Make sure the air conditioner is turned off.
2.  Press the up and down arrow buttons to find Adr, then select it.  

The temperature zone will display "--," "A," or "B."
"--" refers to the code setting of the thermostat. The code setting of the thermostat shall prevail.

3.  Press the up and down arrow buttons to choose "--," "A," or "B." and select it.

Restoring Factory Settings:

1. Make sure the air conditioner is turned off.
2.  Press the up and down arrow buttons to find INit, then select it.  
3.  Press the up and down arrow buttons to choose "ON" and select it. 

When the factory settings are restored:

- The rotating function timing is restored to 10 hours (the highest and lowest temperatures are not set).
- Body temperature compensation is turned off.
- COOL and HEAT/single mode is restored to COOL and HEAT mode.
- The high and low temperature range is restored to the factory setting.
- The remote control receiving function is turned On.
- The address setting is reset and the address of the code switch will prevail.

LED DISPLAY INDICATORS

The following is a list of possible indicators that may appear on the indoor unit's display panel. Not all the display indicators may be available on the unit purchased.

Feature	Indicator	Notes
TIMER ON, SWING, TURBO, SILENCE	ON	Displays for 3 seconds when the TIMER ON feature is set or the SWING, TURBO, or SILENCE feature is turned on. If the unit is off, ON will continue to be shown if the TIMER ON feature is set.
TIMER OFF, SWING, TURBO, SILENCE	OF	Displays for 3 seconds when the TIMER OFF feature is set or the SWING, TURBO, or SILENCE feature is turned off.
SELF CLEAN	SC	Displays when the SELF CLEANING feature is on.
FREEZE PROTECTION	FP	Displays when the FP feature is on.
FORCED COOLING	FC	Displays when the FORCED COOLING mode is selected with the manual control button. See Manual Operation section.

Feature	Indicator	Notes
ANTI-COLD AIR FLOW	cF	The unit is designed not to blow cold air in HEAT mode. When HEAT mode is selected the unit will display "cF" until the set temperature is reached and the unit can blow warm air.
DEFROST	dF	Displays when unit is defrosting. This may last 5-10 minutes depending on the outdoor temperature and the amount of frost buildup on the outside unit.

TROUBLESHOOTING

Issue	Possible Causes	
The fan speed cannot be changed	Check whether Auto mode is selected.	In AUTO mode, the fan speed is set automatically and cannot be changed.
	Check whether DRY mode is selected.	In DRY mode, the FAN SPEED button is ineffective. The fan speed can only be changed in COOL, FAN and HEAT mode.
The temperature display is off.	Check whether FAN mode is selected.	In FAN mode, the temperature cannot be adjusted.

Issue	Possible Causes	
The TIMER OFF disappears after a period of time.	If the TIMER OFF function was activated, the operation may have finished.	The air conditioner will automatically stop at the set time and the indicator light will turn off.
Unit does not turn on when pressing ON/OFF button	The unit has a 3-minute protection feature that prevents the unit from overloading. The unit cannot be restarted within three minutes of being turned off.	
The TIMER ON indicator disappears after a period of time.	If the TIMER ON function was activated, the operation may have finished.	The air conditioner will automatically start at the set time and the indicator light will turn off.
The unit changes from COOL/HEAT mode to FAN mode	The unit may change its setting to prevent frost from forming on the unit. Once the temperature increases, the unit will start operating in the previously selected mode again.	
	The set temperature has been reached, at which point the unit turns off the compressor. The unit will continue operating when the temperature fluctuates again.	

LIMITED WARRANTY – PARTS

This Limited Warranty applies to Covered Equipment manufactured on or after November 1st, 2024.

COVERED EQUIPMENT is defined by the following model number categories:

DRA1_S2A, DRA3_M2A, DRA4_M2A, DRA5_M2A, DRA6_M2A, DRU1_S2A, DRAC_F2A, DRAD_F2A, DRAF_F2A, DRAL_F2A, DRAM_F2A, DRAS_F2A, DRAW_F2A, DRUM_S2A.

Durastar accessories installed with Covered Equipment carry the balance of the Covered Equipment warranty.

BASE RESIDENTIAL WARRANTY: SEVEN (7) YEARS PARTS

Subject to the terms of this Limited Warranty, Manufacturer will repair or replace, at its option, any part of the Covered Equipment that is found to be defective in material or workmanship.

Covered Equipment Parts are warranted to be free from defects in material and workmanship for a period of seven (7) years from the date of installation, under normal use and service. Durastar will, at its option, repair or replace any part determined by Durastar to be defective. Replacement parts carry the balance of the original parts warranty. If an exact replacement part is not available, an equivalent part or credit will be provided.

To qualify:

- The Covered Equipment must be installed in a residential single-family home.*
- The Covered Equipment must be properly installed by a licensed HVAC professional pursuant to all local and state laws.
- Any part to be replaced must be made available to Durastar in exchange for the replacement.

*Single-family home is defined as any single-family dwelling, which includes apartments, condominiums, duplexes, and homes.

BASE COMMERCIAL WARRANTY: TWO (2) YEAR PARTS

Subject to the terms of this Limited Warranty, Covered Equipment installed in commercial applications are warranted against defects in material and workmanship for a period of TWO (2) YEARS.

REGISTERED WARRANTY

Parts for Covered Equipment that is registered by the purchaser online within ninety (90) days of the original installation date shall be warranted for an extended period subject to the terms in this Limited Warranty. Any Covered Equipment not properly registered within the ninety (90) day registration window will be subject to the base warranty terms outlined herein. To register your Covered Equipment online, go to: www.durastar.com/warranty-registration

Registered Residential Warranty: TEN (10) years

Registered Commercial Warranty: FIVE (5) years

FLORIDA, TEXAS, AND CALIFORNIA RESIDENTS ONLY: Failure to register Covered Equipment does not diminish or decrease your limited warranty length. Covered Equipment will receive the full REGISTERED WARRANTY terms.

EFFECTIVE DATE OF WARRANTY

The Effective Date of warranty coverage is determined as follows: (a) If the original installation date can be verified by the installer's invoice then the Effective Date of warranty coverage is the original installation date as shown on the installer's invoice. For residential new construction installations, the final occupancy permit, or proof of purchase from the builder can be substituted for the installer's invoice. (b) if the original installation date cannot be verified by the installer's invoice, or

proof of purchase from the builder in residential new construction applications, then the Effective Date of warranty coverage is the Covered Equipment's manufacture date (as verified by the product's serial number) plus ninety (90) days.

LIMITATIONS

There is NO LABOR component provided with this warranty. This Limited Warranty does NOT cover any labor costs or expenses for service, NOR for removing or reinstalling parts.

This Limited Warranty does NOT cover shipping costs for warranty replacement parts from our factory to the Manufacturer's distributor or from the distributor to the location of your Covered Equipment. You also are responsible for the cost of shipping allegedly defective parts to the distributor and for incidental costs incurred locally, including handling charges. (If in Alaska, Hawaii or Canada, you also must pay the shipping costs of returning the failed part to the port of entry into the continental United States.)

Manufacturer's Liability hereunder is limited to the repair or replacement of Covered Equipment Parts, and in no event shall exceed the value of the original Covered Equipment Purchase Price. Liability for incidental, consequential or special damages are specifically excluded.

EXCLUSIONS

In addition to the other exclusions identified in this Limited Warranty, this Limited Warranty excludes:

- Damages, malfunctions, or failures resulting from failure to properly install, operate, or maintain Covered Equipment in accordance with the Manufacturer's instructions.
- Damages, malfunctions, or failures resulting from misuse, accident,

contaminated, or corrosive atmosphere, vandalism, freight damage, fire, flood, freeze, lightning, power surges, acts of war, acts of God and the like.

- Non-original parts installed with Covered Equipment or used in connection with normal maintenance, such as cleaning or replacing air filters, refrigerant, thermostats, tubing, or concrete pads.
- Covered Equipment that is not installed in the United States.
- Covered Equipment that is not installed by a qualified, trained or licensed HVAC professional in accordance with applicable codes, ordinances, and good trade practices.
- Damages, malfunctions, or failures resulting from the use of any attachment, accessory, or component not authorized by the Manufacturer or resulting from alteration or modification of the unit.
- Covered Equipment moved from the original installation location.
- Covered Equipment when operated with system components (indoor unit, outdoor unit, coil, and refrigerant control devices) or accessories which do not match or meet the specifications recommended by the Manufacturer.
- Any Covered Equipment manufactured that has been sold to the consumer via the Internet or auction website, and has not been installed by a trained, qualified HVAC professional.
- Covered Equipment that is not part of a properly matched system as specified by the Air Conditioning, Heating & Refrigeration Institute (AHRI).

OBTAINING WARRANTY SERVICE

If you believe your Covered Equipment is defective, contact the licensed contractor who installed your mini-split system. Alternatively, contact a licensed contractor, dealer, or distributor.

Durastar Customer Support is available for troubleshooting assistance. Before contacting Customer Support, please locate your model number, serial number, and proof of purchase. These items will be required to complete any warranty service. A Durastar authorized representative will verify warranty eligibility and determine appropriate service options. Service will be provided during normal business hours.

The warranty claim must be submitted at www.durastar.com/warranty-claim by the servicing contractor within 90 DAYS after the date of service in order for the warranty to be approved. The service invoice and/or return of parts may be requested to verify eligibility.

THIS WARRANTY IS IN LIEU OF ANY OTHER WARRANTY, EXPRESS OR IMPLIED, INCLUDING WITHOUT LIMITATION, ANY WARRANTY OF MERCHANTABILITY OR FITNESS FOR A PARTICULAR PURPOSE. TO THE EXTENT ANY IMPLIED WARRANTY IS REQUIRED BY LAW, IT IS LIMITED IN DURATION TO THE EXPRESS WARRANTY PERIOD ABOVE. NEITHER THE MANUFACTURER NOR ITS DISTRIBUTORS SHALL BE LIABLE FOR ANY INCIDENTAL, CONSEQUENTIAL, INDIRECT, SPECIAL, OR PUNITIVE DAMAGES OF ANY NATURE, INCLUDING WITHOUT LIMITATION, LOST REVENUES OR PROFITS, OR ANY OTHER DAMAGE WHETHER BASED IN CONTRACT, TORT, OR OTHERWISE. IN NO EVENT AND UNDER NO CIRCUMSTANCE OF ANY TYPE OR KIND SHALL THE SELLER, MANUFACTURER AND/OR DISTRIBUTOR BE LIABLE FOR ANY REASON, UNDER ANY THEORY, FOR MORE THAN THE BASIC COST OF THE PRODUCT TO THE PURCHASER OR END USER. SOME STATES DO NOT ALLOW THE EXCLUSION OF INCIDENTAL OR CONSEQUENTIAL DAMAGES, SO THE ABOVE EXCLUSION MAY NOT APPLY TO YOU. THIS WARRANTY GIVES YOU SPECIFIC LEGAL RIGHTS. YOU MAY HAVE OTHER RIGHTS THAT VARY FROM STATE TO STATE.

THIS PAGE INTENTIONALLY LEFT BLANK.

THIS PAGE INTENTIONALLY LEFT BLANK.