



Freezeless Sanitary Water Connector Thermaline®

The Thermaline® is a compact unit especially designed to provide water service to mobile homes. It is ideal wherever a freezeless sanitary tight line installation is needed, such as, waterers for livestock.

The Thermaline® is protected from freezing by a bonded polyurethane foam insulation permanently molded in a high strength plastic casing, and a 15 watt (110-120v) portable insert heater, which costs about a penny a day to operate even at 50° below zero.

The heater can be inserted and removed from the Thermaline® without interrupting the water service.

Galvanized steel riser pipe with coal-tar coating on lower end, brass fittings, structural foam protective surface cover, and extra large cushion valve all combine to make the Thermaline® water connector virtually maintenance free.

When not in use, wheel handle at surface level shuts off water below the frost line. Water above the frost line can be removed completely with forced air or suction pump.

SPECIFICATIONS:

U.S. Patent Number – 3,913,602

HEAD - Brass casting with 3/4" N.P.T. outlet

COVER - Pressure molded polypropylene rigid structural foam

HEATER - 15 watt (110-120V) portable insert heater with grounded metal alloy sheath and 3-prong standard plug

RISER PIPE - 1" galvanized steel pipe
Optional - 1" brass pipe

Operating Pipe - 1/4" galvanized steel pipe
Optional - 1/4" brass pipe

INSULATION - Molded polyurethane foam

CASING - 3 1/4" O.D. plastic tubing

VALVE – Permanent type brass valve body with hemispherical seating surface. 3/4" N.P.T. inlet

Bury Depth (ft)	1	2	3	4	5	6	7*	8*
Weight (lbs)	6.5	9	11.5	14	16.5	19	21.5	24

*Must ship by truck line due to length.

Specify as follows:

"Water Connectors shall be Woodford Thermaline_____ft. Bury, with 15 watt portable insert heater, bonded polyurethane insulation, sanitary tight-line design."

For Installation / Troubleshooting Instructions go to www.woodfordmfg.com or call 1-800-621-6032



Rough-In Dimensions

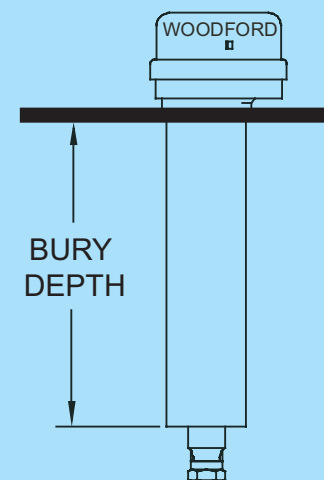

When ordering, specify model and bury depth.

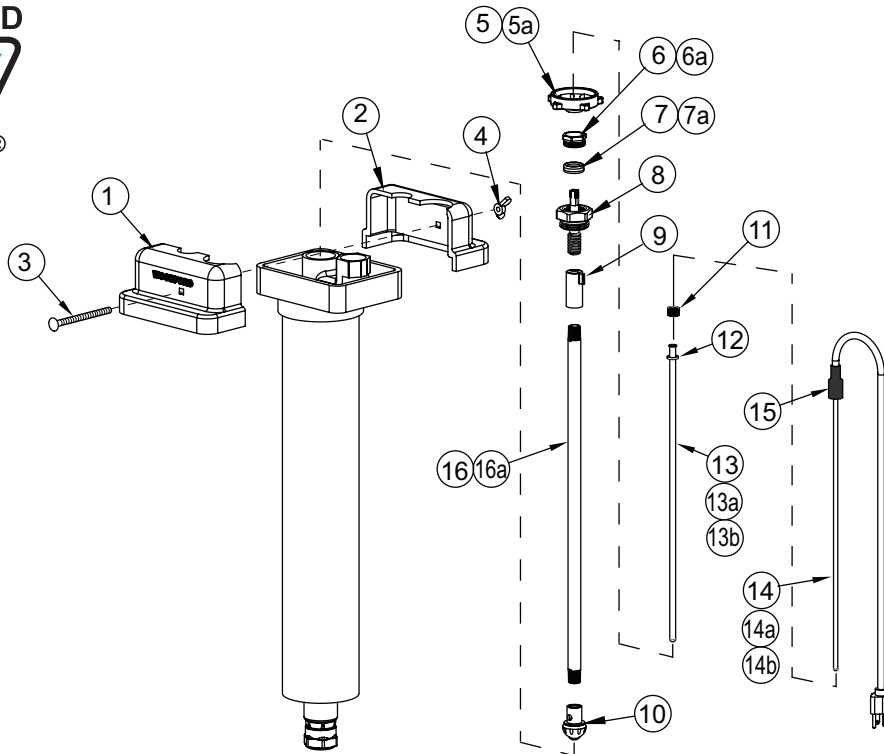

THERMALINE PARTS LIST

ITEM	PART#	DESCRIPTION
1	80055	Cover, Woodford
2	80056	Cover, Thermaline
3	80073	Carriage Bolt
4	80068	Wing Nut
5	80014	Handle (Brass)
*5a	80013	Handle (Brass) (For units sold before 6/1/2011)
6	80017	Packing Nut
*6a	80005	Packing Nut (For units sold before 6/1/2011)
7	30247	Packing
*7a	80008	Packing (For units sold before 6/1/2011)
8	85064	Head Nut Assembly
9	80066	Yoke Nut
10	85015	Combination Valve Assembly
**11	80062	Heater Well Thumb Nut
12	80063	Heater Well Washer
**13	85001	1' Heater Well Assembly (Includes Item 12) Standard on 1' Hydrants
**13a	85002	2' Heater Well Assembly (Includes Item 12) Standard on 2' - 6' Hydrants
**13b	85004	4' Heater Well Assembly (Includes Item 12) Optional on 6' hydrants and standard on 7'-8' hydrants
**14	85061	1' Heater Assembly (Includes Item 15) Standard on 1' Hydrants
**14a	85062	2' Heater Assembly (Includes Item 15) Standard on 2' - 6' Hydrants
**14b	85065	4' Heater Assembly (Includes Item 15) Optional on 6' hydrants and standard on 7'-8' hydrants
15	80061	Heater Cover
RK-THERM		Repair Kit (Includes Items 5-12)

THERMALINE PARTS LIST

ITEM	PART#	DESCRIPTION
OPERATING PIPE (For Brass Head)		
16	80081	1' Bury (11-1/8" long)
	80082	2' Bury (23-1/8" long)
	80083	3' Bury (35-1/8" long)
	80084	4' Bury (47-1/8" long)
	80085	5' Bury (59-1/8" long)
	80086	6' Bury (71-1/8" long)
	80087	7' Bury (83-1/8" long)
	80088	8' Bury (95-1/8" long)
OPERATING PIPE (For Cast Iron Head)		
16a	80031	1' Bury (9-3/8" long)
	80032	2' Bury (21-3/8" long)
	80033	3' Bury (33-3/8" long)
	80034	4' Bury (45-3/8" long)
	80035	5' Bury (57-3/8" long)
	80036	6' Bury (69-3/8" long)
	80037	7' Bury (81-3/8" long)

NOTES:

* Parts 5a, 6a & 7a cannot be used with 85064 Head Nut Assembly.

** Old style heaters originally used in Thermalines with cast iron covers are replaced by items 11, 13 and 14.

For more information contact...

WOODFORD MANUFACTURING COMPANY

2121 Waynoka Road, Colorado Springs, Colorado 80915 • Phone: (800) 621-6032 • Fax: (800) 765-4115

To view our complete product line visit: www.woodfordmfg.com or email: sales@woodfordmfg.com

A Division Of WCM Industries, Inc.

INSTALLATION INSTRUCTIONS



For more information contact...

WOODFORD MANUFACTURING COMPANY

2121 Waynoka Road, Colorado Springs, Colorado 80915 • Phone: (800) 621-6032 • Fax: (800) 765-4115

To view our complete product line visit: www.woodfordmfg.com or email: sales@woodfordmfg.com

A Division of WCM Industries, Inc.

THERMALINE®

Rev 02/12 Form No. IITL.104

SEE INSTALLATION INSTRUCTIONS LOCATED UNDER ORANGE COVER ON UNIT

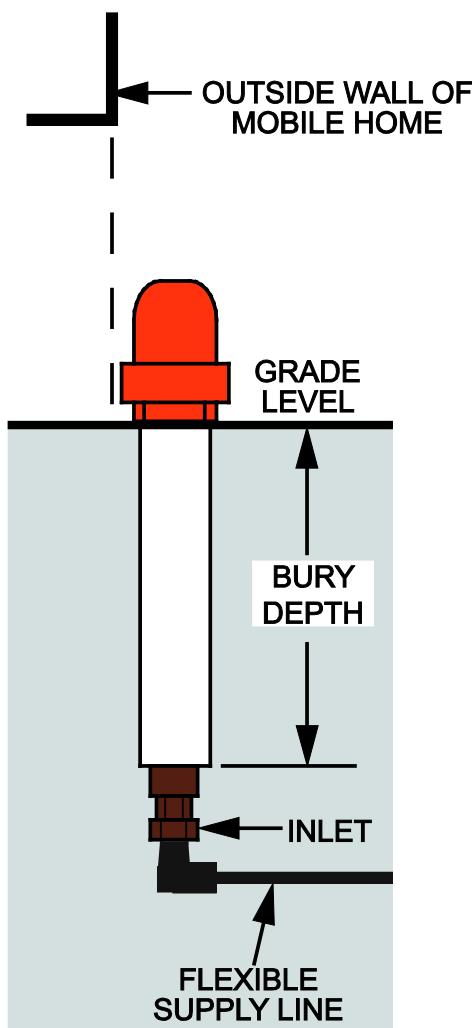

WARNING: Install THERMALINE beside rather than under mobile home to facilitate service of unit.

1. Carefully remove the Heater Assembly, taped to the side of the unit, and set aside.
2. Install THERMALINE so that outlet is 4 inches above grade or to the specifications of the local plumbing code and so that the valve body is below all danger of frost.
3. Flush gravel, debris, etc. out of the supply line before connecting hydrant.
4. To protect the hydrant supply connection from ground heaving or settling, connect the THERMALINE to water supply pipe with brass fittings and a flexible supply line.
5. Remove the orange Cover assembly.
6. Plumb to $\frac{3}{4}$ " N.P.T. outlet.
7. Remove plastic cap to expose Thumb Nut. Insert the Heater Assembly through the Heater Well Thumb Nut located on top of the round handle. Push the rubber Heater Cover down over the Thumb Nut.
8. After installation, check all connections for leaks.
9. Replace the orange cover assembly.
10. Plug power cord into a grounded 110-120v electric outlet.
11. Follow winterizing instructions when unit is not electrically heated or unit may freeze and burst.

NOTE: Using the THERMALINE for an electrical ground is a violation of the NATIONAL ELECTRICAL CODE.

TECH-NOTE



For more information contact...

WOODFORD MANUFACTURING COMPANY

2121 Waynoka Road, Colorado Springs, Colorado 80915 • Phone: (800) 621-6032 • Fax: (800) 765-4115

To view our complete product line visit: www.woodfordmfg.com or email: sales@woodfordmfg.com

A Division of WCM Industries, Inc.

THERMALINE®

Winterizing Instructions

Rev 02/12 Form No. TNTL.101

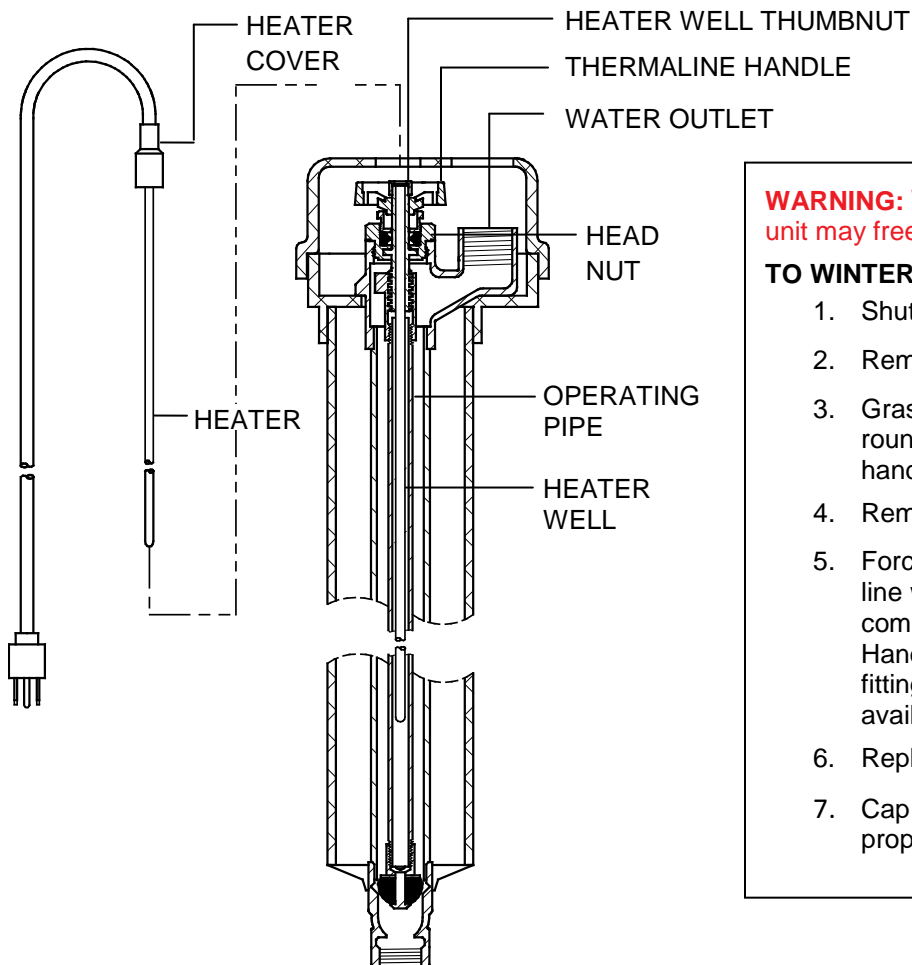

WARNING: Winterize when not electrically heated or unit may freeze and burst.

TO WINTERIZE:

1. Shut valve off.
2. Remove Heater and Rubber Cover.
3. Grasp THERMALINE Handle and remove round Heater Well Thumbnut (knurled fitting) on handle stem.
4. Remove Heater Well from inside of stem.
5. Force air into Water Outlet (where the water line was connected) until water has been completely removed through the hole in the Handle Stem. A hand tire pump with proper fittings can be used where pressurized air is not available.
6. Replace Heater Well and Thumbnut.
7. Cap or plug Water Outlet and Heater Well properly. Store Heater and accessories away.





TECH-NOTE

For more information contact...

WOODFORD MANUFACTURING COMPANY

2121 Waynoka Road, Colorado Springs, Colorado 80915 • Phone: (719) 574-1101 • Fax: (719) 574-7621

To view our complete product line visit: www.woodfordmfg.com or email: sales@woodfordmfg.com

A Division Of WCM Industries, Inc.

04/10 Rev 2

PURGING THERMALINE® TO WINTERIZE WHEN NOT IN USE:

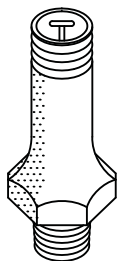

*Shrader WATER TANK
PRESSURE VALVE
("Snifter" Valve)
Available at
Plumbing Houses
in 1/8 or 1/4 NPT.*

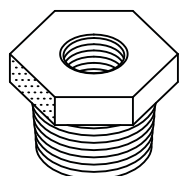

*3/4 to 1/8 or 1/4 NPT
Bushing to fit
"Snifter" Valve.*

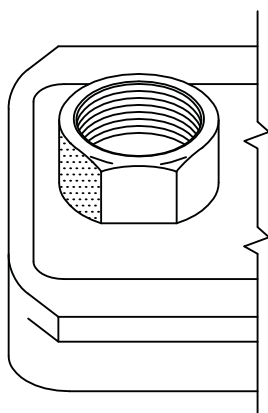

*THERMALINE
WATER OUTLET*

1. Shut valve off.
2. Remove HEATER and RUBBER COVER. Make sure valve is shut off.
3. Grasp THERMALINE HANDLE and remove HEATER WELL THUMBNUIT (knurled fitting) on handle stem. Remove HEATER WELL from inside of stem.
4. Insert BUSHING and AIRVALVE ACCESSORIES show at left.
5. Force air into WATER OUTLET (where the water line was connected) until water has been completely removed through the hole in the HANDLE STEM. A hand tire pump can be used where pressureized air is not available.
6. Replace HEATER WELL and THUMBNUIT.
7. Cap or plug holes properly. Store HEATER and ACCESSORIES away.

WARNING

failure to remove water from unheated Thermalines during freezing weather can cause them to freeze and cut the plunger or break other watertight parts.

TROUBLESHOOTING & MAINTENANCE



For more information contact...

WOODFORD MANUFACTURING COMPANY

2121 Waynoka Road, Colorado Springs, Colorado 80915 • Phone: (800) 621-6032 • Fax: (800) 765-4115

To view our complete product line visit: www.woodfordmfg.com or email: sales@woodfordmfg.com

A Division of WCM Industries, Inc.

Thermaline® Heated Yard Hydrant

Page 1

Rev 10/11 Form No.TMTline.101

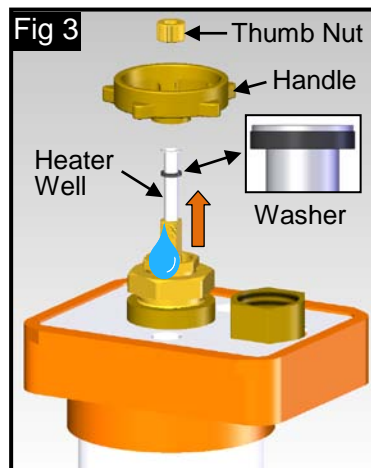
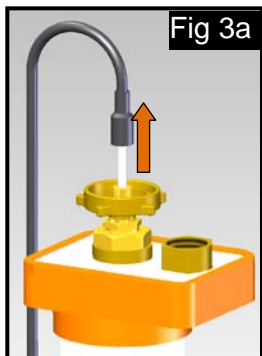
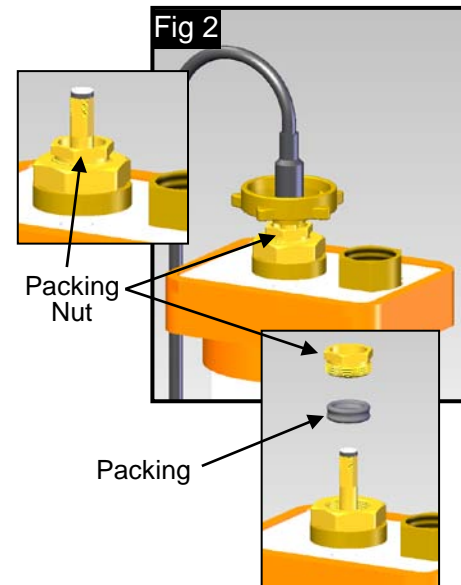
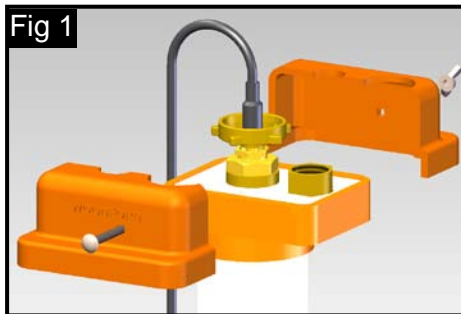
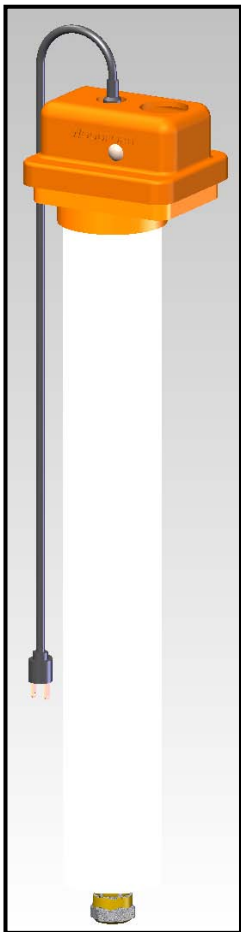

Fig 1: Unbolt and remove Head Covers to access valve and heater components.

Fig 2: Water leaks from around the brass Stem when the hydrant is on.

- The Packing Nut will occasionally need to be tightened to stop a packing leak.
- Tighten the Packing Nut until snug and the leak stops.
- Persistent leaks will require a new Packing.
(Order Packing #80008 for units sold before 6/1/2011)
(Order Packing #30247 for units sold after 6/1/2011)
See page 3 for replacement parts.

Fig 3: Water leaks from the top of the stem when the hydrant is on:

- The Heater Well, Heater Well Thumb Nut or Heater Well Washer may be missing or the Heater Well has a hole or split.
- To inspect the Heater Well:
 1. Unplug the power cord
 2. Pull the Heater and Cord assembly straight up and out of the Heater Well
 3. Remove the Thumb Nut, Heater Well and Handle. Pull the Heater Well straight up and out of the Hydrant. Be careful not to bend or dent the Heater Well.
 4. Reinstall or replace Heater Well.

TROUBLESHOOTING & MAINTENANCE



For more information contact...

WOODFORD MANUFACTURING COMPANY

2121 Waynoka Road, Colorado Springs, Colorado 80915 • Phone: (800) 621-6032 • Fax: (800) 765-4115

To view our complete product line visit: www.woodfordmfg.com or email: sales@woodfordmfg.com

A Division of WCM Industries, Inc.

Page 2

Rev 10/11 Form No.TMTline.101

Thermaline® Heated Yard Hydrant

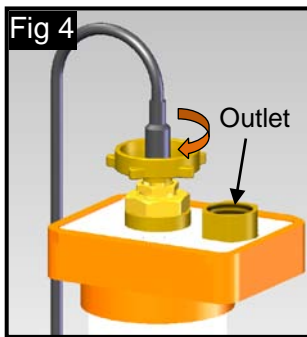

Hydrant is Off

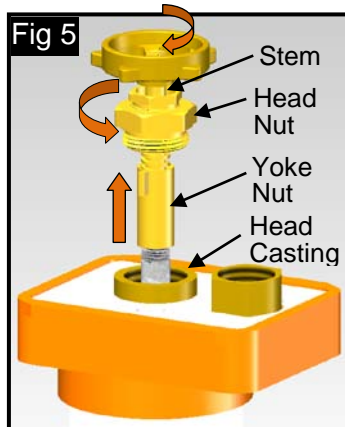
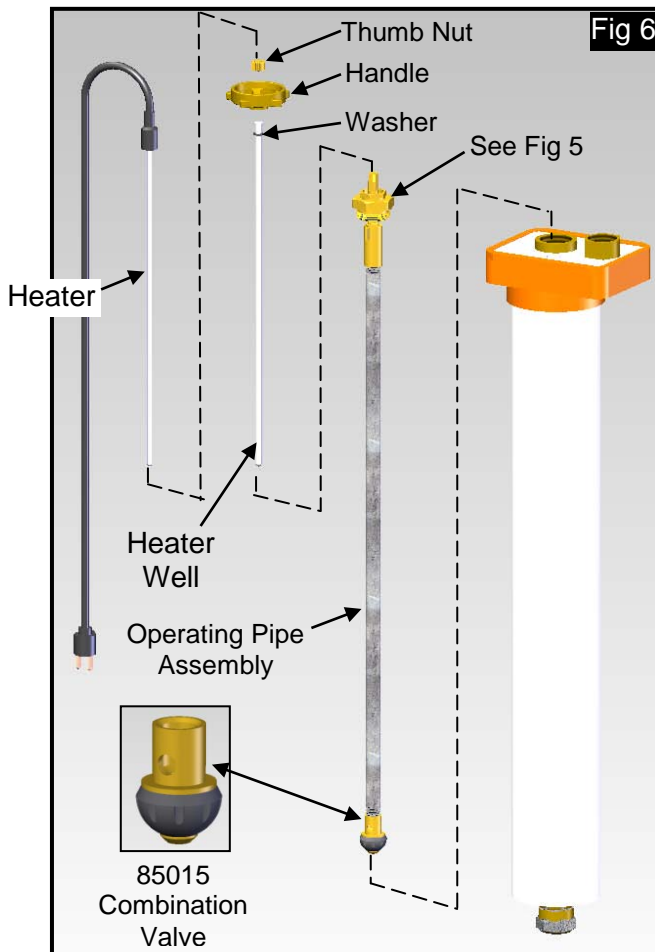

Fig 4: *Water leaks from the outlet when the hydrant is off:*

- The Combination Valve Assembly #85015 **Fig 6** may be worn or damaged and needs to be replaced.
- If the hydrant leaks just after installation, the valve seat may be fouled with debris such as small rocks.
- Follow the instructions below on how to remove the Operating Pipe, inspect or replace the Combination Valve and flush the Casing.

Fig 5 & 6: *Operating Pipe removal:*

1. Shut off the water supply to the hydrant and unplug the Heater.
2. Remove the Heater, Heater Well Thumbnut, Handle and Heater Well. Reference **Fig 3 & 3a**
3. Turn the Stem clockwise until it is seated, but not overly tight.
4. Loosen and turn the Head Nut assembly counterclockwise while turning the operating Stem clockwise until the threads disengage from the Head Casting.
5. With the stem screw engaged in the Yoke Nut, pry up until the 85015 Combination Valve pulls loose from the valve seat.
6. Inspect and/or replace the 85015 Combination Valve.
7. See Reinstall the Operating Pipe instructions on Page 3.



TROUBLESHOOTING & MAINTENANCE



For more information contact...

WOODFORD MANUFACTURING COMPANY

2121 Waynoka Road, Colorado Springs, Colorado 80915 • Phone: (800) 621-6032 • Fax: (800) 765-4115

To view our complete product line visit: www.woodfordmfg.com or email: sales@woodfordmfg.com

A Division of WCM Industries, Inc.

Page 3

Rev 10/11 Form No.TMTline.101

Thermaline® Heated Yard Hydrant

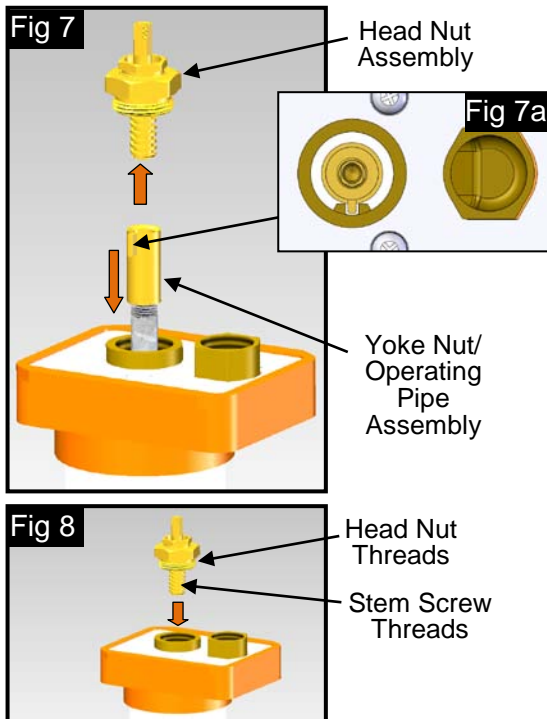

Reinstall the Operating Pipe:

- Fig 7:** Unthread the Operating Pipe from the Head Nut Assembly
- Fig 7a:** Push the Operating Pipe into the hydrant. *The wing on the Yoke Nut goes in the groove inside the Head.*
- Fig 8:** Start the Stem Screw thread into the Yoke Nut and turn the Stem Screw counterclockwise until the Head Nut threads can be engaged in the Head.
- Fig 8:** Thread the Head Nut Assembly into the Head clockwise while turning the Operating Stem counterclockwise.
- Fig 6:** (Page 2) Reinstall the Heater Well, Heater and hydrant parts in reverse order.

For Replacement Parts Order RK-THERM For Repair/Upgrade

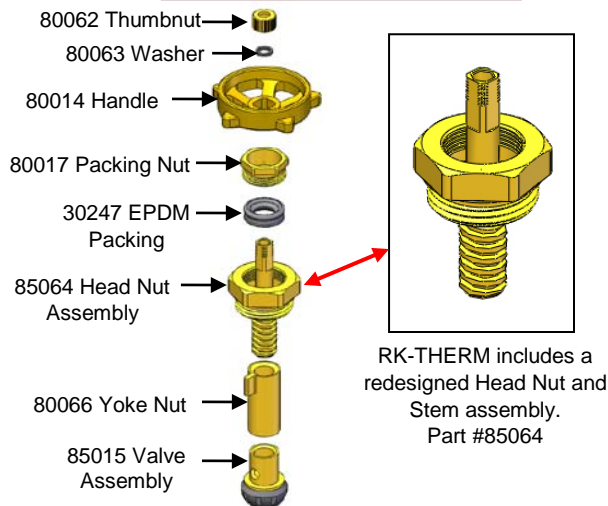

Replacement Parts For Hydrants Built Prior To 6/1/11

