

# RVH8542

UNDERMOUNT WORKSTATION BAR SINK

**RUVATI**<sup>®</sup>  
SPECIFICATION SHEET

## MATERIAL

True 16 Gauge Thickness  
Premium T304 Grade Stainless Steel  
18/10 Chromium/Nickel Content  
Commercial Brushed Finish

## FEATURES

- Heavy duty sound guard padding and undercoating
- Built-in glass rinser with drying rack
- Single-Tier Ledge for Accessories

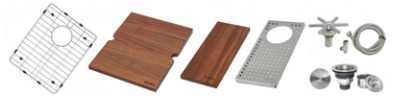

## IN THE BOX



Basket Strainer  
[RVA1025]



Mounting Clips  
[RVA11042]



Flex Hose  
[RVA11025]

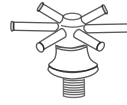

Sprayer Assembly  
[RVA11026]

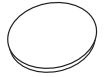

Drain Cover  
[RVA1035]



Cut-out  
Template

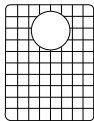

Rinse Grid  
[RVA68210]

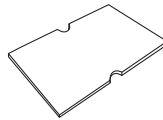

Cutting Board  
[RVA1210]

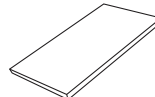

Cutting Board  
[RVA1242]

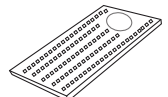

Drainer Grate  
[RVA11027]

## NOMINAL DIMENSIONS

**Exterior:** 22" (wide) x 18" (front-to-back)

**Interior Bowl:** 13" x 14 $\frac{5}{8}$ " (left), 7" x 14 $\frac{5}{8}$ " (right)

**Bowl Depth:** 10"

**Minimum Cabinet Size:** 24" wide

**Drain Hole Size:** 3 $\frac{1}{2}$ "

**Installation Type:**  
Undermount

**Inside Corners:**  
Sharp

**Drain Location:**  
Rear Center

**RUVATI USA**

www.ruvati.com

Phone: 1.855.478.8284  
Email: support@ruvati.com

# OPTIONAL ACCESSORIES (SOLD SEPARATELY)



Deep Basket  
Disposal Flange  
[RVA1049ST]



Deep Basket  
Disposal Flange/Stopper  
[RVA1052ST]



Garbage Disposal  
Flange/Stopper  
[RVA1042ST]



Deep Basket Strainer  
and Stopper  
[RVA1027ST]

## DIMENSIONS

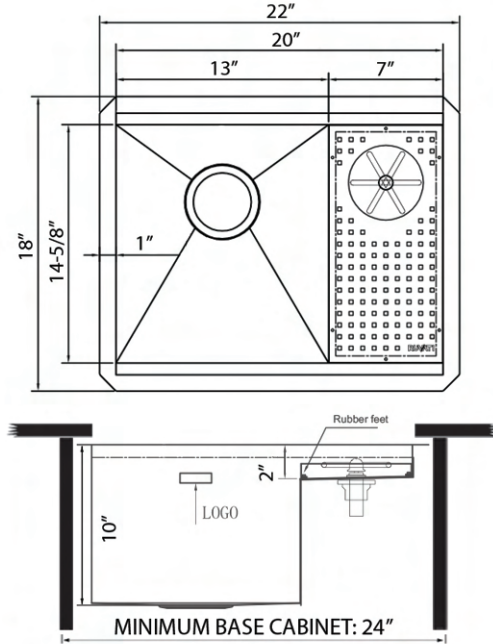

cUPC certified by IAPMO  
to meet US and Canada  
plumbing standards.



**SCAN TO REGISTER  
YOUR WARRANTY**

or visit  
[ruvati.com/register](http://ruvati.com/register)

**RUVATI USA**  
[www.ruvati.com](http://www.ruvati.com)

Phone: 1.855.478.8284  
Email: [support@ruvati.com](mailto:support@ruvati.com)