

110/150/199**Wall Mount Gas - Fired
Condensing Boiler - Combi Model**

User Information Manual

**⚠ WARNING**

If the information in this manual is not followed exactly, a fire or explosion may result, causing property damage, personal injury or loss of life.

Do not store or use gasoline or other flammable vapors and liquids in the vicinity of this or any other appliance.

— WHAT TO DO IF YOU SMELL GAS —

- **DO NOT** try to light any appliance.
- **DO NOT** touch any electrical switch; do not use any telephone in your building.
- Immediately call your gas supplier from a neighbor's telephone. Follow the gas supplier's instructions.
- If you cannot reach your gas supplier, call the fire department.
- Installation & service must be performed by a qualified installer, service technician or the gas supplier.



Please Read This Page First

To . . .	Read and use . . .	Page
Learn precautions	See Hazard Definitions, below	2
Locate boiler components	See illustration at right	2
Prevent air contamination	Laundry room or pool — make sure boiler air is piped to boiler per manual. Read list of air contaminants you must avoid. Have boiler air re-piped to another location if you can't avoid.	4
Maintain boiler	Set up a plan for maintaining the boiler using the schedule included in this manual. Schedule an annual start-up by a qualified service technician before every heating season.	5
Start — or — Shutdown boiler	Follow the Operating instruction sheet details to start or shutdown your boiler.	9
Understand control display	This page shows display screen modes and menu access information.	10
	This page shows how to access the USER MENU to set date and time and reset faults if the boiler enters LOCKOUT.	11-12

Simplicity™ Boiler Components



Hazard Definitions

The following defined terms are used throughout this manual to bring attention to the presence of hazards of various risk levels or to important information concerning the life of the product.

⚠ DANGER

Indicates presence of hazards that will cause severe personal injury, death or substantial property damage.

⚠ WARNING

Indicates presence of hazards that can cause severe personal injury, death or substantial property damage.

⚠ CAUTION

Indicates presence of hazards that will or can cause minor personal injury or property damage.

NOTICE

Indicates special instructions on installation, operation or maintenance that are important but not related to personal injury or property damage.

⚠ WARNING

- Have this boiler serviced/inspected by a qualified service technician, at least annually.
- Failure to comply with the above could result in severe personal injury, death or substantial property damage.

Item	Description
1	Control Display
2	Relief Valve
3	Air Vent
4	DHW Outlet Pipe
5	DHW Inlet Pipe
6	Boiler Out
7	Boiler In
8	Pressure/Temperature Gauge
9	Condensate trap and drain line (drain line must be installed by a qualified technician, per the boiler manual).
10	Relief valve drain line (must be run to safe drainage location — must be installed by a qualified technician, per the boiler manual).

NOTICE

When calling or writing about the boiler— Please have the boiler model number from the boiler rating label and the Consumer Protection (CP) number from the boiler cabinet.



Stop!! — Read Before Proceeding

Should overheating of boiler occur or gas supply fail to shut off, DO NOT turn off or disconnect electrical supply to circulator. Instead, shut off the gas supply at a location external to the appliance.

⚠ DANGER

- If any part of a boiler, burner or its controls has been sprayed with or submerged under water, either partially or fully, DO NOT attempt to operate the boiler until the boiler has been either replaced or completely repaired, inspected, and you are sure that the boiler and all components are in good condition and fully reliable.
- Otherwise, by operating this boiler, you will cause a fire or explosion hazard, and an electrical shock hazard, leading to serious injury, death, or substantial property damage. See the instructions at right.

⚠ WARNING

Failure to adhere to the guidelines on this page can result in severe personal injury, death or substantial property damage.

Boiler Service and Maintenance —

- To avoid electric shock, interrupt electrical supply before performing maintenance.
- To avoid severe burns, allow boiler to cool before performing maintenance.
- You must maintain the boiler as outlined in the manual and have the boiler started up and serviced at least annually by a qualified service technician to ensure boiler/system reliability.

Boiler Operation —

- Do not block flow of combustion or ventilation air to boiler. This boiler is equipped with a control which will automatically shut down the boiler should air or vent be blocked. If vent or air blockage is easily accessible and removable, remove it. The boiler should attempt to restart within an hour. If blockage is not obvious or cannot be removed, have the boiler and system checked by a qualified service technician.

Combustion Air —

- DO NOT obstruct the combustion air intake or expose the air intake to corrosive chemicals (see next page).

Carbon Monoxide Detector —

A carbon monoxide detector that is wired on the same electrical circuit as the boiler is strongly recommended.

Boiler Water —

- Do not use petroleum-based cleaning or sealing compounds in boiler system. Gaskets and seals in the system may be damaged. This can result in substantial property damage.
- Leaks in boiler or piping must be repaired at once to prevent make-up water. Use this boiler ONLY in a closed-loop system. Continual fresh make-up water will reduce boiler life. Mineral buildup in heat exchangers reduces heat transfer, overheats the materials, and causes failure. Addition of oxygen carried in by make-up water can cause internal corrosion.
- Do not add cold water to hot boiler. Thermal shock can cause heat exchanger to crack.

Saltwater Damage — The exposure of boiler components to saltwater can have both immediate and long-term effects. While the immediate effects of saltwater damage are similar to those of freshwater (shorting out of electrical components, washing out of critical lubricants, etc.), the salt and other contaminants left behind can lead to longer term issues after the water is gone due to the conductive and corrosive nature of the salt residue. Therefore, Weil-McLain equipment contaminated with saltwater or polluted water will no longer be covered under warranty and should be replaced.

Electrical Damage — If any electrical component or wiring came into contact with water, or was suspected to have come into contact with water, do not use this boiler. Immediately call a qualified service technician to inspect the boiler and to replace any part of the control system and any gas control that has been in contact with water.

Water Chemistry

Water quality must be maintained as described in boiler manual.

Water pH between 7.0 and 8.5

- Maintain boiler water pH between 7.0 and 8.5. Check with litmus paper or have chemically analyzed by water treatment company.
- If pH differs from above, consult local water treatment company for treatment needed.

Hardness less than 7 grains

Consult local water treatment companies for unusually hard water areas (above 7 grains hardness).

Chloride Concentration must be Less than 50 Ppm

- Filling with chlorinated fresh water should be acceptable since drinking water chloride levels are typically less than 5 ppm.
- Do not use the boiler to directly heat swimming pool or spa water.
- Do not fill boiler or operate with water containing chloride in excess of 50 ppm.

Freeze Protection Fluids —

- NEVER use automotive or standard glycol antifreeze. Use only freeze-protection fluids made for hydronic systems. Follow all guidelines given by the antifreeze manufacturer. Thoroughly clean and flush any replacement boiler system that has used glycol before installing the new boiler. Use only the products listed by Weil-McLain for use with this boiler. See boiler manual for details.

⚠ CAUTION

Frozen Water Damage Hazard

Residences or buildings that are unattended in severely cold weather, boiler system components failures, power outages, or other electrical system failures could result in frozen plumbing and water damage in a matter of hours. For your protection, take preventative actions such as having a security system installed that operates during power outages, senses low temperature, and initiates an effective action. Consult with your boiler contractor or a home security agency.



Prevent Combustion Air Contamination

Air Contamination

Common household and hobby products often contain fluorine or chlorine compounds. When these chemicals pass through the boiler, they can form strong acids in the vent system or boiler. The acid can eat through the vent or boiler wall, causing serious damage and presenting a possible threat of flue gas spillage into the building.

Please read the information on this page.

⚠ WARNING

- If the boiler combustion air inlet is located in any area likely to cause contamination, or if products which would contaminate the air cannot be removed, you must have the combustion air and vent re-piped and terminated to another location.
- Contaminated combustion air will damage the boiler, resulting in possible severe personal injury, death or substantial property damage.
- Do not operate the boiler if its combustion air inlet is located in a laundry room or pool facility, for example. These areas will always contain hazardous contaminants.

Combustion Air Contamination:

⚠ WARNING

- Ensure that the combustion air will not contain any of the contaminants in Figure 1.
- Combustion air supply openings or intake terminations must NOT be near a swimming pool, for example.
- Avoid areas subject to exhaust fumes from laundry facilities. These areas will always contain contaminants.

Figure 1 Corrosive contaminants and sources

Products to avoid
Spray cans containing chloro/fluorocarbons
Permanent wave solutions
Chlorinated waxes/cleaners
Chlorine-based swimming pool chemicals
Calcium chloride used for thawing
Sodium chloride used for water softening
Refrigerant leaks
Paint or varnish removers
Hydrochloric acid/muriatic acid
Cements and glues
Antistatic fabric softeners used in clothes dryers
Chlorine-type bleaches, detergents, and cleaning solvents found in household laundry rooms
Adhesives used to fasten building products and other similar products
Excessive dust and dirt
Areas likely to have contaminants
Dry cleaning/laundry areas and establishments
Swimming pools
Metal fabrication plants
Beauty shops
Refrigeration repair shops
Photo processing plants
Auto body shops
Plastic manufacturing plants
Furniture refinishing areas and establishments
New building construction



Annual Startup And General Maintenance

Figure 2 Service and maintenance schedules

OWNER MAINTENANCE (see the following pages for instructions)	
BEGINNING OF SEASON	Contact your boiler service technician to inspect, service and start up your boiler. You must have an annual start-up performed by a qualified service technician to ensure reliable operation of the boiler and system.
DAILY	<ul style="list-style-type: none"> • Check boiler area. • Check air openings. • Check pressure/temperature gauge. • Verify boiler jacket door is securely closed.
MONTHLY	<ul style="list-style-type: none"> • Check vent piping. • Check air piping. • Check relief valve. • Verify that domestic hot water is being supplied to fixtures at the correct temperature. • Check condensate drain system. • Check automatic air vents (if used). • Check display date and time.
EVERY 6 MONTHS	<ul style="list-style-type: none"> • Check boiler piping (gas and water). • Operate relief valve.

⚠ WARNING

Follow the service and maintenance procedures given throughout this manual and in component literature shipped with the boiler. Failure to perform the service and maintenance could result in damage to the boiler or system. Failure to follow the directions in this manual and component literature could result in severe personal injury, death or substantial property damage.



User Maintenance Procedures

Boiler must
be serviced and
maintained

⚠ WARNING

The boiler should be inspected and started annually, at the beginning of the heating season, only by a qualified service technician. In addition, the maintenance and care of the boiler designated on page 5 and explained on the following pages must be performed to assure maximum boiler efficiency and reliability. Failure to service and maintain the boiler and system could result in equipment failure, causing possible severe personal injury, death or substantial property damage.

⚠ CAUTION

The following information provides detailed instructions for completing the maintenance items listed in the maintenance schedule, page 5. In addition to this maintenance, the boiler must be serviced and started up at the beginning of each heating season by a qualified service technician.

Daily Maintenance

Check Boiler Area

⚠ WARNING

- To prevent potential of severe personal injury, death or substantial property damage, eliminate all materials discussed below from the boiler vicinity. If contaminants are found:
 - Remove products immediately from the area. If they have been there for an extended period, call a qualified service technician to inspect the boiler and vent system for possible damage from acid corrosion.
 - If products cannot be removed, immediately call a qualified service technician to address the problem.
1. Combustible/flammable materials — Do not store combustible materials, gasoline or any other flammable vapors or liquids near the boiler. Remove immediately if found.
 2. Air contaminants — Products containing chlorine or fluorine, if allowed to contaminate the boiler intake air, will cause acidic condensate in the vent and boiler. This will cause significant damage to the vent and/or boiler if allowed to continue.
 3. Read the list of potential materials listed on page 4 of this manual. If any of these products are in the room from which the boiler takes its combustion air, they must be removed immediately or the boiler combustion air must be supplied from outside.

Check Air Openings

1. Verify that combustion and ventilation air openings to the boiler room and/or building are open and unobstructed.
2. Verify that boiler vent discharge and air intake are clean and free of obstructions. Remove any debris on the air intake or flue exhaust openings.

Check Boiler Pressure/Temperature Gauge

1. Make sure the pressure reading on the boiler pressure/temperature gauge does not exceed 24 psig. Higher pressure may indicate a problem with the expansion tank.
2. Contact a qualified service technician if problem persists.

Verify that Boiler Jacket Door is Securely Closed

Visually inspect boiler jacket door to be sure it is sealed all around its perimeter. Verify that the door screws (located on bottom of door) are installed and secured.

⚠ WARNING

- The boiler jacket door must be securely fastened to the boiler to prevent boiler from drawing air from inside the boiler room. Screws should be tight.
- This is particularly important if the boiler is located in the same room as other appliances.
- Failure to keep the door securely fastened could result in severe personal injury or death.
- Contact your installer or technician immediately if the front door does not close correctly or if the door gaskets are damaged.



User Maintenance Procedures (continued)

Monthly Maintenance

Check Vent & Air Piping

Visually inspect the flue gas vent piping and air piping for any signs of blockage, leakage or deterioration of the piping. Notify your qualified service technician at once if you find any problem.

⚠ WARNING

Failure to inspect the vent/air system as noted above and have them repaired by a qualified service technician can result in vent system failure, causing severe personal injury or death.

Check the Relief Valve

1. Inspect the boiler relief valve and the relief valve discharge pipe for signs of weeping or leakage.
2. If the relief valve often weeps, the expansion tank may not be working properly. Immediately contact your qualified service technician to inspect the boiler and system.
3. **For Combi Boiler Models only:** Inspect the combi boiler's Domestic Hot Water Relief Valve and relief valve discharge pipe for signs of weeping or leakage.

Check the Condensate Drain System

1. Visually inspect the condensate drain tubing and the end of the tube. Make sure the tube is in good condition and that condensate can run freely.
2. Inspect the boiler condensate trap, located under the boiler (see Figure 3). Make sure the ball float in the trap is in place and appears to be free to move. Make sure the trap has water in it.
3. Contact a boiler service technician if you observe any problems.

Figure 3 Boiler condensate trap (front access panel removed)

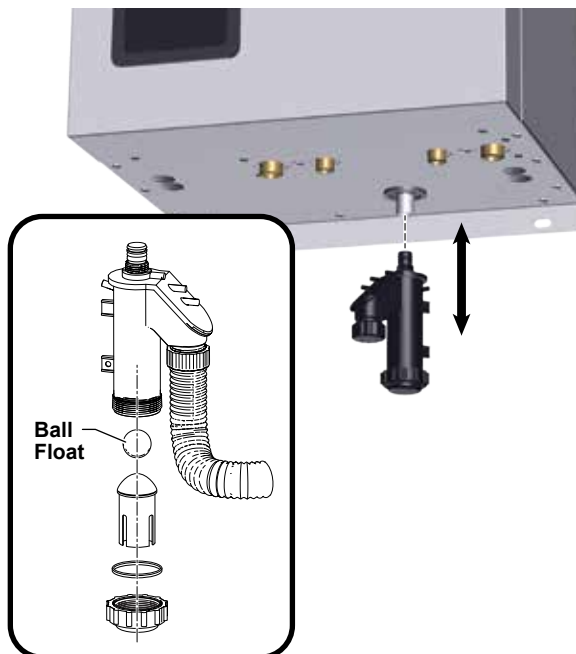

⚠ WARNING

Scald hazard — Water from air vent may be very hot. Avoid contact to prevent possible severe personal injury.

Check DHW Temperatures:

1. Check hot water temperatures at all fixtures
2. Allow hot water to run for several minutes and ensure water temperatures do not exceed 120°F. Temperatures above 120°F can scald. See scald warning on page 12.
3. The combi boiler's thermostatic mixing valve and/or other installed mixing valves may need adjustment. Contact your qualified service technician if temperature adjustments are needed.

Check Automatic Air Vents (If Used — Automatic Air Vents Must Be Used with Diaphragm-Type Expansion Tanks Only)

1. See Figure 4.
2. Remove the cap from any automatic air vent in the system and check operation by depressing valve "B" slightly with the tip of a screwdriver.
3. If the air vent valve appears to be working freely and not leaking, replace cap "A", twisting all the way on.
4. Loosen cap "A" one turn to allow vent to operate.
5. Have vent replaced if it does not operate correctly.

Figure 4 Automatic air vent

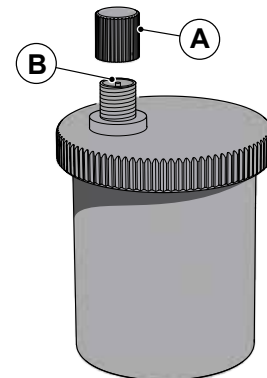

⚠ WARNING

Contact a boiler service technician immediately if you find the trap dry (no water inside).

Check Display Date and Time

1. Observe the date and time shown in the Date/Time screen by starting at the Home screen and press right arrow, then arrowing down until Date/Time is visible, then press Enter.
2. If the date or time is incorrect, follow the instructions in Figure 7, page 11 to access the USER MENU and change the date and/or time settings.
3. Keeping the date and time current makes sure the control can record problems accurately.



User Maintenance Procedures (continued)

Every 6 Months Maintenance

Check Boiler Piping

1. Check all gas lines and smell for gas odors. Perform gas leak inspection per steps 1 through 7, Operating Instructions, page 9. If gas odor or leak is detected, immediately shut down boiler following procedures on page 9. Call a qualified service technician.
2. Visually inspect for water leaks around all piping, circulators, relief valves and other fittings.
3. Immediately call a qualified service technician to repair any leaks.

⚠ WARNING

- Have leaks fixed at once by a qualified service technician. Continual fresh makeup water will reduce boiler life. Minerals can build up in the heat exchanger, reducing heat transfer and causing overheating. Heat exchanger failure can occur.
- Do not use petroleum-based cleaning or sealing compounds in boiler system. Severe damage to boiler and system components can occur, resulting in possible severe personal injury, death or substantial property damage.

Operate Boiler Relief Valve

⚠ WARNING

To avoid water damage or scalding due to valve operation, a metal discharge line must be connected to relief valve outlet and run to a safe place of disposal. This discharge line must be installed by a qualified heating installer or service technician in accordance with the instructions in the Simplicity™ Boiler Manual. The discharge line must be terminated so as to eliminate possibility of severe burns should the valve discharge.

1. Before proceeding, verify that the relief valve outlet has been piped to a safe place of discharge, avoiding any possibility of scalding from hot water.
2. Read the boiler pressure/temperature gauge to make sure the system is pressurized. Record pressure in system to refer to after checking relief valve.
3. Lift the relief valve top lever slightly, allowing water to relieve through the valve and discharge piping.
4. If water flows freely, release the lever and allow the valve to seat. Watch the end of the relief valve discharge pipe to ensure that the valve does not weep after the line has had time to drain. If the valve weeps, lift the seat again to attempt to clean the valve seat. If the valve continues to weep afterwards, contact your qualified service technician to inspect the valve and system.

5. If water does not flow from the valve when you lift the lever completely, the valve or discharge line may be blocked. Immediately shutdown the boiler, following the lighting instructions on the inside jacket top. Call your qualified service technician to inspect the boiler and system.
6. Verify and compare boiler pressure returns to recorded valve pressure before relief valve was checked. If pressure does not return to proper valve pressure, call a qualified service technician.

Operate Domestic Hot Water Relief Valve

1. Before proceeding, verify that the relief valve outlet has been piped to a safe place of discharge, avoiding any possibility of scalding from hot water.
2. Lift the relief valve top lever slightly, allowing water to relieve through the valve and discharge piping.
3. If water flows freely, release the lever and allow the valve to seat. Watch the end of the relief valve discharge pipe to ensure that the valve does not weep after the line has had time to drain. If the valve weeps, lift the seat again to attempt to clean the valve seat. If the valve continues to weep afterwards, contact your qualified service technician to inspect the valve and system.
4. If water does not flow from the valve when you lift the lever completely, the valve or discharge line may be blocked. Immediately shutdown the boiler, following the lighting instructions on the inside jacket top. Call your qualified service technician to inspect the boiler and system.

Operating Instructions

Figure 5 Operating instructions (see page 2 for location of manual gas valve)

FOR YOUR SAFETY — READ BEFORE OPERATING

⚠ WARNING

If you do not follow these instructions exactly, a fire or explosion may result causing property damage, personal injury or loss of life.

- A. This appliance does not have a pilot. It is equipped with an ignition device which automatically lights the burner. Do not try to light the burner by hand.
- B. Before OPERATING, smell all around the appliance area for gas. Be sure to smell next to the floor because some gas is heavier than air and will settle on the floor. See below.
- C. Use only your hand to toggle the switch and/or turn the manual gas valve. If the switch or valve will not move by hand, don't try to repair it, call a qualified service technician. Force or attempted repair may result in a fire or explosion.
- D. Do not use this appliance if any part has been under water. Immediately call a qualified service technician to inspect the appliance and to replace any part of the control system and any gas control, which has been under water.

WHAT TO DO IF YOU SMELL GAS

- Do not try to light any appliance.
- Do not touch any electric switch; do not use any phone in your building.
- Immediately call your gas supplier from a neighbor's phone. Follow the gas supplier's instructions.
- If you cannot reach your gas supplier, call the fire department.

OPERATING INSTRUCTIONS

1. **STOP!** Read the safety information above on this label. This appliance is equipped with an ignition device which automatically lights the burner. Do not try to light the burner by hand.
2. Set room thermostat(s) to lowest setting.
3. Turn OFF all electrical power to the appliance.
4. Toggle the switch located on Boiler's internal automatic gas valve to the "off" position.
5. Locate boiler manual gas valve (in the gas piping connected to the boiler).
6. Turn boiler manual gas valve handle counterclockwise ↺ to OPEN gas supply.
7. Wait five (5) minutes to clear out any gas. Then smell for gas, including near the floor.
8. If you smell gas, **STOP!** Turn the boiler manual gas valve to OFF. Then follow WHAT TO DO IF YOU SMELL GAS, above. If you don't smell gas, go to step 9, below.
9. Turn ON all electrical power to the appliance including the switch located on Boiler's internal automatic gas valve.
10. Set thermostat(s) to desired setting.
11. The boiler display will show symbols and/or text describing the status of the boiler as it proceeds through its operating sequence. "Standby" status means the burner is off.
12. If the appliance will not operate when there is a call for heat and piping is not hot, follow the instructions "To Turn Off Gas To Appliance" below and call your service technician or gas supplier.



(Off Position Shown)

Gas valve CLOSED

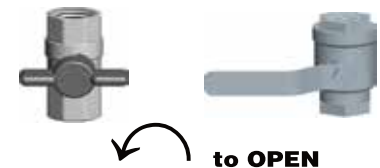

to OPEN

Gas valve OPEN

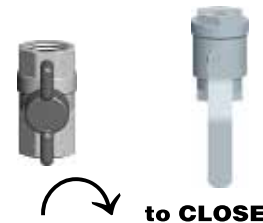

to CLOSE

(Typical gas valve shown; Actual valve may vary)

TO TURN OFF GAS TO THE APPLIANCE

1. Set room thermostats to lowest setting.
2. Turn OFF all electrical power to the appliance including the switch located on Boiler's internal automatic gas valve.
3. Turn boiler manual gas valve knob clockwise ↻ to close gas supply.

550-101-280 (0320)



Control Settings Menus

Figure 6 Simplicity™ control display screen layout and elements

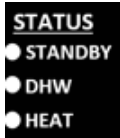
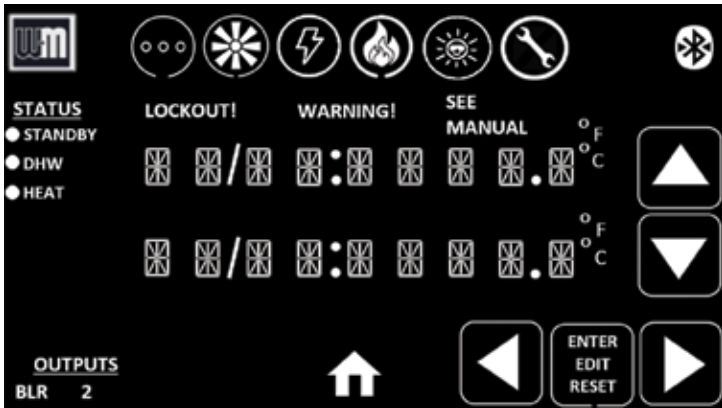

STATUS COLUMN: STANDBY through HEAT appear based on the status of the corresponding input. Dot appears next to the priority currently being serviced.



OUTPUTS ROW: 120v outputs and the status for each. When lit, the output is energized.



ARROW BUTTONS: Touch points for navigating the screen menus and options.



ACTION BUTTON: ENTER confirms an action (enter a menu, confirm a parameter, etc.) EDIT activates Edit mode, RESET is used to reset various things such as lockouts or Run Times.



NOTICES: LOCKOUT! Appears when boiler is in a lockout state. WARNING! appears when boiler is in a condition that does not prevent operation, but has altered its normal operation due to some condition. MANUAL segment appears on its own when manual overrides such as forced rate, forced 3 way valve, virtual input active, etc. SEE MANUAL appears in conjunction with the LOCKOUT! and WARNING! lights indicating to look in the manual's troubleshooting section for how to proceed.



TEMP UNIT SEGMENTS: appear when temperature is shown on the corresponding line, and symbol appears according to the temperature unit chosen for the display (Fahrenheit or Celsius).



Segmented LEDs: This space will display important information such as menu names, temperatures, parameters for the system, and lockout/warning information.

Screens shown above are typical only. Actual screens depend on control settings chosen.



The Simplicity™ Control Display

- Date/Time:** Allows user to edit the current date, time, and daylight savings time.
- Backlight:** Allows user to edit how bright the screen is during normal operation and when dormant.
- Software:** Displays the current software revisions of the control and display.
- Bluetooth:** Allows the user to turn Bluetooth ON or OFF.
- FCC:** Wireless device unique identifier registered with the U.S. Federal Communications Commission.
- IC:** Wireless certification approval number unique to all devices, required for Canada.



Assembled from tested components. Complete system not tested.

- This device complies with Part 15 of the FCC Rules. Operation is subject to the following two conditions: (1) this device may not cause harmful interference, and (2) this device must accept any interference received, including interference that may cause undesired operation.

- DHW SETTINGS:** Allows the user to edit the DHW Temp of the Combi demand, as well as PreHeat mode.
- SERVICE INFO:** Allows the user to view contractor and maintenance information, as well as reset the maintenance reminder when present.
- Settings:** Allows the user to edit temperature units, screen time out, and sound effect of presses.

Resetting Fault :

1. During a fault the Lockout/Warning/See Manual lights will illuminate on the display and the screen will look similar to the display shown here.
2. The user has the option to reset the fault on the screen.
3. To reset the fault, the user will have to press and hold the RESET button on the final screen shown.
4. Call for service if fault continues.

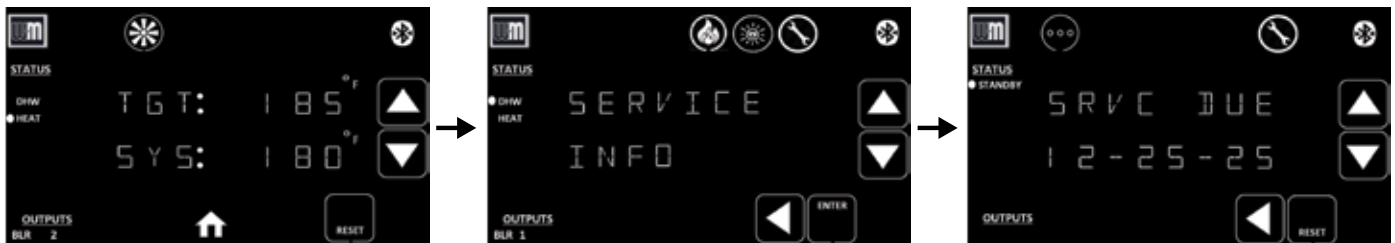
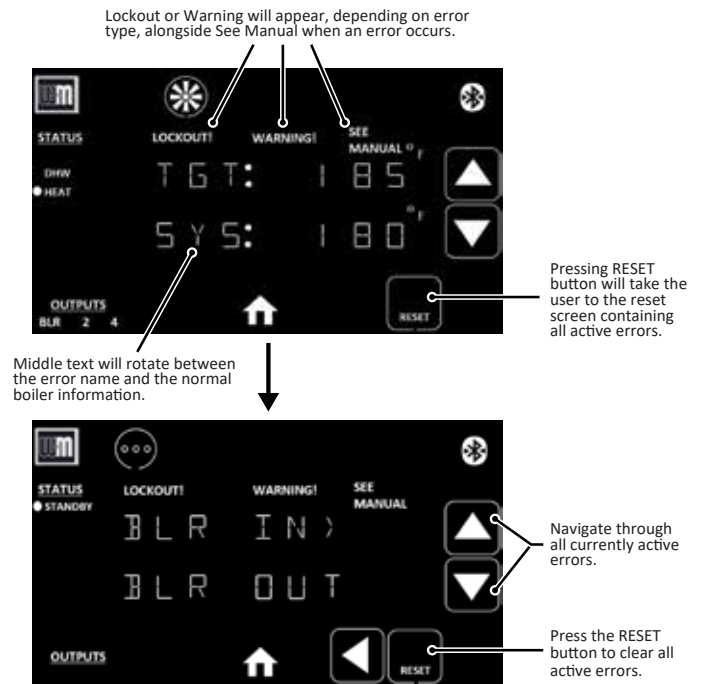

The middle SERVICE INFO can be accessed from the Homeowner Menu screen. Maintenance intervals should be set by a qualified technician when the boiler is initially installed.

When maintenance is due, the main screen will display a circled wrench like in the pictures. When maintenance is due, please have a qualified technician inspect the boiler. When maintenance reminder screen is displayed, you will be able to reset it to clear the reminder by pressing the RESET button on the screen shown on the right.

Screens shown above are typical only. Actual screens depend on control settings chosen.



The Simplicity™ Control Display

Figure 7 ECO Tec boiler control display **Homeowner Combi** controls

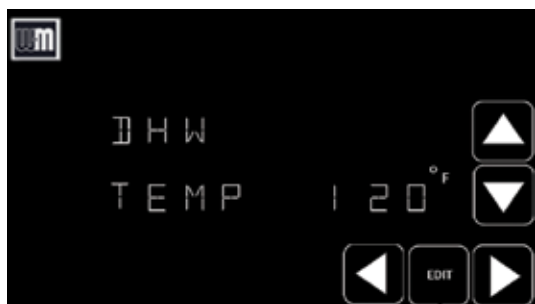

MENU ITEM	DESCRIPTION
The homeowner hot water screen can be accessed by going to the Homeowner menu screen and selecting the "SET HOT WATER" option.	
DHW	<ul style="list-style-type: none"> Set target temperature to the required Combi water temperature for the application according to design with mixing valve.
DHW ENABLED	<ul style="list-style-type: none"> Select whether to enable or disable Combi functionality. Disabling Combi functions will ignore DHW flow calls for heat and only allow space HEAT to service calls for heat.
PREHEAT MODE	<ul style="list-style-type: none"> Automatically maintains boiler water temperature to reduce boiler reaction time on Combi domestic hot water (DHW) draws. Turn PREHEAT mode ON or OFF.



Hot Water Can Scald!

- Water heated to temperature for clothes washing, dish washing and other sanitizing needs can scald and cause permanent injury.
- Children, elderly, and infirm or physically handicapped persons are more likely to be permanently injured by hot water. Never leave them unattended in bathtub or shower. Never allow small children to use a hot water tap or draw their own bath.
- If anyone using hot water in the building fits the above description, or if state laws or local codes require certain water temperatures at hot water taps, you must take special precautions:
 - Use lowest possible temperature setting.
 - Install a thermostatic protective device at each point of use in addition to the mixing valve installed at the water heater.
- Water passing out of drain valves may be extremely hot. To avoid injury:
 - Make sure all connections are tight.
 - Direct water flow away from any person.

For all applications:

**Protection must be taken against excessive pressure on the Combi side!
Install a pressure relief valve (150 psig) on the Combi Domestic Outlet pipe.**