

# AIR DUCT PRODUCTS

951.493.0082 office  
951.808.9076 fax

Ceiling Box

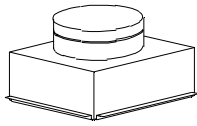

B-Box

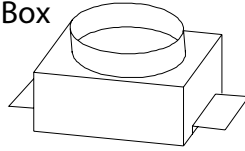

Side Outlet Ceiling Box

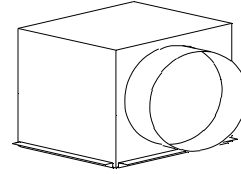

Return Air Can Blank

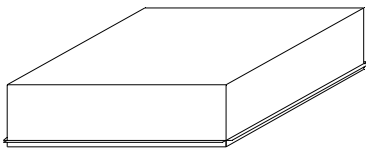

Return Air Can with Collar

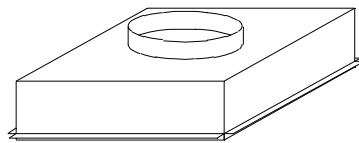

Floor Box

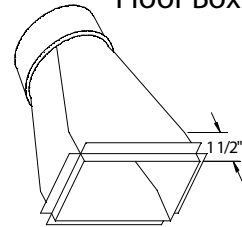

Riser Pipe

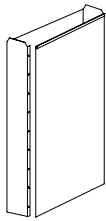

Riser Elbows

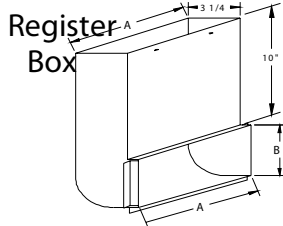
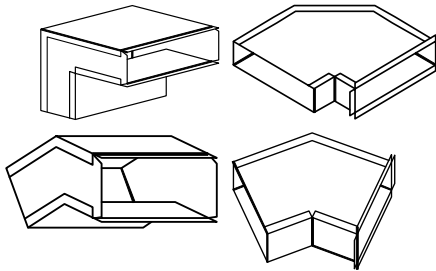

Concrete Box

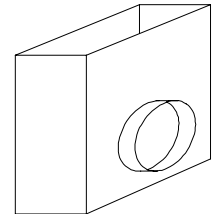

PH1

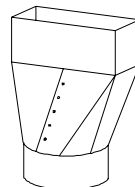

Register Boot

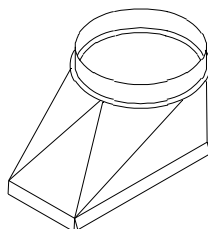

Perimeter Boot Adapter

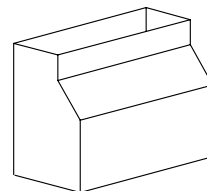

# AIR DUCT PRODUCTS

951.493.0082 office  
951.808.9076 fax

## 4" Deep Ceiling Boxes

30 GA	5456.	5457.	5458.
SIZE	No Collar w/ PG	w/Collar & PG	w/Collar No PG
06 x — x —	\$ 3.88	\$ 5.02	\$ 4.09
06 x 06 x (4-6)		4.88	
08 x — x —	4.74	6.20	4.97
08 x 08 x (4-8)		5.95	
10 x — x —	5.69	7.45	5.94
10 x 10 x (6-10)		7.11	
12 x — x —	6.73	8.50	7.00
12 x 12 x (6-12)		8.36	
14 x — x —	7.85	10.01	8.15
14 x 14 x (6-14)		9.70	
16 x — x —	9.07	12.44	9.38
16 x 16 x (8-16)		12.13	
18 x — x —	10.38	14.03	10.71
18 x 18 x (8-18)		13.65	
20 x — x —	11.78	15.65	12.13
20 x 20 x (10-20)		15.26	

26 GA	5456.	5457.	5458.
SIZE	No Collar w/ PG	w/Collar & PG	w/Collar No PG
06 x — x —	\$ 4.63	\$ 6.05	\$ 5.06
06 x 06 x (4-6)		5.86	
08 x — x —	5.72	7.44	6.24
08 x 08 x (4-8)		7.23	
10 x — x —	6.93	9.09	7.55
10 x 10 x (6-10)		8.72	
12 x — x —	8.26	10.65	8.97
12 x 12 x (6-12)		10.33	
14 x — x —	9.71	12.41	10.51
14 x 14 x (6-14)		12.07	
16 x — x —	11.28	15.10	12.18
16 x 16 x (8-16)		14.92	
18 x — x —	12.97	17.18	13.96
18 x 18 x (8-18)		16.89	
20 x — x —	14.78	19.53	15.87
20 x 20 x (10-20)		18.99	

5456 No Collar

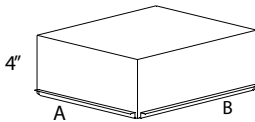

5457. With Collar & PG

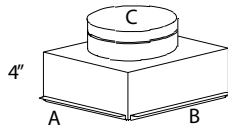

5458. With Collar No PG

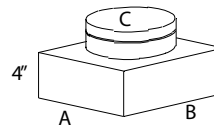

## B-Boxes with Ears

5451.

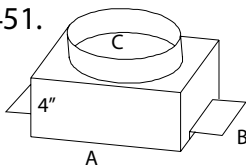

A x B x C	30 GA
06 x — x (4-6)	\$ 4.87
08 x — x (4-8)	5.08
10 x — x —	7.16
10 x 04 x (4-6)	5.18
10 x 06 x (4-8)	5.70
12 x — x —	7.79
12 x 04 x (4-6)	5.35
12 x 06 x (4-8)	6.02
14 x — x —	8.65
14 x 06 x (4-9)	6.44
14 x 08 x (6-10)	7.23

A x B x C	26 GA
06 x — x (4-6)	\$ 5.84
08 x — x (4-8)	6.12
10 x — x —	8.77
10 x 04 x (4-6)	6.30
10 x 06 x (4-8)	6.97
12 x — x —	10.39
12 x 04 x (4-6)	6.82
12 x 06 x (4-8)	7.39
14 x — x —	11.85
14 x 06 x (4-9)	7.95
14 x 08 x (6-10)	8.94

## Side Outlet Ceiling Boxes

30 GA		26 GA	
COLLAR SIZE	Multiply Girth x	COLLAR SIZE	Multiply Girth x
4"	\$ .31	4"	\$ .37
5"	.33	5"	.39
6"	.34	6"	.40
7"	.35	7"	.42
8"	.37	8"	.46
9"	.38	9"	.48
10"	.41	10"	.51
12"	.44	12"	.57
14"	.49	14"	.64
16"	.55	16"	.72
18"	.61	18"	.79
20"	.67	20"	.87

5455

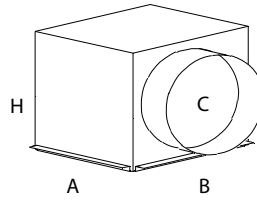

To calculate:  
Side (a+a+b+b) x  
collar size multiplier  
= List

### Side Outlet Standards:

- Box height 2" taller than collar
- 30 GA

## 8"- 14" Deep Ceiling Boxes

30 GA	Depth				
SIZE	8"	10"	11"	12"	14"
06 x 06	\$ 7.75	\$ 9.89	\$ 11.10	\$ 12.40	\$ 15.26
08 x 08	8.96	11.29	12.59	13.97	17.01
10 x 10	10.27	12.78	14.16	15.64	18.85
12 x 12	11.67	14.35	15.83	17.39	20.79
14 x 14	13.16	16.02	17.58	19.23	22.81
16 x 16	14.73	17.77	19.42	21.17	24.92

26 GA	Depth				
SIZE	8"	10"	11"	12"	14"
06 x 06	\$ 9.60	\$ 12.48	\$ 14.10	\$ 15.85	\$ 19.69
08 x 08	11.17	14.29	16.04	17.90	21.98
10 x 10	12.86	16.23	18.09	20.07	24.39
12 x 12	14.67	18.28	20.26	22.36	26.92
14 x 14	16.60	20.45	22.55	24.77	29.57
16 x 16	18.66	22.74	24.96	27.30	32.34

5451. B-Box w/Ears

5455. Side Outlet Ceiling Box

5492. Deep Ceiling Box

# AIR DUCT PRODUCTS

951.493.0082 office  
951.808.9076 fax

## Return Air Cans With PG

30 GA			4" Deep		6" Deep	
SIZE		SIZE	Blank	W/Collar	Blank	W/Collar
A	x	B	5481.	5486.	5482.	5487.
12.25	x	12.25	\$ 8.75	\$ 12.26	\$ 11.05	\$ 14.97
14.25	x	14.25	9.31	12.42	11.47	15.13
16.25	x	16.25	10.54	13.94	12.88	16.75
18.25	x	18.25	11.85	15.57	14.38	18.59
20.25	x	12.25	10.36	13.96	12.70	16.66
	x	14.25	11.08	14.79	13.52	17.60
	x	16.25	11.81	15.63	14.33	18.53
	x	18.25	12.54	16.47	15.15	19.47
	x	20.25	13.26	17.30	15.97	20.41
22.25	x	22.25	14.76	19.02	17.64	22.34
24.25	x	12.25	11.45	15.54	13.98	18.44
	x	14.25	12.27	16.47	14.88	19.48
	x	16.25	13.08	17.41	15.79	20.52
	x	18.25	13.90	18.35	16.69	21.56
	x	20.25	14.71	19.29	17.60	22.60
	x	24.25	16.35	21.16	19.41	24.69
25.25	x	12.25	11.73	15.85	14.30	18.81
	x	14.25	12.56	16.81	15.22	19.87
	x	16.25	13.40	17.78	16.15	20.94
	x	18.25	14.24	18.74	17.08	22.01
	x	20.25	15.08	19.71	18.01	23.07
	x	24.25	16.75	21.63	19.86	25.21

28 GA			4" Deep		6" Deep	
SIZE		SIZE	Blank	W/Collar	Blank	W/Collar
A	x	B	5481.	5486.	5482.	5487.
30.25	x	12.25	\$ 13.65	\$ 18.74	\$ 16.63	\$ 22.16
	x	14.25	14.66	19.89	17.73	23.42
	x	16.25	15.66	21.05	18.83	24.69
	x	18.25	16.67	22.21	19.93	25.95
	x	20.25	17.67	23.36	21.03	27.22
	x	24.25	19.68	25.67	23.23	29.75
36.25	x	12.25	15.38	21.05	18.64	24.80
	x	14.25	16.53	22.37	19.88	26.23
	x	16.25	17.68	23.69	21.13	27.66
	x	18.25	18.83	25.01	22.37	29.09
	x	20.25	19.97	26.33	23.61	30.52
	x	24.25	22.27	28.97	26.10	33.38
40.25	x	20.25	21.51	28.10	25.34	32.50
	x	22.25	22.75	29.53	26.68	34.04
	x	24.25	23.99	30.95	28.01	35.58
	x	26.25	25.24	32.38	29.35	37.12
44.25	x	20.25	23.04	29.86	27.06	34.48
	x	22.25	24.38	31.40	28.50	36.13
	x	24.25	25.72	32.94	29.93	37.78
	x	26.25	27.06	34.48	31.36	39.43
46.25	x	20.25	23.81	30.74	27.92	35.48
	x	22.25	25.19	32.34	29.40	37.18
	x	24.25	26.58	33.93	30.89	38.88
	x	26.25	27.97	35.52	32.37	40.58
48.25	x	20.25	24.58	31.62	28.79	36.47
	x	22.25	26.01	33.27	30.31	38.22
	x	24.25	27.44	34.92	31.84	39.98
	x	26.25	28.87	36.57	33.37	41.74

5481./5482.

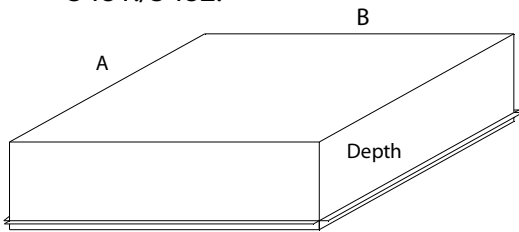

## Return Air Cans With PG

26 GA			4" Deep		6" Deep	
SIZE		SIZE	Blank	W/Collar	Blank	W/Collar
A	x	B	5481.	5486.	5482.	5487.
12.25	x	12.25	\$ 9.74	\$ 13.53	\$ 12.41	\$ 17.33
14.25	x	14.25	11.20	15.70	14.12	19.50
16.25	x	16.25	12.79	17.75	15.94	21.69
18.25	x	18.25	14.50	19.96	17.89	24.19
20.25	x	12.25	12.55	17.78	15.70	21.57
	x	14.25	13.49	18.92	16.76	22.84
	x	16.25	14.44	20.05	17.83	24.12
	x	18.25	15.38	21.18	18.89	25.39
	x	20.25	16.32	22.31	19.95	26.67
22.25	x	22.25	18.27	24.65	22.14	29.29
24.25	x	12.25	13.96	19.92	17.35	23.99
	x	14.25	15.02	21.19	18.53	25.41
	x	16.25	16.08	22.47	19.71	26.83
	x	18.25	17.14	23.74	20.90	28.25
	x	20.25	18.21	25.02	22.08	29.66
	x	24.25	20.33	27.57	24.45	32.50
25.25	x	12.25	14.31	20.34	17.76	24.48
	x	14.25	15.40	21.65	18.97	25.94
	x	16.25	16.49	22.96	20.18	27.39
	x	18.25	17.59	24.27	21.40	28.85
	x	20.25	18.68	25.58	22.61	30.30
	x	24.25	20.86	28.21	25.04	33.21
30.25	x	12.25	16.06	22.45	19.82	26.95
	x	14.25	17.31	23.94	21.18	28.58
	x	16.25	18.55	25.43	22.54	30.22
	x	18.25	19.79	26.92	23.91	31.86
	x	20.25	21.04	28.41	25.27	33.49
	x	24.25	23.52	31.40	27.99	36.76

26 GA			4" Deep		6" Deep	
SIZE		SIZE	Blank	W/Collar	Blank	W/Collar
A	x	B	5481.	5486.	5482.	5487.
36.25	x	12.25	\$ 18.17	\$ 25.32	\$ 22.28	\$ 30.25
	x	14.25	19.60	27.02	23.83	32.10
	x	16.25	21.02	28.73	25.37	33.95
	x	18.25	22.44	30.44	26.91	35.81
	x	20.25	23.86	32.15	28.46	37.66
	x	24.25	26.71	35.56	31.54	41.36
40.25	x	20.25	25.75	34.41	30.58	40.21
	x	22.25	27.29	36.26	32.25	42.20
	x	24.25	28.84	38.11	33.91	44.20
	x	26.25	30.38	39.97	35.57	46.20
44.25	x	20.25	27.64	36.67	32.71	42.76
	x	22.25	29.30	38.67	34.49	44.90
	x	24.25	30.96	40.66	36.28	47.04
	x	26.25	32.63	42.66	38.06	49.18
46.25	x	20.25	28.58	37.80	33.77	44.04
	x	22.25	30.30	39.87	35.62	46.25
	x	24.25	32.03	41.94	37.46	48.46
	x	26.25	33.75	44.01	39.30	50.67
48.25	x	20.25	29.52	38.94	34.84	45.31
	x	22.25	31.31	41.08	36.74	47.60
	x	24.25	33.09	43.22	38.64	49.88
	x	26.25	34.87	45.36	40.55	52.16

5486./5487. B

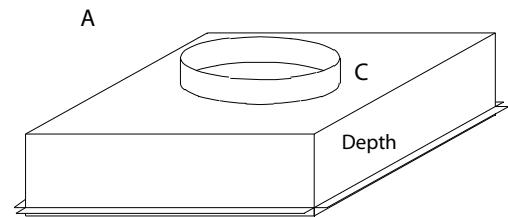

# AIR DUCT PRODUCTS

951.493.0082 office  
951.808.9076 fax

## Floor Boxes

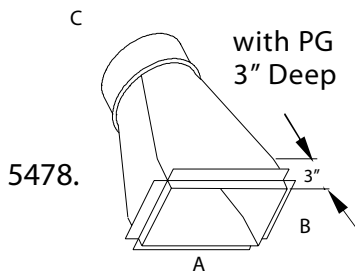
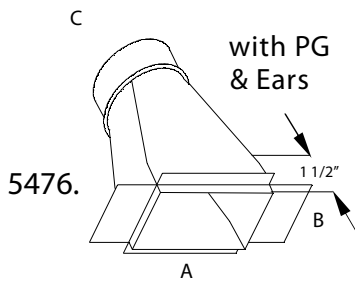
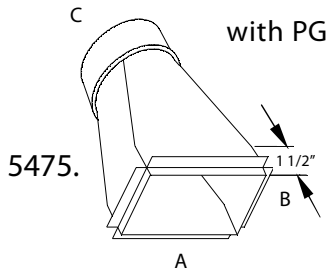

30 GA	5475.	5476.	5478.
SIZE AxBxC	w/ PG 1 1/2" Deep	w/ PG & Ears 1 1/2" Deep	w/ PG 3" Deep
06 x — x —	\$ 5.20	\$ 5.90	\$ 6.08
08 x — x —	6.81	8.25	8.84
08 x 04 x (4-6)	5.67	6.45	6.98
08 x 06 x 06	6.15	7.18	7.77
10 x — x —	7.98	10.37	10.98
10 x 04 x (4-8)	6.44	6.93	7.67
10 x 06 x (6-8)	6.21	8.16	7.82
12 x — x —	8.97	11.18	12.20
12 x 04 x (6-7)	7.15	7.68	8.42
12 x 06 x (6-8)	6.46	9.28	8.54
12 x 08 x 08	7.99	9.33	10.01
14 x — x —	11.38	12.96	14.03
14 x 04 x (6-8)	8.00	9.43	8.96
14 x 06 x (6-9)	8.19	10.54	9.24
14 x 08 x (8-10)	9.44	11.73	11.84
14 x 10 x 10	10.69	11.75	11.85
16 x — x —	12.33	14.78	15.94
16 x 06 x (8-9)	11.15	11.60	12.21
16 x 08 x (8-10)	11.33	11.65	12.42
18 x — x —	14.09	15.25	16.02
18 x 06 x (8-10)	13.02	12.39	12.86
20 x — x —	15.65	16.05	16.54
20 x 06 x (8-10)	14.26	14.07	13.05
20 x 08 x 10	14.86	14.23	13.66
22 x — x —	18.01	17.03	18.54
24 x — x —	24.28	23.12	23.05
24 x 06 x 08	19.98	21.98	16.84
24 x 08 x 10	22.12	22.36	21.54

## Floor Boxes

26 GA	5475.	5476.	5478.
SIZE AxBxC	w/ PG 1 1/2" Deep	w/ PG & Ears 1 1/2" Deep	w/ PG 3" Deep
06 x — x —	\$ 6.24	\$ 6.90	\$ 7.17
08 x — x —	8.08	9.89	10.80
08 x 04 x (4-6)	6.30	7.62	8.36
08 x 06 x 06	7.22	8.51	9.39
10 x — x —	9.61	12.62	13.61
10 x 04 x (4-8)	7.76	8.24	9.26
10 x 06 x (6-8)	7.57	9.80	9.44
12 x — x —	10.91	13.61	15.18
12 x 04 x (6-7)	8.52	9.21	10.24
12 x 06 x (6-8)	8.35	11.27	10.38
12 x 08 x 08	9.59	11.28	12.30
14 x — x —	14.02	15.88	17.58
14 x 04 x (6-8)	9.65	11.52	10.92
14 x 06 x (6-9)	9.84	12.93	11.27
14 x 08 x (8-10)	11.51	14.46	14.71
14 x 10 x 10	13.16	14.48	14.72
16 x — x —	15.41	18.23	20.04
16 x 06 x (8-9)	13.76	14.32	15.20
16 x 08 x (8-10)	14.05	14.37	15.45
18 x — x —	17.65	18.99	20.12
18 x 06 x (8-10)	16.25	17.00	16.01
20 x — x —	19.72	21.15	21.02
20 x 06 x (8-10)	17.82	17.70	16.29
20 x 08 x 10	18.10	18.01	17.09
22 x — x —	22.69	21.58	22.02
24 x — x —	27.92	26.10	27.15
24 x 06 x 08	23.15	24.59	21.32
24 x 08 x 10	23.45	25.12	25.62

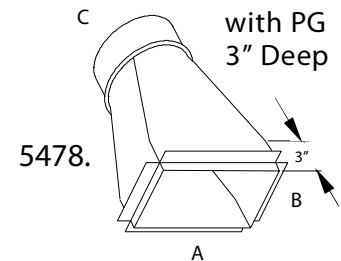
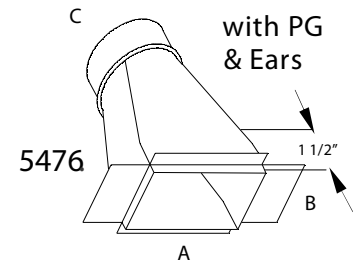
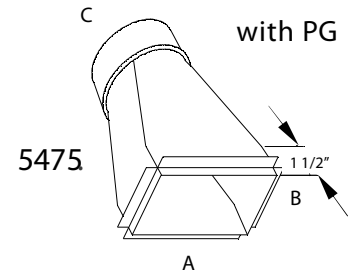

# AIR DUCT PRODUCTS

951.493.0082 office  
951.808.9076 fax

## Register Boxes

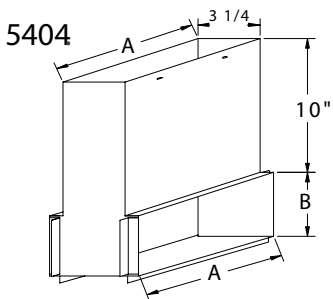
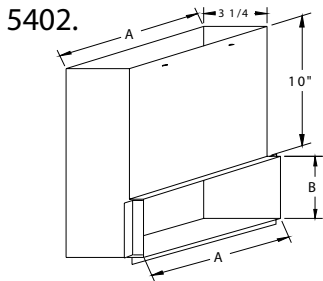
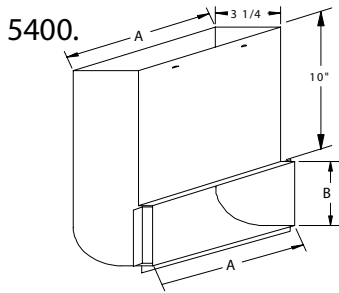

30 GA	Radius Heel		Square Heel		
SIZE	w/ PG	w/ PG & Ears	w/ PG	w/ PG & Ears	w/ PG Dual Outlet
(3.25 x A x B)	5400.	5401.	5402.	5403.	5404.
3.25 x 8 x 4	\$ 6.53	\$ 6.70	\$ 6.47	\$ 6.53	\$ 6.43
3.25 x 8 x —	7.26	7.44	7.61	7.68	7.40
3.25 x 10 x 4,6	7.86	8.08	7.26	7.71	7.11
3.25 x 10 x —	8.74	8.98	8.54	9.07	8.18
3.25 x 12 x 4,6	7.98	8.20	7.91	8.12	7.87
3.25 x 12 x —	8.87	9.11	9.30	9.55	9.05
3.25 x 14 x 6,8	8.97	9.19	8.44	8.97	8.64
3.25 x 14 x —	9.96	10.21	9.93	10.55	9.93

26 GA	Radius Heel		Square Heel		
SIZE	w/ PG	w/ PG & Ears	w/ PG	w/ PG & Ears	w/ PG Dual Outlet
(3.25 x A x B)	5400.	5401.	5402.	5403.	5404.
3.25 x 8 x 4	\$ 7.91	\$ 8.08	\$ 7.87	\$ 8.11	\$ 7.70
3.25 x 8 x —	8.79	8.97	9.26	9.54	8.85
3.25 x 10 x 4,6	9.67	9.89	8.90	9.17	8.58
3.25 x 10 x —	10.74	10.99	10.47	10.79	9.86
3.25 x 12 x 4,6	9.81	10.03	9.76	10.05	9.58
3.25 x 12 x —	10.90	11.15	11.49	11.83	11.02
3.25 x 14 x 6,8	11.12	11.35	10.81	11.13	10.58
3.25 x 14 x —	12.36	12.61	12.71	13.09	12.16

Register Box height is opening (B)+ 10"



# AIR DUCT PRODUCTS

951.493.0082 office  
951.808.9076 fax

## Register Boots

30GA	Straight	Stackhead	Cone
A x B x C	5405.	5406.	5407.
3.25 x 8 x 5,6	\$ 4.32	\$ 5.10	\$ 5.47
3.25 x 8 x —	4.86	5.74	6.33
3.25 x 10 x 5-8	4.94	6.58	6.71
3.25 x 10 x —	5.55	7.41	7.76
3.25 x 12 x 6-8	5.48	7.66	7.90
3.25 x 12 x —	6.58	8.62	8.78
3.25 x 14 x 7,8	6.35	8.26	8.03
3.25 x 14 x 9,10	6.99	8.59	8.70
3.25 x 14 x —	7.15	9.29	9.45

5405.

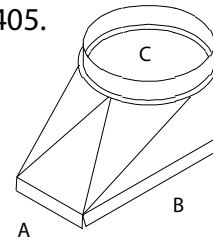

5406.

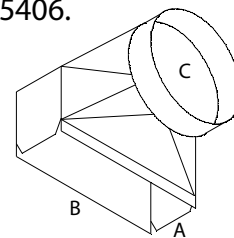

26GA	Straight	Stackhead	Cone
A x B x C	5405.	5406.	5407.
3.25 x 8 x 5,6	\$ 5.36	\$ 6.48	\$ 7.13
3.25 x 8 x —	5.99	7.25	7.47
3.25 x 10 x 5-8	6.22	8.57	8.93
3.25 x 10 x —	6.95	9.58	9.78
3.25 x 12 x 6-8	7.49	9.48	9.70
3.25 x 12 x —	8.37	10.67	10.78
3.25 x 14 x 7,8	8.19	10.26	11.07
3.25 x 14 x 9,10	8.93	10.60	11.17
3.25 x 14 x —	9.15	11.55	12.24

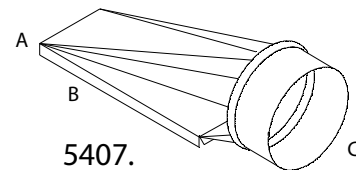

5407.

# AIR DUCT PRODUCTS

951.493.0082 office  
951.808.9076 fax

## Perimeter Boots

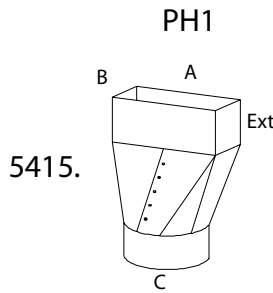

PH2

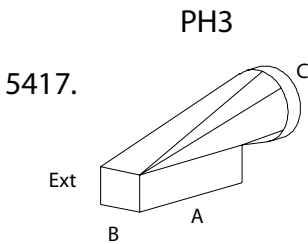
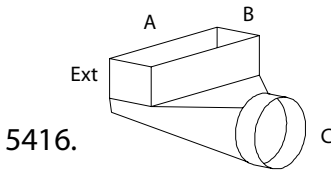

No PG 30 GA			
SIZE	Straight (PH1)	Stackhead (PH2)	Cone (PH3)
8 x (2.25, 4, 6) x 4 - 6	\$ 6.53	\$ 8.02	\$ 8.18
10 x (2.25, 4, 6) x 4 - 7	8.10	9.54	10.30
12 x (2.25, 4, 6) x 4 - 8	9.46	12.02	12.52
14 x (2.25, 4, 6) x 6 - 8	9.64	12.20	12.68
14 x (2.25, 4, 6) x 9,10	10.38	12.49	13.98
14 x 8 x 8 - 10	11.21	13.16	14.48
14 x 10 x 10	11.42	13.85	14.54

No PG 26 GA			
SIZE	Straight (PH1)	Stackhead (PH2)	Cone (PH3)
8 x (2.25, 4, 6) x 4 - 6	\$ 8.27	\$ 11.42	\$ 11.64
10 x (2.25, 4, 6) x 4 - 7	10.37	12.08	13.05
12 x (2.25, 4, 6) x 4 - 8	12.19	15.41	15.72
14 x (2.25, 4, 6) x 6 - 8	12.44	15.65	16.27
14 x (2.25, 4, 6) x 9,10	13.43	16.05	16.85
14 x 8 x 8 - 10	14.83	17.01	17.86
14 x 10 x 10	15.25	19.44	20.41

- 5415. PH1 no PG (Base Price)
- 5416. PH2 no PG (Base Price)
- 5417. PH3 no PG (Base Price)
- 5412. PH1 with PG (x 1.15) = List Price
- 5413. PH2 with PG (x 1.15) = List Price
- 5414. PH3 with PG (x 1.15) = List Price
- 5409. PH1 - PG & Ears (x 1.20) = List Price
- 5410. PH2 - PG & Ears (x 1.20) = List Price
- 5411. PH3 - PG & Ears (x 1.20) = List Price

- Perimeter Boot Standards:**
- Extension length is 6"
  - 0" and 3 1/2" extension also available
  - Please specify on order

## Perimeter Boot Adapters

A x B to A x 3 1/4	30 GA
8 x (2.25, 4, 6) to 8 x 3 1/4	\$ 5.94
10 x (2.25, 4, 6) to 10 x 3 1/4	6.56
12 x (2.25, 4, 6) to 12 x 3 1/4	7.19
14 x (2.25, 4, 6) to 14 x 3 1/4	7.81

A x B to A x 3 1/4	26 GA
8 x (2.25, 4, 6) to 8 x 3 1/4	\$ 7.36
10 x (2.25, 4, 6) to 10 x 3 1/4	8.20
12 x (2.25, 4, 6) to 12 x 3 1/4	9.04
14 x (2.25, 4, 6) to 14 x 3 1/4	9.88

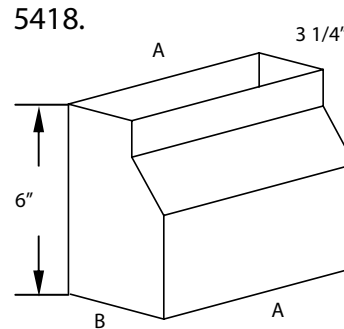

- 5418. Perimeter Boot Adapter
- 5491. Concrete Box - Straight Back
- 5492. Concrete Box - Slant Back

## Concrete Boxes

(A x B x Collar)	30 GA
10 x 2.25 x 5 - 8	\$ 9.52
12 x 2.25 x 5 - 8	10.39
14 x 2.25 x 5 - 8	11.26
10 x 4 x 5 - 8	10.66
12 x 4 x 5 - 8	11.57
14 x 4 x 5 - 8	12.48
10 x 6 x 5 - 8	12.14
12 x 6 x 5 - 8	13.09
14 x 6 x 5 - 9	14.05
14 x 8 x 8, 9	15.90

(A x B x Collar)	26 GA
10 x 2.25 x 5 - 8	\$ 11.76
12 x 2.25 x 5 - 8	12.93
14 x 2.25 x 5 - 8	14.10
10 x 4 x 5 - 8	13.30
12 x 4 x 5 - 8	14.52
14 x 4 x 5 - 8	15.75
10 x 6 x 5 - 8	15.28
12 x 6 x 5 - 8	16.56
14 x 6 x 5 - 9	17.85
14 x 8 x 8, 9	20.33

5491. Straight Back

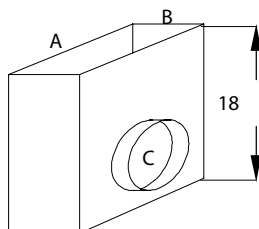

Shorter height same price as standard.

5492. Slant Back

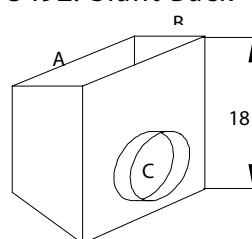

# AIR DUCT PRODUCTS

951.493.0082 office  
951.808.9076 fax

## Riser Pipe

30 GA	3' Length
Size	5420.
3.25 x 8	\$ 11.60
3.25 x 10	13.31
3.25 x 12	15.37
3.25 x 14	17.07

28 GA	5' Length	6' Length	7 1/2' Length	10' Length	End Cap
SIZE	5421.	5421.	5421.	5421.	5425.
3.25 x 8	\$19.95	\$23.87	\$29.27	\$38.71	\$ 1.46
3.25 x 10	22.90	27.39	33.65	44.51	1.58
3.25 x 12	26.32	31.50	38.73	51.15	1.70
3.25 x 14	29.27	35.02	43.11	56.95	1.83

5420./5421.

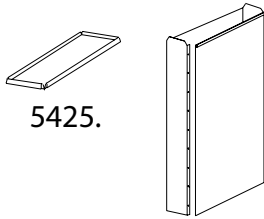

26 GA	3' Length	5' Length	6' Length	7 1/2' Length	10' Length	End Cap
SIZE	5420.	5421.	5421.	5421.	5421.	5425.
3.25 x 8	\$14.93	\$24.45	\$29.27	\$36.03	\$47.72	\$ 1.62
3.25 x 10	17.19	28.15	33.69	41.53	55.02	1.78
3.25 x 12	19.80	32.32	38.70	47.73	63.15	1.93
3.25 x 14	22.06	36.02	43.12	53.23	70.45	2.09

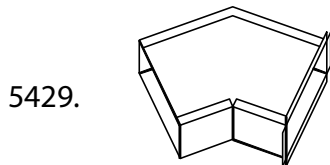
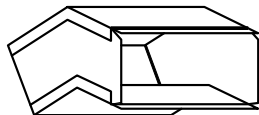
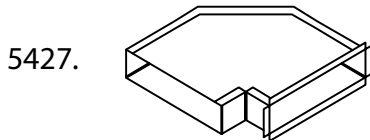
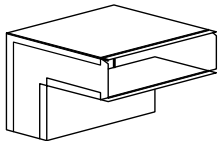

## Riser Elbows

28 GA	Std 90°	Flat 90°	Std 45°	Flat 45°
SIZE	5426.	5427.	5428.	5429.
3.25 x 8	\$ 5.36	\$ 7.29	\$ 5.20	\$ 6.29
3.25 x 10	5.72	8.69	5.56	7.58
3.25 x 12	6.09	10.26	5.92	8.46
3.25 x 14	6.46	12.04	6.29	10.08

26 GA	Std 90°	Flat 90°	Std 45°	Flat 45°
SIZE	5426.	5427.	5428.	5429.
3.25 x 8	\$ 5.89	\$ 8.33	\$ 5.69	\$ 7.07
3.25 x 10	6.33	10.07	6.12	8.66
3.25 x 12	6.77	12.03	6.55	9.76
3.25 x 14	7.21	14.25	6.99	11.78