

# OUTDOOR UNIT

# SERVICE MANUAL

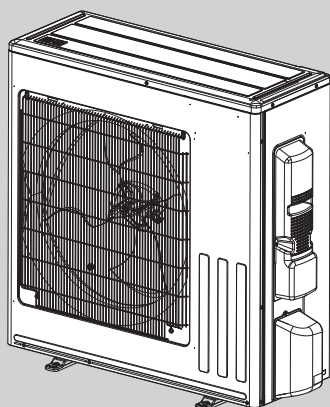


**No. OBH951  
REVISED EDITION-B**

## Models

- |                        |                          |                        |
|------------------------|--------------------------|------------------------|
| <b>MUZ-GX09NL</b> - U1 | <b>MUZ-GX09NLHZ</b> - U1 | <b>MUY-GX09NL</b> - U1 |
| <b>MUZ-GX12NL</b> - U1 | <b>MUZ-GX12NLHZ</b> - U1 | <b>MUY-GX12NL</b> - U1 |
| <b>MUZ-GX15NL</b> - U1 | <b>MUZ-GX15NLHZ</b> - U1 | <b>MUY-GX15NL</b> - U1 |
| <b>MUZ-GX18NL</b> - U1 | <b>MUZ-GX18NLHZ</b> - U1 | <b>MUY-GX18NL</b> - U1 |
| <b>MUZ-GX24NL</b> - U1 | <b>MUZ-GX24NLHZ</b> - U1 | <b>MUY-GX24NL</b> - U1 |
| <b>MUZ-GX30NL</b> - U1 |                          | <b>MUY-GX30NL</b> - U1 |
| <b>MUZ-GX36NL</b> - U1 |                          | <b>MUY-GX36NL</b> - U1 |

Indoor unit service manual  
 MSZ-GX•NL, MSY-GX•NL Series (OBH950)



- |              |            |
|--------------|------------|
| MUZ-GX18NL   | MUY-GX18NL |
| MUZ-GX24NL   | MUY-GX24NL |
| MUZ-GX30NL   | MUY-GX30NL |
| MUZ-GX36NL   | MUY-GX36NL |
| MUZ-GX18NLHZ |            |
| MUZ-GX24NLHZ |            |

## CONTENTS

1. TECHNICAL CHANGES .....	3
2. SERVICING PRECAUTIONS FOR UNITS USING REFRIGERANT R454B .....	4
3. PART NAMES AND FUNCTIONS .....	10
4. SPECIFICATION .....	11
5. OUTLINES AND DIMENSIONS .....	18
6. WIRING DIAGRAM .....	20
7. REFRIGERANT SYSTEM DIAGRAM .....	25
8. DATA .....	28
9. ACTUATOR CONTROL .....	52
10. SERVICE FUNCTIONS .....	53
11. TROUBLESHOOTING .....	54
12. DISASSEMBLY INSTRUCTIONS .....	80

**PARTS CATALOG (OBB951)**

## Use the specified refrigerant only

### Never use any refrigerant other than that specified.

Doing so may cause a burst, an explosion, or fire when the unit is being used, serviced, or disposed of.

Correct refrigerant is specified in the manuals and on the spec labels provided with our products.

We will not be held responsible for mechanical failure, system malfunction, unit breakdown or accidents caused by failure to follow the instructions.

#### <Preparation before the repair service>

- Prepare the proper tools.
- Prepare the proper protectors.
- Provide adequate ventilation.
- After stopping the operation of the air conditioner, turn off the power-supply breaker and pull the power plug.
- Discharge the capacitor before the work involving the electric parts.

#### <Precautions during the repair service>

- Do not perform the work involving the electric parts with wet hands.
- Do not pour water into the electric parts.
- Do not touch the refrigerant.
- Do not touch the hot or cold areas in the refrigeration cycle.
- When the repair or the inspection of the circuit needs to be done without turning off the power, exercise great caution not to touch the live parts.

### WARNING

- When the refrigerant circuit has a leak, do not execute pump down with the compressor.
- When pumping down the refrigerant, stop the compressor before disconnecting the refrigerant pipes.  
The compressor may burst if air etc. get into it.
- When opening or closing the valve below freezing temperatures, refrigerant may spurt out from the gap between the valve stem and the valve body, resulting in injuries.

#### Revision A:

- MUZ-GX09/12/15NL-[U1], MUZ-GX09/12/15NLHZ-[U1] and MUY-GX09/12/15NL-[U1] have been added.

#### Revision B:

- 12. DISASSEMBLY INSTRUCTIONS has been corrected.

# 1

## TECHNICAL CHANGES

**MUZ-GX18NL -  U1**

**MUZ-GX24NL -  U1**

**MUZ-GX30NL -  U1**

**MUZ-GX36NL -  U1**

**MUZ-GX18NLHZ -  U1**

**MUZ-GX24NLHZ -  U1**

1. New model

**MUY-GX18NL -  U1**

**MUY-GX24NL -  U1**

**MUY-GX30NL -  U1**

**MUY-GX36NL -  U1**

**MUZ-GX09NL -  U1**

**MUZ-GX12NL -  U1**

**MUZ-GX15NL -  U1**

**MUZ-GX09NLHZ -  U1**

**MUZ-GX12NLHZ -  U1**

**MUZ-GX15NLHZ -  U1**

1. New model

**MUY-GX09NL -  U1**

**MUY-GX12NL -  U1**

**MUY-GX15NL -  U1**

## 2 SERVICING PRECAUTIONS FOR UNITS USING REFRIGERANT R454B

### Servicing precautions for units using refrigerant R454B



#### WARNING

This unit uses a flammable refrigerant.

If refrigerant leaks and comes in contact with fire or heating part, it will create harmful gas and there is risk of fire.

Do not use means to accelerate the defrosting process or to clean, other than those recommended by the manufacturer. The appliance should not be stored in a room with continuously operating ignition sources (for example: open flames, an operating gas appliance, or an operating electric heater).

Do not pierce or burn.

Be aware that refrigerants may not contain an odor.

- Maintenance, service and repair operations shall be performed by authorized technician with required qualification.
- Servicing shall be performed only by methods recommended by the manufacturer.
- Refrigerant piping shall be protected from physical damage.
- Field installed piping should be kept to a minimum.
- Compliance with national gas regulations shall be observed.
- All field joints shall be accessible for inspection prior to being covered or enclosed.

#### ⚠️ ⚡️ WARNING

- The mounting height of indoor unit shall be 5.9 ft (1.8 m) or more from the floor. Up to 7.5 ft (2.3 m) is recommended.
- The unit shall be installed in rooms exceed the minimum room area ( $A_{min}$ ) determined by total refrigerant amount (M).

**NOTE:** For the corresponding table of the branch box system, refer to the multi-unit installation manual.

#### SYSTEM WITHOUT BRANCH BOX

M		$A_{min}$	
[kg]	[lbs, oz]	[m <sup>2</sup> ]	[ft <sup>2</sup> ]
0.5	1 1	1.9	21
0.6	1 5	2.3	25
0.7	1 8	2.6	28
0.8	1 12	3.0	33
0.9	1 15	3.4	37
1.0	2 3	3.8	41
1.1	2 6	4.1	45
1.2	2 10	4.5	49
1.3	2 13	4.9	53
1.4	3 1	5.2	56
1.5	3 4	5.6	61
1.6	3 8	6.0	65

M		$A_{min}$	
[kg]	[lbs, oz]	[m <sup>2</sup> ]	[ft <sup>2</sup> ]
1.7	3 11	6.3	68
1.8	3 15	6.8	74
1.9	4 3	7.2	78
2.0	4 6	7.6	82
2.1	4 10	7.9	86
2.2	4 13	8.3	90
2.3	5 1	8.7	94
2.4	5 4	9.1	98
2.5	5 8	9.4	102
2.6	5 11	9.8	106
2.7	5 15	10.2	110
2.8	6 2	10.6	115

### 1. REFRIGERANT PIPE NITROGEN PRESSURE TEST METHOD

(1) Connect the testing tools.

- Make sure the stop valves are closed and do not open them.
- Add pressure to the refrigerant lines through the service port of the stop valve for GAS.

(2) Do not add pressure to the specified pressure all at once; add pressure little by little.

1. Pressurize to 0.5 MPa (73 psig, 5 kgf/cm<sup>2</sup>G), wait 5 minutes, and make sure the pressure does not decrease.
2. Pressurize to 1.5 MPa (218 psig, 15 kgf/cm<sup>2</sup>G), wait 5 minutes, and make sure the pressure does not decrease.
3. Pressurize to 4.15 MPa (601 psig, 41.5 kgf/cm<sup>2</sup>G) and measure the surrounding temperature and refrigerant pressure.

(3) If the specified pressure holds for 24 Hours and does not decrease, the pipes have passed the test and there are no leaks.

- If the surrounding temperature changes by 1°F (0.5°C), the pressure will change by about 1 psig (0.007 MPa). Make the necessary corrections.

(4) If the pressure decreases in steps (2) or (3), there is a gas leak. Look for the source of the gas leak.

## 2. Additional refrigerant charge

### Additional refrigerant charge

Refrigerant for the indoor units and the extended piping is not included in the outdoor unit when the unit is shipped from the factory. Therefore, charge each refrigerant piping system with additional refrigerant at the installation site. In addition, in order to carry out service, enter the size and length of each liquid pipe and additional refrigerant charge amounts in the spaces provided on the "Refrigerant amount" plate on the outdoor unit.

#### NOTE:

- When the unit is stopped, charge the unit with the additional refrigerant through the liquid stop valve after the pipe extensions and indoor units have been vacuumized.
- When the unit is operating, add refrigerant to the gas check valve using a safety charger. Do not add liquid refrigerant directly to the check valve.

#### Refrigerant adjustment \*1

Model	MSZ-GX09/12/15NL MSY-GX09/12/15NL	MSZ-GX18/24/30/36NL MSY-GX18/24/30/36NL
Chargeless pipe length A	25 ft (7.5 m)	50 ft (15 m)
Refrigerant adjustment B	0.22 oz/ft (20 g/m)	
Additional refrigerant	Pipe length up to A : No need Pipe length exceeds A : B×(pipe length - A)	

\*1 When installing multi units, refer to the installation manual of the multi outdoor unit for unit installation.

## 3. REFRIGERANT SENSOR INSTALLATION AND REPLACEMENT

- For system with branch box, the refrigerant sensor shall be installed to the indoor unit before turning on the breaker.  
The refrigerant sensor is located inside the branch box package or can be ordered separately Parts Number **MAC-100RS-E**.
- When the refrigerant sensor is installed in the indoor unit, the system may stop operation if refrigerant leaks are detected.
- If the refrigerant sensor fails, replace the refrigerant sensor.
- The refrigerant sensor shall only be replaced with manufacturer approved sensor.
- If the refrigerant sensor error occurs even if the sensor is installed, check the cable connection for the sensor side and the main board side.

#### MSZ-GX06/09/12/15NL

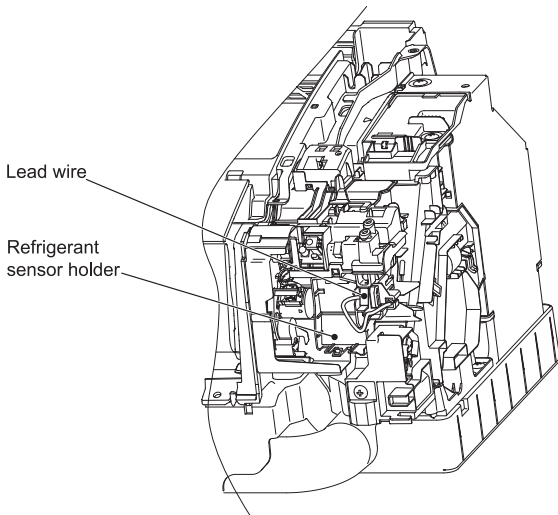


Fig. 1

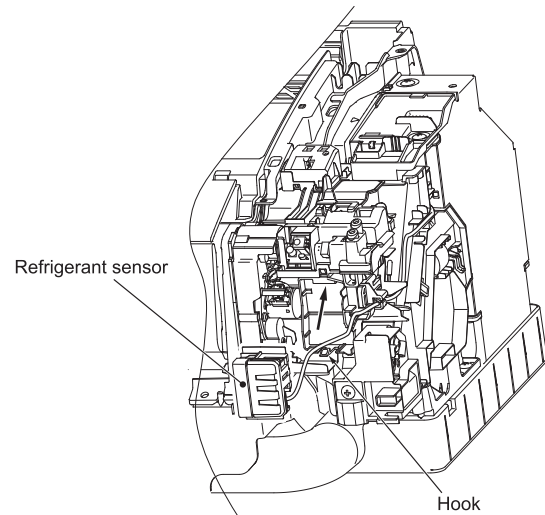
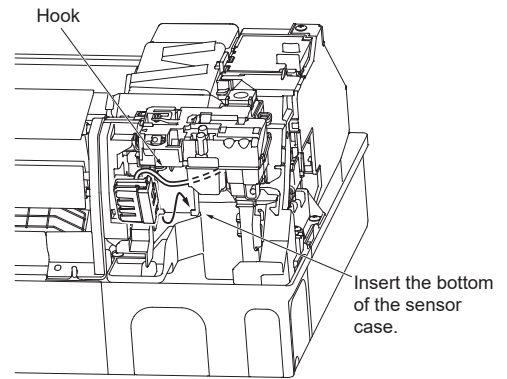
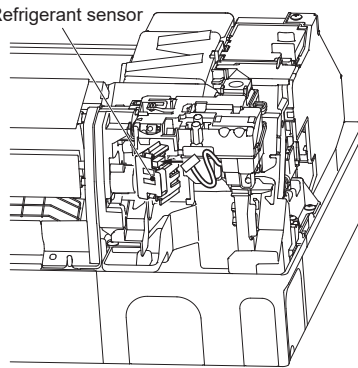
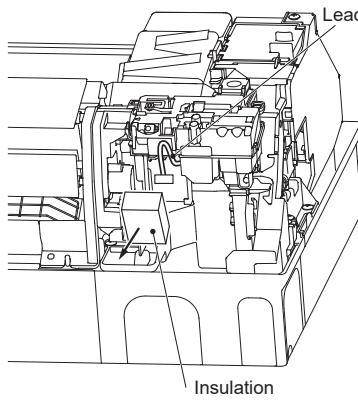


Fig. 2

- (1) Remove the lead wire fixed to the refrigerant sensor holder, then connect it to the refrigerant sensor board. (Fig.1)
- (2) Insert the refrigerant sensor in the direction of the arrow and then fix it with the hook. (Fig. 2)

## MSZ-GX18/24NL



- (1) Remove the panel.
- (2) Remove the insulation and take out the lead wire below the insulation. (Fig. 1)
- (3) Connect the lead wire to refrigerant sensor. (Fig. 2)
- (4) Insert the refrigerant sensor in the direction of the arrow and then fix it with the hook. (Fig. 3)

## 4. Cautions for the unit using R454B refrigerant

Basic work procedures are the same as those for conventional units using refrigerant R410A. However, pay careful attention to the following points.

### ■ Information on servicing

#### 1. Checks to the area

Prior to beginning work on systems containing FLAMMABLE REFRIGERANTS, safety checks are necessary to ensure that the risk of ignition is minimized. For repair to the REFRIGERATING SYSTEM, 2 to 6 below shall be completed prior to conducting work on the system.

#### 2. Work procedure

Work shall be undertaken under a controlled procedure so as to minimize the risk of a flammable gas or vapour being present while the work is being performed.

#### 3. General work area

All maintenance staff and others working in the local area shall be instructed on the nature of work being carried out. Work in confined spaces shall be avoided.

#### 4. Checking for presence of refrigerant

The area shall be checked with an appropriate refrigerant detector prior to and during work, to ensure the technician is aware of potentially toxic or flammable atmospheres. Ensure that the leak detection equipment being used is suitable for use with all applicable refrigerants, i.e. non-sparking, adequately sealed or intrinsically safe.

#### 5. Presence of fire extinguisher

If any hot work is to be conducted on the refrigerating equipment or any associated parts, appropriate fire extinguishing equipment shall be available to hand. Have a dry powder or CO<sub>2</sub> fire extinguisher adjacent to the charging area.

#### 6. No ignition sources

No person carrying out work in relation to a REFRIGERATING SYSTEM which involves exposing any pipe work shall use any sources of ignition in such a manner that it may lead to the risk of fire or explosion. All possible ignition sources, including cigarette smoking, should be kept sufficiently far away from the site of installation, repairing, removing and disposal, during which refrigerant can possibly be released to the surrounding space. Prior to work taking place, the area around the equipment is to be surveyed to make sure that there are no flammable hazards or ignition risks. "No Smoking" signs shall be displayed.

#### 7. Ventilated area

Ensure that the area is in the open or that it is adequately ventilated before breaking into the system or conducting any hot work. A degree of ventilation shall continue during the period that the work is carried out. The ventilation should safely disperse any released refrigerant and preferably expel it externally into the atmosphere.

#### 8. Checks to the refrigerating equipment

Where electrical components are being changed, they shall be fit for the purpose and to the correct specification. At all times the manufacturer's maintenance and service guidelines shall be followed. If in doubt, consult the manufacturer's technical department for assistance. The following checks shall be applied to installations using FLAMMABLE REFRIGERANTS:

- the actual REFRIGERANT CHARGE is in accordance with the room size within which the refrigerant containing parts are installed;
- the ventilation machinery and outlets are operating adequately and are not obstructed;
- marking to the equipment continues to be visible and legible. Markings and signs that are illegible shall be corrected;
- refrigerating pipe or components are installed in a position where they are unlikely to be exposed to any substance which may corrode refrigerant containing components, unless the components are constructed of materials which are inherently resistant to being corroded or are suitably protected against being so corroded.

#### 9. Checks to electrical devices

Repair and maintenance to electrical components shall include initial safety checks and component inspection procedures. If a fault exists that could compromise safety, then no electrical supply shall be connected to the circuit until it is satisfactorily dealt with. If the fault cannot be corrected immediately but it is necessary to continue operation, an adequate temporary solution shall be used. This shall be reported to the owner of the equipment so all parties are advised.

Initial safety checks shall include:

- that capacitors are discharged: this shall be done in a safe manner to avoid possibility of sparking;
- that no live electrical components and wiring are exposed while charging, recovering or purging the system;
- that there is continuity of earth bonding.

### ■ Repairs to sealed components

Sealed electrical components shall be replaced.

### ■ Repair to intrinsically safe components

Intrinsically safe components must be replaced.

### ■ Cabling

Check that cabling will not be subject to wear, corrosion, excessive pressure, vibration, sharp edges or any other adverse environmental effects. The check shall also take into account the effects of aging or continual vibration from sources such as compressors or fans.

### ■ Detection of flammable refrigerants

Under no circumstances shall potential sources of ignition be used in the searching for or detection of refrigerant leaks. A halide torch (or any other detector using a naked flame) shall not be used.

The following leak detection methods are deemed acceptable for all refrigerant systems.

Electronic leak detectors may be used to detect refrigerant leaks but, in the case of FLAMMABLE REFRIGERANTS, the sensitivity may not be adequate, or may need re-calibration. (Detection equipment shall be calibrated in a refrigerant-free area.)

Ensure that the detector is not a potential source of ignition and is suitable for the refrigerant used.

Leak detection equipment shall be set at a percentage of the LFL of the refrigerant and shall be calibrated to the refrigerant employed, and the appropriate percentage of gas (25 % maximum) is confirmed.

Leak detection fluids are also suitable for use with most refrigerants but the use of detergents containing chlorine shall be avoided as the chlorine may react with the refrigerant and corrode the copper pipe-work.

If a leak is suspected, all naked flames shall be removed/extinguished.

If a leakage of refrigerant is found which requires brazing, all of the refrigerant shall be recovered from the system, or isolated (by means of shut off valves) in a part of the system remote from the leak.

### ■ Removal and evacuation

When breaking into the refrigerant circuit to make repairs - or for any other purpose -conventional procedures shall be used. However, for flammable refrigerants it is important that best practice be followed, since flammability is a consideration.

The following procedure shall be adhered to:

- safely remove refrigerant following local and national regulations;
- evacuate;
- purge the circuit with inert gas;
- evacuate;
- continuously flush or purge with inert gas when using flame to open circuit; and
- open the circuit.

The refrigerant charge shall be recovered into the correct recovery cylinders if venting is not allowed by local and national codes.

For appliances containing flammable refrigerants, the system shall be purged with oxygen-free nitrogen to render the appliance safe for flammable refrigerants. This process might need to be repeated several times.

Compressed air or oxygen shall not be used for purging refrigerant systems.

For appliances containing flammable refrigerants, refrigerants purging shall be achieved by breaking the vacuum in the system with oxygen-free nitrogen and continuing to fill until the working pressure is achieved, then venting to atmosphere, and finally pulling down to a vacuum.

This process shall be repeated until no refrigerant is within the system. When the final oxygen-free nitrogen charge is used, the system shall be vented down to atmospheric pressure to enable work to take place.

The outlet for the vacuum pump shall not be close to any potential ignition sources, and ventilation shall be available.

### ■ Charging procedures

In addition to conventional charging procedures, the following requirements shall be followed.

- Ensure that contamination of different refrigerants does not occur when using charging equipment. Hoses or lines shall be as short as possible to minimize the amount of refrigerant contained in them.
- Cylinders shall be kept in an appropriate position according to the instructions.
- Ensure that the REFRIGERATING SYSTEM is earthed prior to charging the system with refrigerant.
- Label the system when charging is complete (if not already).
- Extreme care shall be taken not to overfill the REFRIGERATING SYSTEM.

Prior to recharging the system, it shall be pressure-tested with the appropriate purging gas. The system shall be leak-tested on completion of charging but prior to commissioning. A follow up leak test shall be carried out prior to leaving the site.



## ■ Decommissioning

Before carrying out this procedure, it is essential that the technician is completely familiar with the equipment and all its detail. It is recommended good practice that all refrigerants are recovered safely. Prior to the task being carried out, an oil and refrigerant sample shall be taken in case analysis is required prior to re-use of recovered refrigerant. It is essential that electrical power is available before the task is commenced.

- Become familiar with the equipment and its operation.
- Isolate system electrically.
- Before attempting the procedure, ensure that:
  - mechanical handling equipment is available, if required, for handling refrigerant cylinders;
  - all personal protective equipment is available and being used correctly;
  - the recovery process is supervised at all times by a competent person;
  - recovery equipment and cylinders conform to the appropriate standards.
- Pump down refrigerant system, if possible.
- If a vacuum is not possible, make a manifold so that refrigerant can be removed from various parts of the system.
- Make sure that cylinder is situated on the scales before recovery takes place.
- Start the recovery machine and operate in accordance with instructions.
- Do not overfill cylinders (no more than 80 % volume liquid charge).
- Do not exceed the maximum working pressure of the cylinder, even temporarily.
- When the cylinders have been filled correctly and the process completed, make sure that the cylinders and the equipment are removed from site promptly and all isolation valves on the equipment are closed off.
- Recovered refrigerant shall not be charged into another REFRIGERATING SYSTEM unless it has been cleaned and checked.

## ■ Labelling

Equipment shall be labelled stating that it has been de-commissioned and emptied of refrigerant. The label shall be dated and signed. For appliances containing FLAMMABLE REFRIGERANTS, ensure that there are labels on the equipment stating the equipment contains FLAMMABLE REFRIGERANT.

## ■ Recovery

When removing refrigerant from a system, either for servicing or decommissioning, it is recommended good practice that all refrigerants are removed safely.

When transferring refrigerant into cylinders, ensure that only appropriate refrigerant recovery cylinders are employed. Ensure that the correct number of cylinders for holding the total system charge is available.

All cylinders to be used are designated for the recovered refrigerant and labelled for that refrigerant (i.e., special cylinders for the recovery of refrigerant). Cylinders shall be complete with pressure-relief valve and associated shut-off valves in good working order.

Empty recovery cylinders are evacuated and, if possible, cooled before recovery occurs.

The recovery equipment shall be in good working order with a set of instructions concerning the equipment that is at hand and shall be suitable for the recovery of the flammable refrigerant.

If in doubt, the manufacturer should be consulted. In addition, a set of calibrated weighing scales shall be available and in good working order. Hoses shall be complete with leak-free disconnect couplings and in good condition.

The recovered refrigerant shall be processed according to local legislation in the correct recovery cylinder, and the relevant waste transfer note arranged. Do not mix refrigerants in recovery units and especially not in cylinders.

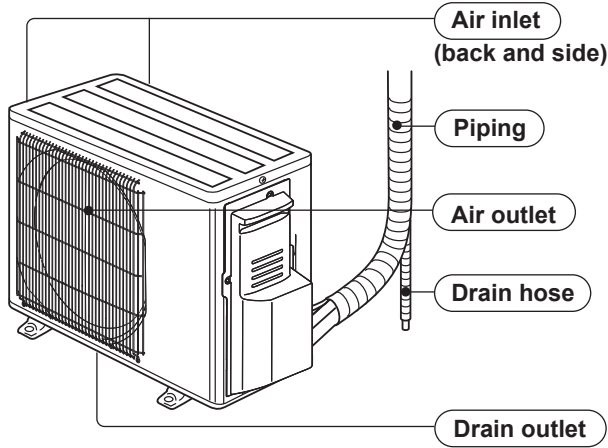
If compressors or compressor oils are to be removed, ensure that they have been evacuated to an acceptable level to make certain that FLAMMABLE REFRIGERANT does not remain within the lubricant.

The compressor body shall not be heated by an open flame or other ignition sources to accelerate this process. When oil is drained from a system, it shall be carried out safely.

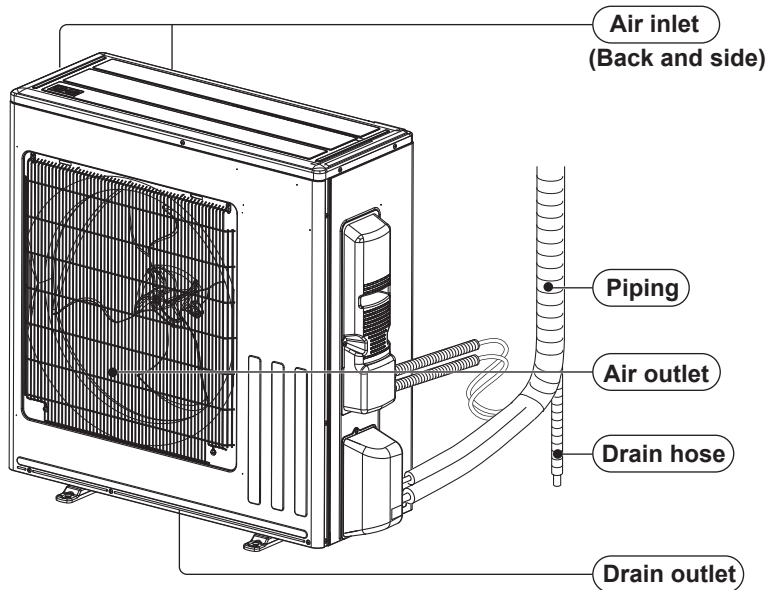
### 3

## PART NAMES AND FUNCTIONS

MUZ-GX09NL    MUZ-GX12NL    MUZ-GX15NL  
MUY-GX09NL    MUY-GX12NL    MUY-GX15NL  
MUZ-GX09NLHZ    MUZ-GX12NLHZ    MUZ-GX15NLHZ



MUZ-GX18NL    MUZ-GX24NL    MUZ-GX30NL    MUZ-GX36NL  
MUY-GX18NL    MUY-GX24NL    MUY-GX30NL    MUY-GX36NL  
MUZ-GX18NLHZ    MUZ-GX24NLHZ



# 4

# SPECIFICATION

Outdoor unit model			MUZ-GX09NL	MUY-GX09NL	MUZ-GX09NLHZ
Capacity Rated (Minimum – Maximum)	Cooling *1	Btu/h	9,000 (3,200–12,200)	9,000 (3,200–12,200)	9,000 (3,200–12,200)
	Heating 47 *1	Btu/h	10,900 (3,300–15,900)	—	9,600 (3,300–15,900)
Capacity Rated (Maximum)	Heating 17 *2	Btu/h	6,700 (10,200)	—	5,900 (11,500)
Power consumption Rated (Minimum – Maximum)	Cooling *1	W	585 (210–1,050)	585 (210–1,050)	585 (210–1,050)
	Heating 47 *1	W	720 (170–1,740)	—	580 (170–1,750)
Power consumption Rated (Maximum)	Heating 17 *2	W	730 (1,390)	—	650 (1,410)
EER2 *1 [SEER2] *3	Cooling		15.4 [28.4]	15.4 [28.4]	15.4 [28.4]
HSPF2 Region IV*4	Heating		10.9	—	10.2
COP	Heating *1		4.44	—	4.85
Power factor	Cooling	%	84	84	84
	Heating	%	92	—	90
Power supply	V, phase, Hz		208/230, 1, 60	208/230, 1, 60	208/230, 1, 60
Max. fuse size (time delay)	A		15	15	15
Min. circuit ampacity	A		12	12	12
Fan motor	F.L.A	A	0.71	0.71	0.71
Compressor	Model		SRB092FQFMC/ SRB092FQFMT	SRB092FQFMC/ SRB092FQFMT	SRB092FQFMC/ SRB092FQFMT
	R.L.A	A	7.0	7.0	7.0
	L.R.A	A	8.7	8.7	8.7
	Refrigeration oil	fl oz. (L) (Model)	11.8 (0.35)/(RM68EH)	11.8 (0.35)/(RM68EH)	11.8 (0.35)/(RM68EH)
Refrigerant control			Linear expansion valve	Linear expansion valve	Linear expansion valve
Sound level *1	Cooling	dB(A)	48	48	48
	Heating	dB(A)	50	—	50
Airflow High - Med. - Low	Cooling	CFM	1,152–1,152–541	1,152–1,152–541	1,177–1,177–553
	Heating	CFM	1,139–1,097–739	—	1,163–1,121–752
Fan speed High - Med. - Low	Cooling	rpm	900–900–460	900–900–460	900–900–460
	Heating	rpm	890–860–600	—	890–860–600
Defrost method			Reverse cycle	—	Reverse cycle
Dimensions	W	in.	31-1/2	31-1/2	31-1/2
	D	in.	11-1/4	11-1/4	11-1/4
	H	in.	21-5/8	21-5/8	21-5/8
Weight	lb.		77	77	77
External finish			Munsell 3Y 7.8/1.1	Munsell 3Y 7.8/1.1	Munsell 3Y 7.8/1.1
Remote controller			Wireless type	Wireless type	Wireless type
Control voltage (by built-in transformer)	V DC		12 – 24	12 – 24	12 – 24
Refrigerant piping			Not supplied	Not supplied	Not supplied
Refrigerant pipe size (Min. wall thickness)	Liquid	in.	1/4 (0.0315)	1/4 (0.0315)	1/4 (0.0315)
	Gas	in.	3/8 (0.0315)	3/8 (0.0315)	3/8 (0.0315)
Connection method	Indoor		Flared	Flared	Flared
	Outdoor		Flared	Flared	Flared
Between the indoor & outdoor units	Height difference	ft.	40	40	40
	Piping length	ft.	65	65	65
Refrigerant charge (R454B)			2lbs.	2lbs.	2lbs.

**NOTE:** Test conditions are based on AHRI 210/240.

\*1: Rating conditions (Cooling) — Indoor: 80°FDB, 67°FWB, Outdoor: 95°FDB, (75°FWB)  
(Heating) — Indoor: 70°FDB, 60°FWB, Outdoor: 47°FDB, 43°FWB

\*2: Rating conditions (Heating) — Indoor: 70°FDB, 60°FWB, Outdoor: 17°FDB, 15°FWB

\*3: Test condition (Refer to page 17.)

\*4: Test condition (Refer to page 17.)

Outdoor unit model			MUZ-GX12NL	MUY-GX12NL	MUZ-GX12NLHZ
Capacity Rated (Minimum – Maximum)	Cooling *1	Btu/h	12,000 (1,300–14,000)	12,000 (1,300–14,000)	12,000 (1,300–14,000)
	Heating 47 *1	Btu/h	14,400 (1,500–18,100)	—	12,300 (3,300–19,100)
Capacity Rated (Maximum)	Heating 17 *2	Btu/h	9,000 (12,000)	—	7,600 (16,000)
Power consumption Rated (Minimum – Maximum)	Cooling *1	W	900 (90–1,490)	900 (90–1,490)	900 (180–1,910)
	Heating 47 *1	W	1,100 (110–1,780)	—	920 (250–2,500)
Power consumption Rated (Maximum)	Heating 17 *2	W	1,000 (1,670)	—	820 (2,530)
EER2 *1 [SEER2] *3	Cooling		13.35 [25.6]	13.35 [25.6]	13.35 [25.6]
HSPF2 Region IV*4	Heating		10.7	—	10.0
COP	Heating *1		3.84	—	3.92
Power factor	Cooling	%	93	93	93
	Heating	%	95	—	93
Power supply	V, phase, Hz		208/230, 1, 60	208/230, 1, 60	208/230, 1, 60
Max. fuse size (time delay)	A		15	15	20
Min. circuit ampacity	A		12	12	16
Fan motor	F.L.A	A	0.71	0.71	0.71
Compressor	Model		SRB092FQFMC/ SRB092FQFMT	SRB092FQFMC/ SRB092FQFMT	SRB140FQHMC/ SRB140FQHMT
	R.L.A	A	7.0	7.0	9.4
	L.R.A	A	8.7	8.7	11.7
	Refrigeration oil	fl oz. (L) (Model)	11.8 (0.35)/(RM68EH)	11.8 (0.35)/(RM68EH)	11.8 (0.35)/(RM68EH)
Refrigerant control			Linear expansion valve	Linear expansion valve	Linear expansion valve
Sound level *1	Cooling	dB(A)	49	49	49
	Heating	dB(A)	51	—	51
Airflow High - Med. - Low	Cooling	CFM	1,152–1,152–541	1,152–1,152–541	1,191–1,191–553
	Heating	CFM	1,139–1,097–739	—	1,177–1,177–752
Fan speed High - Med. - Low	Cooling	rpm	900–900–460	900–900–460	910–910–460
	Heating	rpm	890–860–600	—	900–900–600
Defrost method			Reverse cycle	—	Reverse cycle
Dimensions	W	in.	31-1/2	31-1/2	31-1/2
	D	in.	11-1/4	11-1/4	11-1/4
	H	in.	21-5/8	21-5/8	21-5/8
Weight	lb.		77	77	82
External finish			Munsell 3Y 7.8/1.1	Munsell 3Y 7.8/1.1	Munsell 3Y 7.8/1.1
Remote controller			Wireless type	Wireless type	Wireless type
Control voltage (by built-in transformer)	V DC		12 – 24	12 – 24	12 – 24
Refrigerant piping			Not supplied	Not supplied	Not supplied
Refrigerant pipe size (Min. wall thickness)	Liquid	in.	1/4 (0.0315)	1/4 (0.0315)	1/4 (0.0315)
	Gas	in.	3/8 (0.0315)	3/8 (0.0315)	3/8 (0.0315)
Connection method	Indoor		Flared	Flared	Flared
	Outdoor		Flared	Flared	Flared
Between the indoor & outdoor units	Height difference	ft.	40	40	40
	Piping length	ft.	65	65	65
Refrigerant charge (R454B)			2lbs.	2lbs.	2lbs. 4oz

**NOTE:** Test conditions are based on AHRI 210/240.

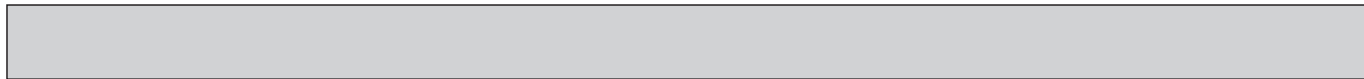
\*1: Rating conditions (Cooling) — Indoor: 80°FDB, 67°FWB, Outdoor: 95°FDB, (75°FWB)

(Heating) — Indoor: 70°FDB, 60°FWB, Outdoor: 47°FDB, 43°FWB

\*2: Rating conditions (Heating) — Indoor: 70°FDB, 60°FWB, Outdoor: 17°FDB, 15°FWB

\*3: Test condition (Refer to page 17.)

\*4: Test condition (Refer to page 17.)



Outdoor unit model			MUZ-GX15NL	MUY-GX15NL	MUZ-GX15NLHZ
Capacity Rated (Minimum – Maximum)	Cooling *1	Btu/h	14,000 (2,800–18,200)	14,000 (2,800–18,200)	14,000 (2,800–18,200)
	Heating 47 *1	Btu/h	18,000 (4,300–21,000)	—	14,000 (4,300–21,000)
Capacity Rated (Maximum)	Heating 17 *2	Btu/h	11,400 (16,400)	—	8,700 (16,800)
Power consumption Rated (Minimum – Maximum)	Cooling *1	W	1,075 (190–2,200)	1,075 (190–2,200)	1,075 (190–2,200)
	Heating 47 *1	W	1,600 (250–2,510)	—	1,100 (230–2,510)
Power consumption Rated (Maximum)	Heating 17 *2	W	1,330 (2,500)	—	950 (2,500)
EER2 *1 [SEER2] *3	Cooling		13.0 [22.2]	13.0 [22.2]	13.0 [22.2]
HSPF2 Region IV*4	Heating		11.0	—	10.0
COP	Heating *1		3.3	—	3.73
Power factor	Cooling	%	97	97	97
	Heating	%	96	—	95
Power supply	V, phase, Hz		208/230, 1, 60	208/230, 1, 60	208/230, 1, 60
Max. fuse size (time delay)	A		20	20	20
Min. circuit ampacity	A		16	16	16
Fan motor	F.L.A	A	0.71	0.71	0.71
Compressor	Model		SRB140FQHMC/ SRB140FQHMT	SRB140FQHMC/ SRB140FQHMT	SRB140FQHMC/ SRB140FQHMT
	R.L.A	A	9.4	9.4	9.4
	L.R.A	A	11.7	11.7	11.7
	Refrigeration oil	fl oz. (L) (Model)	11.8 (0.35)/(RM68EH)	11.8 (0.35)/(RM68EH)	11.8 (0.35)/(RM68EH)
Refrigerant control			Linear expansion valve	Linear expansion valve	Linear expansion valve
Sound level *1	Cooling	dB(A)	49	49	49
	Heating	dB(A)	51	51	51
Airflow High - Med. - Low	Cooling	CFM	1,166–1,166–541	1,166–1,166–541	1,191–1,191–553
	Heating	CFM	1,152–1,152–739	—	1,177–1,177–752
Fan speed High - Med. - Low	Cooling	rpm	910–910–460	910–910–460	910–910–460
	Heating	rpm	900–900–600	—	900–900–600
Defrost method			Reverse cycle	—	Reverse cycle
Dimensions	W	in.	31-1/2	31-1/2	31-1/2
	D	in.	11-1/4	11-1/4	11-1/4
	H	in.	21-5/8	21-5/8	21-5/8
Weight	lb.		81	81	82
External finish			Munsell 3Y 7.8/1.1	Munsell 3Y 7.8/1.1	Munsell 3Y 7.8/1.1
Remote controller			Wireless type	Wireless type	Wireless type
Control voltage (by built-in transformer)	V DC		12 – 24	12 – 24	12 – 24
Refrigerant piping			Not supplied	Not supplied	Not supplied
Refrigerant pipe size (Min. wall thickness)	Liquid	in.	1/4 (0.0315)	1/4 (0.0315)	1/4 (0.0315)
	Gas	in.	1/2 (0.0315)	1/2 (0.0315)	1/2 (0.0315)
Connection method	Indoor		Flared	Flared	Flared
	Outdoor		Flared	Flared	Flared
Between the indoor & outdoor units	Height difference	ft.	40	40	40
	Piping length	ft.	65	65	65
Refrigerant charge (R454B)			2lbs. 4oz	2lbs. 4oz	2lbs. 4oz

**NOTE:** Test conditions are based on AHRI 210/240.

\*1: Rating conditions (Cooling) — Indoor: 80°FDB, 67°FWB, Outdoor: 95°FDB, (75°FWB)  
(Heating) — Indoor: 70°FDB, 60°FWB, Outdoor: 47°FDB, 43°FWB

\*2: Rating conditions (Heating) — Indoor: 70°FDB, 60°FWB, Outdoor: 17°FDB, 15°FWB

\*3: Test condition (Refer to page 17.)

\*4: Test condition (Refer to page 17.)

Outdoor unit model			MUZ-GX18NL	MUY-GX18NL	MUZ-GX18NLHZ
Capacity Rated (Minimum – Maximum)	Cooling *1	Btu/h	18,000 (5,200 – 22,000)	18,000 (5,200 – 22,000)	18,000 (5,200 – 22,000)
	Heating 47 *1	Btu/h	21,600 (6,800 – 27,400)	—	19,000 (6,800 – 27,400)
Capacity Rated (Maximum)	Heating 17 *2	Btu/h	13,700 (18,200)	—	12,000 (22,400)
Power consumption Rated (Minimum – Maximum)	Cooling *1	W	1,280 (340 – 2,150)	1,280 (340 – 2,150)	1,280 (340 – 2,150)
	Heating 47 *1	W	1,680 (400 – 4,000)	—	1,340 (410 – 4,000)
Power consumption Rated (Maximum)	Heating 17 *2	W	1,460 (2,900)	—	1,230 (3,240)
EER2 *1 [SEER2] *3	Cooling		14.05 [22.5]	14.05 [22.5]	14.05 [22.5]
HSPF2 Region IV*4	Heating		10.3	—	10.0
COP	Heating *1		3.77	—	4.16
Power factor	Cooling	%	97	97	97
	Heating	%	97	—	98
Power supply	V, phase, Hz		208/230, 1, 60	208/230, 1, 60	208/230, 1, 60
Max. fuse size (time delay)	A		25	25	25
Min. circuit ampacity	A		23	23	23
Fan motor	F.L.A	A	0.76	0.76	0.76
Compressor	Model		SRB172FQHMC/ SRB172FQHMT	SRB172FQHMC/ SRB172FQHMT	SRB172FQHMC/ SRB172FQHMT
	R.L.A	A	13.8	13.8	13.8
	L.R.A	A	17.2	17.2	17.2
	Refrigeration oil	fl oz. (L) (Model)	14.5 (0.43)/(RM68EH)	14.5 (0.43)/(RM68EH)	14.5 (0.43)/(RM68EH)
Refrigerant control			Linear expansion valve	Linear expansion valve	Linear expansion valve
Sound level *1	Cooling	dB(A)	54	54	54
	Heating	dB(A)	55	—	55
Airflow High - Med. - Low	Cooling	CFM	2,202 – 1,934 – 977	2,202 – 1,934 – 977	2,202 – 1,934 – 977
	Heating	CFM	1,934 – 1,934 – 1,281	—	1,934 – 1,934 – 1,281
Fan speed High - Med. - Low	Cooling	rpm	900 – 800 – 450	900 – 800 – 450	900 – 800 – 450
	Heating	rpm	800 – 800 – 560	—	800 – 800 – 560
Defrost method			Reverse cycle	—	Reverse cycle
Dimensions	W	in.	33-1/16	33-1/16	33-1/16
	D	in.	13	13	13
	H	in.	34-5/8	34-5/8	34-5/8
Weight	lb.		116	116	117
External finish			Munsell 3Y 7.8/1.1	Munsell 3Y 7.8/1.1	Munsell 3Y 7.8/1.1
Remote controller			Wireless type	Wireless type	Wireless type
Control voltage (by built-in transformer)	V DC		12 – 24	12 – 24	12 – 24
Refrigerant piping			Not supplied	Not supplied	Not supplied
Refrigerant pipe size (Min. wall thickness)	Liquid	in.	1/4 (0.0315)	1/4 (0.0315)	1/4 (0.0315)
	Gas	in.	1/2 (0.0315)	1/2 (0.0315)	1/2 (0.0315)
Connection method	Indoor		Flared	Flared	Flared
	Outdoor		Flared	Flared	Flared
Between the indoor & outdoor units	Height difference	ft.	50	50	50
	Piping length	ft.	100	100	100
Refrigerant charge (R454B)			3lbs.12oz	3lbs.12oz	3lbs.12oz

**NOTE:** Test conditions are based on AHRI 210/240.

\*1: Rating conditions (Cooling) — Indoor: 80°FDB, 67°F WB, Outdoor: 95°FDB, (75°F WB)

(Heating) — Indoor: 70°FDB, 60°F WB, Outdoor: 47°FDB, 43°F WB

\*2: Rating conditions (Heating) — Indoor: 70°FDB, 60°F WB, Outdoor: 17°FDB, 15°F WB

\*3: Test condition (Refer to page 17.)

\*4: Test condition (Refer to page 17.)



Outdoor unit model			MUZ-GX24NL	MUY-GX24NL	MUZ-GX24NLHZ
Capacity Rated (Minimum – Maximum)	Cooling *1	Btu/h	22,400 (7,400 – 27,000)	22,400 (7,400 – 27,000)	22,400 (7,400 – 27,000)
	Heating 47 *1	Btu/h	27,600 (6,800 – 32,000)	—	21,200 (6,800 – 32,000)
Capacity Rated (Maximum)	Heating 17 *2	Btu/h	19,200 (24,600)	—	14,000 (25,400)
Power consumption Rated (Minimum – Maximum)	Cooling *1	W	1,720 (510 – 2,890)	1,720 (510 – 2,890)	1,720 (510 – 2,890)
	Heating 47 *1	W	2,340 (470 – 4,000)	—	1,500 (470 – 4,000)
Power consumption Rated (Maximum)	Heating 17 *2	W	2,020 (3,110)	—	1,400 (3,500)
EER2 *1 [SEER2] *3	Cooling		13.0 [21.5]	13.0 [21.5]	13.0 [21.5]
HSPF2 Region IV*4	Heating		10.3	—	10.0
COP	Heating *1		3.46	—	4.14
Power factor	Cooling	%	98	98	98
	Heating	%	95	—	97
Power supply	V, phase, Hz		208/230, 1, 60	208/230, 1, 60	208/230, 1, 60
Max. fuse size (time delay)	A		25	25	25
Min. circuit ampacity	A		23	23	23
Fan motor	F.L.A	A	0.76	0.76	0.76
Compressor	Model		SRB172FQHMC/ SRB172FQHMT	SRB172FQHMC/ SRB172FQHMT	SRB172FQHMC/ SRB172FQHMT
	R.L.A	A	13.8	13.8	13.8
	L.R.A	A	17.2	17.2	17.2
	Refrigeration oil	fl oz. (L) (Model)	14.5 (0.43)/(RM68EH)	14.5 (0.43)/(RM68EH)	14.5 (0.43)/(RM68EH)
Refrigerant control			Linear expansion valve	Linear expansion valve	Linear expansion valve
Sound level *1	Cooling	dB(A)	55	55	55
	Heating	dB(A)	55	—	55
Airflow High - Med. - Low	Cooling	CFM	2,202 – 2,015 – 977	2,202 – 2,015 – 977	2,202 – 2,015 – 977
	Heating	CFM	1,934 – 1,934 – 1,281	—	1,934 – 1,934 – 1,281
Fan speed High - Med. - Low	Cooling	rpm	900 – 830 – 450	900 – 830 – 450	900 – 830 – 450
	Heating	rpm	800 – 800 – 560	—	800 – 800 – 560
Defrost method			Reverse cycle	—	Reverse cycle
Dimensions	W	in.	33-1/16	33-1/16	33-1/16
	D	in.	13	13	13
	H	in.	34-5/8	34-5/8	34-5/8
Weight	lb.		116	116	117
External finish			Munsell 3Y 7.8/1.1	Munsell 3Y 7.8/1.1	Munsell 3Y 7.8/1.1
Remote controller			Wireless type	Wireless type	Wireless type
Control voltage (by built-in transformer)	V DC		12 – 24	12 – 24	12 – 24
Refrigerant piping			Not supplied	Not supplied	Not supplied
Refrigerant pipe size (Min. wall thickness)	Liquid	in.	1/4 (0.0315)	1/4 (0.0315)	1/4 (0.0315)
	Gas	in.	5/8 (0.0394)	5/8 (0.0394)	5/8 (0.0394)
Connection method	Indoor		Flared	Flared	Flared
	Outdoor		Flared	Flared	Flared
Between the indoor & outdoor units	Height difference	ft.	50	50	50
	Piping length	ft.	100	100	100
Refrigerant charge (R454B)			3lbs.12oz	3lbs.12oz	3lbs.12oz

**NOTE:** Test conditions are based on AHRI 210/240.

\*1: Rating conditions (Cooling) — Indoor: 80°FDB, 67°F WB, Outdoor: 95°FDB, (75°F WB)  
(Heating) — Indoor: 70°FDB, 60°F WB, Outdoor: 47°FDB, 43°F WB

\*2: Rating conditions (Heating) — Indoor: 70°FDB, 60°F WB, Outdoor: 17°FDB, 15°F WB

\*3: Test condition (Refer to page 17.)

\*4: Test condition (Refer to page 17.)

Outdoor unit model			MUZ-GX30NL	MUY-GX30NL	MUZ-GX36NL	MUY-GX36NL
Capacity Rated (Minimum – Maximum)	Cooling *1	Btu/h	30,600 (10,300 – 30,600)	30,600 (10,300 – 30,600)	33,800 (10,300 – 33,800)	33,800 (10,300 – 33,800)
	Heating 47 *1	Btu/h	32,600 (9,800 – 34,000)	—	35,200 (9,800 – 36,000)	—
Capacity Rated (Maximum)	Heating 17 *2	Btu/h	21,200 (26,000)	—	22,600 (26,400)	—
Power consumption Rated (Minimum – Maximum)	Cooling *1	W	3,380 (650 – 3,380)	3,380 (650 – 3,380)	4,020 (650 – 4,020)	4,020 (650 – 4,020)
	Heating 47 *1	W	3,360 (590 – 4,000)	—	3,840 (590 – 4,000)	—
Power consumption Rated (Maximum)	Heating 17 *2	W	2,500 (3,320)	—	2,770 (3,470)	—
EER2 *1 [SEER2] *3	Cooling		9.05 [19.2]	9.05 [19.2]	8.4 [18.5]	8.4 [18.5]
HSPF2 Region IV*4	Heating		8.9	—	8.5	—
COP	Heating *1		2.84	—	2.69	—
Power factor	Cooling	%	99	99	98	98
	Heating	%	98	—	98	—
Power supply	V, phase, Hz		208/230, 1, 60	208/230, 1, 60	208/230, 1, 60	208/230, 1, 60
Max. fuse size (time delay)	A		25	25	25	25
Min. circuit ampacity	A		23	23	23	23
Fan motor	F.L.A	A	0.76	0.76	0.76	0.76
Compressor	Model		SRB172FQHMC/ SRB172FQHMT	SRB172FQHMC/ SRB172FQHMT	SRB172FQHMC/ SRB172FQHMT	SRB172FQHMC/ SRB172FQHMT
	R.L.A	A	13.9	13.9	13.9	13.9
	L.R.A	A	17.4	17.4	17.4	17.4
	Refrigeration oil	fl oz. (L) (Model)	14.5 (0.43)/ (RM68EH)	14.5 (0.43)/ (RM68EH)	14.5 (0.43)/ (RM68EH)	14.5 (0.43)/ (RM68EH)
Refrigerant control			Linear expansion valve	Linear expansion valve	Linear expansion valve	Linear expansion valve
Sound level *1	Cooling	dB(A)	57	57	57	57
	Heating	dB(A)	57	—	57	—
Airflow High - Med. - Low	Cooling	CFM	2,202 – 2,202 – 977	2,202 – 2,202 – 977	2,202 – 2,202 – 977	2,202 – 2,202 – 977
	Heating	CFM	1,934 – 1,934 – 1,281	—	1,934 – 1,934 – 1,281	—
Fan speed High - Med. - Low	Cooling	rpm	900 – 900 – 450	900 – 900 – 450	900 – 900 – 450	900 – 900 – 450
	Heating	rpm	800 – 800 – 560	—	800 – 800 – 560	—
Defrost method			Reverse cycle	—	Reverse cycle	—
Dimensions	W	in.	33-1/16	33-1/16	33-1/16	33-1/16
	D	in.	13	13	13	13
	H	in.	34-5/8	34-5/8	34-5/8	34-5/8
Weight	lb.		116	116	116	116
External finish			Munsell 3Y 7.8/1.1	Munsell 3Y 7.8/1.1	Munsell 3Y 7.8/1.1	Munsell 3Y 7.8/1.1
Remote controller			Wireless type	Wireless type	Wireless type	Wireless type
Control voltage (by built-in transformer)		V DC	12 – 24	12 – 24	12 – 24	12 – 24
Refrigerant piping			Not supplied	Not supplied	Not supplied	Not supplied
Refrigerant pipe size (Min. wall thickness)	Liquid	in.	1/4 (0.0315)	1/4 (0.0315)	1/4 (0.0315)	1/4 (0.0315)
	Gas	in.	5/8 (0.0394)	5/8 (0.0394)	5/8 (0.0394)	5/8 (0.0394)
Connection method	Indoor		Flared	Flared	Flared	Flared
	Outdoor		Flared	Flared	Flared	Flared
Between the indoor & outdoor units	Height difference	ft.	50	50	50	50
	Piping length	ft.	100	100	100	100
Refrigerant charge (R454B)			3lbs.12oz	3lbs.12oz	3lbs.12oz	3lbs.12oz

**NOTE:** Test conditions are based on AHRI 210/240.

\*1: Rating conditions (Cooling) — Indoor: 80°FDB, 67°FWB, Outdoor: 95°FDB, (75°FWB)  
(Heating) — Indoor: 70°FDB, 60°FWB, Outdoor: 47°FDB, 43°FWB

\*2: Rating conditions (Heating) — Indoor: 70°FDB, 60°FWB, Outdoor: 17°FDB, 15°FWB

\*3: Test condition (Refer to page 17.)

\*4: Test condition (Refer to page 17.)



## Test condition

\*3, \*4

AHRI 210/240	Mode	Test	Indoor air condition (°F)		Outdoor air condition (°F)	
			Dry bulb	Wet bulb	Dry bulb	Wet bulb
	SEER (Cooling)	"A-Full" Cooling Steady State at rated compressor speed	80	67	95	(75)
		"B-Full" Cooling Steady State at rated compressor speed	80	67	82	(65)
		"B-Low" Cooling Steady State at minimum compressor speed	80	67	82	(65)
		"F-Low" Cooling Steady State at minimum compressor speed	80	67	67	(53.5)
		"E-Int" Cooling Steady State at intermediate compressor speed *5	80	67	87	(69)
	HSPF (Heating)	"H1-Nom" Heating Steady State at rated compressor speed	70	60	47	43
		"H3-Full" Heating at rated compressor speed	70	60	17	15
		"H0-Low" Heating Steady State at minimum compressor speed	70	60	62	56.5
		"H1-Low" Heating Steady State at minimum compressor speed	70	60	47	43
		"H2-Int" Heating at intermediate compressor speed *5	70	60	35	33

\*5: At intermediate compressor speed

= ("Rated compressor speed" - "minimum compressor speed") / 3 + "minimum compressor speed".

## OPERATING RANGE

### (1) POWER SUPPLY

	Rated voltage	Guaranteed voltage (V)
Outdoor unit	208/230 V 1 phase 60 Hz	Min. 187    208    230    Max. 253 ----- ----- ----- -----

### (2) OPERATION

Mode	Condition	Intake air temperature (°F)	
		Outdoor	
		DB	WB
Cooling	Standard temperature	95	—
	Maximum temperature	115	—
	Minimum temperature	14	—
	Maximum humidity	—	
Heating	Standard temperature	47	43
	Maximum temperature	75	65
	Minimum temperature	<b>NL: -5</b> <b>NLHZ: -22</b>	<b>NL: -6</b> <b>NLHZ: -23</b>

# 5

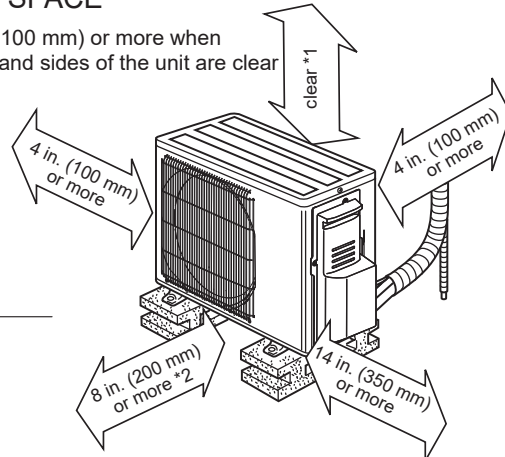
# OUTLINES AND DIMENSIONS

MUZ-GX09NL    MUZ-GX12NL    MUZ-GX15NL  
 MUY-GX09NL    MUY-GX12NL    MUY-GX15NL  
 MUZ-GX09NLHZ    MUZ-GX12NLHZ    MUZ-GX15NLHZ

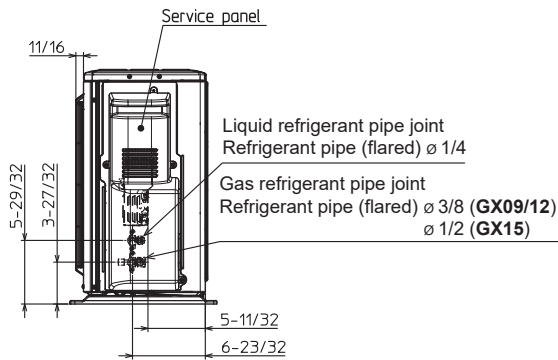
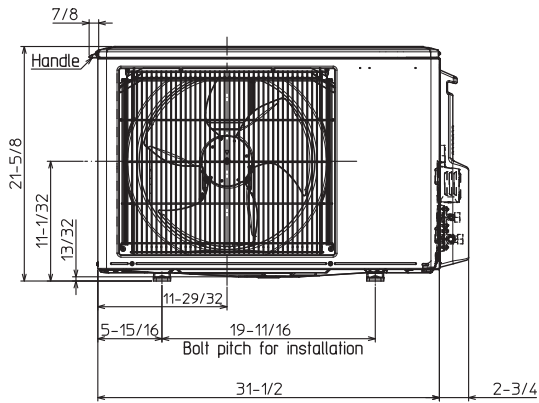
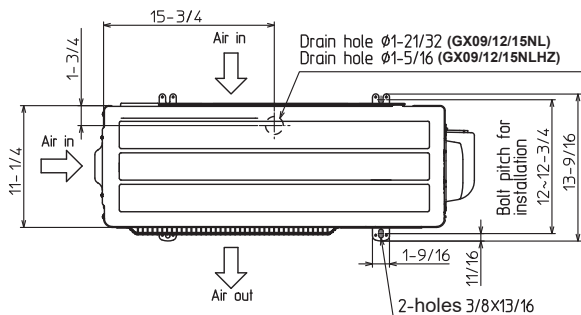
Unit: inch

## REQUIRED SPACE

\*1 4 in. (100 mm) or more when front and sides of the unit are clear



\*2 When any 2 sides of left, right and rear of the unit are clear



MUZ-GX09/12NL    MUZ-GX09/12NLHZ  
 MUY-GX09/12NL

REFRIGERANT PIPE JOINT	LIQUID REFRIGERANT PIPE	FLARED 1/4"
	GAS REFRIGERANT PIPE	FLARED 3/8"

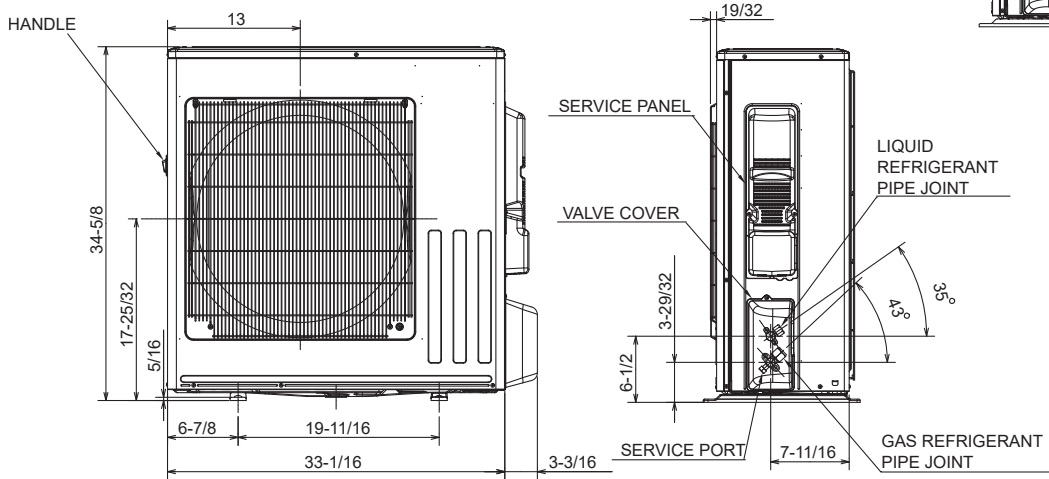
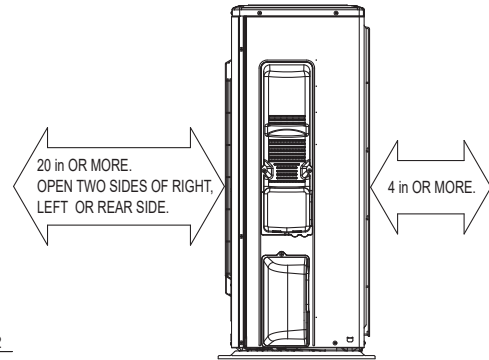
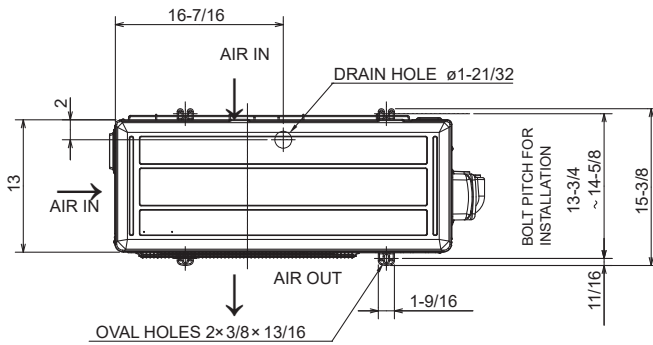
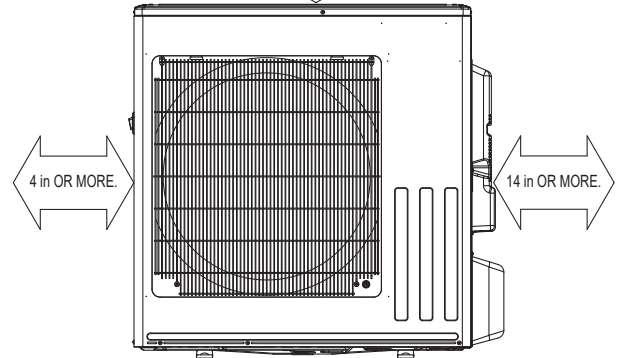
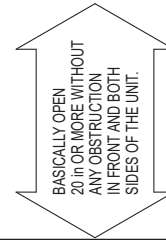
MUZ-GX15NL    MUZ-GX15NLHZ  
 MUY-GX15NL

REFRIGERANT PIPE JOINT	LIQUID REFRIGERANT PIPE	FLARED 1/4"
	GAS REFRIGERANT PIPE	FLARED 1/2"

MUZ-GX18NL    MUZ-GX24NL    MUZ-GX30NL    MUZ-GX36NL  
 MUY-GX18NL    MUY-GX24NL    MUY-GX30NL    MUY-GX36NL  
 MUZ-GX18NLHZ    MUZ-GX24NLHZ

Unit: inch

REQUIRED SPACE



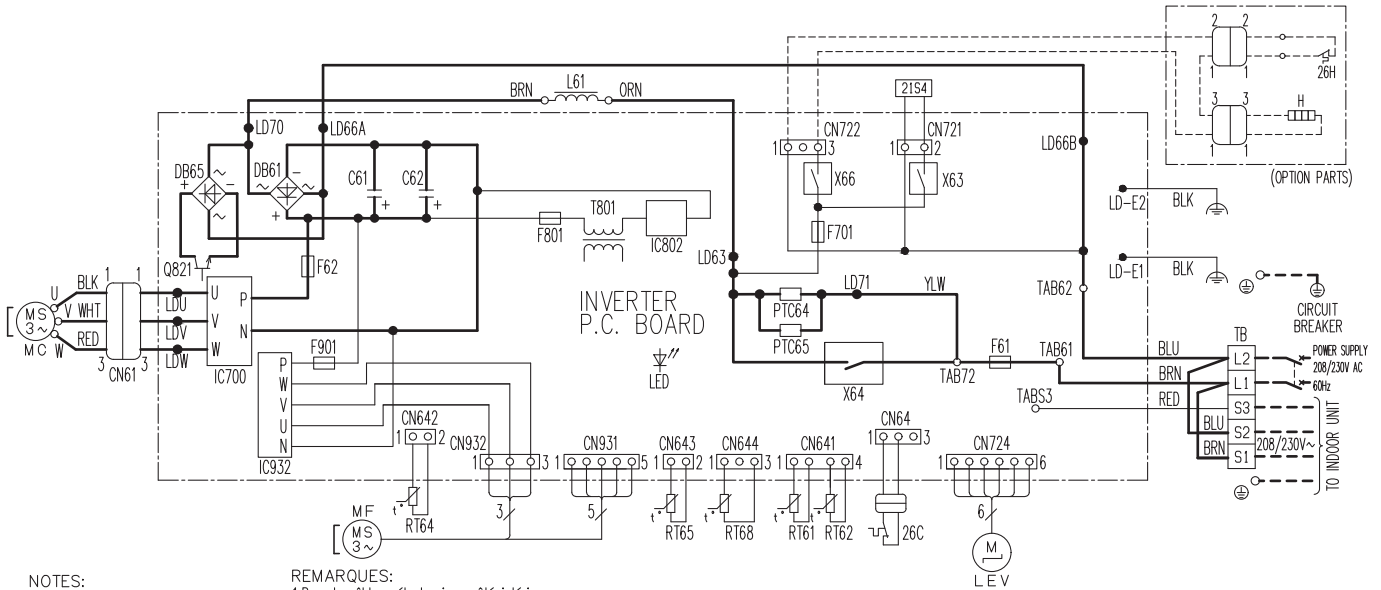
MUZ-GX18NL MUZ-GX18NLHZ  
 MUY-GX18NL

REFRIGERANT PIPE JOINT	LIQUID REFRIGERANT PIPE	FLARED 1/4"
	GAS REFRIGERANT PIPE	FLARED 1/2"

MUZ-GX24/30/36NL MUZ-GX24NLHZ  
 MUY-GX24/30/36NL

REFRIGERANT PIPE JOINT	LIQUID REFRIGERANT PIPE	FLARED 1/4"
	GAS REFRIGERANT PIPE	FLARED 5/8"

MUZ-GX09NL MUZ-GX12NL MUZ-GX15NL

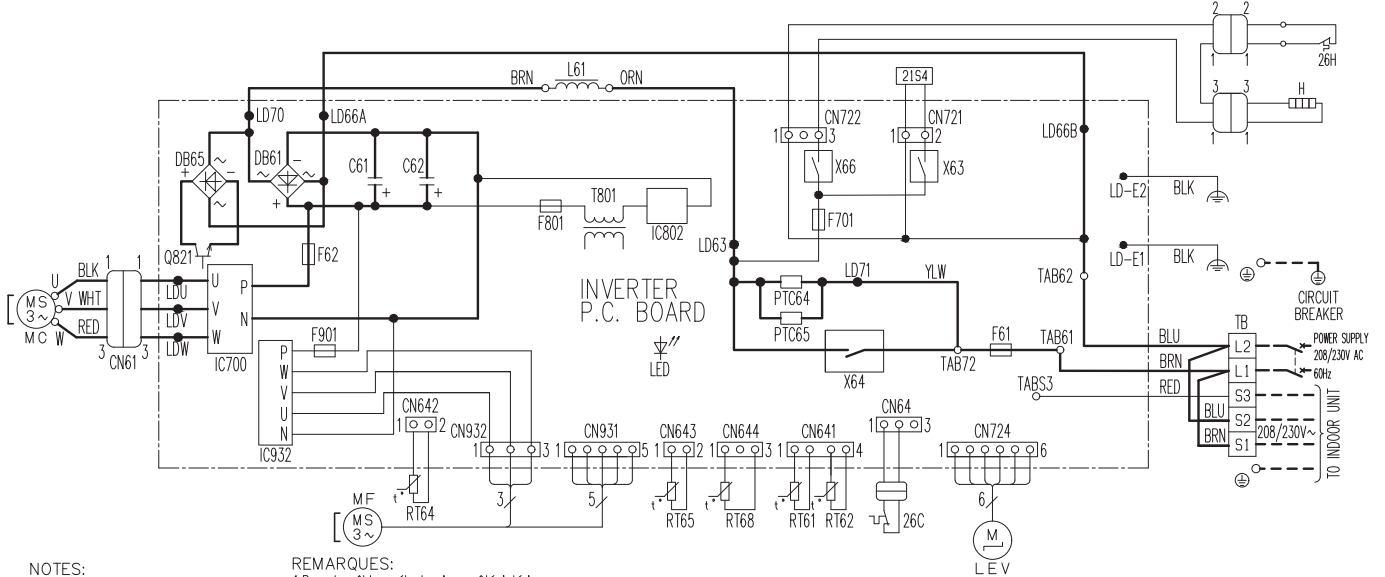


NOTES:  
 1.About the indoor side electric wiring, refer to the indoor unit electric wiring diagram for servicing.  
 2.Use copper supply wires.  
 3.Symbols indicate, :Terminal block :Connector

REMARQUES:  
 1.Pour le câblage électronique côté intérieur, se reporter au schéma d'entretien du câblage électronique de l'appareil intérieur.  
 2.Utiliser des fils d'alimentation en cuivre.  
 3.Les symboles ont les significations suivantes, :Borne :Connecteur

SYMBOL	NAME	SYMBOL	NAME	SYMBOL	NAME
CN61	CONNECTOR	LEV	EXPANSION VALVE COIL	RT68	OUTDOOR HEAT EXCHANGER TEMP. THERMISTOR
C61,C62	SMOOTHING CAPACITOR	L61	REACTOR	TB	TERMINAL BLOCK
DB61,DB65	DIODE MODULE	MC	COMPRESSOR	T801	TRANSFORMER
F61	FUSE (25A 250V)	MF	FAN MOTOR	X63,X64,X66	RELAY
F62	FUSE (15A 250V)	PTC64,PTC65	CIRCUIT PROTECTION	21S4	REVERSING VALVE COIL
F701,F801,F901	FUSE (T3, 15A/250V)	Q821	SWITCHING POWER TRANSISTOR	26C	COMPRESSOR PROTECTOR
H	DEFROST HEATER(OPTION PARTS)	RT61	DEFROST THERMISTOR	26H	HEATER PROTECTOR(OPTION PARTS)
IC700,IC932	POWER MODULE	RT62	DISCHARGE TEMP. THERMISTOR		
IC802	POWER DEVICE	RT64	FIN TEMP. THERMISTOR		
LED	LED	RT65	AMBIENT TEMP. THERMISTOR		

# MUZ-GX09NLHZ MUZ-GX12NLHZ MUZ-GX15NLHZ

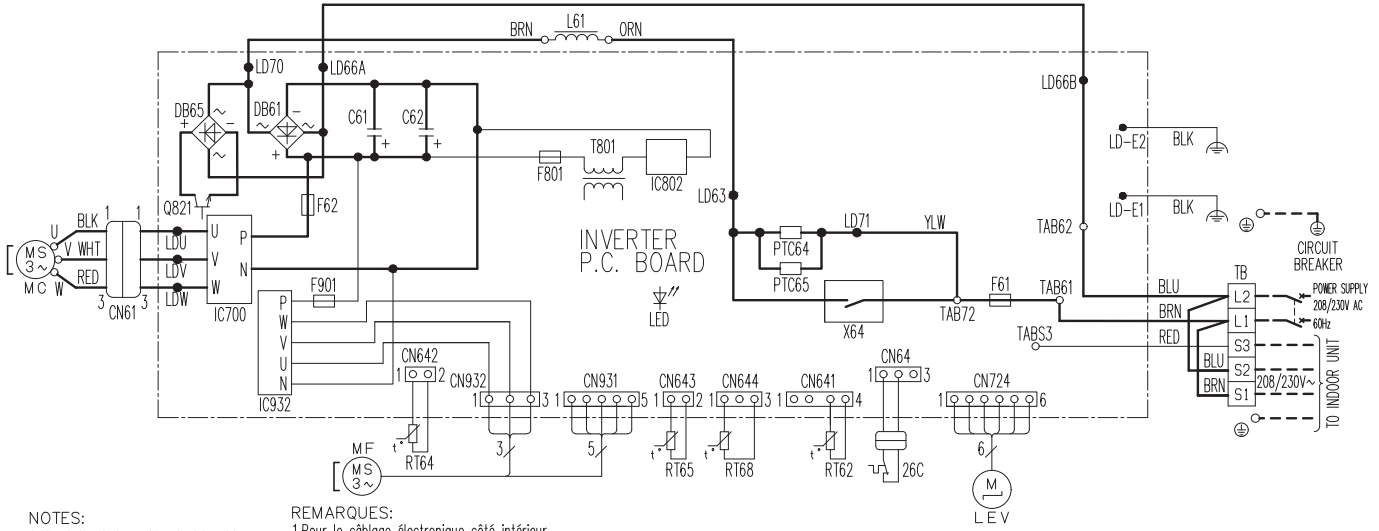


NOTES:  
 1.About the indoor side electric wiring, refer to the indoor unit electric wiring diagram for servicing.  
 2.Use copper supply wires.  
 3.Symbols indicate, □: Terminal block, ○: Connector

REMARQUES:  
 1.Pour le câblage électronique côté intérieur, se reporter au schéma d'entretien du câblage électronique de l'appareil intérieur.  
 2.Utiliser des fils d'alimentation en cuivre.  
 3.Les symboles ont les significations suivantes, □: Borne, ○: Connecteur

SYMBOL	NAME	SYMBOL	NAME	SYMBOL	NAME
CN61	CONNECTOR	LEV	EXPANSION VALVE COIL	RT68	OUTDOOR HEAT EXCHANGER TEMP. THERMISTOR
C61,C62	SMOOTHING CAPACITOR	L61	REACTOR		
DB61,DB65	DIODE MODULE	MC	COMPRESSOR	TB	TERMINAL BLOCK
F61	FUSE (25A 250V)	MF	FAN MOTOR	T801	TRANSFORMER
F62	FUSE (15A 250V)	PTC64,PTC65	CIRCUIT PROTECTION	X63,X64,X66	RELAY
F701,F801,F901	FUSE (T3, 15AL250V)	Q821	SWITCHING POWER TRANSISTOR	21S4	REVERSING VALVE COIL
H	DEFROST HEATER	RT61	DEFROST THERMISTOR	26C	COMPRESSOR PROTECTOR
IC700,IC932	POWER MODULE	RT62	DISCHARGE TEMP. THERMISTOR	26H	HEATER PROTECTOR
IC802	POWER DEVICE	RT64	FIN TEMP. THERMISTOR		
LED	LED	RT65	AMBIENT TEMP. THERMISTOR		

**MUY-GX09NL MUY-GX12NL MUY-GX15NL**



**NOTES:**  
 1. About the indoor side electric wiring, refer to the indoor unit electric wiring diagram for servicing.  
 2. Use copper supply wires.  
 3. Symbols indicate, □: Terminal block ○: Connector

**REMARQUES:**  
 1. Pour le câblage électronique côté intérieur, se reporter au schéma d'entretien du câblage électronique de l'appareil intérieur.  
 2. Utiliser des fils d'alimentation en cuivre.  
 3. Les symboles ont les significations suivantes, □: Borne ○: Connecteur

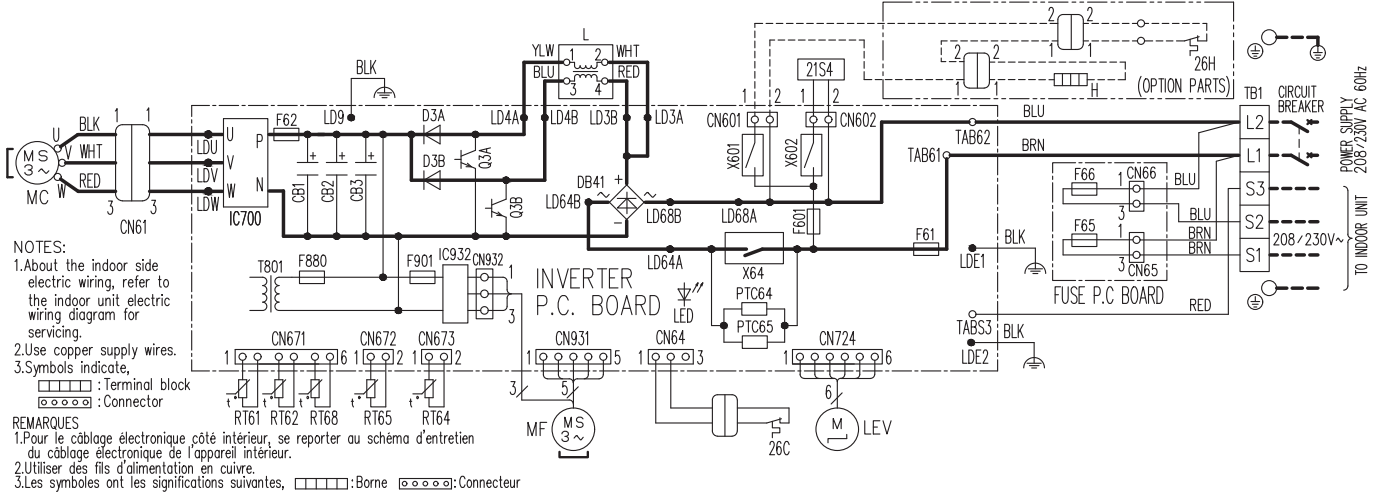
SYMBOL	NAME	SYMBOL	NAME	SYMBOL	NAME
CN61	CONNECTOR	L61	REACTOR	TB	TERMINAL BLOCK
C61,C62	SMOOTHING CAPACITOR	MC	COMPRESSOR	T801	TRANSFORMER
DB61,DB65	DIODE MODULE	MF	FAN MOTOR	X64	RELAY
F61	FUSE (25A 250V)	PTC64,PTC65	CIRCUIT PROTECTION	26C	COMPRESSOR PROTECTOR
F62	FUSE (15A 250V)	Q821	SWITCHING POWER TRANSISTOR		
F801,F901	FUSE (T3, 15A 250V)	RT62	DISCHARGE TEMP. THERMISTOR		
IC700,IC932	POWER MODULE	RT64	FIN TEMP. THERMISTOR		
IC802	POWER DEVICE	RT65	AMBIENT TEMP. THERMISTOR		
LED	LED	RT68	OUTDOOR HEAT EXCHANGER TEMP. THERMISTOR		
LEV	EXPANSION VALVE COIL				

**MUZ-GX18NL**

**MUZ-GX24NL**

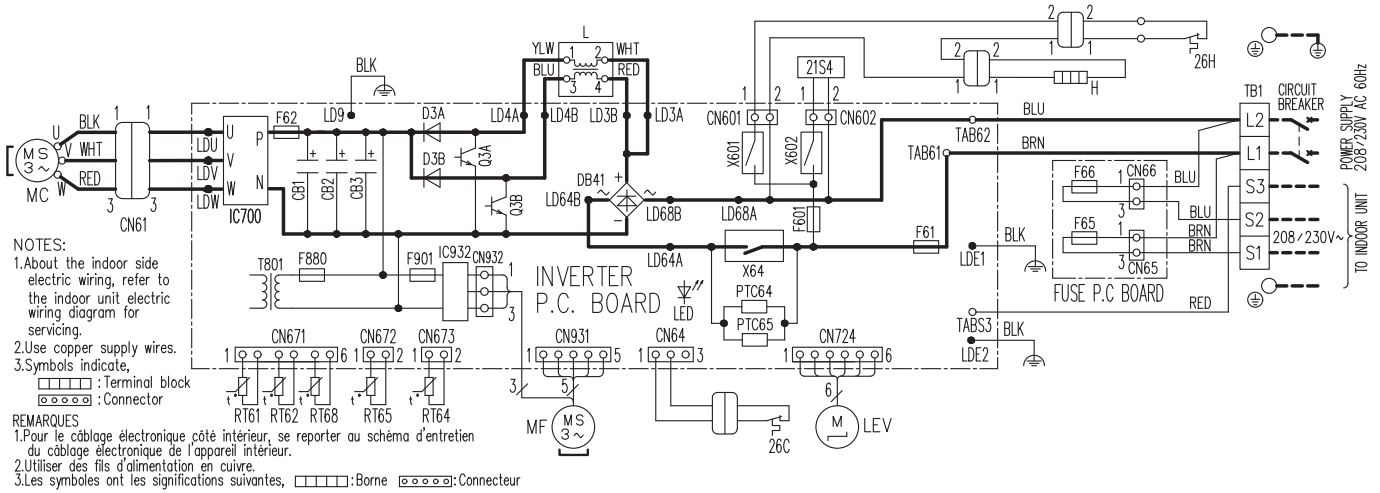
**MUZ-GX30NL**

**MUZ-GX36NL**



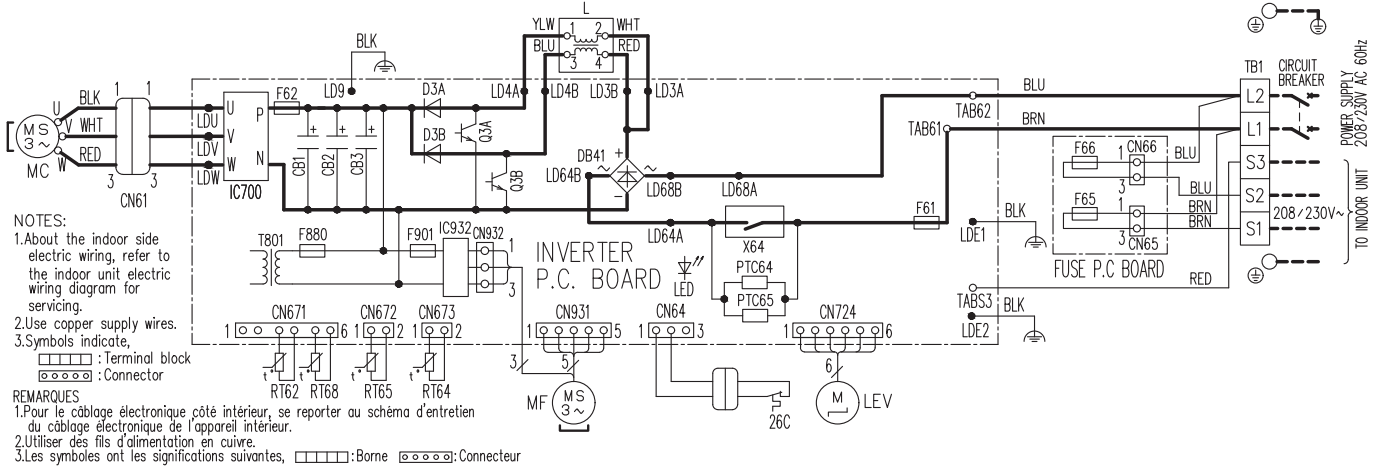
SYMBOL	NAME	SYMBOL	NAME	SYMBOL	NAME
CB1, CB2, CB3	SMOOTHING CAPACITOR	L	REACTOR	RT65	AMBIENT TEMP. THERMISTOR
CN61	CONNECTOR	LED	LED	RT68	OUTDOOR HEAT EXCHANGER TEMP. THERMISTOR
DB41	DIODE MODULE	LEV	EXPANSION VALVE COIL	TB1	TERMINAL BLOCK
D3A, D3B	DIODE	MC	COMPRESSOR	T801	TRANSFORMER
F61	FUSE (25A 250V)	MF	FAN MOTOR	X64, X601, X602	RELAY
F62	FUSE (15A 250V)	PTC64, PTC65	CIRCUIT PROTECTION	21S4	REVERSING VALVE COIL
F65, F66	FUSE (T6.3AL250V)	Q3A, Q3B	SWITCHING POWER TRANSISTOR	26C	COMPRESSOR PROTECTOR
F601, F880, F901	FUSE (T3.15AL250V)	RT61	DEFROST TEMP. THERMISTOR	26H	HEATER PROTECTOR (OPTION PARTS)
H	DEFROST HEATER (OPTION PARTS)	RT62	DISCHARGE TEMP. THERMISTOR		
IC700, IC932	POWER MODULE	RT64	FIN TEMP. THERMISTOR		

**MUZ-GX18NLHZ MUZ-GX24NLHZ**



SYMBOL	NAME	SYMBOL	NAME	SYMBOL	NAME
CB1, CB2, CB3	SMOOTHING CAPACITOR	L	REACTOR	RT65	AMBIENT TEMP. THERMISTOR
CN61	CONNECTOR	LED	LED	RT68	OUTDOOR HEAT EXCHANGER TEMP. THERMISTOR
DB41	DIODE MODULE	LEV	EXPANSION VALVE COIL	TB1	TERMINAL BLOCK
D3A, D3B	DIODE	MC	COMPRESSOR	T801	TRANSFORMER
F61	FUSE (25A 250V)	MF	FAN MOTOR	X64, X601, X602	RELAY
F62	FUSE (15A 250V)	PTC64, PTC65	CIRCUIT PROTECTION	21S4	REVERSING VALVE COIL
F65, F66	FUSE (T6.3AL250V)	Q3A, Q3B	SWITCHING POWER TRANSISTOR	26C	COMPRESSOR PROTECTOR
F601, F880, F901	FUSE (T3.15AL250V)	RT61	DEFROST TEMP. THERMISTOR	26H	HEATER PROTECTOR
H	DEFROST HEATER	RT62	DISCHARGE TEMP. THERMISTOR		
IC700, IC932	POWER MODULE	RT64	FIN TEMP. THERMISTOR		

MUY-GX18NL MUY-GX24NL MUY-GX30NL MUY-GX36NL



SYMBOL	NAME	SYMBOL	NAME	SYMBOL	NAME
CB1, CB2, CB3	SMOOTHING CAPACITOR	L	REACTOR	RT65	AMBIENT TEMP. THERMISTOR
CN61	CONNECTOR	LED	LED	RT68	OUTDOOR HEAT EXCHANGER TEMP. THERMISTOR
DB41	DIODE MODULE	LEV	EXPANSION VALVE COIL	TB1	TERMINAL BLOCK
D3A, D3B	DIODE	MC	COMPRESSOR	T801	TRANSFORMER
F61	FUSE (25A 250V)	MF	FAN MOTOR	X64	RELAY
F62	FUSE (15A 250V)	PTC64, PTC65	CIRCUIT PROTECTION	26C	COMPRESSOR PROTECTOR
F65, F66	FUSE (T6.3AL250V)	Q3A, Q3B	SWITCHING POWER TRANSISTOR		
F880, F901	FUSE (T3.15AL250V)	RT62	DISCHARGE TEMP. THERMISTOR		
IC700, IC932	POWER MODULE	RT64	FIN TEMP. THERMISTOR		

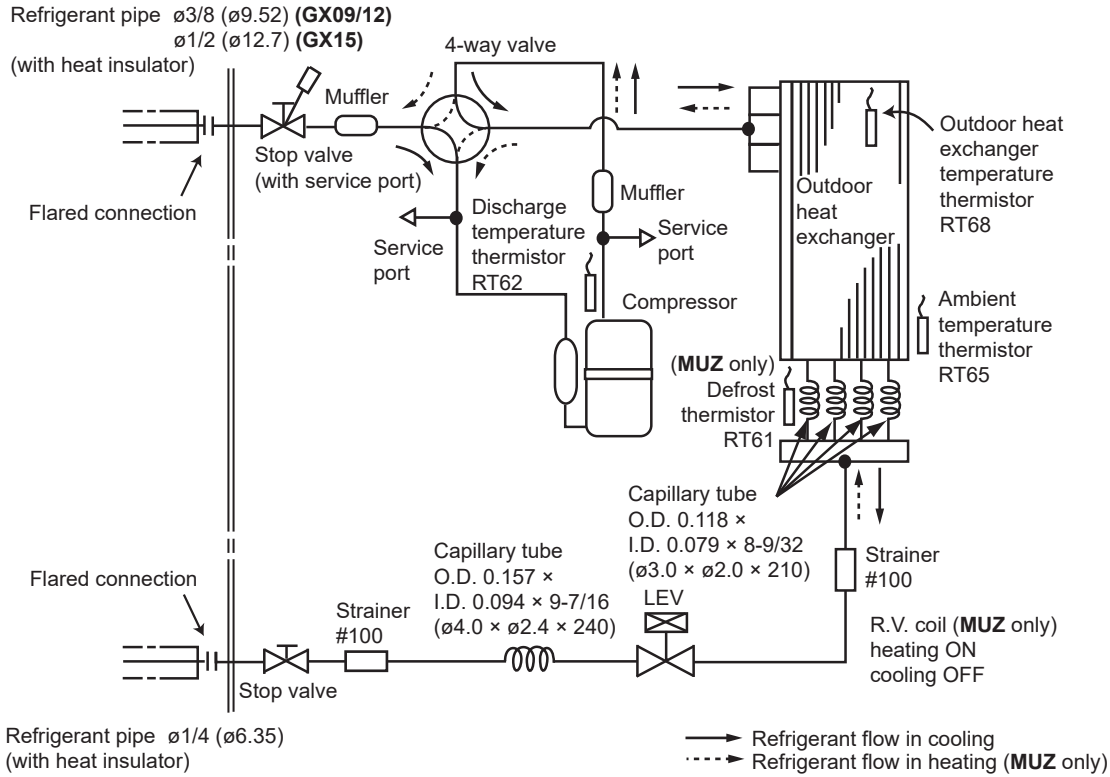


# 7

# REFRIGERANT SYSTEM DIAGRAM

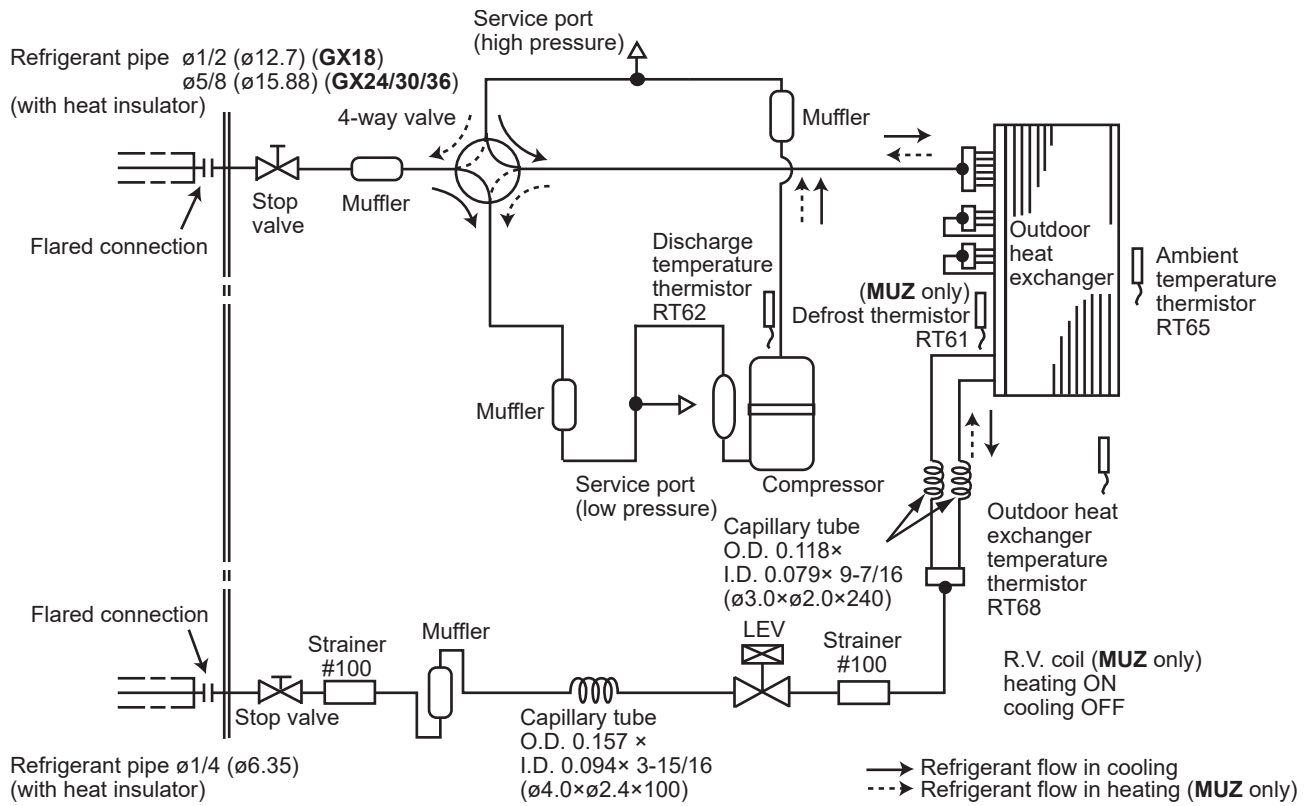
Unit: Inch (mm)

MUZ-GX09NL    MUZ-GX12NL    MUZ-GX15NL  
 MUY-GX09NL    MUY-GX12NL    MUY-GX15NL  
 MUZ-GX09NLHZ    MUZ-GX12NLHZ    MUZ-GX15NLHZ



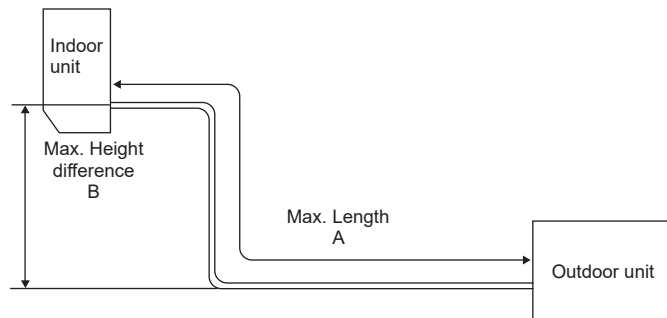
**MUZ-GX18NL**    **MUZ-GX24NL**    **MUZ-GX30NL**    **MUZ-GX36NL**  
**MUY-GX18NL**    **MUY-GX24NL**    **MUY-GX30NL**    **MUY-GX36NL**  
**MUZ-GX18NLHZ**    **MUZ-GX24NLHZ**

Unit: Inch (mm)



## MAX. REFRIGERANT PIPING LENGTH and MAX. HEIGHT DIFFERENCE

Model	Refrigerant piping: ft.		Piping size O.D: in.	
	Max. Length A	Max. Height difference B	Gas	Liquid
MUZ-GX09NL MUZ-GX09NLHZ MUY-GX09NL MUZ-GX12NL MUZ-GX12NLHZ MUY-GX12NL	65	40	3/8	1/4
MUZ-GX15NL MUZ-GX15NLHZ MUY-GX15NL	65	40	1/2	1/4
MUZ-GX18NL MUZ-GX18NLHZ MUY-GX18NL	100	50	1/2	1/4
MUZ-GX24NL MUZ-GX24NLHZ MUY-GX24NL MUZ-GX30NL MUY-GX30NL MUZ-GX36NL MUY-GX36NL	100	50	5/8	1/4



**MUZ-GX09NL    MUZ-GX12NL    MUZ-GX15NL**  
**MUZ-GX18NL    MUZ-GX24NL    MUZ-GX30NL    MUZ-GX36NL**  
**MUY-GX09NL    MUY-GX12NL    MUY-GX15NL**  
**MUY-GX18NL    MUY-GX24NL    MUY-GX30NL    MUY-GX36NL**  
**MUZ-GX09NLHZ    MUZ-GX12NLHZ    MUZ-GX15NLHZ**  
**MUZ-GX18NLHZ    MUZ-GX24NLHZ**

### 8-1. PERFORMANCE DATA

#### 1) COOLING CAPACITY

Model	Indoor air	Outdoor intake air DB temperature (°F)											
	IWB (°F)	75				85				95			
		TC	SHC	SHF	TPC	TC	SHC	SHF	TPC	TC	SHC	SHF	TPC
<b>MUZ-GX09NL</b> <b>MUZ-GX09NLHZ</b> <b>MUY-GX09NL</b>	71	11.0	8.5	0.77	0.52	10.3	7.9	0.77	0.57	9.7	7.4	0.77	0.61
	67	10.4	9.4	0.90	0.49	9.7	8.7	0.90	0.54	9.0	8.1	0.90	0.59
	63	9.8	10.1	1.03	0.47	9.1	9.4	1.03	0.52	8.5	8.7	1.03	0.56
<b>MUZ-GX12NL</b> <b>MUY-GX12NL</b>	71	14.7	9.4	0.64	0.80	13.7	8.7	0.64	0.88	12.9	8.2	0.64	0.95
	67	13.9	10.7	0.77	0.76	13.0	10.0	0.77	0.83	12.0	9.2	0.77	0.90
	63	13.1	11.8	0.90	0.72	12.1	10.9	0.90	0.80	11.3	10.2	0.90	0.86
<b>MUZ-GX12NLHZ</b>	71	14.7	9.5	0.65	0.80	13.7	8.9	0.65	0.88	12.9	8.3	0.65	0.95
	67	13.9	10.9	0.78	0.76	13.0	10.1	0.78	0.83	12.0	9.4	0.78	0.90
	63	13.1	11.9	0.91	0.72	12.1	11.1	0.91	0.80	11.3	10.3	0.91	0.86
<b>MUZ-GX15NL</b> <b>MUZ-GX15NLHZ</b> <b>MUY-GX15NL</b>	71	17.2	11.8	0.69	0.96	16.0	11.0	0.69	1.05	15.1	10.3	0.69	1.13
	67	16.2	13.3	0.82	0.90	15.1	12.4	0.82	0.99	14.0	11.5	0.82	1.08
	63	15.3	14.5	0.95	0.86	14.1	13.5	0.95	0.95	13.2	12.5	0.95	1.03
<b>MUZ-GX18NL</b> <b>MUZ-GX18NLHZ</b> <b>MUY-GX18NL</b>	71	22.1	14.5	0.66	1.14	20.6	13.5	0.66	1.25	19.4	12.7	0.66	1.34
	67	20.9	16.5	0.79	1.08	19.4	15.4	0.79	1.18	18.0	14.2	0.79	1.28
	63	19.6	18.1	0.92	1.02	18.2	16.8	0.92	1.13	16.9	15.6	0.92	1.22
<b>MUZ-GX24NL</b> <b>MUZ-GX24NLHZ</b> <b>MUY-GX24NL</b>	71	27.4	17.7	0.65	1.53	25.6	16.6	0.65	1.68	24.1	15.6	0.65	1.81
	67	26.0	20.3	0.78	1.44	24.2	18.9	0.78	1.59	22.4	17.5	0.78	1.72
	63	24.4	22.3	0.91	1.38	22.6	20.7	0.91	1.52	21.1	19.2	0.91	1.64
<b>MUZ-GX30NL</b> <b>MUY-GX30NL</b>	71	37.5	21.2	0.57	3.01	35.0	19.9	0.57	3.30	32.9	18.6	0.57	3.55
	67	35.5	24.8	0.70	2.84	33.0	23.1	0.70	3.13	30.6	21.4	0.70	3.38
	63	33.4	27.8	0.83	2.70	30.9	25.8	0.83	2.99	28.8	24.0	0.83	3.23
<b>MUZ-GX36NL</b> <b>MUY-GX36NL</b>	71	41.4	22.6	0.55	3.58	38.7	21.2	0.55	3.92	36.3	19.9	0.55	4.22
	67	39.2	26.7	0.68	3.38	36.5	24.8	0.68	3.72	33.8	23.0	0.68	4.02
	63	36.8	30.0	0.81	3.22	34.1	27.8	0.81	3.56	31.8	25.8	0.81	3.84

**NOTE:** 1. IWB : Intake air wet-bulb temperature      TC : Total Capacity ( $\times 10^3$  Btu/h)  
           SHC : Sensible Heat Capacity ( $\times 10^3$  Btu/h)    SHF : Sensible Heat Factor  
           TPC : Total Power Consumption (kW)  
 2. SHC is based on 80°F of indoor Intake air DB temperature.

Model	Indoor air IWB (°F)	Outdoor intake air DB temperature (°F)							
		105				115			
		TC	SHC	SHF	TPC	TC	SHC	SHF	TPC
<b>MUZ-GX09NL</b> <b>MUZ-GX09NLHZ</b> <b>MUY-GX09NL</b>	71	9.0	6.9	0.77	0.65	8.3	6.3	0.77	0.67
	67	8.4	7.5	0.90	0.62	7.7	6.9	0.90	0.65
	63	7.7	8.0	1.03	0.60	7.0	7.3	1.03	0.62
<b>MUZ-GX12NL</b> <b>MUY-GX12NL</b>	71	12.0	7.6	0.64	0.99	11.0	7.0	0.64	1.04
	67	11.2	8.6	0.77	0.95	10.3	7.9	0.77	1.00
	63	10.3	9.3	0.90	0.92	9.4	8.5	0.90	0.95
<b>MUZ-GX12NLHZ</b>	71	12.0	7.8	0.65	0.99	11.0	7.1	0.65	1.04
	67	11.2	8.7	0.78	0.95	10.3	8.0	0.78	1.00
	63	10.3	9.4	0.91	0.92	9.4	8.5	0.91	0.95
<b>MUZ-GX15NL</b> <b>MUZ-GX15NLHZ</b> <b>MUY-GX15NL</b>	71	14.0	9.6	0.69	1.19	12.9	8.8	0.69	1.24
	67	13.0	10.7	0.82	1.14	12.0	9.8	0.82	1.19
	63	12.0	11.4	0.95	1.10	10.9	10.4	0.95	1.14
<b>MUZ-GX18NL</b> <b>MUZ-GX18NLHZ</b> <b>MUY-GX18NL</b>	71	18.0	11.8	0.66	1.41	16.6	10.9	0.66	1.47
	67	16.7	13.2	0.79	1.36	15.4	12.2	0.79	1.42
	63	15.4	14.2	0.92	1.31	14.0	13.0	0.92	1.36
<b>MUZ-GX24NL</b> <b>MUZ-GX24NLHZ</b> <b>MUY-GX24NL</b>	71	22.4	14.5	0.65	1.90	20.6	13.3	0.65	1.98
	67	20.8	16.2	0.78	1.82	19.2	14.9	0.78	1.91
	63	19.2	17.5	0.91	1.75	17.5	16.0	0.91	1.82
<b>MUZ-GX30NL</b> <b>MUY-GX30NL</b>	71	30.6	17.3	0.57	3.73	28.2	16.0	0.57	3.89
	67	28.5	19.9	0.70	3.58	26.2	18.3	0.70	3.75
	63	26.2	21.8	0.83	3.45	23.9	19.9	0.83	3.58
<b>MUZ-GX36NL</b> <b>MUY-GX36NL</b>	71	33.8	18.5	0.55	4.44	31.1	17.0	0.55	4.62
	67	31.4	21.4	0.68	4.26	28.9	19.7	0.68	4.46
	63	28.9	23.5	0.81	4.10	26.4	21.4	0.81	4.26

**NOTE:** 1. IWB : Intake air wet-bulb temperature      TC : Total Capacity ( $\times 10^3$  Btu/h)  
 SHC : Sensible Heat Capacity ( $\times 10^3$  Btu/h)      SHF : Sensible Heat Factor  
 TPC : Total Power Consumption (kW)  
 2. SHC is based on 80°F of indoor Intake air DB temperature.

## 2) COOLING CAPACITY CORRECTIONS

Model	Refrigerant piping length (one way: ft.)			
	25 (std.)	40	65	100
MUZ-GX09NL MUZ-GX09NLHZ MUY-GX09NL	1.0	0.993	0.981	—
MUZ-GX12NL MUZ-GX12NLHZ MUY-GX12NL	1.0	0.987	0.967	—
MUZ-GX15NL MUZ-GX15NLHZ MUY-GX15NL	1.0	0.996	0.988	—
MUZ-GX18NL MUZ-GX18NLHZ MUY-GX18NL	1.0	0.994	0.983	0.969
MUZ-GX24NL MUZ-GX24NLHZ MUY-GX24NL	1.0	0.996	0.990	0.982
MUZ-GX30NL MUY-GX30NL	1.0	0.992	0.979	0.962
MUZ-GX36NL MUY-GX36NL	1.0	0.991	0.975	0.954

## 3) HEATING CAPACITY CORRECTIONS

Model	Refrigerant piping length (one way: ft.)			
	25 (std.)	40	65	100
MUZ-GX09NL MUZ-GX09NLHZ MUZ-GX12NL MUZ-GX12NLHZ MUZ-GX15NL MUZ-GX15NLHZ	1.0	0.997	0.993	—
MUZ-GX18NL MUZ-GX18NLHZ MUZ-GX24NL MUZ-GX24NLHZ MUZ-GX30NL MUZ-GX36NL	1.0	0.997	0.993	0.987

NOTE: 1. IDB : Intake air dry-bulb temperature

TC : Total Capacity ( $\times 10^3$  Btu/h)      TPC : Total Power Consumption (kW)

2. Above data is for heating operation without any frost.

#### 4) HEATING CAPACITY

Model	Indoor air IDB (°F)	Outdoor intake air WB temperature (°F)													
		5		15		25		35		43		45		55	
		TC	TPC	TC	TPC	TC	TPC	TC	TPC	TC	TPC	TC	TPC	TC	TPC
MUZ-GX09NL	75	4.8	0.42	6.3	0.54	7.9	0.63	9.4	0.70	10.6	0.74	11.0	0.75	12.4	0.78
	70	5.2	0.41	6.7	0.52	8.2	0.62	9.6	0.68	10.9	0.72	11.2	0.73	12.7	0.76
	65	5.5	0.39	6.9	0.50	8.6	0.59	10.0	0.67	11.2	0.70	11.6	0.71	13.0	0.75
MUZ-GX09NLHZ	75	4.2	0.40	5.6	0.49	7.0	0.57	8.3	0.57	9.4	0.59	9.6	0.60	10.9	0.63
	70	4.6	0.39	5.9	0.48	7.2	0.56	8.5	0.55	9.6	0.58	9.9	0.59	11.2	0.61
	65	4.8	0.37	6.0	0.46	7.5	0.54	8.8	0.54	9.9	0.57	10.2	0.57	11.4	0.60
MUZ-GX12NL	75	6.3	0.65	8.4	0.82	10.4	0.96	12.5	1.07	14.0	1.13	14.5	1.14	16.4	1.19
	70	6.8	0.62	8.9	0.79	10.8	0.94	12.7	1.05	14.4	1.10	14.8	1.12	16.8	1.17
	65	7.2	0.59	9.1	0.76	11.3	0.91	13.2	1.02	14.8	1.07	15.3	1.09	17.1	1.14
MUZ-GX12NLHZ	75	5.4	0.60	7.1	0.75	8.9	0.87	10.6	0.90	12.0	0.94	12.4	0.96	14.0	0.99
	70	5.8	0.58	7.6	0.72	9.2	0.85	10.9	0.87	12.3	0.92	12.7	0.94	14.3	0.98
	65	6.2	0.56	7.7	0.69	9.7	0.82	11.3	0.85	12.7	0.90	13.0	0.91	14.6	0.96
MUZ-GX15NL	75	7.9	0.94	10.4	1.19	13.1	1.40	15.6	1.56	17.6	1.64	18.1	1.66	20.5	1.73
	70	8.6	0.90	11.1	1.15	13.5	1.37	15.9	1.52	18.0	1.60	18.5	1.63	21.0	1.70
	65	9.0	0.86	11.3	1.10	14.1	1.32	16.5	1.48	18.5	1.56	19.1	1.58	21.4	1.66
MUZ-GX15NLHZ	75	6.2	0.71	8.1	0.88	10.2	1.02	12.1	1.07	13.7	1.13	14.1	1.14	16.0	1.19
	70	6.7	0.68	8.6	0.85	10.5	1.00	12.4	1.05	14.0	1.10	14.4	1.12	16.3	1.17
	65	7.0	0.65	8.8	0.82	11.0	0.97	12.8	1.02	14.4	1.07	14.8	1.09	16.7	1.14
MUZ-GX18NL	75	9.5	0.99	12.5	1.25	15.7	1.47	18.7	1.64	21.1	1.72	21.7	1.75	24.6	1.81
	70	10.3	0.95	13.3	1.21	16.2	1.44	19.1	1.60	21.6	1.68	22.2	1.71	25.2	1.78
	65	10.8	0.91	13.6	1.16	17.0	1.39	19.8	1.55	22.2	1.64	22.9	1.66	25.7	1.75
MUZ-GX18NLHZ	75	8.4	0.91	11.0	1.12	13.8	1.29	16.4	1.31	18.5	1.37	19.1	1.39	21.7	1.45
	70	9.0	0.88	11.7	1.08	14.3	1.27	16.8	1.27	19.0	1.34	19.6	1.37	22.1	1.42
	65	9.5	0.84	12.0	1.04	14.9	1.23	17.4	1.24	19.6	1.31	20.1	1.33	22.6	1.39
MUZ-GX24NL	75	12.1	1.38	16.0	1.74	20.0	2.05	23.9	2.28	26.9	2.40	27.7	2.43	31.5	2.53
	70	13.1	1.32	17.0	1.68	20.7	2.00	24.4	2.22	27.6	2.34	28.4	2.39	32.2	2.48
	65	13.8	1.26	17.4	1.61	21.7	1.93	25.3	2.16	28.4	2.28	29.3	2.32	32.8	2.43
MUZ-GX24NLHZ	75	9.3	1.01	12.3	1.24	15.4	1.43	18.3	1.46	20.7	1.54	21.3	1.56	24.2	1.62
	70	10.1	0.97	13.0	1.20	15.9	1.40	18.8	1.43	21.2	1.50	21.8	1.53	24.7	1.59
	65	10.6	0.93	13.4	1.16	16.6	1.36	19.4	1.39	21.8	1.46	22.5	1.49	25.2	1.56
MUZ-GX30NL	75	14.3	1.98	18.9	2.50	23.6	2.94	28.2	3.28	31.8	3.44	32.8	3.49	37.2	3.63
	70	15.5	1.90	20.0	2.42	24.5	2.87	28.9	3.19	32.6	3.36	33.6	3.43	38.0	3.56
	65	16.3	1.81	20.5	2.32	25.6	2.77	29.8	3.11	33.6	3.28	34.6	3.33	38.8	3.49
MUZ-GX36NL	75	15.5	2.27	20.4	2.86	25.5	3.36	30.4	3.74	34.3	3.94	35.4	3.99	40.1	4.15
	70	16.7	2.17	21.6	2.76	26.4	3.28	31.2	3.65	35.2	3.84	36.3	3.92	41.0	4.07
	65	17.6	2.07	22.2	2.65	27.6	3.17	32.2	3.55	36.3	3.74	37.3	3.80	41.9	3.99

NOTE: 1. IDB : Intake air dry-bulb temperature

TC : Total Capacity ( $\times 10^3$  Btu/h)      TPC : Total Power Consumption (kW)

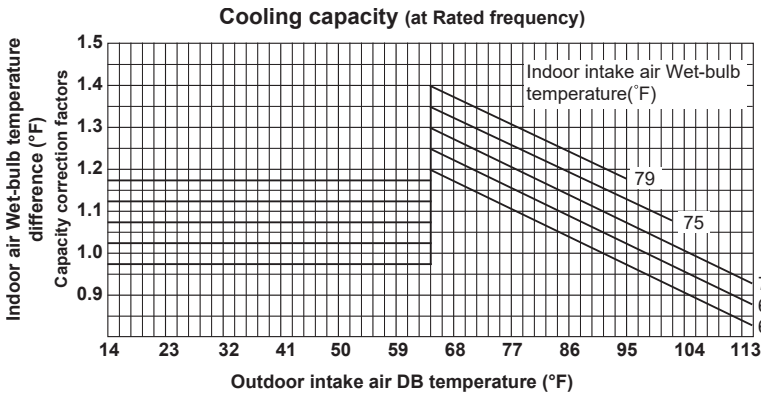
2. Above data is for heating operation without any frost.

How to operate with fixed operational frequency of the compressor.

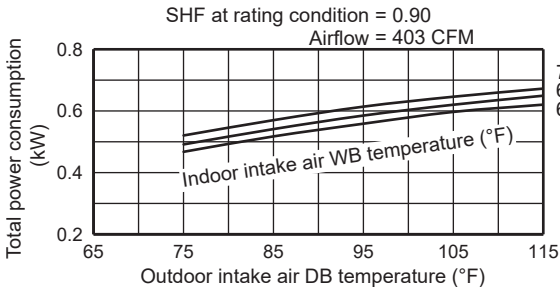
1. Press the emergency operation switch on the front of the indoor unit, and select either EMERGENCY COOL mode or EMERGENCY HEAT mode before starting to operate the air conditioner.
2. The compressor starts with operational frequency.
3. The fan speed of the indoor unit is High.
4. This operation continues for 30 minutes.
5. In order to release this operation, press the emergency operation switch twice or once, or press any button on the remote controller.

## 8-2. PERFORMANCE CURVE

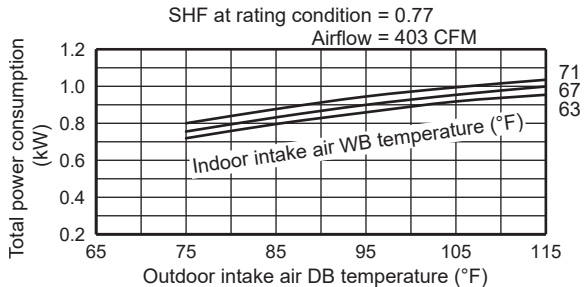
### Cooling



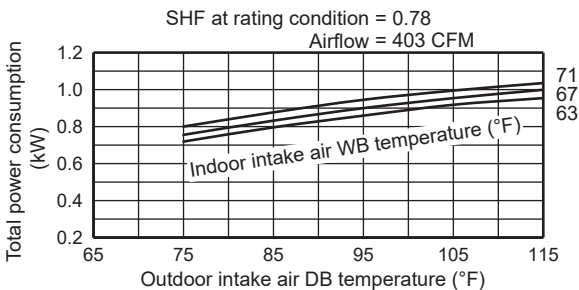
### MUZ-GX09NL MUZ-GX09NLHZ MUY-GX09NL



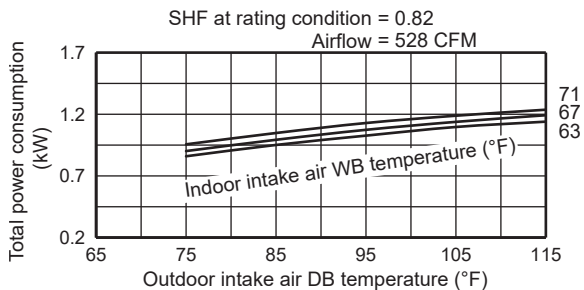
### MUZ-GX12NL MUY-GX12NL



### MUZ-GX12NLHZ



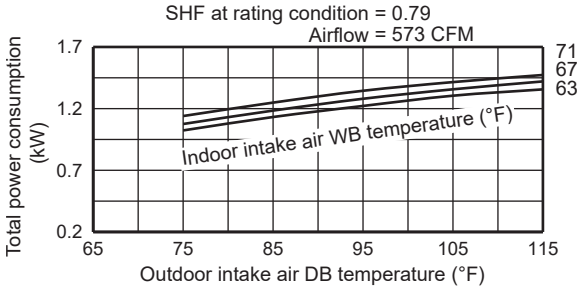
### MUZ-GX15NL MUZ-GX15LHZ MUY-GX15NL



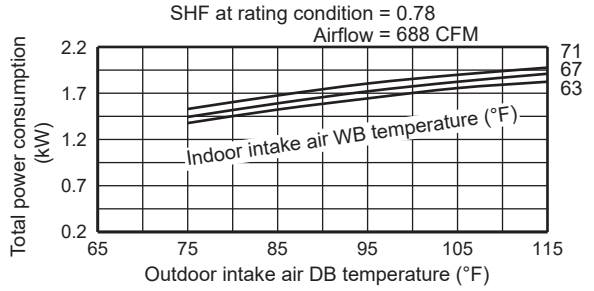
This value of frequency is not the same as the actual frequency in operating. Refer to 8-5 and 8-6 for the relationships between frequency and capacity.



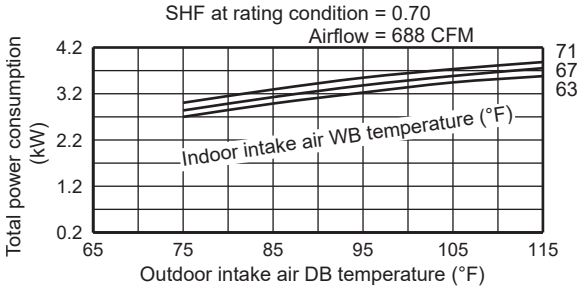
**MUZ-GX18NL MUZ-GX18NLHZ**  
**MUY-GX18NL**



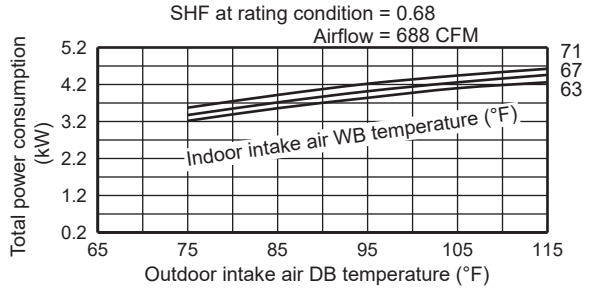
**MUZ-GX24NL MUZ-GX24NLHZ**  
**MUY-GX24NL**



**MUZ-GX30NL**  
**MUY-GX30NL**

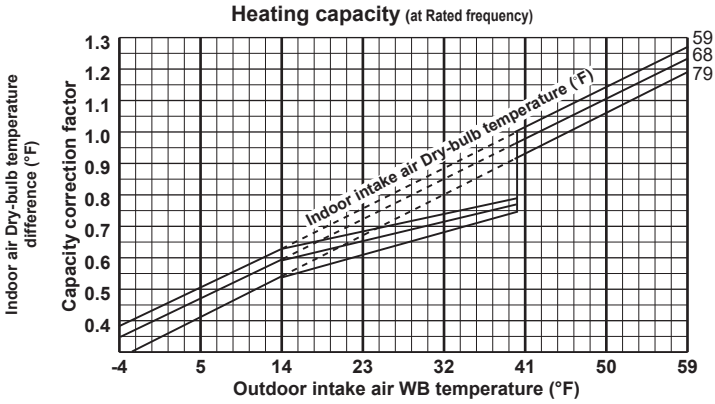


**MUZ-GX36NL**  
**MUY-GX36NL**

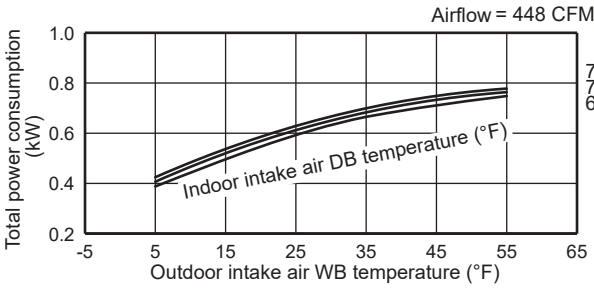


This value of frequency is not the same as the actual frequency in operating. Refer to 8-5 and 8-6 for the relationships between frequency and capacity.

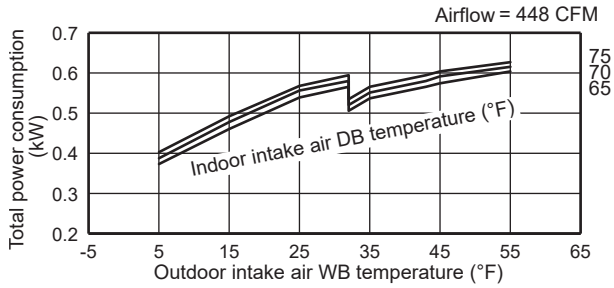
## Heating



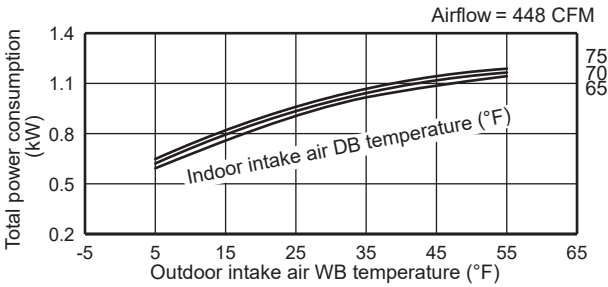
### MUZ-GX09NL



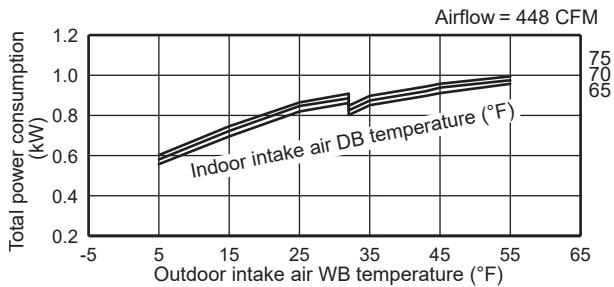
### MUZ-GX09NLHZ



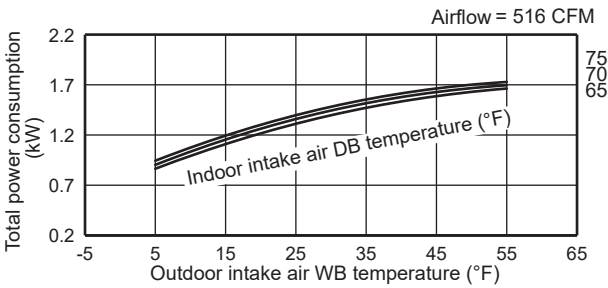
### MUZ-GX12NL



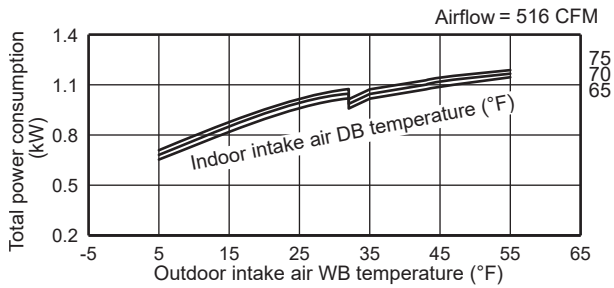
### MUZ-GX12NLHZ



### MUZ-GX15NL

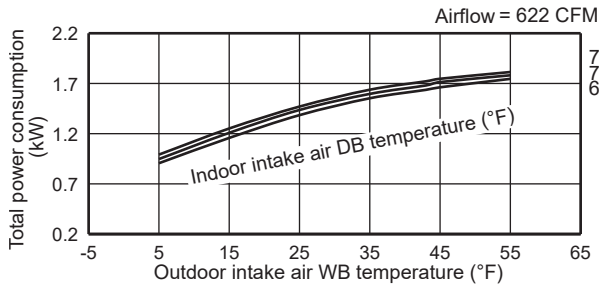


### MUZ-GX15NLHZ

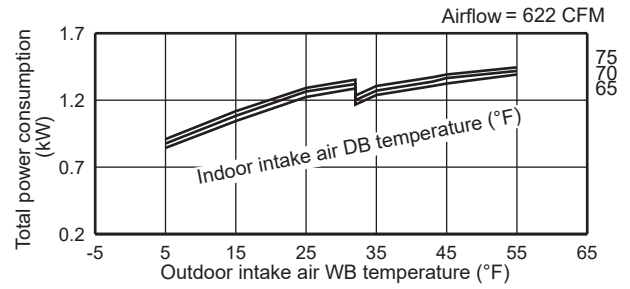


This value of frequency is not the same as the actual frequency in operating. Refer to 8-5 and 8-6 for the relationships between frequency and capacity.

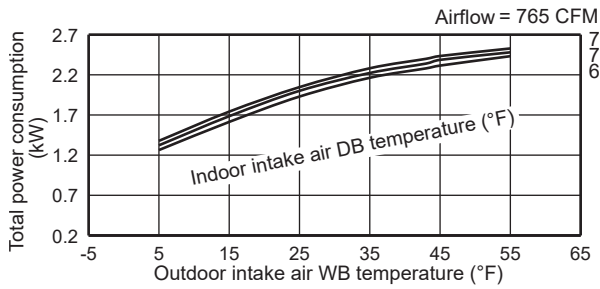
### MUZ-GX18NL



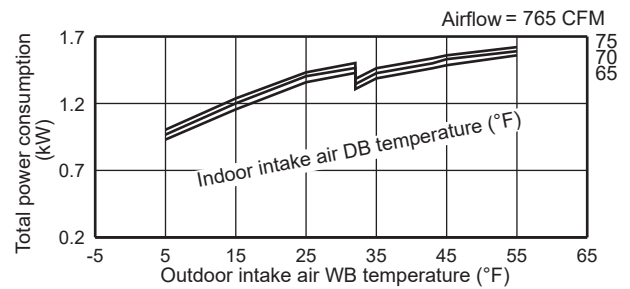
### MUZ-GX18NLHZ



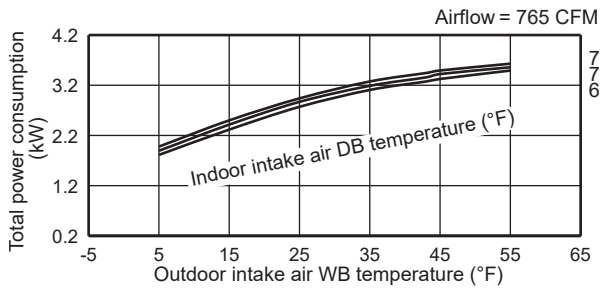
### MUZ-GX24NL



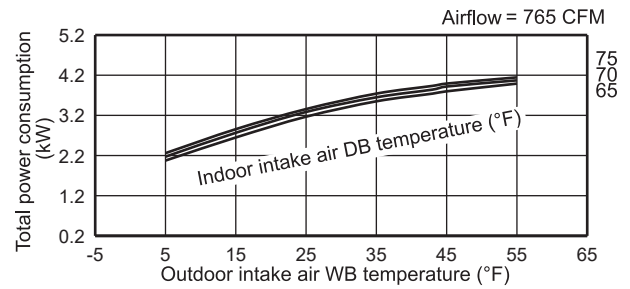
### MUZ-GX24NLHZ



### MUZ-GX30NL



### MUZ-GX36NL



This value of frequency is not the same as the actual frequency in operating. Refer to 8-5 and 8-6 for the relationships between frequency and capacity.

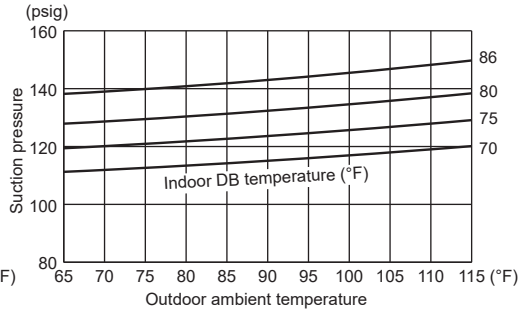
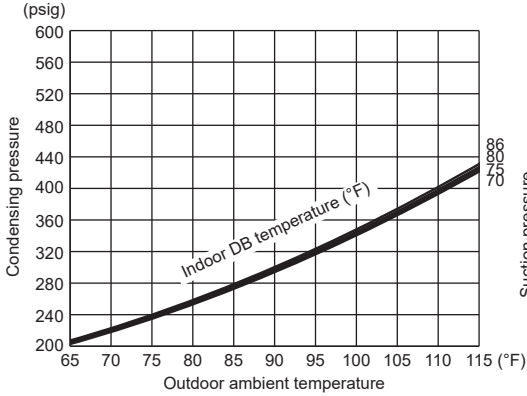
### 8-3. CONDENSING PRESSURE

#### Cooling

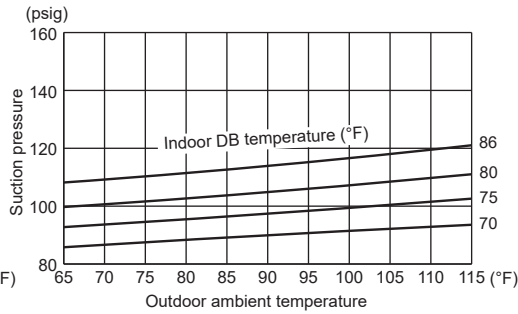
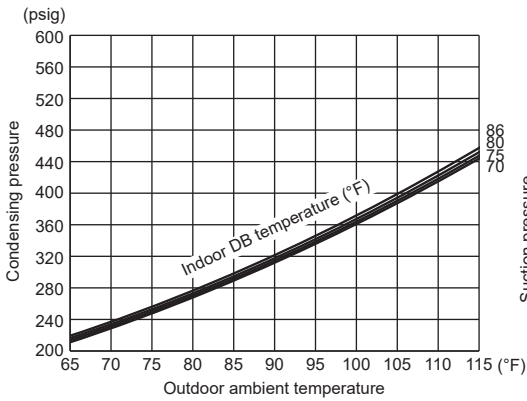
Data are based on the condition of indoor humidity 50 %.

Air flow should be set to High speed.

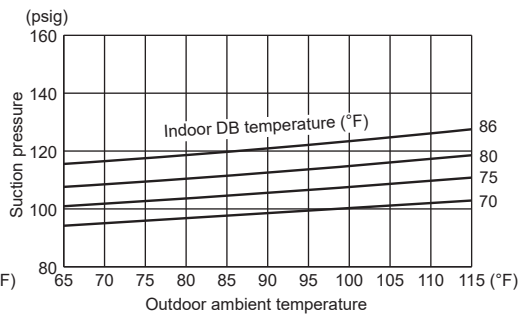
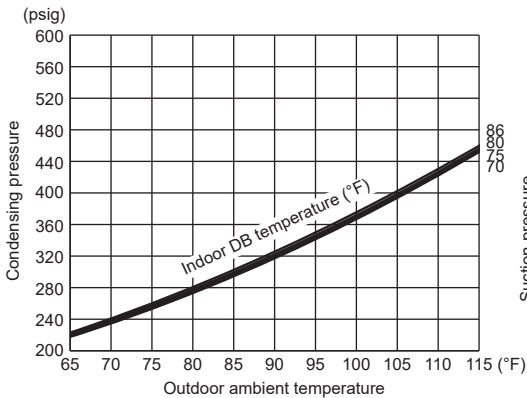
#### MUZ-GX09NL MUY-GX09NL MUZ-GX09NLHZ



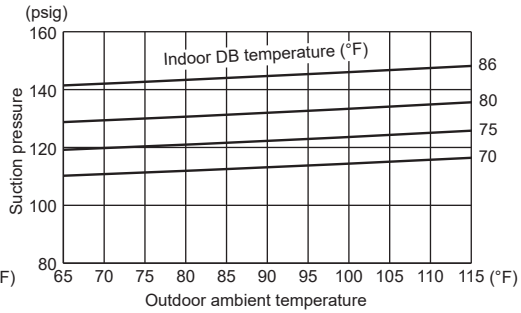
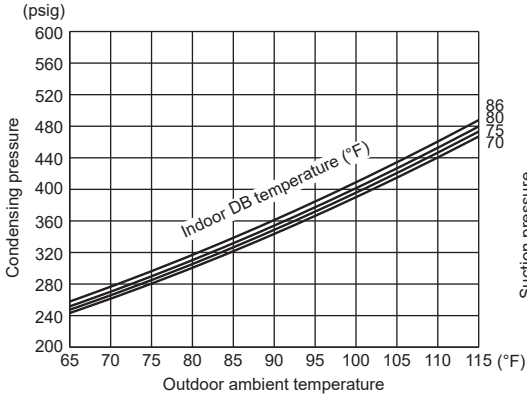
#### MUZ-GX12NL MUY-GX12NL



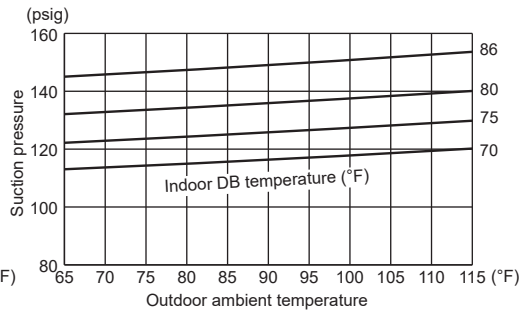
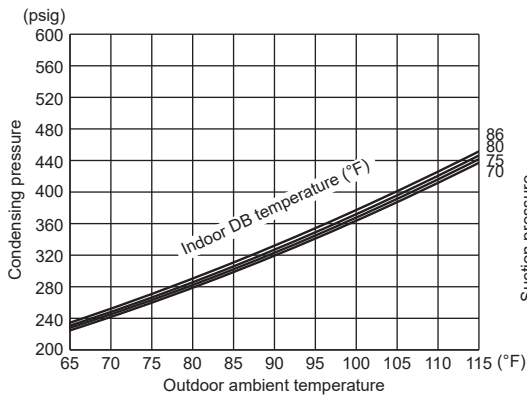
#### MUZ-GX12NLHZ



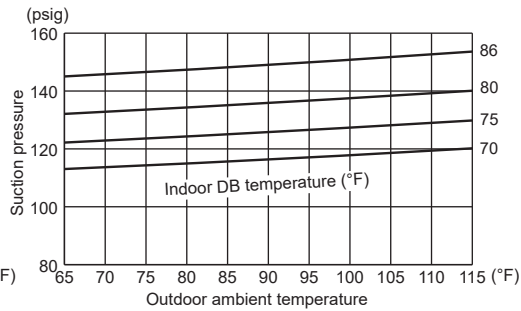
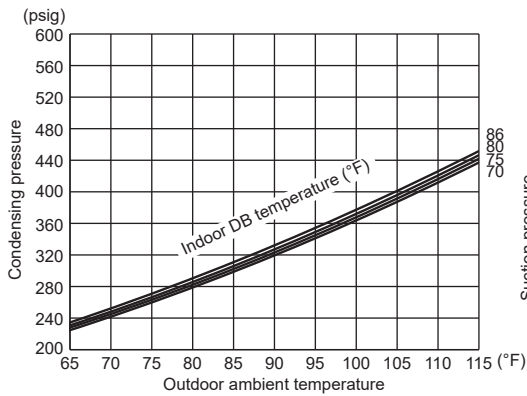
**MUZ-GX15NL MUY-GX15NL MUZ-GX15NLHZ**



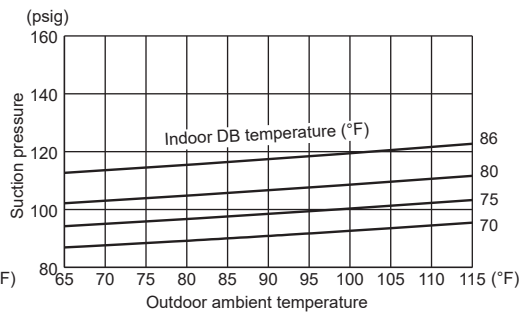
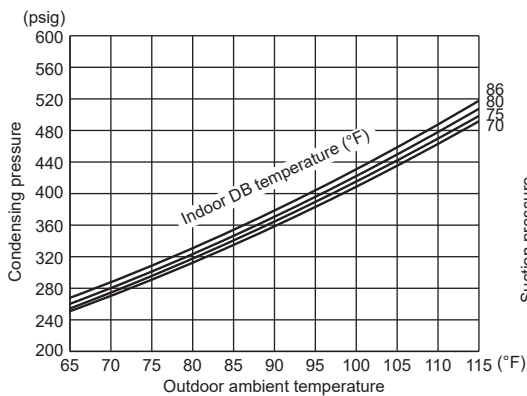
**MUZ-GX18NL MUY-GX18NL MUZ-GX18NLHZ**



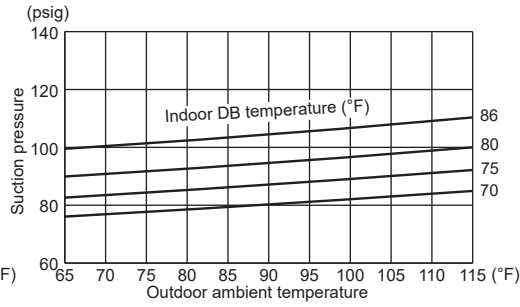
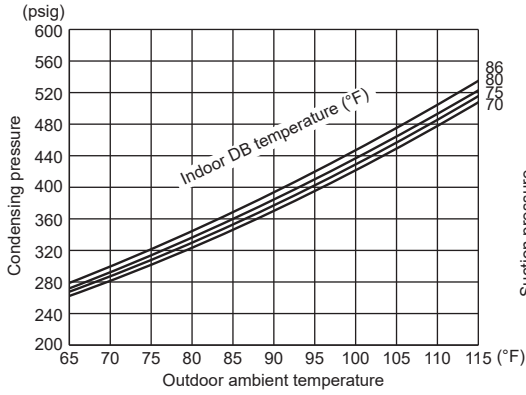
**MUZ-GX24NL MUY-GX24NL MUZ-GX24NLHZ**



**MUZ-GX30NL MUY-GX30NL**



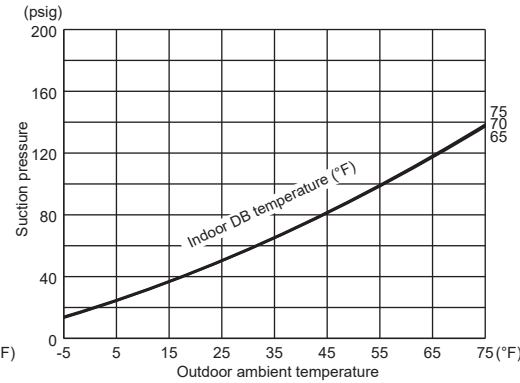
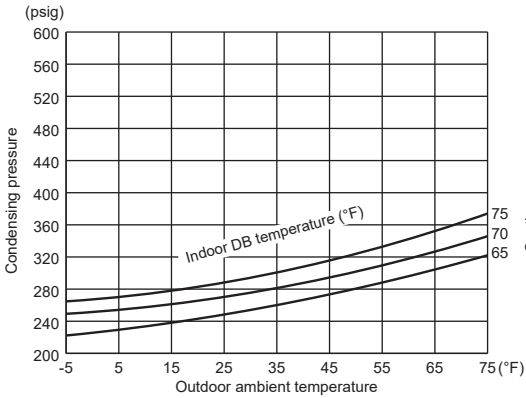
## MUZ-GX36NL MUY-GX36NL



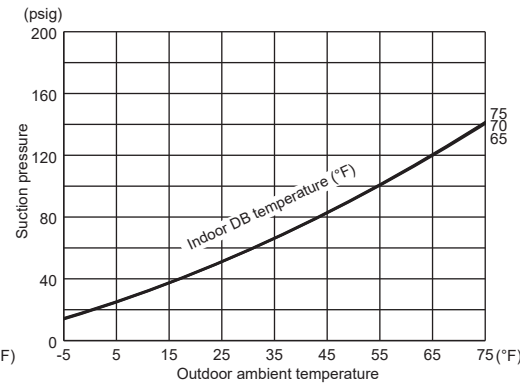
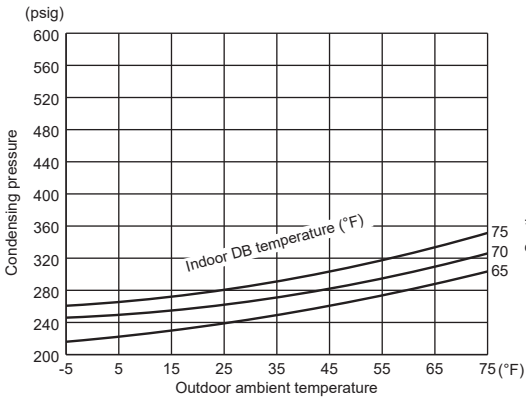
### Heating

Data are based on the condition of outdoor humidity 75%.  
Air flow should be set to High speed.  
Data are for heating operation without any frost.

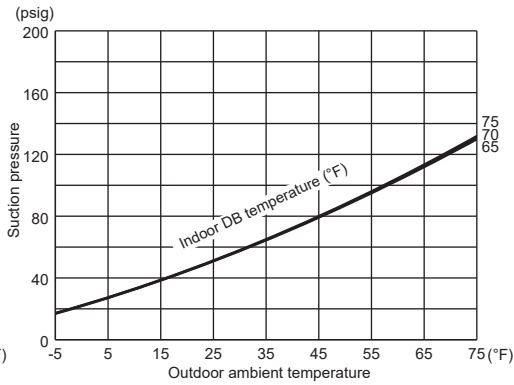
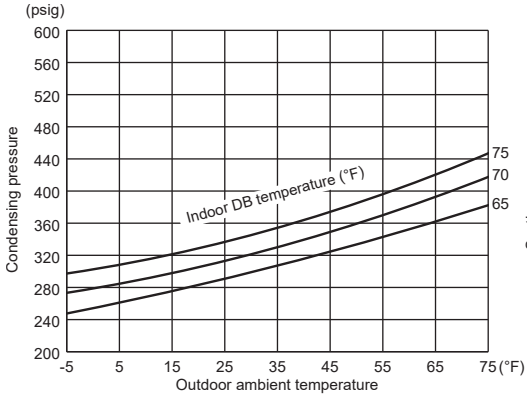
## MUZ-GX09NL



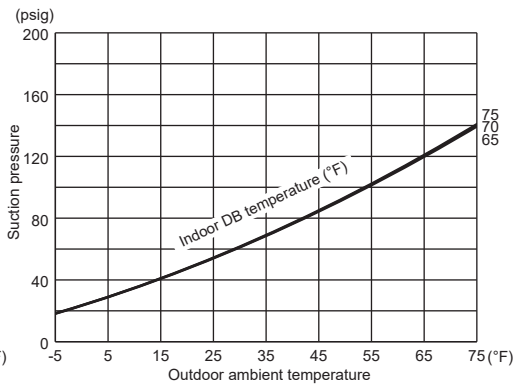
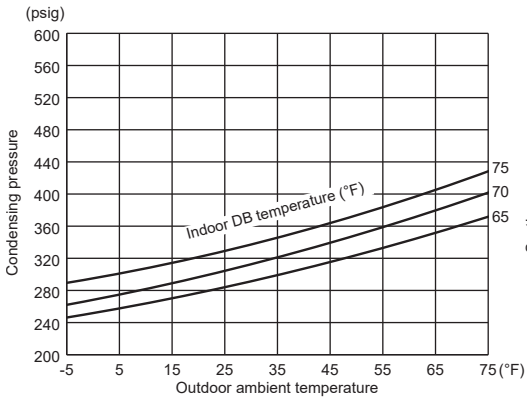
## MUZ-GX09NLHZ



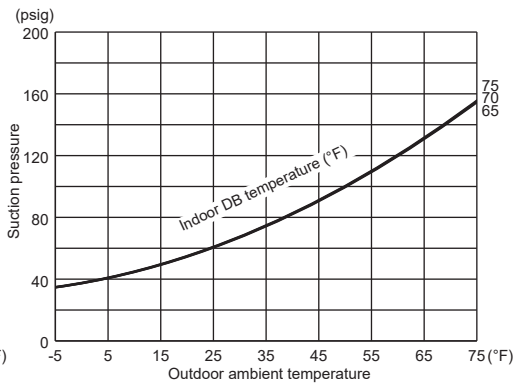
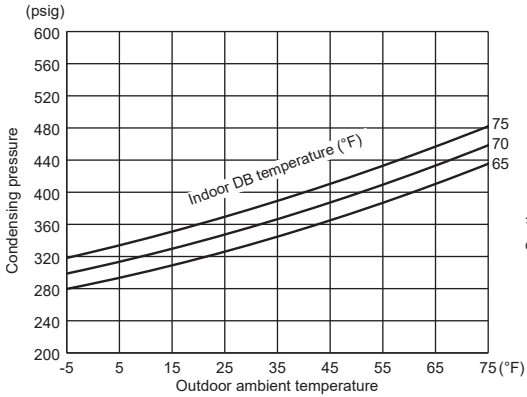
### MUZ-GX12NL



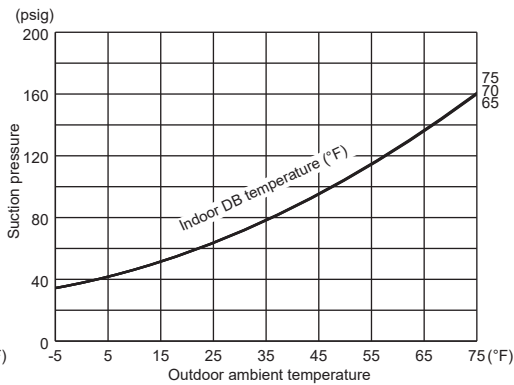
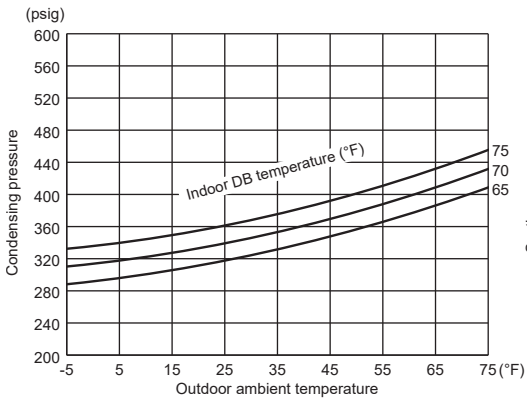
### MUZ-GX12NLHZ



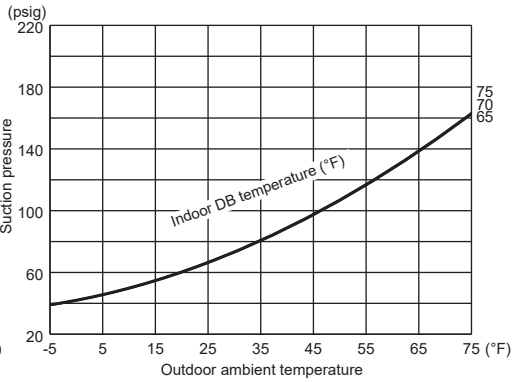
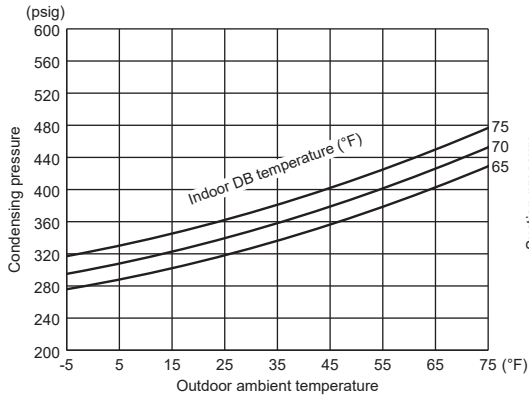
### MUZ-GX15NL



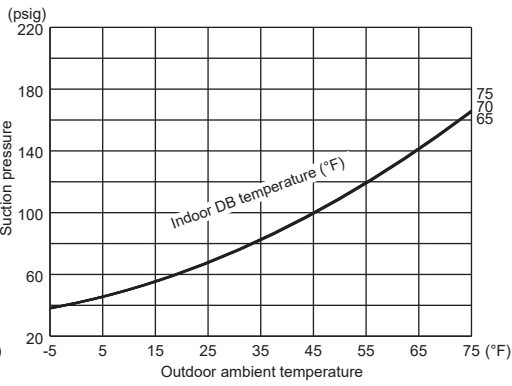
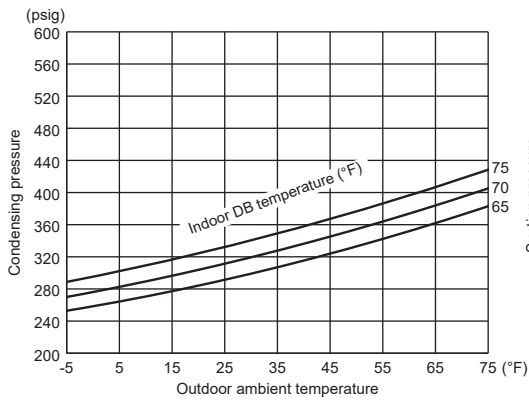
### MUZ-GX15NLHZ



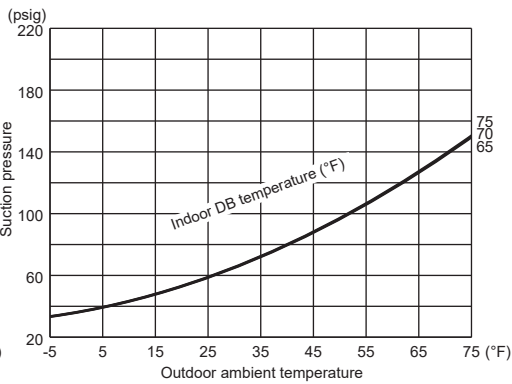
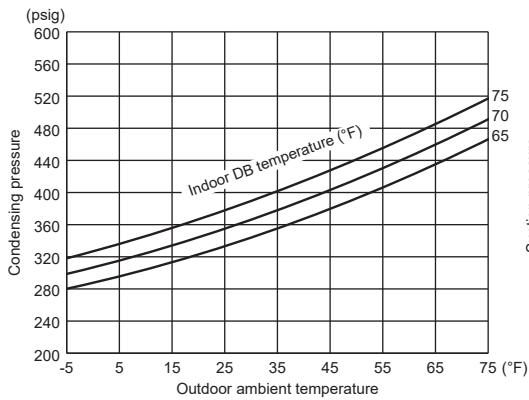
### MUZ-GX18NL



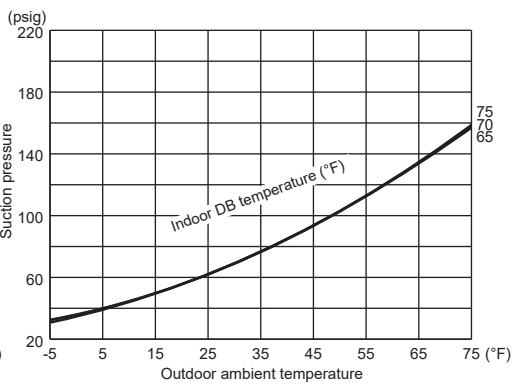
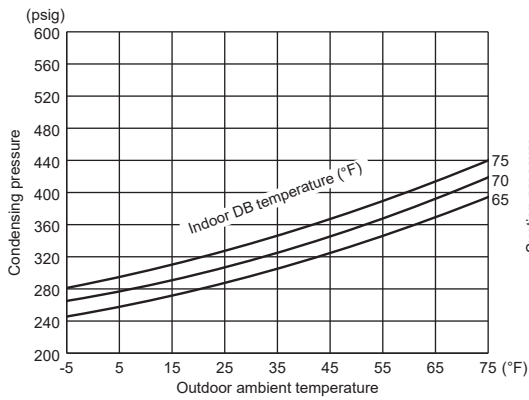
### MUZ-GX18NLHZ



### MUZ-GX24NL

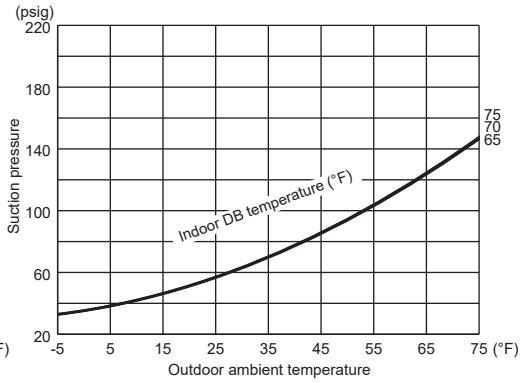
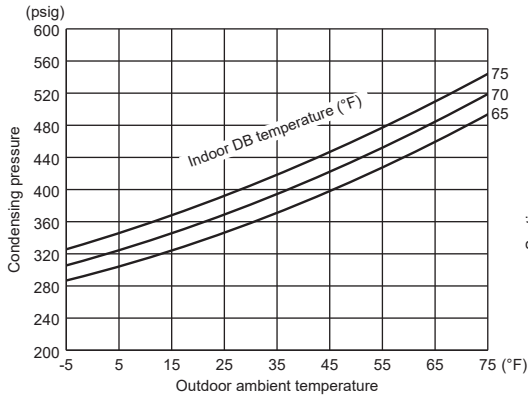


### MUZ-GX24NLHZ

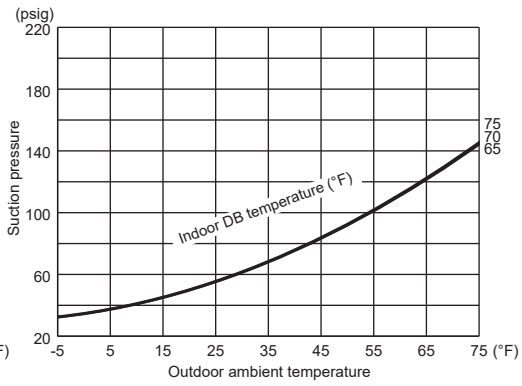
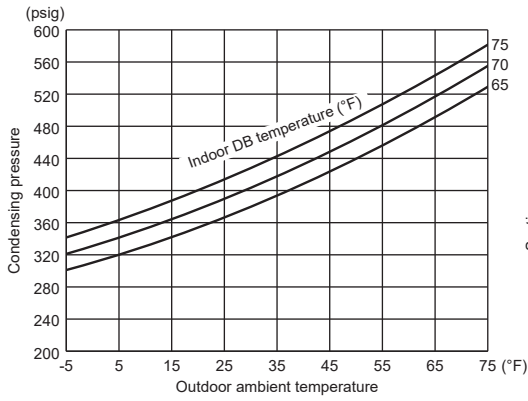




### MUZ-GX30NL

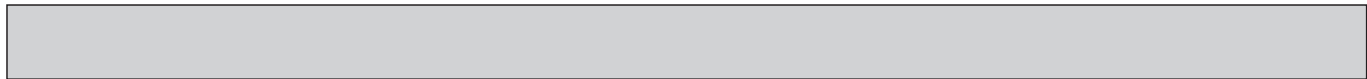


### MUZ-GX36NL



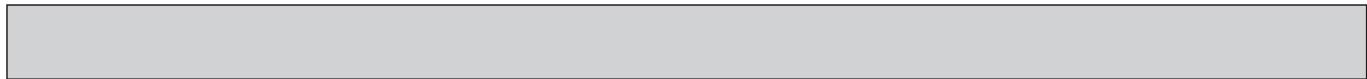
### 8-4. STANDARD OPERATION DATA

Model			MSZ-GX09NL		MSZ-GX09NL		MSY-GX09NL	
Item		Unit	COOL	HEAT	COOL	HEAT	COOL	
Total	Capacity	Btu/h	9,000	10,900	9,000	9,600	9,000	
	SHF	—	0.9	—	0.9	—	0.9	
	Input	kW	0.585	0.72	0.585	0.58	0.585	
	Rated frequency	Hz	48	62	48	54	48	
Electrical circuit	Indoor unit		MSZ-GX09NL		MSZ-GX09NL		MSY-GX09NL	
	Power supply	V, phase, Hz	208/230, 1, 60		208/230, 1, 60		208/230, 1, 60	
	Input	kW	0.024		0.024		0.024	
	Fan motor current	A	0.26/0.24		0.26/0.24		0.26/0.24	
	Outdoor unit		MUZ-GX09NL		MUZ-GX09NLHZ		MUY-GX09NL	
	Power supply	V, phase, Hz	208/230, 1, 60		208/230, 1, 60		208/230, 1, 60	
	Input	kW	0.561	0.696	0.561	0.556	0.561	
	Comp. current	A	2.52/2.28	3.11/2.81	2.49/2.25	2.54/2.30	2.52/2.28	
	Fan motor current	A	0.32/0.29	0.29/0.26	0.35/0.32	0.32/0.29	0.32/0.29	
	Refrigerant circuit	Condensing pressure	psig	334	317	334	297	334
Suction pressure		psig	147	120	147	104	147	
Discharge temperature		°F	143	160	143	145	143	
Condensing temperature		°F	110	106	110	101	110	
Suction temperature		°F	56	41	56	38	56	
Comp. shell bottom temperature		°F	136	147	136	133	136	
Ref. pipe length		ft.	25		25		25	
Refrigerant charge (R454B)			2lbs.		2lbs.		2lbs.	
Indoor unit	Intake air temperature	DB	°F	80	70	80	70	80
		WB	°F	67	60	67	60	67
	Discharge air temperature	DB	°F	62	93	62	91	62
		WB	°F	61	—	61	—	61
	Fan speed	rpm	1,020		1,020		1,020	
Airflow	CFM	403 (wet)	448	403 (wet)	448	403 (wet)		
Outdoor unit	Intake air temperature	DB	°F	95	47	95	47	95
		WB	°F	—	43	—	43	—
	Fan speed	rpm	900	860	900	860	900	
	Airflow	CFM	1,152	1,097	1,177	1,121	1,152	



Model			MSZ-GX12NL		MSZ-GX12NL		MSY-GX12NL	
Item		Unit	COOL	HEAT	COOL	HEAT	COOL	
Total	Capacity	Btu/h	12,000	14,400	12,000	12,300	12,000	
	SHF	—	0.77	—	0.78	—	0.77	
	Input	kW	0.9	1.1	0.9	0.92	0.9	
	Rated frequency	Hz	74	84	47.5	46	74	
Electrical circuit	Indoor unit		MSZ-GX12NL		MSZ-GX12NL		MSY-GX12NL	
	Power supply	V, phase, Hz	208/230, 1, 60		208/230, 1, 60		208/230, 1, 60	
	Input	kW	0.024		0.024		0.024	
	Fan motor current	A	0.26/0.24		0.26/0.24		0.26/0.24	
	Outdoor unit		MUZ-GX12NL		MUZ-GX12NLHZ		MUY-GX12NL	
	Power supply	V, phase, Hz	208/230, 1, 60		208/230, 1, 60		208/230, 1, 60	
	Input	kW	0.876	1.076	0.876	0.896	0.876	
	Comp. current	A	4.12/3.72	4.80/4.34	4.00/3.62	3.83/3.46	4.12/3.72	
	Fan motor current	A	0.32/0.29	0.29/0.26	0.36/0.32	0.35/0.32	0.32/0.29	
	Refrigerant circuit	Condensing pressure	psig	359	370	360	358	359
Suction pressure		psig	128	96	128	102	128	
Discharge temperature		°F	168	180	170	168	168	
Condensing temperature		°F	115	117	115	115	115	
Suction temperature		°F	56	36	58	37	56	
Comp. shell bottom temperature		°F	161	171	156	159	161	
Ref. pipe length		ft.	25		25		25	
Refrigerant charge (R454B)			2lbs.		2lbs. 4oz		2lbs.	
Indoor unit	Intake air temperature	DB	°F	80	70	80	70	80
		WB	°F	67	60	67	60	67
	Discharge air temperature	DB	°F	58	101	62	96	58
		WB	°F	57	—	61	—	57
	Fan speed	rpm	1,020		1,020		1,020	
Airflow	CFM	403 (wet)	448	403 (wet)	448	403 (wet)		
Outdoor unit	Intake air temperature	DB	°F	95	47	95	47	95
		WB	°F	—	43	—	43	—
	Fan speed	rpm	900	860	910	900	900	
	Airflow	CFM	1,152	1,097	1,191	1,177	1,152	

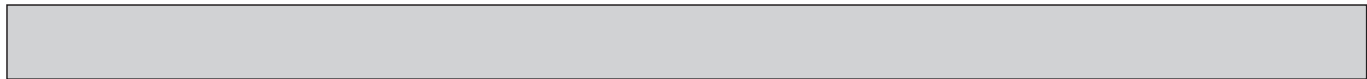
Model			MSZ-GX15NL		MSZ-GX15NL		MSY-GX15NL	
Item		Unit	COOL	HEAT	COOL	HEAT	COOL	
Total	Capacity	Btu/h	14,000	18,000	14,000		14,000	
	SHF	—	0.82	—	0.82	—	0.82	
	Input	kW	1.075	1.6	1.075	1.1	1.075	
	Rated frequency	Hz	54	70	54	52.5	54	
Electrical circuit	Indoor unit		MSZ-GX15NL		MSZ-GX15NL		MSY-GX15NL	
	Power supply	V, phase, Hz	208/230, 1, 60		208/230, 1, 60		208/230, 1, 60	
	Input	kW	0.053	0.037	0.053	0.037	0.053	
	Fan motor current	A	0.50/0.46	0.37/0.34	0.50/0.46	0.37/0.34	0.50/0.46	
	Outdoor unit		MUZ-GX15NL		MUZ-GX15NLHZ		MUY-GX15NL	
	Power supply	V, phase, Hz	208/230, 1, 60		208/230, 1, 60		208/230, 1, 60	
	Input	kW	1.022	1.563	1.022	1.063	1.022	
	Comp. current	A	4.61/4.17	6.29/5.69	4.58/4.14	4.40/3.98	4.61/4.17	
Fan motor current	A	0.33/0.30	0.32/0.29	0.36/0.32	0.35/0.32	0.33/0.30		
Refrigerant circuit	Condensing pressure	psig	378	391	378	371	378	
	Suction pressure	psig	132	94	132	97	132	
	Discharge temperature	°F	172	186	172	182	172	
	Condensing temperature	°F	119	121	119	117	119	
	Suction temperature	°F	57	33	57	41	57	
	Comp. shell bottom temperature	°F	158	174	158	163	158	
	Ref. pipe length	ft.	25		25		25	
	Refrigerant charge (R454B)		2lbs. 4oz		2lbs. 4oz		2lbs. 4oz	
Indoor unit	Intake air temperature	DB	°F	80	70	80	70	80
		WB	°F	67	60	67	60	67
	Discharge air temperature	DB	°F	58	95	58	88	58
		WB	°F	57	—	57	—	57
	Fan speed	rpm	1,260	1,140	1,260	1,140	1,260	
Airflow	CFM	528 (wet)	516	528 (wet)	516	528 (wet)		
Outdoor unit	Intake air temperature	DB	°F	95	47	95	47	95
		WB	°F	—	43	—	43	—
	Fan speed	rpm	910	900	910	900	910	
	Airflow	CFM	1,166	1,152	1,191	1,177	1,166	



Model			MSZ-GX18NL		MSZ-GX18NL		MSY-GX18NL	
Item		Unit	COOL	HEAT	COOL	HEAT	COOL	
Total	Capacity	Btu/h	18,000	21,600	18,000	19,000	18,000	
	SHF	—	0.79	—	0.79	—	0.79	
	Input	kW	1.28	1.68	1.28	1.34	1.28	
	Rated frequency	Hz	54	65.5	54	57.5	54	
Electrical circuit	Indoor unit		MSZ-GX18NL		MSZ-GX18NL		MSY-GX18NL	
	Power supply	V, phase, Hz	208/230, 1, 60		208/230, 1, 60		208/230, 1, 60	
	Input	kW	0.037	0.035	0.037	0.035	0.037	
	Fan motor current	A	0.38/0.34	0.36/0.32	0.38/0.34	0.36/0.32	0.38/0.34	
	Outdoor unit		MUZ-GX18NL		MUZ-GX18NLHZ		MUY-GX18NL	
	Power supply	V, phase, Hz	208/230, 1, 60		208/230, 1, 60		208/230, 1, 60	
	Input	kW	1.243	1.645	1.243	1.305	1.243	
	Comp. current	A	4.81/4.35	6.88/6.22	4.81/4.35	5.29/4.79	4.81/4.35	
Fan motor current	A	0.93/0.84		0.93/0.84		0.93/0.84		
Refrigerant circuit	Condensing pressure	psig	350	382	350	349	350	
	Suction pressure	psig	137	100	137	103	137	
	Discharge temperature	°F	155	178	155	160	155	
	Condensing temperature	°F	113	120	113		113	
	Suction temperature	°F	54	36	54	36	54	
	Comp. shell bottom temperature	°F	146	164	146		146	
	Ref. pipe length	ft.	25		25		25	
	Refrigerant charge (R454B)		3lbs. 12oz		3lbs. 12oz		3lbs. 12oz	
Indoor unit	Intake air temperature	DB	°F	80	70	80	70	80
		WB	°F	67	60	67	60	67
	Discharge air temperature	DB	°F	58	110	58	104	58
		WB	°F	57	—	57	—	57
	Fan speed	rpm	1,120	1,100	1,120	1,100	1,120	
Airflow	CFM	573 (wet)	622	573 (wet)	622	573 (wet)		
Outdoor unit	Intake air temperature	DB	°F	95	47	95	47	95
		WB	°F	—	43	—	43	—
	Fan speed	rpm	800		800		800	
	Airflow	CFM	1,934		1,934		1,934	



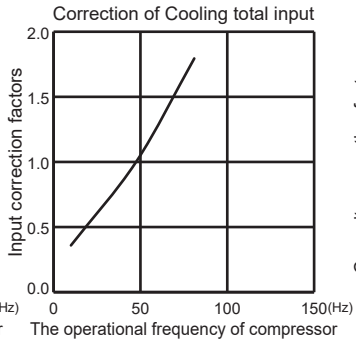
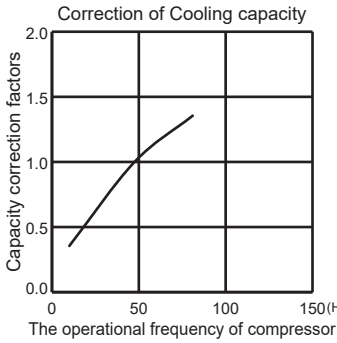
Model			MSZ-GX24NL		MSZ-GX24NL		MSY-GX24NL	
Item		Unit	COOL	HEAT	COOL	HEAT	COOL	
Total	Capacity	Btu/h	22,400	27,600	22,400	21,200	22,400	
	SHF	—	0.78	—	0.78	—	0.78	
	Input	kW	1.72	2.34	1.72	1.5	1.72	
	Rated frequency	Hz	68	90	68	65	68	
Electrical circuit	Indoor unit		MSZ-GX24NL		MSZ-GX24NL		MSY-GX24NL	
	Power supply	V, phase, Hz	208/230, 1, 60		208/230, 1, 60		208/230, 1, 60	
	Input	kW	0.062		0.062		0.062	
	Fan motor current	A	0.58/0.52		0.58/0.52		0.58/0.52	
	Outdoor unit		MUZ-GX24NL		MUZ-GX24NLHZ		MUY-GX24NL	
	Power supply	V, phase, Hz	208/230, 1, 60		208/230, 1, 60		208/230, 1, 60	
	Input	kW	1.658	2.278	1.658	1.438	1.658	
	Comp. current	A	6.67/6.03	10.62/9.61	6.67/6.03	6.12/5.54	6.67/6.03	
	Fan motor current	A	0.99/0.90	0.93/0.84	0.99/0.90	0.93/0.84	0.99/0.90	
	Refrigerant circuit	Condensing pressure	psig	361	406	361	347	361
Suction pressure		psig	131	91	131	96	131	
Discharge temperature		°F	165	191	165	175	165	
Condensing temperature		°F	115	124	115	113	115	
Suction temperature		°F	53	32	53	41	53	
Comp. shell bottom temperature		°F	152	174	152	156	152	
Ref. pipe length		ft.	25		25		25	
Refrigerant charge (R454B)			3lbs. 12oz		3lbs. 12oz		3lbs. 12oz	
Indoor unit	Intake air temperature	DB	°F	80	70	80	70	80
		WB	°F	67	60	67	60	67
	Discharge air temperature	DB	°F	66	99	66	90	66
		WB	°F	65	—	65	—	65
	Fan speed	rpm	1,300		1,300		1,300	
Airflow	CFM	688 (wet)	765	688 (wet)	765	688 (wet)		
Outdoor unit	Intake air temperature	DB	°F	95	47	95	47	95
		WB	°F	—	43	—	43	—
	Fan speed	rpm	830	800	830	800	830	
	Airflow	CFM	2,015	1,934	2,015	1,934	2,015	



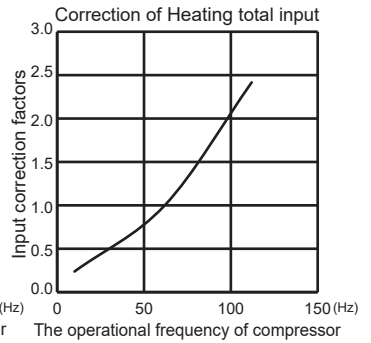
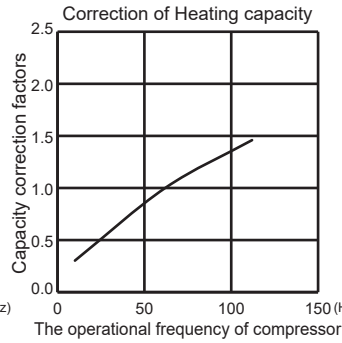
Model			MSZ-GX30NL		MSY-GX30NL	MSZ-GX36NL		MSY-GX36NL	
Item		Unit	COOL	HEAT	COOL	COOL	HEAT	COOL	
Total	Capacity	Btu/h	30,600	32,600	30,600	33,800	35,200	33,800	
	SHF	—	0.7	—	0.7	0.68	—	0.68	
	Input	kW	3.38	3.36	3.38	4.02	3.84	4.02	
	Rated frequency	Hz	105	101.5	105	123	109.5	123	
Electrical circuit	Indoor unit		MSZ-GX30NL		MSY-GX30NL	MSZ-GX36NL		MSY-GX36NL	
	Power supply	V, phase, Hz	208/230, 1, 60		208/230, 1, 60	208/230, 1, 60		208/230, 1, 60	
	Input	kW	0.062		0.062	0.062		0.062	
	Fan motor current	A	0.58/0.52		0.58/0.52	0.58/0.52		0.58/0.52	
	Outdoor unit		MUZ-GX30NL		MUY-GX30NL	MUZ-GX36NL		MUY-GX36NL	
	Power supply	V, phase, Hz	208/230, 1, 60		208/230, 1, 60	208/230, 1, 60		208/230, 1, 60	
	Input	kW	3.318	3.298	3.318	3.958	3.778	3.958	
	Comp. current	A	13.12/11.86	13.22/11.96	13.12/11.86	17.76/16.06	15.63/14.14	17.76/16.06	
	Fan motor current	A	1.16/1.05	0.93/0.84	1.16/1.05	1.16/1.05	0.93/0.84	1.16/1.05	
	Refrigerant circuit	Condensing pressure	psig	395	429	395	412	453	412
Suction pressure		psig	108	88	108	97	86	97	
Discharge temperature		°F	190	196	190	204	202	204	
Condensing temperature		°F	122	128	122	125	132	125	
Suction temperature		°F	44	30	44	37	29	37	
Comp. shell bottom temperature		°F	137	181	137	189	187	189	
Ref. pipe length		ft.	25		25	25		25	
Refrigerant charge (R454B)		3lbs. 12oz		3lbs. 12oz	3lbs. 12oz		3lbs. 12oz		
Indoor unit	Intake air temperature	DB	°F	80	70	80	80	70	80
		WB	°F	67	60	67	67	60	67
	Discharge air temperature	DB	°F	62	102	62	52	106	52
		WB	°F	61	—	61	51	—	51
	Fan speed	rpm	1,300		1,300	1,300		1,300	
Airflow	CFM	688 (wet)	765	688 (wet)	688 (wet)	765	688 (wet)		
Outdoor unit	Intake air temperature	DB	°F	95	47	95	95	47	95
		WB	°F	—	43	—	—	43	—
	Fan speed	rpm	900	800	900	900	800	900	
	Airflow	CFM	2,202	1,934	2,202	2,202	1,934	2,202	

## 8-5. CAPACITY AND INPUT CORRECTION BY INVERTER OUTPUT FREQUENCY

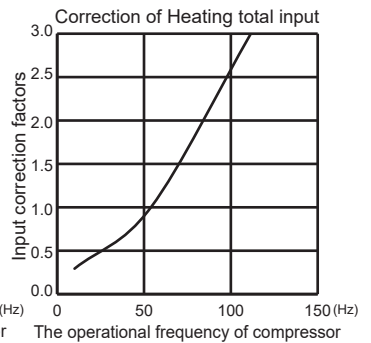
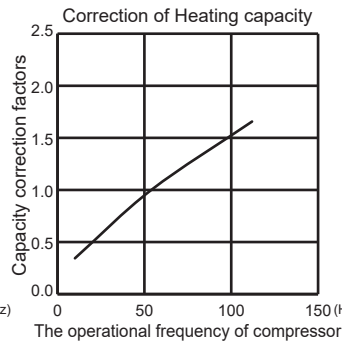
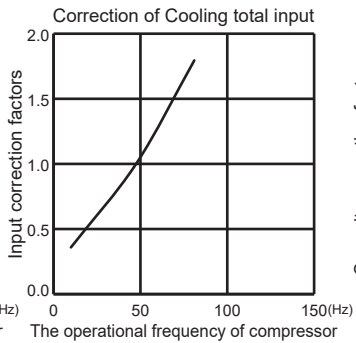
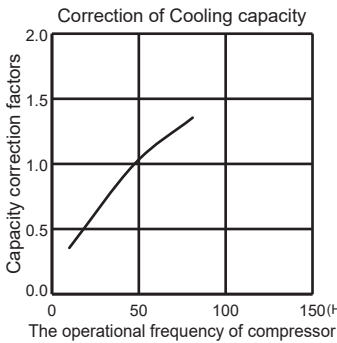
### MUZ-GX09NL MUY-GX09NL



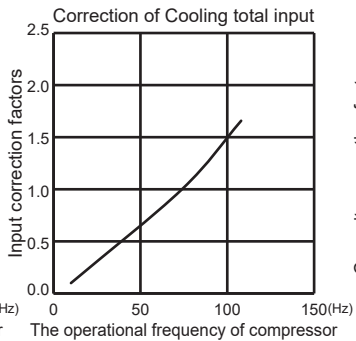
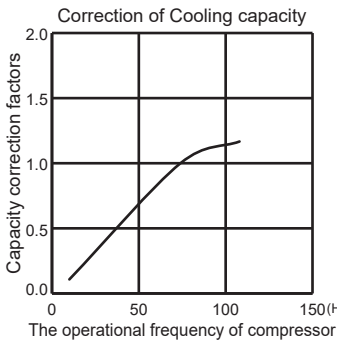
### MUZ-GX09NL



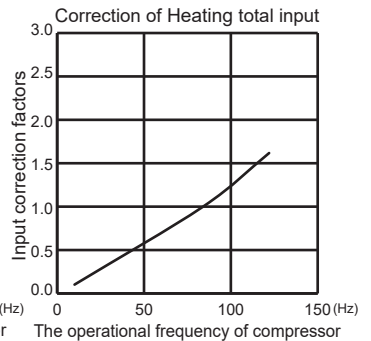
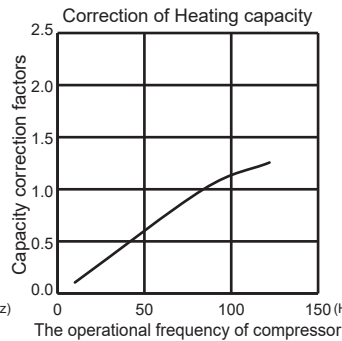
### MUZ-GX09NLHZ



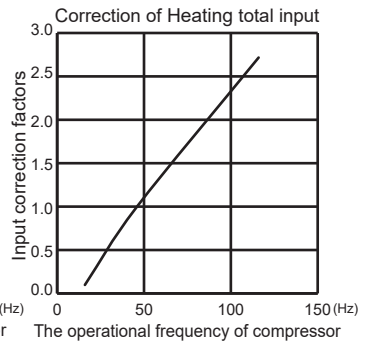
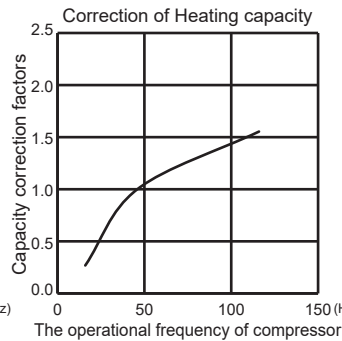
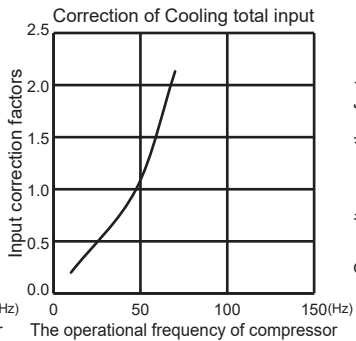
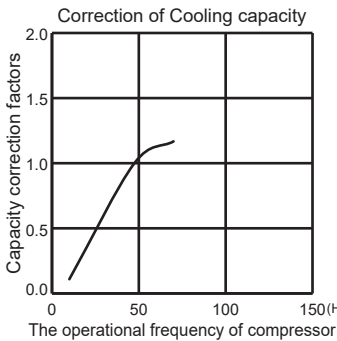
### MUZ-GX12NL MUY-GX12NL



### MUZ-GX12NL



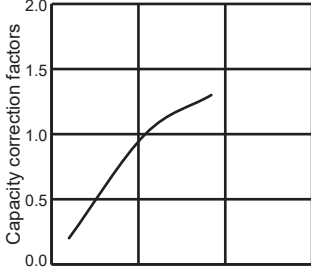
### MUZ-GX12NLHZ





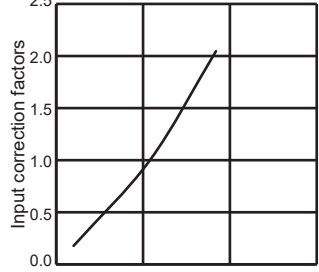
**MUZ-GX15NL MUY-GX15NL**

Correction of Cooling capacity



The operational frequency of compressor

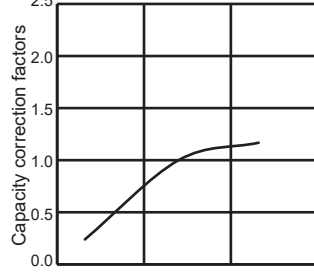
Correction of Cooling total input



The operational frequency of compressor

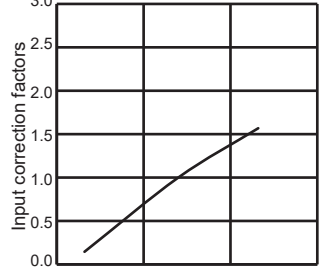
**MUZ-GX15NL**

Correction of Heating capacity



The operational frequency of compressor

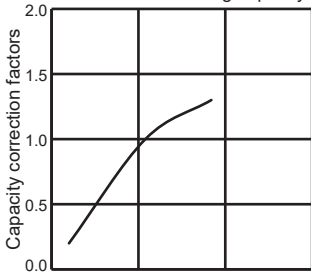
Correction of Heating total input



The operational frequency of compressor

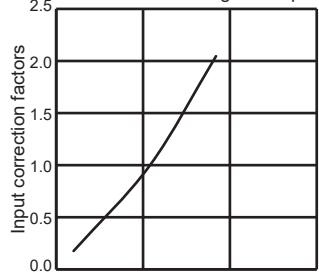
**MUZ-GX15NLHZ**

Correction of Cooling capacity



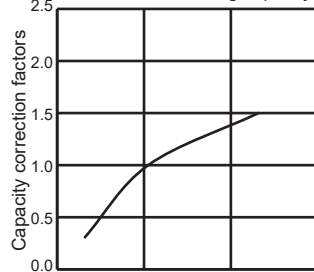
The operational frequency of compressor

Correction of Cooling total input



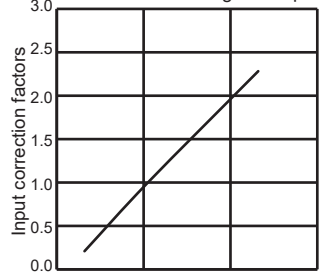
The operational frequency of compressor

Correction of Heating capacity



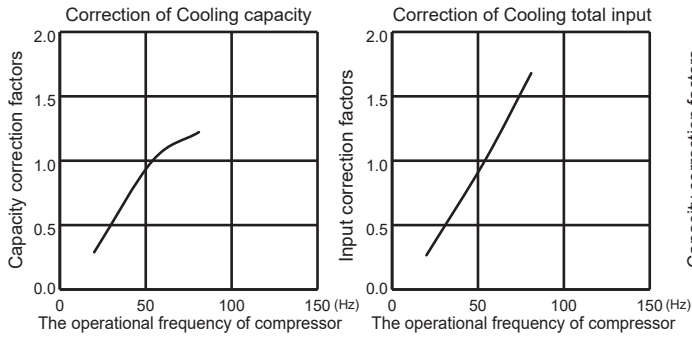
The operational frequency of compressor

Correction of Heating total input

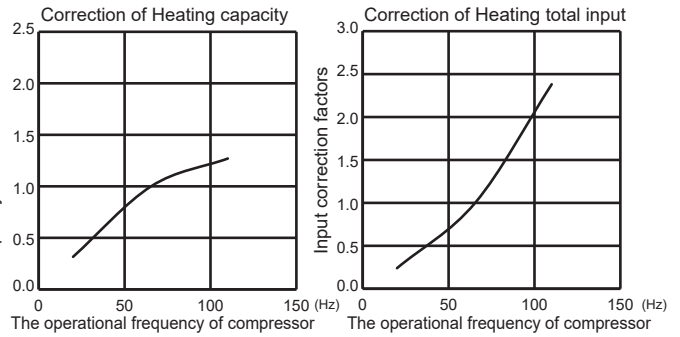


The operational frequency of compressor

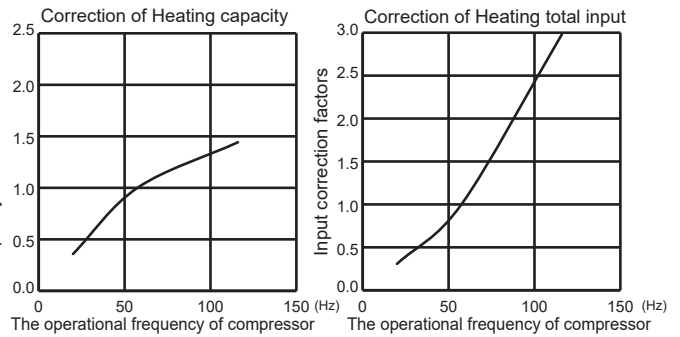
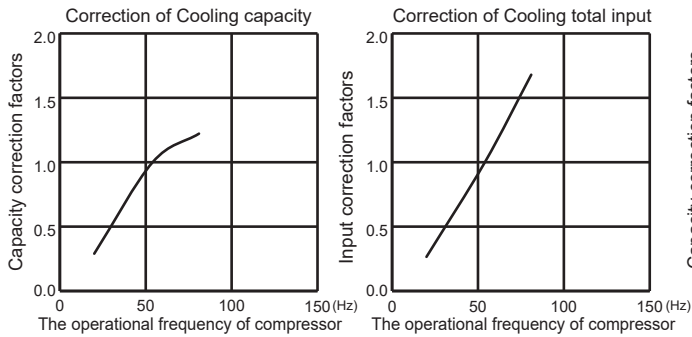
**MUZ-GX18NL MUY-GX18NL**



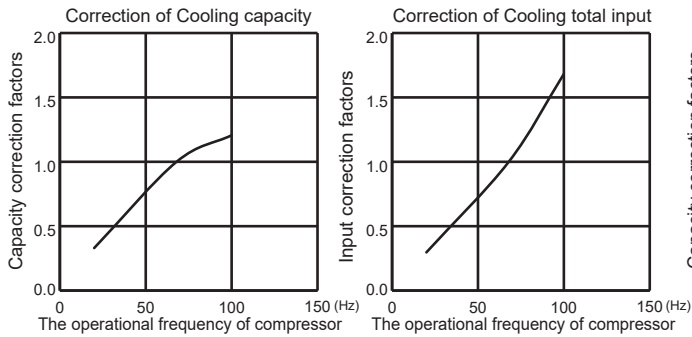
**MUZ-GX18NL**



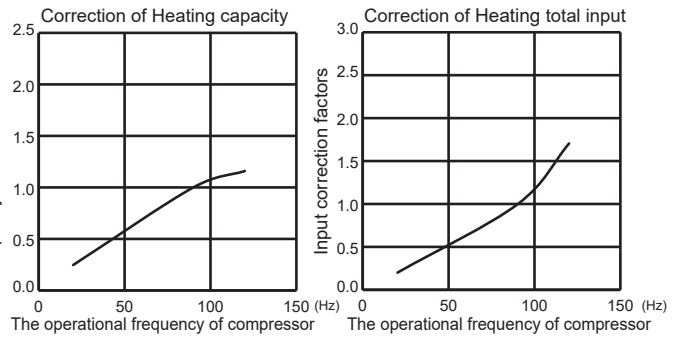
**MUZ-GX18NLHZ**



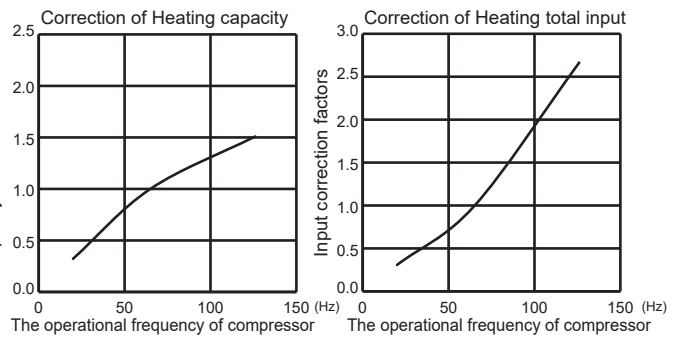
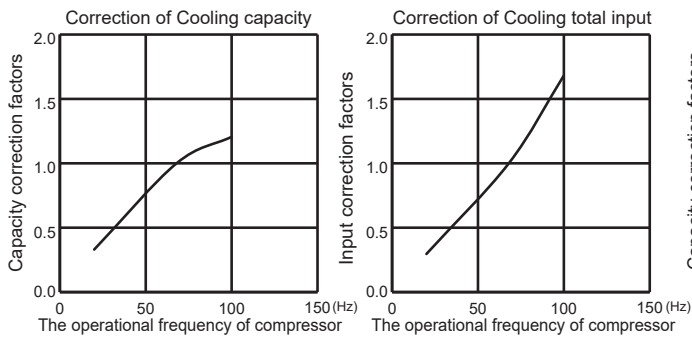
**MUZ-GX24NL MUY-GX24NL**



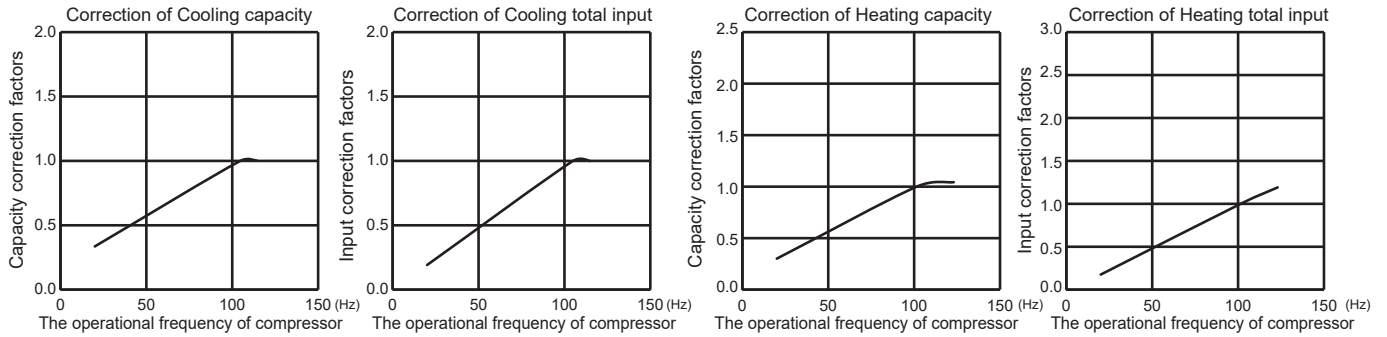
**MUZ-GX24NL**



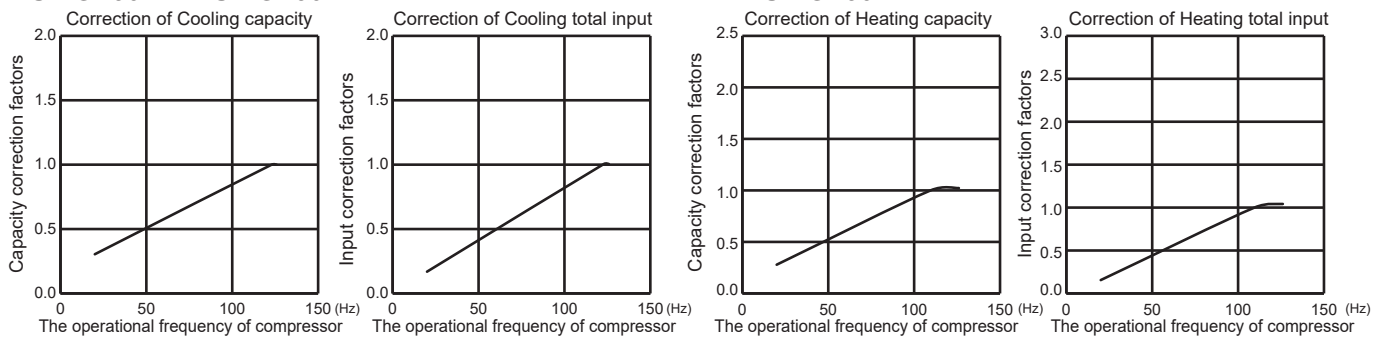
**MUZ-GX24NLHZ**



## MUZ-GX30NL MUY-GX30NL



## MUZ-GX36NL MUY-GX36NL



### 8-6. HOW TO OPERATE FIXED-FREQUENCY OPERATION (Test run operation)

1. Press the emergency operation switch to start COOL or HEAT mode (COOL: Press once, HEAT: Press twice).
2. Test run operation starts and continues to operate for 30 minutes.
3. Compressor operates at rated frequency in COOL mode or 58 Hz in HEAT mode.
4. Indoor fan operates at High speed.
5. After 30 minutes, test run operation finishes and EMERGENCY OPERATION starts (operation frequency of compressor varies).
6. To cancel test run operation (EMERGENCY OPERATION), press the emergency operation switch or any button on remote controller.



**MUZ-GX09NL    MUZ-GX12NL    MUZ-GX15NL**  
**MUZ-GX18NL    MUZ-GX24NL    MUZ-GX30NL    MUZ-GX36NL**  
**MUY-GX09NL    MUY-GX12NL    MUY-GX15NL**  
**MUY-GX18NL    MUY-GX24NL    MUY-GX30NL    MUY-GX36NL**  
**MUZ-GX09NLHZ    MUZ-GX12NLHZ    MUZ-GX15NLHZ**  
**MUZ-GX18NLHZ    MUZ-GX24NLHZ**

### 10-1. CHANGE IN DEFROST SETTING

#### Changing defrost finish temperature

<JS> To change the defrost finish temperature, cut/solder the JS wire of the outdoor inverter P.C. board (Refer to 11-6.1.).

Jumper		Defrost finish temperature	
		MUZ-GX09/12/15NL MUZ-GX09/12/15NLHZ	MUZ-GX18/24/30/36NL MUZ-GX18/24NLHZ
JS	Soldered (Initial setting)	46°F (8°C)	50°F (10°C)
	None (Cut)	55°F (13°C)	59°F (15°C)

### 10-2. PRE-HEAT CONTROL SETTING

Prolonged low load operation, in which the thermostat is OFF for a long time, at low outside temperature [32°F (0°C) or less] may cause the following troubles. To prevent those troubles, activate the pre-heat control.

- 1) If moisture gets into the refrigerant cycle and freezes, it may interfere the startup of the compressor.
- 2) If liquid refrigerant collects in the compressor, a failure in the compressor may occur.

The pre-heat control turns ON when the compressor temperature is 68°F (20°C) or below. When the pre-heat control turns ON, the compressor is energized. (About 70 W)

#### Pre-heat control setting

<JK>

ON: To activate the pre-heat control, cut JK wire of the inverter P.C. board.

OFF: To deactivate the pre-heat control, solder JK wire of the inverter P.C. board.

(Refer to 11-6.1)

Jumper		Pre-heat control setting
JK	Soldered	Deactivated (Initial setting)
	Cut	Activated

**NOTE:** When the inverter P.C. board is replaced, check the jumper wires, and cut/solder them if necessary.

**MUZ-GX09NL**    **MUZ-GX12NL**    **MUZ-GX15NL**  
**MUZ-GX18NL**    **MUZ-GX24NL**    **MUZ-GX30NL**    **MUZ-GX36NL**  
**MUY-GX09NL**    **MUY-GX12NL**    **MUY-GX15NL**  
**MUY-GX18NL**    **MUY-GX24NL**    **MUY-GX30NL**    **MUY-GX36NL**  
**MUZ-GX09NLHZ**    **MUZ-GX12NLHZ**    **MUZ-GX15NLHZ**  
**MUZ-GX18NLHZ**    **MUZ-GX24NLHZ**

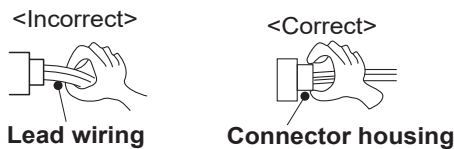
### 11-1. CAUTIONS ON TROUBLESHOOTING

#### 1. Before troubleshooting, check the following

- 1) Check the power supply voltage.
- 2) Check the indoor/outdoor connecting wire for miswiring.

#### 2. Take care of the following during servicing

- 1) Before servicing the air conditioner, be sure to turn OFF the main unit first with the remote controller, then after confirming the horizontal vane is closed, turn off the breaker and/or disconnect the power plug.
- 2) Be sure to turn OFF the power supply before removing the front panel, the cabinet, the top panel, and the electronic control P.C. board.
- 3) When removing the electrical parts, be careful of the residual voltage of smoothing capacitor.
- 4) When removing the electronic control P.C. board, hold the edge of the board with care NOT to apply stress on the components.
- 5) When connecting or disconnecting the connectors, hold the connector housing. DO NOT pull the lead wires.



#### 3. Troubleshooting procedure

- 1) Check if the OPERATION INDICATOR lamp on the indoor unit is blinking on and off to indicate an abnormality. To make sure, check how many times the OPERATION INDICATOR lamp is blinking on and off before starting service work.
- 2) Before servicing, verify that all connectors and terminals are connected properly.
- 3) When the electronic control P.C. board seems to be defective, check for disconnection of the copper foil pattern and burnt or discolored components.
- 4) Refer to 11-2 and 11-3.

## 11-2. FAILURE MODE RECALL FUNCTION AND ERROR CODE DISPLAY MODE

### Outline of the function

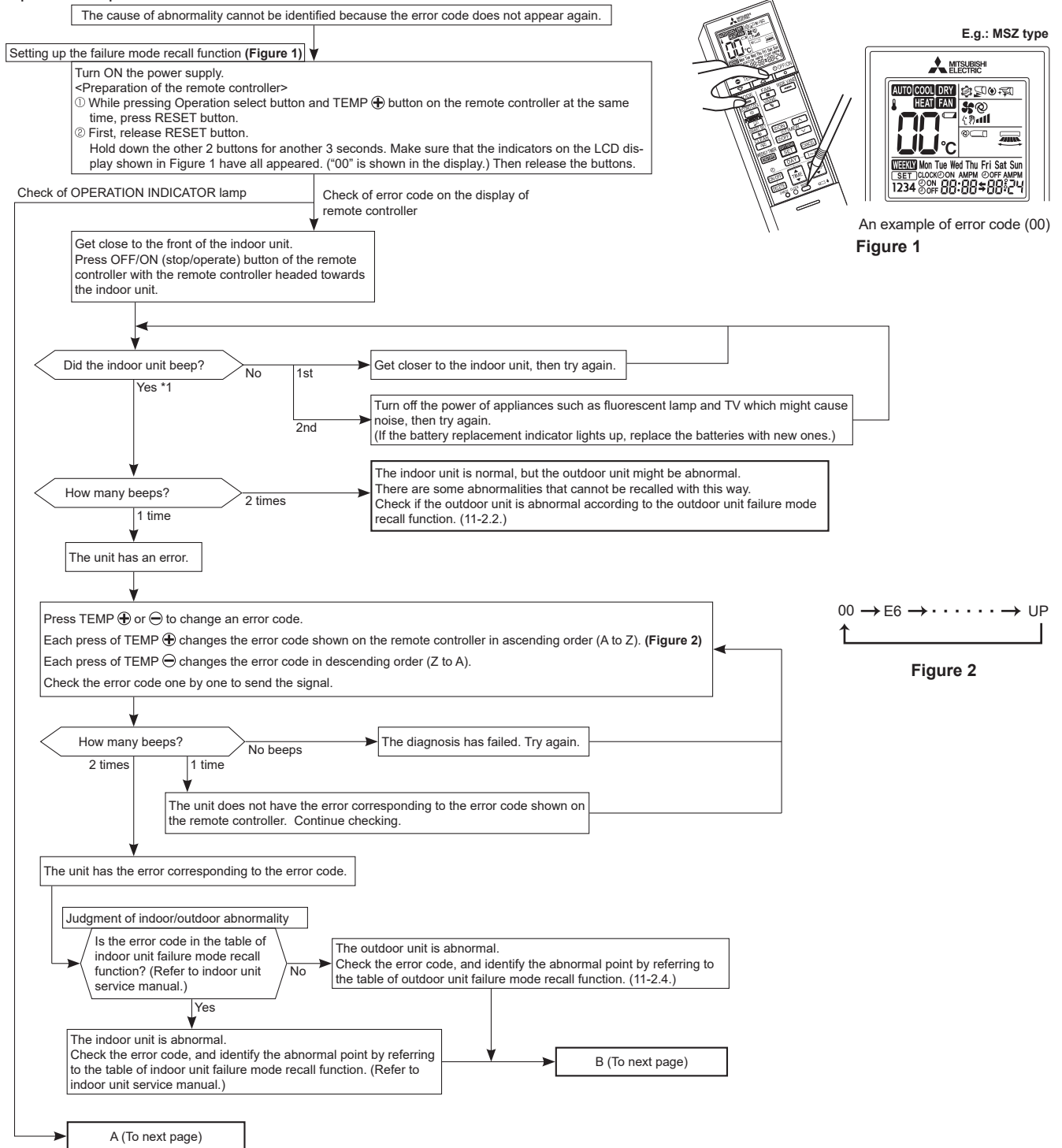
This air conditioner can memorize the failure which has occurred last time.

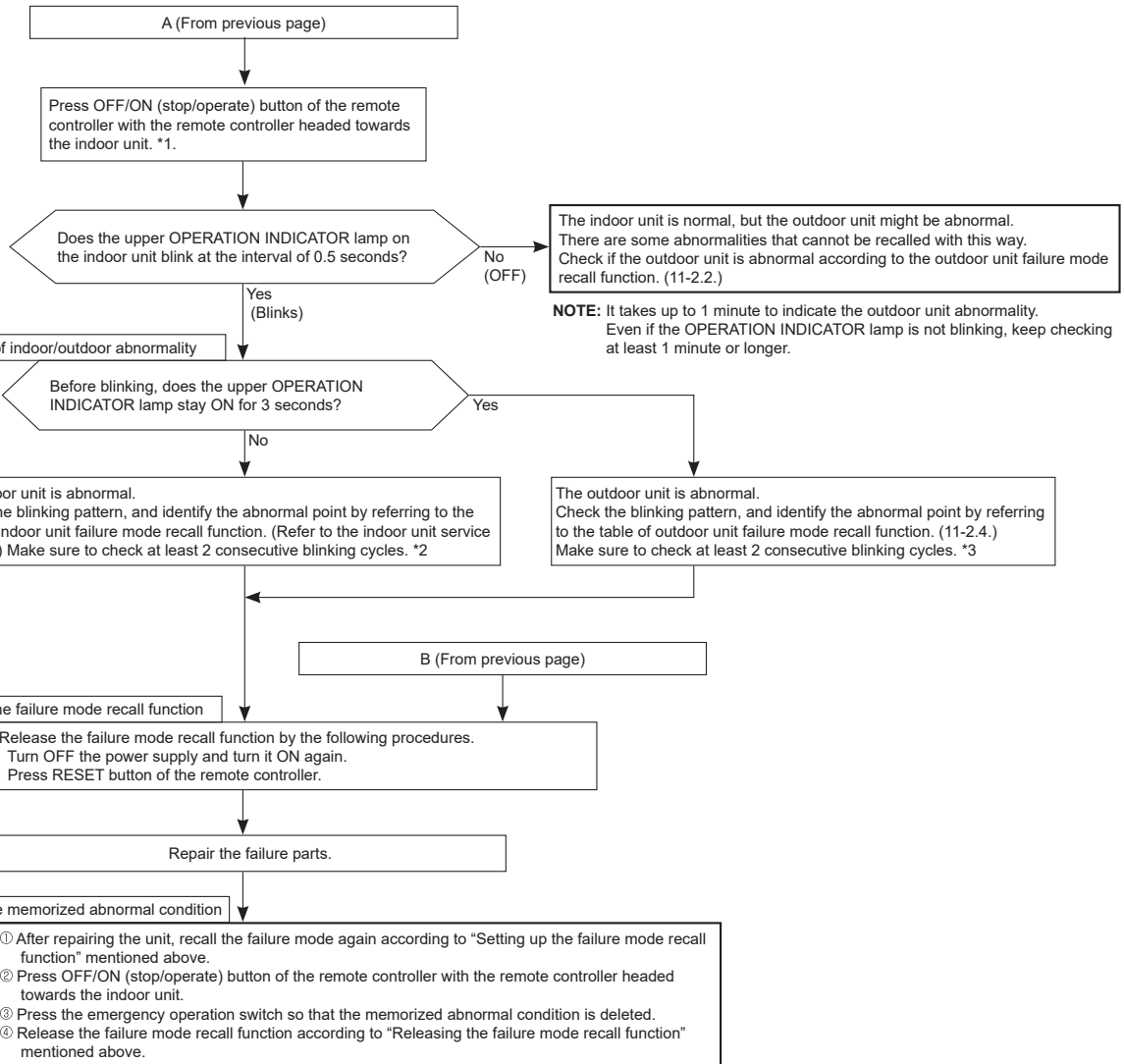
Even though LED indication listed on the troubleshooting check table (11-3.) disappears, the memorized failure can be recalled.

Also, error code can be checked on the display of remote controller while the upper operation indicator lamp on the indoor unit is blinking.

### 1. Flow chart of failure mode recall function for the indoor/outdoor unit

#### Operational procedure



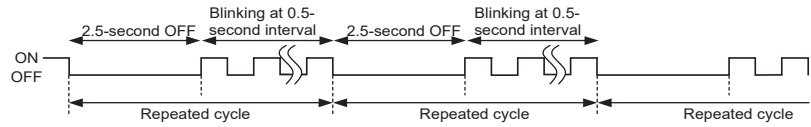


The indoor unit is normal, but the outdoor unit might be abnormal. There are some abnormalities that cannot be recalled with this way. Check if the outdoor unit is abnormal according to the outdoor unit failure mode recall function. (11-2.2.)

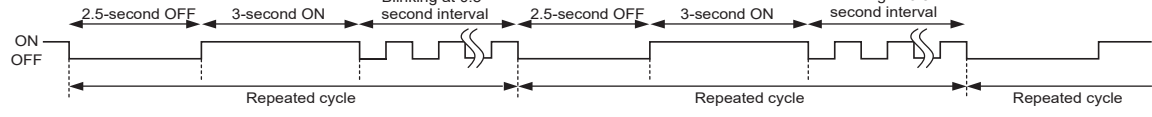
**NOTE:** It takes up to 1 minute to indicate the outdoor unit abnormality. Even if the OPERATION INDICATOR lamp is not blinking, keep checking at least 1 minute or longer.

**NOTE:** 1. Make sure to release the failure mode recall function after it is set up, otherwise the unit cannot operate properly.  
 2. If the abnormal condition is not deleted from the memory, the last abnormal condition is kept memorized.

\*1. Regardless of normal or abnormal condition, 2 short beeps are emitted once the signal is received.  
 \*2. Blinking pattern when the indoor unit is abnormal:



\*3. Blinking pattern when the outdoor unit is abnormal:





## 2. Flow chart of the outdoor unit failure mode recall function

### Operational procedure

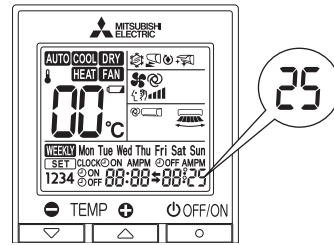
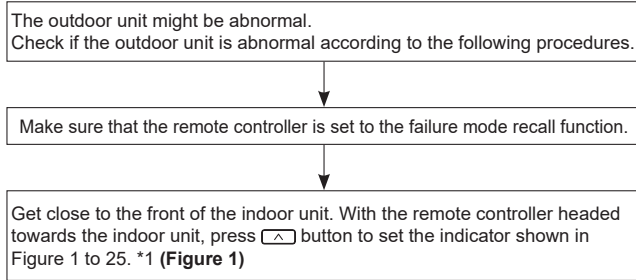
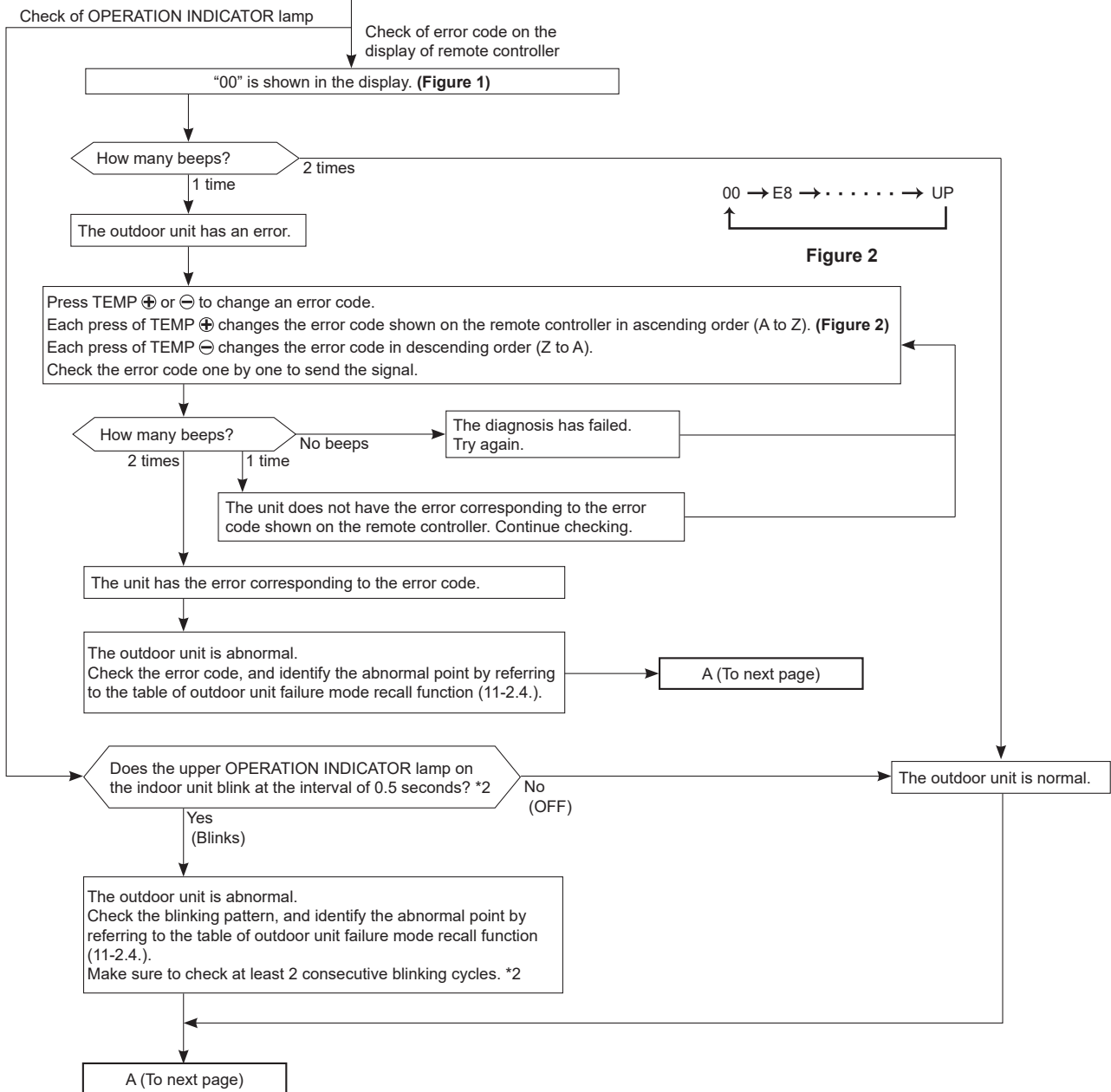
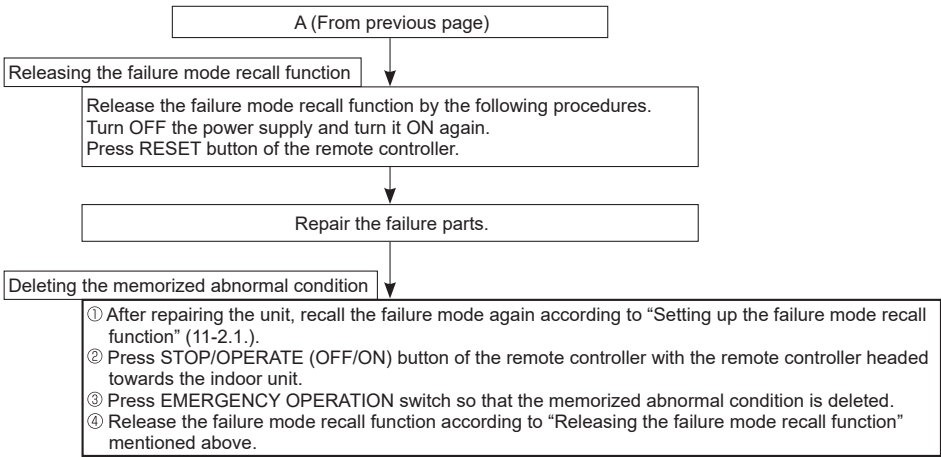
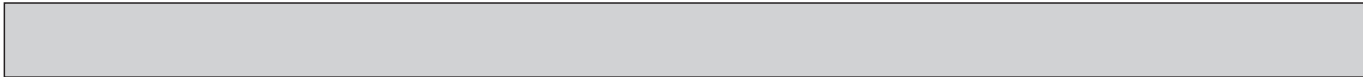


Figure 1

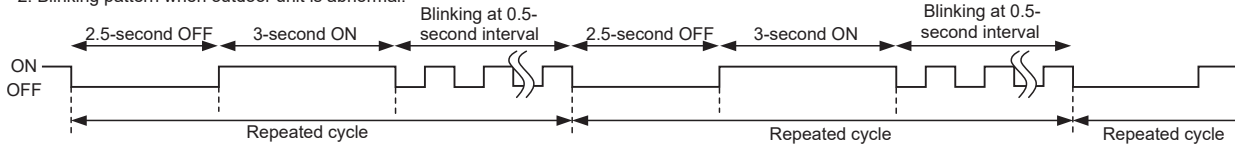




**NOTE:** 1. Make sure to release the failure mode recall function after it is set up, otherwise the unit cannot operate properly.  
2. If the abnormal condition is not deleted from the memory, the last abnormal condition is kept memorized.

\*1. Regardless of normal or abnormal condition, 2 short beeps are emitted once the signal is received.

\*2. Blinking pattern when outdoor unit is abnormal:



### 3. Flow chart of error code display mode

This explains how customers can check the error code on their own.  
This is included in OPERATING INSTRUCTIONS.

#### Operational procedure

The remote controller is powered OFF.

Get close to the front of the indoor unit. Point the remote controller at the receiving section of the indoor unit, and keep pressing CHECK with a fine-tipped object until the beeps. (Figure 1)  
"00" is shown in the display. (Figure 2)

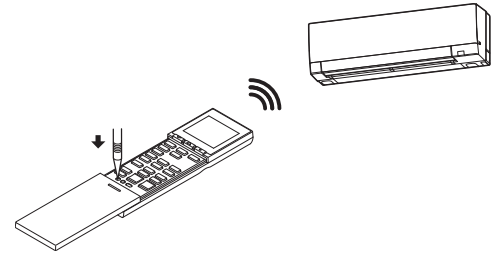


Figure 1

Did the indoor unit beep?

No

1st

Get closer to the indoor unit, then try again.

2nd

Turn off the power of appliances such as fluorescent lamp and TV which might cause noise, then try again.  
(If the battery replacement indicator lights up, replace the batteries with new ones.)

Yes

How many beeps?

2 times

The indoor unit is normal, but the outdoor unit might be abnormal. There are some abnormalities that cannot be recalled with this way. Check if the outdoor unit is abnormal according to the outdoor unit failure mode recall function. (11-2.2.)

1 time

The unit has an error.

Press TEMP ⊕ or ⊖ to change an error code.  
Each press of TEMP ⊕ changes the error code shown on the remote controller in ascending order (A to Z). (Figure 3)  
Each press of TEMP ⊖ changes the error code in descending order (Z to A).  
Check the error code one by one to send the signal.

How many beeps?

No beeps

The diagnosis has failed. Try again.

2 times

1 time

The unit does not have the error corresponding to the error code shown on the remote controller. Continue checking.

The unit has the error corresponding to the error code.

Refer to the error code on the table of indoor unit failure mode recall function (refer to indoor unit service manual) or the table of outdoor unit failure mode recall function (11-2.4).

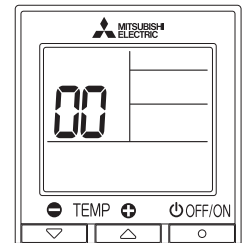


Figure 2

NOTE: Even though the air conditioner operates normally, the memorized indication for the last error appears if it has not been deleted.

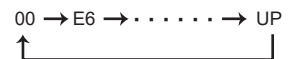
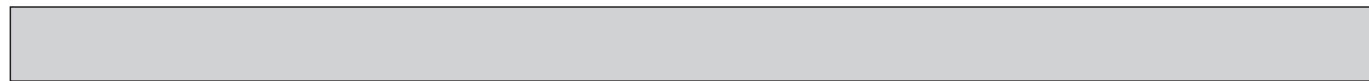


Figure 3



#### 4. Table of outdoor unit failure mode recall function

OPERATION INDICATOR lamp (Indoor unit)	Error code	Abnormal point (Failure mode/protection)	LED indication (Outdoor P.C. board)	Condition	Remedy	Indoor/outdoor unit failure mode recall function	Outdoor unit failure mode recall function
Not blink	00	None (Normal)	—	—	—	—	—
1-time blink 2.5 seconds OFF	E8	Indoor/outdoor communication, receiving error	—	Any signals from the inverter P.C. board cannot be received normally for 3 minutes.	• Refer to 11-5.Ⓜ “How to check miswiring and serial signal error”.	○	○
	E9	Indoor/outdoor communication, receiving error	—	Although the inverter P.C. board sends signal “0”, signal “1” has been received 30 consecutive times.	• Refer to 11-5.Ⓜ “How to check miswiring and serial signal error”.		
	EC	Indoor/outdoor communication, start-up process abnormality	—	The start-up process of the outdoor unit does not complete for 4 minutes.	• Replace the indoor electronic control P.C. board.		
2-time blink 2.5 seconds OFF	UP	Outdoor power system	—	Overcurrent protection cut-out operates 3 consecutive times within 1 minute after the compressor gets started.	• Reconnect connectors. • Refer to 11-5.Ⓜ “How to check inverter/compressor”. • Check stop valve.	○	○
3-time blink 2.5 seconds OFF	U3	Discharge temperature thermistor	1-time blink every 2.5 seconds	Thermistor shorts or opens during compressor running.	• Refer to 11-5.Ⓜ “Check of outdoor thermistors”. Defective outdoor thermistors can be identified by checking the blinking pattern of LED.  • Replace the inverter P.C. board.	○	○
		Defrost thermistor	—				
	U4	Ambient temperature	2-time blink 2.5 seconds OFF				
		Fin temperature thermistor	3-time blink 2.5 seconds OFF				
		Outdoor heat exchanger temperature thermistor	—				
P.C. board temperature thermistor	4-time blink 2.5 seconds OFF						
4-time blink 2.5 seconds OFF	UF	Overcurrent	11-time blink 2.5 seconds OFF	Large current flows into power module (IC700).	• Reconnect compressor connector. • Refer to 11-5.Ⓜ “How to check inverter/compressor”. • Check stop valve.	—	○
		Compressor synchronous abnormality	12-time blink 2.5 seconds OFF	Waveform of compressor current is distorted.	• Reconnect compressor connector.	—	○
		Compressor start-up failure protection	13-time blink 2.5 seconds OFF	Overcurrent cutoff within 10 seconds after activating the compressor.	• Refer to 11-5.Ⓜ “How to check inverter/compressor”.	—	○
5-time blink 2.5 seconds OFF	U2	Discharge temperature	—	Temperature of discharge temperature thermistor exceeds 241°F (116°C), compressor stops. Compressor can restart if discharge temperature thermistor reads 212°F (100°C) or less 3 minutes later.	• Check refrigerant circuit and refrigerant amount. • Refer to 11-5.Ⓜ “Check of LEV”.	—	○
6-time blink 2.5 seconds OFF	Ud	High pressure	—	Temperature of outdoor heat exchanger temperature thermistor exceeds 158°F (70°C) in COOL mode.	• Check refrigerant circuit and refrigerant amount. • Check stop valve.	—	○
7-time blink 2.5 seconds OFF	U5	Fin temperature	7-time blink 2.5 seconds OFF	Temperature of fin temperature thermistor on the inverter P.C. board exceeds 167 – 176°F (75 – 80°C), or temperature of P.C. board temperature thermistor on the inverter P.C. board exceeds 158 – 167°F (70 – 75°C).	• Check around outdoor unit. • Check outdoor unit air passage. • Refer to 11-5.Ⓜ “Check of outdoor fan motor”.	—	○
	Ub	P.C. board temperature					
8-time blink 2.5 seconds OFF	U8	Outdoor fan motor	—	Outdoor fan has stopped 3 times in a row within 30 seconds after outdoor fan start-up.	• Refer to 11-5.Ⓜ “Check of outdoor fan motor”. Refer to 11-5.Ⓜ “Check of inverter P.C. board”.	—	○

**NOTE:** Blinking patterns of this mode differ from the ones of TROUBLESHOOTING CHECK TABLE (11-3.).

**NOTE:** Blinking patterns of this mode differ from the ones of TROUBLESHOOTING CHECK TABLE (11-3.).

OPERATION INDICATOR lamp (Indoor unit)	Error code	Abnormal point (Failure mode/protection)	LED indication (Outdoor P.C. board)	Condition	Remedy	Indoor/outdoor unit failure mode recall function	Outdoor unit failure mode recall function
9-time blink 2.5 seconds OFF	FC	Nonvolatile memory data	5-time blink 2.5 seconds OFF	Nonvolatile memory data cannot be read properly.	• Replace the inverter P.C. board.	○	○
	U6	Power module (IC700)	6-time blink 2.5 seconds OFF	The interface short circuit occurs in the output of the power module (IC700). The compressor winding shorts circuit.	• Refer to 11-5.Ⓐ "How to check inverter/compressor".	—	○
10-time blink 2.5 seconds OFF	U7	Discharge temperature	—	Temperature of discharge temperature thermistor has been 122°F (50°C) or less for 20 minutes.	• Refer to 11-5.Ⓢ "Check of LEV". • Check refrigerant circuit and refrigerant amount.	—	○
11-time blink 2.5 seconds OFF	UJ	Bus-bar voltage (DC)	8-time blink 2.5 seconds OFF	Bus-bar voltage of inverter cannot be detected normally.	• Refer to 11-5.Ⓐ "How to check inverter/compressor".	—	○
	UH	Each phase current of compressor	9-time blink 2.5 seconds OFF	Each phase current of compressor cannot be detected normally.			
13-time blink 2.5 seconds OFF	Fd	Abnormal of wrong voltage power supply connected.	—	When 100 V power supply is connected to 200 V model.	• Check power supply voltage	○	○
14-time blink 2.5 seconds OFF *1	UE	Stop valve (Closed valve)	14-time blink 2.5 seconds OFF	<ul style="list-style-type: none"> <li>• Closed valve is detected by compressor current.</li> <li>• An abnormality of the indoor thermistors is detected.</li> </ul>	<ul style="list-style-type: none"> <li>• Check stop valve.</li> <li>• Refer to "TEST POINT DIAGRAM AND VOLTAGE" on the service manual of indoor unit for the characteristics of the thermistors. (Do not start the operation again without repair to prevent hazards.)</li> </ul>	○	○
	P8	Pipe temperature	16-time blink 2.5 seconds OFF	<ul style="list-style-type: none"> <li>• The indoor coil thermistor detects an abnormal temperature.</li> <li>• An abnormality of the indoor thermistors is detected.</li> </ul>	<ul style="list-style-type: none"> <li>• Replace the inverter P.C. board.</li> <li>• Refer to "TEST POINT DIAGRAM AND VOLTAGE" on the service manual of indoor unit for the characteristics of the thermistors. (Do not start the operation again without repair to prevent hazards.)</li> </ul>	○	○
16-time blink 2.5 seconds OFF *1	PL	Outdoor refrigerant system abnormality	1-time blink 2.5 seconds OFF	<ul style="list-style-type: none"> <li>• A closed valve and air trapped in the refrigerant circuit are detected based on the temperature sensed by the indoor and outdoor thermistors and the current of the compressor.</li> <li>• An abnormality of the indoor thermistors is detected.</li> </ul>	<ul style="list-style-type: none"> <li>• Check for a gas leak in a connecting piping etc.</li> <li>• Check the stop valve.</li> <li>• Refer to 11-5.Ⓢ "Check of outdoor refrigerant circuit".</li> <li>• Refer to "TEST POINT DIAGRAM AND VOLTAGE" on the service manual of indoor unit for the characteristics of the thermistors. (Do not start the operation again without repair to prevent hazards.)</li> </ul>	○	○

\*1 There is a possibility that diesel explosion may occur due to the air mixed in the refrigerant circuit.

First, ensure that there are no leakage points on the valves, flare connections, etc. that allow the air to flow into the refrigerant circuit, or no blockage points (e.g. clogged or closed valves) in the refrigerant circuit that cause an increase in pressure.

If there is no abnormal point like above and the system operates cooling mode normally, the indoor thermistor might have a problem, resulting in false detection. Check both the indoor coil thermistor and the room temperature thermistor, and replace faulty thermistor(s), if any.

**NOTE:** Do not start the operation again without repair to prevent hazards.

### 11-3. TROUBLESHOOTING CHECK TABLE

No.	Symptom	LED indication	Abnormal point/ Condition	Condition	Remedy
1	Outdoor unit does not operate.	1-time blink every 2.5 seconds	Outdoor power system	Overcurrent protection cut-out operates 3 consecutive times within 1 minute after the compressor gets started.	<ul style="list-style-type: none"> <li>Reconnect connector of compressor.</li> <li>Refer to 11-5.⑧ "How to check inverter/compressor".</li> <li>Check stop valve.</li> </ul>
2			Outdoor thermistors	Discharge temperature thermistor, fin temperature thermistor, defrost thermistor, outdoor heat exchanger temperature thermistor or ambient temperature thermistor shorts or opens during compressor running.	<ul style="list-style-type: none"> <li>Refer to 11-5.⑧ "Check of outdoor thermistors".</li> </ul>
				P.C. board temperature thermistor shorts or opens during compressor running.	<ul style="list-style-type: none"> <li>Replace inverter P.C. board.</li> </ul>
3		Outdoor control system	Nonvolatile memory data cannot be read properly.  (The upper lamp of the OPERATION INDICATOR lamp on the indoor unit lights up or blinks 7-time.)	<ul style="list-style-type: none"> <li>Replace inverter P.C. board.</li> </ul>	
4		6-time blink 2.5 seconds OFF	Serial signal	The communication fails between the indoor and outdoor unit for 3 minutes.	<ul style="list-style-type: none"> <li>Refer to 11-5.⑩ "How to check miswiring and serial signal error".</li> </ul>
5		11-time blink 2.5 seconds OFF	Stop valve/ Closed valve	Closed valve is detected by compressor current.	<ul style="list-style-type: none"> <li>Check stop valve.</li> </ul>
6		16-time blink 2.5 seconds OFF	4-way valve/ Pipe temperature	The 4-way valve does not work properly. The indoor coil thermistor detects an abnormal temperature.	<ul style="list-style-type: none"> <li>Refer to 11-5.⑨ "Check of R.V. coil".</li> <li>Replace the inverter P.C. board.</li> </ul>
7	17-time blink 2.5 seconds OFF	Outdoor refrigerant system abnormality	A closed valve and air trapped in the refrigerant circuit are detected based on the temperature sensed by the indoor and outdoor thermistors and the current of the compressor.	<ul style="list-style-type: none"> <li>Check for a gas leak in a connecting piping etc.</li> <li>Check the stop valve.</li> <li>Refer to 11-5.⑨ "Check of outdoor refrigerant circuit".</li> </ul>	
8	'Outdoor unit stops and restarts 3 minutes later' is repeated.	2-time blink 2.5 seconds OFF	Overcurrent protection	Large current flows into the power module (IC700).	<ul style="list-style-type: none"> <li>Reconnect connector of compressor.</li> <li>Refer to 11-5.⑧ "How to check inverter/compressor".</li> <li>Check stop valve.</li> </ul>
9		3-time blink 2.5 seconds OFF	Discharge temperature overheat protection	Temperature of discharge temperature thermistor exceeds 241°F (116°C), compressor stops. Compressor can restart if discharge temperature thermistor reads 212°F (100°C) or less 3 minutes later.	<ul style="list-style-type: none"> <li>Check refrigerant circuit and refrigerant amount.</li> <li>Refer to 11-5.⑧ "Check of LEV".</li> </ul>
10		4-time blink 2.5 seconds OFF	Fin temperature /P.C. board temperature thermistor overheat protection	Temperature of the fin temperature thermistor on the heat sink exceeds 167 - 176°F (75 - 80°C) or temperature of P.C. board temperature thermistor on the inverter P.C. board exceeds 158 - 167°F (70 - 75°C).	<ul style="list-style-type: none"> <li>Check around outdoor unit.</li> <li>Check outdoor unit air passage.</li> <li>Refer to 11-5.⑩ "Check of outdoor fan motor".</li> </ul>
11		5-time blink 2.5 seconds OFF	High pressure protection	Indoor coil thermistor exceeds 158°F (70°C) in HEAT mode. Defrost thermistor exceeds 158°F (70°C) in COOL mode.	<ul style="list-style-type: none"> <li>Check refrigerant circuit and refrigerant amount.</li> <li>Check stop valve.</li> </ul>
12		8-time blink 2.5 seconds OFF	Compressor synchronous abnormality	The waveform of compressor current is distorted.	<ul style="list-style-type: none"> <li>Reconnect connector of compressor.</li> <li>Refer to 11-5.⑧ "How to check inverter/compressor".</li> </ul>
13		10-time blink 2.5 seconds OFF	Outdoor fan motor	Outdoor fan has stopped 3 times in a row within 30 seconds after outdoor fan startup.	<ul style="list-style-type: none"> <li>Refer to 11-5.⑩ "Check of outdoor fan motor".</li> <li>Refer to 11-5.⑩ "Check of inverter P.C. board".</li> </ul>
14		12-time blink 2.5 seconds OFF	Each phase current of compressor	Each phase current of compressor cannot be detected normally.	<ul style="list-style-type: none"> <li>Refer to 11-5.⑧ "How to check inverter/compressor".</li> </ul>
15		13-time blink 2.5 seconds OFF	Bus-bar voltage (DC)	Bus-bar voltage of inverter cannot be detected normally.	<ul style="list-style-type: none"> <li>It occurs with following case.</li> <li>Instantaneous power voltage drop. (Short time power failure)</li> <li>Refer to 11-5.⑩ "Check of power supply".</li> <li>Refer to 11-5.⑧ "How to check inverter/compressor".</li> </ul>

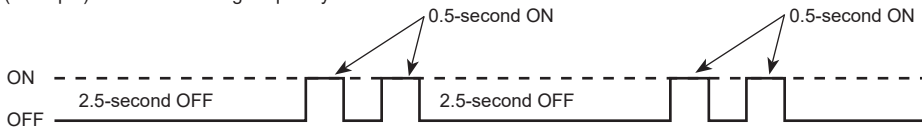
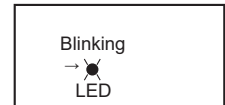


No.	Symptom	LED indication	Abnormal point/ Condition	Condition	Remedy
16	Outdoor unit operates.	1-time blink 2.5 seconds OFF	Deceleration of the operational frequency of the compressor by the current protection control	Current from power outlet is nearing breaker capacity.	The unit is normal, but check the following. • Check if indoor filters are clogged. • Check if refrigerant is short. • Check if indoor/outdoor unit air circulation is short cycled.
		3-time blink 2.5 seconds OFF	Deceleration of the operational frequency of the compressor by the high pressure protection	Temperature of indoor coil thermistor exceeds 131 °F (55°C) in HEAT mode, compressor frequency lowers.	
17		3-time blink 2.5 seconds OFF	Deceleration of the operational frequency of the compressor by the overcooling prevention of the indoor heat exchanger	Indoor coil thermistor reads 46°F (8°C) or less in COOL mode, compressor frequency lowers.	
18		4-time blink 2.5 seconds OFF	Deceleration of the operational frequency of the compressor by the discharge temperature protection	Temperature of discharge temperature thermistor exceeds 232°F (111°C), compressor frequency lowers.	• Check refrigerant circuit and refrigerant amount. • Refer to 11-5.Ⓢ “Check of LEV”. • Refer to 11-5.Ⓢ “Check of outdoor thermistors”.
19	Outdoor unit operates.	7-time blink 2.5 seconds OFF	Low discharge temperature protection	Temperature of discharge temperature thermistor has been 122°F (50°C) or less for 20 minutes.	• Refer to 11-5.Ⓢ “Check of LEV”. • Check refrigerant circuit and refrigerant amount.
20		8-time blink 2.5 seconds OFF	Zero cross detecting circuit	Zero cross signal cannot be detected.	• It occurs with following cases. 1 Instantaneous power voltage drop. (Short time power failure) 2 Distortion of primary voltage • Refer to 11-5.Ⓢ “Check of power supply”.
21		9-time blink 2.5 seconds OFF	Inverter check mode	The connector of compressor is disconnected, inverter check mode starts.	• Check if the connector of the compressor is correctly connected. Refer to 11-5.Ⓢ “How to check inverter/compressor”.

**NOTE:** 1. The location of LED is illustrated at the right figure. Refer to 11-6.1.  
2. LED is lit during normal operation.

Inverter P.C. board

The blinking frequency shows the number of times the LED blinks after every 2.5-second OFF.  
(Example) When the blinking frequency is “2”.



#### 11-4. TROUBLESHOOTING CRITERION OF MAIN PARTS

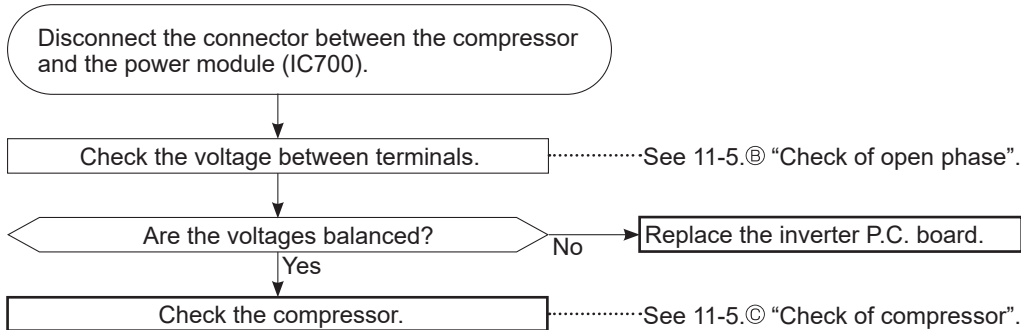
<b>MUZ-GX09NL</b>	<b>MUZ-GX12NL</b>	<b>MUZ-GX15NL</b>	
<b>MUZ-GX18NL</b>	<b>MUZ-GX24NL</b>	<b>MUZ-GX30NL</b>	<b>MUZ-GX36NL</b>
<b>MUY-GX09NL</b>	<b>MUY-GX12NL</b>	<b>MUY-GX15NL</b>	
<b>MUY-GX18NL</b>	<b>MUY-GX24NL</b>	<b>MUY-GX30NL</b>	<b>MUY-GX36NL</b>
<b>MUZ-GX09NLHZ</b>	<b>MUZ-GX12NLHZ</b>	<b>MUZ-GX15NLHZ</b>	
<b>MUZ-GX18NLHZ</b>	<b>MUZ-GX24NLHZ</b>		

Part name	Check method and criterion			Figure
Defrost thermistor (RT61) Fin temperature thermistor (RT64) Ambient temperature thermistor (RT65) Outdoor heat exchanger temperature thermistor (RT68)	Measure the resistance with a multimeter.  Refer to 11-6. "Test point diagram and voltage", 1. "Inverter P.C. board", for the chart of thermistor.			
Discharge temperature thermistor (RT62)	Measure the resistance with a multimeter. Before measurement, hold the thermistor with your hands to warm it up. Refer to 11-6. "Test point diagram and voltage", 1. "Inverter P.C. board", for the chart of thermistor.			
Compressor	Measure the resistance between terminals using a multimeter. [Temperature: 14 – 104°F (-10 – 40°C)]			
		Normal (Ω)		
		<b>MUZ-GX09/12NL</b> <b>MUY-GX09/12NL</b> <b>MUZ-GX09NLHZ</b>	<b>MUZ-GX15NL</b> <b>MUY-GX15NL</b> <b>MUZ-GX12/15NLHZ</b>	
	U-V U-W V-W	1.83 – 2.49	1.30 – 1.77	1.30 – 1.77
Outdoor fan motor	Measure the resistance between lead wires using a multimeter. [Temperature: 14 – 104°F (-10 – 40°C)]			
	Color of lead wire	Normal (Ω)		
	RED – BLK BLK – WHT WHT – RED	26 – 40	29 – 44	
R. V. coil (21S4)	Measure the resistance using a multimeter. [Temperature: 14 – 104°F (-10 – 40°C)]			
		Normal (kΩ)		
	<b>MUZ</b>			
	1.65 – 2.48			
Expansion valve coil (LEV)	Measure the resistance using a multimeter. [Temperature: 14 – 104°F (-10 – 40°C)]			
	Color of lead wire	Normal (Ω)		
	BRN – ORN	37 – 54		
	BRN – WHT			
	RED – BLU			
RED – YLW				
Defrost heater	Measure the resistance using a multimeter. [Temperature: 14 – 104°F (-10 – 40°C)]			
		Normal (Ω)		
		<b>MUZ-GX09/12/15NLHZ</b>	<b>MUZ-GX18/24NLHZ</b>	
	723 – 1,018	343 – 506		



## 11-5. TROUBLESHOOTING FLOW

### A How to check inverter/compressor



### B Check of open phase

- With the connector between the compressor and the power module (IC700) disconnected, activate the inverter and check if the inverter is normal by measuring the **voltage balance** between the terminals.

Output voltage is 50 – 130 V. (The voltage may differ according to the multimeter.)

<< Operation method >>

Start cooling or heating operation by pressing the emergency operation switch on the indoor unit. (TEST RUN OPERATION: Refer to 8-6.)

<< Measurement point >>

At 3 points \*Measure AC voltage between the lead wires at 3 points.

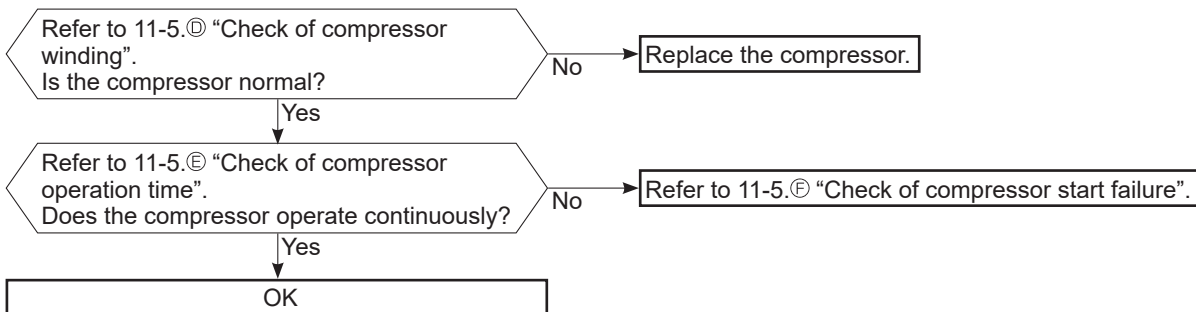
BLK (U)-WHT (V)

BLK (U)-RED (W)

WHT(V)-RED (W)

- NOTE:** 1. Output voltage varies according to power supply voltage.  
 2. Measure the voltage by analog type multimeter.  
 3. During this check, LED of the inverter P.C. board blinks 9 times. (Refer to 11-6.1.)

### C Check of compressor



### D Check of compressor winding

- Disconnect the connector between the compressor and the power module (IC700), and measure the resistance between the compressor terminals.

<<Measurement point>>

At 3 points \*Measure the resistance between the lead wires at 3 points.

BLK-WHT

BLK-RED

WHT-RED

<<Judgement>>

Refer to 11-4.

0 [Ω] .....Abnormal [short]

Infinite [Ω] .....Abnormal [open]

**NOTE:** Be sure to zero the ohmmeter before measurement.

### E Check of compressor operation time

- Connect the compressor and activate the inverter. Then measure the time until the inverter stops due to overcurrent.

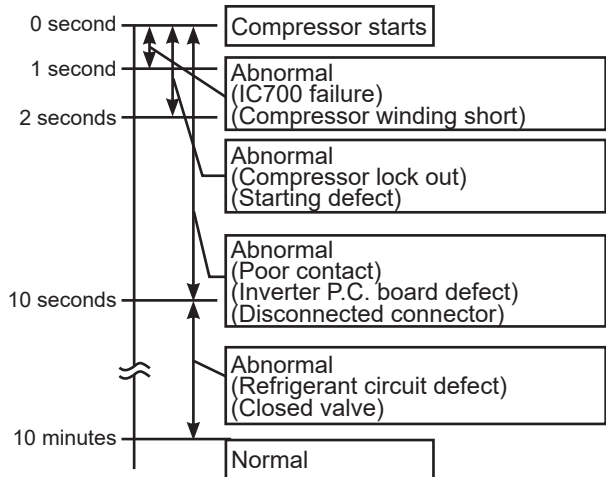
<<Operation method>>

Start heating or cooling operation by pressing the emergency operation switch on the indoor unit. (TEST RUN OPERATION: Refer to 8-6.)

<<Measurement>>

Measure the time from the start of compressor to the stop of compressor due to overcurrent.

<<Judgement>>



### F Check of compressor start failure

Confirm that ①~④ is normal.

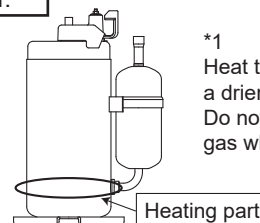
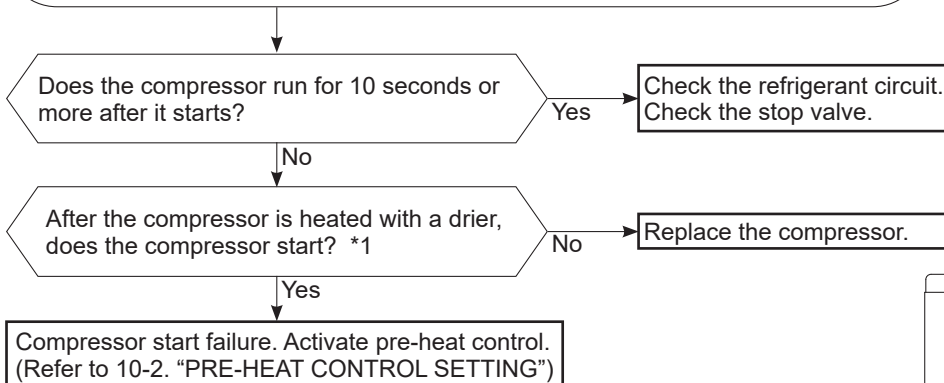
•Electrical circuit check

①. Contact of the compressor connector

②. Output voltage of inverter P.C. board and balance of them (See 11-5.③)

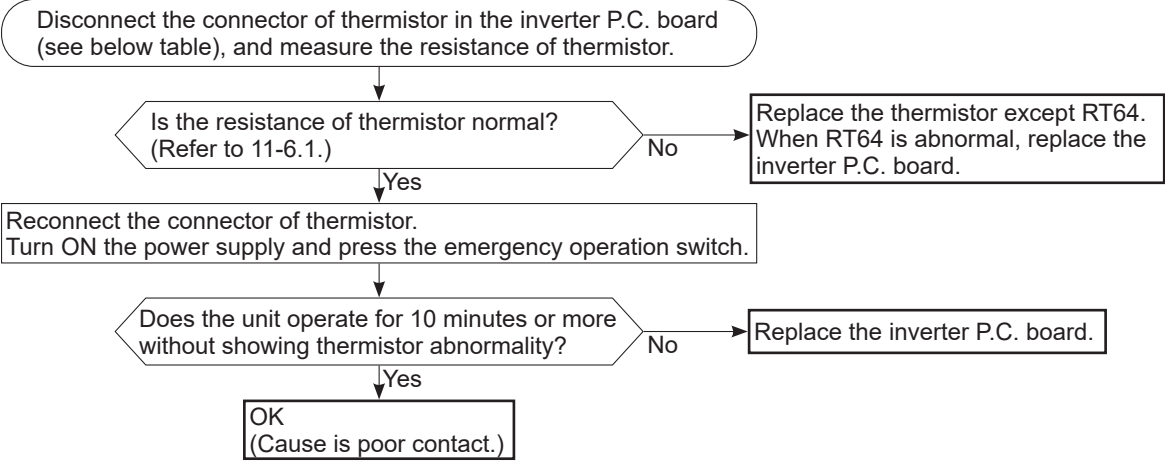
③. Direct current voltage between IC700(P) and (N) on the inverter P.C. board

④. Voltage between outdoor terminal block S1-S2



\*1 Heat the compressor with a drier for about 20 minutes. Do not recover refrigerant gas while heating.

**G Check of outdoor thermistors**



**MUZ-GX09/12/15, MUY-GX09/12/15**

Thermistor	Symbol	Connector, Pin No.	Board
Defrost ( <b>MUZ</b> )	RT61	Between CN641 pin1 and pin2	Inverter P.C. board
Discharge temperature	RT62	Between CN641 pin3 and pin4	
Fin temperature	RT64	Between CN642 pin1 and pin2	
Ambient temperature	RT65	Between CN643 pin1 and pin2	
Outdoor heat exchanger temperature	RT68	Between CN644 pin1 and pin3	

**MUZ-GX18/24/30/36, MUY-GX18/24/30/36**

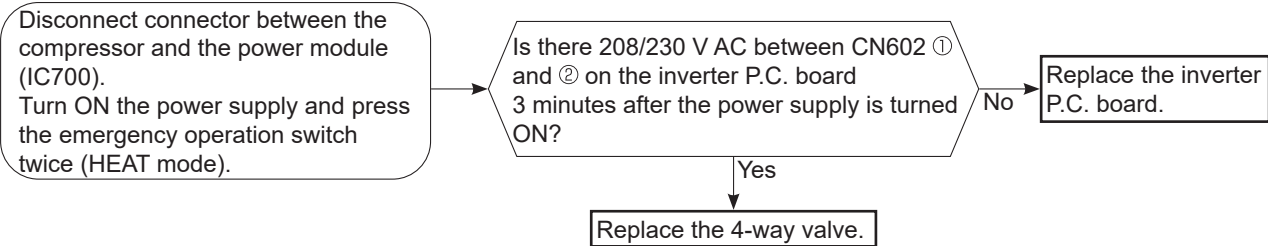
Thermistor	Symbol	Connector, Pin No.	Board
Defrost ( <b>MUZ</b> )	RT61	Between CN671 pin1 and pin2	Inverter P.C. board
Discharge temperature	RT62	Between CN671 pin3 and pin4	
Fin temperature	RT64	Between CN673 pin1 and pin2	
Ambient temperature	RT65	Between CN672 pin1 and pin2	
Outdoor heat exchanger temperature	RT68	Between CN671 pin5 and pin6	

## H Check of R.V. coil

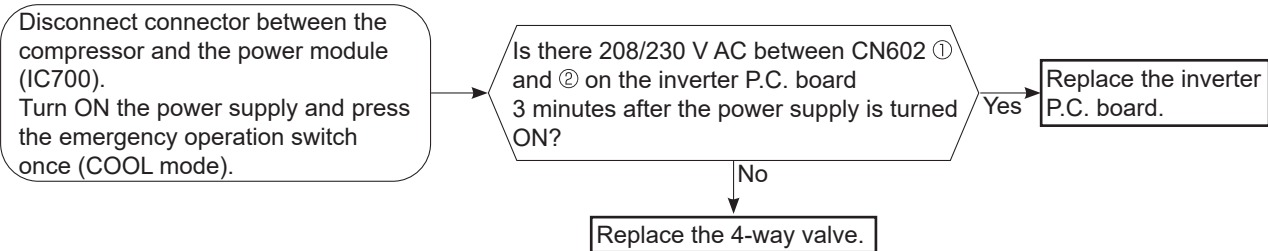
### MUZ-GX18/24/30/36

- \* First of all, measure the resistance of R.V. coil to check if the coil is defective. Refer to 11-4.
- \* In case CN602 is disconnected or R.V. coil is open, voltage is generated between the terminal pins of the connector although no signal is being transmitted to R.V. coil.  
Check if CN602 is connected.

#### Unit operates in COOL mode even if it is set to HEAT mode.



#### Unit operates in HEAT mode even if it is set to COOL mode.



### ① Check of outdoor fan motor

Disconnect the connectors CN931 and CN932 from the inverter P.C. board.  
Check the connection between the connector CN931 and CN932.

Is the resistance between each terminal of outdoor fan motor normal?  
(Refer to 11-4.)

Yes

Disconnect CN932 from the inverter P.C. board, and turn on the power supply.

Rotate the outdoor fan motor manually and measure the voltage of CN931.  
Between 1(+) and 5(-)  
Between 2(+) and 5(-)  
Between 3(+) and 5(-)

No

(Fixed to either 5 or 0 V DC)

Does the voltage between each terminal become 5 and 0 V DC repeatedly?

No

Yes

Does the outdoor fan motor rotate smoothly?

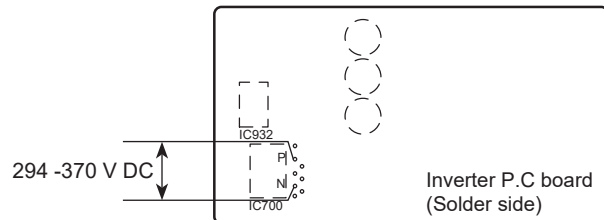
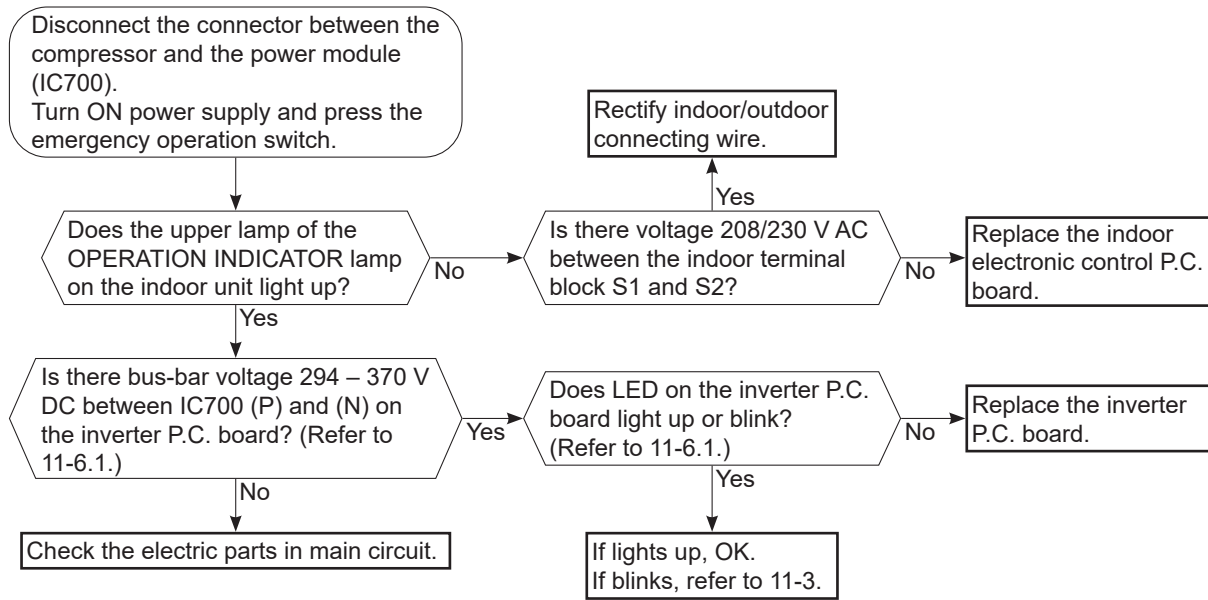
No

Yes

Replace the outdoor fan motor.

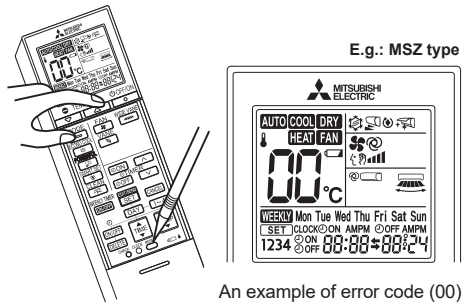
Replace the inverter P.C. board.

## ⓐ Check of power supply



## K Check of LEV (Expansion valve)

Turn ON the power supply.  
 <Preparation of the remote controller>  
 ① While pressing both Operation select button and TEMP + button on the remote controller at the same time, press RESET button.  
 ② First, release RESET button. Hold down the other 2 buttons for another 3 seconds. Make sure that the indicators on the LCD screen shown in the right figure are all displayed. **(Figure 1)** Then release the buttons.



E.g.: MSZ type  
 An example of error code (00)  
**Figure 1**

Press OFF/ON (stop/operate) button of the remote controller (the set temperature is displayed) with the remote controller headed towards the indoor unit. \*1

Expansion valve operates in full-opening direction.

Do you hear the expansion valve "click, click....."?  
 Do you feel the expansion valve vibrate when touching it?  
 Yes → OK

\*1. Regardless of normal or abnormal condition, a short beep is emitted once the signal is received.

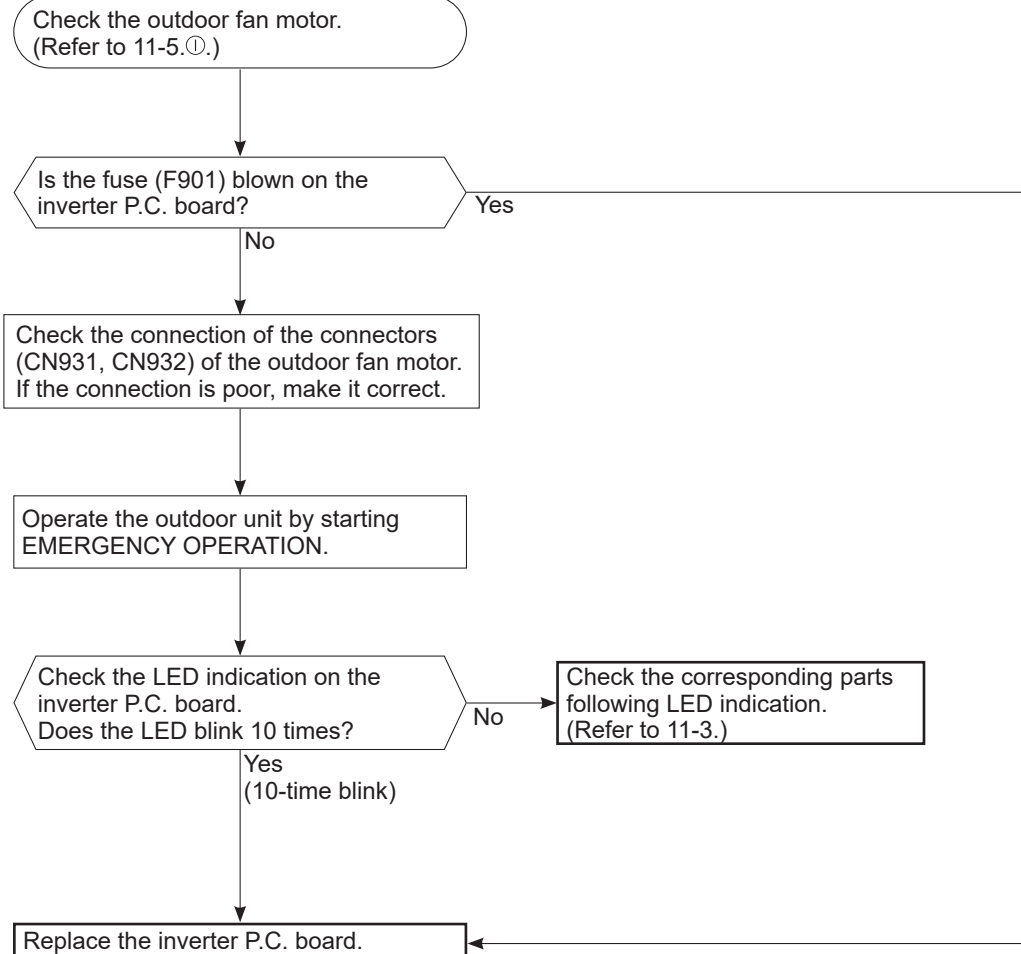
Is LEV coil properly fixed to the expansion valve?  
 No → Properly fix the LEV coil to the expansion valve.

Yes  
 Does the resistance of LEV coil have the characteristics? (Refer to 11-4.)  
 No → Replace the LEV coil.

Yes  
 Measure each voltage between connector pins of CN724 on the inverter P.C. board.  
 1. Pin③(-) — Pin①(+)  
 2. Pin④(-) — Pin①(+)  
 3. Pin⑤(-) — Pin①(+)  
 4. Pin⑥(-) — Pin①(+)  
 Is there about 3 – 5 V AC between each?  
**NOTE:** Measure the voltage by an analog multimeter.  
 No → Replace the inverter P.C. board.  
 Yes → Replace the expansion valve.

**NOTE:** After check of LEV, take the following steps.  
 1. Turn OFF the power supply and turn it ON again.  
 2. Press RESET button on the remote controller.

## Ⓛ Check of inverter P.C. board







## Ⓝ Check of defrost heater

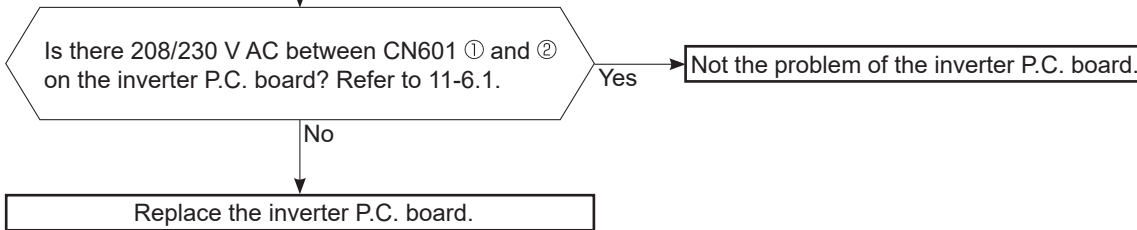
### MUZ-GX18NLHZ MUZ-GX24NLHZ

Check the following points before checking electric continuity.

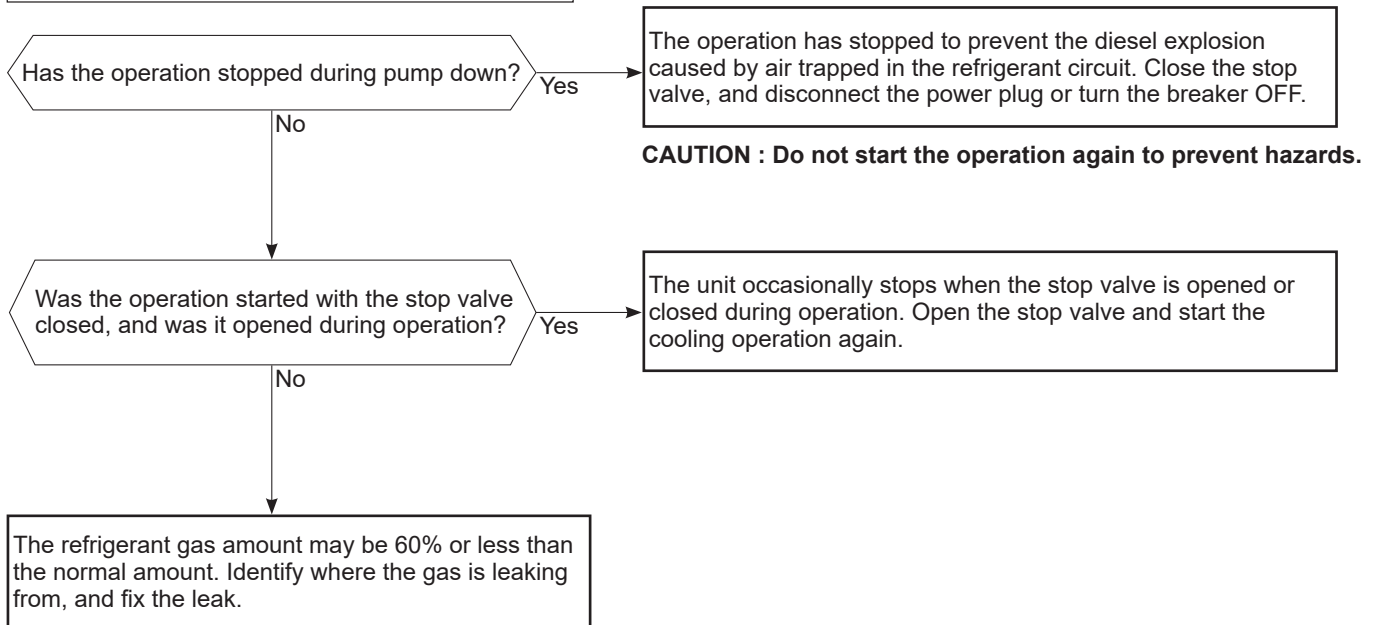
1. Does the resistance of ambient temperature thermistor have the characteristics? Refer to 11-6.1.
2. Is the resistance of defrost heater normal? Refer to 11-4.
3. Does the heater protector remain conducted (not open)?
4. Are both ambient temperature thermistor and circuit of defrost heater securely connected to connectors?

In HEAT mode, for more than 5 minutes, let the ambient temperature thermistor continue to read 32°F (0°C) or below, and let the defrost thermistor continue to read 30°F (-1°C) or below.

**NOTE:** In case both thermistors are more than the above temperature, cool them with cold water etc.

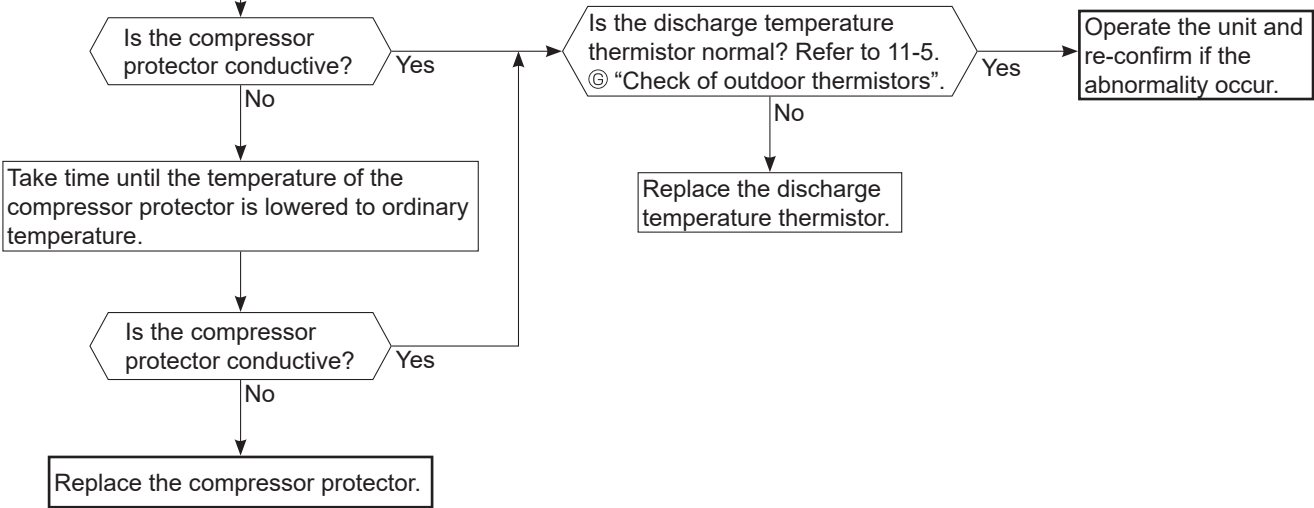


## Ⓞ Check of outdoor refrigerant circuit

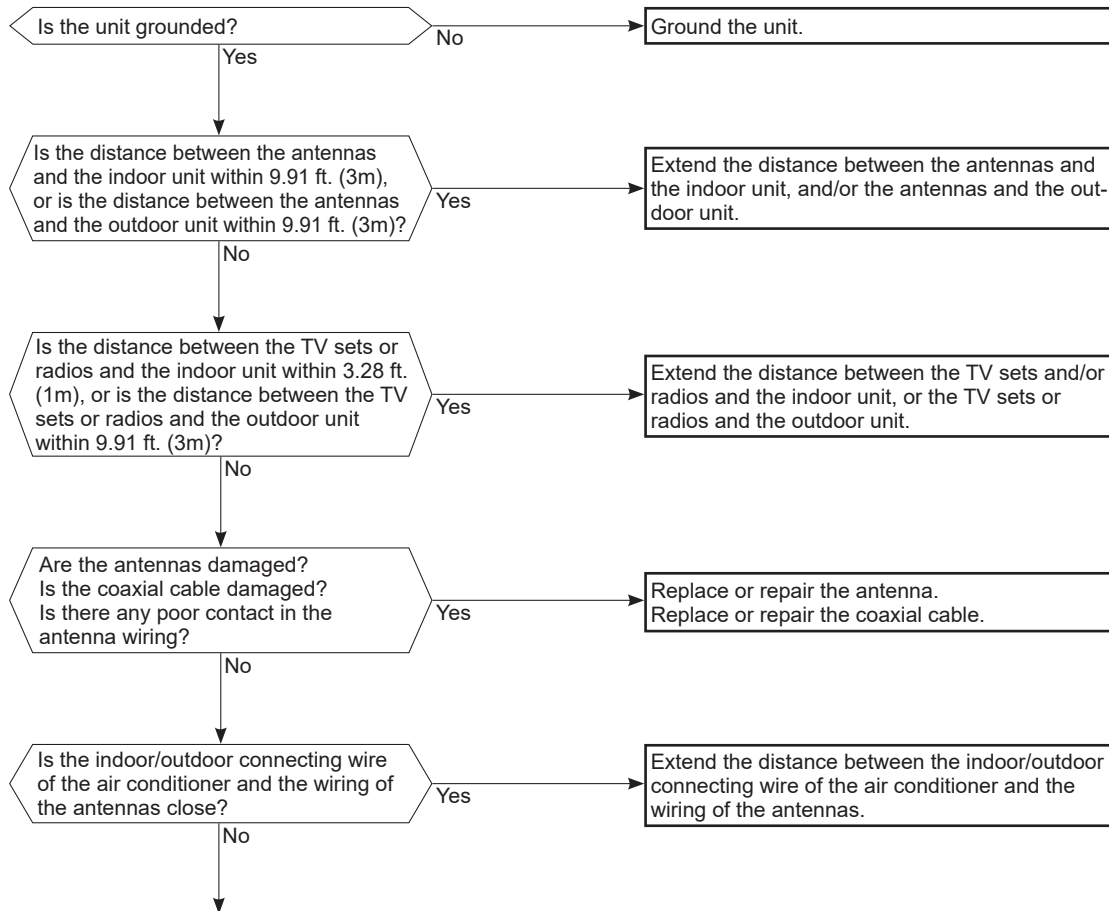


**P Check of compressor protector**

Disconnect the connector of compressor protector in the inverter P.C. board, and check the conduction of compressor protector.



## Q Electromagnetic noise enters into TV sets or radios



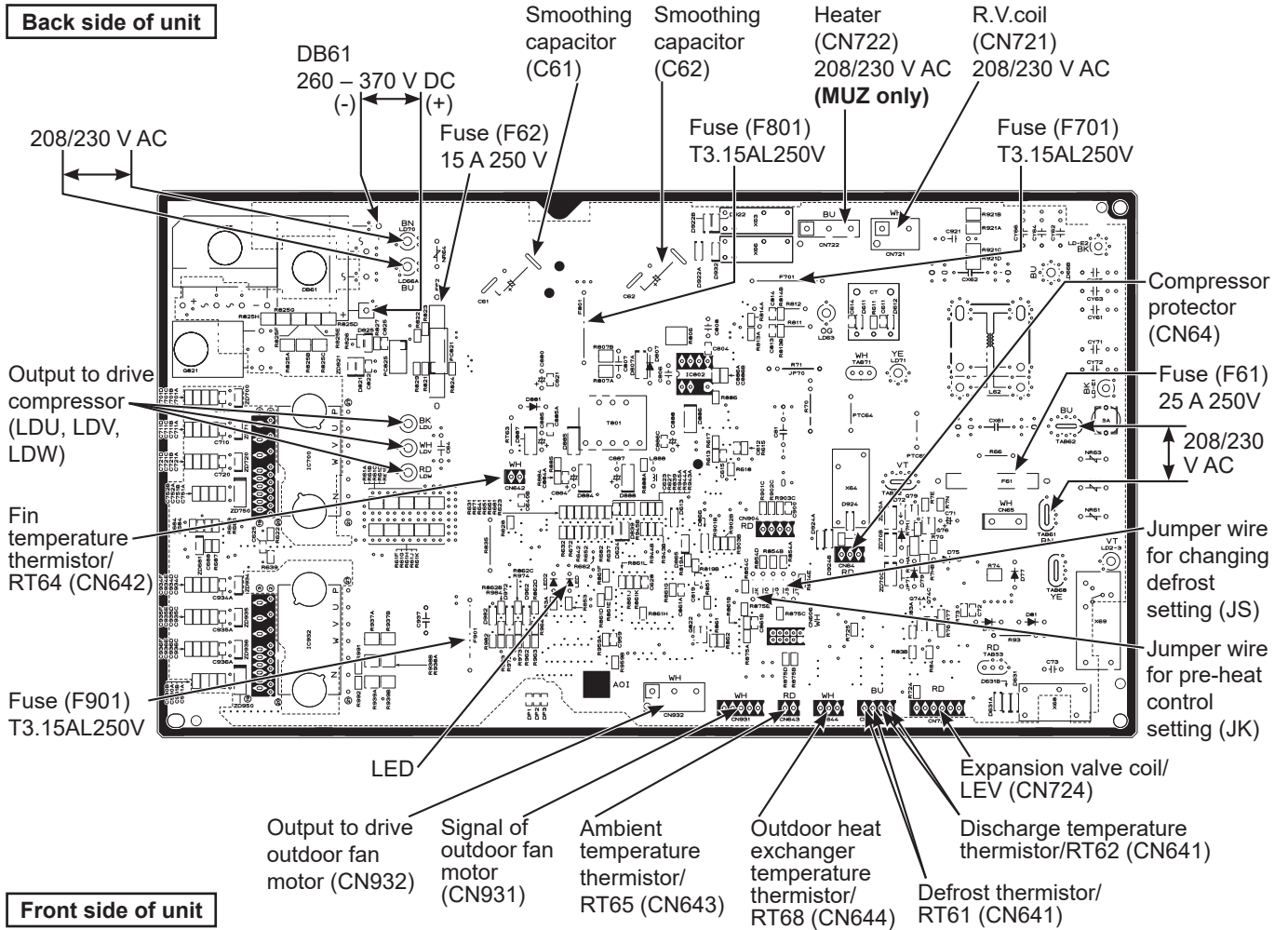
Even if all of the above conditions are fulfilled, the electromagnetic noise may enter, depending on the electric field strength or the installation condition (combination of specific conditions such as antennas or wiring). Check the following before asking for service.

1. Devices affected by the electromagnetic noise  
TV sets, radios (FM/AM broadcast, shortwave)
2. Channel, frequency, broadcast station affected by the electromagnetic noise
3. Channel, frequency, broadcast station unaffected by the electromagnetic noise
4. Layout of:  
indoor/outdoor unit of the air conditioner, indoor/outdoor wiring, ground wire, antennas, wiring from antennas, receiver
5. Electric field intensity of the broadcast station affected by the electromagnetic noise
6. Presence or absence of amplifier such as booster
7. Operation condition of air conditioner when the electromagnetic noise enters in
  - 1) Turn OFF the power supply once, and then turn ON the power supply. In this situation, check for the electromagnetic noise.
  - 2) Within 3 minutes after turning ON the power supply, press OFF/ON (stop/operate) button on the remote controller for power ON, and check for the electromagnetic noise.
  - 3) After a short time (3 minutes later after turning ON), the outdoor unit starts running. During operation, check for the electromagnetic noise.
  - 4) Press OFF/ON (stop/operate) button on the remote controller for power OFF, when the outdoor unit stops but the indoor/outdoor communication still runs on. In this situation, check for the electromagnetic noise.

## 11-6. TEST POINT DIAGRAM AND VOLTAGE

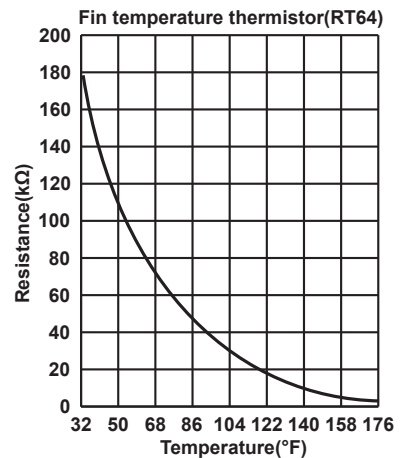
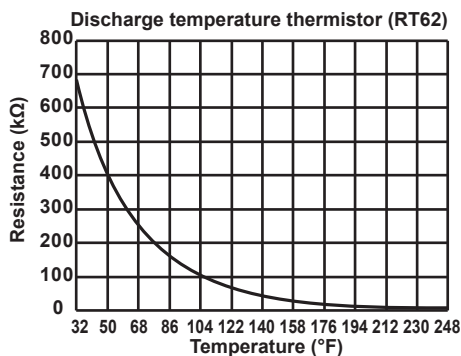
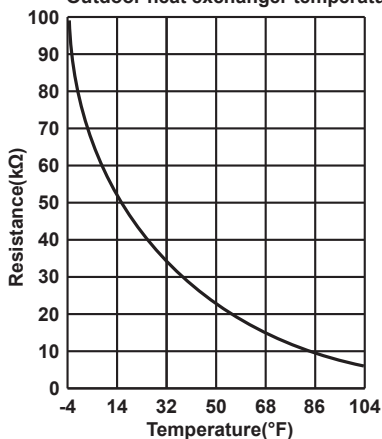
### 1. Inverter P.C. board

MUZ-GX09NL    MUZ-GX12NL    MUZ-GX15NL  
 MUY-GX09NL    MUY-GX12NL    MUY-GX15NL  
 MUZ-GX09NLHZ    MUZ-GX12NLHZ    MUZ-GX15NLHZ



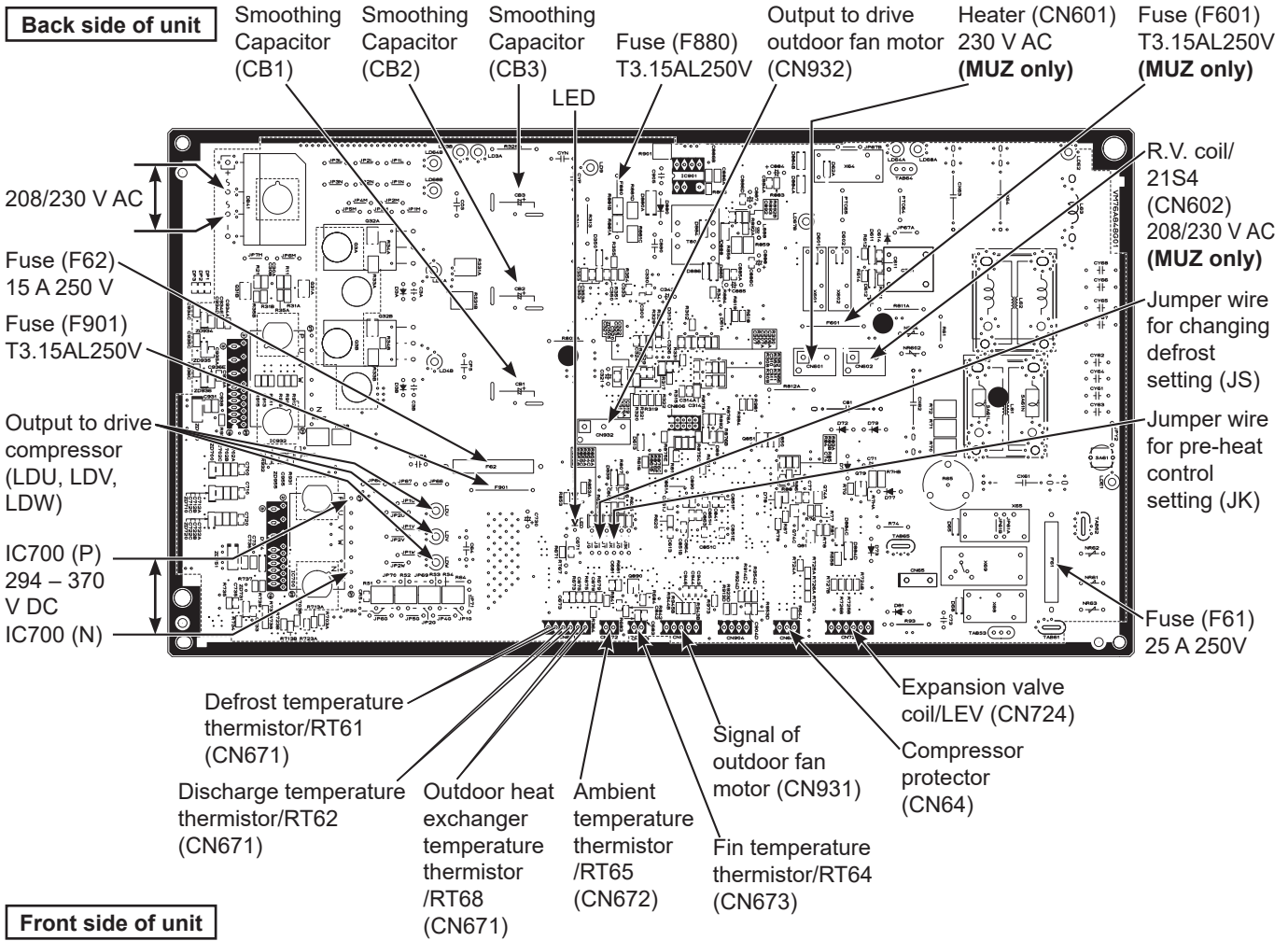
### Front side of unit

Defrost thermistor (RT61)  
 Ambient temperature thermistor (RT65)  
 Outdoor heat exchanger temperature thermistor (RT68)

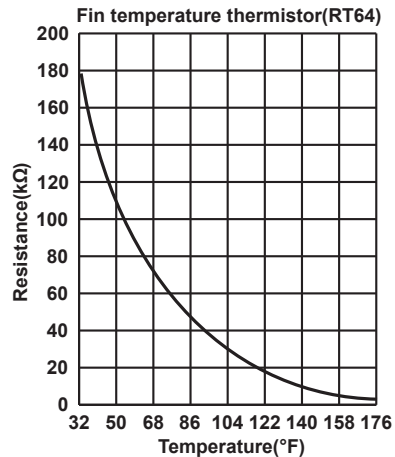
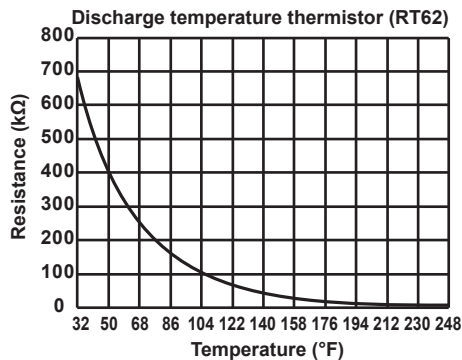
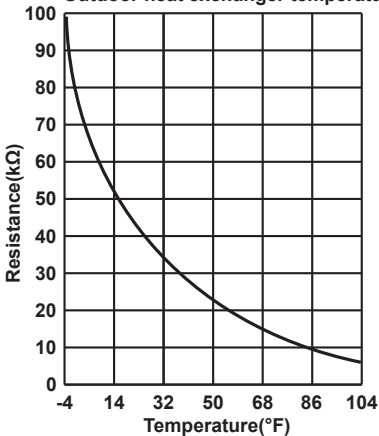


1. Inverter P.C. board

MUZ-GX18NL    MUZ-GX24NL    MUZ-GX30NL    MUZ-GX36NL  
 MUY-GX18NL    MUY-GX24NL    MUY-GX30NL    MUY-GX36NL  
 MUZ-GX18NLHZ    MUZ-GX24NLHZ

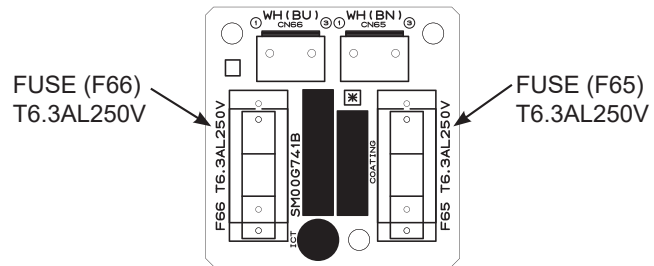


Defrost thermistor(RT61)  
 Ambient temperature thermistor(RT65)  
 Outdoor heat exchanger temperature thermistor(RT68)



2. Fuse P.C. board

MUZ-GX18NL	MUZ-GX24NL	MUZ-GX30NL	MUZ-GX36NL
MUY-GX18NL	MUY-GX24NL	MUY-GX30NL	MUY-GX36NL
MUZ-GX18NLHZ	MUZ-GX24NLHZ		



<Detaching method of the terminal with locking mechanism>

The terminal which has the locking mechanism can be detached as shown below.

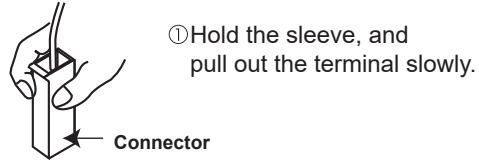
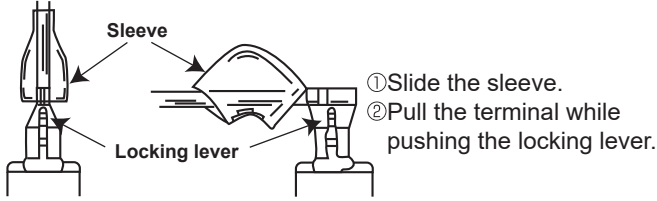
There are 2 types of the terminal with locking mechanism.

The terminal without locking mechanism can be detached by pulling it out.

Check the shape of the terminal before detaching.

(1) Slide the sleeve and check if there is a locking lever or not.

(2) The terminal with the connector shown below has the locking mechanism.



- 12-1. MUZ-GX09NL
- MUZ-GX12NL
- MUZ-GX15NL
- MUY-GX09NL
- MUY-GX12NL
- MUY-GX15NL
- MUZ-GX09NLHZ
- MUZ-GX12NLHZ
- MUZ-GX15NLHZ

**NOTE:** Turn OFF the power supply before disassembly.

—————▶: Indicates the visible parts in the photos/figures.  
- - - - -▶: Indicates the invisible parts in the photos/figures.

OPERATING PROCEDURE	PHOTOS/FIGURES
<p><b>1. Removing the cabinet</b></p> <ol style="list-style-type: none"> <li>(1) Remove the screws fixing the service panel.</li> <li>(2) Pull down the service panel and remove it.</li> <li>(3) Remove the screws fixing the conduit cover. (Photo 4)</li> <li>(4) Remove the conduit cover.</li> <li>(5) Remove the screw fixing the conduit plate. (Photo 5)</li> <li>(6) Remove the conduit plate.</li> <li>(7) Disconnect the power supply wire and indoor/outdoor connecting wire.</li> <li>(8) Remove the screws fixing the top panel.</li> <li>(9) Remove the top panel.</li> <li>(10) Remove the screws fixing the cabinet.</li> <li>(11) Remove the cabinet.</li> <li>(12) Remove the screws fixing the back panel. (Photo 5, 6)</li> <li>(13) Remove the back panel.</li> </ol> <p><b>NOTE:</b> If the red labels have been removed during the operation, put them back in the original position after the operation. Red labels indicate the use of flammable refrigerants. (Figure 1)</p>	<p><b>Photo 1</b></p>

**Photo 2**

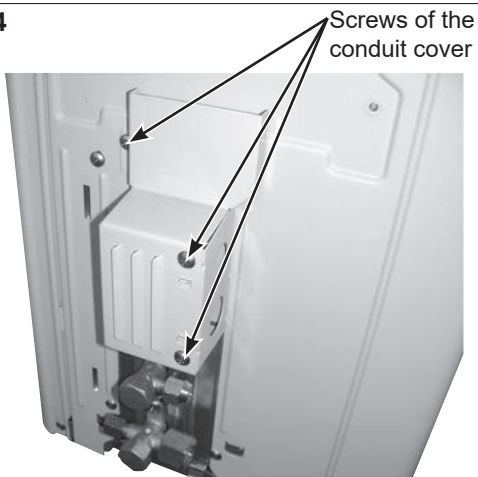
**Photo 3**

**Figure 1**



## OPERATING PROCEDURE

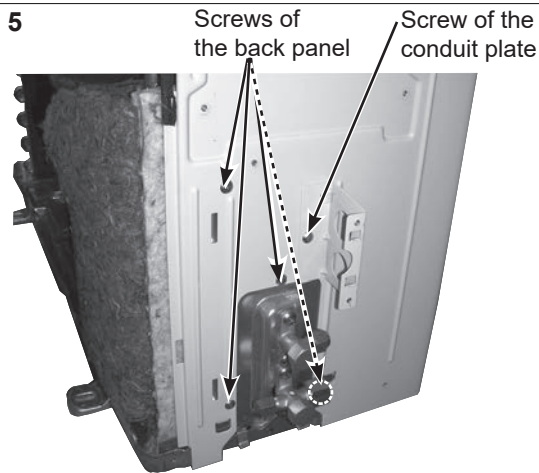
**Photo 4**



Screws of the conduit cover

## PHOTOS/FIGURES

**Photo 5**



Screws of the back panel

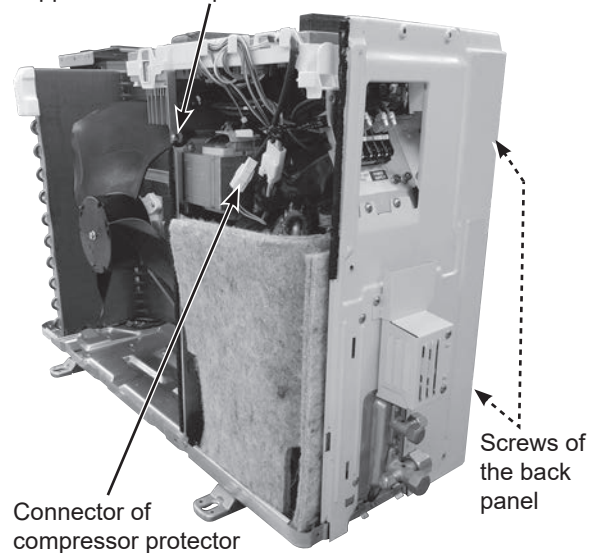
Screw of the conduit plate

### 2. Removing the inverter assembly, inverter P.C. board

- (1) Remove the top panel, cabinet and service panel. (Refer to section 1.)
- (2) Disconnect the lead wire to the reactor and the following connectors:  
<Inverter P.C. board>  
CN721 (R.V. coil)  
CN722 (Defrost heater and heater protector)  
**(NLHZ only)**  
CN931, CN932 (Fan motor)  
CN641 (Defrost thermistor and discharge temperature thermistor)  
CN643 (Ambient temperature thermistor)  
CN644 (Outdoor heat exchanger temperature thermistor)  
CN724 (Expansion valve coil)  
CN64 (Compressor protector)
- (3) Remove the compressor connector (CN61).
- (4) Remove the screws fixing the heat sink support and the separator.
- (5) Remove the fixing screws of the terminal block support and the back panel.
- (6) Remove the inverter assembly.
- (7) Remove the screws of the ground wires and the terminal block support. (Photo 8)
- (8) Remove the heat sink support from the P.C. board support.
- (9) Remove the inverter P.C. board from the P.C. board support.

**Photo 6**

Screw of the heat sink support and the separator

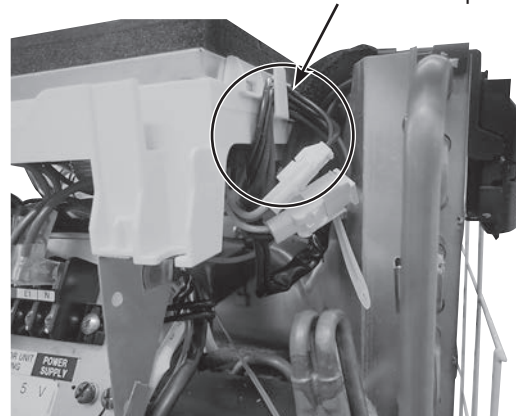


Connector of compressor protector

Screws of the back panel

**Photo 7 (NLHZ only)**

Lead wires of the defrost heater and the heater protector

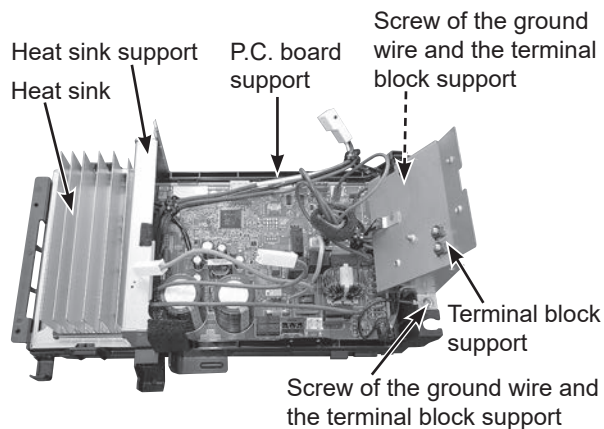


## OPERATING PROCEDURE

### \* Connection procedure when attaching the inverter P.C. board (Photo 9)

1. Connect the lead wires of the fan motor (Power) and ambient temperature thermistor (**NLHZ only**) to the connector on the inverter P.C. board. Pull the lead wires toward you and put them on the left hook on the P.C. board support.
2. Connect the lead wires of the fan motor (Signal) to the connector on the inverter P.C. board. Pull the lead wires toward you and put them on the middle of the hook on the P.C. board support.
3. Connect the lead wires of the outdoor heat exchanger temperature thermistor to the connector on the inverter P.C. board. Pull the lead wires toward you and put them on the right hook on the P.C. board support.
4. Connect the lead wires of the expansion valve coil to the connector on the inverter P.C. board. Pull the lead wires toward you and put them on the right hook on the P.C. board support [so that the compressor protector lead wires are bundled up as shown in Photo 9 (**GX12NLHZ, GX15 only**)].
5. Put the lead wires of the defrost heater and the heater protector on the hook. (Photo 7) (**NLHZ only**)

### Photo 8 (Inverter assembly)



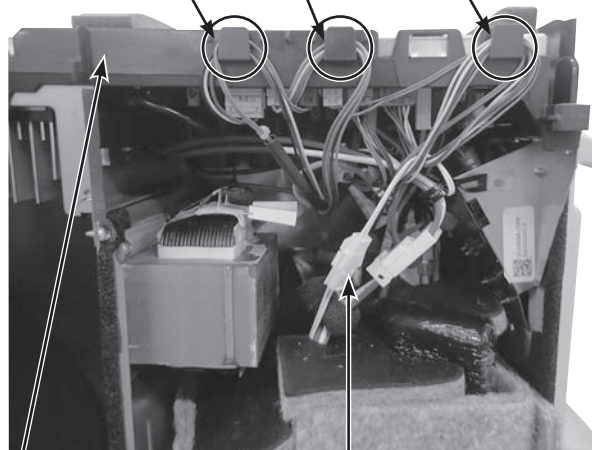
## PHOTOS/FIGURES

### Photo 9 MUZ-GX09NL MUZ-GX09NLHZ MUY-GX09NL MUZ-GX12NL MUY-GX12NL

Lead wires of the fan motor (Power) and ambient temperature thermistor (**NLHZ only**)

Lead wires of the fan motor (Signal)

Lead wires of the outdoor heat exchanger temperature thermistor and the expansion valve coil



Inverter P.C. board support

Connector of the compressor protector

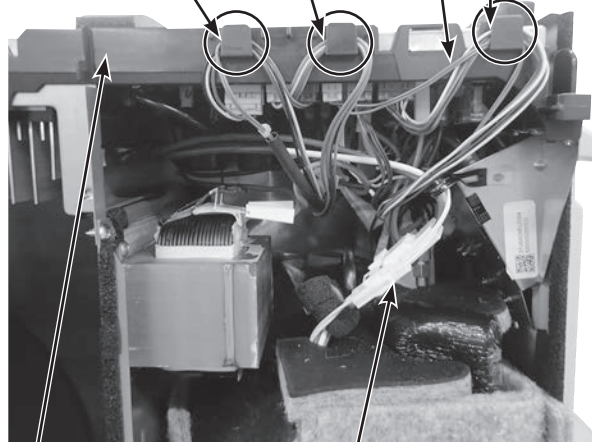
### MUZ-GX12NLHZ MUZ-GX15NL MUZ-GX15NLHZ MUY-GX15NL

Lead wires of the fan motor (Power) and ambient temperature thermistor (**NLHZ only**)

Lead wires of the fan motor (Signal)

Lead wires of the outdoor heat exchanger temperature thermistor

Lead wires of the expansion valve coil



Inverter P.C. board support

Connector of the compressor protector

## OPERATING PROCEDURE

### 3. Removing R.V. coil

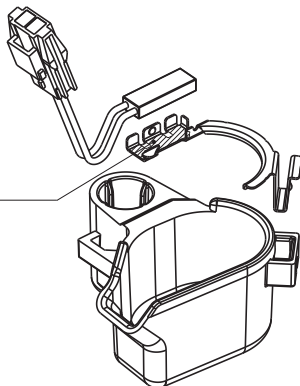
- (1) Remove the cabinet and panels. (Refer to section 1.)
- (2) Disconnect the following connectors:  
<Inverter P.C. board>  
CN721 (R.V. coil)
- (3) Remove the R.V. coil.

### 4. Removing the discharge temperature thermistor, defrost thermistor, outdoor heat exchanger temperature thermistor and ambient temperature thermistor

- (1) Remove the top panel, cabinet and service panel. (Refer to section 1.)
- (2) Disconnect the lead wire to the reactor and the following connectors:  
<Inverter P.C. board>  
CN641 (Defrost thermistor and discharge temperature thermistor)  
CN643 (Ambient temperature thermistor)  
CN644 (Outdoor heat exchanger temperature thermistor)
- (3) Pull out the discharge temperature thermistor from its holder.
- (4) Pull out the defrost thermistor from its holder.
- (5) Pull out the outdoor heat exchanger temperature thermistor from its holder.
- (6) Pull out the ambient temperature thermistor from its holder.

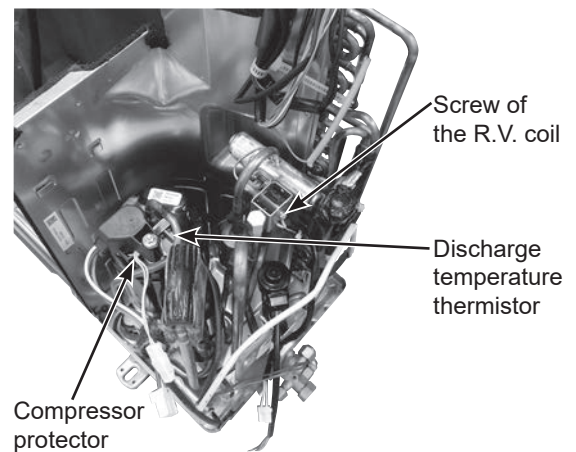
**Figure 2**

Attach the compressor protector to the protector holder with the surface on which the model name is printed facing the area hatched in the figure.



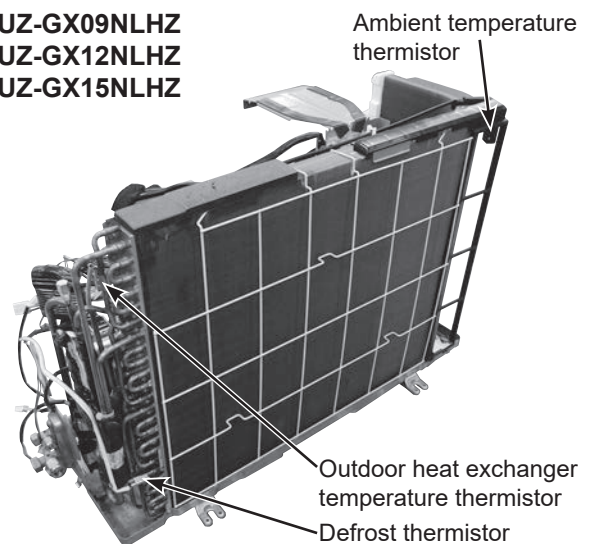
## PHOTOS/FIGURES

**Photo 10**

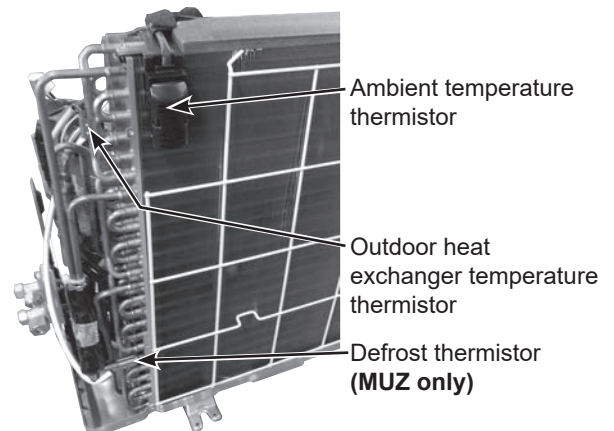


**Photo 11**

**MUZ-GX09NLHZ  
MUZ-GX12NLHZ  
MUZ-GX15NLHZ**



**Other models**



## OPERATING PROCEDURE

### 5. Removing outdoor fan motor

- (1) Remove the top panel, cabinet and service panel. (Refer to section 1.)
- (2) Disconnect the following connectors:  
<Inverter P.C. board>  
CN931, CN932 (Fan motor)
- (3) Remove the propeller fan nut.
- (4) Remove the propeller fan.
- (5) Remove the screws fixing the fan motor.
- (6) Remove the fan motor.

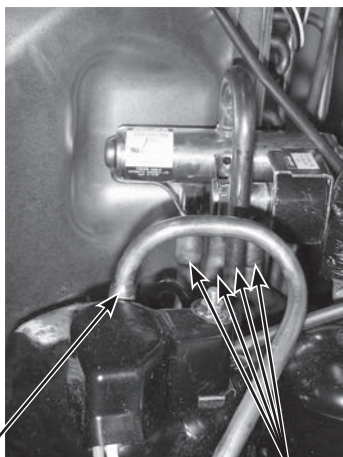
**NOTE:** The propeller fan nut is a reverse thread.

### 6. Removing the compressor and 4-way valve

- (1) Remove the cabinet and panels. (Refer to section 1.)
- (2) Remove the inverter assembly. (Refer to section 2.)
- (3) Remove the screws fixing the reactor.
- (4) Remove the reactor.
- (5) Remove the soundproof felt.
- (6) Recover gas from the refrigerant circuit.  
**NOTE:** Recover gas from the pipes until the pressure gauge shows 0 psig.
- (7) Detach the brazed part of the suction and the discharge pipe connected with compressor.
- (8) Remove the nuts fixing the compressor.
- (9) Remove the compressor.
- (10) Detach the brazed part of pipes connected with 4-way valve.

**NOTE:** If the red labels have been removed during the operation, put them back in the original position after the operation. Red labels indicate the use of flammable refrigerants. (Figure 3)

**Photo 14**



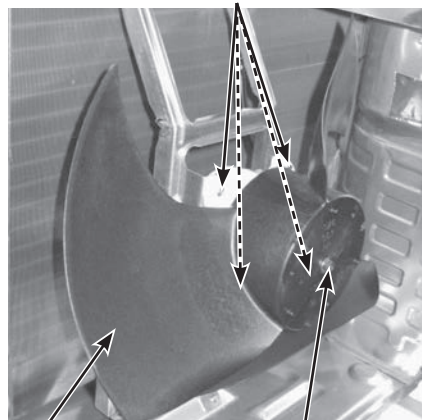
Discharge pipe  
brazed part

Brazed parts of  
4-way valve

## PHOTOS/FIGURES

**Photo 12**

Screws of the outdoor fan motor

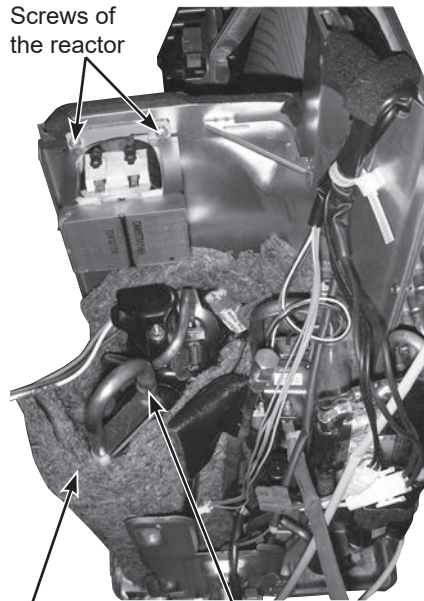


Propeller fan

Propeller fan nut

**Photo 13**

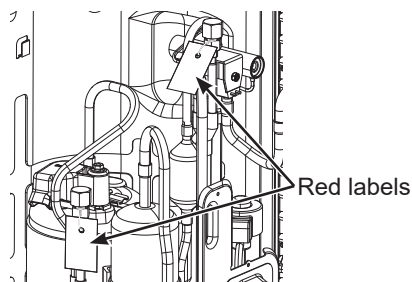
Screws of  
the reactor



Soundproof felt

Suction pipe brazed part

**Figure 3**

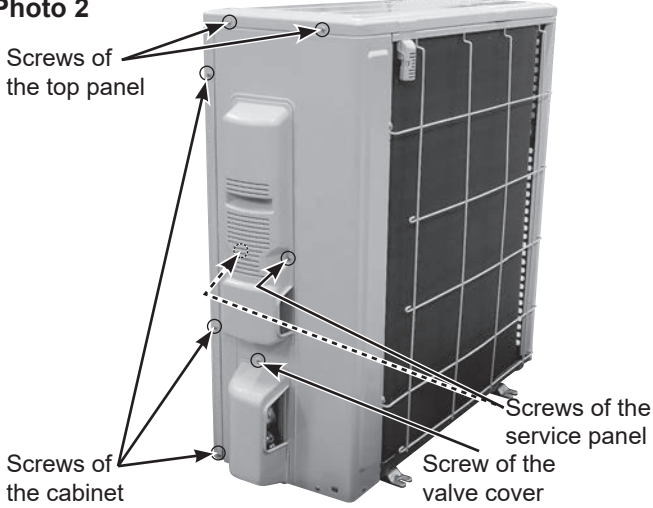
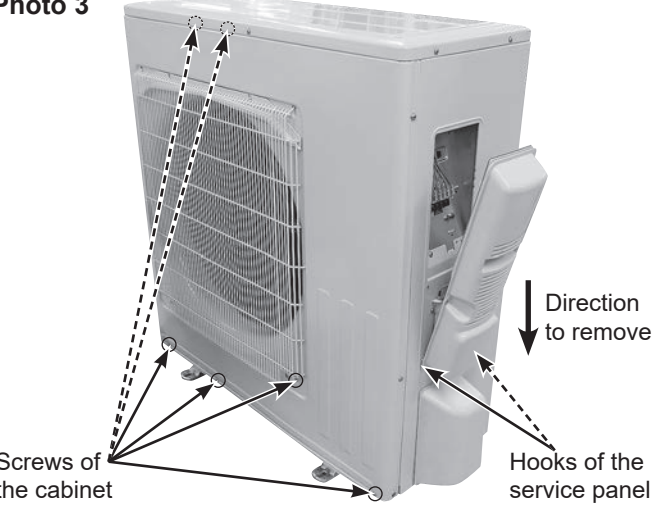
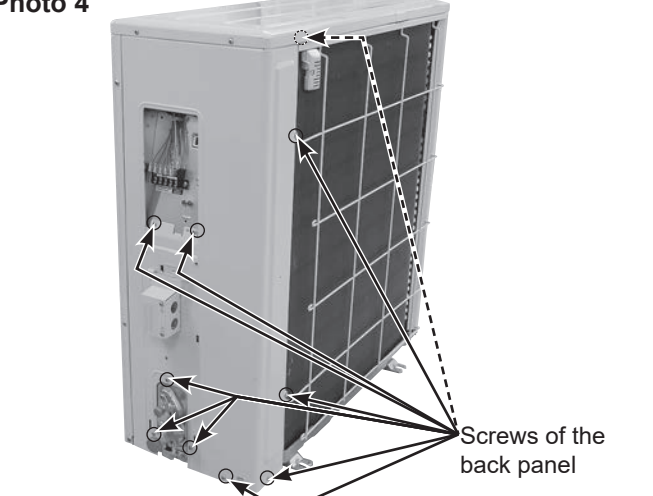
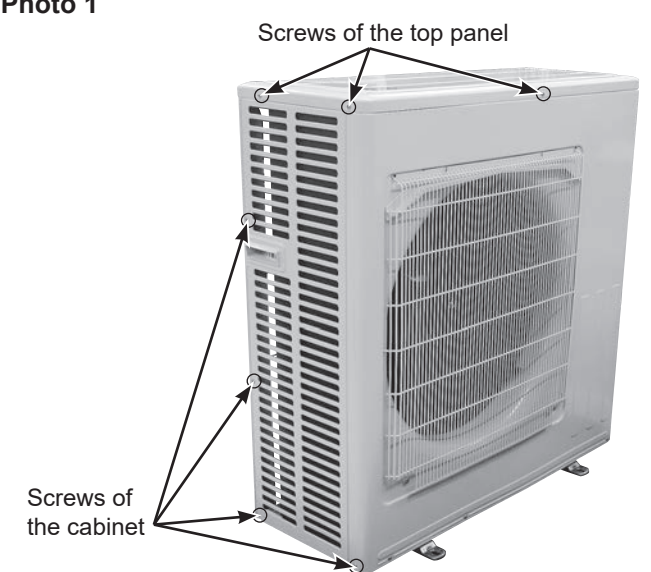
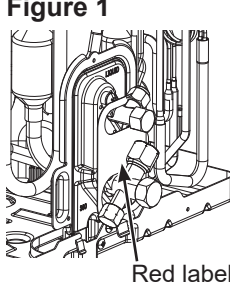


Red labels

**12-2. MUZ-GX18NL MUZ-GX24NL MUZ-GX30NL MUZ-GX36NL**  
**MUY-GX18NL MUY-GX24NL MUY-GX30NL MUY-GX36NL**  
**MUZ-GX18NLHZ MUZ-GX24NLHZ**

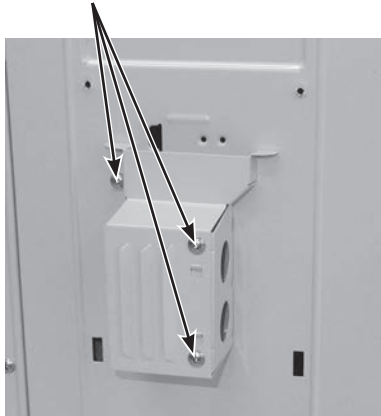
→ : Indicates the visible parts in the photos/figures.  
 ---→ : Indicates the invisible parts in the photos/figures.

**NOTE:** Turn OFF the power supply before disassembly.

OPERATING PROCEDURE	PHOTOS/FIGURES
<p><b>1. Removing the cabinet</b></p> <ol style="list-style-type: none"> <li>(1) Remove the screws of the service panel.</li> <li>(2) Remove the screws of the top panel.</li> <li>(3) Remove the screw of the valve cover.</li> <li>(4) Remove the service panel.</li> <li>(5) Remove the top panel.</li> <li>(6) Remove the valve cover.</li> <li>(7) Remove the screws fixing the conduit cover. (Photo 5)</li> <li>(8) Remove the conduit cover.</li> <li>(9) Remove the screw fixing the conduit plate. (Photo 6)</li> <li>(10) Remove the conduit plate.</li> <li>(11) Disconnect the power supply and indoor/outdoor connecting wire.</li> <li>(12) Remove the screws of the cabinet.</li> <li>(13) Remove the cabinet.</li> <li>(14) Remove the screws of the back panel.</li> <li>(15) Remove the back panel.</li> </ol> <p><b>NOTE:</b> If the red labels have been removed during the operation, put them back in the original position after the operation. Red labels indicate the use of flammable refrigerants. (Figure 1)</p>	<p><b>Photo 2</b></p>  <p><b>Photo 3</b></p>  <p><b>Photo 4</b></p>  <p><b>Photo 1</b></p>  <p><b>Figure 1</b></p> 

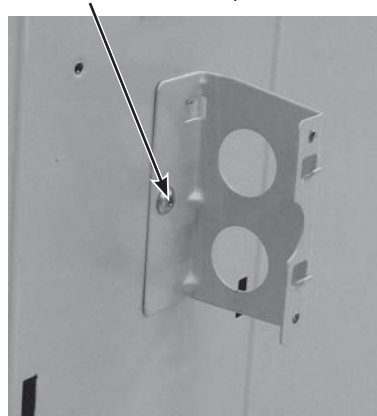
## OPERATING PROCEDURE

**Photo 5** Screws of the conduit cover



## PHOTOS/FIGURES

**Photo 6** Screw of the conduit plate

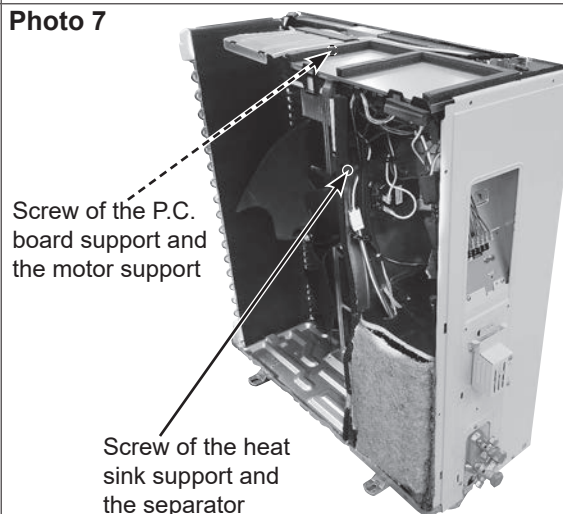


### 2. Removing the inverter assembly, inverter P.C. board and fuse P.C. board

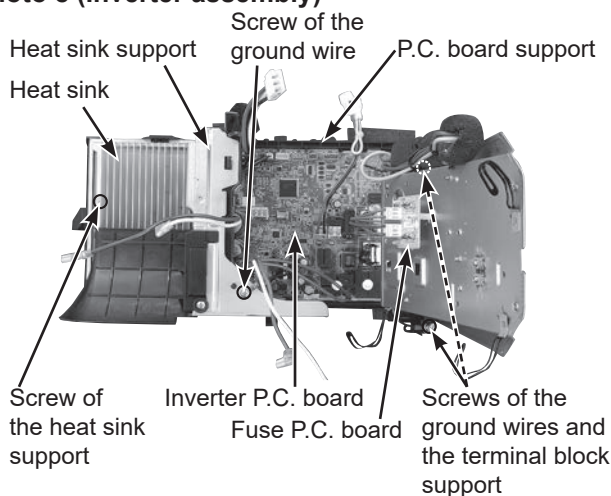
#### 2-1. Removing the inverter assembly and inverter P.C. board

- (1) Remove the top panel, cabinet and service panel.  
(Refer to section 1.)
- (2) Disconnect the lead wire to the reactor and the following connectors:
  - <Inverter P.C. board>
  - CN602 (R.V. coil) **(MUZ)**
  - CN931, CN932 (Fan motor)
  - CN671 (Defrost thermistor **(MUZ)**, discharge temperature thermistor and outdoor heat exchanger temperature thermistor)
  - CN672 (Ambient temperature thermistor)
  - CN724 (Expansion valve coil)
  - CN601 (Defrost heater and heater protector) **(NLHZ)**
  - CN64 (Compressor protector)
- (3) Remove the compressor connector (CN61).
- (4) Remove the screws fixing the heat sink support and the separator.
- (5) Remove the screws fixing the P.C. board support and the motor support.
- (6) Remove the inverter assembly.
- (7) Remove the screws of the ground wires and the terminal block support.
- (8) Remove the screw of the heat sink support, and the heat sink support from the P.C. board support.

**Photo 7**



**Photo 8 (Inverter assembly)**



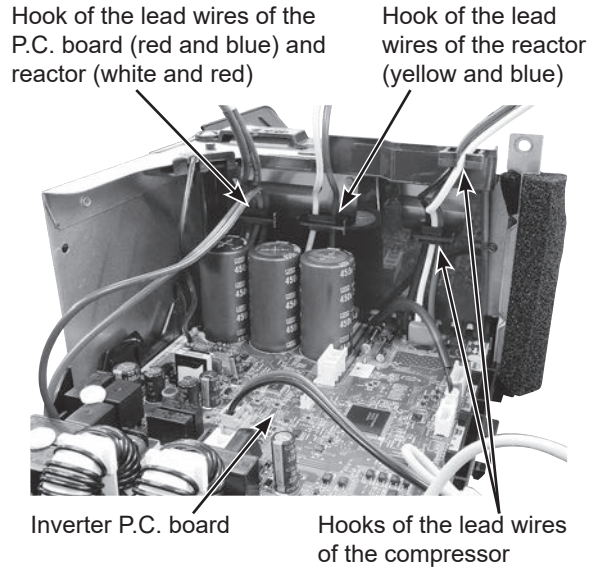
## OPERATING PROCEDURE

### \* Connection procedure when attaching the inverter P.C. board (Photo 8, 9, 10, 11, 12)

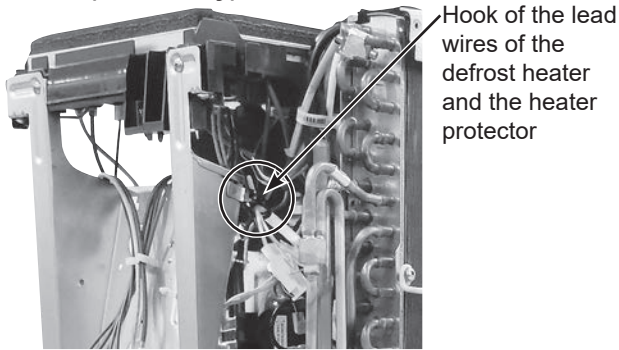
1. Attach the heat sink support to the P.C. board support.
2. Hook the lead wires of the compressor, the reactor and the P.C. board to each hooks on the heat sink support as shown in Photo 11.
3. Connect the lead wires of the expansion valve coil to the connector on the inverter P.C. board. Pull the lead wires of the expansion valve coil toward you and put them on the left hook on the P.C. board support as shown in Photo 12.
4. Hook the lead wires of the compressor, discharge temperature thermistor, defrost thermistor and expansion valve coil to each hook and tighten the wires with the fastener as shown in Photo 12.
5. Hook the lead wires of the defrost heater and the heater protector. (Photo 9)

## PHOTOS/FIGURES

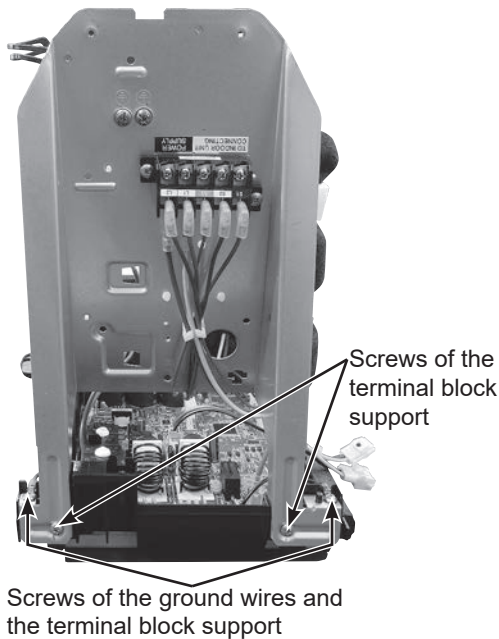
**Photo 11**



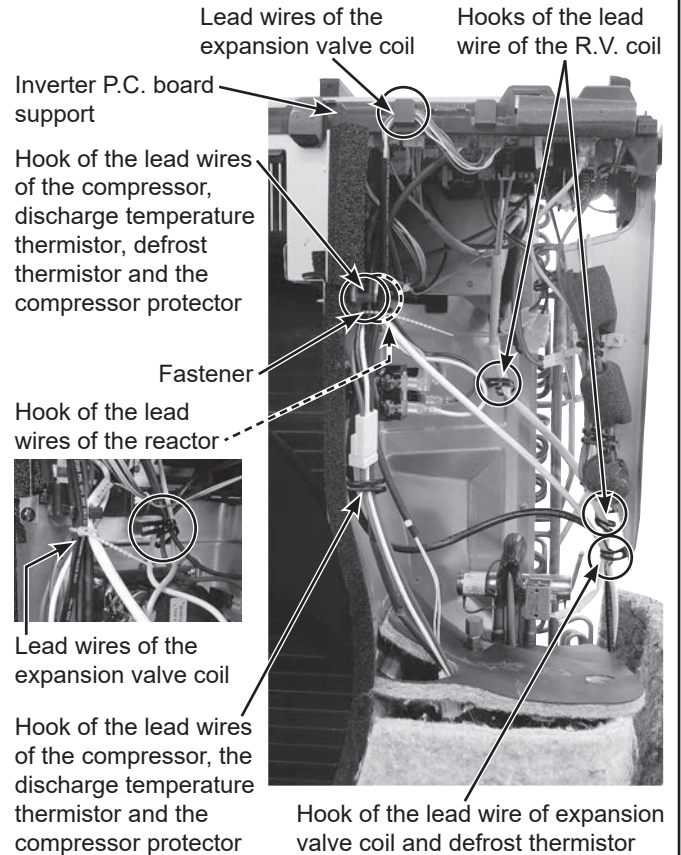
**Photo 9 (NLHZ only)**



**Photo 10**



**Photo 12**



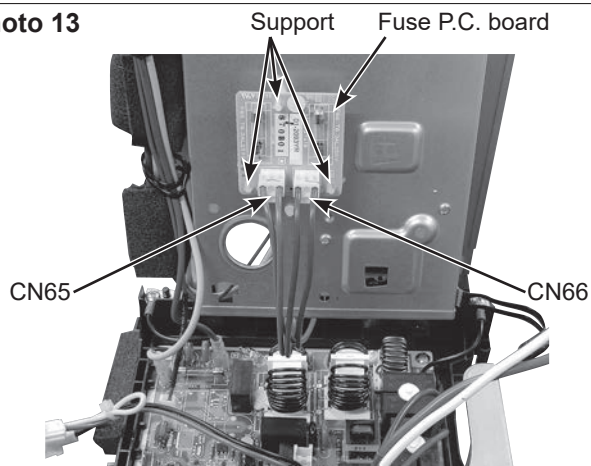
## OPERATING PROCEDURE

## PHOTOS/FIGURES

### 2-2. Removing the fuse P.C. board

- (1) Remove the top panel, cabinet and service panel. (Refer to section 1.)
- (2) Disconnect the lead wire to the reactor and the inverter P.C. board connectors. (Refer to section 2-1. (2))
- (3) Remove the compressor connector (CN61).
- (4) Remove the screws fixing the heat sink support and the separator.
- (5) Remove the screws fixing the P.C. board support and the motor support.
- (6) Remove the fixing screws of the terminal block support and the back panel.
- (7) Remove the inverter assembly.
- (8) Remove the following disconnected connectors:
  - <Fuse P.C. board>
  - CN65, CN66 (Terminal block)
- (9) Remove the fuse P.C. board from the supports.

Photo 13



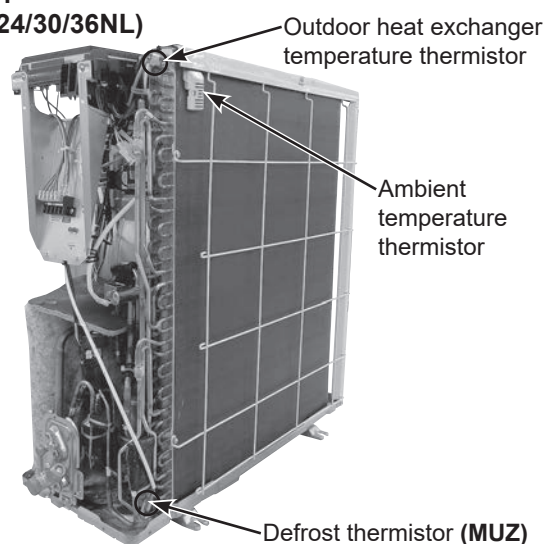
Pinch the stopper of the support, and push it into the hole to remove the fuse P.C. board.

### 3. Removing the discharge temperature thermistor, defrost thermistor (MUZ only), outdoor heat exchanger temperature thermistor and ambient temperature thermistor

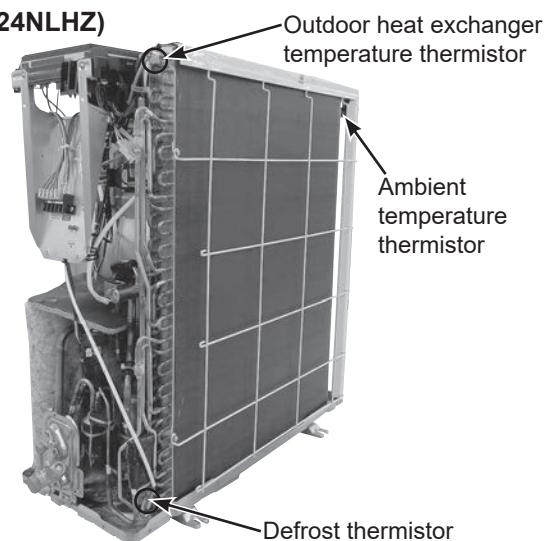
- (1) Remove the cabinet and panels. (Refer to section 1.)
- (2) Disconnect the lead wire to the reactor and the following connectors:
  - <Inverter P.C. board>
  - CN671 (Defrost thermistor (MUZ), discharge temperature thermistor and outdoor heat exchanger temperature thermistor)
  - CN672 (Ambient temperature thermistor)
- (3) Pull out the discharge temperature thermistor from its holder. (Photo 16)
- (4) Pull out the defrost thermistor from its holder.
- (5) Pull out the outdoor heat exchanger temperature thermistor from its holder.
- (6) Pull out the ambient temperature thermistor from its holder.

Photo 14

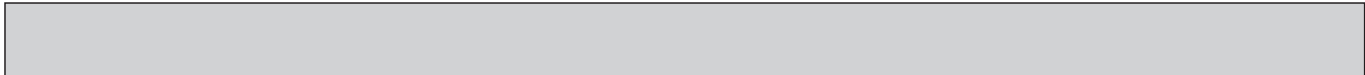
(GX18/24/30/36NL)

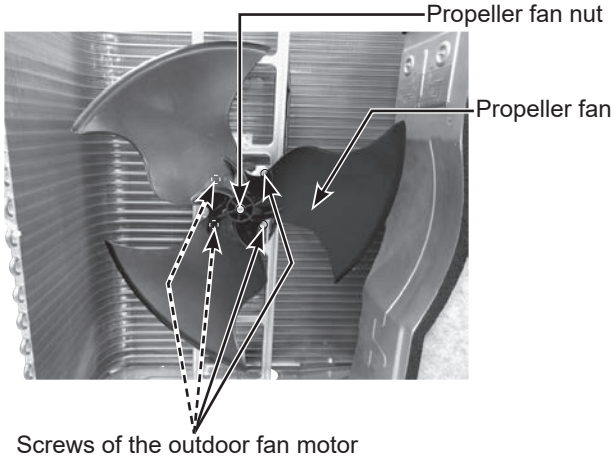
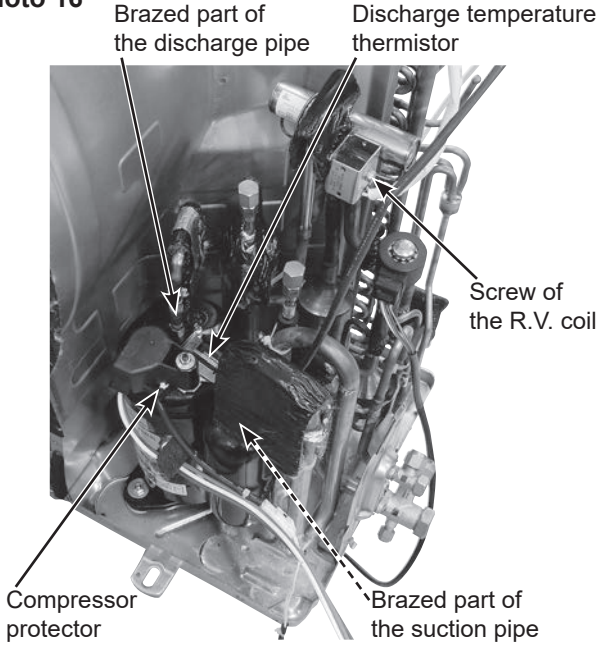


(GX18/24NLHZ)







OPERATING PROCEDURE	PHOTOS/FIGURES
<p><b>4. Removing outdoor fan motor</b></p> <ol style="list-style-type: none"><li>(1) Remove the top panel, cabinet and service panel. (Refer to section 1.)</li><li>(2) Disconnect the following connectors: &lt;Inverter P.C. board&gt; CN931, CN932 (Fan motor)</li><li>(3) Remove the propeller fan nut.</li><li>(4) Remove the propeller fan.</li><li>(5) Remove the screws fixing the fan motor.</li><li>(6) Remove the fan motor.</li></ol>	<p><b>Photo 15</b></p>  <p>Propeller fan nut</p> <p>Propeller fan</p> <p>Screws of the outdoor fan motor</p>
<p><b>5. Removing R. V. coil (MUZ only)</b></p> <ol style="list-style-type: none"><li>(1) Remove the cabinet and panels. (Refer to section 1.)</li><li>(2) Disconnect the following connectors: &lt;Inverter P.C. board&gt; CN602 (R.V. coil)</li><li>(3) Remove the R.V. coil.</li></ol>	<p><b>Photo 16</b></p>  <p>Brazed part of the discharge pipe</p> <p>Discharge temperature thermistor</p> <p>Screw of the R.V. coil</p> <p>Compressor protector</p> <p>Brazed part of the suction pipe</p>

## OPERATING PROCEDURE

### 6. Removing the compressor and 4-way valve

- (1) Remove the cabinet and panels. (Refer to section 1.)
  - (2) Remove the inverter assembly. (Refer to section 2.)
  - (3) Remove the screws fixing the reactor.
  - (4) Remove the reactor.
  - (5) Remove the soundproof felt.
  - (6) Recover gas from the refrigerant circuit.
- NOTE:** Recover gas from the pipes until the pressure gauge shows 0 psig.
- (7) Detach the brazed part of the suction and the discharge pipe connected with compressor. (Photo 16)
  - (8) Remove the compressor nuts.
  - (9) Remove the compressor.
  - (10) Detach the brazed parts of 4-way valve and pipe.

**NOTE:** If the red labels have been removed during the operation, put them back in the original position after the operation. Red labels indicate the use of flammable refrigerants. (Figure 2)

## PHOTOS/FIGURES

Photo 17

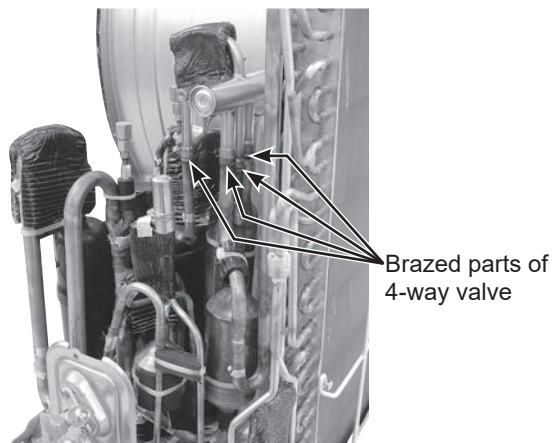


Figure 2

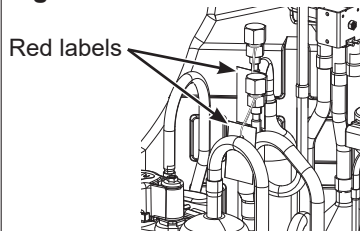
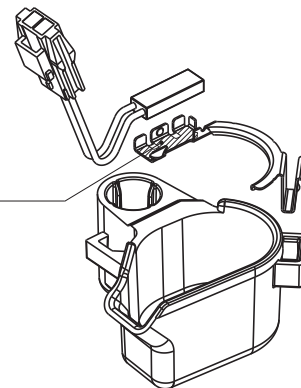


Figure 3

Attach the compressor protector to the protector holder with the surface on which the model name is printed facing the area hatched in the figure.



# **mitsubishi electric corporation**

HEAD OFFICE: TOKYO BUILDING, 2-7-3, MARUNOUCHI, CHIYODA-KU, TOKYO 100-8310, JAPAN

© Copyright 2024 MITSUBISHI ELECTRIC CORPORATION

Issued: Jan. 2025. No. OBH951 REVISED EDITION-B

Issued: Nov. 2024. No. OBH951 REVISED EDITION-A

Published: Oct. 2024. No. OBH951

Made in Japan

Specifications are subject to change without notice.