

**PRODUCT CATALOG #1207**

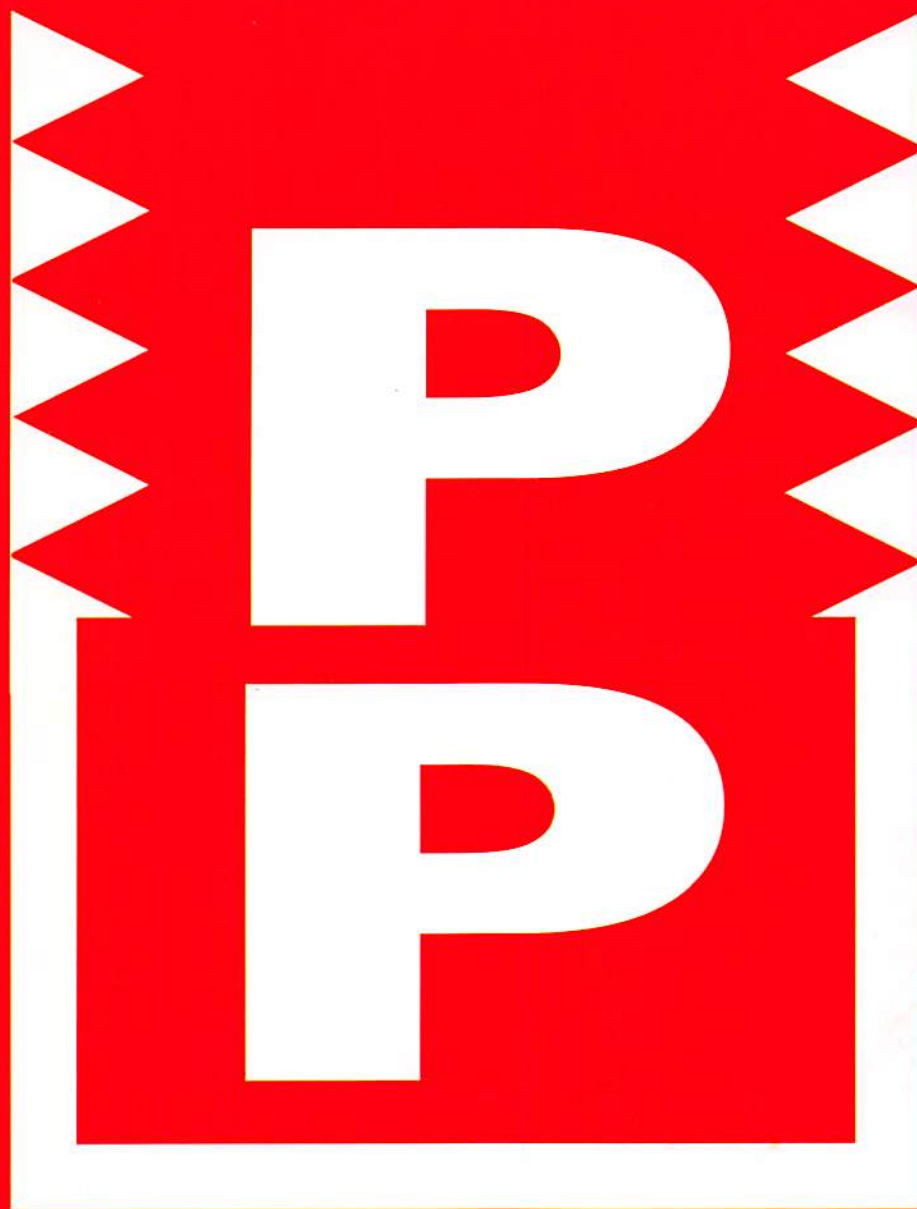

**PLUMBING PRODUCTS CO., INC.**

72234 Corporate Way  
Thousand Palms, CA 92276

# TERMS AND CONDITIONS OF SALE

---

**PRICES:** Prices are subject to change without notice. PRICE LIST 1993 supersedes all previous price schedules. All prices are indicated in United States Currency.

**MINIMUM ORDERS:** \$50.00 NET per purchase order. We will add charges for orders totalling less than \$50.00, to bring the order to minimum billing.

**FREIGHT:** Shipper reserves the right to ship merchandise by the method of our choosing. Shipments are F.O.B. from our Commerce California warehouse. Full freight is allowed on shipments of \$800.00 NET invoice value within the continental United States boundaries. Hawaii and Alaska the NET must be \$1,400.00. Freight allowance will not apply to customers outside the United States boundaries.

**CLAIMS:** All claims for defective merchandise, shipment shortages, billing errors, must be made within two weeks after receipt of goods.

**DAMAGED OR LOST SHIPMENTS:** Delivery to the carrier constitutes delivery to the customer, F.O.B. claims for loss or damaged in transit, should be made promptly by you the customer, to the freight carrier. Our responsibility ceases when the goods are delivered in good condition to the carrier. Plumbing Products Co., Inc., places insurance on all shipments leaving our warehouse, covering damage or loss for full value of shipment. Insurance charges are automatically added to freight charges on invoice.

**RETURN:** Merchandise cannot be returned without prior authorization from our Returns department. All returns must be properly packaged and accompanied by either, a copy of the original invoice (or) packing list. The RGA number should be marked on the outside of the box. Shipping charges for returned merchandise must be prepaid. C.O.D's will be refused by our receiving department. All returns are subject to a minimum 25% restocking charge. Non-defective merchandise (overstock), is non-returnable. Credits are issued, upon inspection. We do not even exchange, or swap merchandise. We will re-invoice the replacement merchandise, and credit the original invoice for the returned merchandise.

**PRODUCT WARRANTY:** Plumbing Products Co., Inc., at its sole option, will replace any product or parts, that are defective due to faulty workmanship, for a period of one year. All warranted replacements are to be re-invoiced and credit will then be applied to the original invoice. Under no circumstances will there be any straight exchanges or no charge shipments.

**PRODUCT LIABILITY:** Product Liability Insurance statements are available upon request.

© 2007 Plumbing Products Co., Inc.

ALL RIGHTS RESERVED



---

(760) 343-3040 • Facsimile Number (760) 343-3609

# SHOWER DRAINS

- 2** 1-1/2" IPS, SHOWER DRAIN. Cast iron, assembled with (6) grill, (6CR) crown, two (7) screws, (14P1) protection plate, and three (7B) bolts.  
Sold 12 per box only.
- 2IB** Same as (2) except, Individually boxed. Sold on an each basis.
- 4** 2" IPS, SHOWER DRAIN. Cast iron, assembled with (6) grill, (6CR) crown, two (7) screws, three (7B) bolts, and (14P2) protection plate.  
Sold 12 per box only.
- 4IB** Same as (4) except, Individually boxed. Sold on an each basis.
- 5** 2" CAULK, SHOWER DRAIN. Cast iron, assembled with (6) grill, (6CR) crown, two (7) screws, three (7B) bolts, and (14P) protection plate.  
Sold 12 per box only.
- 5IB** Same as (5) except, Individually boxed. Sold on an each basis.
- RTO** DRAIN TOP ONLY. Cast iron, assembled with (6) grill, (6CR) crown, two (7) screws. Fits our drain numbers 2, 4, 5, 2TD, 4TD, 5TD, 4NH, 4NHTD, and 5QC. Sold 24 per box only.
- 2S** 1-1/2" IPS, SHOWER DRAIN. Los Angeles Code. Cast iron, assembled with (6) grill, (6CR) crown, two (7) screws , three (7B) bolts, and (14P1) protection plate. Sold 6 per box only.
- 2SIB** Same as (2S) except, Individually boxed. Sold on an each basis.
- 4S** 2" IPS, SHOWER DRAIN. Los Angeles Code. Cast iron, assembled with (6) grill, (6CR) crown, two (7) screws , three (7B) bolts, and (14P1) protection plate.  
Sold 6 per box only.
- 4SIB** Same as (4S) except, Individually boxed. Sold on an each basis
- 5S** 2" CAULK, SHOWER DRAIN. Los Angeles Code. Cast iron, assembled with (6) grill, (6CR) crown, two (7) screws , three (7B) bolts, and (14P1) protection plate.  
Sold 6 per box only.
- 5SIB** Same as (5S) except, Individually boxed. Sold on a each basis.
- CTO** DRAIN TOP ONLY. Los Angeles Code. Cast iron, assembled with (6) grill, (6CR) crown, two (7) screws. Fits our drain numbers 2S, 4S, 5S, 2STD, 4STD,, 5STD, 5SQC, 50SA, 50SP, 5SQCTD, 50STDA, 50STDP, 5NC, 5NCTD, and 5NCA. Sold 12 per box only.

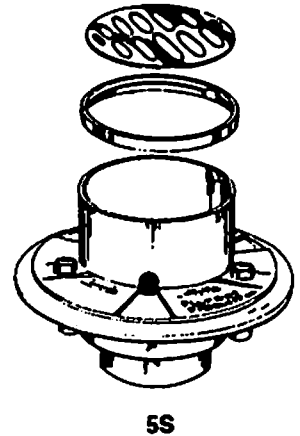
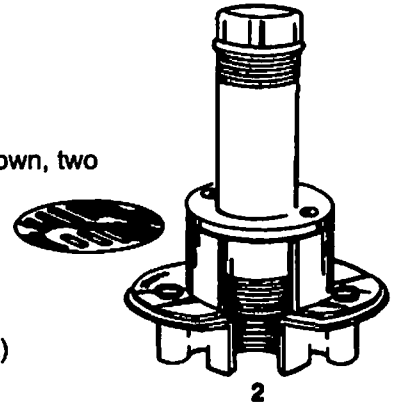

## PROTECTION DRAINS

- 8A 1-1/2" IPS., PROTECTION DRAIN. Cast iron ,assembled with a (6) grill, (6CR) crown, two (7) screws, and (14P) protection plate. Sold on an each basis.
- 9A 2" IPS., PROTECTION DRAIN. Cast iron ,assembled with a (6) grill, (6CR) crown, two (7) screws, and (14P) protection plate. Sold on an each basis.
- 14A 2" CAULK PROTECTION DRAIN. Cast iron, assembled with a (6) grill, (6CR) crown, two (7) screws, and (14P) protection plate. Sold on an each basis.



8A



14A

## BRASS SHOWER DRAINS

- 108 1-1/2 IPS., BRASS SHOWER DRAIN. Assembled with a (6) grill, and two (7) screws. Sold on an each basis.
- 109 2" IPS., BRASS SHOWER DRAIN. Assembled with a (6) grill and two (7) screws. Sold on an each basis.



108

## ABS PLASTIC SHOWER DRAINS

- 50SA 2" GLUE-ON SHOWER DRAIN. ABS black plastic bottom. Los Angeles Code. Cast iron top. Assembled with three (7LS) screws, (6) grill, (6CR) crown, two (7) screws, and (14P) protection plate. Sold 12 per box only.
- 501SA 2" GLUE-ON SHOWER DRAIN. ABS black plastic top and bottom. Los Angeles Code. Assembled with three (7LS) screws, (6) grill, (6CR) crown, two (7) screws, and (14P) protection plate. Sold 12 per box only.
- ATO DRAIN TOP ONLY, ABS black plastic, assembled with (6) grill (6CR) crown, and two (7) screws. Fits our drain numbers 501SA, 50SA, 501STDA, and 50STDA. Sold 24 per box only.

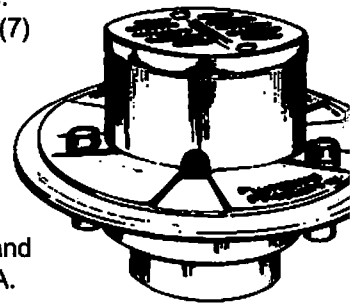

50SA

## PVC PLASTIC SHOWER DRAINS

- 50SP 2" GLUE-ON SHOWER DRAIN. PVC white plastic bottom. Los Angeles Code. Cast iron top. Assembled with three (7LS) screws, (6) grill, (6CR) crown, two (7) screws, and (14P) protection plate. Sold 12 per box only.
- 501SP 2" GLUE-ON SHOWER DRAIN. PVC white plastic top and bottom. Los Angeles Code. Assembled with three (7LS) screws, (6) grill, (6CR) crown, two (7) screws, and (14P) protection plate. Sold 12 per box only.
- PTO DRAIN TOP ONLY, PVC white plastic, assembled with (6) grill (6CR) crown, and two (7) screws. Fits our drain numbers 501SP, 501STDP. Sold 24 per box only.

## NO-CAULK SHOWER DRAINS

- 5NC** 2" NO-CAULK, SHOWER DRAIN. Cast iron, Los Angeles Code. Assembled with three (7B) bolts, (6) grill, (6CR) crown, two (7) screws, and Neoprene gasket. For cast iron, steel, or plastic pipe. Sold 6 per carton only.
- 5NCIB** Same as (5NC) except, individually boxed. Sold on an each basis.
- 5NCPLG** Same as (5NC) with a 2" test plug (4820). Sold 6 per carton only.
- 5NCPLGIB** Same as (5NCPLG) except, individually boxed. Sold on an each basis.
- 5NCA** 2" NO-CAULK, SHOWER DRAIN. ABS black plastic top. Los Angeles Code, cast iron bottom. Assembled with three (7B) bolts, (6) grill, (6CR) crown, two (7) screws, and Neoprene gasket. For cast iron, steel, or plastic pipe. Sold 6 per carton only.

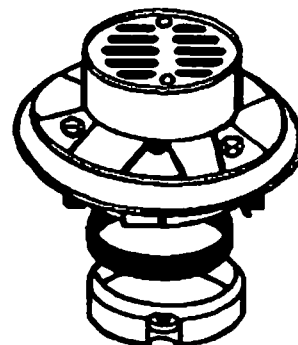

5NC

## QUICK CAULK, SHOWER DRAINS

- 5QC** 2" QUICK CAULK, SHOWER DRAIN. Self caulking, cast iron. Assembled with three (7B) bolts, (6) grill, (6CR) crown, two (7) screws, (14P) protection plate, and (JQCG) Jiffy Seal Gasket. Sold 12 per box only.
- 5QCIB** Same as (5QC) except, individually boxed. Sold on an each basis.
- 5SQC** 2" QUICK CAULK, SHOWER DRAIN. Self caulking, cast iron. Los Angeles Code. Assembled with three (7B) bolts, (6) grill, (6CR) crown, two (7) screws, (14P) protection plate, and (JQCG) Jiffy Seal Gasket. Sold 6 per box only.
- 5SQCIB** Same as (5SQC) except, individually boxed. Sold on an each basis.
- JQCG** QUICK CAULK, JIFFY SEAL GASKET only. Sold 25 per box only.

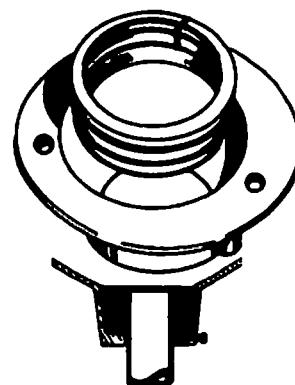

5QC

## NO HUB, SHOWER DRAINS

- 4NH** 2" NO HUB, SHOWER DRAIN. Cast iron. Assembled with three (7B) bolts, (6) grill, (6CR) crown, two (7) screws, and (14P) protection plate. Neoprene coupling NOT included. Sold 6 per box only.
- 4NHIB** Same as (4NH) except, Individually boxed. Sold on an each basis.

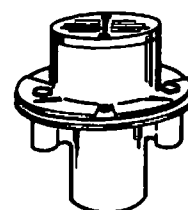

4NH

## ROMAN TUB DRAINS

- TDTO** ROMAN TUB DRAIN, TOP ONLY. Chrome plated. Includes (70R) "O" ring, with two screws. Sold on an each basis.
- 2TD** 1-1/2" IPS, ROMAN TUB DRAIN. Assembled with (TDTO) Roman Tub Top, with two screws, three (7B) bolts, (6CR) crown, and (14P2) protection plate. Individually boxed. Sold on an each basis.

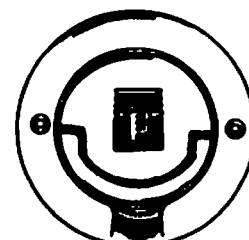

TDTO

## ROMAN TUB DRAINS (CONTINUED)

- 4TD 2" IPS, ROMAN TUB DRAIN. Assembled with (TDTO) Roman Tub Top, with two screws, three (7B) bolts, (6CR) crown, and (14P2) protection plate. Individually boxed. Sold on an each basis.
- 5TD 2" CAULK, ROMAN TUB DRAIN. Assembled with (TDTO) Roman Tub Top, with two screws, three (7B) bolts, (6CR) crown, and (14P2) protection plate. Individually boxed. Sold on an each basis.
- 4NHTD 2" NO HUB, ROMAN TUB DRAIN. Assembled with (TDTO) Roman Tub Top, with two screws, three (7B) bolts, (6CR) crown, and (14P2) protection plate. Individually boxed. Sold on an each basis.
- 5QCTD 2" QUICK CAULK, ROMAN TUB DRAIN. Assembled with (TDTO) Roman Tub Top, with two screws, three (7B) bolts, (6CR) crown, and (14P2) protection plate. and (JQCG) Jiffy Seal Gasket. Individually boxed. Sold on an each basis.

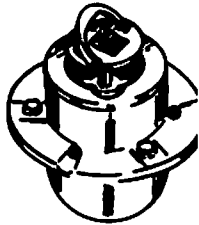

4TD

## ROMAN TUB DRAINS, LOS ANGELES CODE

- 2STD 1-1/2" IPS, ROMAN TUB DRAIN, LOS ANGELES CODE. Assembled with (TDTO) Roman Tub Top, with two screws, three (7B) bolts, (6CR) crown, and (14P2) protection plate. Individually boxed. Sold on an each basis.
- 4STD 2" IPS, ROMAN TUB DRAIN, LOS ANGELES CODE. Assembled with (TDTO) Roman Tub Top, with two screws, three (7B) bolts, and (6CR) crown, and (14P) protection plate. Individually boxed. Sold on an each basis.
- 5STD 2" CAULK, ROMAN TUB DRAIN, LOS ANGELES CODE. Assembled with (TDTO) Roman Tub Top, with two screws, three (7B) bolts, (6CR) crown, and (14P) protection plate. Individually boxed. Sold on an each basis.
- 5SQCTD 2" QUICK CAULK, ROMAN TUB DRAIN, LOS ANGELES CODE. Assembled with (TDTO) Roman Tub Top with two screws, three (7B) bolts, (6CR) crown, (14P) protection plate, and (JQCG) Jiffy Seal Gasket. Individually boxed. Sold on an each basis.
- 50STDA 2" GLUE-ON, ROMAN TUB DRAIN, LOS ANGELES CODE. ABS black plastic bottom, cast iron top. Assembled with (TDTO) Roman Tub Top, with two screws, three (7B) bolts, (6CR) crown, and (14P) protection plate. Individually boxed. Sold on an each basis.
- 50STDP 2" GLUE-ON, ROMAN TUB DRAIN, LOS ANGELES CODE. PVC white plastic bottom, cast iron top. Assembled with (TDTO) Roman Tub Top, with two screws, three (7B) bolts, (6CR) crown, and (14P) protection plate. Individually boxed. Sold on an each basis.
- 501STDA 2" GLUE-ON, ROMAN TUB DRAIN, LOS ANGELES CODE. ABS black plastic top and bottom. Assembled with (TDTO) Roman Tub Top, with two screws, three (7B) bolts, (6CR) crown, and (14P) protection plate. Individually boxed. Sold on an each basis.

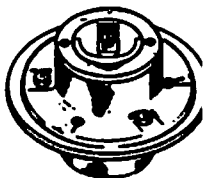

2STD

# ROMAN TUB DRAINS, LOS ANGELES CODE

**501STDP** 2" GLUE-ON, ROMAN TUB DRAIN, LOS ANGELES CODE. PVC white plastic top and bottom. Assembled with (TDTO) Roman Tub Top, with two screws, three (7B) bolts, (6CR) crown, and (14P) protection plate. Individually boxed. Sold on an each basis.

**14ATD** 2" CAULK, ROMAN TUB, PROTECTION DRAIN. Cast iron. Assembled with (TDTO) Roman Tub Top, with two screws, (6CR) crown, and (14P) protection plate. Individually boxed. Sold on an each basis.

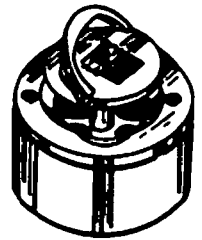

14ATD

## NO-CAULK, ROMAN TUB DRAINS

**5NCTD** 2" NO-CAULK, ROMAN TUB DRAIN, Los Angeles Code. Assembled with (TDTO) with Roman Tub Top, two screws, three (7B) bolts, (6CR) crown, and Neoprene gasket. Individually boxed. Sold on an each basis.

**5NCTDA** 2" NO-CAULK, ROMAN TUB DRAIN, ABS black plastic top, Los Angeles Code, cast iron bottom. Assembled with (TDTO) Roman Tub Top, with two screws, three (7B) bolts, (6CR) crown, and Neoprene gasket. Individually boxed. Sold on an each basis.

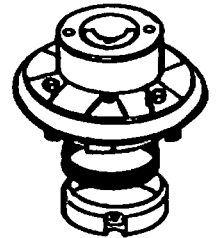

5NCTD

## DRAIN PARTS

**6** GRILL ONLY. Fits all Plumbing Products drains, (except Receptor drains). Fits CASPERS 151CI and 151P drains. Fits AB&A drains 5000 through 5088. Fits JONES and PASCO EZ PLUBM DRAINS. Fits Old Preimer drains. 3-1/2" O.D. with 2-7/8" center to center screw holes.



6

**6129** SNAP IN STRAINER CASPER 129. Fits CASPER 101B, 101NPT, 140NC, 101P, 101PS, and 101PNC. Retrofits AB&A 7200. Fits AB&A 3520 thru 3524, and 6520 thru 6523. Fits INTERCON, B & K INDUSTRIES, PRIER BRASS, and Plumbing Products Receptor drains. Can be used with SWAN and AQUA GLASS stall showers. 4-1/4" prong to prong.



6129

**41** SNAP IN STRAINER. Retrofits CASPER 109. Fits CASPER 101C, 102B, 102BNC, 104B, and 151B. 3-1/4" O.D. Prong to prong diameter 2-7/8".

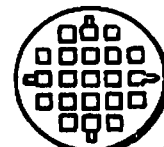

41

**47** SNAP IN STRAINER. Retrofits AB&A 7101. Fits AB&A 3075 through 6517 drains.



47

**45** SNAP IN STRAINER. Fits FRANK PATTERN (INSTANT SET) shower drain 20SD. 3-1/4" O.D. Prong to prong diameter 2-7/8".



45

**483** 3" FIT ALL, SNAP IN STRAINER. Fits most drains with 2-1/16" opening (cover for 2" pipe). Application used with strainer is missing and screws are broken off in top of drain.

**484** 4" FIT ALL, SNAP IN STRAINER. Fits most drains with 3-1/4" opening (cover for 3" pipe). Application used with strainer is missing and screws are broken off in top of drain.



483

## DRAIN PARTS (CONTINUED)

- 485 5" FIT ALL, SNAP IN STRAINER. Fits most drains with 3-5/8" opening (cover for 4" pipe). Application used with strainer is missing and screws are broken off in top of drain.
- 92 STRAINER & 2 SCREWS. Fits PLASTIC ODDITIES. Receptor drains PBR-400, PBR-406, PGP300, PSI-280, and PLP-350. PRIER BRASS, RICHMOND FOUNDRY, CP INDUSTRIES, and JONES drains. AB&A 3000 through 3012 and 3602 through 4974. 4" O.D. Center to Center screw holes are 3-3/8".
- 93 STRAINER & 2 SREWS. Will fit PLASTIC ODDITIES shower drain PFG-600. 4-1/4" O.D. Center to Center screw holes are 2-5/8".
- 6CR CROWN ONLY. For all Plumbing Products drains except Receptor drains). Fits PASCO EZ PLUMB drains. Fits AB&A drains 5000 through 5088. Outside diameter 3-1/2" Inside diameter 3"
- 42GC CROWN ONLY. Fits CASPER 151CI and 151P, JONES cast iron EZ PLUMB drains, and Old PRIEMER drains. 3-5/8" O.D., 3" I.D.
- 46 CROWN ONLY. Fits FRANK PATTERN (INSTANT SET) shower drains #20SD. 3-1/4" O.D., 2-7/8" I.D>
- 7 SCREW, FLAT HEAD, 8-32 x 3/8"
- 7B BOLT, HEX HEAD, steel, 5/16 - 18 x 1".
- 7LS 5/16 x 1-1/4" Hex Lag Screw. For plastic bottom drains.
- 70R RUBBER "O" RING. 1-3/4" O.D. 1-5/8" I.D. Temperature range, 65 F to 200 F, class "B."
- 14P PROTECTION PLATE, Solid face.
- 14P1 PROTECTION PLATE. For 1-1/2" IPS pipe.
- 14P2 PROTECTION PLATE. For 2" IPS pipe.

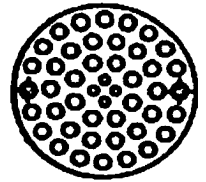

92

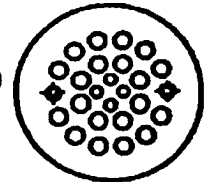

93



6CR



7

7B

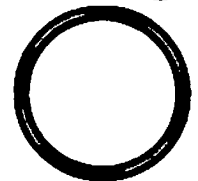

70R

## SHOWER DRAIN TILE SQUARES

- TSSS TILE SQUARE, stainless steel. 4-3/8" O.D. x 3-5/8" I.D.
- TSCP TILE SQUARE, Brass, chrome plated. 4-3/8" O.D. x 3-5/8" I.D.
- TBCP TILE SQUARE, Brass chrome plated. 5-3/4" O.D. x 4-3/8" I.D.



## DRAIN TRIM SETS

600 DRAIN TRIM SET. Includes (6) grill, (6CR) crown, and two (7) screws.

677 GRILL & SCREW SET, includes (6) grill, and two (7) screws.  
Fits all Plumbing Products drains, (except Receptor drains).  
Fits CASPER'S 151CI and 151P drains. Fits AB&A drains 5000 through 5088. Fits JONES and PASCO EZ PLUMB drains.  
Fits Old PREIMER drains.

602 DRAIN TRIM SET with TILE SQUARE. Includes (6) grill, (6CR) crown, two (7) screws, and (TSSS) stainless steel, tile square.

604 DRAIN TRIM SET with TILE SQUARE. Includes (6) grill, (6CR) crown, two (7) screws, and (TSCP) chrome plated, tile square.

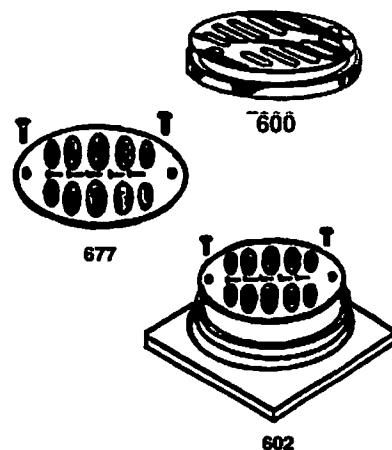

## SOAP & WATER DISPENSERS

215 LOTION DISPENSER, BRASS, Chrome Plated.

216 WATER DISPENSER, FAUCET PART ONLY. For filtered water.  
NOT usable as an instant hot. Input for 1/4" compression.  
7/16" diameter hole needed for installation. Chrome plated.

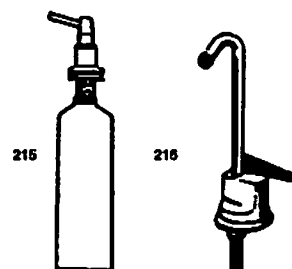

## SINK & TRAY PLUGS

PD3 SINK PLUG, BRASS, Chrome Plated. Fits 2" Opening, 3" O.D., 1-9/16" depth.  
Includes die cast (SJ11RZ) slip joint nut, die cast (LN4) lock nut, (PD3RW) rubber washer, (PD8) three prong strainer and (C87) tailpiece washer. Tailpiece NOT included. Individually boxed.

PD3SS SINK PLUG, STAINLESS STEEL. Fits 2" opening, 3" O.D., 1-1/4" depth. Includes die cast slip joint nut, die cast lock nut, rubber washer, three prong strainer, and tailpiece washer. Tailpiece NOT included. Individually boxed.

PD3SSB SINK PLUG, STAINLESS STEEL, Los Angeles Code. Fits 2" opening, 3" O.D., 1-1/4" depth. Includes BRASS slip joint nut, BRASS lock nut, rubber washer, three prong strainer, and tailpiece washer. Tailpiece NOT included. Individually boxed.

PD3B SINK PLUG, BRASS, chrome plated. LOS ANGELES CODE. Fits 2" opening, 3" O.D., 1-9/16" depth. Includes BRASS (SJ11XRB) slip joint nut, BRASS (LN4BR) lock nut, (PD3RW) rubber washer, (PD8) three prong strainer, and (C87) tailpiece washer. Tailpiece NOT included. Individually boxed.

PD3L TRAY PLUG, BRASS, chrome plated. Fits 2" opening, 3" O.D., 1-9/16" depth.  
Includes die cast (SJ11RZ) slip joint nut, die cast (LN4) lock nut, (PD3RW) rubber washer, (PD3A) rubber stopper, and (C87) tailpiece washer. Tailpiece NOT included. Individually boxed.

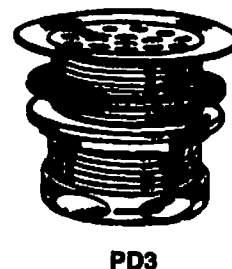

## SINK & TRAY PLUGS (CONTINUED)

- PD3LB** TRAY PLUG. BRASS, Chrome Plated. Los Angeles Code. Fits 2" opening, 3" O.D., 1-9/16" depth. Includes BRASS (SJ11XRB) slip joint nut, BRASS (LN4BR) lock nut, (PD3RW) rubber washer, (PD3A) rubber stopper, and (C87) tailpiece washer. Tailpiece NOT included. Individually boxed.
- PD3LSS** TRAY PLUG, STAINLESS STEEL. Fits 2" opening, 3" O.D., 1-1/4" depth. Includes die cast slip joint nut, one die cast lock nut, rubber washer, rubber stopper, and tailpiece washer. Tailpiece NOT included. Individually boxed.
- PD3LSSB** TRAY PLUG, STAINLESS STEEL. Los Angeles Code. Fits 2" opening, 3" O.D., 1-1/4" depth. Includes BRASS slip joint nut, BRASS lock nut, rubber washer, rubber stopper, and tailpiece washer. Tailpiece NOT included. Individually boxed.
- PD3RW** RUBBER WASHER, 2-7/8" O.D., for 2-1/2" Sink, Tray, Midget Duo Strainers, and Bath Strainer Bodies.
- PD3A** RUBBER STOPPER. 1-3/4" hollow, white, with nickel plated brass ring.
- PD8** STRAINER. Three prong, SNAP-IN strainer, stainless steel. 1-7/8" O.D.
- PD12** CUP STRAINER. 1-1/2" O.D. Metal, for Sink & Tray Plugs.
- C87** FLANGED TAILPIECE WASHER. Polyethylene molded plastic washer for 1-1/2" flanged tailpieces.



PD3A

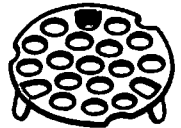

PD8

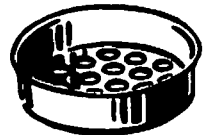

PD12



C87

## JUNIOR BASKET STRAINERS

- PD3J** JUNIOR BASKET STRAINER. BRASS, Chrome Plated. Fits 2" or 2-1/2" opening. includes basket, die cast slip joint nut, die cast lock nut, rubber washer, and tailpiece washer. Tailpiece NOT included.
- PD3JBR** JUNIOR BASKET STRAINER. Los Angeles Code. BRASS, Chrome Plated. Fits 2" or 2-1/2" opening. Includes basket, BRASS slip joint nut, BRASS lock nut, rubber washer, and tailpiece washer. Tailpiece NOT included. Individually boxed.
- PD3J8** JUNIOR BASKET STRAINER. BRASS, Chrome Plated. Fits 2" or 2-1/2" opening. includes (PD8) three prong strainer, die cast slip joint nut, die cast lock nut, rubber washer, and tailpiece washer. Tailpiece NOT included. Individually boxed.
- PD3J8BR** JUNIOR BASKET STRAINER. Los Angeles Code. BRASS, Chrome Plated. Fits 2" or 2-1/2" opening. Includes (PD8) three prong strainer, BRASS slip joint nut, BRASS lock nut, rubber washer, and tailpiece washer. Tailpiece NOT included. Individually boxed.
- PD3BO** JUNIOR BASKET STRAINER, BASKET ONLY. Brass.



PD3J

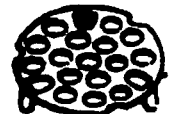

PD3J8

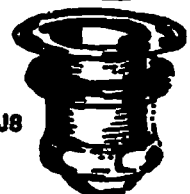

## MIDGET DUO STRAINERS

- PD3D** MIDGET DUO STRAINER. BRASS, Chrome Plated, with (PD3PBO) basket and plastic seat. Fits 2" or 2-1/2" opening. Includes die cast (SJ11RZ) slip joint, die cast (LN4) lock nut, (PD3RW) rubber washer, and (C87) tailpiece washer. Tailpiece NOT included. Individually boxed.
- PD3DBR** MIDGET DUO STRAINER. Los Angeles Code. BRASS, chrome plated, with (PD3PBO) basket and plastic seat. Fits 2" or 2-1/2" opening. Includes BRASS (SJ11XRB) slip joint nut, BRASS (LN4BR) lock nut, (PD3RW) rubber washer, and (C87) tailpiece washer. Tailpiece NOT included. Individually boxed.
- PD3DSS** MIDGET DUO STRAINER. Stainless Steel, with (PD3SSBO) stainless steel basket. Fits 2" or 2-1/2" opening. Includes die cast slip joint nut, die cast lock nut, rubber washer, and tailpiece washer. Tailpiece NOT included. Individually boxed.
- PD3SSBO** MIDGET DUO STRAINER, BASKET only. Stainless steel.



## LARGE BASKET STRAINERS

- 668** LARGE BASKET STRAINER, POST TYPE. Brass, chrome plated. Fits 3-1/2" to 4" openings. Includes die cast (SJ11RZ) slip joint nut, die cast (LN6) lock nut, (666RW) rubber washer, (SJ39R) friction ring, and (C87) tailpiece washer. Tailpiece NOT included. Individually boxed.
- 668BR** LARGE BASKET STRAINER, POST TYPE. Los Angeles Code. Brass, chrome plated. Fit 3-1/2" to 4" openings. Includes BRASS (SJ11XRB) slip joint nut, BRASS (LN6BR) lock nut, (666RW) rubber washer, (SJ39R) friction ring, and (C87) tailpiece washer. Tailpiece NOT included. Individually boxed.
- 668BO** POST TYPE, BASKET only. Brass, chrome plated.
- 666RW** HEAVY RUBBER WASHER. For large basket strainers.

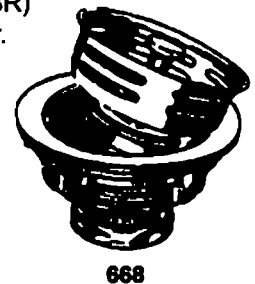

## P.O. PLUGS

- 251** GRID DRAIN -P.O. PLUG, CHROME PLATED. With solid grid strainer. Fits 1-1/2" opening. Size is 1-1/4" x 8".
- 253** LIFT & TURN LAVATORY, P.O. PLUG, 2 piece, Chrome Plated. Fits 1-1/2" opening. Size is 1-1/4" x 8".

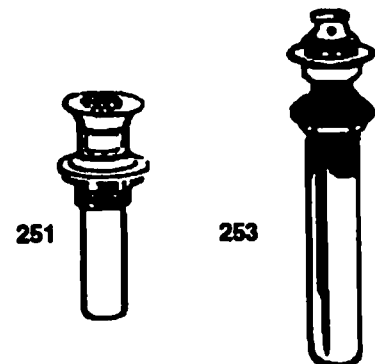

## CRUMB CUPS

- PD5 CRUMB CUP, for 1-1/2" Sink or Tray plugs. With Center Post. Metal.
- PD6 CRUMB CUP, for 1-1/2" Sink or Tray Plugs. Without Center Post. Metal.
- PD7 CRUMB CUP, for 1 " lavatory basin. Metal. 1-1/4" rim to rim.

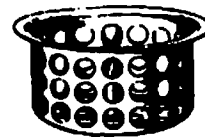

PD5

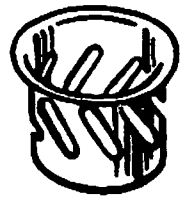

PD7

## STRAINERS

- PD91 DOME STRAINER, Stainless Steel, for bathtub. 2-7/8" O.D., with one (PD93) oval head screw.
- PD92 DOME STRAINER, Brass, chrome plated, for bathtub. 2-7/8" O.D. with one (PD93) oval head screw. Poly Bagged.
- PD93 SCREW, only. 10-24x2 plated. Use for PD91 and PD92
- PD69 BATH TUB STRAINER, BODY only. 2-13/16" O.D., Brass. Fits Tub waste and overflow with 1-3/8" shoe, fine thread.
- PD70 BATH TUB STRAINER BODY (PD69), with (PD9) three prong strainer and (PD3RW) rubber washer.
- PD71 BATH TUB STRAINER BODY (PD69), WITH (PD74) chain & stopper and (PD3RW) rubber washer.
- PD72 BATH TUB STRAINER BODY (PD3CPBO), 1-1/2" IPS threads, with (PD8) three prong strainer and (PD3RW) rubber washer. Fits Tub Waste & Overflow, with 1-1/2" show. Fits (Gerber)
- PD73 STOPPER ONLY. Rubber, hollow, with ring. 1-1/2".
- PD74 STOPPER & CHAIN only. hollow white rubber stopper, and 15" chain. Poly bagged.
- PD9 STRAINER, THREE PRONG, Stainless steel. SNAP-IN. 1-5/8" O.D.



PD91

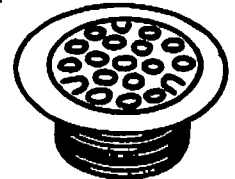

PD70



PD73

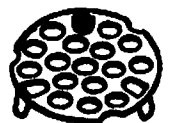

PD9

## LIFT & TURN BATH TUB DRAINS

- 199X LIFT & TURN BATH TUB DRAIN. Fits 1-1/2" opening. Brass, chrome plated. 11-1/2" threads per inch IPS.
- 185 LIFT & TURN BATH TUB PLUG, Brass, chrome plated. 1-5/8" O.D. Fine thread, 16 threads per inch.
- 186 BUSHING for TUB WASTE & OVERFLOW SHOE. Size from 1-1/2" to 1-3/8". Exterior threads are 11-1/2 threads per inch. Interior are 16 threads per inch. Rough brass.

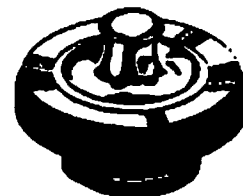

199X

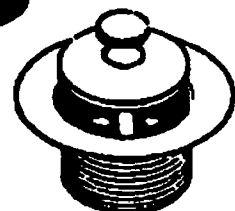

185

## OVERFLOW PLATES

PD14A BATH OVERFLOW PLATE, one Hole. Zinc die cast, Chrome Plated.

PD14A4S BATH OVERFLOW PLATE, One Hole. Zinc die cast, chrome plated. One (14S) oval head screw included. Poly bagged.

PD14A2 BATH OVERFLOW PLATE, One Hole. Zinc die cast, chrome plated. One (PD16CS) bolt, chain, and stopper included. Poly bagged.

PD14L BATH OVERFLOW PLATE, Two Hole. Zinc die cast, chrome plated.

PD14L14S BATH OVERFLOW PLATE, Two Hole. Zinc die cast, chrome plated. Two (14S) oval head screws included. Poly bagged.

PD14CS BATH OVERFLOW PLATE, Two Hole. Zinc die cast, chrome plated. One (PD74) chain and stopper included. Poly bagged.

PD150 OVERFLOW PLATE, brass, chrome plated. 3-1/8" O.D. Old style.

PD150CS Same as (PD150) except, includes (PD16CS) bolt, ring, chain, and stopper. Poly bagged.

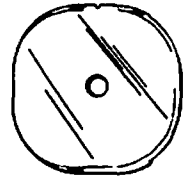

PD14A

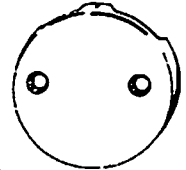

PD14L

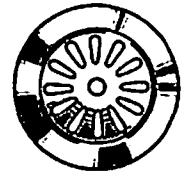

PD150

## TRIP LEVER PLATES

PD141 TRIP LEVER FACE PLATE, ROUND die cast, chrome plated, with spring and washer. Square handle. 3-1/4" O.D. Screws NOT included. 2" center to center screw holes.

PD41 Same as (PD 141) except, Includes two (14S) 1/4-20 x 1-1/2" machine screws. Poly bagged.

PD144 TRIP LEVER FACE PLATE, ROUND die cast, chrome plated, with spring and washer. Recessed handle. 3-1/4" O.D. Screws NOT included. 2" center to center screw holes.

PD44 Same as (PD144) except, Includes two (14S) 1/4-20 x 1-1/2" machine screws. Poly bagged.



PD141

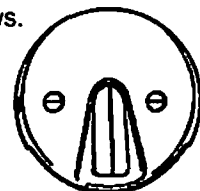

PD144

## OVERFLOW SCREWS, BOLTS, & RINGS

- 14S OVAL HEAD SCREW 1/4"-20 x 1-1/2", brass, chrome plated.
- 14SIB OVAL HEAD SCREW. 1/4"-20 x 1-1/2", brass, chrome plated.  
2 screws to a poly bag.
- 14L OVAL HEAD SCREW 1/4"-20 x 2", brass, chrome plated.
- 14LIB OVAL HEAD SCREW 1/4"-20 x 2", brass, chrome plated.  
2 screws to a poly bag.
- PD16 OVERFLOW BOLT & RING, 1/4"-20 x 1-1/2". Brass, chrome plated.

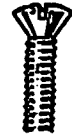

14S



PD16

## DISHWASHER - DISPOSAL HOSE & KITS

- PDD2K DISHWASHER -DISPOSAL CONNECTOR KIT. Assembled with 2 worm gear clamps.
- PDD4K DISHWASHER -DISPOSAL CONNECTOR KIT. Assembled with 4 screw clamps.



PDD2K



PDD4K

## SUREGRIP FLANGES - STEEL, CHROME PLATED

	<u>Size</u>		<u>Height</u>	<u>O.D.</u>
PF1S	3/8"	IPS	1/2"	2-1/2"
PF2S	1/2"	IPS	1/2"	2-1/2"
PF3S	3/4"	IPS	1/2"	2-1/2"
PF8S	1"	IPS	5/8"	2-7/8"
PF9S	1-1/4"	IPS	5/8"	2-7/8"
PFSA	1-1/2"	IPS	3/4"	3"
PFS	1-1/2"	IPS	3/4"	3-1/4"
PF10S	1-1/2"	IPS	3/4"	3-1/2"
PF24S	2"	IPS	3/4"	3-1/2"
PF26SA	1-1/4"	CWT	5/8"	2-7/8"
PF9SA	1-1/2"	CWT	5/8"	2-7/8"
PF5S	5/8"	OD	1/2"	2-1/2"
PF6S	7/8"	OD	1/2"	2-1/2"
PF4S1	1"	OD	1/2"	2-1/2"
PF21S	1-1/8"	OD	1/2"	2-1/2"
PF7S	1-1/4"	OD	5/8"	2-7/8"
PF26S	1-3/8"	OD	5/8"	2-7/8"
PF11S	1-1/2"	OD	5/8"	2-7/8"
PF23S	2"	OD	3/4"	3-1/2"



PF2S

## HIGH BOX FLANGES - STEEL, CHROME PLATED

	<u>Size</u>		<u>Height</u>	<u>O.D.</u>
PF14S	1-1/4"	IPS	1-3/4"	3"
PF12S	1-1/2"	IPS	1-3/4"	8"
PF14SA	1-1/2"	CWT	1-3/4"	3"
PF15S	1-1/4"	OD	1-3/4"	8"
PF13S	1-1/2"	OD	1-3/4"	3"
PF17S	2"	OD	1-3/4"	3"

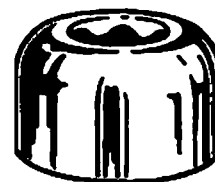

PF13S

## BELL FLANGES - STEEL, CHROME PLATED

	<u>Size</u>		<u>Height</u>	<u>O.D.</u>
PB100	3/8"	IPS	1-1/8"	2-3/8"
PB200	1/2"	IPS	1-1/8"	2-3/8"
PB300	3/4"	IPS	1-1/8"	2-3/8"
PB1400	1-1/4"	IPS	1-1/2"	3"
PB1200	1-1/2"	IPS	1-1/2"	3"
PB1400A	1-1/2"	CWT	1-1/2"	3"
PB400	3/8"	OD	1-1/8"	2-3/8"
PB500	1/2"	OD	1-1/8"	2-3/8"
PB600	5/8"	OD	1-1/8"	2-3/8"
PB1500	1-1/4"	OD	1-1/2"	3"
PB1300	1-1/2"	OD	1-1/2"	3"

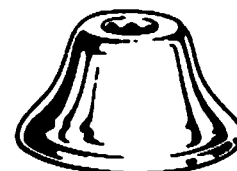

PB200

## SURE GRIP FLANGES - BRASS, CHROME PLATED

	<u>Size</u>		<u>Height</u>	<u>O.D.</u>
PF1B	3/8"	IPS	7/16"	2-1/2"
PF2B	1/2"	IPS	7/16"	2-1/2"
PF3B	3/4"	IPS	7/16"	2-1/2"
PF8B	1"	IPS	11/16"	3"
PF9B	1-1/4"	IPS	11/16"	3"
PF10B	1-1/2"	IPS	11/16"	3-1/2"
PF24B	2"	IPS	3/4"	3-1/2"
PF9BA	1-1/2"	CWT	11/16"	3"
PF5B	5/8"	OD	7/16"	2-1/2"
PF6B	7/8"	OD	7/16"	2-1/2"
PF7B	1-1/4"	OD	11/16"	3"
PF11B	1-1/2"	OD	11/16"	3"

## HIGH BOX FLANGES - BRASS, CHROME PLATED

	<u>Size</u>		<u>Height</u>	<u>O.D.</u>
PF14B	1-1/4"	IPS	1-7/8"	3"
PF12B	1-1/2"	IPS	1-7/8"	3"
PF14BA	1-1/2"	CWT	1-7/8"	3"
PF15B	1-1/4"	OD	1-7/8"	3"
PF13B	1-1/2"	OD	1-7/8"	3"
PF17B	2"	OD	1-7/8"	3"

## BELL FLANGES - BRASS, CHROME PLATED

	Size		Height	O.D.
PB100B	3/8"	IPS	1-1/8"	2-3/8"
PB200B	1/2"	IPS	1-1/8"	2-3/8"
PB500B	1/2"	OD	1-1/8"	2-3/8"
PB600B	5/8"	OD	1-1/8"	2-3/8"
PB1500B	1-1/4"	OD	1-1/2"	3"
PB1300B	1-1/2"	OD	1-1/2"	3"

## FLOOR & CEILING PLATES, SURE GRIP- 0.016 GAUGE STEEL, CHROME PLATED

	Size		O.D.
PF30	3/8"	IPS	2-7/8"
PF31	1/2"	IPS	2-7/8"
PF32	3/4"	IPS	2-7/8"
PF33	1"	IPS	3-5/8"
PF34	1-1/4"	IPS	3-5/8"
PF35	1-1/2"	IPS	3-5/8"
PF36	2"	IPS	4-5/8"
PF37A	1/2"	CWT	2-7/8"
PF38A	3/4"	CWT	2-7/8"
PF27A	1"	CWT	3-5/8"
PF28A	1-1/4"	CWT	3-5/8"
PF34A	1-1/2"	CWT	3-5/8"
PF37	5/8"	OD	2-7/8"
PF38	7/8"	OD	2-7/8"
PF27	1-1/8"	OD	3-5/8"
PF28	1-3/8"	OD	3-5/8"
PF29	1-5/8"	OD	3-5/8"

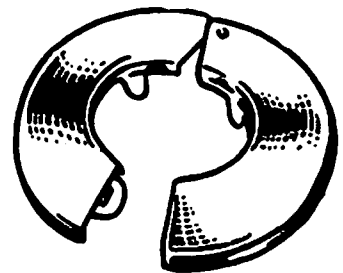

PF31

## FLOOR & CEILING PLATES, SPRING GRIP- 0.032 GAUGE STEEL, CHROME PLATED

	Size		O.D.
PF300	3/8"	IPS	2-1/2"
PF310	1/2"	IPS	2-1/2"
PF320	3/4"	IPS	2-7/8"
PF330	1"	IPS	3-1/4"
PF340	1-1/4"	IPS	3-5/8"
PF350	1-1/2"	IPS	3-7/8"
PF360	2"	IPS	4-1/2"
PF39	2-1/2"	IPS	5-1/2"
PF40	3"	IPS	6"



# FLOOR & CEILING PLATES, SPRING GRIP- 0.032 GAUGE STEEL, CHROME PLATED

	Size		O.D.
PF41	3-1/2"	IPS	6-5/8"
PF42	4"	IPS	7-1/8"
PF64	5"	IPS	8-3/4"
PF65	6"	IPS	10"
PF66	8"	IPS	13"
PF90A	3/8"	CWT	2-7/8"
PF370A	1/2"	CWT	2-1/2"
PF380A	3/4"	CWT	2-1/2"
PF43	1"	CWT	3"
PF44	1-1/4"	CWT	3-3/8"
PF340A	1-1/2"	CWT	3-5/8"
PF46	2"	CWT	4-1/4"
PF47	2-1/2"	CWT	4-7/8"
PF48	3"	CWT	5-1/4"
PF49	4"	CWT	6-5/8"
PF71	5"	CWT	8"
PF72	6"	CWT	10"
PF380	7/8"	OD	2-1/2"
PF370	5/8"	OD	2-1/2"
PF90	1/2"	OD	2-7/8"
PF91	1-1/8"	OD	3-5/8"
PF92	1-3/8"	OD	3-5/8"
PF93	1-5/8"	OD	3-5/8"

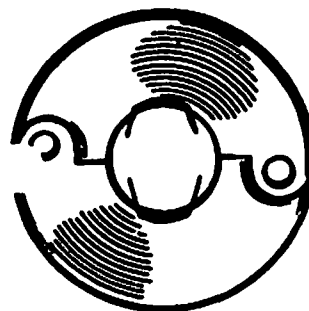

PF310

## SHOWER ROD

PF601 6'x1" BRASS. Chrome Plated, SHOWER ROD

## SHOWER ROD FLANGES

PF16S1 1" O.D. STEEL FLANGE SET, CONCEALED SCREWS, chrome plated.  
Includes two flanges, two brackets, and four screws. Poly bagged.

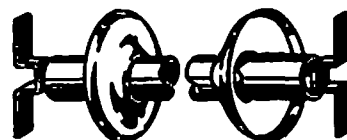

PF16S1

PF171S 1" O.D. STEEL FLANGE SET, EXPOSED SCREWS, chrome plated.  
Includes two flanges and four screws. Poly bagged. Sold on an each basis.



PF171S

**P** PLUMBING  
**P** PRODUCTS CO., INC.

## ADJUSTABLE ROD HOLDERS

PF221 1" O.D. ADJUSTABLE ROD HOLDER SET, die cast, chrome plated.

PF221CPP 1" O.D. ADJUSTABLE ROD HOLDER SET, poly, chrome plated.

PF22RP RUBBER PAD, for adjustable rod holders.



PF221

## SHOWER ROD CURTAIN PINS

PS3112B SHOWER ROD CURTAIN PINS, steel, chrome plated. 12 pins per poly bag.



PS3112B

## FAUCET HOLE COVERS

PS1SBA 1-3/4" O.D. FAUCET HOLE COVER, solid top, stainless steel.

PS1SB 2" O.D., FAUCET HOLE COVER, solid top, brass, chrome plated.



PS1SB

## BEADED CHAIN

PS102SP #10, BEADED CHAIN, 3/16" brass, nickel plated.  
Sold per 250 foot spools only.

PS82SP #8, BEADED CHAIN, 5/32", brass, nickel plated.  
Sold per 250 foot spools only.

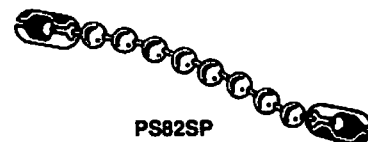

PS82SP

## RUBBER STOPPER

PS40 RUBBER STOPPER, 1-1/4", white, for C.O. and P.O. plugs.



PS40

## BASIN ROSETTES

PS6 BASIN ROSETTE, deep pattern, heavy steel, zinc plated.

PS7 BASIN ROSETTE, flat pattern, heavy steel, zinc plated.



PS6



PS7

## KEYS

SPK30 30" SPRINKLER KEY, heavy steel, nickel plated.

PS4 METER KEY, heavy duty, 5/8" rod, 25" rod, 25" shaft, 10" tee handle.  
Hardened steel-plated.

1918 10" GAS KEY. 5/16" square. Chrome plated.

1917 3" GAS KEY. 5/16" square.

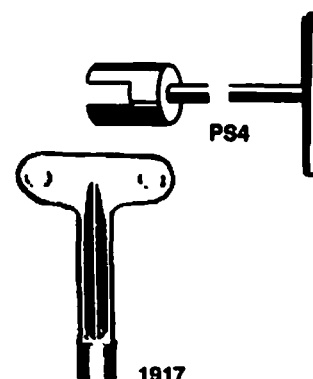

PS4

1917

**P** PLUMBING  
**P** PRODUCTS CO., INC.

(760) 343-3040 • Facsimile Number (760) 343-3609 and or (800) 562-9998

# VOLUME & FLOW CONTROLS

- PS17 VOLUME CONTROL, for shower heads, brass, chrome plated, with "O" ring seal. 1/2" inlet, 1/2" outlet. NOT 100% sealing. Poly bagged.
- PSFR FLOW CONTROL WASHER ONLY, black.



# SHOWER ARMS

- PS18 1/2" IPS x 6" SHOWER ARM. Brass, chrome plated.
- PS19 1/2" IPS x 8" SHOWER ARM. Brass, chrome plated.
- PS10 1/2" IPS x 10" SHOWER ARM. Brass, chrome plated.
- 151D "S" SHOWER ARM ONLY. Raises shower head to 10" Brass, chrome plated.

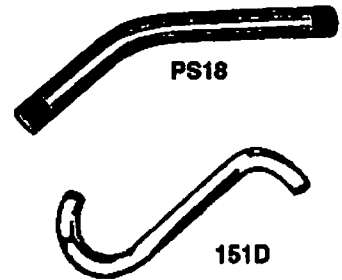

# SHOWER ARM FLANGES

- PF2LFS 2-1/2" diameter, ROUND SHOWER ARM FLANGE, Sure Grip style, steel, chrome plated. 1/2" IPS.
- PF31SS 2-1/2" diameter, ROUND SHOWER ARM FLANGE. Brass, chrome plated. 1/2" IPS.
- PF32SS 2-3/8" diameter, ROUND SHOWER ARM FLANGE. Steel, chrome plated. 1/2" IPS.
- PF3R 2-3/4" diameter, ROUND SHOWER ARM FLANGE. with SET SCREW. Zinc die cast, chrome plated. 1/2" IPS.



# TUB SPOUTS

- PS14 1/2" IPS, TUB SPOUT. Front thread, zinc die cast, chrome plated. Base diameter 2-5/8". Overall length 5-1/8".
- PS1170 1/2" IPS, TUB SPOUT. Back thread, brass, chrome plated.
- PS15QCLD QUICK CONNECT TUB SPOUT. Zinc die cast, chrome plated. Slide connect for 1/2" CWT.

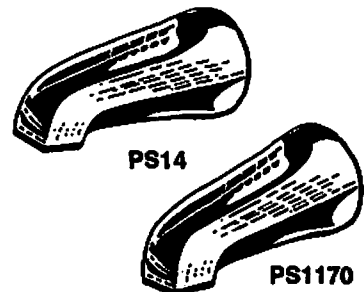

## DIVERTER TUB SPOUTS

**PS15SP2** 1/2" IPS, DIVERTER TUB SPOUT. Front thread, front lift, AUTOMATIC RETURN to tub fill position when water is turned off. Zinc die cast, chrome plated. Base diameter 2-5/8". Overall length 5-1/8".

**PS1602** 1/2" IPS, DIVERTER TUB SPOUT. Back thread, rear lift, AUTOMATIC RETURN to tub fill position when water is turned off. Zinc die cast, chrome plated. Base diameter 2-5/8". Overall length 5-1/8".

**PS1603** 3/4" IPS, DIVERTER TUB SPOUT. Back thread, rear lift, AUTOMATIC RETURN to tub fill position when water is turned off. Zinc die cast, chrome plated. Base diameter 2-5/8". Overall length 5-1/8".

**PS1215** 1/2" IPS, DIVERTER TUB SPOUT. Back thread, rear lift, Brass, chrome plated. Base diameter 2-3/8". Overall length is 5-1/8".

**PS1275** 3/4" IPS, DIVERTER TUB SPOUT. Back thread, rear lift, AUTOMATIC RETURN to tub fill position when water is turned off. Brass, chrome plated. Base diameter 2-3/8". Overall length 5-1/8".

**PS15QC** QUICK CONNECT DIVERTER TUB SPOUT. No threads, front lift. AUTOMATIC RETURN to tub fill position when water is turned off. Zinc, die cast, chrome plated. Base diameter 2-3/8". Overall length is 5-3/8". Slide connect for copper tubing.

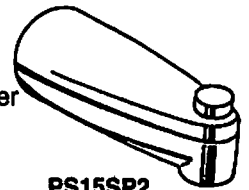

**PS15SP2**



**PS1602**

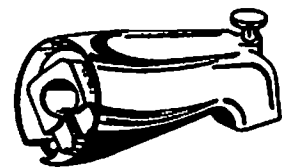

**PS15QC**

## REDUCER BUSHING

**PSB** REDUCER BUSHING, PLASTIC, for Tub Spouts. Changes 3/4" to a 1/2" size.

**PSB3** REDUCER BUSHING, BRASS, for Tub Spouts. Changes 3/4" to a 1/2" size.



**PSB**

## OFFSET BATH SUPPLIES

**3201S** SINGLE OFFSET BATH SUPPLY. 1/2" x 22", copper, chrome plated. One pair per box, includes two (PB500) bell flanges, two (SJ5) nuts, two (SJ43R) rings, two (SJ43W) washers, two (SJ3) nuts, two (SJ3R) rings, and two (SJ3W) washers. Sold one pair per box only.

**3202D** DOUBLE OFFSET BATH SUPPLY. 1/2" x 22", copper, chrome plated. One pair per box, includes two (PB500) bell flanges, two (SJ5) nuts, two (SJ43R) rings, two (SJ43W) washers, two (SJ3) nuts, two (SJ3R) rings, and two (SJ3W) washers. Sold one pair per box only.

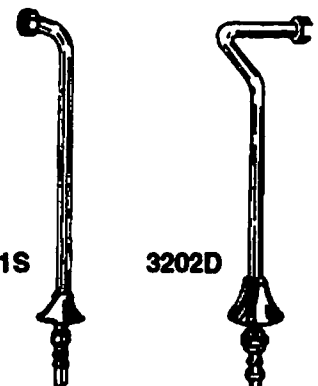

**3201S**

**3202D**

## LINCOLN FLANGES

F5 3/4" HIGH, LINCOLN FLANGE, zinc die cast, chrome plated. 2-3/4" diameter.



F5

F6 1-1/8" HIGH, LINCOLN FLANGE, zinc die cast, chrome plated. 2-3/4" diameter.

F6A 1-3/4" HIGH, LINCOLN FLANGE, zinc die cast, chrome plated. 2-3/4" diameter.



F6

## ESCUTCHEON NUTS & NIPPLES

S4BR ESCUTCHEON NUT, with tapered threads. Brass, chrome plated.

S5 ESCUTCHEON NIPPLE, with straight and tapered threads, for use with the (S4BR) nut. Brass.

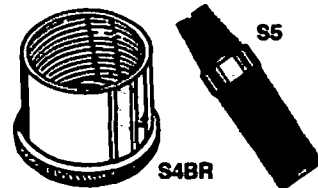

S4BR

S5

## BRASS RUNNING THREAD

RT1 5/8"-16 x 2 1/4" BRASS RUNNING THREAD.

RT2 5/8"-18 x 2 1/4" BRASS RUNNING THREAD.

RT3 5/8"-24 x 2 1/4" BRASS RUNNING THREAD.

RT4 9/16"-18 x 2 1/4" BRASS RUNNING THREAD.

RT5 9/16"-20 x 2 1/4" BRASS RUNNING THREAD.

RT6 9/16"-24 x 2 1/4" BRASS RUNNING THREAD.

## GAS TEST GAUGES

G230 0-30 lbs., 2" dial. One digit increments. 1/4" NPT Brass lower connection and metal case connects to 3/4" IPS line.

G260 0-60 lbs., 2" dial. Two digit increments. 1/4" NPT Brass lower connection and metal case connects to 3/4" IPS line.

G104A 1/4" IPS Tap, BODY ONLY for Gas Gauge. 2 x 1-1/8" hex body.

G106 VALVE STEM & CAP ONLY, for Gas Gauge.

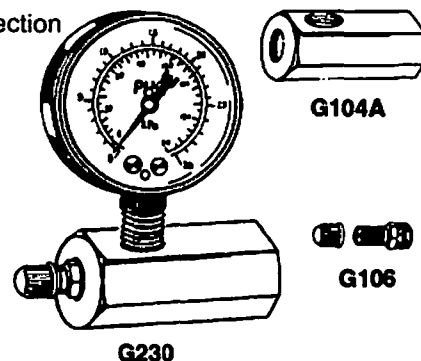

G230

G104A

G106

## WATER TEST GAUGES

W300 0-300 lbs., 2-1/2" dial. 10 digit increments. 1/4" NPT Brass upper connection and metal case with brass coupling nut, sleeve, and washer.

W304A BRASS COUPLING SLEEVE & WASHER 3/4 FHT.



## GENERAL PURPOSE GAUGES

BOTTOM MOUNT, 1/4" IPS CONNECTION BRASS SOCKET, HEAVY STEEL ENAMEL CASE ACCURACY IS + OR -2% AT MIDDLE OF SCALE.

2040 0-15 lbs., 2" dial.  
2540 0-15 lbs., 2-1/2" dial.

2042 0-30 lbs., 2" dial.  
2542 0-30 lbs., 2-1/2" dial.  
3542 0-30 lbs., 3-1/2" dial.  
4542 0-30 lbs., 4-1/2" dial.

2046 0-60 lbs., 2" dial.  
2546 0-60 lbs., 2-1/2" dial.  
3546 0-60 lbs., 3-1/2" dial.  
4546 0-60 lbs., 4-1/2" dial.

2048 0-100 lbs., 2" dial.  
2548 0-100 lbs., 2-1/2" dial.  
3548 0-100 lbs., 3-1/2" dial.  
4548 0-100 lbs., 4-1/2" dial.

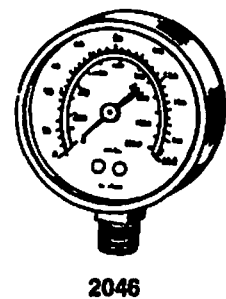

BOTTOM MOUNT, 1/4" IPS CONNECTION BRASS SOCKET, HEAVY STEEL ENAMEL CASE ACCURACY IS + OR -2% AT MIDDLE OF SCALE.

2052 0-160 lbs., 2" dial.  
2552 0-160 lbs., 2-1/2" dial.  
3552 0-160 lbs., 3-1/2" dial.  
4552 0-160 lbs., 4-1/2" dial.

2054 0-200 lbs., 2" dial.  
2554 0-200 lbs., 2-1/2" dial.  
3554 0-200 lbs., 3-1/2" dial.  
4554 0-200 lbs., 4-1/2" dial.

2058 0-300 lbs., 2" dial.  
2558 0-300 lbs., 2-1/2" dial.  
3558 0-300 lbs., 3-1/2" dial.  
4558 0-300 lbs., 4-1/2" dial.

## GENERAL PURPOSE GAUGES (CONTINUED)

2060	0-400 lbs., 2" dial.
2560	0-400 lbs., 2-1/2" dial.
3560	0-400 lbs., 3-1/2" dial.
4560	0-400 lbs., 4-1/2" dial.
2064	0-600 lbs., 2" dial.
2564	0-600 lbs., 2-1/2" dial.
3564	0-600 lbs., 3-1/2" dial.
4564	0-600 lbs., 4-1/2" dial.

## NIPPLE KADDY BOX

- K012 1/2" IPS close to 6". NIPPLE KADDY BOX, Steel. Holds 77 nipples. Individually boxed.
- K034 3/4" IPS close to 6". NIPPLE KADDY BOX, Steel. Holds 66 nipples. Individually boxed.
- K100 1" IPS close to 6". NIPPLE KADDY BOX, Steel. Holds 50 nipples. Individually boxed.
- K125 1-1/4" IPS close to 6". NIPPLE KADDY BOX, Steel. Holds 40 nipples. Individually boxed.
- K150 1-1/2" IPS close to 6". NIPPLE KADDY BOX, Steel. Holds 30 nipples. Individually boxed.
- K200 2" IPS close to 6". NIPPLE KADDY BOX, Steel. Holds 27 nipples. Individually boxed.

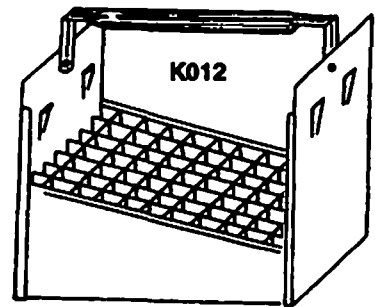

## FITTING KADDY BOX

- K300 FITTING KADDY BOX, Steel. 19-7/8" length, 9-7/8" width, 5" high. Separated by steel dividers into 8 equal sections. Individually boxed.
- K400 Same as (K300) except, without dividers. Individually boxed.

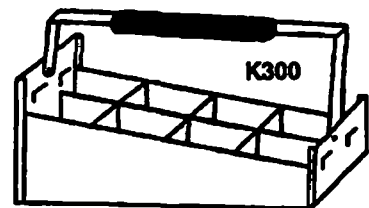

## TEST PLUGS ALSO KNOWN AS DYNAMITE PLUGS

- 4815 1-1/2" TEST PLUG, steel and rubber. For use with ABS, PVC and Cast Iron Pipe.
- 4820 2" TEST PLUG, steel and rubber. For use with ABS, PVC and Cast Iron Pipe.
- 4830 3" TEST PLUG, steel and rubber. For use with ABS, PVC and Cast Iron Pipe.
- 4840 4" TEST PLUG, steel and rubber. For use with ABS, PVC and Cast Iron Pipe.



4815

## WORK GLOVES

- 4060 8 oz. WORK GLOVES, cotton fabric. Clute cut with knit wrist. Sold in even dozens only.
- 4080 9 oz. WORK GLOVES, brown jersey, cotton fabric, knit wrist. Sold in even dozens only.
- 5010 work gloves, split leather palm, full leather index finger, knuckle strap, tips, elastic and safety cuff. Sold in even dozens only.
- 5070L DRIVING GLOVES, smooth leather, Gunn. Sold on an each basis.

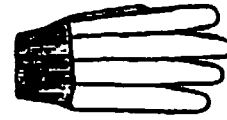

4060

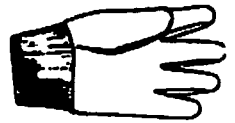

4080



5010



5070L

## HOSE TO PIPE, FITTINGS, BRASS

- HPS1 3/4 FHT x 1/2 FIP (swivel).
- HPS2 3/4 FHT x 3/4 FIP (swivel).
- HPS3 3/4 FHT x 3/4 FHT (swivel).
- HPH4 3/4 MHT x 3/4 MPT x 1/2 FIP.
- HPH5 3/4 MHT x 1/2 MIP x 1/2 CWT (nominal).
- HPH7 3/4 FHT x 3/4 MIP x 1/2 FIP.
- H10C 3/4 FHT hose cap only.
- HP60 3/4 MHT x 3/4 FPT.
- HP110 1/2 MIP x 3/4 FHT.
- HP130 3/4 MHT x 3/4 MHT.
- HP350 3/4 FHT x 3/4 FHT, "Y" connection.



HPS1

HPS2

HPS3



HPH4

HPH5

HPH7



H10C

HP60

HP110

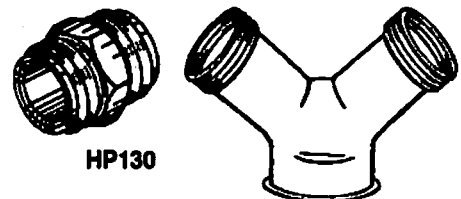

HP130

HP350

**P** PLUMBING  
**P** PRODUCTS CO., INC.



# LOCK NUTS

- LN1 1/2" LOCKNUT, Zinc die cast, for basin cock. 14 threads per inch.
- LN1BR 1/2" LOCKNUT, Brass, for basin cock. 14 threads per inch.
- LN2 15/16" LOCKNUT, Zinc die cast, for ball cock. 14 threads per inch.
- LN2BR 15/16" LOCKNUT, Brass, for ball cock. 14 threads per inch.
- LN2D 15/16" LOCKNUT, Delrin (plastic), for ball cock. 14 threads per inch.
- LN3 1-3/8" LOCKNUT, Zinc die cast, for P.O. plugs. 11-1/2 threads per inch.
- LN4 1-1/2" LOCKNUT, Zinc die cast, for Sink Plugs. 11-1/2 threads per inch.
- LN4BR 1-1/2" LOCKNUT, Brass, for Sink Plugs. 11-1/2 threads per inch.
- LN5 2" LOCKNUT, Zinc die cast, for closet spud & flush valve. 11-1/2 threads per inch.
- LN6 3-3/8" LOCKNUT, Zinc die cast, for basket strainers. 14 threads per inch.
- LN6BR 3-3/8" LOCKNUT, Brass, for basket strainers. 14 threads per inch.
- LN32L 5/8" hole size, LEFT HAND THREAD, LOCKNUT, Zinc die cast, for tank lever. 18 threads per inch.
- LN32P 5/8" hole size, LEFT HAND THREAD, LOCKNUT, Delrin (plastic), for tank lever. 18 threads per inch.



LN2

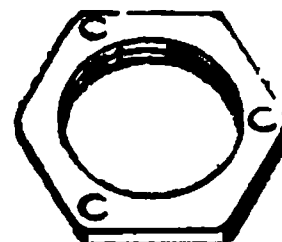

LN32L

# SLIP JOINT NUTS-ZINC DIE CAST-CHROME PLATED

- SJ1 1/2" IPS x 3/8".
- SJ2 1/2" IPS x 7/16".
- SJ3 1/2" IPS x 1/2".
- SJ5 3/4" IPS x 1/2" (Bath Supply).
- SJ7 1-1/4" IPS x 1-1/4".
- SJ9 1-1/2" IPS x 1-1/4".
- SJ10 1-1/2" IPS x 1-3/8".
- SJ11 1-1/2" IPS x 1-1/2".
- SJ12 2" IPS x 2".
- SJ4 15/16" BALLCOCK x 1/2" Zinc die, brass plated.



SJ2



SJ7



SJ2IB

## SLIP JOINT NUTS - ROUGH BRASS

---

- SJ1XRB 1/2" IPS 3/8" (machined).
- SJ2XRB 1/2" IPS x 7/16" (machined).
- SJ3XRB 1/2" IPS x 1/2" (machined).
- SJ7XRB 1-1/4" IPS x 1-1/4" (machined).
- SJ9XRB 1-1/2" IPS x 1-1/4" (machined).
- SJ11XRB 1-1/2" IPS x 1-1/2" (machined).
- SJ12XRB 2" IPS x 2" (machined).

## SLIP JOINT NUTS - BRASS, CHROME PLATED

---

- SJ1XCP 1/2" IPS x 3/8"
- SJ2XCP 1/2" IPS x 7/16".
- SJ3XCP 1/2" IPS x 1/2".
- SJ7XCP 1-1/4" IPS x 1-1/4".
- SJ9XCP 1-1/2" IPS x 1-1/4"
- SJ11XCP 1-1/2" IPS x 1-1/2".
- SJ12XCP 2" IPS x 2".

## SLIP JOINT NUTS - ZINC DIE CAST, CHROME PLATED WITH FRICTION RING & WASHER

---

- SJ1IB 1/2" IPS x 3/8." Includes (SJ1) slip joint nut, (SJ1R) friction ring, and (SJ1W) cone washer. Poly Bagged.
- SJ2IB 1/2" IPS x 7/16." Includes (SJ2) slip joint nut, (SJ2R) friction ring, and (SJ2W) cone washer. Poly Bagged.
- SJ3IB 1/2" IPS x 1/2." Includes (SJ3) slip joint nut, (SJ3R) friction ring, and (SJ3W) cone washer. Poly Bagged.
- SJ7IB 1-1/4" IPS x 1-1/4." Includes (SJ7) slip joint nut, (SJ7R) friction ring, and (SJ7W) square cut washer. Poly Bagged.

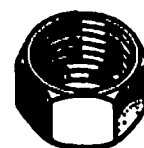

SJ3IB

## SLIP JOINT NUTS - ZINC DIE CAST, CHROME PLATED WITH FRICTION RING & WASHER (CONTINUED)

---

- SJ9IB 1-1/2" IPS x 1-1/4." Includes (SJ9) slip joint nut, (SJ9R) friction ring, and (SJ9W) square cut washer. Poly Bagged.
- SJ11IB 1-1/2" IPS x 1-1/2." Includes (SJ11) slip joint nut, (SJ11R) friction ring, and (SJ11W) square cut washer. Poly Bagged.
- SJ12IB 2" IPS x 2." Includes (SJ12) slip joint nut, (SJ12R) friction ring, and (SJ12W) square cut washer. Poly Bagged.

## SLIP JOINT NUTS BRASS, CHROME PLATED WITH FRICTION RING & WASHER

---

- SJ1XIB 1/2" IPS x 3/8." Includes (SJ1XCP) slip joint nut, (SJ1R) friction ring, and (SJ1W) cone washer. Poly Bagged.
- SJ2XIB 1/2" IPS x 7/16." Includes (SJ2XCP) slip joint nut, (SJ2R) friction ring, and (SJ2W) cone washer. Poly Bagged.
- SJ3XIB 1/2" IPS x 1/2." Includes (SJ3XCP) slip joint nut, (SJ3R) friction ring, and (SJ3W) cone washer. Poly Bagged.
- SJ7XIB 1-1/4" IPS x 1-1/4." Includes (SJ7XCP) slip joint nut, (SJ7R) friction ring, and (SJ7W) square cut washer. Poly Bagged.
- SJ9XIB 1-1/2" IPS x 1-1/4." Includes (SJ9XCP) slip joint nut, (SJ9R) friction ring, and (SJ9W) square cut washer. Poly Bagged.
- SJ11XIB 1-1/2" IPS x 1-1/2." Includes (SJ11XCP) slip joint nut, (SJ11R) friction ring, and (SJ11W) square cut washer. Poly Bagged.
- SJ12XIB 2" IPS x 2." Includes (SJ12XCP) slip joint nut, (SJ12R) friction ring, and (SJ12W) square cut washer. Poly Bagged.

## FRICTION RINGS-SLIP JOINT NUT

---

- SJ1R 5/8" O.D. x 3/8" I.D. Brass.
- SJ2R 5/8" O.D. x 7/16" I.D. Brass.
- SJ3R 5/8" O.D. x 1/2" I.D. Brass.
- SJ41R 15/16" ballcock x 3/8" I.D. Brass.

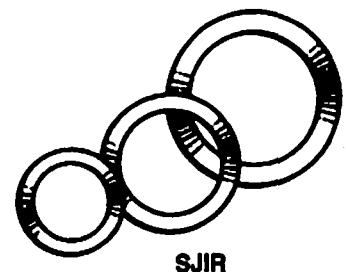

## FRICION RINGS-SLIP JOINT NUT (CONTINUED)

SJ42R	15/16" ballcock x 7/16" I.D. Brass.
SJ43R	15/16" ballcock x 1/2" I.D. Brass.
SJ7R	1-1/2" O.D. x 1-1/4" I.D. Brass.
SJ9R	1-3/4" O.D. x 1-1/4" I.D. Brass.
SJ10R	1-3/4" O.D. x 1-3/8" I.D. Brass.
SJ11R	1-3/4" O.D. x 1-1/2" I.D. Brass.
SJ12R	2-1/8" O.D. x 2" I.D. Brass.

## WASHERS-SLIP JOINT NUT

HW1	GARDEN HOSE WASHER ONLY.
SJ1W	3/4" O.D. x 3/8" I.D. CONE WASHER, rubber.
SJ2W	1/2" O.D. x 7/16" I.D. CONE WASHER, rubber.
SJ3W	5/8" O.D. x 1/2" I.D. CONE WASHER, rubber.
SJ41W	15/16" O.D. x 3/8" I.D. BALLCOCK WASHER, rubber.
SJ42W	15/16" O.D. x 7/16" I.D. BALLCOCK WASHER, rubber.
SJ43W	15/16" O.D. x 1/2" I.D. BALLCOCK WASHER, rubber.
SJ7W	1-1/4" O.D. x 1-1/4" I.D. SQUARE CUT WASHER, rubber.
SJ9W	1-1/2" O.D. x 1-1/4" I.D. SQUARE CUT WASHER, rubber.
SJ11W	1-1/2" O.D. x 1-1/2" I.D. SQUARE CUT WASHER, rubber.
SJ12W	2" O.D. x 2" I.D. SQUARE CUT WASHER, rubber.
SJ23W	2" O.D. x 1-1/2" I.D. SQUARE CUT WASHER, rubber.
SJ7WP	1-1/2" O.D. x 1-1/4" I.D. BEVELED POLY WASHER.
SJ9WP	1-3/4" O.D. x 1-1/4" I.D. BEVELED POLY WASHER.
SJ11WP	1-3/4" O.D. x 1-1/2" I.D. BEVELED POLY WASHER.

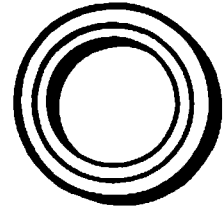

HW1



CONE AND  
S.J. WASHERS

## ABRASIVE CLOTH

- 1110 1-1/2" x 10 yards, 120 grit, WHITE, ABRASIVE CLOTH.
- 1125 1-1/2" x 25 yards, 120 grit, WHITE, ABRASIVE CLOTH.
- 3310 1-1/2" x 10 yards, 120 grit, BROWN, ABRASIVE CLOTH.
- 3325 1-1/2" x 25 yards, 120 grit, BROWN, ABRASIVE CLOTH.
- 55 1-1/2" X 5 yards, OPEN MESH, ABRASIVE CLOTH, Waterproof.
- 510 1-1/2" X 10 yards, OPEN MESH, ABRASIVE CLOTH, Waterproof.

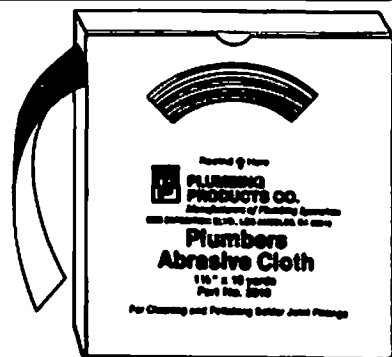

1110

## FITTING BRUSHES, TWISTED METAL HANDLES

- 6212 1/2" I.D., Copper, FITTING BRUSH. Sold per dozens only.
- 6234 3/4" I.D., Copper, FITTING BRUSH. Sold per dozens only.
- 6310 1" I.D., Copper, FITTING BRUSH. Sold per dozens only.
- 6325 1-1/4" I.D., Copper, FITTING BRUSH. Sold per dozens only.
- 6350 1-1/2" I.D., Copper, FITTING BRUSH. Sold per dozens only.
- 6420 2" I.D., Copper, FITTING BRUSH. Sold per dozens only.



6212

## ACID BRUSHES, METAL HANDLES

- 738 3/8" wide, 6" long, ACID BRUSH, horsehair. Sold 144 per box only.
- 812 1/2" wide, 6" long, ACID BRUSH, horsehair. Sold 144 per box only.

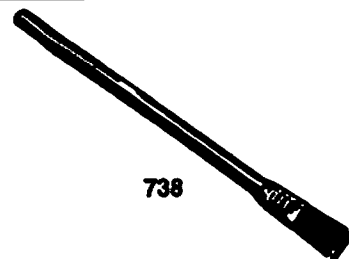

738

## COVER CASINGS

- 83 15/16" O.D. x 10" COVER CASING. Brass, chrome plated.
- 65 2" O.D. x 10" Cover CASING. Brass, chrome plated. (Use with PF23S flange.)



65

## DUCT HOSE

DVD5 4" x 5' DUCT HOSE. Plastic coated wire, flexible. Shrink pack.

DVD20 4" x 20' DUCT HOSE. Plastic coated wire, flexible. Shrink pack.



DVD5

## DRYER VENT HOODS & CLAMPS

DVH 4" DRYER VENT HOOD. Plastic hood, 12n aluminum pipe with flange.

DVK5 DRYER VENT KIT, COMPLETE. Includes one (DVD5) hose, one (DVH) hood, and two clamps.



DVH

## CLEANOUT COVER PLATES

CLEANOUT COVER PLATE with MACHINE SCREW, polished stainless steel. Countersunk hole will accept both 1/4" and 5/16" screws. Face of plate cover with protective paper. Plate comes with 1/4" - 20 x 4" plated machine screw.

<u>PART NUMBER</u>	<u>PLATE SIZE</u>
--------------------	-------------------

50243M	3" O.D.
--------	---------

50324M	4" O.D.
--------	---------

50405M	5" O.D.
--------	---------

50486M	6" O.D.
--------	---------

50567M	7" O.D.
--------	---------

50648M	8" O.D.
--------	---------

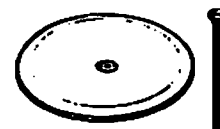

50243M

CLEANOUT COVER PLATE ONLY, polished stainless steel. Countersunk hole will accept both 1/4" and 5/16" screws. Face of plate cover with protective paper.

<u>PART NUMBER</u>	<u>PLATE SIZE</u>
--------------------	-------------------

50243	3" O.D.
-------	---------

50324	4" O.D.
-------	---------

50405	5" O.D.
-------	---------

50486	6" O.D.
-------	---------

50567	7" O.D.
-------	---------

50648	8" O.D.
-------	---------

# CLEANOUT COVER PLATES (CONTINUED)

SCREWS ONLY, for Cleanout Plates.

<u>PART NUMBER</u>	<u>SCREW SIZE</u>
5099M	Machine screw 1/4 - 20 x 4"

## CLOSET SCREWS

C1SO	1/4" x 2-1/2" BRASS SCREW.
C3SO	1/4" x 2-1/2" STEEL SCREW.
C2SO	1/4" x 3-1/2" BRASS SCREW.
C4SO	1/4" x 3-1/2" STEEL SCREW.
C1ASO	5/16" x 2-1/2" BRASS SCREW.
C2ASO	5/16" x 3-1/2" BRASS SCREW.



## CLOSET SCREW (or) HANGER BOLTS WITH NUT & WASHER

C1	1/4" X 2-1/2" CLOSET SCREW, BRASS. Includes (C1SO) Screw, (C9C) closed head BRASS nut, plated (C10) round STEEL washer, plated.
C1WRB	1/4" X 2-1/2" CLOSET SCREW, BRASS. Includes (C1SO) Screw, (C9C) closed head BRASS nut, plated and (C10B) round BRASS washer.
C1A	5/16" X 2-1/2" CLOSET SCREW, BRASS. Includes (C1ASO) Screw, (C9CA) closed head BRASS nut, plated (C10) round STEEL washer, plated.
C2	1/4" X 3-1/2" CLOSET SCREW, BRASS. Includes (C2SO) Screw, (C9C) closed head BRASS nut, plated (C10) round STEEL washer, plated.
C2WRB	1/4" X 3-1/2" CLOSET SCREW, BRASS. Includes (C2SO) Screw, (C9C) closed head BRASS nut, plated (C10B) round BRASS washer.
C2A	5/16" X 3-1/2" CLOSET SCREW, BRASS. Includes (C2ASO) Screw, (C9CA) closed head BRASS nut, plated (C10) round STEEL washer, plated
C2AWRB	1/4" X 2-1/2" CLOSET SCREW, BRASS. Includes (C2ASO) Screw, (C9C) closed head BRASS nut, plated (C10B) round BRASS washer.

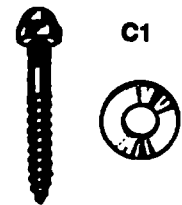

# CLOSET SCREW (or) HANGER BOLTS WITH NUT & WASHER (CONTINUED)

- C3 1/4" X 2-1/2" CLOSET SCREW, STEEL. Includes (C3SO) Screw, (C9CS) closed head STEEL nut, plated (C10) round STEEL washer, plated.
- C4 1/4" X 3-1/2" CLOSET SCREW, brass plated. Includes (C4SO) Screw, (C9CS) closed head STEEL nut, plated, and (C10) round STEEL washer, plated.

## CLOSET SCREW SETS WITH NUTS & ROUND WASHERS

- C1TL 1/4" x 2-1/2" CLOSET SCREWS, BRASS. Poly bagged with two (C1SO) screws, two (C9C) closed head BRASS nuts, plated, and two (C10) round STEEL washers, plated.
- C2TL 1/4" x 3-1/2" CLOSET SCREWS, BRASS. Poly bagged with two (C2SO) screws, two (C9C) closed head BRASS nuts, plated, and two (C10) round STEEL washers, plated.
- C3TL 1/4" x 2-1/2" CLOSET SCREWS, STEEL, brass plated. Poly bagged with two (C3SO) screws, two (C9CS) closed head STEEL nuts, plated, and two (C10) round STEEL washers, plated.
- C4TL 1/4" x 3-1/2" CLOSET SCREWS, STEEL, brass plated. Poly bagged with two (C4SO) screws, two (C9CS) closed head STEEL nuts, plated, and two (C10) round STEEL washers, plated.

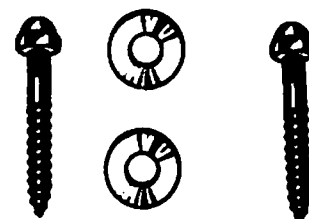

C1TL

## CLOSET BOLTS

- C53BO 1/4" x 1-3/4" CLOSET BOLT ONLY, Steel, brass plated.
- C5BO 1/4" x 2-1/4" CLOSET BOLT ONLY, Steel, brass plated.
- C5A3BO 5/16" x 1-3/4" CLOSET BOLT ONLY, Steel, brass plated.
- C5ABO 5/16" x 2-1/4" CLOSET BOLT ONLY, Steel, brass plated.
- C6BO 1/4" x 3-1/2" CLOSET BOLT ONLY, Steel, brass plated.
- C73BO 1/4" x 1-3/4" CLOSET BOLT ONLY, Brass.
- C7BO 1/4" x 2-1/4" CLOSET BOLT ONLY, Brass.
- C7A3BO 5/16" x 1-3/4" CLOSET BOLT ONLY, Brass.
- C7ABO 5/16" x 2-1/4" CLOSET BOLT ONLY, Brass.
- C8BO 1/4" x 3-1/2" CLOSET BOLT ONLY, Brass.
- C8ABO 5/16" x 3-1/2" CLOSET BOLT ONLY, Brass.



C5BO



## CLOSET BOLTS WITH NUT & OVAL WASHER

- C53 1/4" X 1-3/4" CLOSET BOLT, STEEL, brass plated. Includes (C53BO) bolt, (c90S) open head STEEL nut, plated, and (C11) oval STEEL washer, plated
- C5 1/4" X 2-1/4" CLOSET BOLT, STEEL, brass plated. Includes (C5BO) bolt, (C90S) open head STEEL nut, plated, and (C11) oval STEEL washer, plated.
- C5A3 5/16" x 1-3/4" CLOSET BOLT, STEEL, brass plated. Includes (C5A3BO) bolt, (C90AS) open head STEEL nut, plated, and (C11) oval STEEL washer, plated.
- C5A 5/16" x 2-1/4" CLOSET BOLT, STEEL, brass plated. Includes (C5ABO) bolt, (C90AS) open head STEEL nut, plated, and (C11) oval STEEL washer, plated.
- C6 1/4" X 3-1/2" CLOSET BOLT, STEEL, brass plated. Includes (C6BO) bolt, (C90S) open head STEEL nut, plated, and (C11) oval STEEL washer, plated.
- C7 1/4" X 2-1/4" CLOSET BOLT, BRASS. Includes (C7BO) bolt, (C90) open head BRASS nut, plated, and (C11) oval STEEL washer, plated.
- C7A 5/16" x 2-1/4" CLOSET BOLT, BRASS. Includes (C7ABO) bolt, (C90A) open head BRASS nut, plated, and (C11) oval STEEL washer, plated.
- C8 1/4" x 3-1/2" CLOSET BOLT, BRASS. Included (C8BO) bolt, (C90) open head BRASS nut, plated, and (C11) oval STEEL washer, plated.
- C8A 5/16" x 3-1/2" CLOSET BOLT, BRASS. Includes (C8ABO) bolt, (C90A) open head BRASS nut, plated, and (C11) oval STEEL washer, plated.

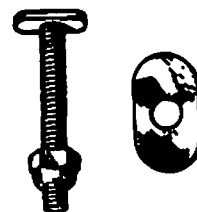

C53

## CLOSET BOLT WITH NUT & ROUND WASHER

- C5R 1/4" x 2-1/4" CLOSET BOLT, STEEL, brass plated. Includes (C5BO) bolt, (C90S) open head STEEL nut, plated, and (C10) round STEEL washer, plated.
- C6R 1/4" x 3-1/2" CLOSET BOLT, STEEL, brass plated. Includes (C6BO) bolt, (C90S) open head STEEL nut, plated, and (C10) round STEEL washer, plated.
- C7R 1/4" X 2-1/4" CLOSET BOLT SET, BRASS. Includes (C7BO) bolt, (C90) open head BRASS nut, plated, and (C10) round STEEL washer, plated.
- C7RWRB 1/4" x 2-1/4" CLOSET BOLT, BRASS. Includes (C7BO) bolt, (C90) open head BRASS nut, plated, and (C10B) round BRASS washer.
- C7RWRS 1/4" x 2-1/4" CLOSET BOLT, BRASS. Includes (C7BO) bolt, (C90) open head BRASS nut, plated, and (C10SS) round STAINLESS STEEL washer, plated.
- C7AR 5/16" x 2-1/4" CLOSET BOLT, BRASS. Includes (C7ABO) bolt, (C90A) open head BRASS nut, plated, and (c10) round STEEL washer, plated.
- C8R 1/4" x 3-1/2" CLOSET BOLT, BRASS. Includes (C8BO) bolt, (C90) open head BRASS nut, plated, and (C10) round STEEL washer, plated.
- C8AR 5/16" x 3-1/2" CLOSET BOLT, BRASS. Includes (C8ABO) bolt, (C90A) open head BRASS nut, plated, (C10) round STEEL washer, plated.

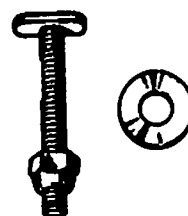

C5R

## CLOSET BOLT SETS WITH BRASS NUTS & SPEED NUTS

**C5TB** 1/4" x 2-1/4" CLOSET BOLT SET, STEEL, brass plated. Poly bagged. Includes two (C5BO) Bolts, two (C10) round STEEL washer, plated, two (C90) open head BRASS nuts, plated, and two (C9T) speed nuts.

**C7T** 1/4" x 2-1/4" CLOSET BOLT SET, BRASS. Poly bagged. Includes two (C7BO) bolts, two (C10) round STEEL washers, plated, two (C90) open head BRASS nuts, plated, and two (C9T) speed nuts.

**C8T** 1/4" x 3-1/2" CLOSET BOLT SET, BRASS. Poly bagged. includes two (C8BO) bolts, two (C10) round STEEL washer, plated, two (C90) open head BRASS nuts, plated, and two (C9T) speed nuts.

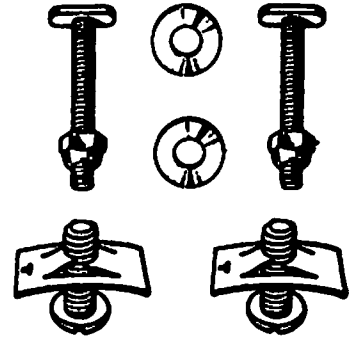

C5TB

## CLOSET BOLT SETS WITH STEEL NUTS & SPEED NUTS

**C53T** 1/4" x 1-3/4" CLOSET BOLT SET, STEEL, brass plated. Poly bagged. Includes two (C53BO) bolts, two (C10) round STEEL washers, plated, two (C90S) open head STEEL nuts, plated, and two (C9T) speed nuts.

**C5T** 1/4" x 2-1/4" CLOSET BOLT SET, STEEL, brass plated. Poly bagged. Includes two (C5BO) bolts, two (C10) round STEEL washers, plated, two (C90S) open head STEEL nuts, plated, and two (C9T) speed nuts.

**C5A3T** 5/16" x 1-3/4" CLOSET BOLT SET, STEEL, brass plated. Poly bagged. Includes two (C5A3BO) bolts, two (C10) round STEEL washers, plated, two (C90AS) open head STEEL nuts, plated, and two (C9TA) speed nuts.

**C6T** 1/4" x 3-1/2" CLOSET BOLT SET, STEEL, brass plated. Poly bagged. Includes two (C6BO) bolts, two (C10) round STEEL washers, plated, and two (C90S) open head STEEL nuts, plated, and two (C9T) speed nuts.

## CLOSET BOLT SETS WITH BRASS NUTS & ROUND WASHERS

**C5TLB** 1/4" x 2-1/4" CLOSET BOLT SET, STEEL, brass plated. Poly bagged. Includes two (C5BO) bolts, two (C10) round STEEL washers, plated, and two (C90) open head BRASS nuts, plated.

**C73TL** 1/4" x 1-3/4" CLOSET BOLT SET, BRASS. Poly bagged. Includes two (C73BO) bolts, two (C10) round STEEL washers, plated, and two (C90) open head BRASS nuts, plated.

**C7TL** 1/4" x 2-1/4" CLOSET BOLT SET, BRASS. Poly bagged. Includes two (C7BO) bolts, two (C10) round STEEL washers, plated, and two (C90) open head BRASS nuts, plated.

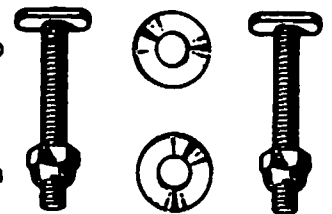

C5TLB

## CLOSET BOLT SETS WITH BRASS NUTS & ROUND WASHERS (CONTINUED)

- C7A3TL** 5/16" x 1-3/4" CLOSET BOLT SET, BRASS. Poly bagged. Includes two (C7A3BO) bolts, two (C10) round STEEL washers, plated, and two (C90A) open head BRASS nuts, plated.
- C8TL** 1/4" x 3-1/2" CLOSET BOLT SET, BRASS. Poly bagged. Includes two (C8BO) bolts, two (C10) round STEEL washers, plated, and two (C90) open head BRASS nuts, plated.

## CLOSET BOLT SETS WITH STEEL NUTS & ROUND WASHERS

- C53TL** 1/4" x 1-3/4" CLOSET BOLT SET, STEEL, brass plated. Poly bagged. Includes two (C53BO) bolts, two (C10) round STEEL washers, plated, and two (C90S) open head STEEL nuts, plated.
- C5TL** 1/4" x 2-1/4" CLOSET BOLT SET, STEEL, brass plated. Poly bagged. Includes two (C5BO) bolts, two (C10) round STEEL washers, plated, and two (C90S) open head STEEL nuts, plated.
- C5A3TL** 5/16" x 1-3/4" CLOSET BOLT SET, STEEL, brass plated. Poly bagged. Includes two (C5A3BO) bolts, two (C10) round STEEL washers, plated, and two (C90AS) open head STEEL nuts, plated.
- C5ATL** 5/16" x 2-1/4" CLOSET BOLT SET, STEEL, brass plated. Poly bagged. Includes two (C5ABO) bolts, two (C10) round STEEL washers, plated, and two (C90AS) open head STEEL nuts, plated.
- C6TL** 1/4" x 3-1/2" CLOSET BOLT SET, STEEL, brass plated. Poly bagged. Includes two (C6BO) bolts, two (C10) round STEEL washers, plated, and two (C90S) open head STEEL nuts, plated.

## CLOSET BOLT SETS WITH BRASS NUTS, ROUND WASHERS, & SQUARE NUTS

- C7TLQ** 1/4" x 2-1/4" CLOSET BOLT SET, BRASS. Poly bagged. Includes two (C7BO) bolts, two (C10) round STEEL washers, plated, two (C90) open head BRASS nuts, plated, and two (C90SQ) square STEEL nuts.
- C73TLQ** 1/4" x 1-3/4" CLOSET BOLT SET, BRASS. Poly bagged. Includes two (C73BO) bolts, two (C10) round STEEL washers, plated, two (C90) open head BRASS nuts, plated, and two (C90SQ) square STEEL nuts.
- C8TLQ** 1/4" x 3-1/2" CLOSET BOLT SET, BRASS. Poly bagged. Includes two (C8BO) bolts, two (C10) round STEEL washers, plated, two (C90) open head BRASS nuts, plated, and two (C90SQ) square STEEL nuts.

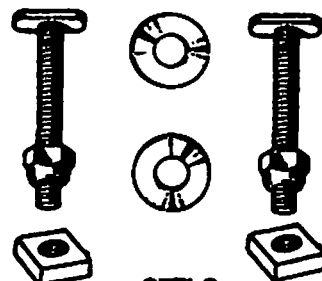

## CLOSET BOLT SETS WITH STEEL NUTS, ROUND WASHERS, & SQUARE NUTS

---

- C53TLQ** 1/4" x 1-3/4" CLOSET BOLT SET, STEEL, brass plated. Poly bagged. Includes two (C53BO) bolts, two (C10) round STEEL washers, plated, two (C90S) open head STEEL nuts, plated, and two (C9OSQ) square STEEL nuts.
- C5TLQ** 1/4" x 2-1/4" CLOSET BOLT SET, STEEL, brass plated. Poly bagged. Includes two (C5BO) bolts, two (C10) round STEEL washers, plated, two (C90S) open head STEEL nuts, plated, and two (C9OSQ) square STEEL nuts.
- C6TLQ** 1/4" x 3-1/2" CLOSET BOLT ONLY, STEEL, brass plated. Poly bagged. Includes two (C6BO) bolts, two (C10) round STEEL washers, plated, two (C90S) open head STEEL nuts, plated, and two (C9OSQ) square STEEL nuts.

## CLOSET BOLT SETS WITH BRASS NUTS & OVAL WASHERS

---

- C73TOL** 1/4" x 1-3/4" CLOSET BOLT SET, BRASS. Poly bagged. Includes two (C73BO) bolts, two (C11) oval STEEL washers, plated, and two (C90) open head BRASS nuts, plated.
- C7TOL** 1/4" x 2-1/4" CLOSET BOLT SET, Brass. Poly bagged. Includes two (C7BO) bolts, two (C11) oval STEEL washers, plated, and two (C90) open head BRASS nuts, plated.
- C7A3TOL** 5/16" x 1-3/4" CLOSET BOLT SET, Brass. Poly bagged. Includes two (C7A3BO) bolts, two (C11) oval STEEL washers, plated, and two (C90A) open head BRASS nuts, plated.
- C7ATOL** 5/16" x 2-1/4" CLOSET BOLT SET, Brass. Poly bagged. Includes two (C7A3BO) bolts, two (C11) oval STEEL washers, plated, and two (C90A) open head BRASS nuts, plated.
- C8TOL** 1/4" x 3-1/2" CLOSET BOLT SET, Brass. Poly bagged. Includes two (C8BO) bolts, two (C11) oval STEEL washers, plated, and two (C90) open head BRASS nuts, plated.
- C8ATOL** 5/16" x 3-1/2" CLOSET BOLT SET, Brass. Poly bagged. Includes two (C8ABO) bolts, two (C11) oval STEEL washers, plated, and two (C90A) open head BRASS nuts, plated.

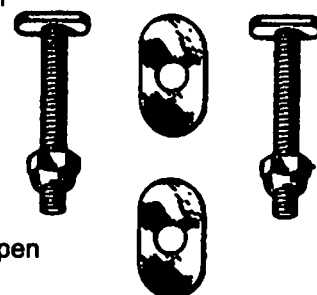

C7TOL

## CLOSET BOLT SETS WITH STEEL NUTS & OVAL WASHERS

- C53TOL** 1/4" x 1-3/4" CLOSET BOLT SET, STEEL, brass plated. Poly bagged. Includes two (C53BO) bolts, two (C11) oval STEEL washers, plated, and two (C90S) open head STEEL nuts, plated.
- C5TOL** 1/4" x 2-1/4" CLOSET BOLT SET, STEEL, brass plated. Poly bagged. Includes two (C5BO) bolts, two (C11) oval STEEL washers, plated, and two (C90S) open head STEEL nuts, plated.
- C5A3TOL** 5/16" x 1-3/4" CLOSET BOLT SET, STEEL, brass plated. Poly bagged. Includes two (C5A3BO) bolts, two (C11) oval STEEL washers, plated, and two (C90AS) open head STEEL nuts, plated.
- C5ATOL** 5/16" x 2-1/4" CLOSET BOLT SET, STEEL, brass plated. Poly bagged. Includes two (C5ABO) bolts, two (C11) oval STEEL washers, plated, and two (C90AS) open head STEEL nuts, plated.
- C6TOL** 1/4" x 3-1/2" CLOSET BOLT SET, STEEL, brass plated. Poly bagged. Includes two (C6BO) bolts, two (C11) oval STEEL washers, plated, and two (C90S) open head STEEL nuts, plated.

## CLOSET BOLT SETS WITH BRASS NUTS, OVAL WASHERS & SQUARE NUTS

- C73TOLQ** 1/4" x 1-3/4" CLOSET BOLT SET, BRASS. Poly bagged. Includes two (C73BO) bolts, two (C11) oval STEEL washers, plated, two (C90) open head BRASS nuts, plated, and two (C9OSQ) square STEEL nuts.
- C7TOLQ** 1/4" x 2-1/4" CLOSET BOLT SET, BRASS. Poly bagged. Includes two (C7BO) bolts, two (C11) oval STEEL washers, plated, two (C90) open head BRASS nuts, plated, and two (C9OSQ) square STEEL nuts.
- C8TOLQ** 1/4" x 3-1/2" CLOSET BOLT SET, BRASS. Poly bagged. Includes two (C8BO) bolts, two (C11) oval STEEL washers, plated, two (C90) open head BRASS nuts, plated, and two (C9OSQ) square STEEL nuts.

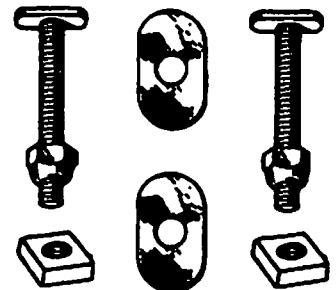

**C7TOLQ**

## CLOSET BOLT SETS WITH STEEL NUTS, OVAL WASHERS & SQUARE NUTS

- C53TOLQ** 1/4" x 1-3/4" CLOSET BOLT SET, STEEL, brass plated. Poly bagged. Includes two (C53BO) bolts, two (C11) oval STEEL washers, plated, two (C90S) open head STEEL nuts, plated, and two (C90SQ) square STEEL nuts.
- C5TOLQ** 1/4" x 2-1/4" CLOSET BOLT SET, STEEL, brass plated. Poly bagged. Includes two (C5BO) bolts, two (C11) oval STEEL washers, plated, two (C90S) open head STEEL nuts, plated, and two (C90SQ) square STEEL nuts.
- C6TOLQ** 1/4" x 3-1/2" CLOSET BOLT SET, STEEL, brass plated. Poly bagged. Includes two (C6BO) bolts, two (C11) oval STEEL washers, plated, two (C90S) open head STEEL nuts, plated, and two (C90SQ) square STEEL nuts.

## CLOSET BOLT SETS WITH BRASS NUTS, OVAL WASHERS & SPEED NUTS

- C73T0** 1/4" x 1-3/4" CLOSET BOLT SET, BRASS. Poly bagged. Includes two (C73BO) bolts, two (C11) oval STEEL washers, plated, two (C90) open head BRASS nuts, plated, and two (C9T) speed nuts.
- C7T0** 1/4" x 2-1/4" CLOSET BOLT SET, BRASS. Poly bagged. Includes two (C7BO) bolts, two (C11) oval STEEL washers, plated, two (C90) open head BRASS nuts, plated, and two (C9T) speed nuts.
- C7A3T0** 5/16" x 1-3/4" CLOSET BOLT SET, BRASS. Poly bagged. Includes two (C7A3BO) bolts, two (C11) oval STEEL washers, plated, two (C90A) open head BRASS nuts, plated, and two (C9TA) speed nuts.
- C7AT0** 5/16" x 2-1/4" CLOSET BOLTS SET, BRASS. Poly bagged. Includes two (C7ABO) bolts, two (C11) oval STEEL washers, plated, two (C90A) open head BRASS nuts, plated, and two (C9TA) speed nuts.
- C8T0** 1/4" x 3-1/2" CLOSET BOLT SET, BRASS. Poly bagged. Includes two (C8BO) bolts, two (C11) oval STEEL washers, plated, two (C90) open head BRASS nuts, plated, and two (C9T) speed nuts.
- C8AT0** 5/16" x 3-1/2" CLOSET BOLT SET, BRASS. Poly bagged. Includes two (C8ABO) bolts, two (C11) oval STEEL washers, plated, two (C90A) open head BRASS nuts, plated, and two (C9TA) speed nuts.

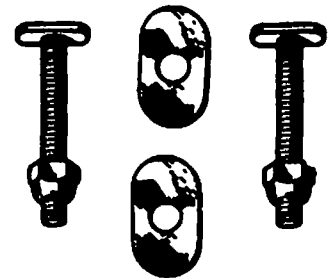

C73T0

## CLOSET BOLT SETS WITH STEEL NUTS, OVAL WASHERS & SPEED NUTS

---

- C53T0** 1/4" x 1-3/4" CLOSET BOLT SET, STEEL, brass plated. Poly bagged. Includes two (C53BO) bolts, two (C11) oval STEEL washers, plated, two (C90S) open head STEEL nuts, plated, and two (C9T) speed nuts.
- C5T0** 1/4" x 2-1/4" CLOSET BOLT SET, STEEL, brass plated. Poly bagged. Includes two (C5BO) bolts, two (C11) oval STEEL washers, plated, two (C90S) open head STEEL nuts, plated, and two (C9T) speed nuts.
- C5A3T0** 5/16" x 1-3/4" CLOSET BOLT SET, STEEL, brass plated. Poly bagged. Includes two (C5A3BO) bolts, two (C11) oval STEEL washers, plated, two (C90AS) open head STEEL nuts, plated, and two (C9TA) speed nuts.
- C5AT0** 5/16" x 2-1/4" CLOSET BOLT SET, STEEL, brass plated. Poly bagged.. Includes two (C5ABO) bolts, two (C11) oval STEEL washers, plated, two (C90AS) open head STEEL nuts, plated, and two (C9TA) speed nuts.

## CLOSET BOLT SET WITH BRASS NUT, ROUND WASHERS & SQUARE NUT

---

- C7RQ** 1/4" x 2-1/4" CLOSET BOLT SET, BRASS. Assembled on bolt. Includes one (C7BO) bolt, two (C10) round STEEL washers, plated, one (C90SO) square STEEL nut, plated, and one (C90) open head BRASS nut, plated.
- C7RQP** Same as (C7RQ) except, UNASSEMBLED. Each set poly bagged.
- C8RQ** 1/4" x 3-1/2" CLOSET BOLT SET, BRASS. Assembled on bolt. Includes one (C8BO) bolt, two (C10) round STEEL washers, one (C90SQ) square STEEL nut, and one (C90) open head BRASS nut, plated.
- C8RQP** Same as (C8RQ) except, UNASSEMBLED. Each set poly bagged.

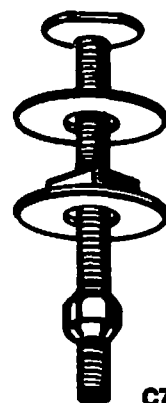

## CLOSET BOLT SET WITH STEEL NUT, ROUND WASHERS & SQUARE NUT

---

- C5RQ** 1/4" x 2-1/4" CLOSET BOLT SET, STEEL, brass plated. Assembled on bolt. Includes one (C5BO) bolt, two (C10) round STEEL washers, plated, one (C90SQ) square STEEL nut, plated, and one (C90S) open head STEEL nut, plated.
- C5RQP** Same as (C5RQ) except, UNASSEMBLED. Each set poly bagged.
- C6RQ** 1/4" x 3-1/2" CLOSET BOLT SET, STEEL, brass plated. Assembled on bolt. Includes one (C6BO) bolt, two (C10) round STEEL washers, plated, one (C90SQ) square STEEL nut, plated, and one (C90S) open head STEEL nut, plated.
- C6RQP** Same as (C6RQ) except, UNASSEMBLED. Each set poly bagged.

## NO TURN CLOSET BOLTS & SETS

- C65BO 1/4" x 2-1/4" NO TURN, CLOSET BOLT, STEEL, brass plated.
- C75BO 1/4" x 2-1/4" NO TURN, CLOSET BOLT, BRASS.
- C66 1/4" x 2-1/4" NO TURN, CLOSET BOLT SET, STEEL, brass plated. Poly bagged. Includes two ( C65BO) bolts, two (C10) round STEEL washers, plated, two (C90S) open head STEEL nuts, plated, and two (C9T) speed nuts.
- C76 1/4" x 2-1/4" NO TURN, CLOSET BOLT SET, BRASS. Poly bagged. Includes two (C75BO) bolts, two (C10) round STEEL washers, plated, two (C90) open head BRASS nuts, plated, and two (C9T) speed nuts.

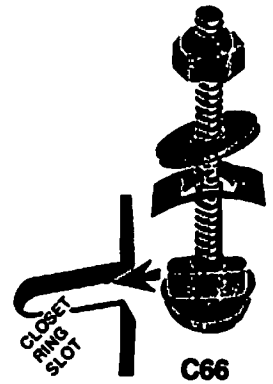

## NO TURN CLOSET BOLTS & CAP SETS

- C77D 1/4" x 2-1/4" NO TURN, CLOSET BOLT & CAP SET, BRASS. Poly bagged Includes two (C75BO) bolts, two (C10) round STEEL washers, plated, two (C90) open head BRASS nuts, plated, two (C9T) speed nuts, and two (C50P) round plastic bolt caps.
- C77X Same as (C77D). Sold in Bulk quantities.
- C67D 1/4" x 2-1/4" NO TURN, CLOSET BOLT & CAP SET, STEEL. Poly bagged. Includes two (C65BO) bolts, two (C10) round STEEL washer, plated, two (C90S) open head STEEL nuts, plated, two (C9T) speed nuts, and two (C50P) round plastic bolt caps.
- C67X Same as (C67D). Sold in Bulk quantities.



## CLOSE COUPLED BOLT SETS & PARTS

- C19 5/16" x 3" CLOSET COUPLED BOLT SET, Brass. Poly bagged. Includes two (C19BO) bolts, four (CBLKR) rubber washer, four (C10) round STEEL washer, plated, two (N19H) hex nuts, and two (N19W) wing nuts. Sponge gasket NOT included.
- C20 Same as (C19) except, Sponge gasket (C20W) included.
- C19BO 5/16" x 3" BRASS BOLT.
- N19H 5/16" - 18 HEX JAM NUT, Steel, plated.
- N19W 5/16" - 18 WING NUT, Steel, plated.
- C20W SPONGE GASKET, for most close coupled toilets and flush valves.
- CBLKR RUBBER WASHER, black, for C19 and C20 bolt sets.

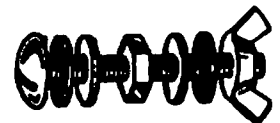

C20



N19H



N19W



C20W



# STUD HOLDERS

C212 1/4" - 20 CLOSET FLANGE STUD HOLDER. Brass.

C212

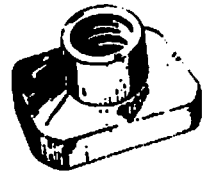

# THREADED RODS

C12A 1/4" - 20 x 2-1/2" THREADED ROD, Brass.



C12A

# CLOSET STUD SET

C12 CLOSET STUD SET, (Portland Code.) Includes one (C12A) threaded rod, 1/4" - 20 x 2-1/2", one (C11) oval STEEL washer, plated, and one (C90) open head BRASS nut, plated.



C12



# NUTS & WASHERS

C90 1/4" - 20 OPEN HEAD BRASS NUT, plated.

C90S 1/4" - 20 OPEN HEAD STEEL NUT, plated.

C90SQ 1/4" - 20 SQUARE STEEL NUT, plated.

C9C 1/4" - 20 CLOSED HEAD BRASS NUT, plated.

C9CS 1/4" - 20 CLOSED HEAD STEEL NUT, plated.

C9T 1/4" SPEED NUT-Plastic.

C90A 5/16" - 18 OPEN HEAD BRASS NUT, plated.

C90AS 5/16" - 18 OPEN HEAD STEEL NUT, plated.

C9CA 5/16" - 18 CLOSED HEAD BRASS NUT, plated.

C9TA 5/16" SPEED NUT-Plastic.

C10 5/16" ROUND STEEL WASHER.

C10B 5/16" ROUND BRASS WASHER.

C10SS 5/16" ROUND STAINLESS STEEL WASHER.

C11 5/16" OVAL STEEL WASHER, plated.

C11SS 5/16" OVAL STAINLESS STEEL WASHER.



C90



C90SQ



C9C



C9T



C10



C11

## REFILL & OVERFLOW TUBES

- C22 1 "O.D. x 10" OVERFLOW TUBE, Brass, threaded one end.
- C1777 1-1/2" O.D. x 18" OVERFLOW TUBE, Brass 20 gauge. Threaded one end.
- C37 1 "O.D. x 1-1/8" O.D. x 10" OVERFLOW TUBE, Brass, threaded both end.

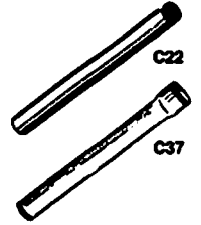

## FLOAT RODS

- C25 1/4" x 8" FLOAT ROD, Brass, threaded both ends.
- C26 1/4" x 9" FLOAT ROD, Brass, threaded both ends.
- C27 1/4" x 10" FLOAT ROD, Brass, threaded both ends.
- C28 1/4" x 12" FLOAT ROD, Brass, threaded both ends.



## CLOSET GUIDES

- C29A ADJUSTABLE CLOSET GUIDE, Cast brass, fits 1", 1-1/8", 1-1/4" O.D. overflow tubes.
- C29D DUNCAN ADJUSTABLE CLOSET GUIDE, one screw adjusts & tightens. Fits 1", 1-1/8", 1-1/4" O.D. overflow tubes.
- C30 SOLID CLOSET GUIDE, Cast brass. Fits 1 "O.D. overflow tube.

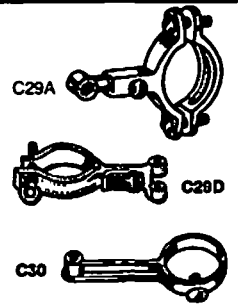

## LIFT WIRE

- C13S 4-1/2" LOWER LIFT WIRE, Brass.
- C13 5" LOWER LIFT WIRE, Brass.
- C17 9" UPPER LIFT WIRE, Brass.

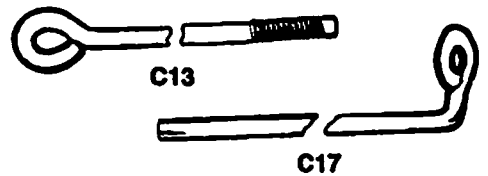

## TANK LEVERS

- C32 TANK LEVER, Chrome plated, die cast handle. 8" brass arm.
- C33 TANK LEVER, Chrome plated, die cast, deluxe handle. 8" brass arm.

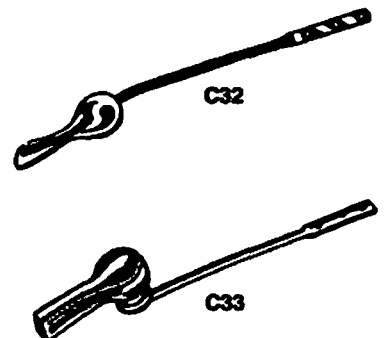

## TANK LEVERS (CONTINUED)

- C31A TANK LEVER, Chrome plated, die cast handle. 8" metal arm, Fortalloy finish, and plastic spud.
- C31P TANK LEVER, Chrome plated, die cast handle. 8" plastic arm, and plastic spud.
- C320 TANK LEVER, Chrome plated, die cast, ARROW handle. 8" brass arm.

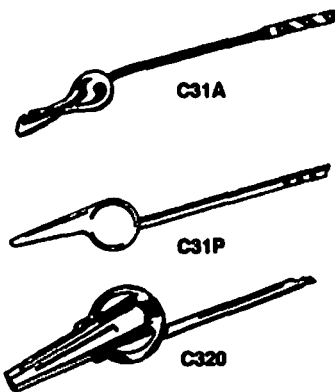

## FLUSH VALVES

- C38AP FLUSH VALVE, All plastic, with flapper and stainless steel chain. Sold 25 per box only.
- C34BRX DOUGLAS type, FLUSH VALVE. Cast brass with 1" BRASS overflow tube. Solid guide, 2" BRASS locknut and rubber washer. Sold on an each basis.

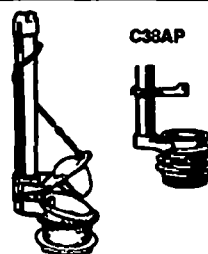

## SPAN SEAL REPAIR FLANGE

- SSRP SPAN SEAL REPAIR FLANGE. Sold 12 per box only.

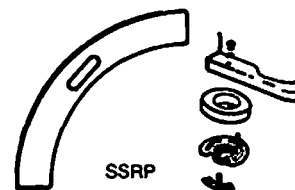

## CLOSET BOLT CAPS & HOLDERS

- C50P BOLT CAPS, Round white plastic. Fits on 7/16" hex nuts.
- C50PIB Same as (C50P) except, packaged and sold two caps per poly bag.
- C51P BOLT CAPS, Oval white plastic. Fits on 7/16" hex nuts.
- C51PIB Same as (C51P) except, packaged and sold two caps per poly bag.
- C55 BOLT CAPS & HOLDERS, Round white plastic. Fits all nuts.
- C56 Same as (C55) except, packaged and sold 2 caps and 2 holders per poly bag.

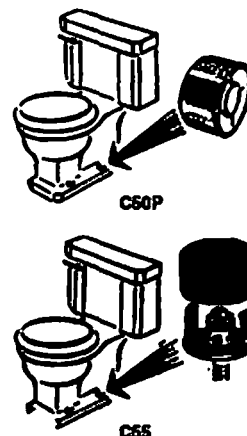

## URINAL & CLOSET SPUDS

---

- C72 1" x 3/4" BRASS URINAL SPUD. Includes one (FR72) friction ring, and one (W72) rubber washer. Individually boxed.
- C73 1-1/4" x 3/4" BRASS URINAL SPUD. Includes one (FR74) friction ring, and one (W74) rubber washer. Individually boxed.
- C74 1-1/4" x 1-1/4" BRASS CLOSET SPUD. Includes one (FR74) friction ring, and one (W74) rubber washer. Individually boxed.
- C81 1-1/2" x 1-1/2" BRASS CLOSET SPUD. Includes one (FR81) friction ring, and one (W81) rubber washer. Individually boxed.
- C82 2" x 2" BRASS CLOSET SPUD. Includes one (FR82) friction ring, and one (W82) rubber washer. Individually boxed.
- C83 2" x 1-1/2" BRASS CLOSET SPUD. Includes one (FR83) friction ring and one (W83) rubber washer. Individually boxed.
- C84 2" x 1-1/4" BRASS CLOSET SPUD. Includes one (FR83) friction ring and one (W83) rubber washer. Individually boxed.
- C88 1-1/2" x 1-1/4" BRASS CLOSET SPUD. Includes one (FR81) friction ring and one (W81) rubber washer. Individually boxed.



C72

## FRICTION RINGS FOR URINAL & CLOSET

---

- FR72 1" x 3/4" FRICTION RING, galvanized.
- FR74 1-1/4" x 1-1/4" FRICTION RING, galvanized.
- FR81 1-1/2" x 1-1/2" FRICTION RING, galvanized.
- FR82 2" X 2" FRICTION RING, galvanized.
- FR83 2" X 1-1/2" FRICTION RING, galvanized.

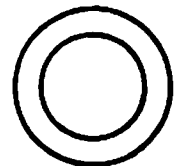

FR72

## RUBBER WASHERS FOR URINAL & CLOSET SPUDS

---

- W72 1" x 3/4" RUBBER WASHER. Sold 100 per box only.
- W74 1-1/4" x 1-1/4" RUBBER WASHER. Sold 100 per box only.
- W81 1-1/2" x 1-1/2" RUBBER WASHER. Sold 100 per box only.
- W82 2" X 2" RUBBER WASHER. Sold 100 per box only.
- W83 2" X 1-1/2" RUBBER WASHER. Sold 100 per box only.



W72

## CLOSET TANK BALLS

---

C85P 4" x 5" PLASTIC FLOAT BALL, with threaded spud.  
Packaged and sold 100 per box only.

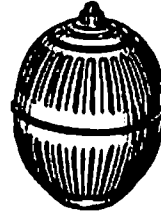

C85P

C86 SEAT - ALL TANK BALL. Curved surface. Individually boxed.  
Sold on an each basis.

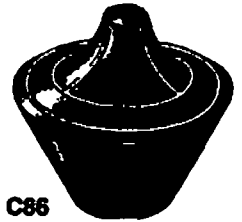

C86

## CLOSET TANK FLAPPERS

---

C86FU FLAPPER UNIVERSAL 3 WAY TYPE. Stainless steel chain and hook  
assembled to flapper. Individually boxed.

1. Fits old style brass overflow tubes.
2. Fits new style plastic flush valve.
3. Fits Crane style which has no overflow tube.

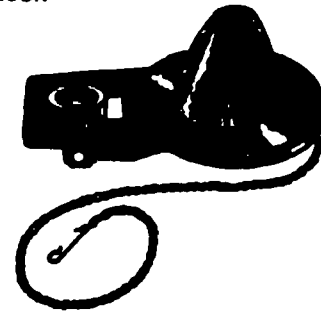

C86FU

<b>PART #</b>	<b>CATALOG PAGE</b>	<b>PART #</b>	<b>CATALOG PAGE</b>	<b>PART #</b>	<b>CATALOG PAGE</b>	<b>PART #</b>	<b>CATALOG PAGE</b>
108	2	2TD	3	501SA	2	6129	5
109	2	3201S	18	501SP	2	6212	27
1110	27	3202D	18	501STDA	4	6234	27
1125	27	3310	27	501STDP	5	6310	27
14A	2	3325	27	50243M	28	6325	27
14ATD	5	3542	20	50243	28	6350	27
14L	12	3546	20	50324	28	6420	27
14LIB	12	3548	20	50324M	28	65	27
14P	6	3552	20	50405	28	666RW	9
14P1	6	3554	20	50405M	28	668	9
14P2	6	3558	20	50486	28	668BO	9
14S	12	3560	21	50486M	28	668BR	9
14SIB	12	3564	21	50567	28	677	7
151D	17	4	1	50567M	28	6CR	6
185	10	4060	22	50648	28	7	6
186	10	4080	22	50648M	28	70R	6
1917	16	41	5	5070L	22	738	27
1918	16	42GC	6	5099M	29	7B	6
199X	10	45	5	50SA	2	7LS	6
2	1	4542	20	50SP	2	812	27
2040	20	4546	20	50STDA	4	83	27
2042	20	4548	20	50STDP	4	8A	2
2046	20	4552	20	510	27	92	6
2048	20	4554	20	55	27	93	6
2052	20	4558	20	5IB	1	9A	2
2054	20	4560	21	5NC	3	ATO	2
2058	20	4564	21	5NCA	3	C1	29
2060	21	46	6	5NCIB	3	C10	39
2064	21	47	5	5NCPLG	3	C10B	39
215	7	4815	22	5NCPLGIB	3	C10SS	39
216	7	4820	22	5NCTD	5	C11	39
251	9	483	5	5NCTDA	5	C11SS	39
253	9	4830	22	5QC	3	C12	39
2540	20	484	5	5QCIB	3	C12A	39
2542	20	4840	22	5QCTD	4	C13	40
2546	20	485	6	5S	1	C13S	40
2548	20	4IB	1	5SIB	1	C17	40
2552	20	4NH	3	5SQC	3	C1777	40
2554	20	4NHIB	3	5SQCIB	3	C19	38
2558	20	4NHTD	4	5SQCTD	4	C19BO	38
2560	21	4S	1	5STD	4	C1A	29
2564	21	4SIB	1	5TD	4	C1ASO	29
2IB	1	4STD	4	6	5	C1SO	29
2S	1	4TD	4	600	7	C1TL	30
2SIB	1	5	1	602	7	C1WRB	29
2STD	4	5010	22	604	7	C2	29

<b>PART #</b>	<b>CATALOG PAGE</b>	<b>PART #</b>	<b>CATALOG PAGE</b>	<b>PART #</b>	<b>CATALOG PAGE</b>	<b>PART #</b>	<b>CATALOG PAGE</b>
C20	38	C5A	31	C74	42	C8TL	33
C20W	38	C5A3	31	C75BO	38	C8TLQ	33
C212	39	C5A3BO	30	C76	38	C8TO	36
C22	40	C5A3T	32	C77D	38	C8TOL	34
C25	40	C5A3TL	33	C77X	38	C8TOLQ	35
C26	40	C5A3TO	37	C7A	31	C90	39
C27	40	C5A3TOL	35	C7A3BO	30	C90A	39
C28	40	C5ATOL	35	C7A3TL	33	C90AS	39
C29A	40	C5ABO	30	C7A3TO	36	C90S	39
C29D	40	C5ATO	37	C7A3TOL	34	C90SQ	39
C2A	29	C5ATL	33	C7ABO	30	C9C	39
C2ASO	29	C5BO	30	C7AR	31	C9CA	39
C2AWRB	29	C5R	31	C7ATO	36	C9CS	39
C2SO	29	C5RQ	37	C7ATOL	34	C9T	39
C2TL	30	C5RQP	37	C7BO	30	C9TA	39
C2WRB	29	C5T	32	C7R	31	CBLKR	38
C3	30	C5TB	32	C7RQ	37	CTO	1
C30	40	C5TL	33	C7RQ	37	DVD20	28
C31A	41	C5TLB	32	C7RQP	37	DVD5	28
C31P	41	C5TLQ	34	C7RWRB	31	DVH	28
C32	40	C5TO	37	C7RWRS	31	DVK5	28
C320	41	C5TOL	35	C7T	32	F5	19
C33	40	C5TOLQ	36	C7TL	32	F6	19
C34BRX	41	C6	31	C7TLQ	33	F6A	19
C37	40	C65BO	38	C7TO	36	FR72	42
C38AP	41	C66	38	C7TOL	34	FR74	42
C3SO	29	C67D	38	C7TOLQ	35	FR81	42
C3TL	30	C67X	38	C8	31	FR82	42
C4	30	C6BO	30	C81	42	FR83	42
C4SO	29	C6R	31	C82	42	G104A	19
C4TL	30	C6RQ	37	C83	42	G106	19
C5	31	C6RQ	37	C84	42	G230	19
C50P	41	C6RQP	37	C85P	43	G260	19
C50PIB	41	C6T	32	C86	43	H10C	22
C51P	41	C6TL	33	C86FU	43	HP110	22
C51PIB	41	C6TLQ	34	C87	8	HP130	22
C53	31	C6TOL	35	C88	42	HP350	22
C53BO	30	C6TOLQ	36	C8A	31	HP60	22
C53T	32	C7	31	C8ABO	30	HPH4	22
C53TL	33	C72	42	C8AR	31	HPH5	22
C53TLQ	34	C73	42	C8ATO	36	HPH7	22
C53TO	37	C73BO	30	C8ATOL	34	HPS1	22
C53TOL	35	C73TL	32	C8BO	30	HPS2	22
C53TOLQ	36	C73TLQ	33	C8R	31	HPS3	22
C55	41	C73TO	36	C8RQ	37	HW1	26
C56	41	C73TOL	34	C8RQP	37	JQCG	3
		C73TOLQ	35	C8T	32		

<b>PART #</b>	<b>CATALOG PAGE</b>	<b>PART #</b>	<b>CATALOG PAGE</b>	<b>PART #</b>	<b>CATALOG PAGE</b>	<b>PART #</b>	<b>CATALOG PAGE</b>
K012	11	PD14CS	12	PF11S	14	PF340A	15
K034	11	PD14L	13	PF12B	14	PF34A	14
K100	21	PD14L14S	11	PF12S	14	PF35	14
K125	21	PD150	11	PF13B	14	PF350	14
K150	21	PD150CS	11	PF13S	12	PF36	14
K200	21	PD16	11	PF14B	13	PF360	14
K300	21	PD3	11	PF14BA	13	PF37	14
K400	21	PD3A	12	PF14S	13	PF370	15
LN1	21	PD3B	7	PF14SA	13	PF370A	15
LN1BR	21	PD3BO	8	PF15B	13	PF37A	14
LN2	23	PD3D	7	PF15S	13	PF38	14
LN2BR	23	PD3DBR	8	PF16S1	13	PF380	15
LN2D	23	PD3DSS	9	PF171S	13	PF380A	15
LN3	23	PD3J	9	PF17B	13	PF38A	14
LN32L	23	PD3J8	9	PF17S	13	PF39	14
LN32P	23	PD3J8BR	8	PF1B	13	PF3B	13
LN4	23	PD3JBR	8	PF1S	15	PF3R	17
LN4BR	23	PD3L	8	PF21S	12	PF3S	12
LN5	23	PD3LB	8	PF221	13	PF40	14
LN6	23	PD3LSS	7	PF221CPP	13	PF41	15
LN6BR	23	PD3LSSB	8	PF22RP	12	PF42	15
N19H	23	PD3RW	8	PF23S	12	PF43	15
N19W	23	PD3SS	8	PF24B	13	PF44	15
PB100	38	PD3SSB	8	PF24S	16	PF46	15
PB100B	38	PD3SSBO	7	PF26S	16	PF47	15
PB1200	13	PD41	7	PF26SA	12	PF48	15
PB1300	14	PD44	9	PF27	13	PF49	15
PB1300B	13	PD5	11	PF27A	12	PF4S1	12
PB1400	13	PD6	11	PF28	12	PF5B	13
PB1400A	14	PD69	10	PF28A	12	PF5S	12
PB1500	13	PD7	10	PF29	14	PF601	15
PB1500B	13	PD70	10	PF2B	14	PF64	15
PB200	13	PD71	10	PF2LFS	14	PF65	15
PB200B	14	PD72	10	PF2S	14	PF66	15
PB300	13	PD73	10	PF30	14	PF6B	13
PB400	14	PD74	10	PF300	13	PF6S	12
PB500	13	PD8	10	PF31	17	PF71	15
PB500B	13	PD9	10	PF310	12	PF72	15
PB600	13	PD91	8	PF31SS	14	PF7B	13
PB600B	14	PD92	10	PF32	14	PF7S	12
PD12	13	PD93	10	PF320	14	PF8B	13
PD141	14	PDD2K	10	PF32SS	14	PF8S	12
PD144	8	PDD4K	10	PF33	17	PF90	15
PD14A	11	PF10B	12	PF330	14	PF90A	15
PD14A2	11	PF10S	12	PF34	14	PF91	15
PD14A4S	11	PF11B	13	PF340	17	PF92	15



<b>PART #</b>	<b>CATALOG PAGE</b>	<b>PART #</b>	<b>CATALOG PAGE</b>	<b>PART #</b>	<b>CATALOG PAGE</b>
PF93	15	SJ1XCP	24	SJ7W	26
PF9B	13	SJ1XIB	25	SJ7WP	26
PF9BA	13	SJ1XRB	24	SJ7XCP	24
PF9S	12	SJ10	23	SJ7XIB	25
PF9SA	12	SJ10R	26	SJ7XRB	24
PFS	12	SJ11	23	SJ9	23
PFSA	12	SJ11IB	25	SJ9IB	25
PS10	17	SJ11R	26	SJ9R	26
PS102SP	16	SJ11W	26	SJ9W	26
PS1170	17	SJ11WP	26	SJ9WP	26
PS1215	18	SJ11XCP	24	SJ9XCP	24
PS1275	18	SJ11XIB	25	SJ9XIB	25
PS14	17	SJ11XRB	24	SJ9XRB	24
PS15QC	18	SJ12	23	SPK30	16
PS15QCLD	17	SJ12IB	25	SSRP	41
PS15SP2	18	SJ12R	26	TDTO	3
PS1602	18	SJ12W	26	TSBCP	6
PS1603	18	SJ12XCP	24	TSCP	6
PS17	17	SJ12XIB	25	TSSS	6
PS18	17	SJ12XRB	24	W300	20
PS19	17	SJ2	23	W304A	20
PS1SB	16	SJ2IB	24	W72	42
PS1SBA	16	SJ2R	25	W74	42
PS3112B	16	SJ2W	26	W81	42
PS4	16	SJ2XCP	24	W82	42
PS40	16	SJ2XIB	25	W83	42
PS6	16	SJ2XRB	24		
PS7	16	SJ23W	26		
PS82SP	16	SJ3	23		
PSB	18	SJ3IB	24		
PSB3	18	SJ3R	25		
PSFR	17	SJ3W	26		
PTO	2	SJ3XCP	24		
RT1	19	SJ3XIB	25		
RT2	19	SJ3XRB	24		
RT3	19	SJ4	23		
RT4	19	SJ41R	25		
RT5	19	SJ41W	26		
RT6	19	SJ42R	26		
RTO	1	SJ42W	26		
S4BR	19	SJ43R	26		
S5	19	SJ43W	26		
SJ1	23	SJ5	23		
SJ1IB	24	SJ7	23		
SJ1R	25	SJ7IB	24		
SJ1W	26	SJ7R	26		

**P** PLUMBING  
**P** PRODUCTS CO., INC.

---

(760) 343-3040 • Facsimile Number (760) 343-3609

**PP** PLUMBING  
PRODUCTS CO., INC.

(760) 343-3040 • Facsimile Number (760) 343-3609 and or (800) 562-9998