



RESIDENTIAL AND COMMERCIAL PLUMBING
PRODUCT SOLUTIONS CATALOG

**THE BRANDS
PROFESSIONAL
PLUMBERS
CHOOSE.**

WELD-ON.

GUY GRAY.

WATER-TITE.

TOUGH PANS.

ROOF TOP BLOX.

TEST-TITE.

AB&A.

STUDOR.

TRUEBRO.

CHRISTY'S.

PROVENT.

PROSET.

FLOODSTOP.



THE BRANDS PROFESSIONAL PLUMBERS CHOOSE.

IPS manufactures the brands professional plumbers choose, combining world class customer service with innovative highly-reliable products that help contractors work faster and smarter. With thirteen residential and commercial brands available on one order, one shipment and one invoice – we will never stop working to exceed your expectations.



WELD-ON.



GUY GRAY.



WATER-TITE.

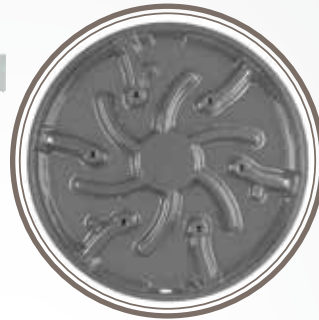

TOUGH PANS.



ROOF TOP BLOX.



TEST-TITE.



AB&A.



STUDOR.



TRUEBRO.



CHRISTY'S.



FLOODSTOP.



PROVENT.



PROSET.

Brand Overview		4
New Products		6
Weld-On®		12
Selection Guide		15
Cements, Primers & Cleaners	CAT 01	16
Christy's Solvent Cements	CAT 01	22
Solvent Welding Applicators & Accessories	CAT *	33
Sealants, Compounds & Lubricants	CAT 02	35
Guy Gray®		40
Washing Machine Outlet Boxes	CAT 04	42
Ice Maker Outlet Boxes	CAT 05	51
Dishwasher Outlet Box	CAT 05	53
Fire-rated Washing Machine Outlet Boxes	CAT 04	54
Fire-rated Ice Maker Boxes	CAT 05	60
Fire-rated Specialty Outlet Boxes	CAT 05	63
Dialysis & Dryer Boxes	CAT 05	66
Faceplates & Accessories	CAT *	67
Water-Tite®		68
Washing Machine Outlet Box Design Options Guide		70
Washing Machine Outlet Boxes	CAT 04	71
Wide-mouth Washing Machine Outlet Boxes	CAT 04	76
Ice Maker Outlet Box Design Options Guide		78
Ice Maker Outlet Boxes	CAT 05	79
Dishwasher and Utility Outlet Boxes	CAT 05	83
Gas Outlet Boxes	CAT 05	84
Kitchen Boxes	CAT 05	86
Supply Valve Box Parts & Accessories	CAT *	88
MultiBox™ Washing Machine Outlet Boxes	CAT 04	91
MultiBox™ Washing Ice Maker Outlet Boxes	CAT 05	94
MultiBox™ Specialty Boxes	CAT 05	95
MultiBox™ FR Washing Machine Outlet Boxes	CAT 04	98
MultiBox™ FR Washing Ice Maker Outlet Boxes	CAT 05	100
MultiBox™ FR Specialty Boxes	CAT 05	101
Hammer Arresters	CAT 23	103
Stabilizer Systems	CAT 14	104
HangerLok® "Push-to-lock" Clamps	CAT 15	105
Clamps & Insulators	CAT 15	106
Strapping, J-Hooks & Hangers	CAT 16	111
Tub Protectors & Boxes	CAT 18	114
Circular Valve Boxes	CAT 18	114
Stud Guards	CAT 18	115
Pipe Sleeving	CAT 18	115
Roof Flashings	CAT 21	116
Type B Ventilation	CAT 21	122
Exhaust Ventilation	CAT 21	124
Side Wall Flashings	CAT 21	125

Tough Pans®		128
Dry Lift Series	CAT 17	130
Pro Series	CAT 17	130
Aluminum Heater Pans	CAT 17	131
Plastic Water Heater Pans	CAT 17	132
Water Heater Stands	CAT 17	133
RoofTop Blox®		134
Blox	CAT 21	136
Blox Accessories	CAT 21	137
Test-Tite®		138
Pneumatic Test Plugs	CAT 11	140
Test Pumps and Accessories	CAT 11	146
Mechanical Test Plugs	CAT 12	148
Test Caps	CAT 13	153
AB&A®		156
Closet & Urinal Flanges	CAT 10	158
Wax Closet Gaskets	CAT 10	163
SetFast® No Cut Toilet Bolts	CAT 10	163
Shower & Floor Drains	CAT 08	164
Shower Pan Liner	CAT 20	179
Waste & Overflow	CAT 09	180
Lav Drains, Traps, Cleanout Covers & Plugs	CAT 19	221
Cast Iron Drains & Cleanouts	CAT 06	228
Light Commercial Drains	CAT 07	232
Backwater Valves	CAT 07	238
Access Panels & Doors	CAT 03	243
Studor®		244
Air Admittance Valves	CAT 22	246
Truebro®		252
Undersink Protection Systems	CAT 24	254
Christy's®		260
Christy's Solvent Cements	CAT 01	22
Saws & Cutting Tools	CAT 25	262
Pipe Preparation	CAT 25	264
Job Site Essentials	CAT 26	266
Gloves	CAT 26	267
Tapes	CAT 26	269
Pressure Gauges	CAT 11	270
FloodStop®		272
Leak Detection	*	274
Pumps	CAT 27	276
Pump Accessories	CAT 27	281
ProVent®		288
Single Stack DWV System	CAT 28	290
ProSet®		292
FireStop Penetrators	CAT 28	294

CAT * items do not have a category



Weld-On® makes the world's most reliable pipe joining products for demanding plumbing professionals who know trust can't be compromised. For 70+ years, Weld-On has been a global leader in solvent cement technology, unmatched not only in research, development and innovation, but also customer support and training. Weld-On's ultra-low VOC solvent cements and primers meet the revised SCAQMD Rule 1168 VOC limits, while maintaining the highest performance expected of Weld-On products.



Since 1931, the AB&A® product family has grown to include a full line of plastic and brass bath wastes, plastic, cast-iron and brass plumbing drains and fittings, cleanouts and associated accessories. Easy-to-install AB&A® bath wastes are offered in an assortment of special finishes to complement today's designs and customer preferences. A wide range of lavatory, floor and shower drains are available in plastic, bronze or cast brass. Recognized for consistent high quality, AB&A® products are used in both new construction and retrofit markets.



In 1969, Water-Tite® standardized laundry connections with the first plastic Washing Machine Recessed Outlet Box. In 1978, IPS Corporation's reputation as industry innovators expanded with the first recessed Ice Maker Outlet Box. Labor-saving products also include the 4N1™ Multi-Size Roof Flashing, Right Strap™ Multi-Functional Clamp, Single Shot® Insulating Clamp, Techno Flange®, Angle Stop Boxes, and Stabilizer Support System. Today, the Water-Tite® product line offers a wide range of plastic labor-saving specialty plumbing products.



Beginning with the industry's first washing machine outlet box in 1958, the Guy Gray® line has evolved into a broad line of high-quality products, including FR-12 Fire-rated Boxes, Stainless Steel, White Powder Coated, Dual Drain, Dishwasher, Dryer, Gas, Coffee Maker and Dialysis Outlet Boxes. The initial offering of domestic valves now includes Single Lever, Quarter-turn and Hammer Arrester Valves with Solder, F1807, CPVC and other connections.



In 1970, Studor's founder, Sture Ericson, developed Air Admittance Valve (AAV) technology, which was brought to the United States in 1986. Today, Studor® remains the only specialized AAV manufacturer in the world, with millions of valves successfully installed in North America and worldwide. Studor® has pioneered AAV technology since its introduction in the USA. Accordingly, AAVs are commonly referred to as "Studor® vents" – the brand name in the industry. The expertise in designing plumbing systems by Studor® engineers is unmatched. Remember, "It's not a Studor® valve unless it says so!"



The Truebro® line consists of protective undersink pipe covers and plumbing enclosures for ADA compliance in handicap-accessible lavatories and sinks – for both new construction and retrofit markets. The Lav Guard 2®, Lav Shield®, Basin Guard®, and Soft Guard Plus™ are professional ADA-mandated protection systems designed for durability, aesthetics, and sanitary installations. The Lav Guard 2® series of undersink pipe wraps offer E-Z Tear to Fit and built-in fasteners for fast, easy installation. Lav Shield® is an attractive, designer-style, tamper-resistant ADA-engineered protective lavatory enclosure. Basin Guard® is a clean and durable design for ADA-compliance in lavatories installed into countertops.



In 2019, IPS Corporation® acquired T. Christy Enterprises, one of North America's premier manufacturers of solvent cements and provider of a broad range of accessories. Christy's® specializes in creating products that meet the needs of professional contractors with easy use, compatibility with adverse conditions and proven reliability.



In 2019, IPS Corporation® acquired Tough Pans®, a drain pan product line designed for gas and electric water heaters and washing machines. Tough Pans® is the most innovative drain pan line on the market, engineered with the strongest materials to produce a nearly indestructible pan. The Dry Lift and Pro series water heater pans can be used on gas or electric tanks and are extremely durable and flexible. The Dry Lift Series of drain pans uses built-in risers to lift tanks 1.5", extending tank life and making connecting to the drain valve effortless.



FloodStop® offers a comprehensive range of solutions for water management, specifically designed to prevent and manage water damage at the point-of-use. FloodStop includes leak detection devices that quickly identify water leaks and shut-off the flow of water through motorized ball valves, which help to stop flood damage before it ever starts. These easy-to-install devices are ideal for both residential and commercial spaces, ensuring early detection and prompt action. In addition, FloodStop® features high-quality sump pumps that effectively remove excess water from basements and crawl spaces, safeguarding properties from flooding and moisture-related issues. Together, the FloodStop® products deliver a proactive, reliable approach to water management, providing homeowners and businesses with the peace of mind they deserve.



The Roof Top Blox® is a revolutionary roof top support block system that works with height extension rods, support brackets, pipe rollers, strut, and more. The Blox is versatile enough for every roof plumbing support, roof piping support, and roof platform support need. In addition, the packaging makes transporting roof support blocks to the job – and roof top – a faster and more efficient process. Engineered with contractors in mind, the Roof Top Blox® system is designed to be quickly installed, expanded, and adjusted from just the top side. Easier installation and lasting dependability make Roof Top Blox® the best roof block choice to specify or install for supporting pipes and mechanical equipment on flat commercial roofs.



The Test-Tite® brand has over 40 years of experience in manufacturing a complete line of pneumatic and mechanical test plugs. Our full line of pneumatic test plugs include standard, multi-size, cleanout, long and bypass pneumatic plugs for use in residential, commercial and underground markets. Pneumatic plugs, up to 15" diameter, come standard with a Pressure Relief Valve – the first full line of Pressure Relief Plugs in the Plumbing industry. Our pneumatic plugs come standard with a heavy wall thickness which is backed by a 2-1/2 year warranty. Our full line of mechanical test plugs include Twist-Tite wing nut test plugs, T-Cone Cleanout and Repair Plugs, Twist 'N Seal®, Flush Cleanout Repair Plugs, and the Mechanical Cleanout Test Plug.



The ProVent® Single Stack System is an innovative DWV (drain, waste and vent) system that ensures a smooth, safe flow without any additional vent piping. The system functions as well or better than conventional two-stack systems, but cuts piping requirements in half while slashing labor and materials costs by up to 40%.

Fabricated from high grade PVC, the ProVent® Single Stack System also installs much more quickly and easily than conventional systems, eliminating floor penetrations, and requiring fewer hangers and supports, helping to keep projects on schedule.

Modeled on a proven DWV solution backed by 60+ years in the field, the system features corrosion-proof StackVent and BaseVent fittings and PVC piping that can be easily engineered to accommodate a wide range of multistory projects.



In 2024, IPS Corporation® acquired the ProSet Systems, the oldest and most experienced in firestop devices for the piping trades. The complete line of firestop penetrators equals or surpasses all the current building and life safety codes.

In addition to being fire-rated, the ProSet penetrators provide for pipe expansion and contraction, waterproofs smokeproofs and reduces pipe noise. ProSet outperforms any metallic or nonmetallic sleeving. Their versatility and combination function creates remarkable solutions.

IPS Corporation has rolled out some exciting new products that make life easier for contractors and professionals in the plumbing, HVAC, and construction industries. With a focus on improving efficiency and sustainability, our latest offerings are all about making jobs quicker, simpler, and more reliable. Whether it's a sump pumps, pneumatic test plug, backwater valves, or other innovative solutions, IPS continues to provide products that help get the job done right!



FLOODSTOP
IPS CORPORATION

Pumps and pump accessories

The water management solutions that FloodStop® offer has increased from point-of-use leak detection devices to high-quality sump pumps and pump accessories, which effectively remove excess water from basements and crawl spaces. These product solutions safeguard properties from flooding and moisture-related issues. Together, the FloodStop® products deliver a proactive, reliable approach to water management, providing homeowners and businesses with the peace of mind they deserve.

See page 276 for more.



Press Fit Connections For Water Heater Kits

FloodStop® point-of-use leak detection kits are now available with press fit valve (Press x Press and Press x MPT) connections for water heater kits. Once water is detected, the motorized ball valves close and sound an alarm.

See page 274 for more.



VIP Series™ Pneumatic Test Plugs

Test-Tite® has introduced a new addition to our DWV test plugs family with the innovative single-size pneumatic plug design. The latest VIP Series™ test plugs are available in four different nominal sizes; 1-1/2", 2", 3" and 4" with 1 ft. chain. The 3- and 4-inch plugs are also available with a 6 ft. chain. Test-Tite's groundbreaking manufacturing process utilizes our proprietary production method, ensuring an elevated level of product precision and performance. The manufacturing process involves cutting-edge presses equipped with digital controllers, facilitating precise vulcanization of the natural rubber body.

See page 140 for more.



Test Dome Coupling

The Test Tite® Test Dome Coupling™ (TDC) provides a safe and economical way to pressure test DWV systems without the need for specialized tools. The TDC can be installed during the ground phase of construction at the DWV-to-sewer cleanout connection point with various cleanout configurations on 3" or 4" pipe – ABS or PVC. A 12 ft. pull cord with integrated t-handle makes the removal of the test dome a breeze once the pressure test has been completed.

See page 153 for more.



Legacy Backwater Valves

AB&A legacy backwater valves help prevent sewage from flowing back into homes during heavy rain or flooding. They protect against costly water damage by stopping reverse flow in drain pipes. Made from durable PVC or ABS material, these valves resist corrosion and are easy to install in both new and existing systems. With features like removable access covers for easy maintenance, AB&A backwater valves are a reliable and simple solution for protecting homes from backflow issues.

See page 238 for more.





P-68™ UV GLOW™ Primer

Weld-On® P-68 UV Glow Primer is a code compliant clear, ultra-low VOC, fast acting primer that rapidly softens and dissolves the joining surfaces of PVC and CPVC pipe and fitting prior to the application of solvent cement. It is the first clear primer with triple unique attributes:

- Clean, clear appearance that glows purple under UV light.
- THF-free. Safer, low fume formula for installers.
- Ultra low VOC. Meets the most stringent codes, regulations and SCAQMD Rule 1168/316A.

See page 29 for more.



FlowGuard Gold® CPVC Green

FlowGuard Gold Green is a green, ultra low VOC emission, medium bodied, fast setting, CPVC solvent cement for CPVC copper tube size pipe and fittings with interference fit through 2 inches (63 mm) diameter.

- ALL WEATHER, ONE STEP CEMENT – formulated to be used without primer if Codes permit. For potable water to 180°F (82°C). Suitable for residential plumbing and industrial systems.
- EASY TO IDENTIFY. High contrast green color CPVC cement is included in 2024 Uniform Plumbing Code.
- APPROVED by Lubrizol Corporation for use on Flowguard plumbing systems.

See page 24 for more.



HangerLok

HangerLok® is a high-performance system to support pipe, tubing, conduit, cable, and more. Improved materials offer improved performance and broader application opportunities. Using a Nylon 6/6 polymer, Hangerlok can be used inside facilities and also exposed areas. Using both a UV inhibitor and a flame retardant, Hangerlok is durable and halogen free. Being UV resistant along with it's non-conductive qualities, Hangerlok's versatility makes it a must have one piece pipe hanger and conduit support system.

See page 105 for more.

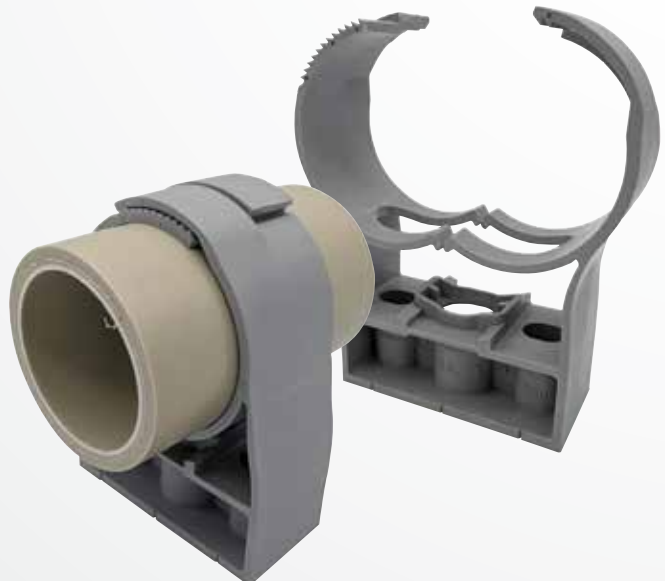



Metal Roof Flashings

Our expanded line of Water-Tite Metal Roof Flashings include round and square bases in a variety of sizes and colors. The adaptable bases are designed to mold to most panel configurations and roof pitches regardless of pipe location. The improved sleeve flexibility absorbs vibration and pipe movement caused by expansion and contraction. The EPDM or high-temperature silicone, of these flashings are compounded specifically for maximum resistance to weathering due to ozone and ultraviolet light.

See page 119 for more.



Type B Vent Flashings

These durable all metal flashing are made for up to 12/12 pitched roofs and double wall pipes, also known as Type-B vent pipes. Use proper FHA style flashing model to help with the pipe angle alignment. Available in a range of sizes from 3-8 inches.

See page 122 for more.



Type B Vent Adjustable Storm Collars

The storm collar works together with the Type B Vent Flashing to provide a waterproof seal where the stack passes through the roof. The storm collar is installed and sealed directly above the flashing.

See page 123 for more.



Stamped Storm Collar

The stamped storm collar works together with the Type B Vent Flashing to provide a waterproof seal where the stack passes through the roof. The storm collar is installed and sealed directly above the flashing.

See page 123 for more.



PROVENT.

IPS CORPORATION

The ProVent® Single Stack System is an innovative DWV (drain, waste and vent) system that ensures a smooth, safe flow without any additional vent piping. The system functions as well or better than conventional two-stack systems, but cuts piping requirements in half while slashing labor and materials costs by up to 40%.

Fabricated from high grade PVC, the ProVent® Single Stack System also installs much more quickly and easily than conventional systems, eliminating floor penetrations, and requiring fewer hangers and supports, helping to keep projects on schedule. Modeled on a proven DWV solution backed by 60+ years in the field, the system features corrosion-proof StackVent and BaseVent fittings and PVC piping that can be easily engineered to accommodate a wide range of multistory projects.

See page 288 for more.



PROSET
IPS CORPORATION

ProSet Firestop penetrators deliver firestopping, smoke-proofing and waterproofing protection in one step with the installation of the piping system. By combining these three jobs in a simplified, single-step install, ProSet Firestop penetrators help keep projects on schedule while slashing materials and labor costs. Fabricated from lightweight PVC, ProSet Firestop penetrators also enable pipe expansion and contraction, and help reduce pipe noise.

Versatile and adaptable, ProSet firestop penetrators can accommodate a range of multistory projects and are suitable for many other non-fire-rated applications, including unique swimming pool inlets and outlets and much more.

See page 292 for more.



ProSet®

ProVent®

FloodStop®

Christy's®

Truebro®

Studor®

AB&A®

Test-Tite®

RTB

ToughPans®

Water-Tite®

Guy Gray®

Weld-On®



WELD ON®

1954

Weld-On® pioneered the solvent cement industry

The plastic piping era in the United States began with the introduction of Weld-On®'s first plastic pipe cement. Ever since, Weld-On® cements, cleaners and primers have been delivering industry-leading performance and revolutionizing plastic piping assembly.



Today

Weld-On® is a global leader in solvent welding technology

Recognized as the world's premium line of products for joining plastic pipes and fittings, today's Weld-On® solvent cements, primers and cleaners meet Ultra low-VOC (Volatile Organic Compound) emission limits. Weld-On products meet environmental standards while maintaining the highest performance expected by professionals.



WELD-ON®

IPS CORPORATION

PLUMBING CEMENTS

1954 – Weld-On® pioneered the solvent cement industry

The plastic piping era in the United States began with the introduction of Weld-On®'s first plastic pipe cement. Ever since, Weld-On® cements, cleaners and primers have been delivering industry-leading performance and revolutionizing plastic piping assembly.



GREENGUARD

PRODUCT CERTIFIED FOR
LOW CHEMICAL EMISSIONS
UL.COM/GG
UL 2818

GOLD

Today's Weld-On® – a global leader in solvent welding technology

Recognized as the world's premium line of products for joining plastic pipes and fittings, today's Weld-On® solvent cements, primers and cleaners meet Ultra low-VOC (Volatile Organic Compound) emission limits. Weld-On products meet environmental standards while maintaining the highest performance expected by professionals.



Choosing the Correct Product

For assistance in selecting the right Weld-On® products for your application, please refer to the selection guide.

	COLOR	GRADE	Nominal Pipe Size	mm	20	25	32	40	50	63	75	90	110	160	200	250	315	355	600	800		
					in	1/2	3/4	1	1 1/4	1 1/2	2	2 1/2	3	4	6	8	10	12	14	24	30	
PRIMERS	CLEAR	I	P68																			
	CLEAR	I	P68 UV GLOW																			
	AQUA BLUE	I	P75																			
	PURPLE CLEAR	I	P70																			
	PURPLE CLEAR	P	Plumbing Primer																			
SPECIALTY	GREEN	P	794***	ALL CLASSES & SCHEDULES EXCEPT SCHEDULE 80																		
	LIGHT AMBER	P	790**																			
ABS	BLACK	P	773	ALL CLASSES & SCHEDULES EXCEPT SCHEDULE 80																		
	MILKY YELLOW	P	771	ALL CLASSES & SCHEDULES EXCEPT SCHEDULE 80																		
CPVC	GRAY	I	729																			
	ORANGE GRAY	I	724 ^o																			
	ORANGE GRAY	I	714																			
	ORANGE	P	713					CTS														
	YELLOW	P	FloGuard [†] Gold® YELLOW						CTS													
	GREEN	P	FloGuard [†] Gold® GREEN						CTS													
PVC	SPECIALTY CEMENTS	CLEAR BLUE	P	795																		
		BLUE to CLEAR	I	748 [†]																		
		BLUE to CLEAR	P	737 [†]																		
		BLUE	P	735 [†]																		
		CLEAR	P	727 [†]																		
		AQUA BLUE	P	725 [†]																		
		BLUE	P	750 HOT WELD																		
	EXTRA HEAVY BODY	GRAY WHITE	I	719																		
		CLEAR GRAY WHITE	I	782																		
	HEAVY BODY	GRAY	I	711																		
		BLUE	I	721 [†]																		
	MEDIUM BODY	CLEAR GRAY	I	705 [†]																		
		CLEAR GRAY	P	781 [†]																		
REGULAR BODY	CLEAR	I	710																			
	CLEAR	P	780																			

Pipe Format

Schedule 40/PN3.2, PN4, PN6

Schedule 80/PN10, PN16

REGULAR BODIED CEMENT

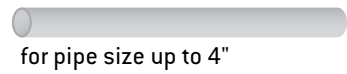

for pipe size up to 4"

MEDIUM BODIED CEMENT



for pipe size up to 6"

HEAVY BODIED CEMENT



for pipe size up to 12"

EXTRA HEAVY BODIED CEMENT



for pipe size up to 30"

Graphic above is intended as a general reference. Some exceptions apply. See Selection Guide for specific details.

† Can be used without a primer with fittings having an interference fit (unless primer required by local code).

^a Flow Guard Gold® is a registered trademark of the Lubrizol Corp.

◇ For CPVC and PVC Chemical Piping Systems

** PVC and CPVC

*** ABS to PVC Transition Joints

CTS: Copper Tube Size

P: Plumbing Grade



I: Industrial Grade



780™ PVC Plumbing, Clear, Regular-Bodied, Fast-Setting

14001



- Regular-bodied, fast-setting, low-VOC PVC cement for all classes and schedules with interference fit through 4" (110 mm) diameter (except Schedule 80)
- Specially formulated for plumbing applications, including PVC foam core pipe

LISTINGS	PRODUCT	DESCRIPTION	MODEL	UNITS/CASE
 	14004	1/4 Pt. Can with Applicator Cap	14004	24
	14003	1/2 Pt. Can with Applicator Cap	14003	24
	14002	Pt. Can with Applicator Cap	14002	12
	14001	Qt. Can with Applicator Cap	14001	12
	14000	Gal. Can with Screw-on Cap	14000	6

780™ PVC Plumbing, Clear, Regular-Bodied and PVC Primer, Purple Twin Pack

15900

- Regular-bodied, fast-setting, low-VOC PVC cement for all classes and schedules with interference fit through 4" (110 mm) diameter (except Schedule 80)
- Specially formulated for plumbing applications, including PVC foam core pipe

LISTING	PRODUCT	DESCRIPTION	MODEL	UNITS/CASE
 	15900	1/2 Pt. Can with Applicator Cap, Cement and Primer Twin Pack	15900	20

781™ PVC Plumbing, Clear, Medium-Bodied, Fast-Setting

14006

- Medium-bodied, fast-setting, low-VOC PVC cement for all classes and schedules with interference fit through 6" (160 mm) diameter, Schedule 80 through 4" (110 mm) diameter
- Specially formulated for plumbing applications, including PVC foam core pipe
- Can be used without primer on non-pressure systems if local codes permit

LISTINGS	PRODUCT	DESCRIPTION	MODEL	UNITS/CASE
 	14009	1/4 Pt. Can with Applicator Cap	14009	24
	14008	1/2 Pt. Can with Applicator Cap	14008	24
	14007	Pt. Can with Applicator Cap	14007	12
	14006	Qt. Can with Applicator Cap	14006	12
	14005	Gal. Can with Screw-on Cap	14005	6

781™ PVC Plumbing, Gray, Medium-Bodied, Fast-Setting

14011

- Medium-bodied, fast-setting, low-VOC PVC cement for all classes and schedules with interference fit through 6" (160 mm) diameter, Schedule 80 through 4" (110 mm) diameter
- Specially formulated for plumbing applications, including PVC foam core pipe
- Can be used without primer on non-pressure systems if local codes permit

LISTINGS	PRODUCT	DESCRIPTION	MODEL	UNITS/CASE
 	14014	1/4 Pt. Can with Applicator Cap	14014	24
	14013	1/2 Pt. Can with Applicator Cap	14013	24
	14012	Pt. Can with Applicator Cap	14012	12
	14011	Qt. Can with Applicator Cap	14011	12
	14010	Gal. Can with Screw-on Cap	14010	6

782™ PVC Plumbing, Clear, Heavy-Bodied, Medium-Setting

- Heavy-bodied, medium-setting, low-VOC PVC cement for all classes and schedules with interference fit through 12" (315 mm) diameter Specially formulated for plumbing applications, including PVC foam core pipe
- Heavy-bodied, medium-setting, low-VOC PVC cement for all classes and schedules with interference fit through 12" (315 mm) diameter
- Good gap filling properties and its medium set allows more working time in warm weather
- Specially formulated for plumbing applications, including PVC foam core pipe



LISTINGS	PRODUCT	DESCRIPTION	MODEL	UNITS/CASE
	14019	1/4 Pt. Can with Applicator Cap	14019	24
	14018	1/2 Pt. Can with Applicator Cap	14018	24
	14017	Pt. Can with Applicator Cap	14017	12
	14016	Qt. Can with Applicator Cap	14016	12
	14015	Gal. Can with 2-7/8" Screw-on Cap	14015	6



14016

782™ PVC Plumbing, Gray, Heavy-Bodied, Medium-Setting

- Heavy-bodied, medium-setting, low-VOC PVC cement for all classes and schedules with interference fit through 12" (315 mm) diameter Specially formulated for plumbing applications, including PVC foam core pipe
- Heavy-bodied, medium-setting, low-VOC PVC cement for all classes and schedules with interference fit through 12" (315 mm) diameter
- Good gap filling properties and its medium set allows more working time in warm weather
- Specially formulated for plumbing applications, including PVC foam core pipe



LISTINGS	PRODUCT	DESCRIPTION	MODEL	UNITS/CASE
	14023	1/2 Pt. Can with Applicator Cap	14023	24
	14022	Pt. Can with Applicator Cap	14022	12
	14021	Qt. Can with Applicator Cap	14021	12
	14020	Gallon Can with Screw-on Cap (wide-mouth opening)	14020	6



14021

782™ PVC Plumbing, White, Heavy-Bodied, Medium-Setting

- Heavy-bodied, medium-setting, low-VOC PVC cement for all classes and schedules with interference fit through 12" (315 mm) diameter Specially formulated for plumbing applications, including PVC foam core pipe
- Heavy-bodied, medium-setting, low-VOC PVC cement for all classes and schedules with interference fit through 12" (315 mm) diameter
- Good gap filling properties and its medium set allows more working time in warm weather
- Specially formulated for plumbing applications, including PVC foam core pipe

LISTINGS	PRODUCT	DESCRIPTION	MODEL	UNITS/CASE
 	16185	Pt. Can with Applicator Cap	16185	12
	16184	Qt. Can with Applicator Cap	16184	12
	16183	Gallon Can with Screw-on Cap (wide-mouth opening)	16183	6



16184

Weld-On®
 Guy Gray®
 Water-Tite®
 ToughPans®
 RTB
 Test-Tite®
 AB&A®
 Studor®
 Truebro®
 Christy's®
 FloodStop®
 ProVent®
 ProSet®

727™ PVC Hot 'R Cold™ Clear, Medium-Bodied, Very Fast-Setting

10841



- Medium-bodied, very fast-setting, low-VOC PVC cement for all classes and schedules with interference fit through 6" (160 mm) diameter, Schedule 80 through 4" (110 mm) diameter
- Premium formula for all weather conditions (-15°F to 110°F, -26°C to 43°C)
- Excellent for industrial, irrigation, electrical conduit, pool & spa and plumbing, including PVC foam core pipe
- Can be used without primer on non-pressure systems if local codes permit

LISTINGS	PRODUCT	DESCRIPTION	MODEL	UNITS/CASE
 	10842	Pt. Can with Applicator Cap	107270031	12
	10841	Qt. Can with Applicator Cap	107270021	12
	10840	Gal. Can with Screw-on Cap	107270011	6

735™ PVC Wet 'N Fast™ Blue, Medium-Bodied, Extremely Fast-Setting

12495

- Medium-bodied, extremely fast-setting, low-VOC PVC cement for all classes and schedules with interference fit through 6" (160 mm) diameter, schedule 80 through 4" (110 mm) diameter
- Plumbing quality cement for wet conditions and/or quick pressurization
- Can be used without primer on non-pressure systems if local codes permit

LISTINGS	PRODUCT	DESCRIPTION	MODEL	UNITS/CASE
 	12498	1/4 Pt. Can with Applicator Cap	107350951	24
	12497	1/2 Pt. Can with Applicator Cap	107350941	24
	12496	Pt. Can with Applicator Cap	107350931	12
	12495	Qt. Can with Applicator Cap	107350921	12
	12494	Gal. Can with Screw-on Cap	107350911	6

737™ PVC Turf 'N Ag™ Blue, Medium-Bodied, Very Fast-Setting

10989

- Medium-bodied, very fast-setting, low-VOC PVC cement for all classes and schedules with interference fit through 8" (200 mm) diameter, Schedule 80 through 4" (110 mm) diameter
- Works well in wet conditions and/or quick pressurization
- Blue color fades to clear in sunlight
- High quality blue cement has a slightly higher viscosity making it ideal for turf and agricultural applications and excellent for PVC Well casing
- Can be used without primer on non-pressure systems if local codes permit

LISTINGS	PRODUCT	DESCRIPTION	MODEL	UNITS/CASE
 	11985	1/4 Pt. Can with Applicator Cap	107370951	24
	11984	1/2 Pt. Can with Applicator Cap	107370941	24
	10990	Pt. Can with Applicator Cap	107370931	12
	10989	Qt. Can with Applicator Cap	107370921	12
	10988	Gal. Can with Screw-on Cap	107370911	6

795™ Flexible PVC Clear, Medium-Bodied, Fast-Setting

- Medium-bodied, fast-setting, low-VOC PVC solvent cement for use on flex/flex and flex/rigid PVC with interference fit through 6" [160 mm] diameter, Schedule 80 through 3" [90 mm] diameter
- Premium cement specially formulated for use on flexible and/or rigid PVC
- Forms flexible, high-strength, water-resistant joints

LISTINGS	PRODUCT	DESCRIPTION	MODEL	UNITS/CASE
	10283	1/4 Pt. Can with Applicator Cap	107950051	24
	10282	1/2 Pt. Can with Applicator Cap	107950041	24
	10281	Pt. Can with Applicator Cap	107950031	12
	10280	Qt. Can with Applicator Cap	107950021	12
	10278	Gal. Can with Screw-on Cap	107950011	6



10280

795™ Flexible PVC Blue, Medium-Bodied, Fast-Setting

- Medium-bodied, fast-setting, low-VOC PVC solvent cement for use on flex/flex and flex/rigid PVC with interference fit through 6" [160 mm] diameter, Schedule 80 through 3" [90 mm] diameter
- Premium cement specially formulated for use on flexible and/or rigid PVC
- Forms flexible, high-strength, water-resistant joints

LISTING	PRODUCT	DESCRIPTION	MODEL	UNITS/CASE
	11905	Qt. Can with Applicator Cap	107950921	12
	11727	Gal. Can with Screw-on Cap	107950911	6



11905

710™ PVC Clear, Regular-Bodied, Very Fast-Setting

- Regular-bodied, very fast-setting, low-VOC PVC cement for all classes and schedules with interference fit through 2" [63 mm] diameter (except Schedule 80)
- Specially formulated for irrigation piping. Also suitable for electrical conduit, pool & spa and plumbing, including PVC foam core pipe

LISTINGS	PRODUCT	DESCRIPTION	MODEL	UNITS/CASE
	10115	1/4 Pt. Can with Applicator Cap	107100051	24
	10114	1/2 Pt. Can with Applicator Cap	107100041	24
	10113	Pt. Can with Applicator Cap	107100031	12
	10112	Qt. Can with Applicator Cap	107100021	12
	10111	Gal. Can with Screw-on Cap	107100011	6





10112

705™ PVC Clear, Medium-Bodied, Fast-Setting

10089

- Medium-bodied, fast-setting, low-VOC PVC cement for all classes and schedules with interference fit through 6" (160 mm) diameter, Schedule 80 through 4" (110 mm) diameter

- Can be used without primer on non-pressure systems if local codes permit
- High-strength formula for industrial, irrigation, DWV, electrical conduit, pool & spa and plumbing, including PVC foam core pipe



LISTINGS	PRODUCT	DESCRIPTION	MODEL	UNITS/CASE
	10100	1/4 Pt. Can with Applicator Cap	107050051	24
	10097	1/2 Pt. Can with Applicator Cap	107050041	24
	10093	Pt. Can with Applicator Cap	107050031	12
	10089	Qt. Can with Applicator Cap	107050021	12
	10085	Gal. Can with Screw-on Cap	107050011	6

705™ PVC Gray, Medium-Bodied, Fast-Setting

10090



- Medium-bodied, fast-setting, low-VOC PVC cement for all classes and schedules with interference fit through 6" (160 mm) diameter, Schedule 80 through 4" (110 mm) diameter

- Can be used without primer on non-pressure systems if local codes permit
- High-strength formula for industrial, irrigation, DWV, electrical conduit, pool & spa and plumbing, including PVC foam core pipe

LISTINGS	PRODUCT	DESCRIPTION	MODEL	UNITS/CASE
	10101	1/4 Pt. Can with Applicator Cap	107050151	24
	10098	1/2 Pt. Can with Applicator Cap	107050141	24
	10094	Pt. Can with Applicator Cap	107050131	12
	10090	Qt. Can with Applicator Cap	107050121	12
	10086	Gal. Can with Screw-on Cap	107050111	6

711™ PVC Gray, Heavy-Bodied, Medium-Setting

- Heavy-bodied, medium-setting, low-VOC PVC cement for all classes and schedules with interference fit, including Schedule 80 through 12" (315 mm) diameter
- High-strength is ideal for industrial piping systems
- Good gap-filling properties and its medium set allows more working time in warm weather

LISTINGS	PRODUCT	DESCRIPTION	MODEL	UNITS/CASE
	10123	1/2 Pt. Can with Applicator Cap	107110141	24
	10121	Pt. Can with Applicator Cap	107110131	12
	10119	Qt. Can with Applicator Cap	107110121	12
	10117	Gal. Can w/ Screw-on Wide-mouth Cap	107110111	6



10119

721™ PVC Blue, Medium-Bodied, Fast-Setting

- Medium-bodied, fast-setting, high-strength, low-VOC PVC solvent cement. Suitable for use on rigid PVC with interference fit Sch. 40 through 6" and Sch. 80 through 4"
- Premium, high-strength formulation for irrigation, DWV, pool & spa, plumbing and non-pressure application
- Can be used without primer on non-pressure systems if local codes permit

LISTINGS	PRODUCT	DESCRIPTION	MODEL	UNITS/CASE
	10849	1/4 Pt. Can with Applicator Cap	107210951	24
	10163	1/2 Pt. Can with Applicator Cap	107210941	24
	10162	Pt. Can with Applicator Cap	107210931	12
	10161	Qt. Can with Applicator Cap	107210921	12
	10160	Gal. Can with Screw-on Cap	107210911	6



10161

Weld-On®

Guy Gray®

Water-Tite®

ToughPans®

RTB

Test-Tite®

AB&A®

Studor®

Truebro®

Christy's®

FloodStop®

ProVent®

ProSet®

719™ PVC Gray, Extra Heavy-Bodied, Slow-Setting



10156

- Extra heavy-bodied, slow-setting, low-VOC PVC cement for all classes and schedules with interference fit, including Schedule 80 through 30" (800 mm) diameter
- Ideal for fabrication of large fittings and applications requiring high gap filling properties. Suitable for irrigation, conduit, pressure and non-pressure applications

LISTINGS	PRODUCT	DESCRIPTION	MODEL	UNITS/CASE
UPC NSF	10156	Qt. Triple Tight Paint Can	107190122	12
NSF	13078	Gal. Wide-mouth Can	107190115	6

719™ PVC White, Extra Heavy-Bodied, Slow-Setting



10157

- Extra heavy-bodied, slow-setting, low-VOC PVC cement for all classes and schedules with interference fit, including Schedule 80 through 30" (800 mm) diameter
- Premium, high-strength formulation for large size industrial piping systems
- Ideal for fabrication of large fittings and applications requiring high gap filling properties. Suitable for irrigation, conduit, pressure and non-pressure application

LISTINGS	PRODUCT	DESCRIPTION	MODEL	UNITS/CASE
UPC	12658	10.3 oz Tube	107190266	24
UPC	10159	Pt. Triple Tight Paint Can	107190232	12
NSF	10157	Qt. Triple Tight Paint Can	107190222	12
	10155	Gal. Triple Tight Paint Can	107190212	4

Red Hot Blue Glue



505201

- Contractor preferred, premium formulation
- Medium body, very fast set
- All classes and Schedules through 6" diameter interference fit (Schedule 80 through 4")
- Can be used without primer if local codes permit for non-pressure systems up to 6" and pressure systems below 4"
- Blue in color

LISTINGS	PRODUCT	DESCRIPTION	MODEL	UNITS/CASE
UPC	505200	Red Hot Blue Glue PVC Cement, 4 oz, Low Voc (1/4 Pint)	RH-RHBV-QP-48	48
UPC	505197	Red Hot Blue Glue PVC Cement, 8 oz, Low Voc (1/2 Pint)	RH-RHBV-HP-36	36
NSF	505199	Red Hot Blue Glue PVC Cement, 16 OZ, Low Voc (Pint)	RH-RHBV-PT-24	24
	505201	Red Hot Blue Glue PVC Cement, 32 OZ, Low Voc (Quart)	RH-RHBV-QT-12	12
	505195	Red Hot Blue Glue PVC Cement, 128 OZ, Low Voc (Gallon)	RH-RHBV-GL-6	6

Red Hot Clear Glue



505201

- Contractor preferred, premium formulation
- Medium body, very fast set
- All classes and Schedules thru 6" diameter interference fit (Schedule 80 through 4")
- Can be used without primer if local codes permit for non-pressure systems up to 6" and pressure systems below 4"
- Clear in color

LISTINGS	PRODUCT	DESCRIPTION	MODEL	UNITS/CASE
UPC	505209	Red Hot Clear Glue PVC Cement, 16 oz (Pint)	RH-RHCV-PT-12	12
UPC	505210	Red Hot Clear Glue PVC Cement, 32 oz (Quart)	RH-RHCV-QT-12	12
NSF	505208	Red Hot Clear Glue PVC Cement, 128 oz (Gallon)	RH-RHCV-GL-6	6

Handy Pack: Red Hot Blue Glue & Purple Primer

- Convenient package includes 1 can each of contractor-preferred Red Hot Blue Glue (Low VOC) and Purple Primer, 8 oz
- For PVC pipe and fitting applications through 6"; potable water, pressure, non-pressure, conduit, drain, duct, DWV and sewer, including Schedule 80
- Cement is blue in color, Primer is purple

LISTING	PRODUCT	DESCRIPTION	MODEL	UNITS/CASE
	505196	1/2 Pt. Can with Applicator Cap, Cement and Primer Twin Pack	RH-RHBV-HDYPK-HP-20	20



505196

750™ HotWeld™ PVC Blue, Medium-Bodied, Extremely Fast-Setting

- Medium-bodied, fast-setting, PVC solvent cement for use on rigid PVC with interference fit Sch. 40 through 6" and Sch. 80 through 4"
- Premium, hot blue formulation, excellent for use in challenging conditions including wet, damp or cold applications with superior long-term performance
- One-step cement that can be used without primer on Sch. 40 pipe and fittings if local code permits

LISTINGS	PRODUCT	DESCRIPTION	MODEL	UNITS/CASE
	13754	1/4 Pt. Can with Applicator Cap	13754	24
	13753	1/2 Pt. Can with Applicator Cap	13753	24
	13752	Pt. Can with Applicator Cap	13752	12
	13751	Qt. Can with Applicator Cap	13751	12
	13750	Gal. Can with Screw-on Cap	13750	6



13752

725™ PVC Wet 'R Dry™ Aqua Blue, Medium-Bodied, Extremely Fast-Setting

- Medium-bodied, extremely fast-setting, low-VOC PVC cement for all classes and schedules with interference fit through 6" (160 mm) diameter, Schedule 80 through 4" (110 mm) diameter
- Premium formula for wet conditions and/or quick pressurization
- Suitable for irrigation, plumbing, and pool & spa applications
- Can be used without primer on non-pressure systems if local codes permit

LISTINGS	PRODUCT	DESCRIPTION	MODEL	UNITS/CASE
	10850	1/4 Pt. Can with Applicator Cap	107250951	24
	10167	1/2 Pt. Can with Applicator Cap	107250941	24
	10166	Pt. Can with Applicator Cap	107250931	12
	10165	Qt. Can with Applicator Cap	107250921	12
	10164	Gal. Can with Screw-on Cap	107250911	6



10165

Weld-On®
Guy Gray®
Water-Tite®
ToughPans®
RTB
Test-Tite®
AB&A®
Studor®
Truebro®
Christy's®
FloodStop®
ProVent®
ProSet®

FlowGuard Gold® CPVC Yellow, Medium-Bodied, Fast-Setting

11026

- Regular-bodied, fast-setting, low-VOC CPVC cement for copper tube size and Schedule 40 pipe and fittings with interference fit through 2" (63 mm) diameter
- Specially formulated for plumbing applications
- For potable water to 180°F (82°C)

LISTINGS	PRODUCT	DESCRIPTION	MODEL	UNITS/CASE
UPC®	11029	1/4 Pt. Can with Applicator Cap	127130851	24
	11028	1/2 Pt. Can with Applicator Cap	127130841	24
NSF	11027	Pt. Can with Applicator Cap	127130831	12
NSF c US	11026	Qt. Can with Applicator Cap	127130821	12
	11025	Gal. Can with Screw-on Cap	127130811	6

FlowGuard Gold® is a registered trademark of The Lubrizol Corporation.

FlowGuard Gold® CPVC Green, Medium-Bodied, Fast-Setting

16162

- Medium-bodied, fast-setting, low-VOC CPVC cement for copper tube size and Schedule 40 pipe and fittings with interference fit through 2" (63 mm) diameter
- Specially formulated for plumbing applications
- For potable water to 180°F (82°C)

LISTINGS	PRODUCT	DESCRIPTION	MODEL	UNITS/CASE
UPC®	16165	1/4 Pt. Can with Applicator Cap	16165	24
	16164	1/2 Pt. Can with Applicator Cap	16164	24
NSF	16163	Pt. Can with Applicator Cap	16163	12
NSF c US	16162	Qt. Can with Applicator Cap	16162	12
	16161	Gal. Can with Screw-on Cap	16161	6

FlowGuard Gold® is a registered trademark of The Lubrizol Corporation.

713™ CPVC Orange, Regular-Bodied, Fast-Setting

10126

- Regular-bodied, fast-setting, low-VOC CPVC cement for copper tube size and Schedule 40 pipe and fittings with interference fit through 2" (63 mm) diameter
- Specially formulated for plumbing applications
- For potable water to 180°F (82°C)

LISTINGS	PRODUCT	DESCRIPTION	MODEL	UNITS/CASE
UPC®	10129	1/4 Pt. Can with Applicator Cap	107130651	24
	10128	1/2 Pt. Can with Applicator Cap	107130641	24
NSF	10127	Pt. Can with Applicator Cap	107130631	12
	10126	Qt. Can with Applicator Cap	107130621	12

714™ CPVC Orange, Heavy-Bodied, Medium-Setting

- Heavy-bodied, medium-setting, low-VOC CPVC cement for all classes and schedules with interference fit through 12" (315 mm) diameter
- Industrial quality for non-chemical applications up to 180°F (82°C)
- Approved for use on Corzan® CPVC piping systems

LISTINGS	PRODUCT	DESCRIPTION	MODEL	UNITS/CASE
	10137	1/2 Pt. Can with Applicator Cap	107140641	24
	10135	Pt. Can with Applicator Cap	107140631	12
	10132	Qt. Can with Applicator Cap	107140621	12
	10130	Gal. Can with Screw-on Cap	107140611	6



10132

714™ CPVC Gray, Heavy-Bodied, Medium-Setting

- Heavy-bodied, medium-setting, low-VOC CPVC cement for all classes and schedules with interference fit through 12" (315 mm) diameter
- Industrial quality for non-chemical applications up to 180°F (82°C)
- Approved for use on Corzan® CPVC piping systems

LISTING	PRODUCT	DESCRIPTION	MODEL	UNITS/CASE
	10134	Pt. Can with Applicator Cap	107140131	12
	10131	Qt. Can with Applicator Cap	107140121	12



10131

724™ CPVC Orange, Heavy-Bodied, Medium-Setting

- Heavy-bodied, medium-setting, low-VOC CPVC cement for all classes and schedules with interference fit through 12" (315 mm) diameter
- Premium, high-strength, chemical-resistant solvent cement for use with CPVC piping systems carrying acids, bases, salts and hypochlorites
- Ideal for use in waste water plants
- May be used on PVC industrial piping systems for chemical applications
- Approved for Corzan® CPVC piping systems

LISTING	PRODUCT	DESCRIPTION	MODEL	UNITS/CASE
	13531	Pt. Can with Applicator Cap	13531	12
	12818	Qt. Can with Applicator Cap	107240621	12
	12817	Gal. Can w/ Screw-on Wide-mouth Cap	107240611	6



12818

724™ CPVC Gray, Heavy-Bodied, Medium-Setting

11659

- Heavy-bodied, medium-setting, low-VOC CPVC cement for all classes and schedules with interference fit through 12" (315 mm) diameter
- Premium, high-strength, chemical-resistant solvent cement for use with CPVC piping systems carrying acids, bases, salts and hypochlorites
- Ideal for use in waste water plants
- May be used on PVC industrial piping systems for chemical applications
- Approved for Corzan® CPVC piping systems

LISTINGS	PRODUCT	DESCRIPTION	MODEL	UNITS/CASE
 	11890	Pt. Can with Applicator Cap	107240131	12
	11659	Qt. Can with Applicator Cap	107240121	12
	12233	Gal. Can w/ Screw-on Wide-mouth Cap	107240111	6

729™ CPVC Gray, Extra Heavy-Bodied, Slow-Setting

10845

- Extra heavy-bodied, slow-setting, low-VOC CPVC cement for all classes and schedules of industrial piping with interference fit through 24" (600 mm) diameter
- May be used for chemical applications Industrial quality cement for applications requiring high gap filling properties
- Ideal for fabrication of large fittings

LISTING	PRODUCT	DESCRIPTION	MODEL	UNITS/CASE
 	10845	Qt. Triple Tight Paint Can	107290122	12
	10844	Gal. Triple Tight Paint Can	107290112	4

771™ ABS Milky, Medium-Bodied, Fast-Setting

- Medium-bodied, fast-setting, low-VOC ABS cement for all classes and schedules with interference fit through 8" (200 mm) diameter
- Specially formulated for plumbing applications (DWW, sewer & drain pipe), conduit and foam cores



LISTINGS	PRODUCT	DESCRIPTION	MODEL	UNITS/CASE
 	10233	Pt. Can with Applicator Cap	107710531	12
	10232	Qt. Can with Applicator Cap	107710521	12
	10230	Gal. Can with Screw-on Cap	107710511	6



10232

771™ ABS Yellow, Medium-Bodied, Fast-Setting (For Canada)

- Medium-bodied, fast-setting, low-VOC ABS cement for all classes and schedules with interference fit through 8" (200 mm) diameter
- Specially formulated for plumbing applications (DWW, sewer & drain pipe), conduit and foam cores

LISTINGS	PRODUCT	DESCRIPTION	MODEL	UNITS/CASE
  	10969	1/4 Pt. Can with Applicator Cap	107710851	24
	10968	1/2 Pt. Can with Applicator Cap	107710841	24
	10967	Pt. Can with Applicator Cap	107710831	12
	10966	Qt. Can with Applicator Cap	107710821	12
	10965	Gal. Can with Screw-on Cap	107710811	6



10966

773™ ABS Black, Medium-Bodied, Fast-Setting

- Medium-bodied, fast-setting, low-VOC ABS cement for all classes and schedules with interference fit through 8" (200 mm) diameter
- Specially formulated for plumbing applications (DWW, sewer & drain pipe), conduit and foam core

LISTINGS	PRODUCT	DESCRIPTION	MODEL	UNITS/CASE
 	10246	1/4 Pt. Can with Applicator Cap	107730351	24
	10245	1/2 Pt. Can with Applicator Cap	107730341	24
	10244	Pt. Can with Applicator Cap	107730331	12
	10243	Qt. Can with Applicator Cap	107730321	12
	10241	Gal. Can with Screw-on Cap	107730311	6



10243

790™ Multi-Purpose Clear, Medium-Bodied, Fast-Setting

10257

- Medium-bodied, fast-setting, low-VOC multi-purpose cement for all classes and schedules with interference fit through 6" (160 mm) diameter, Sch. 80 through 4" (110 mm) diameter
- High-strength cement for PVC and CPVC pipe and fittings
- Light amber in color

PRODUCT	DESCRIPTION	MODEL	UNITS/CASE
10260	1/4 Pt. Can with Applicator Cap	107900051	24
10259	1/2 Pt. Can with Applicator Cap	107900041	24
10258	Pt. Can with Applicator Cap	107900031	12
10257	Qt. Can with Applicator Cap	107900021	12
11248	Gal. Can with Screw-on Cap	107900011	6

794™ ABS-PVC Transition Green, Medium-Bodied, Fast-Setting

10273

- Medium-bodied, fast-setting, low-VOC transition cement for all classes and schedules with interference fit through 6" (160 mm) diameter (not for Schedule 80)
- Specifically designed for use on ABS to PVC transition joints in non-pressure systems
- Suitable for sewer, DWV, and conduit

LISTINGS	PRODUCT	DESCRIPTION	MODEL	UNITS/CASE
	13369	1/4 Pt. Can with Applicator Cap	13369	24
	10275	1/2 Pt. Can with Applicator Cap	107940741	24
	10274	Pt. Can with Applicator Cap	107940731	12
	10273	Qt. Can with Applicator Cap	107940721	12
	10272	Gal. Can with Screw-on Cap	107940711	6



P-68™ UV GLOW™ Primer

- Clean, clear appearance that glows purple under UV light
- THF-free. Safer, low fume formula for installers
- Ultra low VOC
- Meets the most stringent codes, regulations and SCAQMD Rule 1168/316A.

LISTINGS	PRODUCT	DESCRIPTION	MODEL	UNITS/CASE
	16213	Pt. Can with Applicator Cap	16213	12
	16212	Qt. Can with Applicator Cap	16212	12



16212

P-68 Primer, Purple

- THF-free. Safer, low fume formula for installers
- Ultra low VOC
- Meets the most stringent codes, regulations and SCAQMD Rule 1168/316A.

LISTINGS	PRODUCT	DESCRIPTION	MODEL	UNITS/CASE
	10216	1/4 Pt. Can with Applicator Cap	10216	24
	10214	1/2 Pt. Can with Applicator Cap	10214	24
	10212	Pt. Can with Applicator Cap	10212	12
	10210	Qt. Can with Applicator Cap	10210	12
	10208	Gal. Can with Screw-on Cap	10208	6



10210

Plumbing Primer, Purple

- Quality low-VOC primer essential for proper softening and preparation of PVC and CPVC pipe and fitting surfaces
- Specially formulated for plumbing applications



LISTINGS	PRODUCT	DESCRIPTION	MODEL	UNITS/CASE
	14028	1/4 Pt. Can with Applicator Cap	14028	24
	14027	1/2 Pt. Can with Applicator Cap	14027	24
	14026	Pt. Can with Applicator Cap	14026	12
	14025	Qt. Can with Applicator Cap	14025	12
	14024	Gal. Can with Screw-on Cap	14024	6



14025

Plumbing Primer, Clear

- Quality low-VOC primer essential for proper softening and preparation of PVC and CPVC pipe and fitting surfaces
- Specially formulated for plumbing applications

LISTINGS	PRODUCT	DESCRIPTION	MODEL	UNITS/CASE
	14033	1/4 Pt. Can with Applicator Cap	14033	24
	14032	1/2 Pt. Can with Applicator Cap	14032	24
	14031	Pt. Can with Applicator Cap	14031	12
	14030	Qt. Can with Applicator Cap	14030	12
	14029	Gal. Can with Screw-on Cap	14029	6



14030

P-70™ Purple Primer



10223

- Premium, industrial-strength, low-VOC primer essential for proper softening and preparation of PVC and CPVC pipe and fitting surfaces
- Specially recommended for use on Schedule 80 (PN 10 and higher) and large size pipe
- Excellent for cold weather applications

LISTINGS	PRODUCT	DESCRIPTION	MODEL	UNITS/CASE
	10229	1/4 Pt. Can with Applicator Cap	107700451	24
	10227	1/2 Pt. Can with Applicator Cap	107700441	24
	10225	Pt. Can with Applicator Cap	107700431	12
	10223	Qt. Can with Applicator Cap	107700421	12
	10221	Gal. Can with Screw-on Cap	107700411	6



P-70™ Clear Primer



10222

- Premium, industrial-strength, low-VOC primer essential for proper softening and preparation of PVC and CPVC pipe and fitting surfaces
- Specially recommended for use on Schedule 80 (PN 10 and higher) and large size pipe
- Excellent for cold weather applications

LISTINGS	PRODUCT	DESCRIPTION	MODEL	UNITS/CASE
	10228	1/4 Pt. Can with Applicator Cap	107700051	24
	10226	1/2 Pt. Can with Applicator Cap	107700041	24
	10224	Pt. Can with Applicator Cap	107700031	12
	10222	Qt. Can with Applicator Cap	107700021	12
	10220	Gal. Can with Screw-on Cap	107700011	6



P-75™ Wet 'R Dry™ Aqua Blue Primer



10248

- Premium, fast-acting, industrial-strength, low-VOC primer essential for proper softening and preparation of PVC and CPVC pipe and fitting surfaces
- For use with 725™ Wet 'R Dry™ Cements
- Specially formulated for wet and/or quick set applications

LISTINGS	PRODUCT	DESCRIPTION	MODEL	UNITS/CASE
	10250	1/2 Pt. Can with Applicator Cap	107750941	24
	10249	Pt. Can with Applicator Cap	107750931	12
	10248	Qt. Can with Applicator Cap	107750921	12
	10247	Gal. Can with Screw-on Cap	107750911	6



C-65™ Clear Cleaner

- Low-VOC cleaner for removal of oil and grease from the surfaces of PVC, CPVC, ABS and STYRENE pipe and fittings
- Recommended for use before priming of pipe and fittings

PRODUCT	DESCRIPTION	MODEL	UNITS/CASE
10204	1/4 Pt. Can with Applicator Cap	107650051	24
10203	1/2 Pt. Can with Applicator Cap	107650041	24
10202	Pt. Can with Applicator Cap	107650031	12
10201	Qt. Can with Applicator Cap	107650021	12
10200	Gal. Can with Screw-on Cap	107650011	6



10201

PC-64™ Purple Primer-Conditioner

- Low-VOC formula for surface preparation of PVC and CPVC pipe and fittings before solvent cement application

PRODUCT	DESCRIPTION	MODEL	UNITS/CASE
10875	1/4 Pt. Can with Applicator Cap	107640451	24
10874	1/2 Pt. Can with Applicator Cap	107640441	24
10873	Pt. Can with Applicator Cap	107640431	12
10872	Qt. Can with Applicator Cap	107640421	12
10871	Gal. Can with Screw-on Cap	107640411	6



10872

PC-64™ Clear Primer-Conditioner

- Low-VOC formula for surface preparation for PVC and CPVC pipe and fittings before solvent cement application

PRODUCT	DESCRIPTION	MODEL	UNITS/CASE
12656	Qt. Can with Applicator Cap	107640021	12



12656

600™ Clear, Regular-Bodied Contact Adhesive

10076

- Contact adhesive for Polyethylene, Polypropylene, PVC, ABS and Styrene non-pressure drainage systems through 4" diameter; HVAC duct applications through 6" diameter interference fit

- Clear, heavy-bodied and fast-setting

PRODUCT	DESCRIPTION	MODEL	UNITS/CASE
10077	Pt. Can with Applicator Cap	106000031	12
10076	Qt. Can with Applicator Cap	106000021	12

810™ White Repair and Fabrication Adhesive

10810

- Two-component, high-strength, low-VOC reactive adhesive for PVC, CPVC, and other dissimilar materials (acrylic, clay, Styrene, fiberglass reinforced polyester, and concrete)

- Product can withstand very high pressure and is high impact-resistant. Excellent gap-filling property which is ideal for fabricating fittings and joining saddles to pipe
- Good for bonding large diameter PVC and CPVC pipe and fittings

PRODUCT	DESCRIPTION	MODEL	UNITS/CASE
10813	4 Oz. Plastic Jar with Screw-on Cap	10810K151	6
10812	Pt. Plastic Jar with Screw-on Cap	10810K131	4
10811	Qt. Plastic Jar with Screw-on Cap	10810K121	4
10810	Gal. Plastic Jar with Screw-on Cap	10810K111	4

Applicators (Daubers, Rollers & Swabs) for Solvent Cementing

PRODUCT	DESCRIPTION	MODEL	UNITS/CASE
14108	SuperSwab (swab and handle included)	14108	12
14111	SuperSwab – bulk pack (swabs and handles included)	14111	24
14112	Replacement swabs – bulk pack	14112	24
10832	SuperDauber 75, 3/4" Adjustable Dauber	001720000	50
10833	SuperDauber 150, 1-1/4" Adjustable Dauber	001710000	50
10003	Pint Sized Cap Dauber 3/4" for FlowGuard Gold®	006190000	50
10004	DP-75 Cap Dauber for 3/4" up to 1-1/2" Pipe Diameter	006150000	50
10005	DP-150 Cap Dauber 1-1/2" for up to 3" Pipe Diameter	006160000	50
10006	DQ-150 Cap Dauber 1-1/2" for up to 3" Pipe Diameter	006170000	50
13199	DH-38, 3/8" Cap Dauber for FlowGuard Gold® 1/4 & 1/2 Pint Cans	006200000	50
11831	DQ-50, 1/2" Cap Dauber for FlowGuard Gold® Qt. Can	006180000	50
12429	DQ-75 Cap Dauber 3/4" for up to 1-1/2" Pipe Diameter	006580000	50
12121	PB-1 Brush in Plastic Cap w/Handle for Pt. & Qt. Cans	006010000	25
10007	3020 Roll-A-Weld 3" Roller for MT-653 Qt. Can	006300000	24
10008	7020 Jumbo Roll-A-Weld 7" Roller for MT-648 Gal. Can	006310000	20
12071	5020 4" Swab for MT-651 Qt. Can	006340000	24
11957	6020 4" Roller for MT-651 Qt. Can	006330000	24
10009	4020 4" Swab for MT-648 Gal. Can	006320000	24
13360	8020 4" Cotton Swab, Wire Handle for 6" Diameter or Larger Pipe	13360	24

Applicators (Daubers, Rollers & Swabs) for Solvent Cementing

SuperSwab™ Patent No. 8747004

- A sturdy easy-to-grip 4" swab for pipe diameters 4"–8"
- The swab tip is disposable and swab handle is reusable
- Adjustable length and dual cap fits quart and gallon containers

AVAILABLE OPTIONS

- Individual Pack (#14108)
- Bulk Pack Replacement (#14111)
- Swab Tip Bulk Pack (#14112)



SuperDauber™ 3/4" (#10832) and 1-1/4" (#10833)

- Fully adjustable, telescopic stem fits quart, pint and 1/2 pint cans.
- Easy grip, ribbed handle allows better dauber control.
- Shed-resistant dauber material is better for smooth, II application of cement or primer.



Cap Daubers

- DH Daubers fit 1/4 pint and 1/2 pint cans
- DP daubers fit 1/2 pint and pint cans
- DQ daubers fit quart cans
- Available in 3/8", 1/2", 3/4", and 1-1/2" dauber sizes

Available Sizes

- DH-38 (#13199)
- DH-75 (#10004)
- DQ-50 (#11831)
- DQ-75 (#12429)
- DQ-150 (#10006)
- DP-50 (#10003)
- DP-150 (#10005)



PB-1 Brush Product (#12121)

- Plastic handle brush fits standard pint and quart cans.



3020 Roller Product #10007

- Roll-A-Weld 3" roller for pipe diameters from 3" through 6"
- Fits MT-653 empty quart triple tight neck can



6020 Roller

Product #11957

- Roll-A-Weld 4" roller for pipe diameters from 3" through 8"
- Fits standard quart can as well as MT-651 empty quart can



7020 Roller Product #10008

- Jumbo Roll-A-Weld 7" roller for pipe diameters of 6" or larger
- Fits MT-648 empty gallon can and cements available in wide mouth cans



4020 Swab

Product #10009

- 4" swab for pipe diameters of 6" or larger
- Fits MT-648 empty gallon can and cements available in wide mouth cans



5020 Swab Product #12071

- 4" swab for pipe diameters from 3" through 8"
- Fits standard quart can as well as MT-651 empty quart can



8020 Swab

Product #13360

- 4" cotton swab with wire handle for use on pipe diameter 6" or larger.
- Fits standard quart cans and MT-651 empty quart cans.



Applicator Selection Guide

See the following charts for applicator recommendations for your pipe size.

Weld-On solvent cements are packaged with can-lid daubers:

- 3/4" dauber on quarter pint and half pint cans
- 1-1/2" dauber on pint and quart cans

PIPE DIAMETER	1/4"	1/2"	3/4"	1"	1-1/4"	1-1/2"	2"
3/8" Dauber	•	•	•				
1/2" Dauber			•	•			
3/4" Dauber					•	•	
1-1/2" Dauber							•

Rollers & Swabs	Size	Pipe Diameters
3020	3" Roller	3" - 6"
3020	4" Roller	3" - 8"
7020	7" Roller	6"+
4020	4" Swab	6"+
5020	4" Swab	3" - 8"
8020	4" Swab	6"+
SuperSwab™	4" Swab	4" - 8"

For proper solvent welding of pipe and fittings, the cement applicator must be no less than half the size of the pipe.



Easy Twist™ Can Opener



14550

- Ergonomically designed to easily open cement cans without damaging can
- Tightens and seals the cap with an extra torque

PRODUCT	DESCRIPTION	MODEL	UNITS/CASE
14550	Easy Twist, 8-pack display	14550	8

Empty Containers



10014

10010

10012

10015

- Applicator not included
- For solvent cements or primers

PRODUCT	DESCRIPTION	MODEL	UNITS/CASE
10010	MT-648 Gal. Can with 2 7/8" Neck	006480000	6
10012	MT-651 Qt. Can with 1 3/4" Neck	006510000	12
10014	MT-653 Qt. Can with Triple Tight Paint Can	006530000	12
10015	MT-654 Pt. Can with 1 3/4" Neck	006540000	12

Cement and Primer Carriers





12891

- For carrying quart and pint cans

PRODUCT	DESCRIPTION	MODEL	UNITS/CASE
12891	CanTote™ for carrying quart & pint cement cans	1870000	24
14147	Can-Mate® Carrier/2 Dauber Kit for 1/2 pint, pint, & quart cans	1840000	24

ALL SEAL™ Beige Plastic and Metal Pipe Thread Sealant

- Multi-purpose sealant
- Slow drying, soft-setting, formula allows ample time to work with pipe joints. Also easy for disassembly
- Creamy, non-separating consistency provides excellent thread coverage
- Very low-VOC content: 152 g/L
- Product is grit-free to provide leak-proof seal on pipe threads
- For sealing and lubricating all metal and plastic (ABS, PVC, CPVC, Polypropylene & Nylon) piping systems carrying various materials
- 2-year shelf life

LISTINGS	PRODUCT	DESCRIPTION	MODEL	UNITS/CASE
	87660	1/4 Pt. Can with Brush in Cap Applicator	R5123	24
	87665	1/2 Pt. Can with Brush in Cap Applicator	R5124	24
	87670	Pt. Can with Brush in Cap Applicator	R5125	12



87670

BLUE SEAL™ Blue Plastic and Metal Pipe Thread Sealant

- Industrial grade sealant
- Excellent for industrial applications and pipe lines in high vibration environments
- Contains finely homogenized PTFE particles for filling cracks and thread imperfections – ensuring leak-proof seal
- Heavy duty, grit-free formula
- For sealing and lubricating all metal and plastic (ABS, PVC, CPVC, Polypropylene & Nylon) piping systems carrying various materials
- Zero VOC content
- 3-year shelf life

LISTINGS	PRODUCT	DESCRIPTION	MODEL	UNITS/CASE
	87685	1/2 Pt. Can with Brush in Cap Applicator	R5134	24
	87690	Pt. Can with Brush in Cap Applicator	R5135	12
	87695	Qt. Can with Brush in Cap Applicator	R5136	12



87690



White Seal Plus™ White Plastic and Metal Pipe Thread Sealant

- Multi-purpose sealant with PTFE
- Contains finely homogenized PTFE particles for filling cracks and thread imperfections – ensuring a leak-proof seal
- Non-setting formula allows easy disassembly of joints without damage to pipe, fittings or threads
- Protects threaded areas from rust and corrosion and prevents galling
- For sealing and lubricating all metal and plastic (ABS, PVC, CPVC, Polypropylene & Nylon) piping systems carrying various materials.1 Compatible with FlowGuard Gold®, BlazeMaster® and Corzan®
- Zero VOC content
- 3-year shelf life

LISTINGS	PRODUCT	DESCRIPTION	MODEL	UNITS/CASE
	80200	1.7 Oz. Tube	R5002	12
	87725	1/4 Pt. Can with Brush in Cap Applicator	R5163	24
	87730	1/2 Pt. Can with Brush in Cap Applicator	R5164	24
	87735	Pt. Can with Brush in Cap Applicator	R5165	12
	87740	Qt. Can with Brush in Cap Applicator	R5166	12



87735



Weld-On®
Guy Gray®
Water-Tite®
ToughPans®
RTB
Test-Tite®
AB&A®
Studor®
Truebro®
Christy's®
FloodStop®
ProVent®
ProSet®

505™ Key-Tite™ Green Metal Pipe Thread Sealant

10064

- Special formulation seals and lubricates metal pipe joints as well as protects them from rusting and seizing
- Applicable for all types of metal joints (threaded, flanged or gasketed)
- For sealing and lubricating all metal piping systems carrying various materials

PRODUCT	DESCRIPTION	MODEL	UNITS/CASE
10068	1/2 Pt. Can with Brush in Cap Applicator	105050041	24
10064	Pt. Can with Brush in Cap Applicator	105050031	12
10063	Qt. Triple Tight Paint Can	105050022	12

Epoxy Putty Stick

84055

- Quick-hardening sealant/adhesive
- Plugs, seals, patches or repairs most materials except polyethylene or polypropylene
- Excellent for underwater repairs
- Non-toxic, safe for potable water line
- Hardens in 20 minutes and cures in 1 hour
- Lead-free and non-toxic

PRODUCT	DESCRIPTION	MODEL	UNITS/CASE
84055	4 Oz. Epoxy Putty Stick	REP1	24

Pipe Stick Joint Compound

81255

- Thread sealant for metal and plastic pipe
- Lead-free and non-toxic
- Prevents rust and corrosion allowing easier disassembly
- Packaged 12 per box

PRODUCT	DESCRIPTION	MODEL	UNITS/CASE
81255	1.3 Oz. Pipe Stick Joint Compound	R5071	144

182™ Roof Flashing Cement

10051

- For repairing and sealing leaks around flashings, sky lights, vents, gutter and other protrusions
- Wet or dry weather plastic cement

PRODUCT	DESCRIPTION	MODEL	UNITS/CASE
10051	Qt. Triple Tight Paint Can	101820021	12
10050	Gal. Triple Tight Paint Can	101820011	4

Soft Seal™ Plumbers Putty

- Weld-On® Soft Seal Plumber's Putty is compatible with ABS, PVC, and all metals. Check other manufacturer's putty installation instructions to ensure compatibility with ABS and PVC plastics
- For setting and sealing plumbing fixtures and drains
- Will not harden, crack or crumble
- Complies with Federal Specification TT-P-1536A
- Lead-free, non-corrosive and stainless
- 100% waterproof



80100

PRODUCT	DESCRIPTION	MODEL	UNITS/CASE
80100	14 Oz. Poly Tub	R5101	24
80103	3 Lb. Poly Tub	R5103	6
80105	5 Lb. Poly Tub	R5105	6

Stain Free Soft Seal™ Plumbers Putty

- Stain-free for use on granite, marble, stone, quarts and fiberglass
- For setting and sealing plumbing fixtures and drains
- Do not apply on ABS surfaces
- Will not harden, crack or crumble
- 100% waterproof
- Complies with Federal Specification TT-P-1536A



80111

PRODUCT	DESCRIPTION	MODEL	UNITS/CASE
80111	14 Oz. Poly Tub	80111	24

PTFE Thread Seal Tapes

- Meets Fed. mil SPEC T-27730A
- Gray (SS) and Green (02) also meets A-A 58092
- White Oxygen Line Tape also meets CID A-A 58092
- Virgin PTFE Particles
- Contractor Quality
- Great Stretch/Tear Properties



87755

PRODUCT	DESCRIPTION	MODEL	UNITS/CASE
80315	1/2" x 260" White PTFE Tape - 3.5 MIL, .4 g/cm3	TA-S260	500
80310	1/2" x 520" White PTFE Tape - 3.5 MIL, .4 g/cm3	TA-S520	500
87750	3/4" x 260" White PTFE Tape - 3.5 MIL, .4 g/cm3	TA-SW260	350
87755	3/4" x 520" White PTFE Tape - 3.5 MIL, .4 g/cm3	TA-SW520	350
87720	1" x 520" White PTFE Tape - 3.5 MIL, .4 g/cm3	TA-SX520	250
80325	1/2" x 260" Pink Heavy Duty PTFE Tape - 4 MIL, .9 g/cm3	TA-USTT1226P	500
80320	1/2" x 260" Yellow PTFE Tape for Gas Lines - 4 MIL, .9 g/cm3	TA-USTT1226Y	500
513544	1/2" x 260" Gray PTFE Tape for Stainless Steel Lines - 4 MIL, 1.2 g/cm3	TA-USTT1226GRAY	144
513543	1/2" x 260" Green PTFE Tape for Oxygen Lines - 4 MIL, 1.2 g/cm3	TA-USTT1226G	144
513547	1/2" x 520" White PTFE Tape for Oxygen Lines - 4 MIL, 1.2 g/cm3	TA-USTT1252	144

Light Cutting Oil



80424

For light-duty manual or low-RPM machine threading of ferrous and non-ferrous metals as well as for drilling, reaming and rolling machines using ferrous and non-ferrous metals

PRODUCT	DESCRIPTION	MODEL	UNITS/CASE
80424	Qt. Poly Bottle	R1523	24
80425	Gal. Poly Bottle	R1525	6

Dark Cutting Oil



80420

- For medium- to heavy-duty cutting, threading, drilling, reaming and rolling machines using ferrous and non-ferrous metals
- High-grade oil blend

PRODUCT	DESCRIPTION	MODEL	UNITS/CASE
80420	Qt. Poly Bottle	R1623	12
80421	Gal. Poly Bottle	R1625	6

Brushes and Sand Cloth



81352

81352

- For medium- to heavy-duty cutting, threading, drilling, reaming and rolling machines using ferrous and non-ferrous metals
- High-grade oil blend

PRODUCT	DESCRIPTION	MODEL	UNITS/CASE
81352	Acid Brushes	R5401	144
81610	1/2" Premium Duty Fitting Brush	R5553	12
81620	3/4" Premium Duty Fitting Brush	R5555	12
81625	1" Premium Duty Fitting Brush	R5557	12
81630	1-1/4" Premium Duty Fitting Brush	R5559	12
81635	1-1/2" Premium Duty Fitting Brush	R5561	12
81640	2" Premium Duty Fitting Brush	R5563	12
87795	1/2" Heavy Duty Wire Handle Fitting Brush	R5581	12
87800	3/4" Heavy Duty Wire Handle Fitting Brush	R5583	12
87805	1" Heavy Duty Wire Handle Fitting Brush	R5585	12
81651	Combination 4-n-1 Copper Tube & Fitting Brush	R5566	10
81560	1/2" Copper Tube Cleaning Brush	R5570	36
81565	3/4" Copper Tube Cleaning Brush	R5575	36
81400	2 Yds. x 1-1/2" Sand Cloth	R5451	24
81405	10 Yds. x 1-1/2" Sand Cloth	R5455	24
81410	25 Yds. x 1-1/2" Sand Cloth	R5460	24
81500	5 Yds. x 1-1/2" Open Mesh Cloth	R5501	24
81505	10 Yds. x 1-1/2" Open Mesh Cloth	R5503	24
80890	Flame Stopper 9" x 12" Torch Protector	RFS1	25

EZ Flush™ Pipe Lubricant

- Applicable for joining all metal and plastic gasketed pipes
- Lubricates slip-on or "O" ring type joints without harming rubber or plastic gaskets
- Easily flushes out of piping system
- Non-toxic and non corrosive
- No taste or odor transferred to fluids in piping system



LISTINGS	PRODUCT	DESCRIPTION	MODEL	UNITS/CASE
NSF	87717	Pt. Poly Tub	87717	24
	87718	Qt. Poly Tub	87718	12
	87719	Gal. Poly Tub	87719	4
	87721	5 Gal. Poly Tub	87721	1

Seal Lube Gasket Lubricant

- Primes and lubricates slip-on or "O" ring type joints with rubber or synthetic rubber gaskets
- Non-toxic and non-corrosive
- No taste or odor
- 100% water soluble



87710

LISTINGS	PRODUCT	DESCRIPTION	MODEL	UNITS/CASE
NSF	87705	Pt. Poly Tub	R5175	12
	87710	Qt. Poly Tub	R5176	12
	87715	Gal. Poly Tub	R5177	4

Slik Seal™ Plumbers Grease

- For lubricating valve stems, faucets, ball cocks, ensuring smooth operation
- Does not include silicone
- 100% waterproof
- Combination of lithium soap, solvent refined basestock and additives
- Excellent for hot water steam or potable water systems



80427

LISTINGS	PRODUCT	DESCRIPTION	MODEL	UNITS/CASE
NSF	80427	1 Oz. Tin	R301	24

Guy Gray®

Water-Tite®

ToughPans®

RTB

Test-Tite®

AB&A®

Studor®

Truebro®

Christy's®

FloodStop®

ProVent®

ProSet®

ProSet®

ProVent®

FloodStop®

Christy's®

Truebro®

Studor®

AB&A®

Test-Tite®

RTB

ToughPans®

Water-Tite®

Guy Gray®

Weld-On®

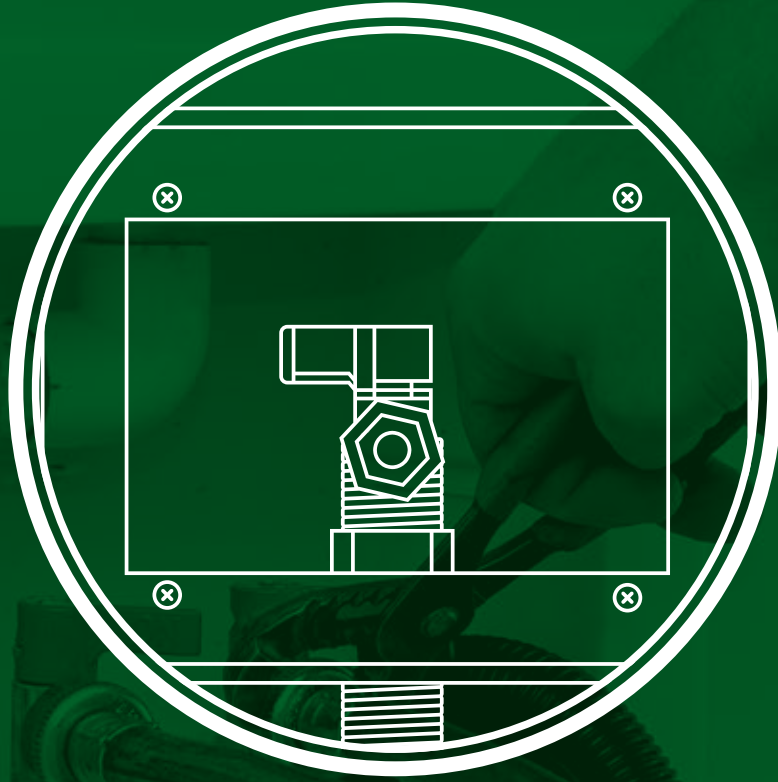

GUY GRAY®

1958

The first-ever washing machine outlet box manufacturer

Starting with the original washing machine outlet box in 1958, the Guy Gray® line has always featured innovative metal-box solutions to keep pace with an ever-evolving industry.



Today

Now the first choice for all metal outlet boxes

What began as a handful of galvanized metal boxes is now an extensive, widely trusted product line – the industry's No. 1 choice in metal outlet boxes. Guy Gray® also offers a wide range of domestic valves and fire-rated boxes.



Center Drain Galvanized Washing Machine Outlet Boxes



82032

- 20-gauge box / 20-gauge faceplate
- G90 hot-dipped galvanized steel (Unpainted)
- Male threaded drain fitting & locknut included
- Rough opening: 10" W x 8-3/4" H x 3-1/2" D
- Faceplate dimension: 11-5/8" W x 9-1/2" H
- Domestic valves
- 3/4" Hose outlet
- Unassembled

LISTINGS	PRODUCT	DESCRIPTION	MODEL	UNITS/CASE
	82026	Qtr-turn Valves, 1/2" MIP/Sweat Conn., 1-1/2" Threaded Drain Fitting	B150	6
	82032	Qtr-turn Valves, 1/2" MIP/Sweat Conn., 2" Threaded Drain Fitting	B200	6
UPC®	82036	Qtr-turn Vavles, 1/2" MIP/Sweat Conn. Valves, 2" Threaded Drain Fitting, Top-mount	BB200TS	6
	81974	Qtr-turn Vavles, 1/2" F1807 Conn., 2" Threaded Drain	B200X	6
	81975	Qtr-turn Vavles, 1/2" CPVC Conn., 2" Threaded Drain	B200C	6
	81957	B200 Outlet Box With 2" Threaded Drain Fitting, Less Valves	B200LV	6
	97091	Replacement Faceplate for Models B, BB, WB, FB, & BIM; 20 Ga. Galvanized ¹	B	1

Center Drain Galvanized Washing Machine Outlet Boxes with Duplex Receptacle



82033

- 20-gauge box / 20-gauge faceplate
- G90 hot-dipped galvanized steel (Unpainted)
- Male threaded drain fitting & locknut included
- Duplex receptacle: 20 amp, 110 volt
- Available with GFCI Receptacle: 20 Amp, 125 Volt
- Rough opening: 12-1/4" W x 8-3/4" H x 3-1/2" D
- Faceplate dimension: 13-3/4" W x 9-1/2" H
- Domestic valves
- 3/4" Hose outlet
- Unassembled

LISTINGS	PRODUCT	DESCRIPTION	MODEL	UNITS/CASE
	82033	Qtr-turn Valves, 1/2" MIP/Sweat Conn., 2" Threaded Drain Fitting	BE200	6
	82037	Qtr-turn Valves, 1/2" MIP/Sweat Conn., 2" Threaded Drain Fitting, Top-mount	BBE200TS	6
UPC®	With GFCI Receptacle			
	82633	Qtr-turn Valves, 1/2" MIP/Sweat, GFCI Receptacle	BE200GF	6
	82636	Qtr-turn Valves, 1/2" MIP/Sweat, GFCI Receptacle, Top Mount	BBE200TSGF	6
	97092	Replacement Faceplate for Models BE, BBE, WBE, & FBE; 20 Ga. Galvanized ¹	BE	1

¹Faceplates are Category *

Center Drain Galvanized Washing Machine Outlet Boxes with Duplex & Dryer Receptacles

- 20-gauge box / 20-gauge faceplate
- G90 hot-dipped galvanized steel (Unpainted)
- Male threaded drain fitting & locknut included
- Duplex receptacle: 20 amp, 110 volt
- Dryer receptacle: 30 amp, 220 volt, 3-wire
- Available with GFCI Receptacle: 20 Amp, 125 Volt
- Rough opening: 14-1/4" W x 8-3/4" H x 3-1/2" D
- Faceplate dimension: 15-3/4" W x 9-1/2" H
- Domestic valves
- 3/4" Hose outlet
- Unassembled



82034

LISTINGS	PRODUCT	DESCRIPTION	MODEL	UNITS/CASE
	82028	Qtr-turn Valves, 1/2" MIP/Sweat Conx., 1-1/2" Threaded Drain Fitting	BED150	6
	82034	Qtr-turn Valves, 1/2" MIP/Sweat Conx., 2" Threaded Drain Fitting	BED200	6
	81978	Qtr-turn Valves, 1/2" F1807 Conx., Duplex & 3 Wire Receptacle	BED200P	6
	82038	Qtr-turn Valves, 1/2" MIP/Sweat Conx., 2" Threaded Drain Fitting, Top-mount	BBED200TS	6
	With GFCI Receptacle			
	82632	Qtr-turn Valves, 1/2" MIP/Sweat Conx., 1-1/2" Threaded Drain, GFCI & 3 Wire Receptacle	BED150GF	6
	82634	Qtr-turn Valves, 1/2" MIP/Sweat Conx., GFCI & 3 Wire Receptacle	BED200GF	6
	82679	Qtr-turn Valves, 1/2" F1807 Conx., GFCI & 3 Wire Receptacle	BED200PGF	6
	82637	Qtr-turn Valves, 1/2" MIP/Sweat Conx., GFCI & 3 Wire Receptacle, Top Mount	BBED200TSGF	6
	97093	Replacement Faceplate for Models BED, BBED, WBED, & FBED; 20 Ga. Galvanized ¹	BED	1



¹Faceplates are Category *

Center Drain Galvanized Washing Machine Outlet Boxes with Duplex and Dryer Receptacles on Right



82035

- 20-gauge box / 20-gauge faceplate
- G90 hot-dipped galvanized steel (Unpainted)
- Male threaded drain fitting & locknut included
- Duplex receptacle: 20 amp, 110 volt
- Dryer receptacle: 30 amp, 220 volt
- Available with GFCI Receptacle: 20 Amp, 125 Volt
- Rough opening: 14" W x 8-3/4" H x 3-1/2" D
- Faceplate dimension: 15-3/4" W x 9-1/2" H
- Domestic valves
- 3/4" Hose outlet
- Unassembled

LISTINGS	PRODUCT	DESCRIPTION	MODEL	UNITS/CASE
	82142	Qtr-turn Valves, 1/2" MIP/Sweat Conn., 2" Drain, 3 Wire 220V Receptacle	NWBED200-3	6
	82035	Qtr-turn Valves, 1/2" MIP/Sweat Conn., 2" Drain, 4 Wire 220V Receptacle	NWBED200-4	6
	With GFCI Receptacle			
	82671	Qtr-turn Valves, 1/2" MIP/Sweat, GFCI & 3 Wire Receptacle	NWBED2003GF	6
	82635	Qtr-turn Valves, 1/2" MIP/Sweat, GFCI & 4 Wire Receptacle	NWBED2004GF	6
	97094	Replacement Faceplate for Models NWBED, WNWBED, & NWFBED; 20 Ga. Galvanized ¹	NWBED	1

Right Drain Galvanized Washing Machine Outlet Boxes with Hammer Arrestor Valves



82043

- 20-gauge box / 20-gauge faceplate
- G90 hot-dipped galvanized steel (Unpainted)
- Male threaded drain fitting & locknut included
- Rough opening: 10" W x 8-3/4" H x 3-1/2" D
- Faceplate dimension: 11-5/8" W x 9-1/2" H
- Unassembled

LISTINGS	PRODUCT	DESCRIPTION	MODEL	UNITS/CASE
	82030	Qtr-turn Domestic Valves, 1/2" MIP/Sweat Conn., 1-1/2" Threaded Drain Fitting	FB150	6
	82039	Qtr-turn Domestic Valves, 1/2" MIP/Sweat Conn., 2" Threaded Drain Fitting	FB200	6
	82031	Single-Lever Valve, 1/2" MIP/Sweat Conn., 1-1/2" Threaded Drain Fitting	WB150	6
	82043	Single-Lever Valve, 1/2" MIP/Sweat Conn., 2" Threaded Drain Fitting	WB200	6
	97091	Replacement Faceplate for Models B, BB, WB, FB, & BIM; 20 Ga. Galvanized ¹	B	1

¹Faceplates are Category *

Right Drain Galvanized Washing Machine Outlet Boxes with Hammer Arrestor Valves

- 20-gauge box / 20-gauge faceplate
- G90 hot-dipped galvanized steel (Unpainted)
- Male threaded drain fitting & locknut included
- Rough opening: 10" W x 8-3/4" H x 3-1/2" D
- Faceplate dimension: 11-5/8" W x 9-1/2" H
- Unassembled

LISTINGS	PRODUCT	DESCRIPTION	MODEL	UNITS/CASE
	82048	Single-Lever Arrestor Valves, 2" Drain	WB200HA	6
	97091	Replacement Faceplate for Models B, BB, WB, FB, & BIM; 20 Ga. Galvanized ¹	B	1



82048

Right Drain Galvanized Washing Machine Outlet Boxes with Duplex Receptacle

- 20-gauge box / 20-gauge faceplate
- G90 hot-dipped galvanized steel (Unpainted)
- Male threaded drain fitting & locknut included
- Duplex receptacle: 20 amp, 110 volt
- Available with GFCI Receptacle: 20 Amp, 125 Volt
- Rough opening: 12-1/4" W x 8-3/4" H x 3-1/2" D
- Faceplate dimension: 13-3/4" W x 9-1/2" H
- Unassembled

LISTINGS	PRODUCT	DESCRIPTION	MODEL	UNITS/CASE
	82040	Qtr-turn Domestic Valves, 1/2" MIP/Sweat Conx.	FBE200	6
	82044	Single-Lever Valve, 1/2" MIP/Sweat Conx.	WBE200	6
	82047	Single Lever Arrestor Valve, 1/2" MIP/Sweat	WBE200HA	6
	With GFCI Receptacle			
	82668	Single-Lever Valve, 1/2" MIP/Sweat Conx., GFCI Receptacle	WBE200GF	6
	82631	Single-Lever Valve, 1/2" MIP/Sweat Conx., GFCI Receptacle	WBE200HAGF	6
97092	Replacement Faceplate for Models BE, BBE, WBE, & FBE; 20 Ga. Galvanized ¹	BE	1	



82631

¹Faceplates are Category *

Right Drain Galvanized Washing Machine Outlet Boxes with Duplex and Dryer Receptacle



82669

- 20-gauge box / 20-gauge faceplate
- G90 hot-dipped galvanized steel (Unpainted)
- Male Threaded drain fitting & locknut included
- Duplex Receptacle: 20 amp, 110 volt
- Available with GFCI Receptacle: 20 Amp, 125 Volt
- Dryer Receptacle: 30 amp, 220 volt, 3-wire
- Rough Opening: 14-1/4" W x 8-3/4" H x 3-1/2" D
- Faceplate dimension: 15-3/4" W x 9-1/2" H
- Unassembled

LISTINGS	PRODUCT	DESCRIPTION	MODEL	UNITS/CASE
	82041	Qtr-turn Domestic Valves, 1/2" MIP/Sweat Conx.	FBED200	6
	82045	Single-Lever Valve, 1/2" MIP/Sweat Conx.	WBED200	6
	With GFCI Receptacle			
	82639	Qtr-turn Domestic Valves, 1/2" MIP/Sweat Conx, GFCI & 3 Wire Receptacle	FBED200GF	6
	82669	Single-Lever Valve, 1/2" MIP/Sweat Conx, GFCI & 3 Wire Receptacle	WBED200GF	6
	97093	Replacement Faceplate for Models BED, BBED, WBED, & FBED; 20 Ga. Galvanized ¹	BED	1

Right Drain Galvanized Washing Machine Outlet Boxes with Duplex and Dryer Receptacle on Right



82042

- 20-gauge box / 20-gauge faceplate
- G90 hot-dipped galvanized steel (Unpainted)
- Male threaded drain fitting & locknut included
- Duplex receptacle: 20 amp, 110 volt
- Available with GFCI Receptacle: 20 Amp, 125 Volt
- Dryer receptacle: 30 amp, 3 or 4-wire
- Rough opening: 14" W x 8-3/4" H x 3-1/2" D
- Faceplate dimension: 15-3/4" W x 9-1/2" H
- Unassembled

LISTINGS	PRODUCT	DESCRIPTION	MODEL	UNITS/CASE
	82042	Qtr-turn Domestic Valves, 1/2" MIP/Sweat Conx., 4 Wire 220 V Receptacle	NWFBED2004	6
	82046	Single-Lever Valve, 1/2" MIP/Sweat Conx., 3 Wire 250 V Receptacle	WNWBED2003	6
	82144	Single-Lever Valve, 1/2" MIP/Sweat Conx., 4 Wire 250 V Receptacle	WNWBED2004	6
	81979	Single-Lever Arrester Valve, 1/2" MIP/Sweat Conx., Duplex & 4 Wire Receptacle	WNWBED2004HA	6
	With GFCI Receptacle			
	82640	Qtr-turn Domestic Valves, 1/2" MIP/Sweat Conx., GFCI & 4 Wire Receptacle	NWFBED2004GF	6
	82670	Single-Lever Valve, 1/2" MIP/Sweat Conx., GFCI & 3 Wire Receptacle	WNWBED2003GF	6
	82678	Single-Lever Valve, 1/2" MIP/Sweat Conx., GFCI & 4 Wire Receptacle	WNWBED2004GF	6
	82680	Single-Lever Arrester Valve, 1/2" MIP/Sweat Conx., GFCI & 4 Wire Receptacle	WNWBED2004HAGF	6
	97094	Replacement Faceplate for Models NWBLED, WNWBLED, & NWFBLED; 20 Ga. Galvanized ¹	NWBLED	1

¹Faceplates are Category *

"T" Series Center Drain White Powder-Coated Cold Rolled Steel Washing Machine Outlet Boxes

- 20-gauge box / 20-gauge faceplate
- Knockouts in top, bottom and sides
- Watertight construction with sloped bottom
- White powder coat finish on cold rolled steel
- Rough opening: 12 3/4" W x 8-1/4" H x 3" D
- Faceplate dimension: 14" W x 9 1/4" H
- 2" PVC, ABS or Slipnut Drain Kit included (2" male adapter or pipe nipple not included in Slipnut Kit)
- Available with quarter-turn ball valve, quarter-turn ball valves with hammer arresters or domestic valves
- Unassembled



82139



82147



82158



82140

LISTINGS	PRODUCT	DESCRIPTION	MODEL	UNITS/CASE
	82139	Brass Qtr-turn Domestic Valves, 1/2" MIP/Sweat Conn., 2" Slipnut Drain Kit	T200	6
	82311	Brass Qtr-turn Valves, 1/2" Sweat Conn., 2" Slipnut Drain Kit	T200QT	6
	82135	Brass Qtr-turn Domestic Valves, 1/2" MIP/Sweat Conn., 2" PVC Drain Fitting	T200TPPVC	6
	82353	Brass Qtr-turn Valves, 1/2" Sweat Conn., 2" PVC Drain Fitting	T200TPPVCQT	6
	82136	Brass Qtr-turn Domestic Valves, 1/2" MIP/Sweat Conn., 2" ABS Drain Fitting	T200TPABS	6
	82147	Brass Qtr-turn Valves, 1/2" Sweat Conn., 2" ABS Drain Fitting	T200TPABSQT	6
	82145	Brass Qtr-turn Valves, 1/2" CPVC Conn., 2" PVC Drain Fitting	T200TPPVCCPVC	6
	82354	Brass Qtr-turn Valves, 1/2" F1960 Conn., 2" Slipnut Drain Kit	T200QTF1960	6
	82158	Brass Qtr-turn Valves w/HA, 1/2" Sweat Conn., 2" PVC Drain Fitting	T200TPPVCHA	6
	82159	Brass Qtr-turn Valves w/HA, 1/2" CPVC Conn., 2" Slipnut Drain Kit	T200TPCVCHA	6
	82480	Brass Qtr-turn Valves w/HA, 1/2" F1807 Conn., 2" PVC Drain Fitting	T200TPPVCPHA	6
	82481	Brass Qtr-turn Valves w/HA, 1/2" F1960 Conn., 2" PVC Drain Fitting	T200TPPVCWHA	6
	82137	Box w/o Valves, 2" PVC Drain Fitting	T200TPPLV	6
	82138	Box w/o Valves, 2" ABS Drain Fitting	T200TPABSLV	6
	82140	Box w/o Valves, 2" Slipnut Drain Kit	T200LV	6
	97095	Replacement Faceplate for Model T150, T200; 20 Ga. White ¹	T	1

¹ Faceplates are Category *

"TT" Series Center Drain White Powder-Coated Cold Rolled Steel Washing Machine Outlet Boxes



82348

- 20-gauge box / 20-gauge faceplate
- White powder coat finish on cold rolled steel
- Lip guard on bottom to prevent overflow
- Extra deep faceplate accommodates up to 2 pieces of 5/8" drywall
- Rough opening: 8-1/4" W x 5-5/8" H x 3-1/2" D
- Faceplate dimension: 10-7/8" W x 8-3/8" H
- Available with quarter-turn ball valves or domestic valves
- Reversible right or left and center drain option
- 2" PVC, ABS or Slipnut Drain Kit included (2" male adapter or pipe nipple not included in Slipnut Kit)
- Unassembled

LISTINGS	PRODUCT	DESCRIPTION	MODEL	UNITS/CASE
	82340	Brass Qtr-turn Domestic Valves, 1/2" MIP/Sweat Conx. Dual Drain, 2" Slipnut Drain Kit	TT200	6
	82341	Brass Qtr-turn Valves, 1/2" Sweat Conx. Dual Drain, 2" Slipnut Drain Kit	TT200QTS	6
	82342	Brass Qtr-turn Domestic Valves, 1/2" MIP/Sweat Conx. Dual Drain, 2" PVC Drain Fitting	TT200TPPVC	6
	82343	Brass Qtr-turn Valves, 1/2" Sweat Conx. Dual Drain, 2" PVC Drain Fitting	TT200TPPVCS	6
	82344	Brass Qtr-turn Valves, 1/2" CPVC Conx. Dual Drain, 2" PVC Drain Fitting	TT200TPPVCC	6
	82345	Brass Qtr-turn Valves, 1/2" F1807 Conx. Dual Drain, 2" PVC Drain Fitting	TT200TPPVCP	6
	82346	Brass Qtr-turn Domestic Valves, 1/2" MIP/Sweat Conx. Dual Drain, 2" ABS Drain Fitting	TT200TPABS	6
	82348	Brass Qtr-turn Valves, 1/2" CPVC Conx. Dual Drain, 2" ABS Drain Fitting	TT200TPABSC	6
	82306	Brass Qtr-turn Valves, 1/2" F1960 Conx., Dual Drain 2" PVC Drain Fitting	TT200TPPVCW	6
	97095	Replacement Faceplate for Model T150, T200; 20 Ga. White ¹	T	1



Reversible Drain White Powder-Coated Econo Metal Washing Machine Outlet Box



82112

- 20-gauge box / 20-gauge faceplate
- White powder coat finish on cold rolled steel
- Lip guard on bottom to prevent overflow
- Extra-deep faceplate accommodates up to 2 pieces of 5/8" drywall
- Rough opening: 8-1/4" W x 5-5/8" H x 3-1/2" D
- Faceplate dimension: 10-7/8" W x 8-3/8" H
- Available with Quarter-turn ball valves or domestic valves
- Reversible right or left and center drain option
- 2" PVC, ABS or Slipnut Drain Kit included (2" male adapter or pipe nipple not included in Slipnut Kit)
- Unassembled

LISTINGS	PRODUCT	DESCRIPTION	MODEL	UNITS/CASE
	Standard Packs			
	82112	Qtr-turn Valves, 1/2" Sweat Conx.,	MWB3	5
	82114	Qtr-turn Valves, 1/2" CPVC Conx.	MWB5	5
	82116	Single-lever Valve, 1/2" Sweat Conx.	MWB7	5
	82148	Qtr-turn Arrester Valves, 1/2" Sweat Conx.	MWB16	5
	82152	Qtr-turn Valves, 1/2" Sweat Conx., 2" PVC Drain	MWB17	5
	82153	Qtr-turn Valves, 1/2" Sweat Conx., 2" ABS Drain	MWB18	5
	82157	Single-lever Arrester Valve, 1/2" Sweat Conx.	MWB20	5
	90504	Replacement Faceplate for Model MWB ¹	90504	1



Slipnut Drain Kit unless otherwise noted

¹Faceplates are Category *

Reversible Drain White Powder-Coated Econo Metal Washing Machine Outlet Box (continued)

	82165	Reversible Qtr-turn Valves, 1/2" F1807 Conx., 2" ABS Drain Conx.	MWB25	5
	82184	Reversible Qtr-turn Valves, 1/2" F1960 Conx.	MWB23	5
	82314	Box w/o Valves, Slipnut Drain Kit	MWBRLV	5
	Contractor Packs			
	82113	Reversible Qtr-turn Valves, 1/2" Sweat Conx.	MWB4	5
	82115	Reversible Qtr-turn Valves, 1/2" CPVC Conx.	MWB6	5
	82117	Reversible Single-lever Valve, 1/2" Sweat Conx.	MWB8	5
90504	Replacement Faceplate for Model MWB ¹	90504	1	

Slipnut Drain Kit unless otherwise noted



82112

Center Drain White Powder-Coated Econo Metal Washing Machine Outlet Box

- 20-gauge box / 20-gauge faceplate
- White powder coat finish on cold rolled steel
- Lip guard on bottom to prevent overflow
- Extra deep faceplate accommodates up to 2 pieces of 5/8" drywall
- Rough opening: 8-1/4" W x 5-5/8" H x 3-1/2" D
- Faceplate dimension: 10-7/8" W x 8-3/8" H
- Available with Quarter-turn ball valves or domestic valves
- 2" Slipnut Drain Kit included (2" male adapter or pipe nipple not included in Slipnut Kit)
- Unassembled

LISTINGS	PRODUCT	DESCRIPTION	MODEL	UNITS/CASE
Standard Packs				
	82118	Qtr-turn Valves, 1/2" Sweat Conx.	MWB9	5
	82120	Qtr-turn Valves, 1/2" CPVC Conx.	MWB11	5
	Contractor Packs			
82119	Qtr-turn Valves, 1/2" Sweat Conx.	MWB10	5	
82121	Qtr-turn Valves, 1/2" CPVC Conx.	MWB12	5	
90504	Replacement Faceplate for Model MWB ¹	90504	1	



82118

Dual Control Single-Lever Washing Machine Outlet Box

- Hot and cold valves can be operated individually or together. Inserting pin through lever holes combines controls.
- Faceplate design allows flush installation and covers the entire box for a clean finish
- One-piece box design, no loose parts to assemble
- Solid, one-piece high-impact resin construction with raised drip guard contains and directs hose leaks down the drain
- Snap-on frame
- Oversized knockouts will not fall down drain

LISTINGS	PRODUCT	DESCRIPTION	MODEL	UNITS/CASE
	82472	Dual Handle Single-lever Valve Box, Installed, 1/2" Sweat Conx.	DLWB1	5
	89284	Replacement Faceplate for 82472 ¹	89284	1



82472

¹Faceplates are Category *

Center Drain White Powder-Coated Econo Metal Washing Machine Outlet Box



82122

- 20-gauge box / 20-gauge faceplate
- White powder coat on cold rolled steel finish
- Lip guard on bottom to prevent overflow
- Extra deep faceplate accommodates up to
- 2 pieces of 5/8" drywall
- Rough opening: 8-1/4" W x 5-5/8" H x 3-1/2" D
- Faceplate dimension: 10-7/8" W x 8-3/8" H
- Available with Quarter-turn ball valves or domestic valves
- 2" Slipnut Drain Kit included (2" male adapter or pipe nipple not included in Slipnut Kit)
- Assembled

LISTINGS	PRODUCT	DESCRIPTION	MODEL	UNITS/CASE
Standard Packs				
	82122	Qtr-turn Valves, 1/2" Sweat Conx.	MWB13	5
	82146	Qtr-turn Valves, 1/2" F1807 Conx.	MWB15	5
	82154	Qtr-turn Arrester Valves, 1/2" Sweat Conx.	MWB19	5
	86161	Qtr-turn Arrester Valves, 1/2" F1960 Conx.	MWB30	5
	85802	Qtr-turn Domestic Valves, 1/2" Sweat Conx.	MWB1D	5
	Top Mount			
	82161	Qtr-turn Valves, 1/2" Sweat Conx., 2" ABS Drain Kit	MWB21	5
	86162	Qtr-turn Arrester Valves, 1/2" Sweat Conx.	MWB26	5
	82162	Qtr-turn Valves, 1/2" F1960 Conx., 2" ABS Drain Kit	MWB22	5
	86163	Qtr-turn Arrester Valves, 1/2" CPVC Conx.	MWB27	5
	86164	Qtr-turn Arrester Valves, 1/2" F1807 Conx.	MWB28	5
	90504	Replacement Faceplate for Model MWB ¹	90504	1
<i>Slipnut Drain Kit unless otherwise noted</i>				



Stainless Steel Washing Machine Outlet Box



82170

- Box and faceplate made of 304 stainless steel
- Available with Quarter-turn valves or domestic valves
- Will not rust or corrode
- Rough opening: 8-1/4" W x 6-1/4" H x 3-1/2" D
- Faceplate dimension: 10-7/8" W x 8-3/8" H
- Center drain outlet w/ 2" slipnut to be used with
- 2" Slipnut Drain Kit included (2" male adapter or pipe nipple not included in Slipnut Kit)
- Assembled

LISTINGS	PRODUCT	DESCRIPTION	MODEL	UNITS/CASE
	82170	Qtr-turn Valves, 1/2" Sweat Conx.	SSWB1	5
	82171	Qtr-turn Domestic Valves, 1/2" Sweat Conx.	SSWB2	5
	82172	Qtr-turn Valves, 1/2" Sweat Conx., Top-mount	SSWB1TM	5
	82307	Qtr-turn Domestic Valves, 1/2" Sweat Conx., Top-mount	SSWB2TM	5
	82327	Qtr-turn Arrester Valves, 1/2" Sweat Conx.	SSWB3	5
	82174	Drain Outlet Box, no valves	SSDB1	5
	97116	Replacement Faceplate for Model SSWB, SSIB & SSDB Stainless Steel ¹	97116	1
<i>Slipnut Drain Kit unless otherwise noted</i>				



¹Faceplates are Category *

Lead-Free Galvanized Ice Maker Outlet Box

- Valves are IAPMO listed to ASME A112.18.1 / CSA B125.1 and are NSF 61/NSF 372 compliant to lead leaching
- Valves feature white handle and stamping
- Rough Opening: 10" W x 8-3/4" H x 3-1/2" D
- Faceplate dimension: 11-5/8" W x 9-1/2" H
- Unassembled

LISTINGS	PRODUCT	DESCRIPTION	MODEL	UNITS/CASE
	88510	Qtr-turn Valve, 1/2" Sweat Conx.	BIM875QTSAB	6
	88158	Qtr-turn Domestic Valve, 1/2" Sweat Conx.	BIM875AB	6
	88512	Qtr-turn Valve, 1/2" CPVC Conx.	BIM876QTCAB	6
	88514	Qtr-turn Valve, 1/2" F1807 Conx.	BIM877QTPAB	6
	88517	Qtr-turn Arrester Valve, 1/2" F1960 Conx.	BIM878QTWAB	6
	81959	Galvanized Ice Maker Box, less valves	BIM875LV	6
	97091	Replacement Faceplate for Models B, BB, WB, FB, & BIM; 20 Ga. Galvanized ¹	B	1



88510

Lead-Free Metal Powder-Coated Ice Maker Outlet Box

- Valves are IAPMO listed to ASME A112.18.1 / CSA B125.1 and are NSF 61/NSF 372 compliant to lead leaching
- Valves feature white handle and stamping
- Rough opening: 4-1/8" W x 4-3/4" H x 2" D
- Faceplate dimension: 7" W x 7" H
- Assembled

LISTINGS	PRODUCT	DESCRIPTION	MODEL	UNITS/CASE
	88133	Qtr-turn Valve, 1/2" Sweat Conx, White	MIB1AB	5
	88530	Qtr-turn Domestic Valve Installed, 1/2" Sweat Conx.	MIB1DAB	5
	88534	Qtr-turn Valve Installed, 1/2" Sweat Conx., Cont. Pack	MIB4AB	10
	88532	Qtr-turn Valve Installed, 1/2" CPVC Conx.	MIB2AB	5
	88178	Qtr-turn Valve, 1/2" F1807 Conx., White	MIB3AB	5
	88535	Qtr-turn Valve, 1/2" F1960 Conx.	MIB5AB	5
	90254	Replacement Faceplate Metal IMOB (7" x 7") 20 Ga. Steel ¹	7063	1



88133

¹ Faceplates are Category *

Lead-Free Metal Powder-Coated Ice Maker Outlet Box with Hammer Arrestor Valve



88531

- Valves are IAPMO listed to ASME A112.18.1 / CSA B125.1 and are NSF 61/NSF 372 compliant to lead leaching
- Valves feature white handle and stamping
- Rough opening: 4-1/8" W x 4-3/4" H x 2" D
- Faceplate dimension: 7" W x 7" H
- Assembled

LISTINGS	PRODUCT	DESCRIPTION	MODEL	UNITS/CASE
	88531	Qtr-turn Arrestor Valve, 1/2" Sweat Conx.	MIB1HAAB	5
UPC	88533	Qtr-turn Arrestor Valve, 1/2" CPVC Conx.	MIB2HAAB	5
	88513	Qtr-turn Arrestor Valve, 1/2" F1807 Conx.	MIB3HAAB	5
	88515	Qtr-turn Arrestor Valve, 1/2" F1960 Conx.	MIB4HAAB	5
	90254	Replacement Faceplate Metal IMOB (7" x 7") 20 Ga. Steel ¹	7063	1

Lead-Free Metal Powder-Coated Commercial Ice Maker Outlet Box with Drain



88436

- Ideal for commercial coffee maker, dishwasher, or ice maker applications
- Valve contains 3/8" compression outlet
- Valve can be installed in multiple configurations
- 3/8" brass plated, Qtr-turn hammer arrestor valve meeting Lead Free requirements NSF61 NSF/ANSI 372
- Slipnut Drain Included (2" male adapter or pipe nipple not included in Slipnut Kit)
- Valve complies with ASSE 1010
- Valves are IAPMO listed to ASME A112.18.1 / CSA B125.1 and are NSF 61/NSF 372 compliant to lead leaching

LISTINGS	PRODUCT	DESCRIPTION	MODEL	UNITS/CASE
UPC	88436	Brass Qtr-turn Arrestor Valve, Installed, 2" Slipnut Drain, 1/2" Sweat Conx., 3/8" Compression Outlet	RMDW1AB	5
	90504	Replacement Faceplate for Model MWB ¹	90504	1

Lead-Free Stainless Steel Ice Maker Outlet Box



88164

- Valves are IAPMO listed to ASME A112.18.1 / CSA B125.1 and are NSF 61/NSF 372 compliant to lead leaching
- Valves feature white handle and stamping
- Rough Opening: 10" W x 8-3/4" H x 3-1/2" D
- Faceplate dimension: 10-7/8" W x 8-3/8" H
- Assembled

LISTINGS	PRODUCT	DESCRIPTION	MODEL	UNITS/CASE
UPC	88164	Qtr-turn Valve, 1/2" Sweat Conx.	SSIB1AB	5
	88177	Qtr-turn Domestic Valve, 1/2" Sweat Conx.	SSIB2AB	5
	97116	Replacement Faceplate for Model SSWB, SSIB & SSDB Stainless Steel ¹	97116	5

¹Faceplates are Category *

Lead-Free Mini Stainless Steel Ice Maker Outlet Box

- Valves are IAPMO listed to ASME A112.18.1 / CSA B125.1 and are NSF 61/NSF 372 compliant to lead leaching
- Small, compact design
- 20 Gauge Box / 20 Gauge Faceplate
- Rough opening: 4-1/8" W x 4-3/4" H x 2" D
- Faceplate dimensions: 7" W x 7" H

LISTINGS	PRODUCT	DESCRIPTION	MODEL	UNITS/CASE
	88521	Qtr-turn Valve, 1/2" Sweat Conx.	SSMIB1AB	5
	88522	Qtr-turn Valve, 1/2" CPVC Conx.	SSMIB2AB	5
	88523	Qtr-turn Valve, 1/2" F1807 Conx.	SSMIB3AB	5
	88524	Qtr-turn Valve, 1/2" F1960 Conx.	SSMIB5AB	5
	97151	Replacement Faceplate for Model SSMIB ¹	97151	1



88521

Lead-Free Mini Stainless Steel Ice Maker Outlet Box with Hammer Arrester Valve

- Valves are IAPMO listed to ASME A112.18.1 / CSA B125.1 and are NSF 61/NSF 372 compliant to lead leaching
- Small, compact design
- 20 Gauge Box / 20 Gauge Faceplate
- Rough opening: 4-1/8" W x 4-3/4" H x 2" D
- Faceplate dimensions: 7" W x 7" H
- Valve complies with ASSE 1010

LISTINGS	PRODUCT	DESCRIPTION	MODEL	UNITS/CASE
	88525	Qtr-turn Arrester Valve, 1/2" Sweat Conx.	SSMIB6AB	5
	88526	Qtr-turn Arrester Valve, 1/2" CPVC Conx.	SSMIB7AB	5
	88527	Qtr-turn Arrester Valve, 1/2" F1807 Conx.	SSMIB8AB	5
	88528	Qtr-turn Arrester Valve, 1/2" F1960 Conx.	SSMIB9AB	5
	97151	Replacement Faceplate for Model SSMIB ¹	97151	1



88525

Lead-Free Stainless Steel Dishwasher Outlet Box

- Valves are IAPMO listed to ASME A112.18.1 / CSA B125.1 and are NSF 61/NSF 372 compliant to lead leaching
- Valves feature white handle and stamping
- Rough Opening: 10" W x 8-3/4" H x 3-1/2" D
- Faceplate dimension: 10-7/8" W x 8-3/8" H
- 3/8" Compression Outlet
- Assembled

LISTINGS	PRODUCT	DESCRIPTION	MODEL	UNITS/CASE
	82681	Qtr-turn Valve, 1/2" Sweat Conx.	SSDW1AB	5
	97151	Replacement Faceplate for Model SSMIB ¹	97151	1



82681

¹ Faceplates are Category *

FR-12 Metal Washing Machine Outlet Box with Quarter-Turn Valves



82567

- Manufactured from heavy duty steel with a white powder-coated finish
- 2 intumescent pads attached to inside and back of outlet box
- Simple installation – just nail or screw to stud
- No loose pieces to assemble allows quick installation
- ETL Listed
- Rough opening: 5-3/8" W x 5-7/8" H x 3-1/8" D
- Faceplate dimension: 8-1/2" W x 8-1/2" H
- 1hr & 2hr rated
- Drain is a metallic 2" male threaded pipe connection
- Available in Quarter-turn, domestic and single-lever valve; with and without hammer arresters installed

LISTINGS	PRODUCT	DESCRIPTION	MODEL	UNITS/CASE
	82567	Qtr-turn Valve, 1/2" Sweat Conx.	FRM12S	22
UPC	82569	Qtr-turn Valve, 1/2" CPVC Conx.	FRM12C	22
	82571	Qtr-turn Valve, 1/2" F1807 Conx.	FRM12P	20
	82573	Qtr-turn Valve, 1/2" F1960 Conx.	FRM12W	23
	97983	Replacement Faceplate for Model FR, Metal ¹	97983	1

FR-12 Metal Washing Machine Outlet Box with Single-Lever Valve



82575

- Manufactured from heavy duty steel with a white powder-coated finish
- 2 intumescent pads attached to inside and back of outlet box
- Simple installation – just nail or screw to stud
- No loose pieces to assemble allows quick installation
- ETL Listed
- Rough opening: 5-3/8" W x 5-7/8" H x 3-1/8" D
- Faceplate dimension: 8-1/2" W x 8-1/2" H
- 1 and 2 HR rating—see design specification for exact rating
- Drain is a metallic 2" male threaded pipe connection
- Available in quarter-turn, domestic and single-lever valve; with and without hammer arresters installed

LISTINGS	PRODUCT	DESCRIPTION	MODEL	UNITS/CASE
	82575	Single-lever Valve, 1/2" Sweat Conx.	FRM12SS	5
UPC	82577	Single-lever Valve, 1/2" CPVC Conx.	FRM12CS	5
	82579	Single-lever Valve, 1/2" F1807 Conx.	FRM12PS	5
	82581	Single-lever Valve, 1/2" F1960 Conx.	FRM12WS	5
	97983	Replacement Faceplate for Model FR, Metal ¹	97983	1

¹Faceplates are Category *

FR-12 Metal Washing Machine Outlet Box with Quarter-Turn Hammer Arrester Valves

- Manufactured from heavy duty steel with a white powder-coated finish
- 2 intumescent pads attached to inside and back of outlet box
- Simple installation – just nail or screw to stud
- No loose pieces to assemble allows quick installation
- Rough opening: 5-3/8" W x 5-7/8" H x 3-1/8" D
- Faceplate dimension: 8-1/2" W x 8-1/2" H
- ETL Listed
- 1 and 2 HR rating—see design specification for exact rating
- Drain is a metallic 2" male threaded pipe connection
- Available in quarter-turn, domestic and single-lever valve; with and without hammer arresters installed



LISTINGS	PRODUCT	DESCRIPTION	MODEL	UNITS/CASE
	82583	Qtr-turn Arrester Valve, 1/2" Sweat Conx.	FRM12SHA	5
	82585	Qtr-turn Arrester Valve, 1/2" CPVC Conx.	FRM12CHA	5
	82587	Qtr-turn Arrester Valve, 1/2" F1807 Conx.	FRM12PHA	5
	82589	Qtr-turn Arrester Valve, 1/2" F1960 Conx.	FRM12WHA	5
	97983	Replacement Faceplate for Model FR, Metal ¹	97983	1

FR-12 Metal Washing Machine Outlet Box with Single-Lever Hammer Arrester Valve

- Manufactured from heavy duty steel with a white powder-coated finish
- 2 intumescent pads attached to inside and back of outlet box
- Simple installation – just nail or screw to stud
- No loose pieces to assemble allows quick installation
- Rough opening: 5-3/8" W x 5-7/8" H x 3-1/8" D
- Faceplate dimension: 8-1/2" W x 8-1/2" H
- ETL Listed
- 1 and 2 HR rating—see design specification for exact rating
- Drain is a metallic 2" male threaded pipe connection
- Available in quarter-turn, domestic and single-lever valve; with and without hammer arresters installed



LISTINGS	PRODUCT	DESCRIPTION	MODEL	UNITS/CASE
	82591	Single-lever Arrester Valve, 1/2" Sweat Conx.	FRM12SSHA	5
	82593	Single-lever Arrester Valve, 1/2" F1807 Conx.	FRM12PSHA	5
	97983	Replacement Faceplate for Model FR, Metal ¹	97983	1

¹ Faceplates are Category *

Weld-On®
Guy Gray®
Water-Tite®
ToughPans®
RTB
Test-Tite®
AB&A®
Studor®
Truebro®
Christy's®
FloodStop®
ProVent®
ProSet®

FR-12 Plastic Washing Machine Outlet Box with Quarter-Turn Valves



82357

- Intumescent pad attached to back of outlet box
- Molded-in test cap for testing of DWV drain system – test cap will not fall down the drain
- Snap-on frame accommodates up to 1" drywall and is interchangeable with all FR Fire-rated plastic outlet boxes
- Simple installation – just nail or screw to stud
- Preloaded nails for right or left stud bay installation
- Rough opening: 6" W x 6" H x 3-1/8" D
- Faceplate dimension: 8-5/16" W x 7-7/8" H
- One faceplate fits washer, ice maker, gas, AAV and auxiliary drain outlet boxes
- ETL Listed
- 1hr & 2hr rated
- Made of high-temperature resin
- No special wrapping or sheet rock fabrication needed

LISTINGS	PRODUCT	DESCRIPTION	MODEL	UNITS/CASE
Standard Packs				
	82355	Qtr-turn Valve, 1/2" Sweat Conx.	FR12S	5
	82357	Qtr-turn Valve, 1/2" CPVC Conx.	FR12C	5
	82359	Qtr-turn Valve, 1/2" F1807 Conx.	FR12P	5
	82361	Qtr-turn Valve, 1/2" F1960 Conx.	FR12W	5
	Contractor Packs			
	82356	Qtr-turn Valve, 1/2" Sweat Conx.	FR12SCP	10
	82358	Qtr-turn Valve, 1/2" CPVC Conx.	FR12CCP	10
	82360	Qtr-turn Valve, 1/2" F1807 Conx.	FR12PCP	10
	82362	Qtr-turn Valve, 1/2" F1960 Conx.	FR12WCP	10
	83370	Qtr-turn Valves, 1/2" REHAU EVERLOC+™	FR12RCP	10
	89282	Replacement Faceplate for Model FR, Plastic ¹	FR7070	1



¹Faceplates are Category *

FR-12 Plastic Washing Machine Outlet Box with Single-Lever Valve

- Intumescent pad attached to back of outlet box
- Molded-in test cap for testing of DWV drain system – test cap will not fall down the drain
- Snap-on frame accommodates up to 1" drywall and is interchangeable with all FR Fire-rated plastic outlet boxes
- Simple installation – just nail or screw to stud
- Preloaded nails for right or left stud bay installation
- Rough opening: 6" W x 6" H x 3-1/8" D
- Faceplate dimension: 8-5/16" W x 7-7/8" H
- One faceplate fits washer, ice maker, gas, AAV and auxiliary drain outlet boxes
- ETL Listed
- 1hr & 2hr rated
- Made of high-temperature resin
- No special wrapping or sheet rock fabrication needed



82363

LISTINGS	PRODUCT	DESCRIPTION	MODEL	UNITS/CASE
	Standard Packs			
	82363	Single-lever Valve, 1/2" Sweat Conx.	FR12SS	5
	82365	Single-lever Valve, 1/2" CPVC Conx.	FR12CS	5
	82367	Single-lever Valve, 1/2" F1807 Conx.	FR12PS	5
	82369	Single-lever Valve, 1/2" F1960 Conx.	FR12WS	5
	Contractor Packs			
	82364	Single-lever Valve, 1/2" Sweat Conx.	FR12SSCP	10
	82366	Single-lever Valve, 1/2" CPVC Conx.	FR12CSCP	10
	82368	Single-lever Valve, 1/2" F1807 Conx.	FR12PSCP	10
	82370	Single-lever Valve, 1/2" F1960 Conx.	FR12WSCP	10
	89282	Replacement Faceplate for Model FR, Plastic ¹	FR7070	1



¹Faceplates are Category *

Weld-On®
Guy Gray®
Water-Tite®
ToughPans®
RTB
Test-Tite®
AB&A®
Studor®
Truebro®
Christy's®
FloodStop®
ProVent®
ProSet®

FR-12 Plastic Washing Machine Outlet Box with Quarter-Turn Hammer Arrester Valves



82375

- Intumescent pad attached to back of outlet box
- Molded-in test cap for testing of DWV drain system – test cap will not fall down the drain
- Snap-on frame accommodates up to 1" drywall and is interchangeable with all FR Fire-rated plastic outlet boxes
- Simple installation – just nail or screw to stud
- Preloaded nails for right or left stud bay installation
- Rough opening: 6" W x 6" H x 3-1/8" D
- Faceplate dimension: 8-5/16" W x 7-7/8" H
- One faceplate fits washer, ice maker, gas, AAV and auxiliary drain outlet boxes
- ETL Listed
- 1hr & 2hr rated
- Made of high temperature resin
- No special wrapping or sheet rock fabrication needed

LISTINGS	PRODUCT	DESCRIPTION	MODEL	UNITS/CASE
Standard Packs				
82371	Qtr-turn Arrester Valve, 1/2" Sweat Conx.		FR12SHA	5
82373	Qtr-turn Arrester Valve, 1/2" CPVC Conx.		FR12CHA	5
82375	Qtr-turn Arrester Valve, 1/2" F1807 Conx.		FR12PHA	5
82377	Qtr-turn Arrester Valve, 1/2" F1960 Conx.		FR12WHA	5
Contractor Packs				
82372	Qtr-turn Arrester Valve, 1/2" Sweat Conx.		FR12SHACP	10
82374	Qtr-turn Arrester Valve, 1/2" CPVC Conx.		FR12CHACP	10
82376	Qtr-turn Arrester Valve, 1/2" F1807 Conx.		FR12PHACP	10
82378	Qtr-turn Arrester Valve, 1/2" F1960 Conx.		FR12WHACP	10
83371	Qtr-turn Arrester Valves, 1/2" REHAU EVERLOC+™		FR12RHACP	10
89282	Replacement Faceplate for Model FR, Plastic ¹		FR7070	1



¹Faceplates are Category *

FR-12 Plastic Washing Machine Outlet Box with Single-Lever Hammer Arrester Valves

- Intumescent pad attached to back of outlet box
- Molded-in test cap for testing of DWV drain system – test cap will not fall down the drain
- Snap-on frame accommodates up to 1" drywall and is interchangeable with all FR Fire-rated plastic outlet boxes
- Simple installation – just nail or screw to stud
- Preloaded nails for right or left stud bay installation
- Rough opening: 6" W x 6" H x 3-1/8" D
- Faceplate dimension: 8-5/16" W x 7-7/8" H
- One faceplate fits washer, ice maker, gas, AAV and auxiliary drain outlet boxes
- ETL Listed
- 1hr & 2hr rated
- Made of high temperature resin
- No special wrapping or sheet rock fabrication needed



82379

LISTINGS	PRODUCT	DESCRIPTION	MODEL	UNITS/CASE
	Standard Packs			
	82379	Single-lever Arrester Valve, 1/2" Sweat Conx.	FR12SSHA	5
	82381	Single-lever Arrester Valve, 1/2" F1807 Conx.	FR12PSHA	5
	Contractor Packs			
	82380	Single-lever Arrester Valve, 1/2" Sweat Conx.	FR12SSHACP	5
	82382	Single-lever Arrester Valve, 1/2" F1807 Conx.	FR12PSHACP	5
	89282	Replacement Faceplate for Model FR, Plastic ¹	FR7070	1

FR-12 Plastic Washing Machine Outlet Box with Domestic Valves

- Intumescent pad attached to back of outlet box
- Molded-in test cap for testing of DWV drain system – test cap will not fall down the drain
- Snap-on frame accommodates up to 1" drywall and is interchangeable with all FR Fire-rated plastic outlet boxes
- Simple installation – just nail or screw to stud
- Preloaded nails for right or left stud bay installation
- Rough opening: 6" W x 6" H x 3-1/8" D
- Faceplate dimension: 8-5/16" W x 7-7/8" H
- One faceplate fits washer, ice maker, gas, AAV and auxiliary drain outlet boxes
- ETL Listed
- 1hr & 2hr rated
- Made of high temperature resin
- No special wrapping or sheet rock fabrication needed



82383

LISTINGS	PRODUCT	DESCRIPTION	MODEL	UNITS/CASE
	Standard Packs			
	82383	Qtr-turn Domestic Valve, 1/2" Sweat Conx.	FR12DS	5
	Contractor Packs			
	82384	Qtr-turn Domestic Valve, 1/2" Sweat Conx.	FR12DSCP	10
	89282	Replacement Faceplate for Model FR, Plastic ¹	FR7070	1

¹ Faceplates are Category *

FR-12 Metal Ice Maker Outlet Box with Domestic Valve

82373

- Valves are IAPMO listed to ASME A112.18.1 / CSA B125.1 and are NSF 61/NSF 372 compliant to lead leaching
- Manufactured from heavy duty steel with a white powdercoated finish
- 2 intumescent pads attached to inside and back of outlet box
- Simple installation – just nail or screw to stud
- No loose pieces to assemble allows quick installation
- Rough opening: 5-3/8" W x 5-7/8" H x 2-1/4" D
- Faceplate dimension: 8-1/2" W x 8-1/2" H
- ETL Listed
- 1hr & 2hr rated – See design specification for exact rating
- Available in Quarter-turn and domestic valves; with and without hammer arresters installed

LISTINGS	PRODUCT	DESCRIPTION	MODEL	UNITS/CASE
	82399	Qtr-turn Valve, 1/2" Sweat Conx.	FRMIB12ABDS	5
	97983	Replacement Faceplate for Model FR, Metal ¹	97983	5

FR-12 Metal Ice Maker Outlet Box

82393

- Valves are IAPMO listed to ASME A112.18.1 / CSA B125.1 and are NSF 61/NSF 372 compliant to lead leaching
- Valves feature white handle and stamping
- Manufactured from heavy duty steel with a white powder-coated finish
- 2 intumescent pads attached to inside and back of outlet box
- Simple installation – just nail or screw to stud
- No loose pieces to assemble allows quick installation
- Rough opening: 5-3/8" W x 5-7/8" H x 2-1/4" D
- Faceplate dimension: 8-1/2" W x 8-1/2" H
- ETL Listed
- 1hr & 2hr rated – see design specification for exact rating
- Available in Quarter-turn and domestic valves; with and without hammer arresters installed

LISTINGS	PRODUCT	DESCRIPTION	MODEL	UNITS/CASE
	82390	Qtr-turn Valve, 1/2" Sweat Conx.	FRMIB12ABS	5
	82393	Qtr-turn Valve, 1/2" CPVC Conx.	FRMIB12ABC	5
	82395	Qtr-turn Valve, 1/2" F1807 Conx.	FRMIB12ABP	5
	82397	Qtr-turn Valve, 1/2" F1960 Conx.	FRMIB12ABW	5
	97983	Replacement Faceplate for Model FR, Metal ¹	97983	1

FR-12 Metal Ice Maker Outlet Box with Hammer Arrester Valves

82392

- Valves are IAPMO listed to ASME A112.18.1 / CSA B125.1 and are NSF 61/NSF 372 compliant to lead leaching
- Valves feature white handle and stamping
- Manufactured from heavy duty steel with a white powder-coated finish
- 2 intumescent pads attached to inside and back of outlet box
- Simple installation – just nail or screw to stud
- No loose pieces to assemble allows quick installation
- Rough opening: 5-3/8" W x 5-7/8" H x 2-1/4" D
- Faceplate dimension: 8-1/2" W x 8-1/2" H
- ETL Listed
- 1hr & 2hr rated – see design specification for exact rating
- Available in Quarter-turn and domestic valves; with and without hammer arresters installed

LISTINGS	PRODUCT	DESCRIPTION	MODEL	UNITS/CASE
	82392	Qtr-turn Arrester Valve, 1/2" Sweat Conx.	FRMIB12ABSHA	5
	82394	Qtr-turn Arrester Valve, 1/2" CPVC Conx.	FRMIB12ABCHA	5
	82396	Qtr-turn Arrester Valve, 1/2" F1807 Conx.	FRMIB12ABPHA	5
	82398	Qtr-turn Arrester Valve, 1/2" F1960 Conx.	FRMIB12ABWHA	5
	97983	Replacement Faceplate for Model FR, Metal ¹	97983	1

¹Faceplates are Category *

FR-12 Plastic Lead-Free Ice Maker Outlet Boxes with Quarter-turn Valves

- Valves are IAPMO listed to ASME A112.18.1 / CSA B125.1 and are NSF 61/NSF 372 compliant to lead leaching
- Valves feature white handle and stamping
- Intumescent pad attached to back of outlet box
- Snap-on frame accommodates up to 1" drywall and is interchangeable with all FR-12 Fire-rated plastic outlet boxes
- Simple installation – just nail or screw to stud
- One faceplate fits washer, ice maker, gas, AAV and auxiliary drain outlet boxes
- Rough opening: 6" W x 6" H x 3-1/8" D
- Faceplate dimension: 8-5/16" W x 7-7/8" H
- Preloaded nails for right or left stud bay installation
- ETL Listed
- 1hr & 2hr rated
- Made of high temperature resin
- No special wrapping or sheet rock fabrication needed



82408

LISTINGS	PRODUCT	DESCRIPTION	MODEL	UNITS/CASE
Standard Packs				
	82408	Qtr-turn Valve, 1/2" Sweat Conx.	FRIB12ABS	5
	82411	Qtr-turn Valve, 1/2" CPVC Conx.	FRIB12ABC	5
	82413	Qtr-turn Valve, 1/2" F1807 Conx.	FRIB12ABP	5
	82415	Qtr-turn Valve, 1/2" F1960 Conx.	FRIB12ABW	5
	Contractor Packs			
	82409	Qtr-turn Valve, 1/2" Sweat Conx.	FRIB12ABSCP	10
	82412	Qtr-turn Valve, 1/2" CPVC Conx.	FRIB12ABCCP	10
	82414	Qtr-turn Valve, 1/2" F1807 Conx.	FRIB12ABPCP	10
	82416	Qtr-turn Valve, 1/2" F1960 Conx.	FRIB12ABWCP	10
	83374	Qtr-turn Valve, 1/2" REHAU EVERLOC+™	FRIB12ABRCP	10
	89282	Replacement Faceplate for Model FR, Plastic ¹	FR7070	1

FR-12 Plastic Lead-Free Ice Maker Outlet Boxes

- Valves are IAPMO listed to ASME A112.18.1 / CSA B125.1 and are NSF 61/NSF 372 compliant to lead leaching
- Valves feature white handle and stamping
- Intumescent pad attached to back of outlet box
- Snap-on frame accommodates up to 1" drywall and is interchangeable with all FR series boxes
- Simple installation – just nail or screw to stud
- Preloaded nails for right or left stud bay installation
- Rough opening: 6" W x 6" H x 3-1/8" D
- Faceplate dimension: 8-5/16" W x 7-7/8" H
- One faceplate fits washer, ice maker, gas, AAV and auxiliary drain outlet boxes
- ETL Listed
- 1hr & 2hr rated
- Made of high temperature resin
- No special wrapping or sheet rock fabrication needed



82389

LISTINGS	PRODUCT	DESCRIPTION	MODEL	UNITS/CASE
	82389	Quarter-turn Domestic Valve, 1/2" Conx.	FRIB12ABDS	5
	97983	Replacement Faceplate for Model FR, Metal ¹	97983	5

¹Faceplates are Category *

Weld-On®
Guy Gray®
Water-Tite®
ToughPans®
RTB
Test-Tite®
AB&A®
Studor®
Truebro®
Christy's®
FloodStop®
ProVent®
ProSet®

FR-12 Plastic Lead-Free Ice Maker Outlet Box with Hammer Arrestor Valve



82417

- Valves are IAPMO listed to ASME A112.18.1 / CSA B125.1 and are NSF 61/NSF 372 compliant to lead leaching
- Valves feature white handle and stamping
- Intumescent pad attached to back of outlet box
- Snap-on frame accommodates up to 1" drywall and is interchangeable with all FR-12 Fire-rated plastic outlet boxes
- Simple installation – just nail or screw to stud
- One faceplate fits washer, ice maker, gas, AAV and auxiliary drain outlet boxes
- Rough opening: 6" W x 6" H x 3-1/8" D
- Faceplate dimension: 8-5/16" W x 7-7/8" H
- Preloaded nails for right or left stud bay installation
- ETL Listed
- 1hr & 2hr rated
- Made of high temperature resin
- No special wrapping or sheet rock fabrication needed

LISTINGS	PRODUCT	DESCRIPTION	MODEL	UNITS/CASE
Standard Packs				
82417	Qtr-turn Arrestor Valve, 1/2" Sweat Conx.		FRIB12ABSHA	5
82419	Qtr-turn Arrestor Valve, 1/2" CPVC Conx.		FRIB12ABCHA	5
82421	Qtr-turn Arrestor Valve, 1/2" F1807 Conx.		FRIB12ABPHA	5
82423	Qtr-turn Arrestor Valve, 1/2" F1960 Conx.		FRIB12ABWHA	5
Contractor Packs				
82418	Qtr-turn Arrestor Valve, 1/2" Sweat Conx.		FRIB12ABSHACP	10
82420	Qtr-turn Arrestor Valve, 1/2" CPVC Conx.		FRIB12ABCHACP	10
82422	Qtr-turn Arrestor Valve, 1/2" F1807 Conx.		FRIB12ABPHACP	10
82424	Qtr-turn Arrestor Valve, 1/2" F1960 Conx.		FRIB12ABWHACP	10
83375	Qtr-turn Arrestor Valves, 1/2" REHAU EVERLOC+™		FRIB12ABRHACP	10
89282	Replacement Faceplate for Model FR, Plastic ¹		FR7070	1



¹Faceplates are Category *

FR-12 Plastic Gas Outlet Boxes

- Intumescent pad attached to back of outlet box
- Snap-on frame accommodates up to 1" drywall and is interchangeable with all FR-12 Fire-rated plastic outlet boxes
- Simple installation – just nail or screw to stud
- Rough opening: 6" W x 6" H x 3-1/8" D
- Faceplate dimension: 8-5/16" W x 7-7/8" H
- Preloaded nails for right or left stud bay installation
- One faceplate fits washer, ice maker, gas, AAV and auxiliary drain outlet boxes
- ETL Listed
- Valves are CSA listed to ANSI Z21/CSA9.1
- 1hr & 2hr rated
- Made of high-temperature resin
- No special wrapping or sheet rock fabrication needed



82446

LISTINGS	PRODUCT	DESCRIPTION	MODEL	UNITS/CASE
	82446	Qtr-turn Gas Valve, 1/2" IPS Conx.	FRGB12IP	5
	82448	Qtr-turn 1/2" Female Gas Valve, for use on CSST	FRGB12CSST	5
	89282	Replacement Faceplate for Model FR, Plastic ¹	FR7070	1

FR-12 Plastic Air Admittance Valve Recess Outlet Box

- Simple installation – just nail or screw to stud
- Preloaded nails for right or left stud bay installation
- AAV not included
- Rough opening: 6" W x 6" H x 3" D
- Faceplate dimension: 9-1/2" W x 9-1/2" H
- ETL Listed
- 1hr & 2hr rated
- Made of high-temperature resin
- No special wrapping or sheet rock fabrication needed
- Replacement grill and screws available, product #48254



82456

LISTINGS	PRODUCT	DESCRIPTION	MODEL	UNITS/CASE
	82456	Air Admittance Valve Outlet Box, 1-1/2" female adaptor included	FRAAV12	5
	48254	9-1/2" x 9-1/2" Replacement Grill	48254	1



¹Faceplates are Category *

FR-12 Auxiliary Drain Outlet Box



82458

- Intumescent pad attached to back of outlet box
- Molded-in test cap for testing of DWV drain system – test cap will not fall down the drain
- Snap-on frame accommodates up to 1" drywall and is interchangeable with all FR-12 Fire-rated plastic outlet boxes
- Simple installation – just nail or screw to stud
- Condensate line not included
- Preloaded nails for right or left stud bay installation
- One faceplate fits plastic washer, ice maker, gas, AAV and auxiliary drain outlet boxes
- ETL Listed
- 1hr & 2hr rated
- Made of high-temperature resin
- No special wrapping or sheet rock fabrication needed
- Ideal for overhead auxiliary drain line discharge

LISTINGS	PRODUCT	DESCRIPTION	MODEL	UNITS/CASE
	82458	Fire-rated Auxiliary Drain Outlet Box	FRAD12	5
	89282	Replacement Faceplate for Model FR, Plastic ¹	FR7070	1

Stainless Steel Gas Outlet Boxes



87888

- Provides a recessed valve installation allowing appliances to be closer to wall
- Two valve options: 1/2" iron pipe & 3/4" iron pipe
- Valves are CSA listed to ANSI Z21/CSA9.1

LISTINGS	PRODUCT	DESCRIPTION	MODEL	UNITS/CASE
	87887	Qtr-turn Valve, 1/2" IP Conn., Stainless Steel Gas Box	SSGB12IP	5
	87888	Qtr-turn Valve, 3/4" IP Conn., Stainless Steel Gas Box	SSGB34IP	5
	87889	Qtr-turn Valve, 1/2" CSST Conn., Stainless Steel Gas Box	SSGB12CSST	5
	97116	Replacement Faceplate for Model SSWB, Stainless Steel ¹	97116	1

Metal Gas Outlet Box



88112

- 20-gauge box / 20-gauge faceplate
- Provides a recessed valve installation allowing appliances to be closer to the wall
- Rough opening: 4-1/8" W x 4-3/4" H x 2" D
- Faceplate dimension: 7" W x 7" H
- White powder coat on cold rolled steel finish
- Valves are CSA listed to ANSI Z21/CSA9.1
- Test plug provided for testing of valve assembly

LISTINGS	PRODUCT	DESCRIPTION	MODEL	UNITS/CASE
	88112	CSA Listed 1/2" IPS Gas Valve	MGB1	5
	90254	Replacement Faceplate for Metal IMOB (7" x 7") 20 Ga. Steel ¹	7063	1

¹Faceplates are Category *

Metal Dishwasher, Commercial Ice Maker, and Coffee Maker Outlet Boxes

- One box design with installed valve or arrester valve saves considerable installation time versus installing separate boxes or separate valves and Hammer Arresters
- Ideal for coffee kiosks, sink/faucet and toilet connections
- Rough opening: 4-1/8" W x 4-3/4" H x 2" D
- Faceplate dimension: 7" W x 7" H
- 3/8" Outlet – Quarter-turn valve with Hammer
- Arrester Installed
- Available with Sweat, CPVC and F1807 Qtr-turn connections; with or without Hammer Arresters



87944

LISTINGS	PRODUCT	DESCRIPTION	MODEL	UNITS/CASE
	87939	Qtr-turn Arrester Valve, 1/2" Sweat Conx., 3/8" Outlet	MDWB1AB	5
	87940	Qtr-turn Arrester Valve, 1/2" CPVC Conx., 3/8" Outlet	MDWB2AB	5
	87944	Qtr-turn Arrester Valve, 1/2" F1807 Conx., 3/8" Outlet	MDWB3AB	5
	87964	Qtr-turn Valve, 1/2" Sweat Conx., 3/8" Outlet	MDWB4AB	5
	87965	Qtr-turn Valve, 1/2" CPVC Conx., 3/8" Outlet	MDWB5AB	5
	87966	Qtr-turn Valve, 1/2" F1807 Conx., 3/8" Outlet	MDWB6AB	5
	90254	Replacement Faceplate for Metal IMOB (7" x 7") 20 Ga. Steel ¹	7063	1

Lead-Free Metal Powder-Coated Commercial Ice Maker/Dishwasher Outlet Box with Drain

- Ideal for commercial coffee maker, dishwasher, or ice maker applications
- Valve contains 3/8" compression outlet
- Valve can be installed in multiple configurations 3/8" brass plated, Qtr-turn hammer arrester valve meeting Lead-Free requirements NSF61-NSF/ANSI 372
- Slipnut Drain Included (2" male adapter or pipe nipple not included in Slipnut Kit)
- Valve complies with ASSE 1010
- Valves are IAPMO listed to ASME A112.18.1 / CSA B125.1 and are NSF 61/NSF 372 compliant to lead leaching



88436

LISTINGS	PRODUCT	DESCRIPTION	MODEL	UNITS/CASE
	88436	Brass Qtr-turn Arrester Valve, 2" Slipnut Drain, Installed, 1/2" Sweat Conx., 3/8" Compression Outlet	RMDW1AB	5
	90504	Replacement Faceplate for Model MWB ¹	90504	1

¹ Faceplates are Category *

Dialysis Supply and Waste Box



82643



82690

- Built from 316 stainless steel to prevent corrosion
- Access door may be positioned in any convenient orientation; includes concealed hinge and Cam Cylinder lock and two keys
- Stainless steel wall flange provides multiple, mounting options to cover space between wall and box; secure with Phillips head screws (supplied)
- Waste outlet can be directly connected to 2" nominal size glass or plastic drain with mechanical coupling
- Tapped holes on mounting plate allow for easy assembly of valves
- Unassembled
- Tailpiece waste connection is 2-3/8" OD stainless steel
- Interior seams are continuous welded with a bead blast finish to provide a water-tight seal and smooth finish
- Equipment drain tube support is located directly over the train to eliminate splatter and minimize clean up
- PVC valves are ball-style with EPDM seals and O-ring; 1/2" FPT Sch 80; flushing nipple is included
- Single or double valve capability for greater flexibility
- Large mounting flanges provide easy securement of box to wall, eliminating the need to build supports
- Valves comply with ASTM F1970-05
- 1/2" inlet and 3/4" hose bibb connection

LISTINGS	PRODUCT	DESCRIPTION	MODEL	UNITS/CASE
With PVC Valves				
	82643	One Valve, Less Door	DBSS1	4
	82644	One Valve, Locking Door	DBSS1D	4
	82645	Two Valves, Less Door	DBSS2	4
	82646	Two Valves, Locking Door	DBSS2D	4
With Stainless Steel Valves				
	82688	One Valve, Less Door	DBSS1SV	4
	82689	One Valve, Locking Door	DBSS1DSV	4
	82690	Two Valves, Less Door	DBSS2SV	4
	82691	Two Valves, Locking Door	DBSS2DSV	4
Accessories				
	82647	One Valve Hole, Less Valves, Locking Door	DBSS1DLV	4
	82648	Two Valve Holes, Less Valves, Locking Door	DBSS2DLV	4
	97208	Frame (Faceplate) for "no door" application ¹	97208	1
	97211	Frame (Faceplate) for "door" applications ¹	97211	1
	97212	Replacement Door, Lock & Key	97212	20



Dryerbox® Metal Dryer Boxes



82426

- Sturdy 22-gauge molded aluminized steel
- Locate the dryer against the wall
- Flex is protected from getting compressed, gain 5 feet of duct run
- Reduces fire hazard
- Lint buildup is minimized
- Meets code requirements as a clean-out
- Doubles as gas connection receptacle

PRODUCT	DESCRIPTION	MODEL	UNITS/CASE
82425	2x6 Upward Exhaust Outlet	DB425	5
82426	2x4 Upward Exhaust Outlet	DB350	6
82427	2x6 Downward Exhaust Outlet	DB4D	5
82428	2x4 Downward Exhaust Outlet	DB3D	6

¹Faceplates are Category *



Guy Gray® Faceplates and Accessories

- Strong, durable replacement faceplates
- Heavy-duty galvanized
- Wide frame allows for clean finish

PRODUCT	DESCRIPTION	MODEL	UNITS/CASE
Faceplates			
89284	Replacement Faceplate for Dual Control Box	89284	1
90254	Replacement Faceplate for MIB	7063	1
97091	Replacement Faceplate for Models B, BB, WB, FB, & BIM; 20 Ga. Galvanized	B	1
97092	Replacement Faceplate for Models BE, BBE, WBE, & FBE; 20 Ga. Galvanized	BE	1
97093	Replacement Faceplate for Models BED, BBED, WBED, & FBED; 20 Ga. Galvanized	BED	1
97094	Replacement Faceplate for Models NWBED, WNWBED, & NWFBED; 20 Ga. Galvanized	NWBED	1
97095	Replacement Faceplate for Model T150, T200; 20 Ga. White	T	1
90504	Replacement Faceplate for Model MWB	90504	1
89282	Replacement Faceplate for Model FR, Plastic	FR7070	1
97983	Replacement Faceplate for Model FR, Metal	97983	1
97116	Replacement Faceplate for Model SSWB, SSIB & SSDB Stainless Steel	97116	1
97151	Replacement Faceplate for SSMIB	97151	1
Accessories			
97031	7/8" Rubber Washer	903P	1
97032	3/4" and 1/2" Reducing Washers	RW1	1
97036	2" Rubber Gasket	L2411	1
97038	2" Chase Drain Nipple	CN200	1
97046	2" Flange Nut	5225	1
97034	2" Chrome-Plated Nut	5062	1
Tamper-Resistant Cover Plates			
96997	Tamper-resistant cover for Models B, BB, WB, FB & BIM	BTRC	6
96998	Tamper-resistant cover for Models BED, BBED, WBED, FBED, BBE, WBE & FBE	BEDTRC	6
96999	Tamper-resistant cover for Models NWBED, WNWBED, NWFBED; Furnished with tamper-resistant screws	NWBEDTRC	6
90355	Screwdriver for tamper-resistant covers	90355	1



90254



90504



96997

ProSet®

ProVent®

FloodStop®

Christy's®

Truebro®

Studor®

AB&A®

Test-Tite®

RTB

ToughPans®

Waater-Tite®

Guy Gray®

Weld-On®

WATER * TITE®

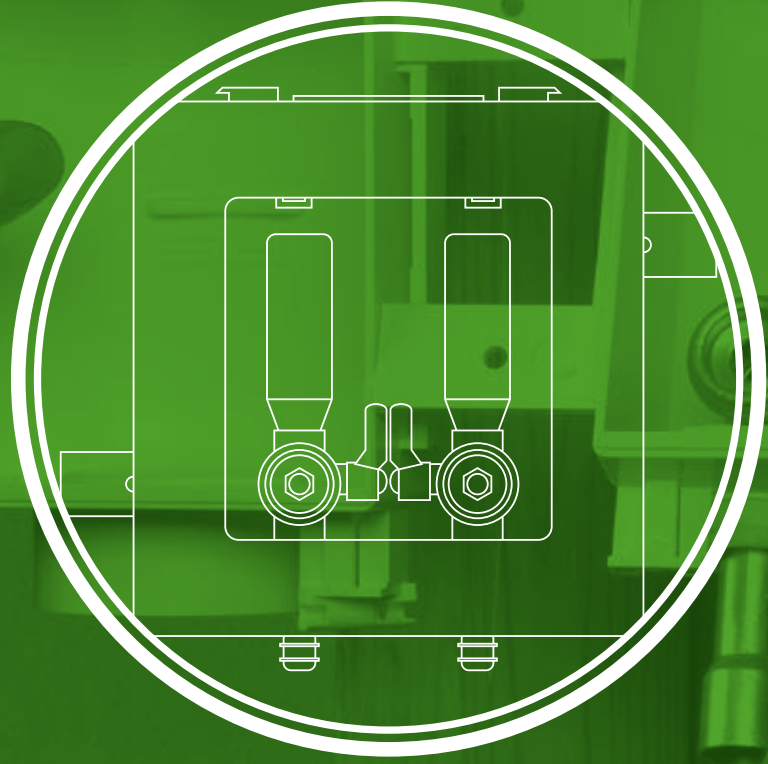

1969

Saving time and effort since 1969

The Water-Tite® Washing Machine Recessed Outlet Box – the industry's first plastic construction – standardized laundry connections in 1969. In 1978, Water-Tite®'s recessed Ice Maker Outlet Box allowed contractors to save more time in the kitchen too.



Today

More labor-saving specialty products than ever

For more than 40 years, Water-Tite® products have been helping plumbers reduce installation time while maintaining a high level of quality. Today, Water-Tite®'s line includes a wide range of innovative, labor-saving specialty plumbing products. From roof flashings to support systems and much more, Water-Tite® has the products that help plumbers work faster and smarter.



DESIGN OPTIONS GUIDE

Water-Tite® offers a comprehensive line of Washing Machine Outlet Boxes, Handles, and Valve Connections for your installation needs. All Water-Tite® and Guy Gray® valves comply with ASME A112.18.1. All integral hammer arrester valves also comply with ASSE 1010. See the following pages for additional details on all of the components.

Washing Machine Outlet Boxes



DU-All™ Dual-Drain Washing Machine Outlet Boxes



Econo Center Drain Washing Machine Outlet Boxes



Wide-mouth Washing Machine Outlet Boxes



MultiBox™ Washing Machine Outlet Boxes

Valve Types



Quarter-turn (Red or Blue)



MultiBox Quarter-turn (Left or Right)



Domestic



Quarter-turn Hammer Arrester (Red or Blue)



MultiBox Hammer Arrester (Left or Right)



Single-lever Hammer Arrester



Single-lever

Valve Connections



1/2" Copper Sweat



1/2" CPVC ASTM D2846



1/2" Crimp ASTM F1807



1/2" Cold Expansion ASTM F1960



Long Shank Extension



REHAU EVERLOC+™



F3347

DU-All™ Dual-Drain Washing Machine Outlet Boxes

- Back of box rests against the back sheetrock wall for sturdy installation. Flat box side for secure mounting to the stud
- Solid one-piece construction with raised drip guard contains and directs leaks down the drain
- Forward mounted valves give easy access for on/off operation
- Various valve-mounting options allow dual drain, right drain only or left drain only
- Can be inverted for top-mount and center drain option
- Second drain can be used to easily receive a Redi-Vent® AAV when valves are in forward configuration
- EZ Out Test Caps are raised for easy removal and KOs are oversized so they won't fall down drain
- Textured, snap-on frame with hot and cold supply designations embossed on front, accommodates up to 1" drywall for a clean finish
- DU-All™ and Center Drain Econo Box faceplates are interchangeable
- Rough opening: 8-1/4" W x 6-1/8" H x 3-3/4" D
- Faceplate dimension: 10-3/16" W x 8-13/16" H
- Extended mounting flange provided
- Faceplate unassembled in contractor packs



85131
Standard pack
(shown with faceplate)



85132
Contractor pack
(shown without faceplate)



82053
Top-mount Invert outlet box
for Top-mount option
(shown without faceplate)

LISTINGS	PRODUCT	DESCRIPTION	MODEL	UNITS/CASE
Standard Packs				
	82052	Brass Qtr-turn Valves, Installed, 1/2" Sweat Conx.	W2700	10
	82054	Brass Qtr-turn Valves, Installed, 1/2" CPVC Conx.	W2701	10
	82056	Brass Qtr-turn Valves, Installed, 1/2" F1807 Conx.	W2702	10
	85131	Brass Qtr-turn Valves, Installed, 3/8" F1807 Conx.	W2738	10
	82001	Brass Qtr-turn Valves, Installed, 1/2" F1960 Conx.	W2711	10
	82321	Brass Qtr-turn Valves, Installed, 1/2" F3347 Conx.	W2722	10
	82746	Brass Qtr-turn Valves, Installed, 1/2" REHAU EVERLOC+™	W2705	10
	85610	Domestic Adapter Valves, Installed, 1/2" Sweat Conx.	W2312D	10
	85630	Single-lever Valve, Installed, 1/2" Sweat Conx.	W2800	10
	85637	Single-lever Valve, Installed, 1/2" CPVC Conx.	W2801	10
	85682	Single-lever Valve, Installed, 1/2" F1807 Conx.	W2800X	10
	85741	Single-lever Valve, Installed, 1/2" F1960 Conx.	W2811	10
	85614	Brass Qtr-turn Valves, Unassembled, 1/2" Sweat Conx.	W2412	10
	82107	Brass Qtr-turn Valves, Unassembled, 1/2" CPVC Conx.	W2704	10
	82008	Brass Qtr-turn Valves, Unassembled, 1/2" F1960 Conx.	W2713	10
	85604	Washer Box Only – No Valves	W2012	10
	Contractor Packs			
	82053	Brass Qtr-turn Valves, Installed, 1/2" Sweat Conx.	W2700CP	20
	82055	Brass Qtr-turn Valves, Installed, 1/2" CPVC Conx.	W2701CP	20
	82057	Brass Qtr-turn Valves, Installed, 1/2" F1807 Conx.	W2702CP	20
	85132	Brass Qtr-turn Valves, Installed, 3/8" F1807 Conx.	W2738CP	20
	82002	Brass Qtr-turn Valves, Installed, 1/2" F1960 Conx.	W2711CP	20
	82322	Brass Qtr-turn Valves, Installed, 1/2" F3347 Conx.	W2722CP	20
	82747	Brass Qtr-turn Valves, Installed, 1/2" REHAU EVERLOC+™	W2705CP	20
	85632	Single-lever Valve, Installed, 1/2" Sweat Conx.	W2800CP	20
	85638	Single-lever Valve, Installed, 1/2" CPVC Conx.	W2801CP	20
	85742	Single-lever valve, Installed, 1/2" F1960	W2811CP	20
	Dual-Drain Display Packs			
	82013	Brass Qtr-turn Valves, Installed, 1/2" Sweat Conx.	R2512B	6
	82017	Single-lever Valve, Installed, 1/2" Sweat Conx.	R2800B	6
	82000	Washer Box Only – No Valves	R2012B	6
	89267	Replacement Faceplate ¹	W7070	1



¹Faceplates are Category *

DU-All™ Dual-Drain Washing Machine Outlet Boxes with Hammer Arrester Valves



85714
Standard pack
(shown with faceplate)



85704
Contractor pack
(shown without faceplate)



85704
Top-mount Invert outlet box
for Top-mount option.
(shown without faceplate)

- Patented one-piece design speeds installation versus separate drain and valve boxes – Patent # 4,934,410
- Back of box rests against the back sheetrock wall for sturdy installation
- Solid one-piece construction with raised drip guard contains and directs leaks down the drain
- Forward mounted valves give easy access to homeowners for on/off operation
- Various valve mounting options allow dual drain, right drain only or left drain only
- Can be inverted for top-mount and center drain option
- Flat box side for secure mounting to the stud
- EZ Out Test Caps are raised for easy removal and
- KOs are oversized so they won't fall down drain
- Textured, snap-on frame, with hot and cold supply designations embossed on front, accommodates up to 1" drywall for a clean finish
- DU-All™ and Center Drain Econo Box faceplates are interchangeable
- Rough opening: 8-1/4" W x 6-1/8"H x 3-3/4" D
- Faceplate dimension: 10-3/16" W x 8-13/16" H
- Extended mounting flange provided
- Faceplate unassembled in contractor packs

LISTINGS	PRODUCT	DESCRIPTION	MODEL	UNITS/CASE
Hammer Arrester Standard Packs				
85703	Brass Qtr-turn Arrester Valves, Installed, 1/2" Sweat Conx.		W2700HA	10
85706	Brass Qtr-turn Arrester Valves, Installed, 1/2" CPVC Conx.		W2701HA	10
85714	Brass Qtr-turn Arrester Valves, Installed, 1/2" F1807 Conx.		W2702HA	10
81998	Brass Qtr-turn Arrester Valves, Installed, 1/2" F1960 Conx.		W2711HA	10
82451	Brass Qtr-turn Arrester Valves, Installed, 1/2" F3347 Conx.		W2722HA	10
85701	Single-lever Arrester Valve, Installed, 1/2" Sweat Conx.		W2800HA	10
85717	Single-lever Arrester Valve, Installed, 1/2" CPVC Conx.		W2801HA	10
85719	Single-lever Arrester Valve, Installed, 1/2" F1807 Conx.		W2802HA	10
85748	Single-lever Arrester Valve, Installed, 1/2" F1960		W2811HA	10
82748	Single-lever Arrester Valve, Installed REHAU EVERLOC+™		W2705HA	10
Hammer Arrester Contractor Packs				
85704	Brass Qtr-turn Arrester Valves, Installed, 1/2" Sweat Conx.		W2700HACP	20
85707	Brass Qtr-turn Arrester Valves, Installed, 1/2" CPVC Conx.		W2701HACP	20
85723	Brass Qtr-turn Arrester Valves, Installed, 1/2" F1807 Conx.		W2702HACP	20
81999	Brass Qtr-turn Arrester Valves, Installed, 1/2" F1960 Conx.		W2711HACP	20
82453	Brass Qtr-turn Arrester Valves with 1/2" F3347 Conx.		W2722HACP	20
85702	Single-lever Arrester Valve, Installed, 1/2" Sweat Conx.		W2800HACP	20
85718	Single-lever Arrester Valve, Installed, 1/2" CPVC Conx.		W2801HACP	20
85749	Single-lever Arrester Valve, Installed, 1/2" F1960		W2811HACP	20
82749	Single-lever Arrester Valve, Installed REHAU EVERLOC+™		W2705HACP	20
89267	Replacement Faceplate ¹		W7070	1



¹Faceplates are Category *

Weld-On®
Guy Gray®
Water-Tite®
ToughPans®
RTB
Test-Tite®
AB&A®
Studor®
Truebro®
Christy's®
FloodStop®
ProVent®
ProSet®

DU-All™ 10 N 1® Dual-Drain Washing Machine Outlet Boxes

- Patented one-piece design speeds installation versus separate drain and valve boxes – Patent # 4,934,410
- Back of box rests against the back sheetrock wall for sturdy installation
- Solid one-piece construction with raised drip guard contains and directs leaks down the drain
- Various valve mounting options allow dual drain, right drain only, left drain only, bottom or top-mount
- Valves unassembled for contractor's mounting option
- Multiple drain options
- Flat box side for secure mounting to the stud
- EZ Out Test Caps are raised for easy removal and KOs are oversized so they won't fall down drain
- Textured, snap-on frame, with hot and cold supply designations embossed on the front, accommodates up to 1" drywall for a clean finish
- DU-All™ and Center Drain Econo Box faceplates are interchangeable
- Rough opening: 8-1/4" W x 6-1/8"H x 3-3/4" D
- Faceplate dimension: 10-3/16" W x 8-13/16" H
- Extended mounting flange provided
- Faceplate unassembled in contractor packs

LISTINGS	PRODUCT	DESCRIPTION	MODEL	UNITS/CASE
Standard Packs				
	85125	Brass Qtr-turn Valves, Uninstalled, 1/2" F1807 Conx.	W2122	10
	85614	Brass Qtr-turn Valves, Unassembled, 1/2" Sweat Conx.	W2412	10
	82107	Brass Qtr-turn Valves, Unassembled, 1/2" CPVC Conx.	W2704	10
	82008	Brass Qtr-turn Valves, Unassembled, 1/2" F1960 Conx.	W2713	10
Contractor Packs				
	85122	Brass Qtr-turn Valves, Uninstalled, 1/2" Sweat Conx.	W2121CP	20
	85124	Brass Qtr-turn Valves, Uninstalled, 1/2" CPVC Conx.	W2250CP	20
	85126	Brass Qtr-turn Valves, Uninstalled, 1/2" F1807 Conx.	W2122CP	20
	89267	Replacement Faceplate ¹	W7070	1



85125
Standard pack
(shown with faceplate)



85125
Contractor pack
(shown without faceplate)



v
Top-mount Invert outlet box
for Top-mount option.
(shown without faceplate)

¹Faceplates are Category *

Econo Center Drain Washing Machine Outlet Boxes



82064
Standard pack
(shown with faceplate)



82065
Contractor pack
(shown without faceplate)



82065
Top-mount Invert outlet box
for Top-mount option.
(shown without faceplate)

- Box can be inverted for top-mount valves and center drain option
- Textured, snap-on frame accommodates up to 1" drywall for a clean finish
- Center Drain Econo Box and DU-All™ faceplates are interchangeable
- One-piece construction with raised drip guard contains potential leaks down the drain
- Raised EZ-out test caps allow for easy removal
- Oversized KOs will not fall down drain
- Brass Quarter-turn valves installed
- Rough opening: 8-1/4" W x 6-1/8" H x 3-3/4"D
- Faceplate dimension: 10-3/16" W x 8-13/16" H
- Extended mounting flange provided
- Covered by one or more of the following patents – D411,870; D471,960
- Faceplate unassembled in contractor packs

LISTINGS	PRODUCT	DESCRIPTION	MODEL	UNITS/CASE
Standard Packs				
82064	Brass Qtr-turn Valves, Installed, 1/2" Sweat Conx.		W4700	10
82066	Brass Qtr-turn Valves, Installed, 1/2" CPVC Conx.		W4701	10
82068	Brass Qtr-turn Valves, Installed, 1/2" F1807 Conx.		W4702	10
82003	Brass Qtr-turn Valves, Installed, 1/2" F1960 Conx.		W4711	10
82308	Brass Qtr-turn Valves, Installed, 1/2" F3347 Conx.		W4722	10
82752	Brass Qtr-turn Valves, Installed, 1/2" REHAU EVERLOC+™		W4705	10
87203	Washer Box Only – No Valves, 1-1/2" x 2" Coupling		W4015	10
87204	Washer Box Only – No Valves		W4012	10
Contractor Packs				
82065	Brass Qtr-turn Valves, Installed, 1/2" Sweat Conx.		W4700CP	20
82067	Brass Qtr-turn Valves, Installed, 1/2" CPVC Conx.		W4701CP	20
82069	Brass Qtr-turn Valves, Installed, 1/2" F1807 Conx.		W4702CP	20
82004	Brass Qtr-turn Valves, Installed, 1/2" F1960 Conx.		W4711CP	20
82753	Brass Qtr-turn Valves, Installed, 1/2" REHAU EVERLOC+™		W4705CP	20
Center Drain Display Pack				
81977	Brass Qtr-turn Valves, Installed 1/2" F1807		R4702	4
89267	Replacement Faceplate ¹		W7070	1



¹Faceplates are Category *

Weld-On®
Guy Gray®
Water-Tite®
ToughPans®
RTB
Test-Tite®
AB&A®
Studor®
Truebro®
Christy's®
FloodStop®
ProVent®
ProSet®

Econo Center Drain Washing Machine Outlet Boxes with Hammer Arrester Valves

- Box can be inverted for top-mount valves and center drain option
- Textured, snap-on frame accommodates up to 1" drywall for a clean finish
- Center Drain Econo Box and DU-All™ faceplates are interchangeable
- One-piece construction with raised drip guard contains potential leaks down the drain
- Raised EZ-out test caps allow for easy removal
- Oversized KOs will not fall down drain
- Brass Hammer Arrester valves installed
- Rough opening: 8-1/4" W x 6-1/8" H x 3-3/4"D
- Faceplate dimension: 10-3/16" W x 8-13/16" H
- Extended mounting flange provided
- Products covered by one or more of the following patents – D411,870; D471,960
- Faceplate unassembled in contractor packs

LISTINGS	PRODUCT	DESCRIPTION	MODEL	UNITS/CASE
Hammer Arrester Standard Packs				
	85708	Brass Qtr-turn Arrester Valves, Installed, 1/2" Sweat Conx.	W4700HA	10
	85711	Brass Qtr-turn Arrester Valves, Installed, 1/2" CPVC Conx.	W4701HA	10
	85716	Brass Qtr-turn Arrester Valves, Installed, 1/2" F1807 Conx.	W4702HA	10
	85738	Brass Qtr-turn Arrester Valves, Installed, 1/2" F1960	W4711HA	10
	82754	Brass Qtr-turn Arrester Valves, Installed, 1/2" REHAU EVERLOC+™	W4705HA	10
Hammer Arrester Contractor Packs				
	85709	Brass Qtr-turn Arrester Valves, Installed, 1/2" Sweat Conx.	W4700HACP	20
	85712	Brass Qtr-turn Arrester Valves, Installed, 1/2" CPVC Conx.	W4701HACP	20
	85722	Brass Qtr-turn Arrester Valves, Installed 1/2" F1807	W4702HACP	20
	85773	Brass Qtr-turn Arrester Valves, Installed, 2" F1960, TCONE	W4702THACP	10
	85739	Brass Qtr-turn Arrester Valves, Installed, 1/2" F1960	W4711HACP	20
	82755	Brass Qtr-turn Arrester Valves, Installed, 1/2" REHAU EVERLOC+™	W4705HACP	20
	89267	Replacement Faceplate ¹	W7070	1



85708
Standard pack
(shown with faceplate)



85709
Contractor pack
(shown without faceplate)



82709
Top-mount Invert outlet box
for Top-mount option.
(shown without faceplate)

¹ Faceplates are Category *

Right-hand Wide-Mouth Outlet Boxes



87351

- Wide-mouth opening for drainage of auxiliary line
- Drain line partition for separation of washer discharge hose and auxiliary discharge line
- Discharge guide tube holds discharge line firmly and protects against splashes
- One drain outlet, no additional fittings
- One-piece molded in test cap will not fall down drain line
- Four mounting brackets included
- Rough opening: 10-1/4" W x 6" H x 3-5/8" D
- Faceplate dimension: 13" W x 5-5/8" H
- Faceplate unassembled in contractor packs

LISTINGS	PRODUCT	DESCRIPTION	MODEL	UNITS/CASE
Standard Packs				
87351	Brass Qtr-turn Valves, Installed, 1/2" Sweat Conx.		W8900	10
87355	Brass Qtr-turn Valves, Installed, 1/2" CPVC Conx.		W8901	10
87359	Brass Qtr-turn Valves, Installed, 1/2" F1807 Conx.		W8902	10
87378	Brass Qtr-turn Valves, Installed, 1/2" F1960 Conx.		W8911	10
87349	Brass Qtr-turn Valves, Uninstalled, 1/2" Sweat Conx.		W8912	10
87386	Brass Qtr-turn Valves, Uninstalled, 1/2" F1960 Conx.		W8411	10
82771	Brass Qtr-turn Arrester Valves, Installed, 1/2" REHAU EVERLOC+™		W8905	10
87363	Single-lever Valve, Installed, 1/2" Sweat Conx.		W8904	10
Contractor Packs				
87353	Brass Qtr-turn Valves, Installed, 1/2" Sweat Conx.		W8900CP	10
87357	Brass Qtr-turn Valves, Installed, 1/2" CPVC Conx.		W8901CP	10
87361	Brass Qtr-turn Valves, Installed, 1/2" F1807 Conx.		W8902CP	10
87379	Brass Qtr-turn Valves, Installed, 1/2" F1960 Conx.		W8911CP	10
82772	Brass Qtr-turn Valves, Installed, 1/2" REHAU EVERLOC+™		W8905CP	10
87365	Single-lever Valve, Installed, 1/2" Sweat Conx.		W8904CP	10
87398	Single-lever Valve, Installed, 1/2" F1960 Conx.		W8914CP	10
87435	Wide Mouth WMOB, Uninstalled – 1/2" Pex Conx., Knockouts for Top or Bottom Mount		W8902KOCP	10
Top-mount Contractor Packs				
87385	Brass Qtr-turn Valves, Installed, Top-mount, 1/2" Sweat Conx.		W8900CPTM	10
87383	Brass Qtr-turn Valves, Installed, Top-mount, 1/2" CPVC Conx.		W8901CPTM	10
87384	Brass Qtr-turn Valves, Installed, Top-mount, 1/2" F1807 Conx.		W8902CPTM	10
87382	Brass Qtr-turn Valves, Installed, Top-mount, 1/2" F1960 Conx.		W8911CPTM	10
87417	Brass Qtr-turn Valves, Installed, Top-mount, 1/2" F3347 Conx.		W8922CPTM	10
87405	Wide Mouth WMOB, Right Drain, Less Valves		W8900LV	10
89277	Replacement Faceplate ¹		89277	1



¹Faceplates are Category *

Weld-On®
Guy Gray®
Water-Tite®
ToughPans®
RTB
Test-Tite®
AB&A®
Studor®
Truebro®
Christy's®
FloodStop®
ProVent®
ProSet®

Right-hand Wide-Mouth Outlet Boxes with Hammer Arresters

- Wide-mouth opening for drainage of auxiliary line
- Drain line partition for separation of washer discharge hose and auxiliary discharge line
- Discharge guide tube holds discharge line firmly and protects against splashes
- One drain outlet, no additional fittings
- One-piece molded in test cap will not fall down drain line
- Four mounting brackets included
- Rough opening: 10-1/4" W x 6" H x 3-5/8" D
- Faceplate dimension: 13" W x 5 5/8" H
- Faceplate unassembled in contractor packs



87404

LISTINGS	PRODUCT	DESCRIPTION	MODEL	UNITS/CASE
Hammer Arrester Standard Pack				
	87404	Brass Qtr-turn Arrester Valves, Installed, 1/2" F1807 Conx.	W8902HA	10
	82773	Brass Qtr-turn Arrester Valves, Installed, 1/2" REHAU EVERLOC+™	W8905HA	10
Hammer Arrester Contractor Packs				
	87390	Brass Qtr-turn Arrester Valves, Installed, 1/2" Sweat Conx.	W8900HACP	10
	87407	Brass Qtr-turn Arrester Valves, Installed, 1/2" CPVC Conx.	W8901HACP	10
	87401	Brass Qtr-turn Arrester Valves, Installed, 1/2" F1960 Conx.	W8911HACP	10
	82774	Brass Qtr-turn Arrester Valves, Installed, 1/2" REHAU EVERLOC+™	W8905HACP	10
	87400	Single-lever Valve, Installed, 1/2" F1960 Conx.	W8914HACP	10
Top Mount Contractor Packs				
	87388	Brass Qtr-turn Arrester Valves, Installed, Top-mount, 1/2" Sweat Conx.	W8900HACPTM	10
	87408	Brass Qtr-turn Arrester Valves, Installed, Top-mount, 1/2" F1960 Conx. (Display Pack)	W8911HACPTM	10
	87418	Brass Qtr-turn Arrester Valves, Installed, Top-mount, 1/2" F3347 Conx.	W8922HACPTM	10
	87389	Brass Qtr-turn Arrester Valves, Installed, Top-mount, 1/2" F1807 Conx.	W8902HACPTM	10
	89277	Replacement Faceplate ¹	89277	1



Left-hand Wide-Mouth Outlet Boxes

- Wide-mouth opening for drainage of auxiliary line
- Drain line partition for separation of washer discharge hose and auxiliary discharge line
- Discharge guide tube holds discharge line firmly and protects against splashes
- One drain outlet, no additional fittings
- One-piece molded in test cap will not fall down drain line
- Four mounting brackets included
- Rough opening: 10-1/4" W x 6" H x 3-5/8" D
- Faceplate dimension: 13" W x 5-5/8" H
- Faceplate unassembled in contractor packs



96997

LISTINGS	PRODUCT	DESCRIPTION	MODEL	UNITS/CASE
Standard Packs				
	87367	Brass Qtr-turn Valves, Installed, 1/2" Sweat Conx.	W8900LD	10
	87371	Brass Qtr-turn Valves, Installed, 1/2" CPVC Conx.	W8901LD	10
	87374	Brass Qtr-turn Valves, Installed, 1/2" F1807 Conx.	W8902LD	10
	87380	Brass Qtr-turn Valves, Installed, 1/2" F1960 Conx.	W8911LD	10
Contractor Packs				
	87373	Brass Qtr-turn Valves, Installed, 1/2" CPVC Conx.	W8901LDCP	10
Hammer Arrester Contractor Packs				
	87409	Brass Qtr-turn Arrester Valves, Installed, 1/2" CPVC Conx.	W8901LDHACP	10
	89277	Replacement Faceplate ¹	89277	1



¹ Faceplates are Category *

DESIGN OPTIONS GUIDE

Water-Tite® offers a comprehensive line of Ice Maker Outlet Boxes, Handles, and Valve Connections for your installation needs. All Water-Tite® and Guy Gray® valves comply with lead-free laws and ASME A112.18.1. All integral hammer arrester valves also comply with ASSE 1010. See the following pages for additional details on all of the components.

Ice Maker Outlet Boxes



Plastic Square
Ice Maker Outlet Boxes



Plastic Round
Ice Maker Outlet Boxes



Plastic Mini-Round
Outlet Boxes



MultiBox™ Ice Maker
Outlet Boxes

Valve Types – Compression Connection



Quarter-turn



MultiBox Quarter-
turn



Domestic



Quarter-turn
Hammer Arrester



MultiBox Hammer
Arrester



Quarter-turn
w/o Hammer Arrester

Valve Connections



1/2" Copper Sweat



1/2" CPVC
ASTM D2846



1/2" Crimp
ASTM F1807



3/8" Crimp
ASTM F1807



1/2" Cold
Expansion
ASTM F1960



Long Shank
Extension



REHAU EVERLOC+



F3347

Plastic Lead-free Ice Maker Outlet Boxes

- Valves are IAPMO listed to ASME A112.18.1 / CSA B125.1 and are NSF 61/NSF 372 compliant to lead leaching
- Valves feature white handle and stamping
- Rough opening: 5 3/4" W x 4 7/8" H x 3-1/2" D
- Faceplate dimension 8-1/4" W x 7-5/16" H
- Contour box design allows easy valve access
- One-piece box and flange design needs no additional support framing nor support framing labor
- Snap-on faceplate accommodates up to 3/4" drywall
- Faceplate unassembled in contractor packs
- Product covered by one or more of the following patents – D411,870; D471,960



87967



87978

LISTINGS	PRODUCT	DESCRIPTION	MODEL	UNITS/CASE
Lead-free Standard Packs				
	87967	Brass Qtr-turn Valve, Installed, 1/2" Sweat Conx.	AB9700	10
	87971	Brass Qtr-turn Valve, Installed, 1/2" CPVC Conx.	AB9701	10
	87969	Brass Qtr-turn Valve, Installed, 1/2" F1807 Conx.	AB9702	10
	87973	Brass Qtr-turn Valve, Installed, 1/2" F1960 Conx.	AB9711	10
	88017	Brass Qtr-turn Domestic Valve, Installed, 1/2" Sweat Conx.	AB9000A	10
	87952	Brass Qtr Turn Valve, Installed, 1/2" F3347 Conx.	AB9722	10
	87954	Brass Qtr Turn Valve, Installed, 3/8" F1807 Conx.	AB9738	10
	82821	Brass Qtr Turn Valve, Installed, REHAU EVERLOC+™ Conx.	AB9705	10
	88008	Ice Maker Box Only - No Valves	W9000LV	10
Lead-free Contractor Packs				
	87968	Brass Qtr-turn Valve, Installed, 1/2" Sweat Conx.	AB9700CP	20
	87972	Brass Qtr-turn Valve, Installed, 1/2" CPVC Conx.	AB9701CP	20
	87970	Brass Qtr-turn Valve, Installed, 1/2" F1807 Conx.	AB9702CP	20
	87974	Brass Qtr-turn Valve, Installed, 1/2" F1960 Conx.	AB9711CP	20
	87953	Brass Qtr Turn Valve, Installed, 1/2" F3347 Conx.	AB9722CP	20
	87955	Brass Qtr Turn Valve, Installed, 3/8" F1807 Conx.	AB9738CP	20
	82822	Brass Qtr Turn Valve, Installed, REHAU EVERLOC+™ Conx.	AB9705CP	20
Lead-free Hammer Arrester Standard Packs				
	87978	Brass Qtr-turn Arrester Valve, Installed, 1/2" Sweat Conx.	AB9700HA	10
	87982	Brass Qtr-turn Arrester Valve, Installed, 1/2" CPVC	AB9701HA	10
	87980	Brass Qtr-turn Arrester Valve, Installed, 1/2" F1807 Conx.	AB9702HA	10
	87984	Brass Qtr-turn Arrester Valve, Installed, 1/2" F1960 Conx.	AB9711HA	10
	87958	Brass Qtr-turn Arrester Valve, Installed, 1/2" F3347 Conx.	AB9722HA	10
	82823	Brass Qtr-turn Arrester Valve, Installed, REHAU EVERLOC+™	AB9705HA	10
Lead-free Hammer Arrester Contractor Packs				
	87979	Brass Qtr Turn Arrester Valve, Installed, 1/2" Sweat Conx.	AB9700HACP	20
	87983	Brass Qtr-turn Arrester Valve, Installed, 1/2" CPVC Conx.	AB9701HACP	20
	87981	Brass Qtr-turn Arrester Valve, Installed, 1/2" F1807	AB9702HACP	20
	87985	Brass Qtr-turn Arrester Valve, Installed, 1/2" F1960	AB9711HACP	20
	87959	Brass Qtr Turn Arrester Valve, Installed, 1/2" F3347 Conx.	AB9722HACP	20
	82824	IBrass Qtr-turn Arrester Valve, Installed, REHAU EVERLOC+™	AB9705HACP	20
Lead-free Display Packs				
	88182	Brass Qtr-turn Valve, Installed, 1/2" Sweat Conx.	RAB9000B	10
	89266	Replacement Faceplate ¹	W7011	1



¹ Faceplates are Category *

Round Ice Maker Outlet Box with Hose



88480

- Valves are IAPMO listed to ASME A112.18.1 / CSA B125.1 and are NSF 61/NSF 372 compliant to lead leaching
- 72" stainless steel braided hose comes attached to valve
- Hose is replaceable
- Round faceplate enables easier installation after wallboard is installed
- Flat-sided walls ensure rigid mount against stud bay
- Rough opening: 6" diameter x 3-1/2" deep
- Faceplate diameter: 8" round
- Protective cover protects valves and hose from paint and debris during construction
- Additional top knockouts molded in box to allow for mounting shut-off valves or gas valves
- Faceplate unassembled in contractor packs
- Four molded-in flanges enable easy and secure installation

LISTINGS	PRODUCT	DESCRIPTION	MODEL	UNITS/CASE
Standard Packs				
	88480	Brass Qtr-turn Valve, Installed, 1/2" Sweat Conx.	AB9800	10
	88482	Brass Qtr-turn Valve, Installed, 1/2" CPVC Conx.	AB9801	10
	88484	Brass Qtr-turn Valve, Installed, 1/2" F1807 Conx.	AB9802	10
	88486	Brass Qtr-turn Valve, Installed, 1/2" F1960 Conx.	AB9811	10
	88068	Round Ice Maker Supply Box only, No Valves or Hose	W9800LV	10
Contractor Packs				
	88481	Brass Qtr-turn Valve, Installed, 1/2" Sweat Conx.	AB9800CP	20
	88483	Brass Qtr-turn Valve, Installed, 1/2" CPVC Conx.	AB9801CP	20
	88485	Brass Qtr-turn Valve, Installed, 1/2" F1807 Conx.	AB9802CP	20
	88487	Brass Qtr-turn Valve, Installed, 1/2" F1960 Conx.	AB9811CP	20
	89275	Replacement Faceplate ¹	89275	1

Round Ice Maker Outlet Box, Less Hose



88488

- Valves are IAPMO listed to ASME A112.18.1 / CSA B125.1 and are NSF 61/NSF 372 compliant to lead leaching
- Round faceplate enables easier installation after wallboard is installed
- Protective cover protects valves and hose from paint and debris during construction
- Rough opening: 6" diameter x 3-1/2" deep
- Faceplate diameter: 8" round
- Flat-sided walls ensure rigid mount against stud bay
- Additional top knockouts molded in box to allow for mounting shut-off valves or gas valves
- Faceplate unassembled in contractor packs
- Four molded-in flanges enable easy and secure installation

LISTINGS	PRODUCT	DESCRIPTION	MODEL	UNITS/CASE
Standard Packs				
	88488	Brass Qtr-turn Valve, Installed, 1/2" Sweat Conx.	AB9900	10
	88491	Brass Qtr-turn Valve, Installed, 1/2" CPVC Conx.	AB9901	10
	88493	Brass Qtr-turn Valve, Installed, 1/2" F1807 Conx.	AB9902	10
	88496	Brass Qtr-turn Valve, Installed, 1/2" F1960 Conx.	AB9911	10
Contractor Packs				
	88489	Brass Qtr-turn Valve, Installed, 1/2" Sweat Conx.	AB9900CP	20
	88492	Brass Qtr-turn Valve, Installed, 1/2" CPVC Conx.	AB9901CP	20
	88494	Brass Qtr-turn Valve, Installed, 1/2" F1807 Conx.	AB9902CP	20
	88497	Brass Qtr-turn Valve, Installed, 1/2" F1960 Conx.	AB9911CP	20
	89275	Replacement Faceplate ¹	89275	1

¹Faceplates are Category *

Weld-On®
Guy Gray®
Water-Tite®
ToughPans®
RTB
Test-Tite®
AB&A®
Studor®
Truebro®
Christy's®
FloodStop®
ProVent®
ProSet®

Round Ice Maker Outlet Box with Hammer Arrester Valve, Less Hose

- Pre-loaded nails provide strong rigid mount
- Nails are reversible and box can be mounted to left or right-hand stud bay
- Round trim ring faceplate accommodates up to 1" drywall
- Valves are IAPMO listed to ASME A112.18.1 / CSA B125.1 and are NSF 61/NSF 372 compliant to lead leaching
- Valves feature white handle and stamping
- Rough opening: 4-3/4" diameter x 2-3/8" deep
- Faceplate diameter: 6-1/8" round
- Valve options: Copper, CPVC, PEX, and Wirsbo®
- Molded-in side support brackets support box to stud bay
- Brass quarter-turn valve installed



88498

LISTINGS	PRODUCT	DESCRIPTION	MODEL	UNITS/CASE
	88498	Brass Qtr-turn Arrester Valve, Installed, 1/2" F1960 Conx.	AB9911HACP	20
	88490	Brass Qtr-turn Arrester Valve, Installed, 1/2" Sweat Conx.	AB9900HACP	20
	88495	Brass Qtr-turn Arrester Valve, Installed, 1/2" F1807 Conx.	AB9902HACP	20
	89275	Replacement Faceplate ¹	89275	1

Round Mini Ice Maker Outlet Box With Hammer Arrester Valve & Preloaded Mounting Nails

- Pre-loaded nails provide strong rigid mount
- Nails are reversible and box can be mounted to left or right-hand stud bay
- Round trim ring faceplate accommodates up to 1" drywall
- Valves are IAPMO listed to ASME A112.18.1 / CSA B125.1 and are NSF 61/NSF 372 compliant to lead leaching
- Valves feature white handle and stamping
- Rough opening: 4-3/4" diameter x 2-3/8" deep
- Faceplate diameter: 6-1/8" round
- Valve options: Copper, CPVC, PEX, and Wirsbo®
- Molded-in side support brackets support box to stud bay
- Available in standard and contractor packs
- Brass quarter-turn valve installed



88372

LISTINGS	PRODUCT	DESCRIPTION	MODEL	UNITS/CASE
Standard Packs				
	88372	Brass Qtr-turn Arrester Valve, Installed, 1/2" Sweat Conx.	AB9200HA	10
	88376	Brass Qtr-turn Arrester Valve, Installed, 1/2" CPVC Conx.	AB9201HA	10
	88377	Brass Qtr-turn Arrester Valve, Installed, 1/2" F1807 Conx.	AB9202HA	10
	88379	Brass Qtr-turn Arrester Valve, Installed, 1/2" F1960 Conx.	AB9211HA	10
	88559	Brass Qtr-turn Arrester Valve, Installed, 1/2" F3347 Conx.	AB9222HA	10
Contractor Packs				
	88373	Brass Qtr-turn Arrester Valve, Installed, 1/2" Sweat Conx.	AB9200HACP	20
	88381	Brass Qtr-turn Arrester Valve, Installed, 1/2" CPVC Conx.	AB9201HACP	20
	88378	Brass Qtr-turn Arrester Valve, Installed, 1/2" F1807 Conx.	AB9202HACP	20
	88380	Brass Qtr-turn Arrester Valve, Installed, 1/2" F1960 Conx.	AB9211HACP	20
	89279	Replacement Faceplate ¹	89279	1

¹Faceplates are Category *

Round Mini Lead-free Ice Maker Outlet Box and Preloaded Mounting Nails



87989

- Valves are IAPMO listed to ASME A112.18.1 / CSA B125.1 and are NSF 61/NSF 372 compliant to lead leaching
- Valves feature white handle and stamping
- Pre-loaded nails provide strong rigid mount
- Nails are reversible and box can be mounted to left or right-hand stud bay
- Round trim ring faceplate accommodates up to 1" drywall
- Molded-in side support brackets supports box to stud bay
- Rough opening: 4-3/4" diameter x 2-3/8" deep
- Faceplate diameter: 6-1/8" round
- Valve options: Copper, CPVC, PEX and Wirsbo®
- Brass quarter-turn valve installed
- Faceplate unassembled in contractor packs

LISTINGS	PRODUCT	DESCRIPTION	MODEL	UNITS/CASE
Lead-free Standard Packs				
	87989	Brass Qtr-turn Valve, Installed, 1/2" Sweat Conx.	AB9200	10
	87993	Brass Qtr-turn Valve, Installed, 1/2" CPVC Conx.	AB9201	10
	87991	Brass Qtr-turn Valve, Installed, 1/2" F1807 Conx.	AB9202	10
	87995	Brass Qtr-turn Valve, Installed, 1/2" F1960 Conx.	AB9211	10
	88399	Brass Qtr-turn Valve, Installed, 1/2" F3347 Conx.	AB9222	10
	88382	Brass Qtr-turn Valve, Installed, 3/8" F1807 Conx.	AB9238	10
Lead-free Contractor Packs				
	87990	Brass Qtr-turn Valve, Installed, 1/2" Sweat Conx.	AB9200CP	20
	87994	Brass Qtr-turn Valve, Installed, 1/2" CPVC Conx.	AB9201CP	20
	87992	Brass Qtr-turn Valve, Installed, 1/2" F1807 Conx.	AB9202CP	20
	87996	Brass Qtr-turn Valve, Installed, 1/2" F1960 Conx.	AB9211CP	20
	89279	Replacement Faceplate ¹	89279	1

Round Mini Ice Maker Outlet Box with Domestic Valve and Preloaded Mounting Nails



88374

- Pre-loaded nails provide strong rigid mount
- Nails are reversible and box can be mounted to left or right-hand stud bay
- Round trim ring faceplate accommodates up to 1" drywall
- Valves are IAPMO listed to ASME A112.18.1 / CSA B125.1 and are NSF 61/NSF 372 compliant to lead leaching
- Valves feature white handle and stamping
- Rough opening: 4-3/4" diameter x 2-3/8" deep
- Faceplate diameter: 6-1/8" round
- Valve options: Copper, CPVC, PEX, and Wirsbo®
- Molded-in side support brackets support box to stud bay
- Available in standard and contractor packs
- Brass quarter-turn valve installed

LISTINGS	PRODUCT	DESCRIPTION	MODEL	UNITS/CASE
	88374	Domestic Valve, Installed, 1/2" Sweat Conx.	AB9200D	10
	89279	Replacement Faceplate ¹	89279	1

¹Faceplates are Category *

Round Mini Plastic Dishwasher, Commercial Ice Maker, and Coffee Maker Outlet Box with Preloaded Mounting Nails

- One box design with installed valve or arrester valve saves considerable installation time versus installing separate boxes or separate valves and Hammer Arresters
- 3/8" outlet, quarter-turn valve pre-installed
- Preloaded, reversible nails provide strong rigid mount
- Rough opening: 4-3/4" diameter x 2-3/8" deep
- Valves are IAPMO listed to ASME A112.18.1 / CSA B125.1 and are NSF 61/NSF 372 compliant to lead leaching
- Faceplate diameter: 6-1/8" round
- Round faceplate design accommodates up to 1" sheet rock
- Available with Sweat, CPVC and PEX Qtr-turn connections; with or without Hammer Arresters
- Ideal for coffee kiosks, sink/faucet and toilet connections
- Molded-in side support brackets support box to stud bay



87934

LISTINGS	PRODUCT	DESCRIPTION	MODEL	UNITS/CASE
Standard Packs with Arrester Valves				
	87934	Brass Qtr-turn Arrester Valve, 3/8" Outlet, Installed, 1/2" Sweat Conx.	AB9300HA	10
	87935	Brass Qtr-turn Arrester Valve, 3/8" Outlet, Installed, 1/2" CPVC Conx.	AB9301HA	10
	87937	Brass Qtr-turn Arrester Valve, 3/8" Outlet, Installed, 1/2" F1807 Conx.	AB9302HA	10
	Standard Packs			
	87960	Brass Qtr-Turn Valve, 3/8" Outlet, Installed, 1/2" Sweat Conx.	AB9300	10
	87961	Brass Qtr-Turn Valve, 3/8" Outlet, Installed, 1/2" CPVC Conx.	AB9301	10
	87962	Brass Qtr-Turn Valve, 3/8" Outlet, Installed, 1/2" F1807 Conx.	AB9302	10
	Contractor Packs with Arrester Valves			
	87938	Brass Qtr-turn Arrester Valve, 3/8" Outlet, Uninstalled, 1/2" F1807 Conx.	AB9302HACP	20
	89279	Replacement Faceplate ¹	89279	1



Utility Outlet Boxes, No Valves

- Box contains 16 knockouts for custom configuration
- Integrated stabilizer bar slots allow for center of the stud bay mount using a stabilizer bar
- Easily and quickly mounts to stud with four integrated mounting ears
- Available with standard faceplate or solid faceplate for concealment



82761

LISTINGS	PRODUCT	DESCRIPTION	MODEL	UNITS/CASE
	82760	Utility Box with Solid Frame, No Valves	1500	10
	97252	Replacement Frame - Solid (only fits Utility Box)	97252	40
	82761	Utility Box with Standard Frame, No Valves	1501	10
	97251	Replacement Frame - Standard (only fits Utility Box)	97251	40

¹Faceplates are Category *

Mini Round Gas Outlet Box



88106

- Provides a recessed valve installation allowing appliances to be closer to wall
- Preloaded nails provide a strong rigid mount
- Nails are reversible and box can be mounted to the left or right-hand stud bay
- Two valve options: 1/2" iron pipe & 1/2" CSST Tubing
- Valves are CSA listed to ANSI Z21/CSA9.1
- Test plug provided for testing of valve assembly
- Round trim ring fits mini ice maker box & accommodates up to 1" sheet rock
- Molded side support brackets support box to stud bay
- Faceplate unassembled in contractor packs

LISTINGS	PRODUCT	DESCRIPTION	MODEL	UNITS/CASE
Standard Packs				
	88106	Mini Gas Outlet Box, 1/2" IPS Gas Valve	W5700	10
Contractor Pack				
	88107	Mini Gas Outlet Box, 1/2" IPS Gas Valve	W5700CP	10
	89267	Replacement Faceplate ¹	W7070	1

¹Faceplates are Category *

Weld-On®
Guy Gray®
Water-Tite®
ToughPans®
RTB
Test-Tite®
AB&A®
Studor®
Truebro®
Christy's®
FloodStop®
ProVent®
ProSet®

Round Gas Outlet Box

- Provides a recessed valve installation allowing appliances to be closer to wall
- Three valve options: 1/2" iron pipe, 1/2" CSST tubing and 3/4" iron pipe
- Valves are CSA listed to ANSI Z21/CSA9.1
- Four molded-in flanges enable easy and secure installation
- Round face plate enables easier installation after wallboard is installed
- Flat-sided walls ensure rigid mount against stud bay



87860

LISTINGS	PRODUCT	DESCRIPTION	MODEL	UNITS/CASE
	87860	Large Round, 1/2" IPS Gas Valve	W5912IP	5
	87861	Large Round, 3/4" IPS Gas Valve	W5934IP	5
	87862	Large Round, 1/2" Female Gas Valve CSST	W5912CSST	5
	89275	Replacement Faceplate ¹	89275	1

¹Faceplates are Category *

MultiBox™ Kitchen Outlet Box



83197

- Valves are IAPMO listed to ASME A112.18.1 / CSA B125.1 and are NSF 61/NSF 372 compliant to lead leaching
- Extra large frame provides three breaklines for custom fit to cabinetry
- Extra large frame provides extra 1" coverage for potential cabinet rough cuts
- Available with three standard qtr.-turn valves or two standard qtr.-turn valves and one hammer arrester valve

PRODUCT	DESCRIPTION	MODEL	UNITS/CASE
Standard Packs			
83195	Three 3/8" Outlet Valves, 1/2" Sweat	ASDW1200	10
83196	Three 3/8" Outlet Valves, 1/2" CPVC	ASDW1201	10
83197	Three 3/8" Outlet Valves, 1/2" F1807	ASDW1202	10
83198	Three 3/8" Outlet Valves, 1/2" F1960	ASDW1211	10
83384	Three 3/8" Outlet Valves, 1/2" REHAU EVERLOC+™	ASDW1205	10
Hammer Arrester			
83199	Three 3/8" Outlet Valves, Includes One Integral HA, 1/2" Sweat	ASDW1200HA	10
83206	Three 3/8" Outlet Valves, Includes One Integral HA, 1/2" CPVC	ASDW1201HA	10
83207	Three 3/8" Outlet Valves, Includes One Integral HA, 1/2" F1807	ASDW1202HA	10
83208	Three 3/8" Outlet Valves, Includes One Integral HA, 1/2" F1960	ASDW1211HA	10
83386	Three 3/8" Outlet Valves, Includes One Integral HA, 1/2" REHAU EVERLOC+™	ASDW1205HA	10
82974	Replacement Faceplate ¹	MBF1233	1



83207

Fire-rated MultiBox™ Kitchen Outlet Box



83310

- Intumescent pad attached to back of outlet box
- Extra large frame provides three breaklines for custom fit to cabinetry
- Extra large frame provides extra 1" coverage for potential cabinet rough cuts
- 1hr & 2hr rated
- Available with three standard qtr.-turn valves or two standard qtr.-turn valves and one hammer arrester valve
- ETL Listed
- Valves are IAPMO listed to ASME A112.18.1 / CSA B125.1 and are NSF 61/NSF 372 compliant to lead leaching

PRODUCT	DESCRIPTION	MODEL	UNITS/CASE
Standard Pack			
83310	Three 3/8" Outlet Valves, 1/2" Sweat	FRASDW1200	10
83311	Three 3/8" Outlet Valves, 1/2" CPVC	FRASDW1201	10
83312	Three 3/8" Outlet Valves, 1/2" F1807	FRASDW1202	10
83313	Three 3/8" Outlet Valves, 1/2" F1960	FRASDW1211	10
Hammer Arrester			
83314	Three 3/8" Outlet Valves, Includes One Integral HA, 1/2" Sweat	FRASDW1200HA	10
83315	Three 3/8" Outlet Valves, Includes One Integral HA, 1/2" CPVC	FRASDW1201HA	10
83316	Three 3/8" Outlet Valves, Includes One Integral HA, 1/2" F1807	FRASDW1202HA	10
83317	Three 3/8" Outlet Valves, Includes One Integral HA, 1/2" F1960	FRASDW1211HA	10
82974	Replacement Faceplate ¹	MBF1233	1



83314

¹Faceplates are Category *

Utility Kitchen Outlet Box with Three Valves

- Valves are IAPMO listed to ASME A112.18.1 / CSA B125.1 and are NSF 61/NSF 372 compliant to lead leaching
- Available with three qtr-turn hammer arrester valves
- Easily and quickly mounts to stud with four integrated mounting ears
- Top and bottom stabilizer bar slots
- Custom configurations available upon request



82764

PRODUCT	DESCRIPTION	MODEL	UNITS/CASE
82762	Three 3/8" Hammer Arrester Valves, Sweat	15003HA	5
82763	Three 3/8" Hammer Arrester Valves, CPVC	15013HA	5
82764	Three 3/8" Hammer Arrester Valves, F1807	15023HA	5
82765	Three 3/8" Hammer Arrester Valves, F1960	15113HA	5
82760	Utility Box with Solid Frame, No Valves ¹	1500	10
82761	Utility Box with Standard Frame, No Valves ¹	1501	10

Utility Kitchen Outlet Box with Four Valves

- Valves are IAPMO listed to ASME A112.18.1 / CSA B125.1 and are NSF 61/NSF 372 compliant to lead leaching
- Available with four qtr-turn hammer arrester valves
- Easily and quickly mounts to stud with four integrated mounting ears
- Top and bottom stabilizer bar slots
- Custom configurations available upon request



82768

PRODUCT	DESCRIPTION	MODEL	UNITS/CASE
82766	Four 3/8" Qtr-turn Valves, Sweat	15004	5
82767	Four 3/8" Qtr-turn Valves, CPVC	15014	5
82768	Four 3/8" Qtr-turn Valves, F1807	15024	5
82769	Four 3/8" Qtr-turn Valves, F1960	15114	5
82760	Utility Box, No Valves - Solid Frame ¹	1500	10
82761	Utility Box, No Valves - Standard Frame ¹	1501	10

¹Faceplates are Category *



Water-Tite® Faceplates

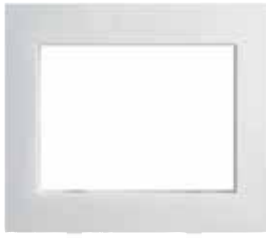

89267



89279

- Strong, durable replacement faceplates
- White to match existing box
- Wide frame allows for clean finish

PRODUCT	DESCRIPTION	MODEL	UNITS/CASE
89267	Dual-Drain & Standard WMOB (10-3/16" x 8-13/16") Faceplate	W7070	1
89277	Wide-Mouth WMOB Faceplate	89277	1
89266	Square Plastic IMOB (8-1/4" x 7-5/16") for 9700-series	W7011	1
89279	Mini Round Ice Maker and Gas Outlet Box Faceplate	89279	1
89275	Round IMOB Faceplate	89275	1
82945	MultiBox Faceplate Open	MBF1200	10
82946	MultiBox Faceplate Solid	MBF1211	10
82947	MultiBox Faceplate Louvered	MBF1222	10
82974	MultiBox Faceplate, Extra Deep	MBF1233	10

Outlet Box Accessories & Replacement Parts



88285



88651

PRODUCT	DESCRIPTION	MODEL	UNITS/CASE
88285	Short (4") Washer Box Mounting Flange	7003	1
88290	Long (7-11/16") Washer Box Mounting Flange	7003 A	1
90195	Grommet for WMOB & IMOB Compression Supply	7009	1
89917	Metal Locknut for 1/2" Supply Valves	6240	1
89431	Plastic Locknut for 1/2" CPVC Supply Valves	89431	1
88650	1/4" Cap for Ice Maker Valve, Brass (one cap)	88650	1
88651	3/8" Cap for Angle Stop Valves, Brass (pair)	88651	1
88652	3/4" Cap for Ice Washing Machine Valves, Brass (pair)	88652	1

Gas Outlet Box Valves



88651

- Easy quarter-turn
- Furnished with end plug for testing of valve
- CSA listed to ANSI Z21/CSA9.1
- Also compatible with Guy Gray® products

PRODUCT	DESCRIPTION	MODEL	UNITS/CASE
88311	1/2" Gas Valve Kit for Iron Pipe	88311	1
88312	1/2" Gas Valve Kit for CSST Tubing	88312	1
88313	3/4" Gas Valve Kit for Iron Pipe	203A04	1

Weld-On®
Guy Gray®
Water-Tite®
ToughPans®
RTB
Test-Tite®
AB&A®
Studor®
Truebro®
Christy's®
FloodStop®
ProVent®
ProSet®



Washing Machine Outlet Box Valves

- Brass finish
- Easy quarter-turn
- 3/4" Hose Bibb Connection
- Easy valve replacement for repairs
- Complies with ASME A112.18.1
- Also compatible with Guy Gray® products

LISTINGS	PRODUCT	DESCRIPTION	MODEL	UNITS/CASE
	88721	Qtr-turn Brass Valve, Red Handle, 1/2" Sweat Conx.	88721	1
	88722	Qtr-turn Brass Valve, Blue Handle, 1/2" Sweat Conx.	88722	1
	88725	Qtr-turn Brass Valve, Red Handle, 1/2" F1807 Conx.	88725	1
	88726	Qtr-turn Brass Valve, Blue Handle, 1/2" F1807 Conx.	88726	1
	88723	Qtr-turn Brass Valve, Red Handle, 1/2" CPVC Conx.	88250	1
	88724	Qtr-turn Brass Valve, Blue Handle, 1/2" CPVC Conx.	88251	1
	88727	Qtr-turn Brass Valve, Red Handle, 1/2" F1960 Conx.	88406	1
	88728	Qtr-turn Brass Valve, Blue Handle, 1/2" F1960 Conx.	88407	1
	88536	Qtr-turn Brass Valve, Red Handle, 1/2" Rehau Conx.	88536	1
	88537	Qtr-turn Brass Valve, Blue Handle, 1/2" Rehau Conx.	88537	1
	88828	Qtr-turn Brass Valve, Red Handle, 1/2" F3347 Conx.	88828	1
	88829	Qtr-turn Brass Valve, Blue Handle, 1/2" F3347 Conx.	88829	1
	90011	Domestic Adapter Valve (Blue Handle), 1/2" MIP/Sweat Conx.	6404AVEID	1
	90374	Domestic Adapter Valve (Red Handle), 1/2" MIP/Sweat Conx.	6404AVEIDR	1
	88260	Single-lever Valve, 1/2" Sweat Conx.	6408	1
	88262	Single-lever Valve, 1/2" CPVC Conx.	88262	1
	88261	Single-lever Valve, 1/2" F1807 Conx.	88261	1
	88259	Single-lever Valve, 1/2" F1960 Conx.	88259	1
	88242	Dual Handle Single Lever Valve ONLY, 1/2" Sweat Conx.	HS88242	5
	88170	Long Shank Extension Only, 1/2" Sweat Conx.	6401A	1



Washing Machine Outlet Box Hammer Arrester Valves

- Brass finish
- Easy quarter-turn
- 3/4" Hose Bibb Connection
- Easy valve replacement for repairs
- Complies with ASSE 1010
- Complies with ASME A112.18.1
- Also compatible with Guy Gray® products

LISTINGS	PRODUCT	DESCRIPTION	MODEL	UNITS/CASE
	88757	Qtr-turn Arrester Brass Valve, Red Handle, 1/2" Sweat Conx.	88757	1
	88758	Qtr-turn Arrester Brass Valve, Blue Handle, 1/2" Sweat Conx.	88758	1
	88761	Qtr-turn Arrester Brass Valve, Red Handle, 1/2" F1807 Conx.	88761	1
	88762	Qtr-turn Arrester Brass Valve, Blue Handle, 1/2" F1807 Conx.	88762	1
	88759	Qtr-turn Arrester Brass Valve, Red Handle, 1/2" CPVC Conx.	88759	1
	88760	Qtr-turn Arrester Brass Valve, Blue Handle, 1/2" CPVC Conx.	88760	1
	88763	Qtr-turn Arrester Brass Valve, Red Handle, 1/2" F1960 Conx.	88763	1
	88764	Qtr-turn Arrester Brass Valve, Blue Handle, 1/2" F1960 Conx.	88764	1
	88838	Qtr-turn Arrester Brass Valve, Red Handle, 1/2" Rehau Conx.	88838	1
	88839	Qtr-turn Arrester Brass Valve, Blue Handle, 1/2" Rehau Conx.	88839	1



88757

Continued next page



Washing Machine Outlet Box Hammer Arrester Valves (cont.)

LISTINGS	PRODUCT	DESCRIPTION	MODEL	UNITS/CASE
	88825	Qtr-turn Arrester Brass Valve, Red Handle, 1/2" F3347 Conx.	88825	1
	88826	Qtr-turn Arrester Brass Valve, Blue Handle, 1/2" F3347 Conx.	88826	1
	88800	Single-lever Valve, 1/2" Sweat Conx.	88800	1
	88801	Single-lever Valve, 1/2" F1807 Conx., Stainless Steel HA	88801	1
	88804	Single-lever Valve, 1/2" Sweat Conx. with Male NPT	88804	1
	88807	Single-lever Valve, 1/2" CPVC Conx., Stainless Steel HA	88807	1
	88806	Single-lever Valve, 1/2" F1960 Conx., Stainless Steel HA	88806	1

Lead-Free Ice Maker Outlet Box Valves



88733

- Lead-free compliant
- Valves feature white handle and stamping
- Easy quarter-turn
- Brass finish
- 1/4" compression connection
- Complies with ASME A112.18.1
- Also compatible with Guy Gray® products
- NSF/ANSI/CAN 61:Q <= 0.5

LISTINGS	PRODUCT	DESCRIPTION	MODEL	UNITS/CASE
	88733	Lead-free , Qtr-turn Valve, White Handle, 1/2" Sweat Conx.	88733	1
	88735	Lead-free , Qtr-turn Valve, White Handle, 1/2" F1807 Conx.	88735	1
	88734	Lead-free , Qtr-turn Valve, White Handle, 1/2" CPVC Conx.	88734	1
	88736	Lead-free , Qtr-turn Valve, White Handle, 1/2" F1960 Conx.	88736	1
	88538	Lead-free , Qtr-turn Arrester Valve, White Handle, 1/2" Rehau Conx.	88538	1
	88830	Lead-free , Qtr-turn Valve, White Handle, 1/2" F3347 Conx.	88830	1

Lead Free Ice Maker Outlet Box Hammer Arrester Valves



88366

- Lead-free compliant
- Valves feature white handle and stamping
- Easy quarter-turn
- Brass finish
- 1/4" compression connection
- Complies with ASME A112.18.1
- Also compatible with Guy Gray® products
- NSF/ANSI/CAN 61:Q <= 0.5

LISTINGS	PRODUCT	DESCRIPTION	MODEL	UNITS/CASE
	88769	Lead-free , Qtr-turn Arrester Valve, White Handle, 1/2" Sweat Conx.	88769	1
	88771	Lead-free , Qtr-turn Arrester Valve, White Handle, 1/2" F1807 Conx.	88771	1
	88770	Lead-free , Qtr-turn Arrester Valve, White Handle, 1/2" CPVC Conx.	88770	1
	88772	Lead-free , Qtr-turn Arrester Valve, White Handle, 1/2" F1960 Conx.	88772	1
	88840	Lead-free , Qtr-turn Arrester Valve, White Handle, 1/2" Rehau Conx.	88840	1
	88827	Lead-free , Qtr-turn Arrester Valve, White Handle, 1/2" F3347 Conx.	88827	1

Weld-On®
Guy Gray®
Water-Tite®
ToughPans®
RTB
Test-Tite®
AB&A®
Studor®
Truebro®
Christy's®
FloodStop®
ProVent®
ProSet®

MultiBox™ System - Washing Machine Outlet Boxes, Single Box

- For top mount water supply
- Integrated mounting flanges - no clips to lose or hassle with
- Top and bottom stabilizer bar slots
- Optional nail slots
- Water softener drain adapter can be used in this configuration (See page 97)
- Forged brass qtr-turn valves
- Integrated drain knock outs will not fall down the drain after DWV test
- Anti-rotational valve design
- MultiBox faceplates fit any MultiBox configuration, including fire-rated
- All faceplates fit up to two sheets of 5/8" drywall
- Standard faceplate includes cable tie bosses to secure drain hose



82890



82898

LISTINGS	PRODUCT	DESCRIPTION	MODEL	UNITS/CASE
Standard Packs				
	82890	Single Box System, 1/2" Sweat	MBS1200	10
	82891	Single Box System, 1/2" CPVC	MBS1201	10
	82892	Single Box System, 1/2" F1807	MBS1202	10
	82893	Single Box System, 1/2" F1960	MBS1211	10
	83027	Single Box System, 1/2" F3347	MBS1222	10
	83166	Single Box System, 1/2 REHAU EVERLOC+™	MBS1205	10
Contractor Packs				
	82894	Single Box System, 1/2" Sweat	MBS1200CP	10
	82895	Single Box System, 1/2" CPVC	MBS1201CP	10
	82896	Single Box System, 1/2" F1807	MBS1202CP	10
	82897	Single Box System, 1/2" F1960	MBS1211CP	10
	82953	Single Box System, Single Lever, 1/2" F1960	MBS1211SLCP	10
	83167	Single Box System, 1/2 REHAU EVERLOC+™	MBS1205CP	10
Hammer Arrester Standard Packs				
	82898	Single Box System w/Hammer Arresters, 1/2" Sweat	MBS1200HA	10
	82899	Single Box System w/Hammer Arresters, 1/2" CPVC	MBS1201HA	10
	82900	Single Box System w/Hammer Arresters, 1/2" F1807	MBS1202HA	10
	83020	Single Box System w/Hammer Arresters, 1/2" F3347	MBS1222HA	10
	82901	Single Box System w/Hammer Arresters, 1/2" F1960	MBS1211HA	10
	83020	Single Box System w/Hammer Arresters, 1/2" F13347	MBS1222HA	10
	83168	Single Box System w/Hammer Arresters, 1/2" REHAU EVERLOC+™	MBS1205HA	10
Hammer Arrester Contractor Packs				
	82902	Single Box System w/Hammer Arresters, 1/2" Sweat	MBS1200HACP	10
	82903	Single Box System w/Hammer Arresters, 1/2" CPVC	MBS1201HACP	10
	82904	Single Box System w/Hammer Arresters, 1/2" F1807	MBS1202HACP	10
	82905	Single Box System w/Hammer Arresters, 1/2" F1960	MBS1211HACP	10
	83169	Single Box System w/Hammer Arresters, 1/2" REHAU EVERLOC+™	MBS1205HACP	10
House Pack: Washing Machine Outlet Box and Ice Maker Outlet Box Contractor Packs				
	82958	Single Box System and Ice Maker Box, F1807	MBSAB1202CP	10
	82959	Single Box System and Ice Maker Box, F1960	MBSAB1211CP	10
House Pack: Washing Machine Outlet Box and Ice Maker Outlet Box with Hammer Arrester				
	82969	Single Box System and Ice Maker Box, F1807	MBSAB1202HACP	10
	82973	Single Box System and Ice Maker Box, F1960	MBSAB1211HACP	10
	82938	Replacement Faceplate ¹	MBS1200DB1	1



¹Faceplates are Category *

MultiBox™ System - Washing Machine Outlet Boxes with Auxiliary Drain Boxes



82906



82914



83173

- Integrated mounting flanges - no clips to lose or hassle with
- Top and bottom stabilizer bar slots
- Optional nail slots
- Nine valve knock-outs in box only
- Two drain knock-outs: 2" in standard washing machine drain, optional 1" to pipe valve box to DWV system
- Integrated drain knock outs will not fall down the drain after DWV test
- Anti-rotational valve design
- Forged brass qtr-turn valves
- MultiBox faceplates fit any MultiBox configuration, including fire-rated
- All faceplates fit up to two sheets of 5/8" drywall
- Standard faceplate includes cable tie bosses to secure drain hose

LISTINGS	PRODUCT	DESCRIPTION	MODEL	UNITS/CASE
Standard Packs				
82906	Dual Box System, 1/2" Sweat		MB1200	10
82907	Dual Box System, 1/2" CPVC		MB1201	10
82908	Dual Box System, 1/2" F1807		MB1202	10
82909	Dual Box System, 1/2" F1960		MB1211	10
83028	Dual Box System, 1/2" F3347		MB1222	10
83172	Dual Box System, 1/2" REHAU EVERLOC+™		MB1205	10
Contractor Packs				
82910	Dual Box System, 1/2" Sweat		MB1200CP	10
82911	Dual Box System, 1/2" CPVC		MB1201CP	10
82912	Dual Box System, 1/2" F1807		MB1202CP	10
82913	Dual Box System, 1/2" F1960		MB1211CP	10
83173	Dual Box System, 1/2" REHAU EVERLOC+™		MB1205CP	10
Hammer Arrester Standard Packs				
82914	Dual Box System w/Hammer Arresters, 1/2" Sweat		MB1200HA	10
82915	Dual Box System w/Hammer Arresters, 1/2" CPVC		MB1201HA	10
82916	Dual Box System w/Hammer Arresters, 1/2" F1807		MB1202HA	10
83021	Dual Box System w/Hammer Arresters, 1/2" F3347		MB1222HA	10
82917	Dual Box System w/Hammer Arresters, 1/2" F1960		MB1211HA	10
83021	Dual Box System w/Hammer Arresters, 1/2" F3347		MB1222HA	10
83174	Dual Box System w/Hammer Arresters, 1/2" REHAU EVERLOC+™		MB1205HA	10
Hammer Arrester Contractor Packs				
82918	Dual Box System w/Hammer Arresters, 1/2" Sweat		MB1200HACP	10
82919	Dual Box System w/Hammer Arresters, 1/2" CPVC		MB1201HACP	10
82920	Dual Box System w/Hammer Arresters, 1/2" F1807		MB1202HACP	10
82921	Dual Box System w/Hammer Arresters, 1/2" F1960		MB1211HACP	10
82954	Dual Box System Single Lever w/Hammer Arresters, 1/2" F1960		MB1211SLHACP	10
83175	Dual Box System w/Hammer Arresters, 1/2" REHAU EVERLOC+™		MB1205HACP	10
82938	Replacement Faceplate ¹		MBS1200DB1	1



¹Faceplates are Category *

Weld-On®
Guy Gray®
Water-Tite®
ToughPans®
RTB
Test-Tite®
AB&A®
Studor®
Truebro®
Christy's®
FloodStop®
ProVent®
ProSet®

MultiBox™ System - Washing Machine Outlet Box (Box Only)

- Integrated mounting flanges - no clips to lose or hassle with
- Top and bottom stabilizer bar slots
- Optional nail slots
- Nine valve knock-outs in box only
- Two drain knock-outs: 2" in standard washing machine drain, optional 1" to pipe valve box to DWV system
- Integrated drain knock outs will not fall down the drain after DWV test
- Anti-rotational valve design
- Forged brass qtr-turn valves
- MultiBox faceplates fit any MultiBox configuration, including fire-rated
- All faceplates fit up to two sheets of 5/8" drywall
- Standard faceplate includes cable tie bosses to secure drain hose



82938

PRODUCT	DESCRIPTION	MODEL	UNITS/CASE
82938	MultiBox Box Only Open Frame	MBS1200DB1	10
82948	MultiBox Box Only Solid Frame	MBS1200DB2	10
82949	MultiBox Box Only Louvered Frame	MBS1200DB3	10
82952	MultiBox Box Only Open Frame, Contractor Pack	MBS1200DB1CP	10

MultiBox™ System - Ice Maker Outlet Box



82930

- Integrated mounting flanges - no clips to lose or hassle with
- Top and bottom stabilizer bar slots
- Optional nail slots
- 2" standard drain, for optional use
- Integrated drain knock outs will not fall down the drain after DWV test
- Anti-rotational valve design
- Forged brass qtr-turn valves
- MultiBox faceplates fit any MultiBox configuration, including fire-rated
- All faceplates fit up to two sheets of 5/8" drywall
- Valves are IAPMO listed to ASME A112.18.1 / CSA B125.1 and are NSF 61/NSF 372 compliant to lead leaching

LISTINGS	PRODUCT	DESCRIPTION	MODEL	UNITS/CASE
Standard Packs				
82922	1/4" Outlet, 1/2" Sweat		AB1200	10
82923	1/4" Outlet, 1/2" CPVC		AB1201	10
82924	1/4" Outlet, 1/2" F1807		AB1202	10
82925	1/4" Outlet, 1/2" F1960		AB1211	10
83029	1/4" Outlet, 1/2" F3347		AB1222	10
83378	1/4" Outlet, 1/2" REHAU EVERLOC+™		AB1205	10
Contractor Packs				
82926	1/4" Outlet, 1/2" Sweat		AB1200CP	10
82927	1/4" Outlet, 1/2" CPVC		AB1201CP	10
82928	1/4" Outlet, 1/2" F1807		AB1202CP	10
82929	1/4" Outlet, 1/2" F1960		AB1211CP	10
83379	1/4" Outlet, 1/2" REHAU EVERLOC+™		AB1205CP	10
Hammer Arrester Standard Packs				
82930	1/4" Outlet w/Hammer Arrester, 1/2" Sweat		AB1200HA	10
82931	1/4" Outlet w/Hammer Arrester, 1/2" CPVC		AB1201HA	10
82932	1/4" Outlet w/Hammer Arrester, 1/2" F1807		AB1202HA	10
83022	1/4" Outlet w/Hammer Arrester, 1/2" F3347		AB1222HA	10
82933	1/4" Outlet w/Hammer Arrester, 1/2" F1960		AB1211HA	10
83380	1/4" Outlet w/Hammer Arrester, 1/2" REHAU EVERLOC+™		AB1205HA	10
Hammer Arrester Contractor Packs				
82934	1/4" Outlet w/Hammer Arrester, 1/2" Sweat		AB1200HACP	10
82935	1/4" Outlet w/Hammer Arrester, 1/2" CPVC		AB1201HACP	10
82936	1/4" Outlet w/Hammer Arrester, 1/2" F1807		AB1202HACP	10
82937	1/4" Outlet w/Hammer Arrester, 1/2" F1960		AB1211HACP	10
83381	1/4" Outlet w/Hammer Arrester, 1/2" REHAU EVERLOC+™		AB1205HACP	10
82938	Replacement Faceplate ¹		MBS1200DB1	1



¹Faceplates are Category *

Weld-On®
Guy Gray®
Water-Tite®
ToughPans®
RTB
Test-Tite®
AB&A®
Studor®
Truebro®
Christy's®
FloodStop®
ProVent®
ProSet®

MultiBox™ System - Specialty Outlet Boxes

- Integrated mounting flanges - no clips to lose or hassle with
- Top and bottom stabilizer bar slots
- Optional nail slots
- Extra large faceplate comes standard with kitchen boxes providing breaklines for custom fit to cabinetry and an extra 1" coverage for potential rough cuts
- MultiBox faceplates fit any MultiBox configuration, including fire-rated
- Anti-rotational valve design
- All faceplates fit up to two sheets of 5/8" drywall
- MultiBox Dishwasher/Commercial Ice Maker boxes can be inverted to utilize the 2" drain
- Standard and deep faceplates include cable tie bosses to secure drain hose
- Valves are IAPMO listed to ASME A112.18.1 / CSA B125.1 and are NSF 61/NSF 372 compliant to lead leaching
- Forged brass qtr-turn valves
- MultiBox Dishwasher/Commercial Ice Maker boxes can be inverted to utilize the 2" drain

LISTINGS	PRODUCT	DESCRIPTION	MODEL	UNITS/CASE
Kitchen Outlet Boxes				
83195	Three 3/8" Outlet Valves, 1/2" Sweat		ASDW1200	10
83196	Three 3/8" Outlet Valves, 1/2" CPVC		ASDW1201	10
83197	Three 3/8" Outlet Valves, 1/2" F1807		ASDW1202	10
83198	Three 3/8" Outlet Valves, 1/2" F1960		ASDW1211	10
Kitchen Outlet Boxes with Hammer Arresters				
83199	Three 3/8" Outlet Valves, Includes One Integral HA, 1/2" Sweat		ASDW1200HA	10
83206	Three 3/8" Outlet Valves, Includes One Integral HA, 1/2" CPVC		ASDW1201HA	10
83207	Three 3/8" Outlet Valves, Includes One Integral HA, 1/2" F1807		ASDW1202HA	10
83208	Three 3/8" Outlet Valves, Includes One Integral HA, 1/2" F1960		ASDW1211HA	10
Angle Stop Boxes				
83187	Two 3/8" Outlet Valves, 1/2" Sweat		AS1200	10
83188	Two 3/8" Outlet Valves, 1/2" CPVC		AS1201	10
83189	Two 3/8" Outlet Valves, 1/2" F1807		AS1202	10
83190	Two 3/8" Outlet Valves, 1/2" F1960		AS1211	10
Dishwasher/Commercial Ice Maker Outlet Boxes				
83191	3/8" Outlet Valve w/ Hammer Arrester, 1/2" Sweat		DW1200HA	10
83192	3/8" Outlet Valve w/ Hammer Arrester, 1/2" CPVC		DW1201HA	10
83193	3/8" Outlet Valve w/ Hammer Arrester, 1/2" F1807		DW1202HA	10
83194	3/8" Outlet Valve w/ Hammer Arrester, 1/2" F1960		DW1211HA	10
82974	Replacement Faceplate ¹		MBF1233	1



83197



83207



83187



83191

¹Faceplates are Category *

MultiBox™ System - Specialty Outlet Boxes



83183

- Integrated mounting flanges - no clips to lose or hassle with
- Top and bottom stabilizer bar slots
- Optional nail slots
- MultiBox faceplates fit any MultiBox configuration, including fire-rated

- Anti-rotational valve design
- All faceplates fit up to two sheets of 5/8" drywall
- Standard faceplate includes cable tie bosses to secure drain hose
- Valves are CSA listed to ANSI Z21/CSA9.1
- Forged brass qtr-turn valves

LISTINGS	PRODUCT	DESCRIPTION	MODEL	UNITS/CASE
Toilet Connection Boxes				
	83183	3/8" Outlet Valve, 1/2" Sweat	TC1200	10
	83184	3/8" Outlet Valve, 1/2" CPVC	TC1201	10
	83185	3/8" Outlet Valve, 1/2" F1807	TC1202	10
	83186	3/8" Outlet Valve, 1/2" F1960	TC1211	10
Gas Outlet Boxes				
	82940	1/2" IPS Gas Valve	MBG1212IP	10
	82941	1/2" Female Gas Valve CSST	MBG1212CSST	10
	82942	3/4" IPS Gas Valve	MBG1234IP	10
	82938	Replacement Faceplate ¹	MBS1200DB1	1



82940

Studor® Air Admittance Valve Box Kit



82939

- Integrated mounting flanges - no clips to lose or hassle with
- Top and bottom stabilizer bar slots
- Optional nail slots
- MultiBox faceplates fit any MultiBox configuration, including fire-rated

- All faceplates fit up to two sheets of 5/8" drywall
- Only receives the Redi-Vent
- Box is IAPMO Listed; see "Redi-Vent®" on page 248 for Redi-Vent listings and certifications

LISTINGS	PRODUCT	DESCRIPTION	MODEL	UNITS/CASE
	82939	Aux. Drain Box, Redi-Vent, Louvered Frame	MBS1200AAV	10
	82947	Replacement Louvered Faceplate	MBF1222	1

¹Faceplates are Category *



Auxiliary Drain Adapter

- Snaps into drain box
- Provides a 1" air gap and can be used with the washing machine drain hose
- Can accommodate up to three auxiliary drain lines from low volume appliances

PRODUCT	DESCRIPTION	MODEL	UNITS/CASE
82943	MultiBox Aux Drain Adapter	MB1250AD	10



Water Softener Drain Adapter

- Contains integral pipe retainer
- Provides a 1" air gap and can be used with the washing machine drain hose
- Can accommodate one drain line up to 7GPM

PRODUCT	DESCRIPTION	MODEL	UNITS/CASE
82944	MultiBox Water Softener Drain	MB1250WS	10



MultiBox™ System - Faceplates

- Available in standard, louvered and solid
- All faceplates fit any MultiBox configuration including fire-rated
- All faceplates fit up to two sheets of 5/8" drywall
- Standard faceplate includes cable tie bosses to secure drain hose
- Standard frame available in an extra deep option
- Extra deep faceplate comes standard with kitchen boxes
- Separate adapter not required for 2-hour fire wall
- Trim flange provides extra 1" coverage for potential cabinet rough cuts
- Three optional breaklines allow for custom fit cabinetry

PRODUCT	DESCRIPTION	MODEL	UNITS/CASE
Faceplates Only			
82945	MultiBox Faceplate Open	MBF1200	10
82946	MultiBox Faceplate Solid	MBF1211	10
82947	MultiBox Faceplate Louvered	MBF1222	10
82974	MultiBox Faceplate, Extra Deep	MBF1233	10
82977	MultiBox FR Faceplate Open	MBFRF1200	10

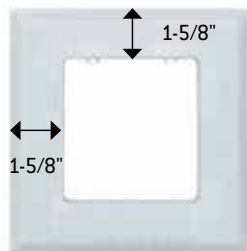

MultiBox™ System - Fire-rated Washing Machine Outlet Boxes



83036

- Intumescent pad attached to back of outlet box
- 1hr & 2hr rated
- ETL Listed
- For top mount water supply
- Integrated mounting flanges - no clips to lose or hassle with
- Top and bottom stabilizer bar slots
- Optional nail slots
- Water softener drain adapter can be used in this configuration (See page 97)
- Integrated drain knock outs will not fall down the drain after DWV test
- Anti-rotational valve design
- Forged brass qtr-turn valves
- MultiBox faceplates fit any MultiBox configuration, including fire-rated
- All faceplates fit up to two sheets of 5/8" drywall
- Standard faceplate includes cable tie bosses to secure drain hose



83044

LISTINGS	PRODUCT	DESCRIPTION	MODEL	UNITS/CASE
Standard Packs				
	83036	Single Box System, 1/2" Sweat	MBFRS1200	10
	83037	Single Box System, 1/2" CPVC	MBFRS1201	10
	83038	Single Box System, 1/2" F1807	MBFRS1202	10
	83039	Single Box System, 1/2" F1960	MBFRS1211	10
	83388	Single Box System, 1/2" F3347	MBFRS1222	10
	83326	Single Box System, 1/2" REHAU EVERLOC+™	MBFRS1205	10
Contractor Packs				
	83040	Single Box System, 1/2" Sweat	MBFRS1200CP	10
	83041	Single Box System, 1/2" CPVC	MBFRS1201CP	10
	83042	Single Box System, 1/2" F1807	MBFRS1202CP	10
	83043	Single Box System, 1/2" F1960	MBFRS1211CP	10
	83327	Single Box System, 1/2" REHAU EVERLOC+™	MBFRS1205CP	10
Hammer Arrester Standard Packs				
	83044	Single Box System w/Hammer Arresters, 1/2" Sweat	MBFRS1200HA	10
	83045	Single Box System w/Hammer Arresters, 1/2" CPVC	MBFRS1201HA	10
	83046	Single Box System w/Hammer Arresters, 1/2" F1807	MBFRS1202HA	10
	83372	Single Box System w/Hammer Arresters, 1/2" F3347	MBFRS1222HA	10
	83047	Single Box System w/Hammer Arresters, 1/2" F1960	MBFRS1211HA	10
	83328	Single Box System w/Hammer Arresters, 1/2" REHAU EVERLOC+™	MBFRS1205HA	10
Hammer Arrester Contractor Packs				
	83048	Single Box System w/Hammer Arresters, 1/2" Sweat	MBFRS1200HACP	10
	83049	Single Box System w/Hammer Arresters, 1/2" CPVC	MBFRS1201HACP	10
	83050	Single Box System w/Hammer Arresters, 1/2" F1807	MBFRS1202HACP	10
	83051	Single Box System w/Hammer Arresters, 1/2" F1960	MBFRS1211HACP	10
	83329	Single Box System w/Hammer Arresters, 1/2" REHAU EVERLOC+™	MBFRS1205HACP	10
	82938	Replacement Faceplate ¹	MBS1200DB1	1



¹Faceplates are Category *

MultiBox™ System - Fire-rated Washing Machine Outlet Boxes with Auxiliary Drain Boxes

- Intumescent pad attached to back of each outlet box
- 1hr & 2hr rated
- ETL Listed
- Top and bottom stabilizer bar slots
- Optional nail slots
- Two drain knock-outs: 2" in standard washing machine drain, optional 1" to pipe valve box to DWV system
- Integrated drain knock outs will not fall down the drain after DWV test
- Anti-rotational valve design
- Forged brass qtr-turn valves
- MultiBox faceplates fit any MultiBox configuration, including fire-rated
- All faceplates fit up to two sheets of 5/8" drywall
- Standard faceplate

LISTINGS	PRODUCT	DESCRIPTION	MODEL	UNITS/CASE
Standard Packs				
	83052	Dual Box System, 1/2" Sweat	MBFR1200	10
	83053	Dual Box System, 1/2" CPVC	MBFR1201	10
	83054	Dual Box System, 1/2" F1807	MBFR1202	10
	83055	Dual Box System, 1/2" F1960	MBFR1211	10
	83389	Dual Box System, 1/2" F3347	MBFR1222	10
	83332	Dual Box System, 1/2" REHAU EVERLOC+™	MBFR1205	10
Contractor Packs				
	83056	Dual Box System, 1/2" Sweat	MBFR1200CP	10
	83057	Dual Box System, 1/2" CPVC	MBFR1201CP	10
	83058	Dual Box System, 1/2" F1807	MBFR1202CP	10
	83059	Dual Box System, 1/2" F1960	MBFR1211CP	10
	83321	Dual Box System, Single Lever 1/2" F1960	MBFR1211SLCP	10
	83333	Dual Box System, 1/2" REHAU EVERLOC+™	MBFR1205CP	10
Hammer Arrester Standard Packs				
	83060	Dual Box System w/Hammer Arresters, 1/2" Sweat	MBFR1200HA	10
	83061	Dual Box System w/Hammer Arresters, 1/2" CPVC	MBFR1201HA	10
	83062	Dual Box System w/Hammer Arresters, 1/2" F1807	MBFR1202HA	10
	83373	Dual Box System w/Hammer Arresters, 1/2" F3347	MBFR1222HA	10
	83063	Dual Box System w/Hammer Arresters, 1/2" F1960	MBFR1211HA	10
	83334	FR MultiBox WMOB REHAU EVERLOC+™	MBFR1205HA	10
Hammer Arrester Contractor Packs				
	83064	Dual Box System w/Hammer Arresters, 1/2" Sweat	MBFR1200HACP	10
	83065	Dual Box System w/Hammer Arresters, 1/2" CPVC	MBFR1201HACP	10
	83066	Dual Box System w/Hammer Arresters, 1/2" F1807	MBFR1202HACP	10
	83067	Dual Box System w/Hammer Arresters, 1/2" F1960	MBFR1211HACP	10
	83335	Dual Box System w/Hammer Arresters, 1/2" REHAU EVERLOC+™	MBFR1205HACP	10
	83325	Dual Box System w/Hammer Arresters, Single Lever 1/2" F1960	MBFR1211SLHACP	10
FR Auxiliary Drain Box Only				
	83068	Drain Box Only, Open Frame	MBFRS1200DB1	10
	82945	Replacement Faceplate ¹	MBF1200	1
	83086	Drain Box Only, Solid Frame	MBFRS1200DB2	10
	82946	Replacement Faceplate ¹	MBF1211	1
	83087	Drain Box Only, Louvered Frame	MBFRS1200DB3	10
	82947	Replacement Faceplate Louvered ¹	MBF1222	1



83052



83053



83055



83060



83062



83068

¹ Faceplates are Category *

Weld-On®
Guy Gray®
Water-Tite®
ToughPans®
RTB
Test-Tite®
AB&A®
Studor®
Trubro®
Christy's®
FloodStop®
ProVent®
ProSet®

MultiBox™ System - Fire-rated Ice Maker Outlet Box

- Intumescent pad attached to back of outlet box
- 1hr & 2hr rated
- ETL Listed
- Integrated mounting flanges - no clips to lose or hassle with
- Top and bottom stabilizer bar slots
- Optional nail slots
- 2" standard drain, for optional use
- Integrated drain knock outs will not fall down the drain after DWV test
- Anti-rotational valve design
- Forged brass qtr-turn valves
- MultiBox faceplates fit any Multibox configuration, including fire-rated
- All faceplates fit up to two sheets of 5/8" drywall
- Valves are IAPMO listed to ASME A112.18.1 / CSA B125.1 and are NSF 61/NSF 372 compliant to lead leaching



83069



83077



LISTINGS	PRODUCT	DESCRIPTION	MODEL	UNITS/CASE
Standard Packs				
83069	1/4" Outlet, 1/2" Sweat		MBFRAB1200	10
83070	1/4" Outlet, 1/2" CPVC		MBFRAB1201	10
83071	1/4" Outlet, 1/2" F1807		MBFRAB1202	10
83072	1/4" Outlet, 1/2" F1960		MBFRAB1211	10
83390	1/4" Outlet, 1/2" F3347		MBABFR1222	10
83338	1/4" Outlet Valve, 1/2" REHAU EVERLOC+™		MBFRAB1205	10
Contractor Packs				
83073	1/4" Outlet, 1/2" Sweat		MBFRAB1200CP	10
83074	1/4" Outlet, 1/2" CPVC		MBFRAB1201CP	10
83075	1/4" Outlet, 1/2" F1807		MBFRAB1202CP	10
83076	1/4" Outlet, 1/2" F1960		MBFRAB1211CP	10
83339	1/4" Outlet Valve, 1/2" REHAU EVERLOC+™		MBFRAB1205CP	10
Hammer Arrester Standard Packs				
83077	1/4" Outlet w/ Hammer Arrester, 1/2" Sweat		MBFRAB1200HA	10
83078	1/4" Outlet w/ Hammer Arrester, 1/2" CPVC		MBFRAB1201HA	10
83079	1/4" Outlet w/ Hammer Arrester, 1/2" F1807		MBFRAB1202HA	10
83346	1/4" Outlet w/ Hammer Arrester, 1/2" F3347		MBFRAB1222HA	10
83080	1/4" Outlet w/ Hammer Arrester, 1/2" F1960		MBFRAB1211HA	10
83340	Three 1/4" Outlet Valve, Includes One Integral HA, 1/2" REHAU EVERLOC+™		MBFRAB1205HA	10
Hammer Arrester Contractor Packs				
83081	1/4" Outlet w/ Hammer Arrester, 1/2" Sweat		MBFRAB1200HACP	10
83082	1/4" Outlet w/ Hammer Arrester, 1/2" CPVC		MBFRAB1201HACP	10
83083	1/4" Outlet w/ Hammer Arrester, 1/2" F1807		MBFRAB1202HACP	10
83084	1/4" Outlet w/ Hammer Arrester, 1/2" F1960		MBFRAB1211HACP	10
83341	1/4" Outlet Valve, Includes One Integral HA, 1/2" REHAU EVERLOC+™		MBFRAB1205HACP	10
82945	Replacement Faceplate ¹		MBF1200	1

¹Faceplates are Category *

MultiBox™ System - Fire-rated Specialty Outlet Boxes

- Intumescent pad attached to back of outlet box
- 1hr & 2hr rated
- ETL Listed
- Integrated mounting flanges - no clips to lose or hassle with
- Top and bottom stabilizer bar slots
- Optional nail slots
- Extra large faceplate comes standard with kitchen boxes providing breaklines for custom fit to cabinetry and an extra 1" coverage for potential rough cuts
- Forged brass qtr-turn valves
- Anti-rotational valve design
- MultiBox faceplates fit any MultiBox configuration, including fire-rated
- All faceplates fit up to two sheets of 5/8" drywall
- Standard and deep faceplates include cable tie bosses to secure drain hose
- Valves comply with the requirements of NSF 61-G and the "Reduction of Lead in Drinking Water Act"
- [Federal Public Law 111-380]
- MultiBox Dishwasher/Commercial Ice Maker boxes can be inverted to utilize the 2" drain



83310



83093

LISTINGS	PRODUCT	DESCRIPTION	MODEL	UNITS/CASE
	83310	Three 3/8" Outlet Valves, 1/2" Sweat	FRASDW1200	10
	83311	Three 3/8" Outlet Valves, 1/2" CPVC	FRASDW1201	10
	83312	Three 3/8" Outlet Valves, 1/2" F1807	FRASDW1202	10
	83313	Three 3/8" Outlet Valves, 1/2" F1960	FRASDW1211	10
FR Kitchen Outlet Boxes with Hammer Arrester				
	83314	Three 3/8" Outlet Valves, Includes One Integral HA, 1/2" Sweat	FRASDW1200HA	10
	83315	Three 3/8" Outlet Valves, Includes One Integral HA, 1/2" CPVC	FRASDW1201HA	10
	83316	Three 3/8" Outlet Valves, Includes One Integral HA, 1/2" F1807	FRASDW1202HA	10
	83317	Three 3/8" Outlet Valves, Includes One Integral HA, 1/2" F1960	FRASDW1211HA	10
FR Angle Stop Boxes				
	83092	Two 3/8" Outlet Valves, 1/2" Sweat	FRAS1200	10
	83093	Two 3/8" Outlet Valves, 1/2" CPVC	FRAS1201	10
	83094	Two 3/8" Outlet Valves, 1/2" F1807	FRAS1202	10
	83095	Two 3/8" Outlet Valves, 1/2" F1960	FRAS1211	10
FR Dishwasher/Commercial Ice Maker Outlet Boxes with Hammer Arrester				
	83096	3/8" Outlet Valve w/ Hammer Arrester, 1/2" Sweat	FRDW1200HA	10
	83097	3/8" Outlet Valve w/ Hammer Arrester, 1/2" CPVC	FRDW1201HA	10
	83098	3/8" Outlet Valve w/ Hammer Arrester, 1/2" F1807	FRDW1202HA	10
	83099	3/8" Outlet Valve w/ Hammer Arrester, 1/2" F1960	FRDW1211HA	10
	82974	Replacement Faceplate ¹	MBF1222	1



¹Faceplates are Category *

MultiBox™ System - Fire-rated Specialty Outlet Boxes

Weld-On®
Guy Gray®
Water-Tite®
ToughPans®
RTB
Test-Tite®
AB&A®
Studor®
Truebro®
Christy's®
FloodStop®
ProVent®
ProSet®



- Intumescent pad attached to back of outlet box
- 1hr & 2hr rated
- ETL Listed
- Integrated mounting flanges - no clips to lose or hassle with
- Top and bottom stabilizer bar slots
- Optional nail slots
- Extra large faceplate comes standard with kitchen boxes providing breaklines for custom fit to cabinetry and an extra 1" coverage for potential rough cuts

- Forged brass qtr-turn valves
- Anti-rotational valve design
- MultiBox faceplates fit any MultiBox configuration, including fire-rated
- All faceplates fit up to two sheets of 5/8" drywall
- Standard faceplate includes cable tie bosses to secure drain hose
- Valves are CSA listed to ANSI Z21/CSA9.1



83088



83347

LISTINGS	PRODUCT	DESCRIPTION	MODEL	UNITS/CASE
FR Toilet Connection Boxes				
	83088	3/8" Outlet Valves, 1/2" Sweat	FRTC1200	10
	83089	3/8" Outlet Valves, 1/2" CPVC	FRTC1201	10
	83090	3/8" Outlet Valves, 1/2" F1807	FRTC1202	10
	83091	3/8" Outlet Valves, 1/2" F1960	FRTC1211	10
FR Gas Outlet Boxes				
	83347	1/2" Gas Valve	FRMBG1212IP	10
	83348	1/2" Gas Valve	FRMBG1212CSST	10
	83349	3/4" Gas Valve	FRMBG1234IP	10
	82945	Replacement Faceplate ¹	MBF1200	1

FR Studor® Air Admittance Valve Box Kit



83085

- Intumescent pad attached to back of outlet box
- 1hr & 2hr rated
- ETL Listed
- Integrated mounting flanges - no clips to lose or hassle with
- Top and bottom stabilizer bar slots
- Optional nail slots

- MultiBox faceplates fit any MultiBox configuration, including fire-rated
- Anti-rotational valve design
- All faceplates fit up to two sheets of 5/8" drywall
- Standard faceplate includes cable tie bosses to secure drain hose
- Box is IAPMO Listed; see "Redi-Vent®" on page 248 for Redi-Vent listings and certifications

LISTINGS	PRODUCT	DESCRIPTION	MODEL	UNITS/CASE
	83085	Aux. Drain Box, Redi-Vent, Louvered Frame	MBFRS1200AAV	10
	82947	Replacement Faceplate Louvered ¹	MBF1222	1

¹Faceplates are Category *

Hammer Arresters

Ignoring water hammer can lead to costly damage within any plumbing system. Water-Tite® “AA” Single Fixture Shock-Buster™ Hammer Arresters are the solution to eliminating water hammer in residential and light commercial supply lines. All our Hammer Arresters are manufactured to the highest standards that our customers have come to expect. Shock-Buster Hammer Arresters contain all the necessary approvals to pass code inspection in any territory. “AA” Hammer Arresters must be installed as close to the valve as possible; recommended to be no more than 6’ from the valve being protected.

- “AA” single fixture size
- Guaranteed for the lifespan of the plumbing system
- UPC listed
- ASSE Certified to ASSE 1010-2021 standard
- Approved for sealed wall installations with no access panel required
- May be installed at any angle
- Conforms to IPC Code



LISTINGS	PRODUCT	DESCRIPTION	MODEL	UNITS/CASE
	86600	3/4" x 3/4" Arrester For Washing Machine	86600	25
	86601	1/2" Male Sweat Arrester	86601	50
	86590	1/2" MIP Conx. Arrester (Lead-free)	86590	50
	86603	3/4" Male Sweat Arrester	86603	50
	86604	1/2" CPVC Socket Arrester	86604	50
	86624	1/2" CPVC Male Inlet Arrester	86624	50
	86592	1/4" x 1/4" Compression Tee Arrester (Lead-free)	86592	25
	86593	3/8" x 3/8" Compression Tee Arrester (Lead-free)	86593	25
	86595	3/8" x 3/8" Reverse Nut Tee Arrester (Lead-free)	86595	25
	86596	5/8" x 5/8" Reverse Nut Tee Arrester (Lead-free)	86596	25
	86598	1/2" x 1/2" F1807 Barb Tee Arrester (Lead-free)	86598	25
	86621	1/2" F1807 Barb Arrester	86621	50
	86599	1/2" x 1/2" F1960 Tee Arrester (Lead-free)	86599	25



86600



86595



86596



86598



86603



86590

Weld-On®
Guy Gray®
Water-Tite®
ToughPans®
RTB
Test-Tite®
AB&A®
Studer®
Truebro®
Christy's®
FloodStop®
ProVent®
ProSet®

PEX Bend Supports



- Provides versatile, rigid, 90-degree support for PEX tubing
- When snapped into PEX Bend Support Bracket, offers a full 360-degree rotation with positive locking at 45 degree intervals
- Reduces noise and vibration
- Plastic material eliminates cutting or scratching of tubing
- For residential or commercial applications
- Fits 3/8" and 1/2" tubing
- Offers three installation options – mounting directly to stud or overhead joist, through stabilizer bar, or snapped into PEX Bend Support Bracket

LISTINGS	PRODUCT	DESCRIPTION	MODEL	UNITS/CASE
	86673	1/2" PEX Bend Support, Ceiling/Stud Mount	PBS2	50
	86672	1/2" PEX Bend Support, Bar Mount	PBS1	100
	86652	18" PEX Support Bar	PS18	50
	86653	26" PEX Support Bar	PS26	50

Stabilizer Bar Kits



- Insulators are available for horizontal runs of 1/2" or 3/4" tube
- Supports all CTS tubing
- Kits include a 20" or 26" stabilizer bar, 2 tube insulators and 4 nails
- Horizontal insulators are available in CPVC
- Impact-resistant to 0°F [-18°C] Max temp: 160°F [71°C] continuous

LISTINGS	PRODUCT	DESCRIPTION	MODEL	UNITS/CASE
Horizontal Run Stabilizer Bar Kits				
	86694	20" Bar with Plastic Insulators for 1/2" CTS	S2012PH	50
	86696	20" Bar with Plastic Insulators for 3/4" CTS	S2034PH	50
	86698	26" Bar with Plastic Insulators for 1/2" CTS	S2612PH	50
	86699	26" Bar with Plastic Insulators for 3/4" CTS	S2634PH	50
Vertical Run Stabilizer Bar Kits				
86701	20" Bar with Plastic Insulators for 1/2" CTS	S2012PV	50	
86702	20" Bar with Plastic Insulators for 3/4" CTS	S2034PV	50	
86703	26" Bar with Plastic Insulators for 1/2" CTS	S2612PV	50	
86704	26" Bar with Plastic Insulators for 3/4" CTS	S2634PV	50	

Stabilizer Bars

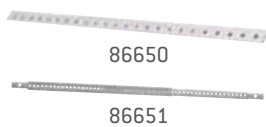

LISTINGS	PRODUCT	DESCRIPTION	MODEL	UNITS/CASE
	86650	20" Stabilizer Bar for 16" Stud Bays	S20	100
	86655	26" Stabilizer Bar for 24" Stud Bays	S26	100
	86651	MultiBox Adjustable Stabilizer Bar for 16" Stud Bays	MBSSB	100

Plastic Stabilizer Insulators



- Plastic insulators are available for vertical and horizontal tube runs
- Horizontal insulators fit 1/2" and 3/4" tube
- Vertical insulators fit 1/2" or 3/4" tube
- To be used with stabilizer bar
- Impact-resistant to 0°F [-18°C] Max temp: 160°F [71°C] continuous
- Stabilizers covered by one or more of the following U.S. Patents: 5,154,375; 5,236,158; 5,230,488; 5,267,710; 5,370,345

PRODUCT	DESCRIPTION	MODEL	UNITS/CASE
86670	Plastic Horizontal Insulators for 1/2" CTS (50/Bag)	S12PH	200
86675	Plastic Horizontal Insulators for 3/4" CTS (50/Bag)	S34PH	200
86685	Plastic Vertical Insulators for 1/2" CTS (50/Bag)	S12PV	200
86690	Plastic Vertical Insulators for 3/4" CTS (50/Bag)	S34PV	200

HangerLok® "Push-to-lock" clamps

- Single pre-loaded nail and ergonomic design that allows a single plumber to do the job
- "Push-to-loc" feature that secure the pipe
- Compatible with any and all pipe, tubing conduit & cable systems
- Corrosion and UV resistant
- Performance clamps allow for expansion and contraction

- Sizes ranging from 1/2" up to 4" in diameter
- Can be mounted to a myriad of different substrates ranging from wood, steel, concrete, masonry, strut, threaded pipe, and more.
- Made in the USA product and has the BABA (Buy America-Build America) act certification

PRODUCT	DESCRIPTION	MODEL	UNITS/CASE
Clamps			
84350	HL Clamp 12mm, Nylon	H8812L0K	100
84351	HL Clamp, 15mm, Nylon	H8815L0K	100
84352	HL Clamp, 17mm, Nylon	H8817L0K	100
84353	HL Clamp, 20mm, Nylon	H8820L0K	100
84354	HL Clamp, 22mm, Nylon	H8822L0K	100
84355	HL Clamp, 25mm, Nylon	H8825L0K	50
84356	HL Clamp, 28mm, Nylon	H8828L0K	50
84357	HL Clamp, 32mm, Nylon	H8832L0K	50
84358	HL Clamp, 36mm, Nylon	H8836L0K	50
84359	HL Clamp, 40mm, Nylon	H8840L0K	25
84360	HL Clamp, 47mm, Nylon	H8847L0K	25
84361	HL Clamp, 51mm, Nylon	H8851L0K	25
84362	HL Clamp, 59mm, Nylon	H8859L0K	20
84363	HL Clamp, 71mm, Nylon	H8871L0K	25
84364	HL Clamp, 80mm, Nylon	H8880L0K	25
84365	HL Clamp, 113mm, Nylon	H88113L0K	25
Strutcatcher			
84366	HL Strutcatcher	LT109	100
Flanges			
84368	HL Thread, 1/4" thread	F285914	100
84369	HL Thread, 3/8" thread	F325938	100
84370	HL Thread, 3/8" thread	F7111338	25
84371	HL Thread, 1/2" thread	F7111312	25
Spacers			
84372	45 mm Spacer	LT8845	100
84373	85 mm Spacer	LT8885	50



84363 (open)



84363 (closed)



84371



84373

Combination Clamps

Suspension Insulator

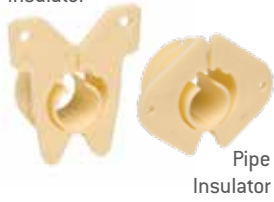

Pipe Insulator

Suspension Clamp



Half Clamp

- Plastic full clamp preloaded with nail
- Supports 1/2", 3/4" and 1" copper tube size
- Supports all CTS tubing
- Impact-resistant to 0°F [-18°C] Max temp: 160°F continuous

LISTINGS	PRODUCT	DESCRIPTION	MODEL	UNITS/CASE
	82864	Combination Half, Supports 1/2" & 3/4", with Preloaded Nail (100/Bag)	CH1234	1000
	82865	Combination Half, Supports 3/4" IPS / 1.250" CTS, with Preloaded Nail (25/Bag)	CH34114	100
UPC	82957	Combination Suspension, Supports 1/2" & 3/4" CTS (100/Bag)	CI31234	1000
	82979	Combination Suspension/Insulator, Supports 1/2" & 3/4" CTS (50/Bag)	CI1341234	500
	83015	Combination Two Hole, Supports 1/2" & 3/4" CTS (100/Bag)	CC61234	1000
	82972	Combination Pipe Insulator, Supports 1/2" & 3/4" CTS (50/Bag)	CI41234	500

Half Clamps

- Plastic half clamp preloaded with nail
- Supports copper and PEX tubing
- Not recommended for CPVC tubing
- Impact-resistant to 0°F [-18°C] Max temp: 160°F continuous

LISTINGS	PRODUCT	DESCRIPTION	MODEL	UNITS/CASE
Standard Packs				
	82846	Supports 3/8" CTS, with Preloaded Nail (100/Bag)	H138	1000
	82850	Supports 1/2" CTS, with Preloaded Nail (50/Bag)	H112	2000
UPC	82855	Supports 3/4" CTS, with Preloaded Nail (50/Bag)	H134	1000
	82860	Supports 1" CTS, with Preloaded Nail (50/Bag)	H101	500
Display Packs				
	82840	Supports 1/2" CTS, with Preloaded Nail (5/Bag)	RH112C	10
	82845	Supports 3/4" CTS, with Preloaded Nail (5/Bag)	RH134C	10



82846

Clamp-Tite Full Clamps

- Plastic full clamp preloaded with nail
- Supports 1/2", 3/4" and 1" copper tube size
- Supports all CTS tubing
- Impact-resistant to 0°F (-18°C) Max temp: 160°F continuous

LISTINGS	PRODUCT	DESCRIPTION	MODEL	UNITS/CASE
	83795	Supports 1/2" CTS, with Preloaded Nail (100/Bag)	F212	1000
	83800	Supports 3/4" CTS, with Preloaded Nail (50/Bag)	F234	500
	83805	Supports 1" CTS, with Preloaded Nail (25/Bag)	F201	250



83805

Full Clamps

- 1/2", 3/4", 1" CTS with pre-loaded nails
- Isolates supply tubing from wood framing
- Impact-resistant to 0°F (-18°C)
- Maximum temp. 160°F continuous
- Supports all CTS tubing

LISTINGS	PRODUCT	DESCRIPTION	MODEL	UNITS/CASE
	83797	Supports 1/2" CTS, with Preloaded Nail (100/Bag)	F212LF	500
	83798	Supports 3/4" CTS, with Preloaded Nail (50/Bag)	F234LF	500
	83799	Supports 1" CTS, with Preloaded Nail (25/Bag)	F201LF	250



83798

Single Shot® Insulating Suspension Clamps

- Pre-loaded nail
- Easy installation snaps onto any CTS pipe system to provide a hands free installation
- Reduces noise caused by expansion and contraction
- Supports all CTS tubing
- Impact-resistant to 0°F (-18°C) Max Temp: 160°F continuous

LISTINGS	PRODUCT	DESCRIPTION	MODEL	UNITS/CASE
	82980	1/2" Single Shot Insulator with Preloaded Nail (50/bag)	SS512	1000
	82981	3/4" Single Shot Insulator with Preloaded Nail (50/bag)	SS534	1000
	82982	1" Single Shot Insulator with Preloaded Nail (50/bag)	SS501	500



82980

Insulating Suspension Clamps

- Plastic insulating suspension clamp reduces noise from tubing expansion and contraction
- Supports copper, PEX and ideally isolates CPVC tubing from wood
- Impact-resistant to 0°F (-18°C) Max temp: 160°F (71°C) continuous
- Supports all CTS tubing

LISTINGS	PRODUCT	DESCRIPTION	MODEL	UNITS/CASE
	82951	Supports 1/2" CTS (50/Bag)	I312	2000
	82955	Supports 3/4" CTS (50/Bag)	I334	1000
	82960	Supports 1" CTS (50/Bag)	I301	500
	82961	Supports 1-1/4" CTS (50/Bag)	I314	250
	82962	Supports 1-1/2" CTS (25/Bag)	I315	250
	82963	Supports 2" CTS (25/Bag)	I320	250



82957

Right Strap™ Multi-Functional Pipe Clamps



82852



- Patent # 6,073,891
- Installs 2 ways – half clamp, full clamp
- For all metal and plastic 1/2", 3/4" and 1" copper tube size materials
- Supports all CTS tubing

- Factory-assembled for half-clamp installation
- Allows for expansion and contraction of supply tubing
- Greatly reduces the chance for noise common to overly restrictive systems
- No pinning, no binding, no complaints!

LISTINGS	PRODUCT	DESCRIPTION	MODEL	UNITS/CASE
Standard Packs				
82852		Supports 1/2" CTS, with Preloaded Nail (50/Bag)	82852	2000
82854		Supports 3/4" CTS, with Preloaded Nail (50/Bag)	82854	1000
82856		Supports 1" CTS, with Preloaded Nail (50/Bag)	82856	500
Display Packs				
82841		Supports 1/2" CTS, with Preloaded Nail (5/Bag)	82841	10
82842		Supports 3/4" CTS, with Preloaded Nail (5/Bag)	82842	10



Two-Hole Pipe Clamps



83015



83003

- Plastic Two-Hole pipe clamp reduces noise from tubing expansion and contraction
- Isolates CPVC tubing from wood

- Impact-resistant to 0°F (-18°C) Max temp: 160°F continuous
- Supports all CTS tubing

LISTINGS	PRODUCT	DESCRIPTION	MODEL	UNITS/CASE
83003		Supports 1/2" CTS (100/Bag)	C612	2000
83008		Supports 3/4" CTS (100/Bag)	C634	1000
83010		Supports 1" CTS (50/Bag)	C601	500
83012		Supports 1-1/4" CTS (50/Bag)	C614	250
83013		Supports 1-1/2" CTS (25/Bag)	C615	250
83014		Supports 2" CTS (25/Bag)	C620	250



Weld-On®
Guy Gray®
Waater-Tite®
ToughPans®
RTB
Test-Tite®
AB&A®
Studor®
Truebro®
Christy's®
FloodStop®
ProVent®
ProSet®

Pipe Insulators

- Plastic pipe insulator reduces noise from tubing expansion and contraction
- Supports tubing from wood
- Fits 1-3/8" hole
- Impact-resistant to 0°F (-18°C) Max temp: 160°F continuous
- Supports all CTS tubing

LISTINGS	PRODUCT	DESCRIPTION	MODEL	UNITS/CASE
Standard Packs				
	82965	Supports 1/2" CTS (25/Bag)	I412	1000
	82970	Supports 3/4" CTS (25/Bag)	I434	1000
	82975	Supports 1" CTS (25/Bag)	I401	1000
Display Packs				
	82966	Supports 1/2" CTS (5/Bag)	RI412C	10
	82971	Supports 3/4" CTS (5/Bag)	RI434C	10



82965

Long Pattern Pipe Insulators

- Long Pattern insulators isolates supply tube from wood
- Supports all CTS tubing
- Impact-resistant to 0°F (-18°C) Max temp: 160°F continuous

LISTINGS	PRODUCT	DESCRIPTION	MODEL	UNITS/CASE
	82967	1/2" Long Pattern Insulator/Gray/25 bag	82967	1000



82967

Metal Stud Insulators

- For use in metal studs and galvanized super-tight brackets
- Plastic pipe insulator reduces noise from tubing expansion and contraction
- Impact-resistant to 0°F (-18°C) Max temp: 160°F continuous
- Supports copper, CPVC and PEX tubing through metal studs
- Fits 1-11/32" hole

PRODUCT	DESCRIPTION	MODEL	UNITS/CASE
89148	Supports 3/8", 1/2", 3/4" CTS (50/Bag)	MS11	500
89150	Supports 1/2" CTS (100/Bag)	MS13	1000
89151	Supports 3/4" CTS (100/Bag)	MS14	1000
89152	Supports 1" CTS (50/Bag)	MS15	500



89148



89150

Metal Stud Insulators For CPVC Piping



89158

- CPVC Pipe can be cemented to insulator
- Isolates supply tubing from metal studs
- Impact-resistant to 0°F (-18°C) Max Temp: 160°F (71°C) continuous
- Plastic metal stud insulators
- Compatible with CPVC pipe
- Fits 1-11/32" hole

PRODUCT	DESCRIPTION	MODEL	UNITS/CASE
89158	Supports 1/2" CTS (100/Bag)	MSI6	200
89161	Supports 3/4" CTS (100/Bag)	MSI7	200

Metal Stud Insulators For DWV Piping



89165

- Plastic metal stud insulators for DWV piping
- Isolates DWV piping from metal studs
- Impact-resistant to 0°F (-18°C) Max Temp: 160°F (71°C) continuous
- Fits 2-5/8" Hole

PRODUCT	DESCRIPTION	MODEL	UNITS/CASE
89165	Supports 1-1/2" DWV in metal studs (25 per bag)	MSI15	500
89166	Supports 2" DWV in metal studs (25 per bag)	MSI20	500

Metal Stud Punch



89160

- Lightweight, high-strength
- Non-slip rubber grips

PRODUCT	DESCRIPTION	MODEL	UNITS/CASE
89160	Punch Offset head, 1-11/32" hole in up to 22ga; for 3/8" through 1" CTS Metal Stud Insulators	MSP1	1

Metal DWV Hanger with Plastic Sleeve

- Secures 1-1/2" – 4" DWV piping
- Galvanized
- 3/4" width
- Minimum 12" stem length
- Plastic sleeve provides additional pipe protection

PRODUCT	DESCRIPTION	MODEL	UNITS/CASE
82834	1-1/2" Galvanized DWV hanger with plastic sleeve, 3/4" width	MH421	50
82835	2" Galvanized DWV hanger with plastic sleeve, 3/4" width	MH422	50
82836	3" Galvanized DWV hanger with plastic sleeve, 3/4" width	MH423	50
82837	4" Galvanized DWV hanger with plastic sleeve, 3/4" width	MH424	50



82836

Metal DWV Hanger without Plastic Sleeve

- Secures 1-1/2" – 4" DWV piping
- Galvanized, uncoated
- 3/4" width

PRODUCT	DESCRIPTION	MODEL	UNITS/CASE
82830	1-1/2" Galvanized DWV hanger uncoated, 12" stem length	MH321	50
82831	2" Galvanized DWV hanger uncoated, 12" stem length	MH322	50
82832	3" Galvanized DWV hanger uncoated, 12" stem length	MH323	50
82833	4" Galvanized DWV hanger uncoated, 12" stem length	MH324	50
82838	1-1/2" Galvanized DWV hanger uncoated, 48" stem length	MH4821	25
82839	2" Galvanized DWV hanger uncoated, 48" stem length	MH4822	25
82843	3" Galvanized DWV hanger uncoated, 48" stem length	MH4823	25
82844	4" Galvanized DWV hanger uncoated, 48" stem length	MH4824	25



82832

Hang-Tite™ Pipe Holders



- New I-beam construction so shaft will not flex
- 3/4" snap lock saddle on 1-1/2" – 4" Hang-Tites
- Saddle wrap around exceeds 75% of pipe circumference to eliminate popouts
- Allows for expansion & contraction
- Nails attached to top of J-Hooks
- Nail holes spaced 1" apart on both sides of I-beam shaft
- High-impact-resistant ABS material
- For PVC or ABS schedule 40 DWV pipe
- Hang-Tite™ Extension available

PRODUCT	DESCRIPTION	MODEL	UNITS/CASE
White			
93140	1/2" CTS/5" Shank (25/Bag, w/Nails)	93140	200
93142	3/4" CTS/5" Shank (25/Bag, w/Nails)	93142	200
93144	1" CTS/5" Shank (25/Bag, w/Nails)	93144	200
93145	1-1/4" CTS/5" Shank (25/Bag, w/Nails)	93145	200
93150	1-1/2" Sch. 40 DWV/8" Shank 25 per bag w/nails attached	93150	200
93155	2" Sch. 40 DWV/8" Shank 25 per bag w/nails attached	93155	200
93160	3" Sch. 40 DWV/8" Shank 25 per bag w/nails attached	93160	200
93161	3" Sch. 30 DWV/8" Shank 25 per bag w/nails attached	93161	200
93165	4" Sch. 40 DWV/8" Shank 25 per bag w/nails attached	93165	100
Black			
93166	1-1/2" Sch. 40 DWV/8" Shank 25 per bag w/nails attached	93166	200
93167	2" Sch. 40 DWV/8" Shank 25 per bag w/nails attached	93167	200
93168	3" Sch. 40 DWV/8" Shank 25 per bag w/nails attached	93168	200
93169	4" Sch. 40 DWV/8" Shank 25 per bag w/nails attached	93169	100

Copper Clad Wire Pipe Hangers



- Copper-clad for corrosion resistance
- Self-nailing
- Heavy-gauge wire construction for suspending copper & CPVC tubing

PRODUCT	DESCRIPTION	MODEL	UNITS/CASE
83130	6" Suspension for 1/2" CTS (12/Bag)	RCPH12	50
83135	6" Suspension for 3/4" CTS (12/Bag)	RCPH34	50

Plastic Hanger Strapping

- Flexible, non-conductive, non-abrasive
- Can be cut with shears, snips or utility knife
- 3/4" wide, .050 thick with 1/8" holes spaced 3/4" apart
- Supports 25 lb. per section at 4-foot intervals

LISTINGS	PRODUCT	DESCRIPTION	MODEL	UNITS/CASE
	83030	10' Roll x 3/4"	RHS10	20
	83035	25' Roll x 3/4"	RHS25	20
	83025	100' Roll x 3/4"	HS1	20



83030

Galvanized Metal Hanger Strapping

- 24- & 28-gauge rolls
- 3/4" rolls in 10' lengths

PRODUCT	DESCRIPTION	MODEL	UNITS/CASE
84025	10' Roll x 3/4" (28-gauge)	RGS7	50
84030	10' Roll x 3/4" (24-gauge)	RGS8	50



84025

Sure-Tite™ Support Brackets

- Sure-Tite™ copper-plated brackets are available in two lengths, 20" & 26", for use in residential or commercial applications
- Can be nailed or screwed to wood or metal studs
- For use on lavatories, toilets, hose bibs, water heater or any water supply penetrating a wall
- Brackets available with several hole patterns depending on your need
- Simple installation, just nail bracket in place and solder the pipe to bracket
- Reduce cost in the field, less expense than fabricating brackets or cutting wood blocks
- Rigid installation

PRODUCT	DESCRIPTION	MODEL	UNITS/CASE
86618	20" Copper-plated w/1/2" holes/16-gauge	86618	50
86626	26" Copper-plated w/1/2" holes/16-gauge	86626	50
86619	20" Copper-plated w/1/2" extruded holes/16-gauge	86619	25
86718	20" Copper-plated w/1/2", 3/4" & 1" holes/16-gauge	86718	50
86726	26" Copper-plated w/1/2", 3/4" & 1" holes/18-gauge	86726	50
86614	18" Copper-plated w/1/2" snap-in, 3/4" & 1" holes/20-gauge	86614	50
86832	18" Galvanized w/1-11/32" holes for MSI insulators/20-gauge	86832	50
86632	26" Galvanized w/1-11/32" holes for MSI insulators/20-gauge	86632	50

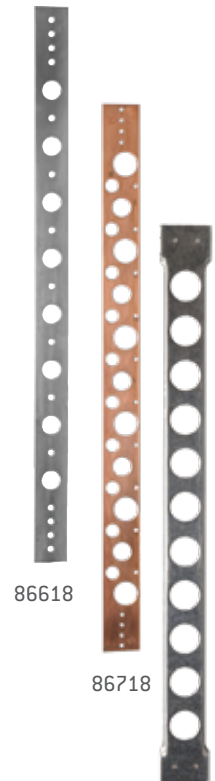

86618

86718

86632

Bathtub Protectors



83250

- Corrugated bed design for optimum protection
- Material: Polystyrene

PRODUCT	DESCRIPTION	MODEL	UNITS/CASE
83250	Standard Protector for 14" or 16" Deep Tubs (60" x 30")	TP1	35
83252	Standard Protector for 14" or 16" Deep Tubs (60" x 30")/Bulk pack on skid	TP1B	210
83255	Oval Protector for 16" Deep Tubs (60" x 42")	TP2	25
83253	Oval Protector for 16" Deep Tubs (60" x 42")/Bulk pack on skid	TP2B	200

Tub Boxes



83300



83302

- Plastic forms that create access for tub trap and drain in slab foundation. No concrete to chisel. Simply invert box over drain rough, pour slab and cut out box bottom prior to tub installation
- Creates access for tub trap & drain in slab foundation
- Material: Polystyrene

PRODUCT	DESCRIPTION	MODEL	UNITS/CASE
83301	Large 7" Deep Box 11-1/2" x 11-1/2" Bottom ID (13 x 13 Top ID)	TX1	20
83300	Small 6-1/2" Deep Box (12" x 8 1/8" Top OD)	TX2	20
83302	Heavy Duty 7-3/4" Deep Box (14-1/2" x 14-1/2" Top OD) Injection Molded, High Impact Plastic with Pipe Knockouts Compatible with 1-1/2" and 2" Pipe. Bottom Panel Scored for Easy Breakout.	TX3	5 Pair

Circular Valve Boxes



83350



83365

- Durable plastic construction
- Cover has snap-lock & lift-hold
- Lids available separately

PRODUCT	DESCRIPTION	MODEL	UNITS/CASE
Circular Valve Boxes			
83350	Small 6" Diameter Top OD w/Green Snap-in Lid	VB1	36
83353	7" Diameter Top OD w/Green Snap-in Lid	VB1S	1
83355	Large 10" Diameter Top OD w/Green Snap-in Lid	VB2	1
83354	Lid Only, 7" Diameter Top OD	VB1SL	60
83357	Lid Only, 10" Diameter Top OD	VB2L	1
Rectangular Meter Boxes			
83360	10" Box (12" x 10" Top OD) w/Green Snap-in Lid	VB3	1
83365	12" Standard Box (17-3/4" x 12-1/2" Top OD) w/Green Snap-in Lid	VB4	1
83366	6" Extension for 12" Standard Boxes	VB4X	1
83367	12" Jumbo Box (20 1/2" x 14-1/2" Top OD) w/Green Snap-in Lid	VB5	1
83369	6" Extension for Jumbo Meter Boxes	VB5X	1
83361	Lid Only, 10" Box	VB3L	1
83352	Lid Only, 12" Box	VB4L	1

Stud Guards and FHA Plates

- Self-anchoring galvanized steel plates (18-gauge)
- Prevents damage to piping & wiring from wallboard nails
- Fast & easy installation

PRODUCT	DESCRIPTION	MODEL	UNITS/CASE
84005	1-1/2" x 3" Galvanized Steel Stud Guard	RSG13	100
84010	1-1/2" x 5" Galvanized Steel Stud Guard	RSG15	100
84000	1-1/2" x 9" Galvanized Steel FHA Plate	RFHA1	100

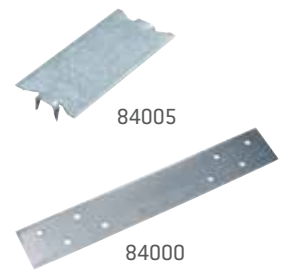

Pipe Sleeving

- Protects supply tubing in slab foundation
- Color coded – red for hot; blue for cold
- Available in .004, .006, .010 and .025 thickness

LISTINGS	PRODUCT	DESCRIPTION	MODEL	UNITS/CASE
	83405	Red .004 for 1/2" – 1" Tubing (200' Roll)	WTSR4	20
	83407	Blue .004 for 1/2" – 1" Tubing (200' Roll)	WTSB4	20
	83400	Red .006 for 1/2" – 1" Tubing (200' Roll)	WTSR	20
	83404	Blue .006 for 1/2" – 1" Tubing (200' Roll)	WTSB	20
	83409	Red .010 for 1/2" – 1" Tubing (100' Roll)	WTSR10	20
	83410	Blue .010 for 1/2" – 1" Tubing (100' Roll)	WTSB10	20
	83411	Black .006 for 1-1/4" – 2" Tubing (200' Roll)	WTSBK	10
	83412*	Red .025 Heavy Duty PVC for 1/2" – 3/4" Tubing (50' Roll)	WTSR2734	1
	83413*	Blue .025 Heavy Duty PVC for 1/2" – 3/4" Tubing (50' Roll)	WTSB2734	1
	83416	Red .025 Ultra-Flex Heavy for 1/2" – 1" Tubing (100' Roll)	WTSR32	1
	83417	Blue .025 Ultra-Flex Heavy for 1/2" – 1" Tubing (100' Roll)	WTSB32	1
	83418	Red .025 Ultra-Flex Heavy for 1/2" – 1" Tubing (50' Roll)	WTSR3210	1
	83419	Blue .025 Ultra-Flex Heavy for 1/2" – 1" Tubing (50' Roll)	WTSB3210	1



Ultra-Flex Heavy 25 mil. Pipe Sleeving is ideal for both CPVC and Copper Piping Systems.

* For use with Copper pipe only



84000



83410



83411

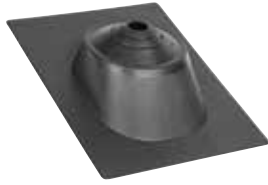

Weld-On®
Guy Gray®
Water-Tite®
ToughPans®
RTB
Test-Tite®
AB&A®
Studor®
Truebro®
Christy's®
FloodStop®
ProVent®
ProSet®

Multi-Size 4N1™, 3N1® and 3N4 Hard Plastic Base Roof Flashings



81709

- Adjustable multi-size flashing fits 1-1/4" – 3" and 3" – 4" vent pipe
- Tested for ultraviolet, ozone and weather resistance
- Elastomer collar heat tested to 180°F
- Approved for type "B" installations



LISTINGS	PRODUCT	DESCRIPTION	MODEL	UNITS/CASE
 	81709	12" x 16" Base for 1-1/4"–1-1/2", 2", 3", 4" Vent Pipe	HB41	20
	81700	11-1/8" x 15" Base for 1-1/4", 1-1/2", 2" or 3" Vent Pipe	HB31	20

Multi-Size 3N1® and 3N4 Flexible Plastic Base Roof Flashings



81705

- Adjustable multi-size flashing fits 1-1/4" – 3" and 3" – 4" vent pipe
- Tested for ultraviolet, ozone and weather resistance
- 100% flexible
- Elastomer collar heat tested to 180°F
- Approved for type "B" installations



LISTINGS	PRODUCT	DESCRIPTION	MODEL	UNITS/CASE
 	81705	10" x 13-1/4" Base for 1-1/4", 1-1/2", 2" or 3" Vent Pipe	FB31	20
	81707	12" x 14-3/4" Base for 3" or 4" Vent Pipe	FB34	20

Multi-Size 4N1® and 3N1® Galvanized Steel Base Roof Flashings



81711

- 26-gauge galvanized base
- Adjustable multi-size flashing fits 1-1/4" – 3" and 3" – 4" vent pipe
- Tested for ultraviolet, ozone and weather resistance
- Elastomer collar heat tested to 180°F
- Approved for type "B" installations
- Available in black, brown, weathered gray, and mill finish

LISTINGS	PRODUCT	DESCRIPTION	MODEL	UNITS/CASE
 	81711	12" x 16" Base for 1-1/4"–1-1/2", 2", 3", 4" Vent Pipe	GB41	20
	81710	10-3/4" x 14-1/2" Base for 1-1/4", 1-1/2", 2" or 3" Vent Pipe	GB31	20
	81723	18" x 15.625" Base for 1-1/4"/ 1-1/2", 2", and 3" Vent Pipe (3N1® Collar), Galvanized bent edge flashing	GB3118BE	10
	81881	18" x 15.625" Base Base for 1-1/4"/ 1-1/2", 2", 3", and 4" Vent Pipe (4N1® Collar), Galvanized bent edge flashing	GB4118BE	10





81723

Caution: Do not use Petroleum base mastics, sealing compounds or paints on collar portion of all flashings, on all hardbase, flexible or rain collars.

Multi-Size 4N1®, 3N1® & 3N4 Aluminium Base Roof Flashings

- Adjustable multi-size flashing fits 1-1/4" – 3" and 3" – 4" vent pipe
- Tested for ultraviolet, ozone and weather resistance
- Elastomer collar heat tested to 180°F
- Approved for type "B" installations
- Available in black, brown, weathered gray, and mill finish



LISTINGS	PRODUCT	DESCRIPTION	MODEL	UNITS/CASE
 	81716	12" x 16" Base for 1-1/4", 1-1/2", 2" or 3" Vent Pipe	AB41	20
	81715	10-3/4" x 14-1/2" Base for 1-1/4", 1-1/2", 2" or 3" Vent Pipe	AB31	20



81716

Multi-Size 4N1® Copper Base Roof Flashings



- Adjustable multi-size flashing fits 1-1/4" – 4"
- Tested for ultraviolet, ozone and weather resistance
- Elastomer collar heat tested to 180°F
- Approved for type "B" installations

LISTINGS	PRODUCT	DESCRIPTION	MODEL	UNITS/CASE
 	81942	12" x 16" Base for 1/4", 1/2", 2", 3" or 4" Vent Pipe	CB41	5
	81885	12" x 16" Base for 1/4", 1/2", 2", 3" or 4" Vent Pipe, Single Pack	CB41S	1



Standard Hard Plastic Base Roof Flashings

- Thermoplastic hard base with elastomer collar
- Approved for type "B" installations
- 18" x 18" available for code required areas
- Tested for ultraviolet, ozone and weather resistance
- Elastomer collar heat tested to 180°F



LISTINGS	PRODUCT	DESCRIPTION	MODEL	UNITS/CASE
Standard				
 	81750	9-1/4" x 13" Base for 1-1/4" or 1-1/2" Vent Pipe	HB1	20
	81751	11-1/8" x 15" Base for 1-1/4" or 1-1/2" Vent Pipe	HB1LB	20
	81755	9-1/4" x 13" Base for 2" Vent Pipe	HB2	20
	81756	11-1/8" x 15" Base for 2" Vent Pipe	HB2LB	20
	81760	11-1/8" x 15" Base for 3" Vent Pipe	HB3	20
	81765	12" x 15-1/2" Base for 4" Vent Pipe	HB4	20



81750

Standard All Flexible Roof Flashings

- Tested for ultraviolet, ozone and weather resistance
- Elastomer collar heat tested to 180°F
- Approved for Type "B" installations

LISTINGS	PRODUCT	DESCRIPTION	MODEL	UNITS/CASE
 	81800	9" x 11-3/8" Base for 1-1/4" or 1-1/2" Vent Pipe	FB1	20
	81805	9" x 11-3/8" Base for 2" Vent Pipe	FB2	20
	81810	10" x 13-1/4" Base for 3" Vent Pipe	FB3	20
	81815	12" x 14-3/4" Base for 4" Vent Pipe	FB4	20



81800

Caution: Do not use Petroleum base mastics, sealing compounds or paints on collar portion of all flashings, on all hardbase, flexible or rain collars.

Standard Galvanized Steel Base Roof Flashings



81850

- 24-gauge galvanized base with elastomer collar
- Fits any roof pitch to 45°
- Elastomer collar heat tested to 180°F
- Tested for ultraviolet, ozone and weather resistance

LISTINGS	PRODUCT	DESCRIPTION	MODEL	UNITS/CASE
Standard				
	81850	8-3/4" x 12-1/2" Base for 1-1/4" or 1-1/2" Vent Pipe	GB1	20
	81855	8-3/4" x 12-1/2" Base for 2" Vent Pipe	GB2	20
	81860	10-3/4" x 14-1/2" Base for 3" Vent Pipe	GB3	20
	81865	12" x 16" Base for 4" Vent Pipe	GB4	20
	81870	8-3/4" x 12-1/2" Base for 1/2", 3/4" or 1" Tubing	GB5	20
18" x 18"				
	81879	18" x 18" Base for 1/2", 3/4" or 1" Tubing	GB518	15



Standard Aluminium Base Roof Flashings



81900

- Aluminum base with elastomer collar
- Approved for Type "B" installations
- Elastomer collar heat tested to 180°F
- Tested for ultraviolet, ozone and weather resistance

LISTINGS	PRODUCT	DESCRIPTION	MODEL	UNITS/CASE
	81900	8-3/4" x 12-1/2" Base for 1-1/4" or 1-1/2" Vent Pipe	AB1	20
	81905	8-3/4" x 12-1/2" Base for 2" Vent Pipe	AB2	20
	81910	10-3/4" x 14-1/2" Base for 3" Vent Pipe	AB3	20
	81915	12" x 16" Base for 4" Vent Pipe	AB4	20
	81916	8-3/4" x 12-1/2" Base for 1/2", 3/4" and 1" Tubing	AB5	20



Caution: Do not use Petroleum base mastics, sealing compounds or paints on collar portion of all flashings, on all hardbase, flexible or rain collars.

Metal Roof Flashings

- **Sleeve Flexibility:** Absorbs vibration and pipe movement caused by expansion/contraction
- **Easy On-site Customization:** Can accommodate all normal installations
- **Adaptable Base:** Designed to mold to most panel configurations and roof pitches regardless of pipe location
- **Weather Protection:** Made of EPDM or high-temperature silicone, these flashings are compounded specifically for maximum resistance to weathering due to ozone and ultraviolet light
- **EPDM is Lab Tested and certified:** IAPMO PS64-2012ea1

PRODUCT	DESCRIPTION	MODEL	UNITS/CASE
Square Base			
81455	#3, Gray, EPDM, for pipe sizes 0"-5-3/4"	MRF3GSQ	10
81456	#4, Gray, EPDM, for pipe sizes 2-3/4"-7"	MRF4GSQ	10
81457	#5, Gray, EPDM, for pipe sizes 3-3/4"-7-3/4"	MRF5GSQ	10
81458	#6, Gray, EPDM, for pipe sizes 4-3/4"-10"	MRF6GSQ	10
81459	#7, Gray, EPDM, for pipe sizes 6"-11"	MRF7GSQ	10
81845	#3, Black, EPDM, for pipe sizes 0"-5-3/4"	MRF3BSQ	6
81460	#4, Black, EPDM, for pipe sizes 2"-3/4"-7"	MRF4BSQ	10
81461	#5, Black, EPDM, for pipe sizes 3-3/4"-7-3/4"	MRF5BSQ	10
81462	#6, Black, EPDM, for pipe sizes 4-3/4"-10"	MRF6BSQ	10
81463	#7, Black, EPDM, for pipe sizes 6"-11"	MRF7BSQ	10
81464	#3, Terra Cotta, Silicone, for pipe sizes 0"-5-3/4"	MRF3TSSQ	6
81465	#4, Terra Cotta, Silicone, for pipe sizes 2-3/4"-7"	MRF4TSSQ	6
81466	#3, Black, Silicone, for pipe sizes 0"-5-3/4"	MRF3BSSQ	6
81467	#4, Black, Silicone, for pipe sizes 2-3/4"-7"	MRF4BSSQ	6
Round Base			
81820	#1, Gray, EPDM, for pipe sizes 0"-2-3/8"	MRF1GRD	10
81821	#2, Gray, EPDM, for pipe sizes 1-3/4"-3"	MRF2GRD	10
81822	#3, Gray, EPDM, for pipe sizes 0"-5"	MRF3GRD	10
81823	#4, Gray, EPDM, for pipe sizes 3"-6-1/4"	MRF4GRD	10
81824	#5, Gray, EPDM, for pipe sizes 4-1/4"-7-1/2"	MRF5GRD	10
81825	#6, Gray, EPDM, for pipe sizes 5"-9"	MRF6GRD	10
81826	#7, Gray, EPDM, for pipe sizes 6"-11"	MRF7GRD	10
81468	#1, Black, EPDM, for pipe sizes 0"-2-3/8"	MRF1BRD	10
81469	#2, Black, EPDM, for pipe sizes 1-1/4"-3"	MRF2BRD	10
81470	#3, Black, EPDM, for pipe sizes 0"-5"	MRF3BRD	10
81471	#4, Black, EPDM, for pipe sizes 3"-6-1/4"	MRF4BRD	10
81472	#5, Black, EPDM, for pipe sizes 4-1/4"-7-1/2"	MRF5BRD	10
81473	#6, Black, EPDM, for pipe sizes 5"-9"	MRF6BRD	10
81474	#7, Black, EPDM, for pipe sizes 6"-11"	MRF7BRD	10
81475	#3, Terra Cotta, Silicone, for pipe sizes 0"-5"	MRF3TCSR	6
81476	#5, Terra Cotta, Silicone, for pipe sizes 4-1/4"-7-1/2"	MRF5TCSR	6
81477	#3, Black, Silicone, for pipe sizes 0-5"	MRF3BSRD	6
81478	#5, Black, Silicone, for pipe sizes 4-1/4"-7-1/2"	MRF5BSRD	6

continued on next page

Caution: Do not use Petroleum base mastics, sealing compounds or paints on collar portion of all flashings, on all hardbase, flexible or rain collars.



81455



81455



81464



81822



81470



81475

Metal Roof Flashings (Cont.)



81494

81494	#1, Gray, EPDM, for pipe sizes 3/4"–2-3/4"	MRF1GRDRF	10
81495	#2, Gray, EPDM, for pipe sizes 2"–7-1/4"	MRF2GRDRF	10
81496	#3, Gray, EPDM, for pipe sizes 3-1/4"–10"	MRF3GRDRF	10
81828	#1, Black, EPDM, for pipe sizes 3/4"–2-3/4"	MRF1BRDRF	10
81829	#2, Black, EPDM, for pipe sizes 2"–7-1/4"	MRF2BRDRF	10
81830	#3, Black, EPDM, for pipe sizes 3-1/4"–10"	MRF3BRDRF	10

Specialty Solar Collars & Flashings

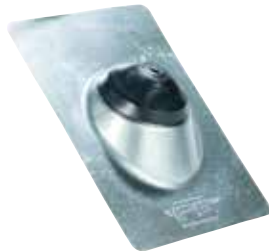

81870

- Commercial & residential: water-tight seal for solar mounting system
- Requires no mastic, caulking or taping – mess free

PRODUCT	DESCRIPTION	MODEL	UNITS/CASE
81870	8-3/4" x 12-1/2" Galvanized Base for 1/2", 3/4" or 1" Tubing	GB5	20
81879	18" x 18" Galvanized Base for 1/2", 3/4" or 1" Tubing	GB518	15
81916	8-3/4" x 12-1/2" Aluminum Base for 1/2", 3/4" and 1" Tubing	AB5	20
81937	18" x 18" Aluminum Base for 1/2", 3/4" or 1" Tubing	AB518	15
81745	Collar Only for 1/2", 3/4", 1" Vent Pipe (25 bag)	RC5	100

Multi-Size 3-8 Aluminum Base Roof Flashings



81499

- 3"–8" pipe sizes
- Sleeve flexibility absorbs vibration and pipe movement caused by expansion/contraction
- Made of EPDM which are compounded specifically for maximum resistance to weathering due to ozone and ultraviolet light
- Easy on-site customization with pull tab design can accommodate all normal installations
- 20° pitch to accommodate 12/12 roof pitch
- Large footprint 22 gauge dead soft aluminum base
- EPDM is lab tested and certified: IAPMO PS64-2012ea1

PRODUCT	DESCRIPTION	MODEL	UNITS/CASE
81499	Multi-Size 3-8 Aluminum Base Flashing	DSALUF38	10

Electrical Mast Roof Flashing



81731

- Constructed of UV stabilized flexible PVC with proven track record of 40 years
- Equipped with multi-piece stainless steel clamps
- Available in two sizes
- Tongue and groove design for increased weather protection
- Constructed of UV stabilized flexible PVC
- Warrantied for the life of the roof system

PRODUCT	DESCRIPTION	MODEL	UNITS/CASE
81731	Electrical Mast RetroFit Roof Flashing, 0 to 3-1/2" – 11 x 13-3/4" Base	EFB1	15
81732	Electrical Mast RetroFit Roof Flashing, 0 to 5" – 14" x 15" Base	EFB2	15

Standard Size Rain Collars

- Can be used to repair the elastomer sealing collar on all types of residential “no caulk” roof vent flashings quickly and easily
- Eliminates the need for a mastic or caulking type messy repair job
- Fully tested for ultraviolet, ozone and weather resistance
- Better appearance than a mastic repair job
- Can be used to instantly repair a leak during a wet period, until the flashing can be replaced at a later time
- Large size covers the entire existing elastomer collar
- For patching leaking no-caulk-style flashings
- Individual size and multi-size adjustable models available



81725



PRODUCT	DESCRIPTION	MODEL	UNITS/CASE
81725	Collar for 1-1/2" Vent Pipe	RC1	100
81730	Collar for 2" Vent Pipe	RC2	100
81735	Collar for 3" Vent Pipe	RC3	75
81740	Collar for 4" Vent Pipe	RC4	75
81745	Collar for 1/2", 3/4", 1" Vent Pipe (25 bag)	RC5	100

Low-Profile Collars

- For all metal style roof flashings
- Designed to fit all metal coned roof jacks/flashings 1" – 4"
- Requires no mastic, caulking or taping for a total waterproof seal
- Low-profile size
- Manufactured using a special EPDM material with UV inhibitor
- Life of the roof system warranty



81739



LISTINGS	PRODUCT	DESCRIPTION	MODEL	UNITS/CASE
	81739	Low Profile Collar for 1" Vent Pipe (25 bag)	LPC1	100
	81741	Low Profile Collar for 1-1/2" Vent Pipe (25 bag)	LPC15	100
	81742	Low Profile Collar for 2" Vent Pipe (25 bag)	LPC2	100
	81743	Low Profile Collar for 3" Vent Pipe (25 bag)	LPC3	100
	81744	Low Profile Collar for 4" Vent Pipe (25 bag)	LPC4	100

Multi-Size 4N1™ Rain Collar

- Can be used to repair the elastomer sealing collar on all types of residential “no caulk” roof vent flashings quickly and easily
- Eliminates the need for a mastic or caulking type messy repair job
- Can be used to instantly repair a leak during a wet period, until the flashing can be replaced at a later time
- Large size covers the entire existing elastomer collar
- Fully tested for ultraviolet, ozone and weather resistance
- Individual sizes and multi-size adjustable models available
- Better appearance than a mastic



81721

LISTINGS	PRODUCT	DESCRIPTION	MODEL	UNITS/CASE
 	81721	4N1® Collar for 1 ¼", 1 ½", 2" or 3" Vent Pipe	RC41	20

Caution: Do not use Petroleum base mastics, sealing compounds or paints on collar portion of all flashings, on all hardbase, flexible or rain collars.

Type B Vent Flashings



81575

- 28 gauge G-90 ASTM-A653 CS Galvanized steel
- Conical shape allows adjusting from 0/12 to 8/12 roof pitch
- Steep pitch models adjust from 8/12 to 12/12 roof pitch
- Cone and base seams have sealant on the inside of flashing
- Complies with ANSI / UL 441

PRODUCT	DESCRIPTION	MODEL	UNITS/CASE
81575	3" Type B Flashing	TB3	12
81576	4" Type B Flashing	TB4	12
81577	5" Type B Flashing	TB5	12
81578	6" Type B Flashing	TB6	12
81579	7" Type B Flashing	TB7	6
81580	8" Type B Flashing	TB8	6
81585	3" Type B Flashing – Steep Pitch	TB3SP	12
81586	4" Type B Flashing – Steep Pitch	TB4SP	12
81592	5" Type B Flashing – Steep Pitch	TB5SP	12
81593	6" Type B Flashing – Steep Pitch	TB6SP	12

Weld-On®
Guy Gray®
Water-Tite®
ToughPans®
RTB
Test-Tite®
AB&A®
Studor®
Truebro®
Christy's®
FloodStop®
ProVent®
ProSet®

Stamped Storm Collar

- Works with Type B Vent flashing
- Provides a waterproof seal at roof stack penetration
- Storm collar is installed and sealed above the flashing
- 28 gauge G-90 ASTM-A653 CS Galvanized steel
- Complies with ANSI / UL 441

PRODUCT	DESCRIPTION	MODEL	UNITS/CASE
81597	3" Type B Storm Collar Stamped	SC3S	24
81598	4" Type B Storm Collar Stamped	SC4S	24
81601	5" Type B Storm Collar Stamped	SC5S	24
81602	6" Type B Storm Collar Stamped	SC6S	24



81597

Multi-Cap™ Type B Vent Caps

- Recommended for flue, hot stack, or Type B installations.
- Constructed from heavy-duty aluminum for durability.
- Resists rust and corrosion, ensuring long-lasting performance.
- Prevents weather, debris, and birds from entering the flue
- Non-clogging positive draft design
- Clamp fittings adjustable for all standard sizes
- Aluminum construction
- Complies with ANSI / UL 441

PRODUCT	DESCRIPTION	MODEL	UNITS/CASE
81694	Type B-Vent Cap, for outside diameter of 2-7/8" to 4-7/8"	VC35	12
81695	Type B-Vent Cap, for outside diameter of 4-7/8" to 6-7/8"	VC57	12
81696	Type B-Vent Cap, for outside diameter of 6-7/8" to 8-7/8"	VC79	12
81697	Type B-Vent Cap, for outside diameter of 8-7/8" to 10-7/8"	VC911	1
81698	Type B-Vent Cap, for outside diameter of 11-7/8" to 14"	VC1214	1



81694

Type B Vent Adjustable Storm Collars

- 28 gauge G-90 ASTM-A653 CS Galvanized steel
- Adjustable slip fit tab provides snug fit around vent
- Locking tab secures installation
- 7"-9" storm collar accommodates multi-sizes.
- Complies with ANSI / UL 441

PRODUCT	DESCRIPTION	MODEL	UNITS/CASE
81587	3" Type Adj Storm Collar	SC3	24
81588	4" Type Adj Storm Collar	SC4	24
81589	5" Type Adj Storm Collar	SC5	24
81590	6" Type Adj Storm Collar	SC6	24
81591	7-9" Type Adj Storm Collar	SC79	24

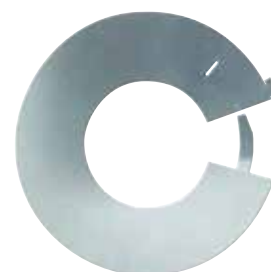

81587

Galvanized Steel SnapCap™



81680

- All-Flow™ capability: patent pending counterbalanced damper works with any CFM fan
- 3", 4", & 6" adapters for multiple application sizes

- Heavy gauge flange and housing
- Three powder coated finishes available
- Adapter set and cable tie included with each SnapCap™

PRODUCT	DESCRIPTION	MODEL	UNITS/CASE
81680	SnapCap - Galvanized Steel, Brown	SCBRG	1
81681	SnapCap - Galvanized Steel, Black	SCBLG	1
81682	SnapCap - Galvanized Steel, Weathered Gray	SCGRG	1



81681



81682

Aluminium SnapCap™



81684

- All-Flow™ capability: patent pending counterbalanced damper works with any CFM fan
- 3", 4", & 6" adapters for multiple application sizes

- Heavy gauge flange and housing
- Three powder coated finishes available
- Adapter set and cable tie included with each SnapCap™

PRODUCT	DESCRIPTION	MODEL	UNITS/CASE
81684	SnapCap - Aluminum, Black	SCBLAC	1

Weld-On®
Guy Gray®
Water-Tite®
ToughPans®
RTB
Test-Tite®
AB&A®
Studor®
Truebro®
Christy's®
FloodStop®
ProVent®
ProSet®

Greenskin® Building Seals

- For all types of interior or exterior penetrations through buildings
- Use with HVAC, electrical, plumbing, etc.
- Perfect weathertight poly seal
- Easy to use, flexible continuous membrane
- No caulking
- No taping joints
- Spacer button allows air flow behind seal
- No trapped moisture in wall cavity

PRODUCT	DESCRIPTION	MODEL	UNITS/CASE
81411	10x10 Greenskin® Fits 0.5" DWV	WTGS10NPS05	12
81412	10x10 Greenskin® Fits 0.75" DWV	WTGS10NPS075	12
81413	10x10 Greenskin® Fits 1" DWV	WTGS10NPS1	12
81414	10x10 Greenskin® Fits 1.25" DWV	WTGS10NPS125	12
81415	10x10 Greenskin® Fits 1.5" DWV	WTGS10NPS15	12
81416	10x10 Greenskin® Fits 2" DWV	WTGS10NPS2	12
81417	12x12 Greenskin® Fits 3" DWV	WTGS12NPS3	12
81418	12x12 Greenskin® Fits 4" DWV	WTGS12NPS4	12
81419	12x12 Greenskin® Fits 4" Duct	WTGS12HVAC4	12
81420	12x12 Greenskin® Fits 5" Duct	WTGS12HVAC5	12
81421	12x12 Greenskin® Fits 6" Duct	WTGS12HVAC6	12
81422	15x15 Greenskin® Fits 8" Duct	WTGS15HVAC8	12
81423	12x12 Greenskin® Single Gang RT	WTGS12ELB	12
81424	12x12 Greenskin® Single Gang RT	WTGS12ELR	12

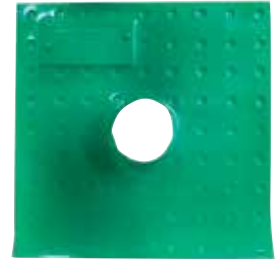
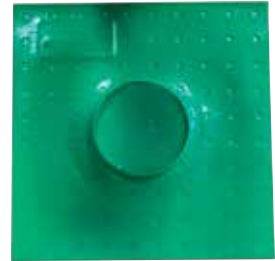

81411

Faceplates with Gasket Backing

PRODUCT	DESCRIPTION	MODEL	UNITS/CASE
81425	6x12 Faceplate - Two 2" Holes	WTMLFP6122	25
81426	6x12 Faceplate - Two 3" Holes	WTMLFP6123	25
81427	6x12 Faceplate - Blank	WTMLFP612BG	25
81428	6x16 Faceplate - Two 2" Holes	WTMLFP6162	25
81429	6x16 Faceplate - Two 3" Holes	WTMLFP6163	25
81430	6x16 Faceplate - Blank	WTMLFP616BG	25
81431	4.5x10 Faceplate - Two 2" Holes	WTMLFP4102	25
81432	4.5x10 Faceplate - Blank	WTMLFP410BG	25
81433	8x8 Faceplate - One 4" Hole	WTMLFP884	25
81434	8x8 Faceplate - Blank	WTMLFP88BG	25
81435	6x6 Faceplate - One 3" Hole	WTMLFP663	25
81436	6x6 Faceplate - One 2" Hole	WTMLFP662	25
81437	6x6 Faceplate - One 1.5" Hole	WTMLFP6615	25
81438	6x6 Faceplate - One Blank	WTMLFP66BG	25

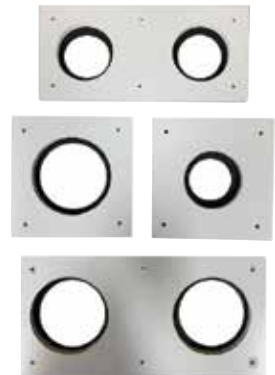

Faceplates without Gasket Backing



81443

PRODUCT	DESCRIPTION	MODEL	UNITS/CASE
81439	6x16 Faceplate - Blank No Gasket	WTMLFP616B	25
81440	6x16 Faceplate - Blank No Gasket	WTMLFP612B	25
81441	4.5x10 Faceplate - Blank No Gasket	WTMLFP410B	25
81442	8x8 Faceplate - Blank No Gasket	WTMLFP88B	25
81443	6x6 Faceplate - Blank No Gasket	WTMLFP66B	25
81444	6x6 Faceplate - Thick No Gasket	WTMLFP66BTH	25

Meter Pocket



81445

PRODUCT	DESCRIPTION	MODEL	UNITS/CASE
81445	9 x16 Meter Pocket-Meter Sockets	WTMP916	



Mushroom Vent Cap



81753

- Fully assembled for easy installation
- Made from heavy-duty PVC that stands up to rain, hail, snow, and UV rays
- Stainless steel hex head bolts are corrosion resistant
- Charcoal gray cap compliments any type or color roof
- Product can be installed on 3" or 4" Schedule 40 pipe
- Will work on other exterior pipes that need protection

PRODUCT	DESCRIPTION	MODEL	UNITS/CASE
81753	Mushroom Vent Cap for 3- or 4-inch pipes	34MCL	5

Pro-Flash®

- Non-breathable and flexible
- Weather tight elastomeric seal
- Score lines allow for multiple pipe sizes
- Easily integrates into your building envelope system
- Flexible membrane easily forms around any contours of the building (trims, corners, etc.)
- No caulking or taping

PRODUCT	DESCRIPTION	MODEL	UNITS/CASE
81450	1/8"-3/8" NPS Pro-Flash® 25-Pk	WTPFGR2525PK	25
81451	0.5"-1.75" NPS Pro-Flash® 25-Pk	WTPFGR5015025PK	25
81452	2" SDR35-6" NPS Pro-Flash® 25-Pk	WTPFGR20035025PK	25
81453	4" SDR35-6" NPS Pro-Flash® 25-Pk	WTPFGR35065025PK	2



81450

ProSet®

ProVent®

FloodStop®

Christy's®

Truebro®

Studor®

AB&A®

Test-Tite®

RTB

ToughPans®

Waater-Tite®

Guy Gray®

Weld-On®



TOUGH PANS®

2019

Tough Pans® Water Heater Pans

In 2019, IPS Corporation® acquired the Dry Lift and Pro Series Water Heater protection pans which are designed for gas and electric water heaters.

The Dry Lift and Pro Series pans were added to IPS Corporation®'s high quality aluminum and plastic pans to form the most extensive protection pan line in the industry - now known as Tough Pans®.



Today

Most innovative drain pan line on the market

The Dry Lift and Pro Series pans are the most innovative drain pan line on the market, engineered with the strongest materials to produce a nearly indestructible pan. The Dry Lift and Pro series water heater pans can be used on gas or electric tanks and are extremely durable and flexible. The Dry Lift Series of drain pans uses built in risers to lift tanks 1.5", extending tank life and making connecting to the drain valve effortless.



Dry Lift Series



87090

- For use with gas or electric tanks
- Patented lift system for easy valve connection and extended tank life
- ASTM E-84 Class A Rating
- Constructed with the strongest materials for extreme toughness and flexibility

PRODUCT	DESCRIPTION	MODEL	UNITS/CASE
87090	Dry Lift WH Pan 23" with CPVC Adapter	VP23RC	1
87091	Dry Lift WH Pan 23" with PVC Adapter	VP23RP	1
87092	Dry Lift WH Pan 25" with CPVC Adapter	VP25RC	1
87093	Dry Lift WH Pan 25" with PVC Adapter	VP25RP	1
87094	Dry Lift WH Pan 27" with CPVC Adapter	VP27RC	1
87095	Dry Lift WH Pan 27" with PVC Adapter	VP27RP	1

Pro Series



87114

- For use with gas or electric tanks
- ASTM E-84 Class A Rating
- Constructed with the strongest materials for extreme toughness and flexibility

PRODUCT	DESCRIPTION	MODEL	UNITS/CASE
With Hole			
87110	PRO WH Pan 19" with CPVC Adapter	VP19PC	1
87111	PRO WH Pan 19" with PVC Adapter	VP19PP	1
87112	PRO WH Pan 21" with CPVC Adapter	VP21PC	1
87113	PRO WH Pan 21" with PVC Adapter	VP21PP	1
87114	PRO WH Pan 23" with CPVC Adapter	VP23PC	1
87115	PRO WH Pan 23" with PVC Adapter	VP23PP	1
87116	PRO WH Pan 25" with CPVC Adapter	VP25PC	1
87117	PRO WH Pan 25" with PVC Adapter	VP25PP	1
87118	PRO WH Pan 27" with CPVC Adapter	VP27PC	1
87119	PRO WH Pan 27" with PVC Adapter	VP27PP	1
87120	PRO WH Pan 31" with CPVC Adapter	VP31PC	1
87121	PRO WH Pan 31" with PVC Adapter	VP31PP	1
No Hole			
87122	PRO WH Pan 19", No Hole, PVC Adapter	VP19PPNH	1
87123	PRO WH Pan 21", No Hole, PVC Adapter	VP21PPNH	1
87124	PRO WH Pan 23", No Hole, PVC Adapter	VP23PPNH	1
87125	PRO WH Pan 25", No Hole, PVC Adapter	VP25PPNH	1
87126	PRO WH Pan 27", No Hole, PVC Adapter	VP27PPNH	1
87127	PRO WH Pan 31", No Hole, PVC Adapter	VP31PPNH	1

Aluminium Water Heater Pans, PVC Drain Connection

- Durable 25 mil. aluminum circular pans recommended for gas water heater protection
- Drain adapter fits over 1" and inside 1-1/2" PVC pipe
- 2" clearance around diameter of heater pan recommended
- 2 1/8" deep
- Will not rust
- Pre-drilled with drain kit



87030

PRODUCT	DESCRIPTION	MODEL	UNITS/CASE
87030	18" ID x 20" OD Pan, 1" x 1-1/2" PVC Drain Conx.	AHP18203	10
87000	20" ID x 22" OD Pan, 1" x 1-1/2" PVC Drain Conx.	AHP2022	10
87003	22" ID x 24" OD Pan, 1" x 1-1/2" PVC Drain Conx.	AHP2224	10
87006	24" ID x 26" OD Pan, 1" x 1-1/2" PVC Drain Conx.	AHP2426	10
87010	26" ID x 28" OD Pan, 1" x 1-1/2" PVC Drain Conx.	AHP2628	10
87031	28" ID x 30" OD Pan, 1" x 1-1/2" PVC Drain Conx.	AHP2830	5
87013	30" ID x 32" OD Pan, 1" x 1-1/2" PVC Drain Conx.	AHP3032	5
87041	32" ID x 34" OD Pan, 1" x 1-1/2" PVC Drain Conx.	AHP3234	5

Aluminium Water Heater Pans, CPVC Drain Connection

- Durable 25 mil. aluminum circular pans recommended for gas water heater protection
- Drain adapter fits over 1" and inside 1-1/2" PVC pipe
- 2" clearance around diameter of heater pan recommended
- 2 1/8" deep
- Will not rust
- Pre-drilled with drain kit
- Furnished with 1" CPVC drain kit



87035

PRODUCT	DESCRIPTION	MODEL	UNITS/CASE
87035	18" ID x 20" OD Pan, 1" CPVC Drain Conx.	AHP1820C	10
87002	20" ID x 22" OD Pan, 1" CPVC Drain Conx.	AHP2022C	10
87005	22" ID x 24" OD Pan, 1" CPVC Drain Conx.	AHP2224C	10
87008	24" ID x 26" OD Pan, 1" CPVC Drain Conx.	AHP2426C	10
87012	26" ID x 28" OD Pan, 1" CPVC Drain Conx.	AHP2628C	10
87033	28" ID x 30" OD Pan, 1" CPVC Drain Conx.	AHP2830C	5
87014	30" ID x 32" OD Pan, 1" CPVC Drain Conx.	AHP3032C	5
87074	32" ID x 34" OD Pan, 1" CPVC Drain Conx.	AHP3234C	5

Aluminium Water Heater Pans, PVC Drain Connection, No Hole

- Durable 25 mil. aluminum circular pans recommended for gas water heater protection
- Drain adapter fits over 1" and inside 1-1/2" PVC pipe
- 2" clearance around diameter of heater pan recommended
- 2 1/8" deep
- Will not rust
- Pre-drilled with drain kit
- Furnished with drain kit



87001

PRODUCT	DESCRIPTION	MODEL	UNITS/CASE
87001	20" ID x 22" OD Pan, 1" PVC Drain Conx./No Hole	AHP2022NH	10
87004	22" ID x 24" OD Pan, 1" PVC Drain Conx./No Hole	AHP2224NH	10
87007	24" ID x 26" OD Pan, 1" PVC Drain Conx./No Hole	AHP2426NH	10
87011	26" ID x 28" OD Pan, 1" PVC Drain Conx./No Hole	AHP2628NH	10
87015	30" ID x 32" OD Pan, 1" PVC Drain Conx./No Hole	AHP3032NH	5

Plastic Water Heater Pans, PVC Drain Connection



86970

- Circular pans recommended for electric water heater protection
- PVC drain adapter fits over 1" PVC or inside 1-1/2" PVC pipe
- 2" clearance around diameter of heater pan recommended
- 2-1/2" deep
- New plastic material allows for increased flexibility and ease of installation
- 1-piece construction
- Furnished with PVC drain kit

PRODUCT	DESCRIPTION	MODEL	UNITS/CASE
86970	18" ID x 20" OD Pan, 1" x 1-1/2" PVC Drain Conx.	HP1820	20
86975	20" ID x 22" OD Pan, 1" x 1-1/2" PVC Drain Conx.	HP2022	20
86980	22" ID x 24" OD Pan, 1" x 1-1/2" PVC Drain Conx.	HP2224	20
86985	24" ID x 26" OD Pan, 1" x 1-1/2" PVC Drain Conx.	HP2426	20
86990	26" ID x 28" OD Pan, 1" x 1-1/2" PVC Drain Conx.	HP2628	10
86997	28" ID x 30" OD Pan, 1" x 1-1/2" PVC Drain Conx.	HP2830	5
86995	30" ID x 32" OD Pan, 1" x 1-1/2" PVC Drain Conx.	HP3032	5

Plastic Water Heater Pans, CPVC Drain Connection



86979

- Circular pans recommended for electric water heater protection
- CPVC adapter fits 1" CPVC pipe
- 2" clearance around diameter of heater pan recommended
- 2-1/2" deep
- New plastic material allows for increased flexibility and ease of installation
- 1-piece construction
- Furnished with 1" CPVC drain kit

PRODUCT	DESCRIPTION	MODEL	UNITS/CASE
86979	20" ID x 22" OD Pan, 1" CPVC Drain Conx.	HP2022C	20
86984	22" ID x 24" OD Pan, 1" CPVC Drain Conx.	HP2224C	20
86989	24" ID x 26" OD Pan, 1" CPVC Drain Conx.	HP2426C	20
86994	26" ID x 28" OD Pan, 1" CPVC Drain Conx.	HP2628C	10
86999	28" ID x 30" OD Pan, 1" CPVC Drain Conx.	HP2830C	5
86998	30" ID x 32" OD Pan, 1" CPVC Drain Conx.	HP3032C	5

Plastic Water Heater Pans, PVC Drain Connection, No Hole



86976

- Circular pans recommended for electric water heater
- 2" clearance around diameter of heater pan recommended
- 2-1/2" deep
- New plastic material allows for increased flexibility and ease of installation
- 1-piece construction
- Furnished with PVC drain kit

PRODUCT	DESCRIPTION	MODEL	UNITS/CASE
86976	20" ID x 22" OD Pan Undrilled, 1" x 1-1/2" PVC Drain Conx.	HP2022NH	20
86981	22" ID x 24" OD Pan Undrilled, 1" x 1-1/2" PVC Drain Conx.	HP2224NH	20
86986	24" ID x 26" OD Pan Undrilled, 1" x 1-1/2" PVC Drain Conx.	HP2426NH	20
86991	26" ID x 28" OD Pan Undrilled, 1" x 1-1/2" PVC Drain Conx.	HP2628NH	10
86996	30" ID x 32" OD Pan Undrilled, 1" x 1-1/2" PVC Drain Conx.	HP3032NH	5

Plastic Washing Machine Pans

- 1" PVC drain connection included
- Provides protection from washing machine overflow or hose failure
- High-impact plastic – will not rust
- Pan not drilled
- 1" to 2" clearance around diameter of pan recommended



83200

PRODUCT	DESCRIPTION	MODEL	UNITS/CASE
83200	27" x 29" ID/27 1/2" x 29-1/2" Top OD Pan w/1" x 1-1/2" PVC Drain	WMP1	5
83202	28-1/4" x 28-1/4" ID/29 1/8" x 29 1/8" Top OD Pan w/1" x 1-1/2" PVC Drain	WMP2	5
83203	28" x 30" ID/31 x 33 Top OD Pan w/1" x 1-1/2" PVC Drain	WMP3	5
83205	29" x 34" ID/31" x 36" Top OD Pan w/ 1" x 1-1/2" PVC Drain	WMP4	5

Adapter Kit For All Plastic, Aluminium and Washing Machine Pans

- Can be used with aluminum or plastic water heater pans and washing machine pans
- PVC adapter fits over 1" and inside 1-1/2" PVC pipe
- Kit comes with adapter, rubber washer and lock nut
- Combination adapter is 1" x 1-1/2"



89075

PRODUCT	DESCRIPTION	MODEL	UNITS/CASE
88371	PVC 1" x 1-1/2" Adapter (White)	88371	5
89075	CPVC 1" x 1-1/2" Adapter (Beige)	89075	5



88371

Water Heater Stand

- Durable galvanized steel stand recommended for 30 – 50 gal. capacity gas water heater protection
- Easy screw & nut assembly



83180

PRODUCT	DESCRIPTION	MODEL	UNITS/CASE
83180	18-Gauge 21" x 21" x 18" Stand (650# Weight Limit)	WHS1	1
83181	16-Gauge 24" x 24" x 18" Stand (1300# Weight Limit)	WHS2	1

ProSet®

ProVent®

FloodStop®

Christy's®

Truebro®

Studor®

AB&A®

Test-Tite®

RTB

ToughPans®

Waater-Tite®

Guy Gray®

Weld-On®

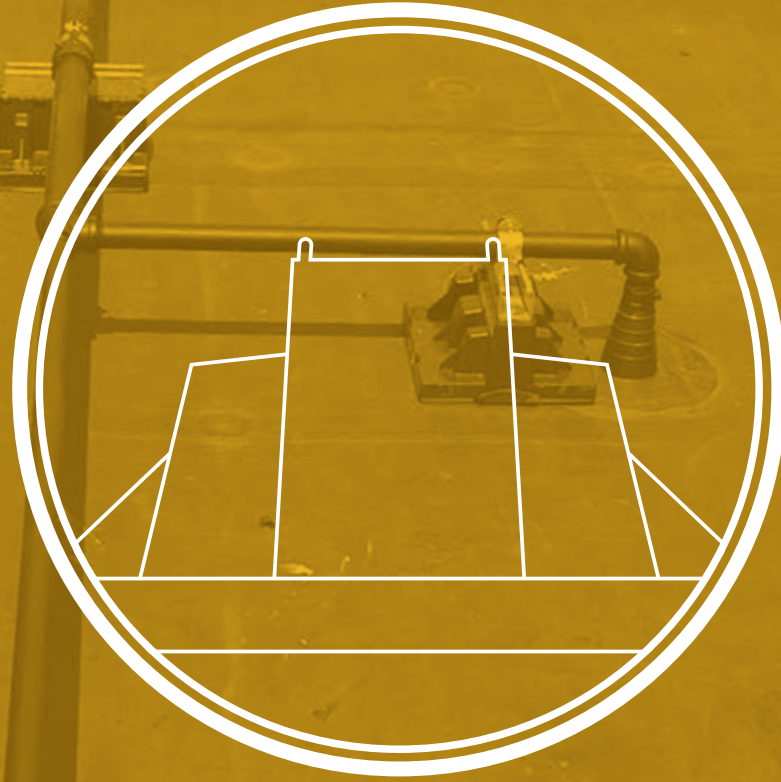

ROOF TOP BLOX.®

2016

Roof Top Blox®

In 2016, IPS Corporation® acquired the Roof Top Blox®. The Roof Top Blox® is a revolutionary roof top support block system that works with height extension rods, support brackets, pipe rollers, strut, and more. The Blox is versatile enough for every roof plumbing support, roof piping support, and roof platform support need. In addition, the packaging makes transporting roof support blocks to the job – and roof top – a faster and more efficient process.



Today

Versatile, time-saving roof top support block system

Engineered with contractors in mind, the Roof Top Blox® system is designed to be quickly installed, expanded, and adjusted from just the top side. Easier installation and lasting dependability make Roof Top Blox® the best roof block choice to specify or install for supporting pipes and mechanical equipment on flat commercial roofs.

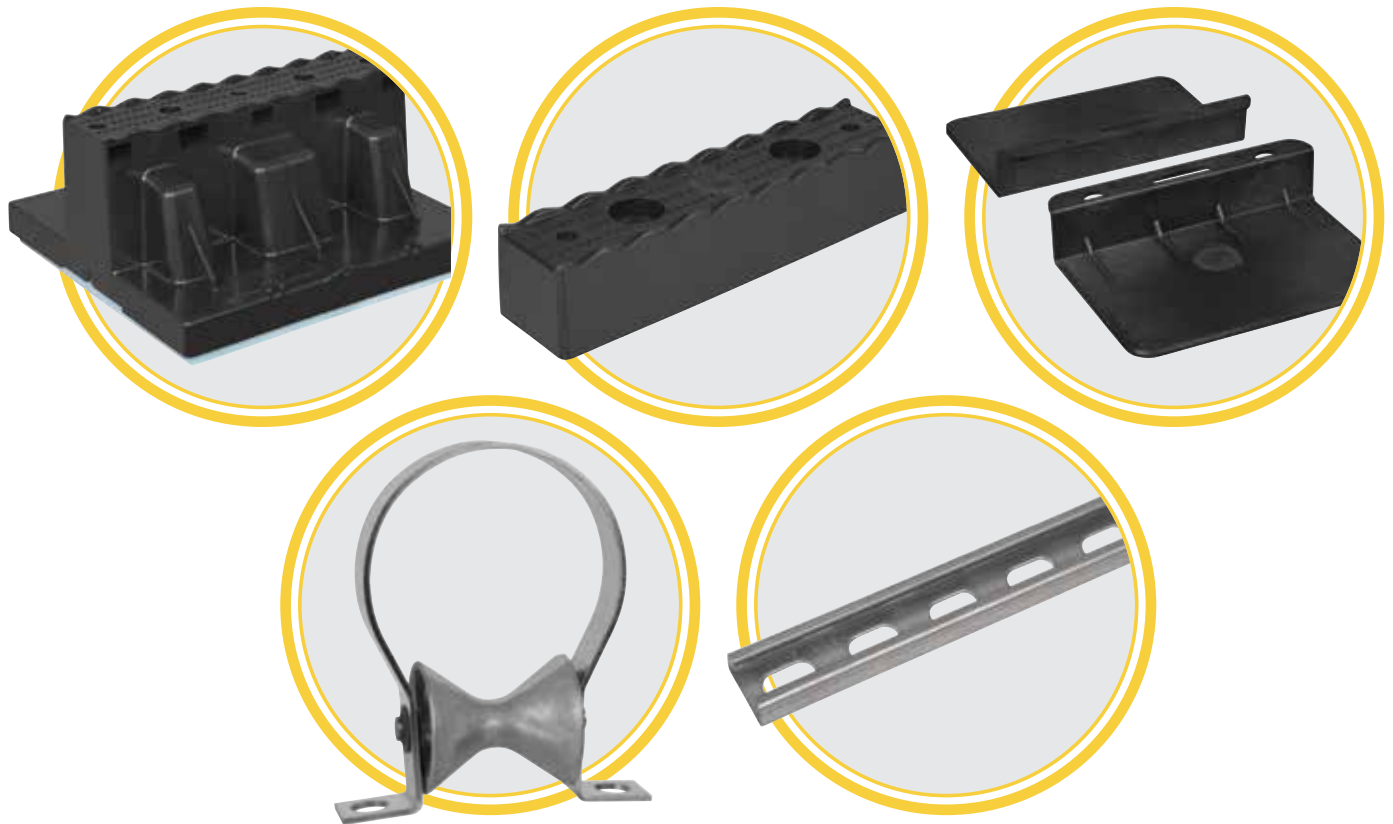

Roof Top Blox® Adjustable Pipe Support



80600

- Made of Polypropylene Copolymer
- Bundled in 8 pack totes
- Includes on-board galvanized strap
- 250 lbs. max weight single point

- 350 lbs. max weight with strut
- Perfect solution for supporting piping and equipment on flat commercial roofs

LISTINGS	PRODUCT	DESCRIPTION	MODEL	UNITS/CASE
	80600	Roof Top Blox-Adj Pipe Support (8-pack)	RTB01	8

1.5" Blox Height Extension



80601

- Fastens directly on top of Blox
- Two #10 screws provided
- Use to elevate Blox to 6" overall height

- 100 lbs./45 kg max loads when directly mounted to blox or when elevated on threaded rods
- Available in 24 or 48 packs

PRODUCT	DESCRIPTION	MODEL	UNITS/CASE
80601	1.5" Blox Height Extension	XTB0224	24

Securing Brackets



80607

- Pair of securing brackets secure Blox directly to roof surface
- Help to secure Blox to protect against moderate wind, water and snow loads

- Brackets lock onto engineered mounting tabs with two #12x3/4" screws, then glue to roof surface with structural adhesive

PRODUCT	DESCRIPTION	MODEL	UNITS/CASE
80607	Securing Bracket (1 pair)	SCB07	32

Small & Large Pipe Rollers



80605

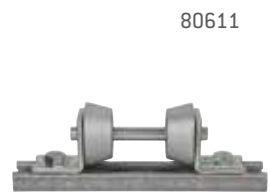

80611



80606

- Small aluminum roller supports 1" - 3" diameter pipe
- Large aluminum roller supports 4" - 6" diameter pipe
- Use on long pipe runs to allow for expansion and contraction of piping
- Can be mounted centrally or side by side on Blox

- Can be mounted directly on Blox or elevated with extension rods (R0D03)
- Includes strut, bolts and mounting screws (Large rollers only)

PRODUCT	DESCRIPTION	MODEL	UNITS/CASE
Small Pipe Rollers			
80605	1" - 3" Small Pipe Roller	ROL05	16
80611	1"-3" Small Pipe Roller Less Containment Band	ROL08	16
Large Pipe Roller			
80606	4" - 6" Large Pipe Roller	ROL06	8

Weld-On®
Guy Gray®
Waater-Tite®
ToughPans®
RTB
Test-Tite®
AB&A®
Studor®
Truebro®
Christy's®
FloodStop®
ProVent®
ProSet®

12" Extension Rods

- 11-1/2" long, 1/2" diameter zinc coated threaded rods with nuts and washers
- Use with XTBO2, STR04, ROL05 or ROL06 to elevate piping up to 14" overall height
- Insert rods a minimum of 1" into blox, not to exceed 3"

PRODUCT	DESCRIPTION	MODEL	UNITS/CASE
80603	12" Extension Rods	ROD03	24

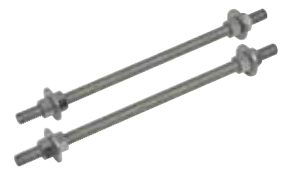

80603

10" Galvanized Slotted Strut

- Mounts directly to Blox top with #14x1 sheet metal screws and washers
- Can also be installed elevated with threaded extension rods
- Accepts strut clamps
- 350 lbs./158 kg max. static load when strut is applied to Blox

PRODUCT	DESCRIPTION	MODEL	UNITS/CASE
80604	10" Slotted Steel Strut	STR04	24



80604

M-1® Structural Adhesive

- Non-solvent based, flexible, high-bond M-1 adhesive
- 10 oz. tube bonds 10 pairs of SCB07
- Bonds SCB07 Securing Brackets to all roof surfaces and materials
- Available in gray or white (Not to be applied under Blox)

PRODUCT	DESCRIPTION	MODEL	UNITS/CASE
80608	Structural Adhesive, Gray	ADH12	24
80609	Structural Adhesive, White	ADH12WH	24



80608

Primer for M-1® Adhesive

- Primer required for bonding with ADH12 to TPO roofing systems.
- One pint primes TPO membranes for 35 pairs of Securing Brackets

PRODUCT	DESCRIPTION	MODEL	UNITS/CASE
80610	TPO Primer, F1280 (pint)	PRI13	4



80610

ProSet®

ProVent®

FloodStop®

Christy's®

Truebro®

Studor®

AB&A®

Test-Tite®

RTB

ToughPans®

Waater-Tite®

Guy Gray®

Weld-On®

TEST * TITE®

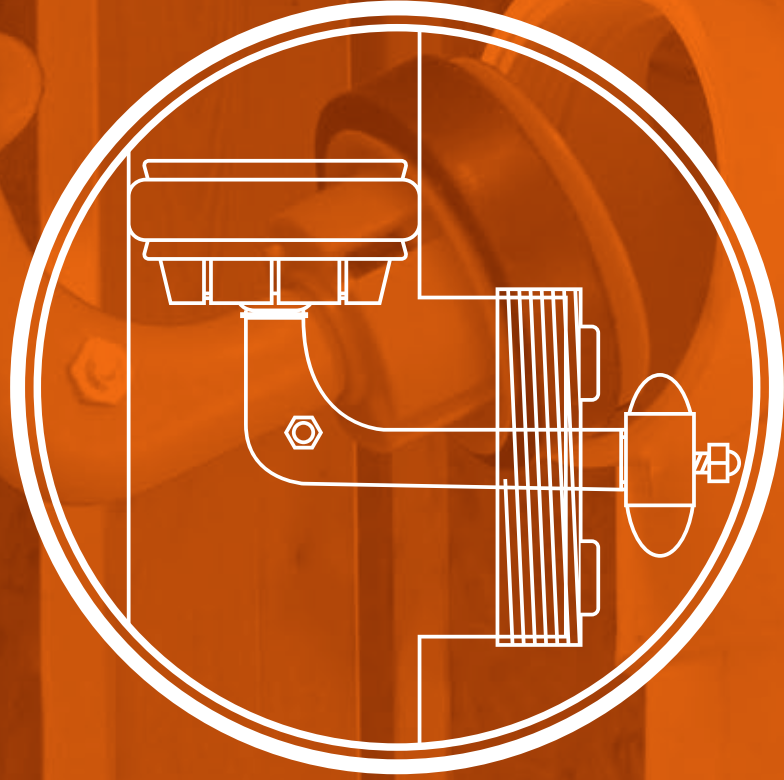

BRAND OVERVIEW

40+ years of field-tested reliability

For more than four decades now, Test-Tite® products have featured a full range of pneumatic and mechanical test plugs. Plumbers worldwide have come to rely on Test-Tite® time- and field-tested plugs, turning to them for use in residential, commercial, and underground markets.

Test plugs, tools, hoses and more

Test-Tite® pneumatic plugs come with a three-year warranty and include the full plumbing line of Pressure Relief Test Plugs up to 15" in diameter. Test-Tite® mechanical plugs feature the patented Mechanical Cleanout Test Plug, as well as the Flush Cleanout Repair Plugs. The full Test-Tite® product line also includes test caps, hoses and accessories.



VIP Series™ Pneumatic Test Plugs



83354

- High-performance Schrader valve compatible with traditional air pumps. Valve cap is provided.
- Quality control testing on every test plug. Every plug is inflated outside the pipe to a size twice its' diameter for a duration of 30 minutes.
- Highest quality tested natural rubber from a global raw material compounder with ISCC Plus certification.
- The plug design has evenly spaced "sealing ribs" to enhance bond to the pipe wall. These sealing ribs prevent slippage of the test plug when pressure is applied.
- Vulcanization In-Mold Process with state-of-the-art precision molding vulcanization presses and automated PLC programmable temperature and mold controls.
- Long valve stem provides a flat surface so the metal ring will not slip off the plug.
- Ring tag is made of ABS plastic and will not rust. In addition, it is sized to a diameter greater than the pipe so it cannot fall into the pipe. Finally, it comes with a "comfort grip" handle.
- The sash galvanized steel chain is lightweight, rust resistant, and kink proof.
- Leading industry 30-month warranty from time of manufacturer against manufacturer's defects.
- Supporting accessories include extension hoses, inflation hoses, and gauges.v

PRODUCT	DESCRIPTION	MODEL	UNITS/CASE
Standard Packs			
83551	1-1/2" Pneu. Plug w/1 ft Chain	83551	6
83552	2" Pneu. Plug w/1 ft Chain	83552	6
83553	3" Pneu. Plug w/1 ft Chain	83553	6
83554	4" Pneu. Plug w/1 ft Chain	83554	6
83556	3" Pneu. Plug w/6 ft Chain	83556	6
83557	4" Pneu. Plug w/6 ft Chain	83557	6

Pressure Relief Pneumatic Test Plugs



83582

- Pressure relief automatically resets as the pressure in the plug vents below release pressure
- Pressure relief has no moving parts to fail or malfunction
- Molded as one-piece with no seams or bonded parts
- Pressure relief exhausts out of the top of the plug not into test area
- Internal pressure relief device releases pressure when plug exceeds maximum pressure levels
- Works in place of "standard" pneumatic plugs
- 5 sealing ribs in the center portion of the plug for positive sealing
- Three-year limited warranty
- 3" and 4" plugs are available with 48" long chains (bulk packs only). Contact IPS for availability

PRODUCT	DESCRIPTION	MODEL	UNITS/CASE
Standard Packs			
83581	1-1/4" – 1-1/2" PR Test Plug Boxed	83581	6
83582	2" Pressure Relief Test Plug	83582	6
83583	3" Pressure Relief Test Plug	83583	6
83584	4" Pressure Relief Test Plug	83584	6
Bulk Packs			
83585	1-1/4" – 1-1/2" PR Test Plug Bulk	83585	12
83586	2" Pressure Relief Test Plug	83586	12
83587	3" Pressure Relief Test Plug	83587	12
83588	4" Pressure Relief Test Plug	83588	12

Weld-On®
Guy Gray®
ToughPans®
Waater-Tite®
RTB
Test-Tite®
AB&A®
Studor®
Truebro®
Christy's®
FloodStop®
ProVent®
ProSet®

Large Pressure Relief Pneumatic Test Plugs

- Designed for testing or to temporarily stop the flow
- Each size is designed for one specific pipe size
- Can be used in a variety of fitting applications and are suitable for most pipe materials
- Conforms to irregular pipe shapes to seal effectively
- Manufactured from a durable natural rubberMetal cap/core tool is also included



83625

PRODUCT	DESCRIPTION	MODEL	UNITS/CASE
83625	5" Standard Pneumatic Test Plug w/ PR Valve	83625	1
83626	6" Standard Pneumatic Test Plug w/ PR Valve	83626	1
83628	8" Standard Pneumatic Test Plug w/ PR Valve	83628	1
83630	10" Standard Pneumatic Test Plug w/ PR Valve	83630	1
83632	12" Standard Pneumatic Test Plug w/ PR Valve	83632	1
83635	15" Standard Pneumatic Test Plug w/ PR Valve	83635	1

Multi-Size Pneumatic Test Plugs

- Designed for the testing of pipelines or to temporarily stop the flow
- Can be used individually as a test plug or together with another plug for testing
- Each plug is designed for two or more pipe sizes
- Plugs are suitable for many different pipe materials
- Manufactured from a durable natural rubber compound
- 4"-6" diameter and smaller come with a 12" chain and a ring assembly attached to a molded inflation valve
- Metal cap/core tool is also included



83212

PRODUCT	DESCRIPTION	MODEL	UNITS/CASE
83211	3/4" – 1-1/2" Multi-Size Standard Pneumatic Test Plug	83211	1
83212	1-1/4" – 2" Multi-Size Standard Pneumatic Test Plug	83212	6
83225	2" – 3" Multi-Size Standard Pneumatic Test Plug	83225	6
83234	3" – 4" Multi-Size Standard Pneumatic Test Plug	83234	6
83246	4" – 6" Multi-Size Standard Pneumatic Test Plug	83246	1
83248	4" – 8" Multi-Size Standard Pneumatic Test Plug w/ PR Valve	83248	1
83268	6" – 8" Multi-Size Standard Pneumatic Test Plug w/ PR Valve	83268	1
83261	6" – 10" Multi-Size Standard Pneumatic Test Plug w/ PR Valve	83261	1
83282	8" – 12" Multi-Size Standard Pneumatic Test Plug w/ PR Valve	83282	1
83216	10" – 16" Multi-Size Standard Pneumatic Test Plug w/ PR Valve	83216	1
83218	12" – 18" Multi-Size Standard Pneumatic Test Plug w/ PR Valve	83218	1
83633	12" – 24" Large Diameter Multi-Size Pneumatic Test Plug w/ PR Valve	83633	1

Pressure Relief Long Pneumatic Test Plugs

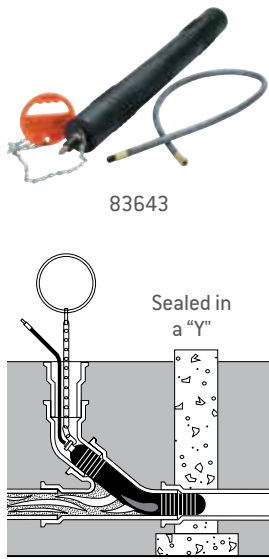

- Designed for the testing of pipelines or to temporarily stop the flow
- Designed to be used in a "Y" to block flow from the main sewer line
- Suitable for many different pipe materials
- Manufactured from a durable natural rubber compound
- Each size comes with a 24" chain and ring assembly attached to a pressure relief valve
- Also included with each plug is a 36" inflation hose

PRODUCT	DESCRIPTION	MODEL	UNITS/CASE
Standard Packs			
83642	2" Long Pneumatic Test Plug w/ PR Valve	83642	1
83643	3" Long Pneumatic Test Plug w/ PR Valve	83643	1
83644	4" Long Pneumatic Test Plug w/ PR Valve	83644	1
83646	4" – 6" Long Pneumatic Test Plug w/ PR Valve	83646	1
Bulk Packs			
83542	2" Long Pneumatic Test Plug w/ PR Valve	83542	6
83543	3" Long Pneumatic Test Plug w/ PR Valve	83543	6
83544	4" Long Pneumatic Test Plug w/ PR Valve	83544	6

Multi-Size Dual Stage Long Pneumatic Test Plugs

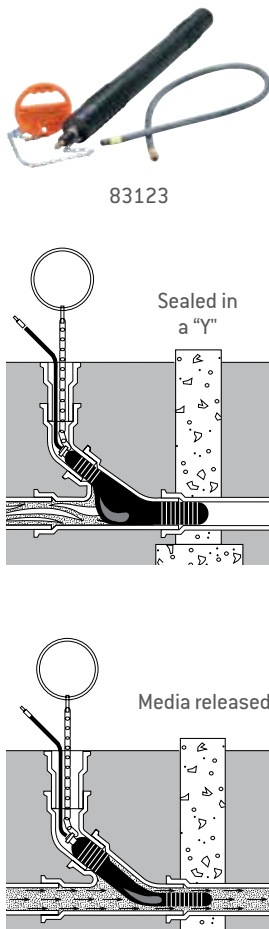

- Designed for the testing of pipelines or to temporarily stop the flow
- Designed to be used in a "Y" to block flow from the main sewer line
- The multi-size dual-stage long is designed to release the test media before completely deflating and removing the plug
- Suitable for many different pipe materials
- Manufactured from a durable natural rubber compound
- Each size comes with a 24" chain and ring assembly attached to a pressure relief valve
- Also included with each plug is a 36" inflation hose

PRODUCT	DESCRIPTION	MODEL	UNITS/CASE
83123	2" – 3" Multi-Size – Dual-Stage Long Pneumatic Test Plug w/ PR Valve	83123	1
83134	3" – 4" Multi-Size – Dual-Stage Long Pneumatic Test Plug w/ PR Valve	83134	1
83146	4" – 6" Multi-Size – Dual-Stage Long Pneumatic Test Plug w/ PR Valve	83146	1

Weld-On®
Guy Gray®
Waater-Tite®
ToughPans®
RTB
Test-Tite®
AB&A®
Studor®
Truebro®
Christy's®
FloodStop®
ProVent®
ProSet®

Pneumatic Cleanout Test Plugs

- Designed for the testing of plumbing pipelines above the cleanout tee
- Each size is designed for one specific pipe size
- Design of this plug will allow for passing of the test water or air by deflating the plug
- After deflation, the plug can be unscrewed from the test tee
- Manufactured from a durable natural rubber compound
- Each size comes with a molded-in inflation valve

PRODUCT	DESCRIPTION	MODEL	UNITS/CASE
Standard Packs			
83651	1-1/2" Cleanout Pneumatic Test Plug	83651	6
83652	2" Cleanout Pneumatic Test Plug	83652	6
83653	3" Cleanout Pneumatic Test Plug	83653	6
83654	4" Cleanout Pneumatic Test Plug	83654	6
Bulk Packs			
83661	1-1/2" Cleanout Pneumatic Test Plug – Bulk Pack	83661	12
83662	2" Cleanout Pneumatic Test Plug – Bulk Pack	83662	12
83663	3" Cleanout Pneumatic Test Plug – Bulk Pack	83663	12
83664	4" Cleanout Pneumatic Test Plug – Bulk Pack	83664	12



83654

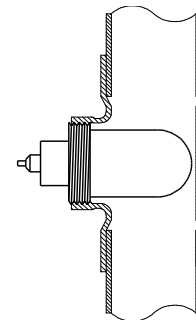

Pneumatic Bypass Plugs

- Designed for the bypassing of water or sewage in pipelines or to temporarily stop the flow
- Can also be adapted to use in air testing of sewer lines
- Each plug is designed for one pipe size
- Plugs can be used in a variety of applications and are suitable for many different pipe materials
- Manufactured from a durable natural rubber compound
- Sizes 1-1/2" through 5" come with a 12" chain and ring assembly
- Sizes 3" and larger come with a pressure relief valve
- Sizes 6" through 15" come with an eyebolt for connecting a rope or inflation/lift line

PRODUCT	DESCRIPTION	MODEL	UNITS/CASE
83671	1-1/2" Pneumatic Bypass Plug	83671	1
83672	2" Pneumatic Bypass Plug	83672	1
83673	3" Pneumatic Bypass Plug w/ PR Valve	83673	1
83674	4" Pneumatic Bypass Plug w/ PR Valve	83674	1
83675	5" Pneumatic Bypass Plug w/ PR Valve	83675	1
83676	6" Pneumatic Bypass Plug w/ PR Valve	83676	1
83678	8" Pneumatic Bypass Plug w/ PR Valve	83678	1
83680	10" Pneumatic Bypass Plug w/ PR Valve	83680	1
83682	12" Pneumatic Bypass Plug w/ PR Valve	83682	1
83685	15" Pneumatic Bypass Plug w/ PR Valve	83685	1



83674

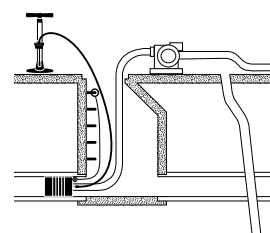

Multi-Size Pneumatic Bypass Plugs



83802

- Designed for the bypassing of water or sewage in pipelines or to temporarily stop the flow
- Can also be adapted to use in air testing of sewer lines
- Plugs can be used in a variety of applications and are suitable for many different pipe materials
- Each plug is designed for two or more pipe sizes
- Manufactured from a durable natural rubber compound
- Each plug comes with an eyebolt for connecting a rope or inflation/lift line and a pressure relief valve

PRODUCT	DESCRIPTION	MODEL	UNITS/CASE
83761	6" – 10" Multi-Size Pneumatic Bypass Plug w/ PR Valve	83761	1
83802	8" – 12" Multi-Size Pneumatic Bypass Plug w/ PR Valve	83802	1
83816	10" – 16" Multi-Size Pneumatic Bypass Plug w/ PR Valve	83816	1
83818	12" – 18" Multi-Size Pneumatic Bypass Plug w/ PR Valve	83818	1
83824	12" – 24" Multi-Size Pneumatic Bypass Plug w/ PR Valve	83824	1

Large Multi-Size Pneumatic Bypass Plugs

- Designed for the bypassing of water or sewage in pipelines or to temporarily stop the flow
- Can also be adapted to use in air testing of sewer lines
- Each plug is designed for two or more pipe sizes
- Can be used in a variety of applications and are suitable for many different pipe materials
- Manufactured from a durable natural rubber compound

PRODUCT	DESCRIPTION	MODEL	UNITS/CASE
83860	15" – 30" Multi-Size Pneumatic Bypass Plug	83860	1
83861	20" – 36" Multi-Size Pneumatic Bypass Plug	83861	1
83865	24" – 48" Multi-Size Pneumatic Bypass Plug	83865	1
83877	48" – 72" Multi-Size Pneumatic Bypass Plug	83877	1

Weld-On®
Guy Gray®
Waater-Tite®
ToughPans®
RTB
Test-Tite®
AB&A®
Studor®
Truebro®
Christy's®
FloodStop®
ProVent®
ProSet®

Multi-Size Pneumatic Front Air Test Plugs

- Designed for the bypassing of water or sewage in pipelines or to temporarily stop the flow
- Can also be adapted to use in air testing of sewer lines
- Plugs can be used in a variety of applications and are suitable for many different pipe materials
- Each plug is designed for two or more pipe sizes
- Manufactured from a durable natural rubber compound
- Each plug comes with an eyebolt for connecting a rope or inflation/lift line and a pressure relief valve

PRODUCT	DESCRIPTION	MODEL	UNITS/CASE
84048	4" – 8" Multi-Size Pneumatic Front Air Test Plugs w/ PR Valve	84048	1
84082	8" – 12" Multi-Size Pneumatic Front Air Test Plugs w/ PR Valve	84082	1
84118	12" – 18" Multi-Size Pneumatic Front Air Test Plugs w/ PR Valve	84118	1
84124	12" – 24" Multi-Size Pneumatic Front Air Test Plugs w/ PR Valve	84124	1
84146	15" – 30" Multi-Size Pneumatic Front Air Test Plugs	84146	1
84147	20" – 36" Multi-Size Pneumatic Front Air Test Plugs	84147	1
84148	24" – 48" Multi-Size Pneumatic Front Air Test Plugs	84148	1
84149	36" – 60" Multi-Size Pneumatic Front Air Test Plugs	84149	1
84151	48" – 72" Multi-Size Pneumatic Front Air Test Plugs	84151	1
84152	60" – 96" Multi-Size Pneumatic Front Air Test Plugs	84152	1



83802

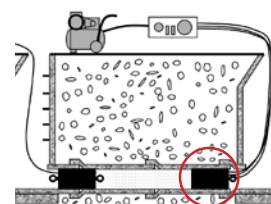

Multi-Size Pneumatic Back Air Test Plugs

- Designed for the testing of pipelines or to temporarily stop the flow
- Can be used individually as a test plug or together with another plug for testing
- Each plug is designed for two or more pipe sizes
- Plugs are suitable for many different pipe materials
- Manufactured from a durable natural rubber compound
- Sizes 12" - 24" and smaller come with pressure relief valve
- Each size comes with an eyebolt at each end for connecting directly to another Air

PRODUCT	DESCRIPTION	MODEL	UNITS/CASE
83948	4" – 8" Multi-Size Pneumatic Back Air Test Plugs w/ PR Valve	83948	1
83962	8" – 12" Multi-Size Pneumatic Back Air Test Plugs w/ PR Valve	83962	1
83968	12" – 18" Multi-Size Pneumatic Back Air Test Plugs w/ PR Valve	83968	1
83974	12" – 24" Multi-Size Pneumatic Back Air Test Plugs w/ PR Valve	83974	1
83975	15" – 30" Multi-Size Pneumatic Back Air Test Plugs	83975	1
83976	20" – 36" Multi-Size Pneumatic Back Air Test Plugs	83976	1
83978	24" – 48" Multi-Size Pneumatic Back Air Test Plugs	83978	1
83979	36" – 60" Multi-Size Pneumatic Back Air Test Plugs	83979	1
83981	48" – 72" Multi-Size Pneumatic Back Air Test Plugs	83981	1



83962

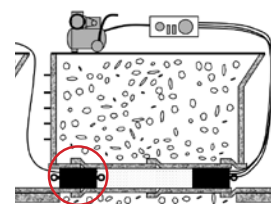

Weld-On®
Guy Gray®
ToughPans®
Waater-Tite®
RTB
Test-Tite®
AB&A®
Studor®
Truebro®
Christy's®
FloodStop®
ProVent®
ProSet®

Drain Flush



83505

- Connects to garden hose to safely, cleanly, and easily clear drain pipes of obstructions with water pressure
- Works in minutes without harsh chemicals
- Effective up to 1,000'
- Sizes available for most common residential rain applications
- Completely reusable
- One-year replacement guarantee

PRODUCT	DESCRIPTION	MODEL	UNITS/CASE
83500	Drain Flush for 1" – 2" Drains	RDF12	12
83505	Drain Flush for 1-1/2" – 3" Drains	RDF13	12
83510	Drain Flush for 3" – 4" Drains	RDF34	6
83515	Drain Flush for 3" – 6" Drains	RDF36	6

Extension Hoses



83692

- Pressure rated at 250 psig
- Made with brass fitting and ferrules
- Extension hoses each have a male and female fitting to connect directly to an inflation valve

PRODUCT	DESCRIPTION	MODEL	UNITS/CASE
83692	2-Ft. Extension Hose	83692	6
83693	3-Ft. Extension Hose	83693	6
83695	5-Ft. Extension Hose	83695	6
83696	10-Ft. Extension Hose	83696	1
83697	20-Ft. Extension Hose	83697	1
83698	30-Ft. Extension Hose	83698	1
83703	40-Ft. Extension Hose	83703	1

Air Test Caps



83922

- Used for converting a bypass plug to a Front Air Test Plug
- Each cap includes two fittings for inflation and reading pressure
- Each cap thread is standard pipe thread
- Caps are PVC for easy removal

PRODUCT	DESCRIPTION	MODEL	UNITS/CASE
83921	1-1/2" Air Test Cap, Quick Disconnect	83921	1
83922	3" Air Test Cap, Quick Disconnect	83922	1
83923	4" Air Test Cap, Quick Disconnect	83923	1

Replacement Fittings



99694

- Replacement parts for Test-Tite® testing equipment

PRODUCT	DESCRIPTION	MODEL	UNITS/CASE
99577	Quick Disconnect, Hose	99577	1
99851	1/4" Disconnect Plug	99851	1
99751	Inflator, for Extension Hose	99751	1
99752	Deflator, for Extension Hose	99752	1
99694	1/4" Tank Valve	99694	1

Pump with Gauge

- Easy-to-read pressure gauge
- Includes thumb-lock disconnect
- Includes foot base
- Inflation noses on all pumps can be replaced

PRODUCT	DESCRIPTION	MODEL	UNITS/CASE
83700	Black Pump w/Gauge – Hi Impact Plastic Body	83700	1
83710	Red Pump w/Gauge – Steel Body	83710	1



83700

Inflation / Lift Hoses

- Extension hoses each have a male and female fitting to connect directly to an inflation valve
- Includes a quick snap connection on lift line

PRODUCT	DESCRIPTION	MODEL	UNITS/CASE
83732	10-Ft. Inflation/Lift Hose	83732	1
83733	20-Ft. Inflation/Lift Hose	83733	1
83734	30-Ft. Inflation/Lift Hose	83734	1
83735	40-Ft. Inflation/Lift Hose	83735	1



83732

Weld-On®
 Guy Gray®
 Water-Tite®
 ToughPans®
 RTB
 Test-Tite®
 AB&A®
 Studor®
 Truebro®
 Christy's®
 FloodStop®
 ProVent®
 ProSet®

Twist 'N Seal® Pipe Sealing Plug



83791



- Stop water flow while soldering or cementing pipe fittings
- Holds up to 60 psig
- Quick and easy to use
- Comes individually or in a kit
- Simple to change sizes – just unscrew rubber seal and replace
- No tools required

PRODUCT	DESCRIPTION	MODEL	UNITS/CASE
83782	Small tool with 1/2" seal already attached	83782	6
83783	Small tool with 3/4" seal already attached	83783	6
83784	Small tool with 1" seal already attached	83784	6
83787	Large tool with 1-1/4" seal already attached	83787	1
83788	Large tool with 1-1/2" seal already attached	83788	1
83789	Large tool with 2" seal already attached	83789	1
83785	1/2" – 1" Twist 'N Seal Kit	83785	6
83792	1/2" – 1" Twist 'N Seal Kit w/ Carrying Case	83792	1
97470	1/2" Replacement Seal	97470	6
83790	1-1/4" – 2" Twist 'N Seal Kit w/ Carrying Case	83790	1
97528	1-1/4" Replacement Seal	97528	1
83791	1/2" – 2" Twist 'N Seal Kit w/ Carrying Case	83791	1
97529	1-1/2" Replacement Seal	97529	1
97530	2" Replacement Seal	97530	1
97543	Carrying Case	97543	1

Mechanical Cleanout Test Plugs



83656

- Clear cap provides a "window" to monitor the test media as it drains
- Expandable rubber gasket provides air and water tight seal
- Tests up to 40 vertical feet
- Durable design; plated steel parts will not rust
- No tools, hoses or gauges are required for installation
- Hand-tighten in seconds
- Available in 2-, 3-, 4- and 6-inch diameters

PRODUCT	DESCRIPTION	MODEL	UNITS/CASE
83656	2" Mechanical Cleanout Test Plug, for PVC/ABS DWV	MC02	6
83649	2" Mechanical Cleanout Test Plug, for Cast Iron	MC02CI	6
83657	3" Mechanical Cleanout Test Plug - Bulk Pack	MC03	6
83658	4" Mechanical Cleanout Test Plug - Bulk Pack	MC04	6
83659	6" Mechanical Cleanout Test Plug, for PVC/ABS DWV	MC06	1
83660	6" Mechanical Cleanout Test Plug, for Cast Iron	MC06CI	1
90442	2" Rubber Seal Only for MC02 Plug	90442	1
90446	2" Rubber Seal Only for MC02CI Plug	90446	1
90443	3" Rubber Seal Only for MC03 Plug	90443	1
90447	6" Rubber Seal Only for MC06 Plug	90447	1
90448	6" Rubber Seal Only for MC06CI Plug	90448	1
90445	Pop-It Seal Only for 2", 3", and 4"	90445	1

Metal Wing Nut Test Plugs

- Cost-effective plug
- Used for plugging open-ended pipe

- Rubber sealing ring

PRODUCT	DESCRIPTION	MODEL	UNITS/CASE
88386	Tests 1-1/2" Drain Pipe	RWN1	6
88387	Tests 2" Drain Pipe	RWN2	6
88388	Tests 3" Drain Pipe	RWN3	6
88389	Tests 4" Drain Pipe	RWN4	6
88384	Tests 5" Drain Pipe	RWN5	5
88390	Tests 6" Drain Pipe	RWN6	5



88386

Twist-Tite Mechanical Test Plugs

- Oversized wingnut with wrench pad for easy removal
- Made of high-impact ABS material
- This model for end-of-pipe only

- Will not rust or corrode
- Neoprene gasket

PRODUCT	DESCRIPTION	MODEL	UNITS/CASE
83591	1-1/2" Mechanical Test Plug	MWN1	10
83592	2" Mechanical Test Plug	MWN2	10
83593	3" Mechanical Test Plug	MWN3	10
83594	4" Mechanical Test Plug	MWN4	10
83596	6" Mechanical Test Plug	MWN6	5
83598	8" Mechanical Test Plug	MWN8	5



83591

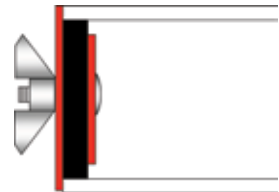

Inside Pipe Twist-Tite Mechanical Test Plugs

- Oversized wingnut with wrench pad for easy removal
- Made of high-impact ABS 124
- This model for inside-pipe only

- Will not rust or corrode
- Neoprene gasket

PRODUCT	DESCRIPTION	MODEL	UNITS/CASE
83595	4" Inside Pipe Twist-Tite	MWN9	10
83597	6" Inside Pipe Twist-Tite	MWN10	5
83599	8" Inside Pipe Twist-Tite	MWN11	5



83595

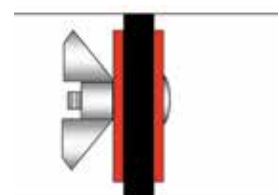

Weld-On®
Guy Gray®
Water-Tite®
ToughPans®
RTB
Test-Tite®
AB&A®
Studor®
Truebro®
Christy's®
FloodStop®
ProVent®
ProSet®

Flush Mechanical Cleanout Repair Plug



83687

- Holds up to 50 feet of back pressure
- Seals air tight! (Does not rely on threads to seal)
- Back pressure actually increases sealing ability
- Completely flush inside and out
- Can install cleanout cover over plug

- Cannot fall into the pipe
- Comes with 5/16" wrench
- Center is tapped for screw, and can be covered with cleanout cover
- Fits cleanouts only. Not designed to fit pipe.

PRODUCT	DESCRIPTION	MODEL	UNITS/CASE
83687	2" Flush Mechanical Cleanout Repair Plug	FCRP2	10
83688	3" Flush Mechanical Cleanout Repair Plug	FCRP3	10
83689	3-1/2" Flush Mechanical Cleanout Repair Plug	FCRP35	10
83690	4" Flush Mechanical Cleanout Repair Plug	FCRP4	10



83687

T-Cone Combination Cleanout Test Plugs



86395

- Economical, rust-proof and reusable
- Positive sealing
- Tests up to 50 feet of head pressure

PRODUCT	DESCRIPTION	MODEL	UNITS/CASE
86375	Tests 1-1/2" Sch. 40 DWV	S152	50
86385	Tests 2" Sch. 40 DWV & Type "M" Copper Tube	S202	50
86390	Tests 3" Sch. 40 & Copper DWV; 2" Cast Iron Hub	S302	10
86455	Tests 3" Sch. 40 Socket	S300	50
86395	Tests 4" Type "M" Copper Tube, Cast Iron Closet Bend (SW), VCP Barrel	S401	50
86400	Tests 4" Sch. 40 & Copper DWV, PVC S&D, Cast Iron & VCP Barrel; 3" Cast Iron Hub	S402	10
86420	Tests 6" Copper DWV, PVC PSM (SDR 35), PVC DR-14, CI & VCP Barrel	S601	10
86425	Tests 6" Sch. 40 DWV, PVC DR-18, Cast Iron Barrel (EH)	S602	10
86435	Tests 8" Sch. 40 DWV, PVC PSM (SDR 35), PVC DR-18, VCP Barrel	S802	20

Flush Mount T-Cone Combination Cleanout Test Plugs

- Economical, rust-proof and reusable
- Positive sealing
- Tests up to 50 feet of head pressure

PRODUCT	DESCRIPTION	MODEL	UNITS/CASE
86520	Flush Mount Recessed Plug; Tests 2" Sch. 40 DWV	CS202	50
86526	Flush Mount Recessed Plug; Tests 3" Sch. 40 & Copper DWV, Type "M" Copper	CS302	50
86535	Flush Mount Recessed Plug; Tests 4" Sch. 40 & Copper DWV, PVC S&D, Cast Iron Barrel	C0402	50



86520

T-Cone Flush Mount Cleanouts with Cover Plate

- Easy-to-install and remove
- Fits DWV pipe
- Positive sealing
- For flush or below ground applications
- Cover plate protects and identifies sewer cleanout

PRODUCT	DESCRIPTION	MODEL	UNITS/CASE
86315	3" Cleanout Plug with Cover Plate & Screw	C0302C	50
86320	4" Cleanout Plug with Cover Plate & Screw	C0402C	50



86315

T-Cone Cleanout Repair Plugs

- Easy and economical repairs to damaged/corroded, metal or plastic
- Cleanout threads – no need to replace fitting
- Epoxy sealant included for airtight and watertight repairs

PRODUCT	DESCRIPTION	MODEL	UNITS/CASE
86335	Fits 1-1/2" Female Cleanout Adapter	EB152E	50
86340	Fits 2" Female Cleanout Adapter	EB220E	50
86345	Fits 3" Female Cleanout Adapter	EB320E	50
86350	Fits 3-1/2" Female Cleanout Adapter	EB350E	50
86355	Fits 4" Female Cleanout Adapter	EB420E	50



86315

2-Way Wrench For T-Cone Cleanout Test and Repair Plugs

- For tightening 1" through 6" combination cleanout test plugs and cleanout repair plugs with raised head
- For t-cone cleanout test and repair plugs
- Also fits 3" through 4" recessed drive plugs

PRODUCT	DESCRIPTION	MODEL	UNITS/CASE
86545	T-Cone 2-Way Wrench	SM106	1



86545

Deep Techno-Caps™ - PVC

- Extra deep solvent weld socket provides room for errors on pipe that is not cut straight
- Offers an economical solution to heavy duty PVC or ABS schedule 40 DWV end caps
- Tested to 5 stories of head pressure (22 psig)

PRODUCT	DESCRIPTION	MODEL	UNITS/CASE
87531	Tests 1-1/2" Deep PVC DWV Pipe (50/Bag)	TC1D	800
87532	Tests 2" Deep PVC DWV Pipe (50/Bag)	TC2D	600
87533	Tests 3" Deep PVC DWV Pipe (25/Bag)	TC3D	250
87534	Tests 4" Deep PVC DWV Pipe (25/Bag)	TC4D	150



Deep Techno-Caps™ - ABS

- Extra deep solvent weld socket provides room for errors on pipe that is not cut straight
- Offers an economical solution to heavy duty PVC or ABS schedule 40 DWV end caps
- Tested to 5 stories of head pressure (22 psig)

PRODUCT	DESCRIPTION	MODEL	UNITS/CASE
87536	Tests 1-1/2" Deep ABS DWV Pipe (50/Bag)	TC1AD	800
87537	Tests 2" Deep ABS DWV Pipe (50/Bag)	TC2AD	600



Techno-Caps™ - PVC

- Heavy duty PVC test cap
- For 1-1/2", 2", 3" and 4" DWV pipe
- Can be solvent-welded on PVC pipe

- Will not clog or fall into pipe
- Can be tested up to 40' of water of 17 psig
- Also available in orange



PRODUCT	DESCRIPTION	MODEL	UNITS/CASE
87503	Tests 1-1/2" PVC DWV Pipe (100/Bag)	TC1	800
87505	Tests 2" PVC DWV Pipe (100/Bag)	TC2	600
87510	Tests 3" PVC DWV Pipe (50/Bag)	TC3	250
87515	Tests 4" PVC DWV Pipe (25/Bag)	TC4	150
87516	Tests 6" PVC DWV Pipe (10/Bag)	TC6	50

Test Dome™ Coupling

- Key on cap and a keyway on the body forces correct alignment during assembly and installation, which also prevents rotation. If cap is removed, when reinstalling you will hear the snap and feel a difference if the cap doesn't seat correctly.
- Synthetic pre-greased cap ensures the solvent cement does not bond/seize to the dome cap which prevents easy removal.
- Stainless-steel clamp secures the knot on the nylon cord. The molded parallel securing tabs on the top of the test cap accepts and secures the stainless-steel clamp during install.
- Color coded dome and coupling. Orange dome is 3" size. Silver dome is 4" size.
- Black coupling is ABS resin. White coupling is PVC resin.

- Spigot to hub connection configuration for easy fitting into plastic pipe connections. Spigot to spigot configuration is also offered.
- Color coded T-handle matches the dome color and allows for a strong pull of the nylon cord once pressure testing is complete.
- Installation text (TOP ARRIBA) on test dome coupling identifies the correct orientation for placement on the pipe. With the coupling positioned correctly, the dome will ALWAYS be in position for easy removal with the T-handle and cord.
- APMO IGC 122-2019 Certified
- ASTM D2661-21 Certified
- ASTM D2665-20 Certified



83474



83471

PRODUCT	DESCRIPTION	MODEL	UNITS/CASE
83470	3" ABS Test Dome Coupling	TD3ABS	6
83471	3" PVC Test Dome Coupling	TD3PVC	6
83472	4" ABS Test Dome Coupling	TD4ABS	6
83473	4" PVC Test Dome Coupling	TD4PVC	6
83474	4" ABS Test Dome Coupling SPGT	TD4SPABS	6
83475	4" PVC Test Dome Coupling SPGT	TD4SPPVC	6

Weld-On®
Guy Gray®
Waater-Tite®
ToughPans®
RTB
Test-Tite®
AB&A®
Studor®
Truebro®
Christy's®
FloodStop®
ProVent®
ProSet®

Techno-Caps™ - ABS



- Heavy duty ABS test cap
- Can be solvent-welded
- For 1-1/2", 2", 3" and 4" DWV pipe
- Will not clog or fall into pipe
- Can be tested up to 40' of water or 17 psig

PRODUCT	DESCRIPTION	MODEL	UNITS/CASE
87526	Tests 1-1/2" ABS DWV Pipe (100/Bag)	TC1A	800
87527	Tests 2" ABS DWV Pipe (100/Bag)	TC2A	600
87528	Tests 3" ABS DWV Pipe (50/Bag)	TC3A	250
87529	Tests 4" ABS DWV Pipe (25/Bag)	TC4A	150

Combination Kap-On Test Caps



86615

- Moderate-pressure test cap
- Higher rated than plug-on test caps
- For 1-1/2", 2", 3" and 4" DWV pipe
- Each cap can be used for two sizes
- Solvent-welded onto PVC or ABS pipe
- Can be tested up to 30' of water or 12 psig

PRODUCT	DESCRIPTION	MODEL	UNITS/CASE
86615	Tests 1-1/2" & 2" DWV Pipe (100/Bag)	K012	500
86620	Tests 3" & 4" DWV Pipe (50/Bag)	K034	250

Plug-On Test Caps



86615

- Low-pressure test cap
- For 1-1/2", 2", 3" and 4" DWV pipe
- Solvent-welded onto PVC or ABS pipe
- Can be tested up to 10' of water or 4.3 psig

PRODUCT	DESCRIPTION	MODEL	UNITS/CASE
85000	Tests 1-1/2" DWV Pipe (100/Bag)	5817P11/2	100
85005	Tests 2" DWV Pipe (50/Bag)	5817P2	1500
85010	Tests 3" DWV Pipe (25/Bag)	5817P3	600
85015	Tests 4" DWV Pipe (20/Bag)	5817P4	340

Slip-On Caps



85465

- For 1-1/2", 2", 3" and 4" DWV pipe
- Pushed onto PVC or ABS pipe
- Normally used as a "dust cap" to keep out debris
- Not designed for pressure
- Orange plastic

PRODUCT	DESCRIPTION	MODEL	UNITS/CASE
85450	Slip-on Test Cap for 1-1/2" DWV (40/Bag)	S01	600
85455	Slip-on Test Cap for 2" DWV (25/Bag)	S02	400
85460	Slip-on Test Cap for 3" DWV (25/bag)	S03	150
85465	Slip-on Test Cap for 4" DWV	S04	90

Flexible PVC Test Caps with Stainless Steel Clamp

- Moderate-pressure test cap
- For 1-1/2", 2", 3", 4" and 6" DWV pipe
- Can be used as a cleanout cap
- Used on plastic, steel, copper and cast iron pipe
- Flexible PVC construction
- Stainless steel clamp will not rust
- Can be tested up to 30' of water or 13 psig

PRODUCT	DESCRIPTION	MODEL	UNITS/CASE
83711	1-1/2" Cleanout Test Cap w/S.S. Clamping Band	83711	200
83712	2" Cleanout Test Cap w/S.S. Clamping Band	83712	100
83713	3" Cleanout Test Cap w/S.S. Clamping Band	83713	50
83714	4" Cleanout Test Cap w/S.S. Clamping Band	83714	50
83706	6" Cleanout Test Cap w/S.S. Clamping Band	83706	20



Shower Rough-In Test Plug

- Combination test plug and shower stub-out
- Hi-viz plastic for easy visibility
- Smooth threaded end for easy plastering
- Reusable and long lasting
- No tools required

PRODUCT	DESCRIPTION	MODEL	UNITS/CASE
83803	Shower Rough-In Test Plug	STP1	50



Guy Gray®
Water-Tite®
ToughPans®
RTB
Test-Tite®
AB&A®
Studor®
Truebro®
Christy's®
FloodStop®
ProVent®
ProSet®

ProSet®

ProVent®

FloodStop®

Christy's®

Truebro®

Studor®

AB&A®

Test-Tite®

RTB

ToughPans®

Waater-Tite®

Guy Gray®

Weld-On®

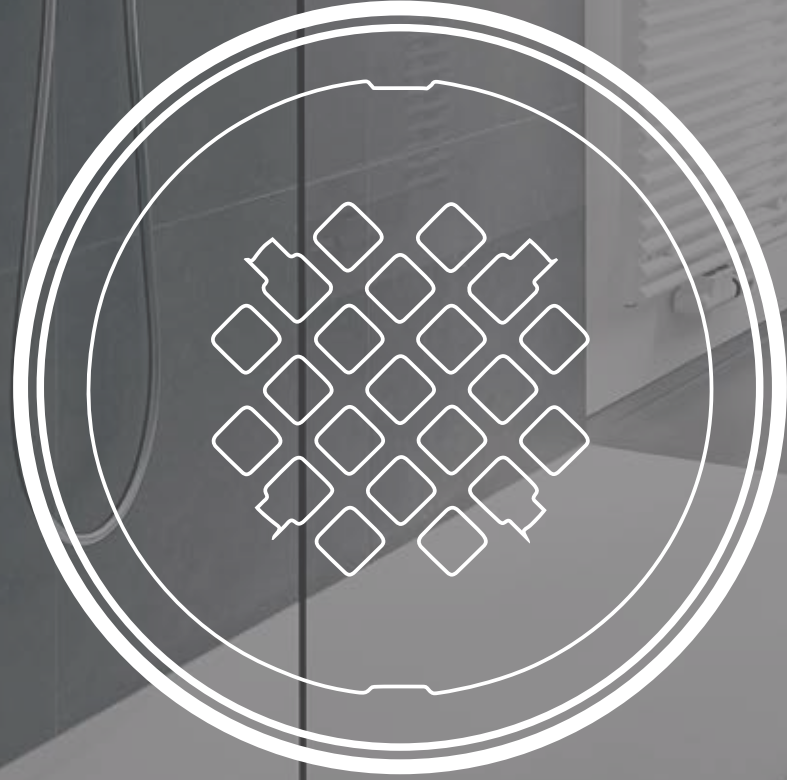

AB&A®

BRAND OVERVIEW

Broader offering for plumbing wholesalers & contractors

IPS Corporation® acquired the American Brass & Aluminum Foundry (AB&A®) in 2010. Since 1931, the AB&A® product family has grown to include a full line of plastic and brass bath wastes, plastic, cast iron and brass plumbing drains and fittings, cleanouts, and associated accessories.

High quality wastes and drains

Easy-to-install AB&A® bath wastes are offered in an assortment of special finishes to complement today's designs and customer preferences. A wide range of lavatory, floor, and shower drains are available in plastic, bronze, or cast brass. Recognized for their consistent high quality, AB&A® products are used in both new construction and retrofit markets.



Techno Flange® Closet Flanges



- One-piece knockout will not fall down drain line
- Knockout breaks out in one piece
- Inset test cap cannot be damaged by construction equipment
- Beveled hub design allows easier insertion into 4" foam core pipe
- Available with stainless steel or powder-coated adjustable ring
- Flush-Tite design allows flush installation inside 4" pipe
- Fits 3" or 4" Sch. 40 DWV pipe



86132

LISTINGS	PRODUCT	DESCRIPTION	MODEL	UNITS/CASE
UPC	86132	Standard Pattern w/Techno Knockout for 3" or 4" PVC Pipe	4830TFK	40
	86137	Standard Pattern w/Techno Knockout for 3" or 4" ABS Pipe	5830TFK	40

Flush-Tite Closet Flanges



86150

- Solvent weld installation only
- For over 3" or inside 4" Sch. 40 DWV pipe
- Available for 4" hub fit
- Available in standard or long pattern, with or without pipe stop
- Also available for inside 3" pipe

LISTINGS	PRODUCT	DESCRIPTION	MODEL	UNITS/CASE
UPC	86150	Standard Pattern w/o Knockout for PVC Pipe, w/o Pipe Stop	48302	40
	86155	Standard Pattern w/o Knockout for ABS Pipe, w/o Pipe Stop	58302	40
	86151	Long Pattern w/o Knockout for PVC Pipe, w/o Pipe Stop	4830LP	40
	86140	Long Pattern w/o Knockout for PVC Pipe, with Pipe Stop	4830	40
	86145	Long Pattern w/o Knockout for ABS Pipe, with Pipe Stop	5830	40
	86149	Fits Inside 3" Sch. 40 DWV PVC Pipe, w/o Knockout	48301	20
	86160	Fits Inside 3" Sch. 40 DWV ABS Pipe, w/o Knockout	58301	20
	86130	Standard Pattern with Knockout for PVC Pipe	4830KO	40
	86135	Standard Pattern with Knockout for ABS Pipe	5830KO	40
	86131	Long Pattern with Knockout for PVC Pipe	4830LPK	40
	86126	Fits Over 4" Sch. 40 DWV PVC Pipe, w/o Knockout	4824	20
	86127	Fits Over 4" Sch. 40 DWV ABS Pipe, w/o Knockout	5824	20
	86128	Fits Over 4" Sch. 40 DWV PVC Pipe, With Knockout	4824KO	20

Techno Flange® Closet Flanges with Metal Adjustable Ring

- One-piece knockout will not fall down drain line
- Knockout breaks out in one piece
- Inset test cap cannot be damaged by construction equipment
- Beveled hub design allows easier insertion into 4" foam core pipe
- Available with stainless steel or powder-coated adjustable ring
- Flush-Tite design allows flush installation inside 4" pipe
- Fits 3" or 4" Sch. 40 DWV pipe



LISTINGS	PRODUCT	DESCRIPTION	MODEL	UNITS/CASE
	86173	With Techno Knockout for 3" or 4" PVC Pipe	4830ATF	40
	86177	With Techno Knockout for 3" or 4" PVC Pipe/SS Ring	4830ASTF	40
	86178	With Techno Knockout for 3" or 4" ABS Pipe/SS Ring	5830ASTF	40



86177

Flush-Tite Closet Flanges with Metal Adjustable Ring

- Metal adjustable ring allows for easy alignment of bolts and screws
- For over 3" or inside 4" Sch. 40 DWV pipe
- Available in standard or long pattern, with or without pipe stop
- Also available for 4" hub fit



86166

LISTINGS	PRODUCT	DESCRIPTION	MODEL	UNITS/CASE
	86166	Without Knockout for 3" or 4" PVC Pipe, w/o Pipe Stop	4830A2	40
	86175	Without Knockout for 3" or 4" ABS Pipe, w/o Pipe Stop	5830A2	40
	86179	With Stainless Steel Ring, 3" or 4" PVC, w/o Pipe Stop	4830AS2	40
	86182	With Stainless Steel Ring, 3" or 4" ABS, w/o Pipe Stop	5830AS2	40
	86165	With Knockout for 3" or 4" PVC Pipe	4830A	40
	86170	With Knockout for 3" or 4" ABS Pipe	5830A	40
	86141	Fits Over 4" Sch. 40 DWV PVC Pipe, w/o Knockout	4824A	20
	86142	Fits Over 4" Sch. 40 DWV ABS Pipe, w/o Knockout	5824A	20

Offset Closet Flange

- 1-1/2" offset from center
- All plastic

LISTINGS	PRODUCT	DESCRIPTION	MODEL	UNITS/CASE
	86180	For 3" or 4" PVC Pipe	4831	20
	86185	For 3" or 4" ABS Pipe	5831	20



86180

Offset Closet Flange with Metal Ring



86181

- Adjustable ring allows for easy alignment of bolts and screws
- Full 3" flow allows for a clog-free opening
- Fits 3" or 4" PVC and ABS DWV Pipe
- 1.5" offset allows for margin of error for pipe flange alignment

LISTINGS	PRODUCT	DESCRIPTION	MODEL	UNITS/CASE
With Adjustable Stainless Steel Ring				
86181	3" x 4" PVC Offset Closet Flange with Stainless Steel Ring		4831M	20
86186	3" x 4" ABS Offset Closet Flange with Stainless Steel Ring		5831M	20
With Adjustable Stainless Steel Ring and Knockout				
86245	3" x 4" PVC Offset Closet Flange with Stainless Steel Ring & Knockout		4831MKO	20
86246	3" x 4" ABS Offset Closet Flange with Stainless Steel Ring & Knockout		5831MKO	20
With Powder Coated Steel Ring				
86247	3" x 4" PVC Offset Closet Flange with Powder Coated Steel Ring		4831A	20
86248	3" x 4" ABS Offset Closet Flange with Powder Coated Steel Ring		5831A	20



86245

45° Closet Flange



86196

- Allows for plumbing in tight areas
- Available as all plastic or with stainless steel adjustable ring
- Available with or without knockout

LISTINGS	PRODUCT	DESCRIPTION	MODEL	UNITS/CASE
86196	45° PVC Closet Flange w/ Plastic Adjustable Ring		4845P	20
86197	45° ABS Closet Flange w/ Plastic Adjustable Ring		5845P	20
86198	45° PVC Closet Flange w/ S.S. Adjustable Ring		4845S	20
86199	45° ABS Closet Flange w/ S.S. Adjustable Ring		5845S	20
86201	45° PVC Closet Flange w/ Plastic Adjustable Ring/KO		4845PKO	20
86203	45° PVC Closet Flange w/ S.S. Adjustable Ring/KO		4845SKO	20



86203

Long Closet Flange



86147

- Allows for plumbing in tight areas
- Available as all plastic or with stainless steel adjustable ring
- Available with or without knockout

PRODUCT	DESCRIPTION	MODEL	UNITS/CASE
86147	Long Closet Flange – PVC	4846S	10
86148	Long Closet Flange – ABS	5846S	10

Weld-On®
Guy Gray®
Waater-Tite®
ToughPans®
RTB
Test-Tite®
AB&A®
Studor®
Truebro®
Christy's®
FloodStop®
ProVent®
ProSet®

Push 'N Repair® Closet Flange

- One-piece construction / gasket permanently attached to hub of flange
- Seals the entire length of the tailpiece extension
- Can be cut to desired length
- Available in PVC or ABS
- No bolts to tighten
- Full 3" of flow, no obstructions of bolts
- Easy push-in installation
- Pre-lubricated gasket
- Fits 4" PVC, DWV, No-hub-service weight & extra heavy cast iron

PRODUCT	DESCRIPTION	MODEL	UNITS/CASE
86191	3" PVC Push N' Repair Closet Flange	4843	5
86192	3" ABS Push N' Repair Closet Flange	5843	5
86193	4" PVC Push N' Repair Closet Flange	4844	5
86194	4" ABS Push N' Repair Closet Flange	5844	5



86191

Stainless Steel Extension Ring

- Stainless Steel will not rust
- Use multiple rings to adjust height

PRODUCT	DESCRIPTION	MODEL	UNITS/CASE
86187	Stainless Steel Ring Only	86187	20



86187

Closet Flange Extension Rings



86209

- Builds up existing closet flange when new flooring leaves it below grade for proper seal
- At 1/4" thick, multiples may be stacked to desired height
- 1 pair per header sleeve

PRODUCT	DESCRIPTION	MODEL	UNITS/CASE
86208	Pair of 1/4" Thick Extension Rings	86208	20 Pr.
86209	Kit of 3 Extension Rings & 2 Closet Bolts, Nuts, Washers	86209	20 Kits

Closet Flange Stabilizer



86133

- Eliminates water closet from rocking
- Optimal for concrete slabs or wooden floors
- 9-3/8" x 9-3/8"

PRODUCT	DESCRIPTION	MODEL	UNITS/CASE
86133	4" Closet Flange Stabilizer	CS4	25

Adjustable Urinal Flange Kits



86133

- Builds up existing closet flange when new flooring leaves it below grade for proper seal
- At 1/4" thick, multiples may be stacked to desired height
- 1 pair per header sleeve

PRODUCT	DESCRIPTION	MODEL	UNITS/CASE
68004	Urinal Fl Socket Adj PVC 2"	ABA8548	20
68005	Urinal Fl Spigot Adj PVC 2"	ABA8549	20
65362	Urinal Fl Socket Adj ABS 2"	ABA8545	20
65363	Urinal Fl Spigot Adj ABS 2"	ABA8546	20

SetFast® Closet Bolt



42443

53990

The SetFast® bolt is the first telescopic closet bolt that requires "No Cutting" or "Break Off". SetFast® bolts install like a standard closet bolt but adjust like no other. Just tighten the nut and watch the bolt get shorter with every turn. SetFast® bolts are a real time saver that simplifies both toilet installation and removal. Sold in pairs, 2 bolts per pack.

- Professional grade 5/16" solid brass with stainless steel washers
- No Tipping
- No Cutting or Break-off
- No Spinning
- Self Adjusting Length (42443 only)
- Adjustable Length (53990). Great for installations where the closet flange is below the finished floor.

PRODUCT	DESCRIPTION	MODEL	UNITS/CASE
42443	SetFast® Self Adjusting Closet Bolt – Standard Length – 5/16" x 2-1/4"	42443	100
42450	SetFast® Self Adjusting Closet Bolt – Standard Length – 5/16" x 2-1/4", Counter Display Unit	42443CDU	100
53990	SetFast® Adjustable Closet Bolt – Extended Length – 5/16" x 3"	53990	50

Wax Closet Gaskets

- Builds up existing closet flange when new flooring leaves it below grade for proper seal
- At 1/4" thick, multiples may be stacked to desired height
- 1 pair per header sleeve

PRODUCT	DESCRIPTION	MODEL	UNITS/CASE
Standard Wax Closet Gasket			
82550	Standard Wax Closet Gasket	RWG1	48
82563	Standard Wax Closet Gasket with No Mess Tray	RWG1T	48
82555	Standard Wax Closet Gasket with Plastic Horn	RWG2	24
82565	Reinforced Wax Closet Gasket with Plastic Horn	RNWG1	24
Standard Wax Closet Gasket with Bolts			
87760	Standard Wax Closet Gasket with Brass Bolt Kit	RWG3	48
82556	Standard Wax Closet Gasket with Double-Nut Brass Bolt Kit	RWG7	48
82551	Standard Wax Closet Gasket with SetFast® Self-Adjusting Closet Bolts (42443)	RWGSF1	48
82552	Standard Wax Closet Gasket with Plastic Horn and Brass Bolt Kit	RWG4	24
82554	Standard Wax Gasket with Plastic Horn and Brass-Plated Bolt Kit	RWG6	24
82557	Standard Wax Closet Gasket with Plastic Horn and Double-nut Brass Bolt Kit	RWG8	24
82558	Standard Wax Closet Gasket with Plastic Horn and SetFast® Self-Adjusting Closet Bolts (42443)	RWGSF2	24
Jumbo Wax Closet Gasket			
82560	Jumbo Wax Closet Gasket	RWG1J	48
82561	Jumbo Wax Closet Gasket with Plastic Horn	RWG2J	24
Jumbo Wax Closet Gasket with Bolts			
82566	Jumbo Wax Closet Gasket with SetFast® Self-Adjusting Closet Bolts (42443)	RWGSFJ	48
82553	Jumbo Wax Closet Gasket with Plastic Horn and 3.5" Brass-plated Bolt Kit	RWG5	24
82559	Jumbo Wax Closet Gasket with Plastic Horn and 3.5" Double-nut Brass Bolt Kit	RWG10	24



82550



82565



83559

Weld-On®
Guy Gray®
Water-Tite®
ToughPans®
RTB
Test-Tite®
AB&A®
Studor®
Truebro®
Christy's®
FloodStop®
ProVent®
ProSet®

TOILET BOLT LOCK WRENCH / AB&A® / IPS

Jam-Bar

Toilet bowl removal can be difficult if the bolt(s) are corroded or have damaged ends. Forcing the nut can often cause the bolt to break free and spin. Because space is limited, holding back on the bolt using conventional tools can be difficult. The "Jam-Bar" is a thin bladed wrench designed to fit into tight spaces. The patented fork-like blade and serrated teeth grip and hold the bolt. The more the bolt tries to spin, the tighter the grip. Works on both 1/4" and 5/16" bolts.

- Simplifies toilet and tank removal
- Quality tool steel
- Grips 1/4" to 5/16" threaded bolts

PRODUCT	DESCRIPTION	MODEL	UNITS/CASE
53991	Jam-Bar Toilet Bolt Lock Wrench	53991	8



22725

Fiberglass and Acrylic Floor Shower Drains

- Available connections: solvent weld, SUREFIT, caulk, no-caulk, and 2" male or female IPS
- Designed for pre-formed shower bases



67017

LISTINGS	PRODUCT	DESCRIPTION	MODEL	UNITS/CASE
Plastic Body Drains				
Solvent Weld – 2"				
	67015	ABS – White Plastic Strainer – Snap-in (7210 Series)	ABA3400	36
	67017	PVC – White Plastic Strainer – Snap-in (7210 Series)	ABA3408	36
	67016	ABS – Stainless Steel Strainer – Snap-in (7200 Series)	ABA3401	36
	67018	PVC – Stainless Steel Strainer – Snap-in (7200 Series)	ABA3409	36



86055

LISTINGS	PRODUCT	DESCRIPTION	MODEL	UNITS/CASE
Solvent Weld OR No-Caulk – 2"				
	86055	ABS – Stainless Steel Strainer – Snap-in (44010 Series)	5820G	20
	86050	PVC – Stainless Steel Strainer – Snap-in (44010 Series)	4820G	20
	82405	PVC – Stainless Steel Strainer – Snap-in – Display Pack (44010 Series)	R4820G	6



67012

LISTINGS	PRODUCT	DESCRIPTION	MODEL	UNITS/CASE
No-Caulk – 2" SUREFIT Joint				
	67012	ABS – White Plastic Strainer – Snap-in (7103 Series)	ABA3200	20
	67065	PVC – White Plastic Strainer – Snap-in (7103 Series)	ABA3202	20
	67013	ABS – Stainless Steel Strainer – Snap-in (7101 Series)	ABA3201	20
	67014	PVC – Stainless Steel Strainer – Snap-in (7101 Series)	ABA3203	20



67022

PRODUCT	DESCRIPTION	MODEL	UNITS/CASE
No-Caulk – 2" Gasket for DWV			
67021	White Plastic with Plastic Strainer – Snap-in (7210 Series)	ABA3520	36
67022	White Plastic with SS Strainer – Snap-in (7200 Series)	ABA3521	36



67042

PRODUCT	DESCRIPTION	MODEL	UNITS/CASE
Brass Body Drains			
No-Caulk – 2" SUREFIT Joint			
67041	SUREFIT Joint – Brass Body – 2" – SS Snap-in (7101 Series)	ABA6508	18
No-Caulk – 2" Gasket for DWV			
67042	No-Caulk – Brass Body – 2" – SS Snap-in (7200 Series)	ABA6520	18
IPS – 2" Female Thread			
67218	2" Female IPS – Brass Body – SS Snap-in (7200 Series)	ABA6828	8
Caulk – 2"			
67040	Caulk Type – Brass Body – 2" – SS Snap-in (7101 Series)	ABA6500	18

Weld-On®
Guy Gray®
Waater-Tite®
ToughPans®
RTB
Test-Tite®
AB&A®
Studor®
Truebro®
Christy's®
FloodStop®
ProVent®
ProSet®

Fiberglass and Acrylic Floor Shower Drain Components

PRODUCT	DESCRIPTION	MODEL	UNITS/CASE
Plastic Shower Drain Locknut (3400 - 3456 Series)			
69521	ABS Locknut	ABA7005	15
68068	PVC Locknut	ABA7006	15
No-Caulk Components			
69202	"No-Caulk" Neoprene Sealing Joint for DWV Pipe	ABA7215	15
60925	"No Caulk" Neoprene Sealing Joint for CTS Pipe	ABA7216	
69203	Caulking Key	ABA7218	15
69204	Brass - Inside Caulking Ring	ABA7226	15
SUREFIT Components			
69500	SUREFIT Gasket Set	ABA2400	36

Snap-in Strainers

PRODUCT	DESCRIPTION	MODEL	UNITS/CASE
Round 4-1/4" Snap-In Steel Grate (7200-7210 Series)			
69554	Chrome	ABA7200	15
69555	Chrome – Carded	ABA7200CARD	15
69560	Satin Nickel – Carded	ABA7205SNCARD	1
69776	Venetian Bronze – Carded	ABA7205VBCARD	1
69773	Oil Rubbed Bronze – Carded	ABA7205ORBCARD	1
67298	Matte Black – Carded	ABA7205MBCARD	1
69155	Champagne Bronze – Carded	ABA7205CBCARD	1
69181	White (Plastic ABS)	ABA7210	15
63348	White (Plastic ABS) – Carded	ABA7210CARD	15
Round 4-1/4" Snap-In Steel Grate (7101-7103 Series)			
69774	Chrome – Carded	ABA7101CARD	15
64991	Satin Nickel – Carded	ABA7101SNCARD	1
69536	Venetian Bronze – Carded	ABA7101VBCARD	1
69530	Oil Rubbed Bronze – Carded	ABA7101ORBCARD	1
69689	Matte Black – Carded	ABA7101MBCARD	1
69688	Champagne Bronze – Carded	ABA7101CBCARD	1
69524	White (Plastic ABS)	ABA7103	15
69770	White (Plastic ABS) – Carded	ABA7103CARD	1

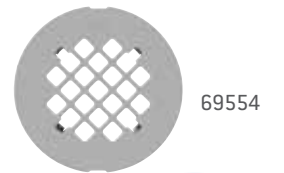

69554

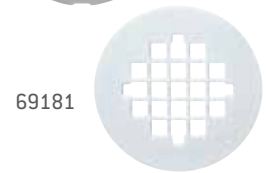

69181



69774

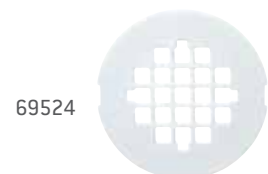

69524

Weld-On®

Guy Gray®

Water-Tite®

ToughPans®

RTB

Test-Tite®

AB&A®

Studor®

Truebro®

Christy's®

FloodStop®

ProVent®

ProSet®

Receptor Base Fiberglass Shower Drains



63500

- Fits 2" pipe (solvent weld)
- Residential showers with preformed bases
- Strainers: round snap-in or screw down
- Available in ABS (black) or PVC (white)
- Easy to use test plug is included
- Tightening bar included

LISTINGS	PRODUCT	DESCRIPTION	MODEL	UNITS/CASE
Solvent Weld – 2" Rib Grip – SS Screw Down Strainer (44000 Series)				
63490	ABS		ABA34490	20
63500	PVC		ABA34500	20
Solvent Weld – 2" Rib Grip – SS Snap-On Strainer (44010 Series)				
63491	ABS		ABA34490SNAP	20
63501	PVC		ABA34500SNAP	20



Offset Receptor Base Fiberglass Shower Drains



67076

PRODUCT	DESCRIPTION	MODEL	UNITS/CASE
Offset Solvent Weld – 2" – SS Strainer (44000 Series)			
67032	PVC	ABA3465	20
67076	ABS	ABA3469	20

Weld-On®
Guy Gray®
Waater-Tite®
ToughPans®
RTB
Test-Tite®
AB&A®
Studor®
Truebro®
Christy's®
FloodStop®
ProVent®
ProSet®

Tile Shower Drain with Reversible Clamping Ring - Round Stamped Grate

- Fits 2" hub or 3" inside fit (solvent weld)
- Residential showers with tile flooring
- Strainers: round or square, stamped steel snap-in or screw down, and heavy cast brass screw down
- Square barrel accessory allows installer to convert round drains to square
- Available in ABS (black) or PVC (gray)
- Easy to use test plug is included

LISTINGS	PRODUCT	DESCRIPTION	MODEL	UNITS/CASE
ABS Body, Flange, and Tailpiece - 2" x 3" Solvent Weld, Round Stamped Strainer (44000 Series)				
	63601	Tile Shower Round Stamped CP – ABS	ABA44601	20
	63641	Tile Shower Round Stamped Plas Crown CP – ABS	ABA44601CR	20
	63600	Tile Shower Round Stamped Snap CP – ABS	ABA44601SNAP	20
	PVC Body, Flange, and Tailpiece - 2" x 3" Solvent Weld, Round Stamped Strainer (44000 Series)			
	63608	Tile Shower Round Stamped CP – PVC	ABA44701	20
	63642	Tile Shower Round Stamped Plas Crown CP – PVC	ABA44701CR	20
	63607	Tile Shower Round Stamped Snap CP – PVC	ABA44701SNAP	20



63601



63608

Replacement Grates for Receptor Base & Tile Drains – Round

PRODUCT	DESCRIPTION	MODEL	UNITS/CASE
Round 4-1/4" Stamped SS Shower Grate w/Screws on 2-5/8" Center - Cover-All (44000 Series)			
63614	Round Stamped Grate w/Screws CP	ABA44000	12
63615	Round Stamped Grate w/Screws SN	ABA44000SN	4
63616	Round Stamped Grate w/Screws VB	ABA44000VB	4
63617	Round Stamped Grate w/Screws ORB	ABA44000ORB	4
63612	Round Stamped Grate w/Screws MB	ABA44000MB	4
63613	Round Stamped Grate w/Screws CB	ABA44000CB	4
Round 4-1/4" Stamped SS Shower Grate Snap-In - Cover-All (44010 Series)			
63618	Round Stamped Snap-In Grate CP	ABA44010	12
63619	Round Stamped Snap-In Grate SN	ABA44010SN	4
63620	Round Stamped Snap-In Grate VB	ABA44010VB	4
63621	Round Stamped Snap-In Grate ORB	ABA44010ORB	4
63643	Round Stamped Snap-In Grate MB	ABA44010MB	4
63646	Round Stamped Snap-In Grate CB	ABA44010CB	4
Round 4" Stamped SS Shower Grate w/Screws on 3-3/8" Center - Plastic Crown (7102 Series)			
x	Round Stamped Grate w/Screws Crown CP	ABA7102CARD	15
69543	Round Stamped Grate w/Screws Crown SN	ABA7102SNCARD	15
69544	Round Stamped Grate w/Screws Crown VB	ABA7102VBCARD	15
69541	Round Stamped Grate w/Screws Crown ORB	ABA7102ORBCARD	15
69546	Round Stamped Grate w/Screws Crown MB	ABA7102MBCARD	15
69529	Round Stamped Grate w/Screws Crown CB	ABA7102CBCARD	15



63615



63618



69835

Weld-On®
Guy Gray®
Water-Tite®
ToughPans®
RTB
Test-Tite®
AB&A®
Studor®
Truebro®
Christy's®
FloodStop®
ProVent®
ProSet®

Tile Shower Drain with Reversible Clamping Ring - Square Stamped Grate

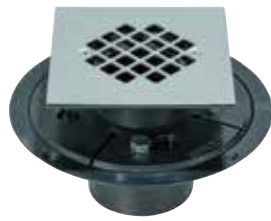

63602



63609

- Fits 2" hub or 3" inside fit (solvent weld)
- Residential showers with tile flooring
- Strainers: round or square, stamped steel snap-in or screw down, and heavy cast brass screw down
- Square barrel accessory allows installer to convert round drains to square
- Available in ABS (black) or PVC (gray)
- Easy to use test plug is included

LISTINGS	PRODUCT	DESCRIPTION	MODEL	UNITS/CASE
ABS Body, Flange, and Tailpiece - 2" x 3" Solvent Weld, Square Stamped Strainer (44030 Series)				
	63602	Tile Shower Square Stamped CP	ABA44601SQ	20
	63630	Tile Shower Square Stamped Snap CP	ABA44601SQSNAP	20
PVC Body, Flange, and Tailpiece - 2" x 3" Solvent Weld, Square Stamped Strainer (44030 Series)				
	63609	Tile Shower Square Stamped CP	ABA44701SQ	20
	63631	Tile Shower Square Stamped Snap CP	ABA44701SQSNAP	20



Replacement Grates for Receptor Base & Tile Drains – Square

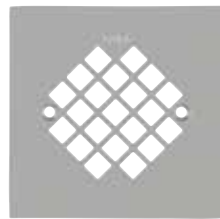

63626



63639

PRODUCT	DESCRIPTION	MODEL	UNITS/CASE
Square 4-1/4" Stamped SS Shower Grate w/Screws on 2-5/8" Center (44030 Series)			
63626	Square Stamped Grate w/ Screws CP	ABA44030	12
63627	Square Stamped Grate w/ Screws SN	ABA44030SN	15
63628	Square Stamped Grate w/ Screws VB	ABA44030VB	15
63629	Square Stamped Grate w/ Screws ORB	ABA44030ORB	15
63649	Square Stamped Grate w/ Screws MB	ABA44030MB	15
63650	Square Stamped Grate w/ Screws CB	ABA44030CB	15
Square 4-1/4" Stamped SS Shower Grate Snap-In (44050 Series)			
63639	Square Stamped Snap-In Grate CP	ABA44050	12
63632	Square Stamped Snap-In Grate SN	ABA44050SN	15
63633	Square Stamped Snap-In Grate VB	ABA44050VB	15
63634	Square Stamped Snap-In Grate ORB	ABA44050ORB	15
63651	Square Stamped Snap-In Grate MB	ABA44050MB	15
63652	Square Stamped Snap-In Grate CB	ABA44050CB	15

Tile Shower Drain with Reversible Clamping Ring - Round Cast Brass Grate

- Fits 2" hub or 3" inside fit (solvent weld)
- Residential showers with tile flooring
- Strainers: round or square, stamped steel snap-in or screw down, and heavy cast brass screw down
- Square barrel accessory allows installer to convert round drains to square
- Available in ABS (black) or PVC (gray)
- Easy to use test plug is included

LISTINGS	PRODUCT	DESCRIPTION	MODEL	UNITS/CASE
ABS Body, Flange, and Tailpiece - 2" x 3" Solvent Weld, Round Cast Brass Strainer (44020 Series)				
	63603	Tile Shower Round Cast CP (44020 Series)	ABA44603	20
	63661	Tile Shower Round Cast SN (44020 Series)	ABA44603SN	4
	63662	Tile Shower Round Cast ORB (44020 Series)	ABA44603ORB	4
	63663	Tile Shower Round Cast VB (44020 Series)	ABA44603VB	4
	PVC Body, Flange, and Tailpiece - 2" x 3" Solvent Weld, Round Cast Brass Strainer (44020 Series)			
	63610	Tile Shower Round Cast CP (44020 Series)	ABA44703	20
	63664	Tile Shower Round Cast SN (44020 Series)	ABA44703SN	4
	63665	Tile Shower Round Cast VB (44020 Series)	ABA44703VB	4
	63666	Tile Shower Round Cast ORB (44020 Series)	ABA44703ORB	4



63603



63610

Strainers

- Available strainers: round stamped stainless steel, round heavy duty cast brass, or square heavy duty cast brass
- Available connections: 2" x 3" solvent weld or 2" no-caulk

PRODUCT	DESCRIPTION	MODEL	UNITS/CASE
Round 4-1/4" Cast Brass Shower Grate w/Screws on 2-5/8" Center (44020 Series)			
63622	Round Cast Grate w/ Screws CP	ABA44020	4
63623	Round Cast Grate w/ Screws SN	ABA44020SN	4
63624	Round Cast Grate w/ Screws VB	ABA44020VB	4
63625	Round Cast Grate w/ Screws ORB	ABA44020ORB	4
63644	Round Cast Grate w/ Screws MB	ABA44020MB	4
63647	Round Cast Grate w/ Screws CB	ABA44020CB	4

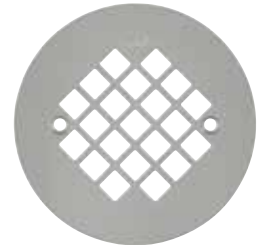

63622

Tile Shower Drain with Reversible Clamping Ring - Square Cast Brass Grate



63604



63611

- Fits 2" hub or 3" inside fit (solvent weld)
- Residential showers with tile flooring
- Strainers: round or square, stamped steel snap-in or screw down, and heavy cast brass screw down
- Square barrel accessory allows installer to convert round drains to square
- Available in ABS (black) or PVC (gray)
- Easy to use test plug is included

LISTINGS	PRODUCT	DESCRIPTION	MODEL	UNITS/CASE
ABS Body, Flange, and Tailpiece - 2" x 3" Solvent Weld, Square Cast Brass Strainer [44040 Series]				
63604	Tile Shower Square Cast CP		ABA44603SQ	20
63605	Tile Shower Square Cast SN		ABA44603SQSN	4
63606	Tile Shower Square Cast VB		ABA44603SQVB	4
63660	Tile Shower Square Cast ORB		ABA44603SQORB	4
PVC Body, Flange, and Tailpiece - 2" x 3" Solvent Weld, Square Cast Brass Strainer [44040 Series]				
63611	Tile Shower Square Cast CP		ABA44703SQ	20
63667	Tile Shower Square Cast SN		ABA44703SQSN	4
63668	Tile Shower Square Cast VB		ABA44703SQVB	4
63669	Tile Shower Square Cast ORB		ABA44703SQORB	4



Strainers



63635

PRODUCT	DESCRIPTION	MODEL	UNITS/CASE
Square 4-1/4" Cast Brass Shower Grate w/Screws on 2-5/8" Center [44040 Series]			
63635	Square Cast Grate w/ Screws CP	ABA44040	4
63636	Square Cast Grate w/ Screws SN	ABA44040SN	4
63637	Square Cast Grate w/ Screws VB	ABA44040VB	4
63638	Square Cast Grate w/ Screws ORB	ABA44040ORB	4
63645	Square Cast Grate w/ Screws MB	ABA44040MB	4
63648	Square Cast Grate w/ Screws CB	ABA44040CB	4

Tile Shower Drain with Reversible Clamping Ring - Round Cast Brass Grate - Brass Barrel

LISTINGS	PRODUCT	DESCRIPTION	MODEL	UNITS/CASE
	ABS Body, Flange, and Tailpiece - 2" x 3" Solvent Weld, Round Cast Brass Barrel & Strainer (7212 Series)			
	63800	Tile Shower Round Brass Barrel Cast CP	ABA44603BB	4
	63804	Tile Shower Round Brass Barrel Cast SN	ABA44603BBSN	4
	63805	Tile Shower Round Brass Barrel Cast VB	ABA44603BBVB	4
	63806	Tile Shower Round Brass Barrel Cast ORB	ABA44603BBORB	4
	PVC Body, Flange, and Tailpiece - 2" x 3" Solvent Weld, Round Cast Brass Barrel & Strainer (7212 Series)			
	63802	Tile Shower Round Brass Barrel Cast CP	ABA44703BB	4
	63810	Tile Shower Round Brass Barrel Cast SN	ABA44703BBSN	4
	63811	Tile Shower Round Brass Barrel Cast VB	ABA44703BBVB	4
	63812	Tile Shower Round Brass Barrel Cast ORB	ABA44703BBORB	4



63800



63802

Round Strainers

PRODUCT	DESCRIPTION	MODEL	UNITS/CASE
Round 3-15/16" Cast Brass Shower Grate w/ Screws on 3-3/8" Center – For Brass Strainer Barrels (7212 Series)			
63349	Round Cast Grate w/ Screws Crown CP	ABA7212CARD	15
67312	Round Cast Grate w/ Screws Crown SN	ABA7213SNCARD	15
67315	Round Cast Grate w/ Screws Crown VB	ABA7213VBCARD	15
67309	Round Cast Grate w/ Screws Crown ORB	ABA7213ORBCARD	15
67317	Round Cast Grate w/ Screws Crown MB	ABA7213MBCARD	15
67331	Round Cast Grate w/ Screws Crown CB	ABA7213CBCARD	15



63349

Tile Shower Drain with Reversible Clamping Ring - Square Cast Brass Grate - Brass Barrel



LISTINGS	PRODUCT	DESCRIPTION	MODEL	UNITS/CASE
	ABS Body, Flange, and Tailpiece - 2" x 3" Solvent Weld, Square Cast Brass Barrel & Strainer (72121 Series)			
	63801	Tile Shower Square Brass Barrel Cast CP	ABA44603BBSQ	4
	63807	Tile Shower Square Brass Barrel Cast SN	ABA44603BBSQSN	4
	63808	Tile Shower Square Brass Barrel Cast VB	ABA44603BBSQVB	4
	63809	Tile Shower Square Brass Barrel Cast ORB	ABA44603BBSQORB	4
	PVC Body, Flange, and Tailpiece - 2" x 3" Solvent Weld, Round Cast Brass Barrel & Strainer (72121 Series)			
	63803	Tile Shower Square Brass Barrel Cast CP	ABA44703BBSQ	4
	63813	Tile Shower Square Brass Barrel Cast SN	ABA44703BBSQSN	4
	63814	Tile Shower Square Brass Barrel Cast VB	ABA44703BBSQVB	4
	63815	Tile Shower Square Brass Barrel Cast ORB	ABA44703BBSQORB	4

Square Strainers

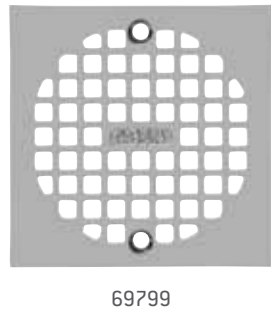

PRODUCT	DESCRIPTION	MODEL	UNITS/CASE
	Square 4-1/4" Cast Brass Shower Grate w/ Screws on 3-3/8" Center (72121 Series)		
69799	Square Cast Grate w/ Screws CP (for brass barrel)	ABA72121CARD	15
69802	Square Cast Grate w/ Screws SN (for brass barrel)	ABA72132SNCARD	15
69803	Square Cast Grate w/ Screws VB (for brass barrel)	ABA72132VBCARD	15
69804	Square Cast Grate w/ Screws ORB (for brass barrel)	ABA72132ORBCARD	15
69195	Square Cast Grate w/ Screws MB (for brass barrel)	ABA72132MBCARD	15
69850	Square Cast Grate w/ Screws CB (for brass barrel)	ABA72132CBCARD	15

Accessories for Tile Shower Drains



PRODUCT	DESCRIPTION	MODEL	UNITS/CASE
	ABS		
63696	ABS Square Barrel w/Snap-In Grate CP	ABA44601SQSNAPB	12
	PVC		
63695	PVC Square Barrel w/Snap-In Grate CP	ABA44701SQSNAPB	4
63694	PVC Long Round Barrel (no grate)	ABA447701LB	4

General Purpose Drains

- 1-1/2" male IPS
- For mobile homes and RVs

PRODUCT	DESCRIPTION	MODEL	UNITS/CASE
67028	White Plastic Grate – Snap-in (7103 Series)	ABA3100	36
67029	Stainless Steel Grate – Snap-in (7101 Series)	ABA3101	36



67028

Strainers

PRODUCT	DESCRIPTION	MODEL	UNITS/CASE
Round 4-1/4" Snap-In Steel Grate (7101-7103 Series)			
69774	Chrome – Carded	ABA7101CARD	15
64991	Satin Nickel – Carded	ABA7101SNCARD	1
69536	Venetian Bronze – Carded	ABA7101VBCARD	1
69530	Oil Rubbed Bronze – Carded	ABA7101ORBCARD	1
69689	Matte Black – Carded	ABA7101MBCARD	1
69688	Champagne Bronze – Carded	ABA7101CBCARD	1
69524	White (Plastic ABS)	ABA7103	15
69770	White (Plastic ABS) – Carded	ABA7103CARD	1



69774



69524

Cast Bronze Shower Drains – Complete – Round

Available connections:

- 2" IPS
- 2" caulk
- 2" sweat

Strainer options:

- Stamped stainless steel
- Round heavy duty cast brass
- Recommended for copper pan installations

PRODUCT	DESCRIPTION	MODEL	UNITS/CASE
1-3/8" Brass Barrel w/ 4-1/2" Stainless Steel Grate (7135 Series)			
67037	2" Caulk	ABA6410	18
67038	2" IPS	ABA6420	18
67178	2" Sweat	ABA6430	8
2-1/2" Brass Barrel w/ 4-1/2" Stainless Steel Grate (7135 Series)			
67177	2" Caulk	ABA6415	8
67039	2" IPS	ABA6425	8
67179	2" Sweat	ABA6435	8



67178

Strainers

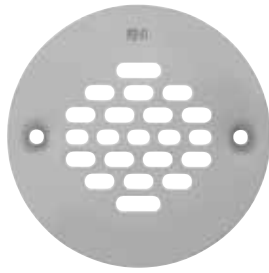

69552

PRODUCT	DESCRIPTION	MODEL	UNITS/CASE
Round Stainless Steel Grate w/ Screws (7135 Series)			
69552	Chrome – Carded	ABA7135CARD	6
69289	Satin Nickel – Carded	ABA7137SNCARD	6
69128	Oil Rubbed Bronze – Carded	ABA7137ORB CARD	6
69159	Matte Black – Carded	ABA7137MBCARD	6
69130	Champagne Bronze – Carded	ABA7137CBCARD	6

Cast Bronze Shower Drains – Complete



67190

Available connections:

- 2" IPS
- 2" caulk
- 2" sweat

Strainer options:

- Stamped stainless steel
- Round heavy duty cast brass
- Recommended for copper pan installations

PRODUCT	DESCRIPTION	MODEL	UNITS/CASE
1-3/8" Barrel w/ 4-1/2" Square Cast Brass Grate (72121 Series)			
67190	2" Caulk Chrome	ABA6600	8
67193	2" IPS Chrome	ABA6610	18
67196	2" Sweat Chrome	ABA6620	8
2-1/2" Barrel w/ 4-1/2" Square Cast Brass Grate (72121 Series)			
67192	2" Caulk Chrome	ABA6605	8
67044	2" IPS Chrome	ABA6615	18
67197	2" Sweat Chrome	ABA6622	8

Square Strainers



69799

PRODUCT	DESCRIPTION	MODEL	UNITS/CASE
Square 4-1/4" Cast Brass Shower Grate w/ Screws on 3-3/8" Center (72121 Series)			
69799	Square Cast Grate w/ Screws CP (for brass barrel)	ABA72121CARD	15
69802	Square Cast Grate w/ Screws SN (for brass barrel)	ABA72132SNCARD	15
69803	Square Cast Grate w/ Screws VB (for brass barrel)	ABA72132VBCARD	15
69804	Square Cast Grate w/ Screws ORB (for brass barrel)	ABA72132ORB CARD	15
69195	Square Cast Grate w/ Screws MB (for brass barrel)	ABA72132MBCARD	15
69850	Square Cast Grate w/ Screws CB (for brass barrel)	ABA72132CBCARD	15

Weld-On®
Guy Gray®
ToughPans®
Waater-Tite®
RTB
Test-Tite®
AB&A®
Studor®
Truebro®
Christy's®
FloodStop®
ProVent®
ProSet®

Strainers

PRODUCT	DESCRIPTION	MODEL	UNITS/CASE
Cast Bronze Drain Body Only (6400, 6500, 6600 Series)			
68261	2" Caulk	ABA7232	1
67205	2" IPS	ABA7233	1
68239	2" Sweat	ABA7234	1
1-3/8" Brass Barrel Only (6500, 6600 Series)			
67206	Chrome	ABA7240	1
2-1/2" Brass Barrel Only (6500, 6600 Series)			
67207	Chrome	ABA7242	1
Screws for Brass Body Drains (6400, 6500, 6600 series) – #8-32 x 1/4" Phillips Flat Head Machine Screws			
60053	For CP, SN, PN, SC, SP	ABA8827	10
60093	For VB, ORB	ABA8827ORB	10
69840	Friction Ring & Gasket Set	ABA6861	12

Cast Bronze Shower Drains – Complete

- Adjustable with clamping ring

PRODUCT	DESCRIPTION	MODEL	UNITS/CASE
67240	2" FIP with Chrome Plated Stainless Steel Grate	ABA6320	4



67240

Non-adjustable EZZ Set Shower Drains



67002



67003



67001



67000

Available connections:

- 1-1/2" IPS
- 2" IPS
- 2" caulk
- 2" no-caulk
- 2" No-hub
- 2" solvent weld
- 2" SUREFIT
- Recommended for hot mop applications

LISTINGS	PRODUCT	DESCRIPTION	MODEL	UNITS/CASE
EZZ Set Shower Drain - Cast Iron Top and Body – Chrome Plated Grate & Crown (#7120)				
67002	2" IPS		ABA5065	4
67144	2" Caulk		ABA5070	4
67003	2" No-hub		ABA5073	4
67146	2" No-Caulk w/ Rubber Connector		ABA5074	4
Los Angeles Style EZZ Set Shower Drain - Cast Iron Top and Body – Chrome Plated Grate & Crown (7120 Series)				
67147	2" IPS		ABA5080	4
67148	2" Caulk		ABA5085	4
67149	2" No-hub		ABA5090	4
Los Angeles Style EZZ Set Shower Drain - Cast Iron Top with Plastic Body – Chrome Plated Grate & Crown (7120 Series)				
67001	ABS – 2" Solvent Weld		ABA5040	4
67140	PVC – 2" Solvent Weld		ABA5045	4
Los Angeles Style EZZ Set Shower Drain - Plastic Top and Body – Chrome Plated Grate & Crown (#7120)				
67000	ABS – 2" Solvent Weld		ABA5000	15
67136	PVC – 2" Solvent Weld		ABA5008	15
67138	PVC – No-Caulk SUREFIT Conn.		ABA5020	15

Strainers

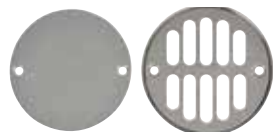

69569

- Includes protection plate
- Replacement grate for shower drains
- Includes all parts necessary for quick and easy installation
- Pick from a variety of finishes

PRODUCT	DESCRIPTION	MODEL	UNITS/CASE
Round 3-1/4" Steel Grate w/ Screws – 2 7/8" Center to Center (7120 Series)			
69569	Chrome Grate & Crown	ABA5145	15
69615	Satin Nickel Grate & Crown	ABA5149SN	1
69614	Oil Rubbed Bronze Grate & Crown	ABA5149ORB	1
69685	Matte Black Grate & Crown	ABA5149MB	1
69686	Champagne Bronze Grate & Crown	ABA5149CB	1

Weld-On®
Guy Gray®
Waater-Tite®
ToughPans®
RTB
Test-Tite®
AB&A®
Studor®
Truebro®
Christy's®
FloodStop®
ProVent®
ProSet®

Components

- For use in cast iron no-caulk drains
- For use with the 67175 drain

PRODUCT	DESCRIPTION	MODEL	UNITS/CASE
69232	Rubber Drain Connector	ABA6910	6

Cast Iron Adjustable Shower Drain

Available connections:

- 2" IPS
- 2" caulk
- 2" no-hub
- 2" no-caulk

PRODUCT	DESCRIPTION	MODEL	UNITS/CASE
Wide-Bodied			
2" IPS Drain with Round Cast Brass Grate (7212 Series)			
67154	Chrome	ABA52007212	4
2" Caulk Drain with Round Cast Brass Grate (7212 Series)			
67159	Chrome	ABA52047212	4
2" No-hub Drain with Round Cast Brass Grate (7212 Series)			
67160	Chrome	ABA52087212	4
Narrow-Bodied			
2" No-Caulk Drain with Round Cast Brass Grate (7212 Series)			
67175	Chrome	ABA5225	4



67154

Round Strainers

PRODUCT	DESCRIPTION	MODEL	UNITS/CASE
Round 3-15/16" Cast Brass Shower Grate w/ Screws on 3-3/8" Center – For Brass Strainer Barrels (7212 Series)			
63349	Round Cast Grate w/ Screws Crown CP	ABA7212CARD	15
67312	Round Cast Grate w/ Screws Crown SN	ABA7213SNCARD	15
67315	Round Cast Grate w/ Screws Crown VB	ABA7213VBCARD	15
67309	Round Cast Grate w/ Screws Crown ORB	ABA7213ORBCARD	15
67317	Round Cast Grate w/ Screws Crown MB	ABA7213MBCARD	15
67331	Round Cast Grate w/ Screws Crown CB	ABA7213CBCARD	15

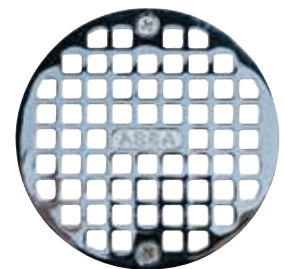

63349

Round Strainers



67155

PRODUCT	DESCRIPTION	MODEL	UNITS/CASE
2" IPS Drain with Square Cast Brass Grate (72121 Series)			
67155	Chrome	ABA520072121	4
2" Caulk Drain with Square Cast Brass Grate (72121 Series)			
67271	Chrome	ABA520472121	4
2" No-hub Drain with Square Cast Brass Grate (72121 Series)			
67161	Chrome	ABA520872121	4

Square Strainers



69799

PRODUCT	DESCRIPTION	MODEL	UNITS/CASE
Square 4-1/4" Cast Brass Shower Grate w/ Screws on 3-3/8" Center (72121 Series)			
69799	Square Cast Grate w/ Screws Chrome (for brass barrel)	ABA72121CARD	15
69802	Square Cast Grate w/ Screws Satin Nickel (for brass barrel)	ABA72132SNCARD	15
69803	Square Cast Grate w/ Screws Venetian Bronze (for brass barrel)	ABA72132VBCARD	15
69804	Square Cast Grate w/ Screws Oil-Rubbed Bronze (for brass barrel)	ABA72132ORBCARD	15
69195	Square Cast Grate w/ Screws Matte Black (for brass barrel)	ABA72132MBCARD	15
69850	Square Cast Grate w/ Screws Champagne Bronze (for brass barrel)	ABA72132CBCARD	15

Adjustable Drain with 1-1/2" Top Flange



67024

LISTINGS	PRODUCT	DESCRIPTION	MODEL	UNITS/CASE
ABS Flange & Body – 2" Solvent Weld Connection				
	67024	White Plastic Snap-in Grate (7103 Series)	ABA3900	15
	67025	Stainless Steel Snap-in Grate (7101 Series)	ABA3901	15
ABS Flange & Body – 2" SUREFIT Connection				
	67023	Stainless Steel Snap-in Grate (7101 Series)	ABA3601	15

Weld-On®
Guy Gray®
Waater-Tite®
ToughPans®
RTB
Test-Tite®
AB&A®
Studor®
Truebro®
Christy's®
FloodStop®
ProVent®
ProSet®

Strainers

PRODUCT	DESCRIPTION	MODEL	UNITS/CASE
Round 4-1/4" Snap-In Steel Grate (7101-7103 Series)			
69774	Chrome – Carded	ABA7101CARD	15
64991	Satin Nickel – Carded	ABA7101SNCARD	1
69536	Venetian Bronze – Carded	ABA7101VBCARD	1
69530	Oil Rubbed Bronze – Carded	ABA7101ORBCARD	1
69689	Matte Black – Carded	ABA7101MBCARD	1
69688	Champagne Bronze – Carded	ABA7101CBCARD	1
69524	White (Plastic ABS)	ABA7103	15
69770	White (Plastic ABS) – Carded	ABA7103CARD	1



69524

SHOWER PAN LINER / AB&A® / IPS

Shower Pan Liner

- 40 mil thick, gray
- No underlay mount required – may be glued directly to drain for positive seal
- Meets ASTM D-4551
- Meets FHA & HUD requirements for shower pan

LISTINGS	PRODUCT	DESCRIPTION	MODEL	UNITS/CASE
	83440	40 mil. Membrane 4' x 50' (200 Sq. Ft.)	P445	1 Roll
	83445	40 mil. Membrane 5' x 40' (200 Sq. Ft.)	P454	1 Roll
	83446	40 mil. Membrane 6' x 50' (300 Sq. Ft.)	P465	1 Roll
	83447	40 mil. Membrane 4' x 100' (400 Sq. Ft.)	P441	1 Roll
	83448	40 mil. Membrane 5' x 100' (500 Sq. Ft.)	P451	1 Roll
	83449	40 mil. Membrane 6' x 100' (600 Sq. Ft.)	P461	1 Roll
	83450	6' X 6' Shower Pan Liner	P466K	1
	40 Mil. PVC Shower Dam Corners			
	85530	40 mil. PVC Shower Dam Corners	SDC1	40

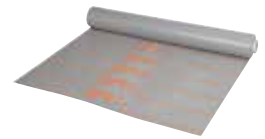

83440



83440

SHOWER PAN LINER SOLVENT CEMENT / AB&A® / IPS

LISTINGS	PRODUCT	DESCRIPTION	MODEL	UNITS/CASE
	PVC Liner Cement			
	10835	PVC Shower Pan Liner Solvent Cement (1 Pint)	106600031	12



Schedule 40 Waste & Overflow – “Classic” Full Kits w/Flex Pipe & Test Kit

Weld-On®
Guy Gray®
Waater-Tite®
ToughPans®
RTB
Test-Tite®
AB&A®
Studor®
Truebro®
Christy's®
FloodStop®
ProVent®
ProSet®



61231

- “Classic” high-flow capacity slotted overflow plate provides greater drainage through the tub overflow
- Thin gasket included for thick-walled tubs (e.g. marble)
- With 16” and 24” FLEX pipe
- Strainer and stopper are brass unless noted
- Additional special finish kits available on page 188188
- “Classic” Test Kits available on page 186

LISTINGS	PRODUCT	DESCRIPTION	MODEL	UNITS/CASE
16" ABS Flex Full Kits				
61758		Push eN Lift Chrome	ABA2225FLEX	12
61666		Touch Toe Chrome	ABA2242FLEXCS	12
16" PVC Flex Full Kits				
61231		Push eN Lift Chrome	ABA2226FLEXHF	12
62139		Turn Top Chrome	ABA2259FLEXHF	12
61237		Touch Toe Chrome	ABA2243FLEXCSHF	12
24" PVC Flex Full Kits				
60948		Push eN Lift Chrome	ABA2226FLEX24HF	12
62244		Turn Top Chrome	ABA2259FLEX24HF	12
63408		Touch Toe Chrome	ABA2243FLEX24CSHF	12



Schedule 40 Waste & Overflow – “Classic” Full Kit Rough Ins w/Flex Pipe & Test Kit

LISTINGS	PRODUCT	DESCRIPTION	MODEL	UNITS/CASE
16" PVC Flex Full Kit Rough Ins				
61415		Chrome	ABA2259RIFLEXHF	12
24" PVC Flex Full Kit Rough Ins				
61715		Chrome	ABA2259RIFLEX24HF	12



Schedule 40 Waste & Overflow – “Classic” One-Piece Direct Drain Full Kits w/Flex Pipe & Test Kit

- “Classic” high-flow capacity slotted overflow plate provides greater drainage through the tub overflow
- Thin gasket included for thick-walled tubs (e.g. marble)
- Available in multiple lengths of FLEX pipe
- Custom lengths available to match tub specs
- Strainer and stopper are brass unless noted
- Additional special finish kits available on page 188
- “Classic” Test Kits available on page 186

LISTINGS	PRODUCT	DESCRIPTION	MODEL	UNITS/CASE
ABS One-Piece Direct Drain Flex Full Kits				
	65501	16" Push eN Lift Chrome	ABA2227FLEX16HF	12
	65506	15.5" Push eN Lift Chrome	ABA2227FLEX155HF	12
	65510	15" Push eN Lift Chrome	ABA2227FLEX15HF	12
	65508	14.5" Push eN Lift Chrome	ABA2227FLEX145HF	12
	65509	14" Push eN Lift Chrome	ABA2227FLEX14HF	12
	PVC One-Piece Direct Drain Flex Full Kits			
	65601	16" Push eN Lift Chrome	ABA2228FLEX16HF	12
	65606	15.5" Push eN Lift Chrome	ABA2228FLEX155HF	12
	65607	15" Push eN Lift Chrome	ABA2228FLEX15HF	12
	65608	14.5" Push eN Lift Chrome	ABA2228FLEX145HF	12
	65609	14" Push eN Lift Chrome	ABA2228FLEX14HF	12
	61731	16" Push eN Lift Chrome, Solid Overflow Plate	ABA2226FLEXS	12
	61991	16" Touch Toe Chrome, Solid Overflow Plate	ABA2243FLEXCSSF	12



65601

Schedule 40 Waste & Overflow – “Classic” One-Piece Direct Drain Full Kit Rough Ins w/Flex Pipe & Test Kit

- “Classic” high-flow capacity slotted overflow plate provides greater drainage through the tub overflow
- Thin gasket included for thick-walled tubs (e.g. marble)
- With 16" and 24" FLEX pipe
- Strainer and stopper are brass unless noted
- Additional special finish kits available on page 188
- “Classic” Test Kits available on page 186

LISTINGS	PRODUCT	DESCRIPTION	MODEL	UNITS/CASE
ABS One-Piece Direct Drain Flex Full Kit Rough Ins				
	65540	16" Chrome 1P Flex RI - 16"	ABA2227RIFLEX16HF	12
PVC One-Piece Direct Drain Flex Full Kit Rough Ins				
	65541	16" Chrome	ABA2228RIFLEX16HF	12
	65542	15.5" Chrome	ABA2228RIFLEX155HF	12
	65543	15" Chrome	ABA2228RIFLEX15HF	12
	65599	15" Chrome, Solid Overflow Plate	ABA2228FLEX15SF	12
	65544	14.5" Chrome	ABA2228RIFLEX145HF	12
	65545	14" Chrome	ABA2228RIFLEX14HF	12
	65546	16" Satin Nickel	ABA2228RIFLEX16SNHF	12
	65547	15.5" Satin Nickel	ABA2228RIFLEX155SNHF	12
	65548	15" Satin Nickel	ABA2228RIFLEX15SNHF	12
	65549	14.5" Satin Nickel	ABA2228RIFLEX145SNHF	12
	65550	14" Satin Nickel	ABA2228RIFLEX14SNHF	12



65559

continued on next page

Schedule 40 Waste & Overflow – “Classic” One-Piece Direct Drain Full Kit Rough Ins w/Flex Pipe & Test Kit (continued)



65556

LISTINGS	PRODUCT	DESCRIPTION	MODEL	UNITS/CASE
	PVC One-Piece Direct Drain Flex Full Kit Rough Ins (continued)			
	65551	16" Venetian Bronze	ABA2228RIFLEX16VBHF	12
	65552	15.5" Venetian Bronze	ABA2228RIFLEX155VBHF	12
	65553	15" Venetian Bronze	ABA2228RIFLEX15VBHF	12
	65554	14.5" Venetian Bronze	ABA2228RIFLEX145VBHF	12
	65555	14" Venetian Bronze	ABA2228RIFLEX14VBHF	12
	65556	16" Matte Black	ABA2228RIFLEX16MBHF	12
	65557	15.5" Matte Black	ABA2228RIFLEX155MBHF	12
	65558	15" Matte Black	ABA2228RIFLEX15MBHF	12
	65559	14.5" Matte Black	ABA2228RIFLEX145MBHF	12
	65560	14" Matte Black	ABA2228RIFLEX14MBHF	12
	65565	16" Champagne Bronze	ABA2228RIFLEX16CBHF	12
	65566	15.5" Champagne Bronze	ABA2228RIFLEX155CBHF	12
	65567	15" Champagne Bronze	ABA2228RIFLEX15CBHF	12
	65568	14.5" Champagne Bronze	ABA2228RIFLEX145CBHF	12
	65569	14" Champagne Bronze	ABA2228RIFLEX14CBHF	12



Schedule 40 Waste & Overflow – “Classic” Full Kits w/Test



61023

- “Classic” high-flow capacity slotted overflow plate provides greater drainage through the tub overflow
- Thin gasket included for thick-walled tubs (e.g. marble)
- Strainer and stopper are brass unless noted
- Additional special finish kits available on page 188
- “Classic” Test Kits available on page 186

LISTINGS	PRODUCT	DESCRIPTION	MODEL	UNITS/CASE
	ABS			
	62094	ABS with Push eN Lift Chrome Stopper	ABA2225HF	10
	61741	ABS with Turn Top Chrome Stopper	ABA2258HF	10
	61236	ABS with Touch Toe Chrome Stopper	ABA2242CSHF	10
	61998	ABS with Touch Toe Chrome Stopper, Solid Overflow Plate	ABA2242CSSF	20
	61226	ABS with Flip Top Chrome Stopper	ABA2210HF	10
	PVC			
	61023	PVC with Push eN Lift Chrome Stopper	ABA2226HF	10
	61025	PVC with Turn Top Chrome Stopper	ABA2259HF	10
	61024	PVC with Touch Toe Chrome Stopper	ABA2243CSHF	10



Weld-On®
Guy Gray®
ToughPans®
Waater-Tite®
RTB
Test-Tite®
AB&A®
Studor®
Truebro®
Christy's®
FloodStop®
ProVent®
ProSet®

Schedule 40 Waste & Overflow – “Classic” Half Kits w/Test Kit – ABS

LISTINGS	PRODUCT	DESCRIPTION	MODEL	UNITS/CASE
	ABS with Push eN Lift Stopper			
	62001	Chrome	ABA2217HF	20
	62003	Chrome with Zinc Strainer	ABA2217ZHF	20
	62002	Chrome with Zinc Strainer & ABS Stopper	ABA2217PZHF	20
	62486	Chrome with Metal Test kit	ABA2217MHF	20
	61992	Chrome with Classic Solid Overflow Plate	ABA2217SF	20
	61999	Chrome w/Zinc Strainer & ABS Stopper Classic Solid OFP	ABA2217PZSF	20
	62005	Satin Nickel	ABA2221SNHF	20
	61993	Satin Nickel with Classic Solid Overflow Plate	ABA2221SNSF	20
	62006	Venetian Bronze	ABA2221VBHF	20
	62004	Oil Rubbed Bronze	ABA2221ORBHF	20
	62501	White	ABA2221WHF	20
	62489	Champagne Bronze	ABA2221CBHF	20
	62281	Matte Black	ABA2221MBHF	20
	61994	Matte Black with Classic Solid Overflow Plate	ABA2221MBSF	20
	ABS with Turn Top Stopper			
	62127	Chrome	ABA2250HF	20
	62015	Chrome with Zinc Strainer & Stopper	ABA2250ZHF	20
	ABS with Touch Toe Stopper			
	62012	Chrome	ABA2234CSHF	20
	61986	Chrome with Classic Solid Overflow Plate	ABA2234CSSF	20
	62109	Satin Nickel	ABA2238SNCSHF	6
	61988	Satin Nickel with Classic Solid Overflow Plate	ABA2238SNCSSF	20
	62915	Venetian Bronze	ABA2238VBCSHF	6
	62104	Oil Rubbed Bronze	ABA2238ORBCSHF	6
	62287	Champagne Bronze	ABA2238CBCSHF	6
	62283	Matte Black	ABA2238MBCSHF	6
	61997	Matte Black with Classic Solid Overflow Plate	ABA2238MBCSSF	20
	ABS with Flip Top Stopper			
	62480	Chrome	ABA2200HF	6



Weld-On®

Guy Gray®

Water-Tite®

ToughPans®

RTB

Test-Tite®

AB&A®

Studor®

Truebro®

Christy's®

FloodStop®

ProVent®

ProSet®

Schedule 40 Waste & Overflow – “Classic” Half Kits w/Test Kit – PVC



62016

- “Classic” high-flow capacity slotted overflow plate provides greater drainage through the tub overflow
- Thin gasket included for thick-walled tubs (e.g. marble)
- Strainer and stopper are brass unless noted
- Additional special finish kits available on page 188
- “Classic” Test Kits available on page 186

LISTINGS	PRODUCT	DESCRIPTION	MODEL	UNITS/CASE	
	PVC with Push eN Lift Stopper				
	62007	Chrome	ABA2218HF	20	
	69911	Chrome with Classic Solid Overflow Plate	ABA2218SF	20	
	62038	Chrome with Zinc Strainer	ABA2218ZHF	20	
	62037	Chrome with Zinc Strainer & ABS Stopper	ABA2218PZHF	20	
	69906	Chrome with Zinc Strainer & ABS Stopper, Classic Solid Overflow Plate	ABA2218PZSF	20	
	62487	Chrome with Metal Test kit	ABA2218MHF	20	
	62009	Satin Nickel	ABA2222SNHF	20	
	69912	Satin Nickel with Classic Solid Overflow Plate	ABA2222SNSF	20	
	62092	Venetian Bronze	ABA2222VBHF	20	
	62008	Oil Rubbed Bronze	ABA2222ORBHF	20	
	69913	Oil Rubbed Bronze with Classic Solid Overflow Plate	ABA2222ORBBSF	20	
	62093	White	ABA2222WHF	20	
	62262	Champagne Bronze	ABA2222CBHF	20	
	69914	Champagne Bronze with Classic Solid Overflow Plate	ABA2222CBSF	6	
	62280	Matte Black	ABA2222MBHF	20	
	69915	Matte Black with Classic Solid Overflow Plate	ABA2222MBSF	20	
		PVC with Turn Top Stopper			
	62016	Chrome	ABA2251HF	20	
	62017	Chrome with Zinc Strainer & Stopper	ABA2251ZHF	20	
	PVC with Touch Toe Stopper				
62013	Chrome	ABA2235CSHF	20		
69907	Chrome with Classic Solid Overflow Plate	ABA2235CSSF	6		
62014	Satin Nickel	ABA2239SNCSHF	6		
69908	Satin Nickel with Classic Solid Overflow Plate	ABA2239SNCSSF	20		
62124	Venetian Bronze	ABA2239VBCSHF	6		
62117	Oil Rubbed Bronze	ABA2239ORBBSHF	6		
69909	Oil Rubbed Bronze with Classic Solid Overflow Plate	ABA2239ORBBSHF	20		
62286	Champagne Bronze	ABA2239CBCSHF	6		
69916	Champagne Bronze with Classic Solid Overflow Plate	ABA2239CBCSSF	6		
62282	Matte Black	ABA2239MBCSHF	6		
69917	Matte Black with Classic Solid Overflow Plate	ABA2239MBCSSF	6		
	PVC with Flip Top Stopper				
62000	Chrome	ABA2201HF	6		

Weld-On®
Guy Gray®
Waater-Tite®
ToughPans®
RTB
Test-Tite®
AB&A®
Studor®
Truebro®
Christy's®
FloodStop®
ProVent®
ProSet®

Schedule 40 Waste & Overflow – “Classic” Half Kits w/Test Kit & Straight Drain Fitting

- “Classic” high-flow capacity slotted overflow plate provides greater drainage through the tub overflow
- Thin gasket included for thick-walled tubs (e.g. marble)
- Strainer and stopper brass unless noted
- Additional special finish kits available on page 188
- “Classic” Test Kits available on page 186



LISTINGS	PRODUCT	DESCRIPTION	MODEL	UNITS/CASE
	ABS Half Kits			
	62142	Half Kit “Classic” with Push eN Lift Stopper Chrome – Hub Adapter	ABA2282HF	6
	62278	Half Kit “Classic” with Touch Toe Stopper Chrome – Hub Adapter	ABA2298CSHF	6
	PVC Half Kits			
	62276	Half Kit “Classic” with Push eN Lift Stopper Chrome – Hub Adapter	ABA2283HF	6
	62145	Half Kit “Classic” with Touch Toe Stopper Chrome – Hub Adapter	ABA2299CSHF	6

Schedule 40 Waste & Overflow – “Classic” Half Kits w/Test Kit & Direct Drain Fitting

- “Classic” high-flow capacity slotted overflow plate provides greater drainage through the tub overflow
- Thin gasket included for thick-walled tubs (e.g. marble)
- Strainer and stopper brass unless noted
- Additional special finish kits available on page 188
- “Classic” Test Kits available on page 186



PRODUCT	DESCRIPTION	MODEL	UNITS/CASE
ABS Half Kits			
65502	Direct Drain “Classic” with Push eN Lift Stopper Chrome	ABA2227HF	20
65503	Direct Drain “Classic” with Touch Toe Stopper Chrome	ABA2227CSHF	20
PVC Half Kits			
65602	Direct Drain “Classic” with Push eN Lift Stopper Chrome	ABA2228HF	20
65603	Direct Drain “Classic” with Touch Toe Stopper Chrome	ABA2228CSHF	20

Schedule 40 Waste & Overflow – “Classic” Rough-in Kits w/Test Kit



62073

- Less Pipe and Tee
- Includes Strainer
- Thin gasket included for thick-walled tubs (e.g. marble)
- Strainer is brass unless noted

LISTINGS	PRODUCT	DESCRIPTION	MODEL	UNITS/CASE
ABS				
	62070	Chrome	ABA2217RIHF	20
	62072	Chrome with Zinc Strainer	ABA2217RIPZHF	20
	62497	Satin Nickel	ABA2221SNRIHF	6
	62492	Oil Rubbed Bronze	ABA2221ORBRIHF	6
	62298	Champagne Bronze	ABA2221CBRIHF	6
	62292	Matte Black	ABA2221MBRIHF	6
PVC				
	62073	Chrome	ABA2218RIHF	20
	62078	Chrome with Slip Condensate Overflow Elbow	ABA22181RICOSHF	20
	62074	Chrome with Threaded Condensate Overflow Elbow	ABA22181RICOTHF	20
	62075	Chrome with Metal Test kit	ABA2218RIMHF	20
	62076	Chrome with Zinc Strainer	ABA2218RIZHF	20
	62088	Satin Nickel	ABA2222SNRIHF	6
	62249	Oil Rubbed Bronze	ABA2222ORBRIHF	6
	62374	White	ABA2222WRIHF	6
	62297	Champagne Bronze	ABA2222CBRIHF	6
	62291	Matte Black	ABA2222MBRIHF	6



Schedule 40 Waste & Overflow – “Classic” Rough-in Kits w/Test Kit & Direct Drain Fitting

- “Classic” high-flow capacity slotted overflow plate provides greater drainage through the tub overflow
- Thin gasket included for thick-walled tubs (e.g. marble)
- Strainer and stopper are brass unless noted
- California Residents:

PRODUCT	DESCRIPTION	MODEL	UNITS/CASE
ABS Rough In Kits			
65513	Direct Drain “Classic”Rough In Kit Direct Drain Chrome	ABA2227RIHF	20
PVC Rough In Kits			
65610	Direct Drain “Classic”Rough In Kit Direct Drain Chrome	ABA2228RIHF	20

“Classic” Waste & Overflow Test Kits



68685

68210

LISTINGS	PRODUCT	DESCRIPTION	MODEL	UNITS/CASE
“Classic” Overflow Test Cap				
	69601	ABS	ABA2352	15
	68210	PVC	ABA2353	15
Strainer Test Stopper				
	68685	Plastic	ABA6918	12
	68038	Metal	ABA6918M	12



“Classic” Trim Kits

- For both ABS and PVC rough-in kits shown above
- “Classic” high-flow capacity slotted overflow plate provides greater drainage through the tub overflow
- Stopper, strainer, and classic high-flow capacity overflow plate
- Strainer and stopper are brass unless noted



62082

LISTINGS	PRODUCT	DESCRIPTION	MODEL	UNITS/CASE
	Push eN Lift Stopper			
	62082	Chrome	ABA2218TKHF	20
	69082	Chrome with Solid Overflow Plate	ABA2218TKSF	20
	62087	Chrome ABS Stopper	ABA2218TKPZHF	20
	69087	Chrome ABS Stopper with Solid Overflow Plate	ABA2218TKPZSF	20
	62084	Satin Nickel	ABA2222SNTKHF	6
	69498	Satin Nickel with Solid Overflow Plate	ABA2221SNTKSF	6
	62264	Venetian Bronze	ABA2221VBTKHF	6
	69264	Venetian Bronze with Solid Overflow Plate	ABA2221VBTKSF	20
	62493	Oil Rubbed Bronze	ABA2221ORBTKHF	6
	69493	Oil Rubbed Bronze with Solid Overflow Plate	ABA2221ORBTKSF	6
	62236	White	ABA2222WTKHF	6
	62271	Champagne Bronze	ABA2221CBTKHF	6
	69494	Champagne Bronze with Solid Overflow Plate	ABA2221CBTKSF	6
	62273	Matte Black	ABA2221MBTKHF	6
	69495	Matte Black with Solid Overflow Plate	ABA2221MBTKSF	6
	Turn Top Stopper			
	61050	Chrome	ABA2250TKHF	20
	62325	Chrome with Zinc Stopper	ABA2250TKZHF	20
	69910	Chrome with Zinc Stopper (Flapper), Solid Overflow Plate	ABA2250TKSF	20
	Touch Toe			
	62096	Chrome	ABA2234TKHF	20
	69096	Chrome with Solid Overflow Plate	ABA2234TKSF	20
	67993	Satin Nickel with Solid Overflow Plate	ABA2221MBTKSN	6
	62301	Champagne Bronze	ABA2235CBTKHF	20
	67994	Champagne Bronze with Solid Overflow Plate	ABA2221MBTKCB	6
	62300	Matte Black	ABA2235MBTKHF	20
	67995	Matte Black with Solid Overflow Plate	ABA2221MBTKMB	6
	67996	Venetian Bronze with Solid Overflow Plate	ABA2221MBTVB	6



“Classic” Finish Kits



63276

- For both ABS and PVC rough-in kits shown above
- Includes stopper and Classic high-flow capacity overflow plate
- “Classic” high-flow capacity slotted overflow plate provides greater drainage through the tub overflow
- Stopper is brass unless noted

LISTINGS	PRODUCT	DESCRIPTION	MODEL	UNITS/CASE
	Push eN Lift Stopper			
	63276	Chrome	ABA2377HF	6
	69926	Chrome with Classic Solid Overflow Plate	ABA2377SF	20
	63281	Polished Brass	ABA2378PBHF	20
	64055	Satin Nickel	ABA2378SNHF	20
	69055	Satin Nickel with Classic Solid Overflow Plate	ABA2378SNSF	6
	64058	Venetian Bronze	ABA2378VBHF	20
	69058	Venetian Bronze with Classic Solid Overflow Plate	ABA2378VBSF	6
	64054	Oil Rubbed Bronze	ABA2378ORBHF	20
	69054	Oil Rubbed Bronze with Classic Solid Overflow Plate	ABA2378RBSF	6
	63282	Polished Nickel	ABA2378PNHF	20
	63285	Satin Chrome	ABA2378SCHF	20
	64056	Satin Pearl	ABA2378SPHF	20
	64059	White	ABA2378WHF	20
	63283	Champagne Bronze	ABA2378CBHF	20
	69056	Champagne Bronze with Classic Solid Overflow Plate	ABA2378CBSF	6
	63287	Matte Black	ABA2378MBHF	20
	69057	Matte Black with Classic Solid Overflow Plate	ABA2378MBSF	6
	Turn Top Stopper			
	63263	Chrome	ABA2371HF	6
	Touch Toe Stopper			
	63246	Chrome	ABA2365CSHF	20
	63251	Polished Brass	ABA2366PBCSHF	6
	63255	Satin Nickel	ABA2366SNCSHF	6
	63260	Venetian Bronze	ABA2366VBCSHF	6
	63250	Oil Rubbed Bronze	ABA2366ORBCSHF	6
	63261	White	ABA2366WCSHF	6
	63342	Champagne Bronze	ABA2366CBCSHF	6
	63262	Matte Black	ABA2366MBCSHF	6



Weld-On®
Guy Gray®
ToughPans®
Waater-Tite®
RTB
Test-Tite®
AB&A®
Studor®
Truebro®
Christy's®
FloodStop®
ProVent®
ProSet®

Schedule 40 Waste & Overflow - One-Hole Full Kits

• Strainer and stopper are brass unless noted

• Additional special finish kits available on page 193

LISTINGS	PRODUCT	DESCRIPTION	MODEL	UNITS/CASE
ABS with Push eN Lift Stopper				
61026	Chrome		ABA906	20
61281	Chrome with Retaining Clip & Test Kit		ABA906CT	20
61029	Satin Nickel		ABA910SN	20
61289	Satin Nickel with Retaining Clip & Test Kit		ABA910SNCT	20
61292	Venetian Bronze		ABA910VB	20
61293	Venetian Bronze with Retaining Clip & Test Kit		ABA910VBCT	20
61287	Oil Rubbed Bronze		ABA910ORB	20
61288	Oil Rubbed Bronze with Retaining Clip & Test Kit		ABA910ORBCT	20
61294	White		ABA910W	20
ABS with Turn Top Stopper				
61040	Chrome		ABA1101	20
61054	Chrome with Retaining Clip & Test Kit		ABA1101CT	20
ABS with Touch Toe Stopper				
61034	Chrome		ABA1200CS	20
61793	Chrome with Retaining Clip & Test Kit		ABA1200CSCT	20
PVC with Push eN Lift Stopper				
61030	Chrome		ABA911	20
61295	Chrome with Retaining Clip & Test Kit		ABA911CT	20
61268	Satin Nickel		ABA915SN	20
61783	Satin Nickel with Retaining Clip & Test Kit		ABA915SNCT	20
61301	Venetian Bronze		ABA915VB	20
61302	Venetian Bronze with Retaining Clip & Test Kit		ABA915VBCT	20
61297	Oil Rubbed Bronze		ABA915ORB	20
61784	Oil Rubbed Bronze with Retaining Clip & Test Kit		ABA915ORBCT	20
61711	White		ABA915W	20
PVC with Turn Top Stopper				
61042	Chrome		ABA1106	20
PVC with Touch Toe Stopper				
61637	Chrome		ABA1210CS	20
61799	Chrome with Retaining Clip & Test Kit		ABA1210CSCT	20



61030

Weld-On®

Guy Gray®

Water-Tite®

ToughPans®

RTB

Test-Tite®

AB&A®

Stuor®

Truebro®

Christy's®

FloodStop®

ProVent®

ProSet®

Schedule 40 Waste & Overflow - One-Hole Half Kits w/Test Kit – ABS

- Strainer and stopper are brass unless noted
- Additional special finish kits available on page 193



62021



LISTINGS	PRODUCT	DESCRIPTION	MODEL	UNITS/CASE
ABS with Push eN Lift Stopper				
62021	Chrome		ABA951	20
62022	Chrome with Retaining Clip & Test Kit		ABA951CT	20
62023	Chrome with Zinc Strainer & ABS Stopper		ABA951PZ	20
62024	Chrome w/ Zinc Strainer, ABS Stopper, Clip, Test Kit		ABA951PZCT	20
62027	Satin Nickel		ABA955SN	20
62169	Satin Nickel with Retaining Clip & Test Kit		ABA955SNCT	6
62029	Venetian Bronze		ABA955VB	20
62171	Venetian Bronze with Retaining Clip & Test Kit		ABA955VBCT	6
62026	Oil Rubbed Bronze		ABA955ORB	20
62164	Oil Rubbed Bronze with Retaining Clip & Test Kit		ABA955ORBCT	6
62172	White		ABA955W	20
62958	White with Retaining Clip & Test Kit		ABA955WCT	6
ABS with Turn Top Stopper				
62442	Chrome		ABA1305	20
62444	Chrome with Retaining Clip & Test Kit		ABA1305CT	20
62565	Chrome with Zinc Strainer		ABA1305Z	6
62934	Chrome with Zinc Strainer, Clip & Test Kit		ABA1305ZCT	6
ABS with Touch Toe Stopper				
62400	Chrome		ABA1260CS	6
62289	Chrome with Retaining Clip & Test Kit		ABA1260CSCT	6

Weld-On®
Guy Gray®
Waater-Tite®
ToughPans®
RTB
Test-Tite®
AB&A®
Studor®
Truebro®
Christy's®
FloodStop®
ProVent®
ProSet®

Schedule 40 Waste & Overflow - One-Hole Half Kits – PVC

- Strainer and stopper are brass unless noted
- Additional special finish kits available on page 193

LISTINGS	PRODUCT	DESCRIPTION	MODEL	UNITS/CASE
	PVC with Push en Lift Stopper			
	62030	Chrome	ABA956	20
	62033	Chrome with Retaining Clip & Test Kit	ABA956CT	20
	62032	Chrome with Retaining Clip & Metal Test Kit	ABA956CM	20
	62982	Chrome with Zinc Strainer & ABS Stopper	ABA956PZ	20
	62183	Chrome w/ Zinc Strainer, ABS Stopper, Clip, Test Kit	ABA956PZCT	20
	62039	Satin Nickel	ABA960SN	20
	62040	Satin Nickel with Retaining Clip & Test Kit	ABA960SNCT	6
	62197	Venetian Bronze	ABA960VB	20
	62198	Venetian Bronze with Retaining Clip & Test Kit	ABA960VBCT	6
	62190	Oil Rubbed Bronze	ABA960ORB	20
	62191	Oil Rubbed Bronze with Retaining Clip & Test Kit	ABA960ORBCT	6
	62199	White	ABA960W	20
	62970	White with Retaining Clip & Test Kit	ABA960WCT	6
	PVC with Turn Top Stopper			
	62059	Chrome	ABA1310	20
	62454	Chrome with Retaining Clip & Test Kit	ABA1310CT	20
	62058	Chrome with Zinc Strainer	ABA1310Z	6
	62288	Chrome with Zinc Strainer, Clip & Test Kit	ABA1310ZCT	6
	PVC with Touch Toe Stopper			
	62048	Chrome	ABA1263S	20
	62339	Chrome with Retaining Clip and Test Kit	ABA1263SCT	20



62030



Schedule 40 Waste & Overflow – One-Hole Half Kits w/Test Kit & Straight Drain Fitting

- Strainer and stopper are brass unless noted
- Additional special finish kits available on page 193

LISTINGS	PRODUCT	DESCRIPTION	MODEL	UNITS/CASE
	ABS One Hole Kits			
	62412	Half Kits with Chrome Push en Lift Stopper	ABA801	6
	PVC One Hole Kits			
	62416	Half Kits with Chrome Push en Lift Stopper	ABA809	6



62416



Schedule 40 Waste & Overflow – One-Hole Half Kits w/Test Kit & Direct Drain Fitting

- Strainer and stopper are brass unless noted
- Additional special finish kits available on page 193

LISTINGS	PRODUCT	DESCRIPTION	MODEL	UNITS/CASE
	ABS One Hole Kits			
	65504	Half Kits with Chrome Push en Lift Stopper, 1-1/2" Direct Drain Shoe	ABA807	20
	PVC One Hole Kits			
	65604	Half Kits with Chrome Push en Lift Stopper, 1-1/2" Direct Drain Shoe	ABA808	20



65604



Schedule 40 Waste & Overflow – One-Hole Rough-in Kits w/Test Kit

- Less pipe and tee; includes strainer
- Strainer is brass unless noted



62044

LISTINGS	PRODUCT	DESCRIPTION	MODEL	UNITS/CASE
ABS				
	62041	Chrome with Retaining Clip and Test Kit	ABA951RICT	20
	62042	Chrome with Zinc Strainer, Clip and Test Kit	ABA951RIPZCT	20
PVC				
	62044	Chrome with Retaining Clip and Test Kit	ABA956RICT	20
	62176	Chrome with Retaining Clip and Metal Test Kit	ABA956RICM	20
	62054	Chrome with Zinc Strainer, Clip and Test Kit	ABA956RIPZCT	20
	62182	Chrome with Zinc Strainer, Clip and Metal Test Kit	ABA956RIPZCM	20



One-Hole Trim Kits

- Stopper and one-hole overflow plate
- Stopper is brass unless noted



62050

LISTINGS	PRODUCT	DESCRIPTION	MODEL	UNITS/CASE
Push eN Lift Stopper				
	62050	Chrome	ABA951TK	20
	62051	Chrome with ABS Stopper	ABA951TKPZ	20
Turn Top Stopper				
	62250	Chrome	ABA1310TKZ	20



One-Hole Finish Kits

- Stopper, strainer, and one-hole overflow plate
- Strainer and stopper are brass unless noted

PRODUCT	DESCRIPTION	MODEL	UNITS/CASE
Push eN Lift Stopper			
63084	Chrome	ABA1615	3
63085	Polished Brass	ABA1617	3
64003	Satin Nickel	ABA1619SN	20
64004	Venetian Bronze	ABA1619VB	20
64002	Oil Rubbed Bronze	ABA1619ORB	20
64011	Champagne Bronze	ABA1619CB	20
64010	Matte Black	ABA1619MB	20
Push eN Lift Stopper – 1-3/8" – 16 – Fine Thread			
63102	Chrome	ABA1630	3
63106	Satin Nickel	ABA1634SN	3
64969	Venetian Bronze	ABA1634VB	3
63105	Oil Rubbed Bronze	ABA1634ORB	3
Touch Toe Stopper			
63394	Chrome	ABA1520CS	3
63386	Satin Nickel	ABA1524SNCS	6
63396	Venetian Bronze	ABA1524VBCS	6
63387	Oil Rubbed Bronze	ABA1524ORBCS	6
63392	Champagne Bronze	ABA1524CBCS	6
63391	Matte Black	ABA1524MBCS	6



63084



Schedule 40 Waste & Overflow - Two-Hole Full Kits

- Strainer and stopper are brass unless noted
- Additional special finish kits available on page 197

LISTINGS	PRODUCT	DESCRIPTION	MODEL	UNITS/CASE
ABS with Push eN Lift Stopper				
	61303	Chrome	ABA926	20
ABS with Turn Top Stopper				
	61041	Chrome	ABA1125	20
ABS with Touch Toe Stopper				
	61825	Chrome	ABA1230S	20
	PVC with Push eN Lift Stopper			
	61306	Chrome	ABA931	20
PVC with Turn Top Stopper				
	61043	Chrome	ABA1130	20
PVC with Touch Toe Stopper				
	61038	Chrome	ABA1236CS	20



61306

Schedule 40 Waste & Overflow – Two-Hole Half Kits w/Test Kit – ABS



62202

• Strainer and stopper are brass unless noted

• Additional special finish kits available on page 197

LISTINGS	PRODUCT	DESCRIPTION	MODEL	UNITS/CASE
ABS with Push eN Lift Stopper				
62202	Chrome		ABA971	20
62203	Chrome with Retaining Clip & Test kit		ABA971CT	20
62295	Chrome with Zinc Strainer and ABS Stopper		ABA971PZ	20
62296	Chrome with Zinc Strainer, ABS Stopper, Clip, & Test		ABA971PZCT	20
62207	Satin Nickel		ABA975SN	6
62299	Venetian Bronze		ABA975VB	6
62205	Oil Rubbed Bronze		ABA975ORB	6
ABS with Turn Top Stopper				
62461	Chrome		ABA1330	20
ABS with Touch Toe Stopper				
62429	Chrome		ABA1280S	20
62818	Satin Nickel		ABA1284SNCS	6
62815	Venetian Bronze		ABA1284VBCS	6
62313	Oil Rubbed Bronze		ABA1284ORBSCS	6



Weld-On®
Guy Gray®
Waater-Tite®
ToughPans®
RTB
Test-Tite®
AB&A®
Studor®
Truebro®
Christy's®
FloodStop®
ProVent®
ProSet®

Schedule 40 Waste & Overflow – Two-Hole Half Kits w/Test Kit – PVC

- Strainer and stopper are brass unless noted
- Additional special finish kits available on page 197

LISTINGS	PRODUCT	DESCRIPTION	MODEL	UNITS/CASE
	PVC with Push eN Lift Stopper			
	62018	Chrome	ABA976	20
	62212	Chrome with Retaining Clip & Test kit	ABA976CT	20
	62036	Chrome with Zinc Strainer & ABS Stopper	ABA976PZ	20
	62305	Chrome with Zinc Strainer, ABS Stopper, Clip, & Test	ABA976PZCT	20
	62219	Satin Nickel	ABA980SN	6
	62223	Venetian Bronze	ABA980VB	6
	62216	Oil Rubbed Bronze	ABA980ORB	6
	PVC with Turn Top Stopper			
	62062	Chrome	ABA1335	20
	62066	Chrome with Zinc Strainer, Stopper, Clip & Test	ABA1335ZCT	20
	PVC with Touch Toe Stopper			
	62045	Chrome	ABA1285CS	20
	62439	Satin Nickel	ABA1289SNCS	6
	62441	Venetian Bronze	ABA1289VBCS	6
	62436	Oil Rubbed Bronze	ABA1289ORBCS	6



62018

Schedule 40 Waste & Overflow – Two-Hole Half Kits w/Test Kit & Straight Drain Fitting

LISTINGS	PRODUCT	DESCRIPTION	MODEL	UNITS/CASE
	ABS with Touch Toe Stopper			
	62346	Chrome – Hub Adapter	ABA851	20
	PVC with Touch Toe Stopper			
	62421	Chrome – Hub Adapter	ABA859	20



62421

Schedule 40 Waste & Overflow - Two-Hole Rough-In Kits w/Test Kit



62972

- Less pipe and tee
- Includes strainer
- Strainer is brass unless noted

LISTINGS	PRODUCT	DESCRIPTION	MODEL	UNITS/CASE
ABS				
62043		Chrome with Retaining Clip and Test Kit	ABA971RIT	20
62350		Chrome with Zinc Strainer, Clip and Test Kit	ABA971RIPZCT	20
PVC				
62972		Chrome with Retaining Clip and Test Kit	ABA976RICT	20
62034		Chrome with Zinc Strainer, Clip and Test Kit	ABA976RIZT	20

Schedule 40 Waste & Overflow – Two-Hole Half Kits w/Test Kit & Direct Drain Fitting



65605

- Less pipe and tee
- Includes strainer
- Strainer is brass unless noted

LISTINGS	PRODUCT	DESCRIPTION	MODEL	UNITS/CASE
ABS				
65505		Two-Hole ABS Half Kits Push eN Lift CP, 1-1/2" Direct Drain Shoe	ABA901	20
PVC				
65605		Two-Hole PVC Half Kit Push eN Lift CP, 1-1/2" Direct Drain Shoe	ABA902	20

Two-Hole Trim Kits



62055

- Stopper and two-hole overflow plate
- Stopper is brass unless noted

LISTINGS	PRODUCT	DESCRIPTION	MODEL	UNITS/CASE
Push eN Lift Stopper				
62055		Chrome	ABA976TK	20
62988		Chrome with ABS Stopper	ABA976TKP	20
Turn Top Stopper				
62510		Chrome	ABA1335TK	20

Weld-On®
Guy Gray®
ToughPans®
Waater-Tite®
RTB
Test-Tite®
AB&A®
Studor®
Truebro®
Christy's®
FloodStop®
ProVent®
ProSet®

Two-Hole Finish Kits

- Stopper, strainer, and two-hole overflow plate
- Strainer and stopper are brass unless noted

PRODUCT	DESCRIPTION	MODEL	UNITS/CASE
Push eN Lift Stopper			
63090	Chrome	ABA1620	6
63095	Satin Nickel	ABA1624SN	20
64005	Venetian Bronze	ABA1624VB	20
63094	Oil Rubbed Bronze	ABA1624ORB	20
64017	Champagne Bronze	ABA1624CB	20
64016	Matte Black	ABA1624MB	20
Turn Top Stopper			
64048	Chrome	ABA1555	6
Touch Toe Stopper			
63015	Chrome	ABA1525S	6
63019	Satin Nickel	ABA1529SNS	6
63021	Venetian Bronze	ABA1529VBS	6
63016	Oil Rubbed Bronze	ABA1529ORBS	6
64978	Champagne Bronze	ABA1529CBCS	6
64976	Matte Black	ABA1529MBCS	6
Push eN Lift Stopper – 1-3/8" – 16 – Fine Thread Strainer with Bushing to 1-1/2" – 11-1/2			
64050	Chrome	ABA16356899	20
64052	Satin Nickel	ABA16396899SN	20
64053	Venetian Bronze	ABA16396899VB	20
64051	Oil Rubbed Bronze	ABA16396899ORB	20



63090



64050

Weld-On®
Guy Gray®
Water-Tite®
ToughPans®
RTB
Test-Tite®
AB&A®
Studor®
Truebro®
Christy's®
FloodStop®
ProVent®
ProSet®

One-Hole Converter Finish Kits



- Strainer and stopper are brass unless noted

PRODUCT	DESCRIPTION	MODEL	UNITS/CASE
With 1-3/8"-16 Fine Thread Strainer, Bushing to 1-1/2"-11-1/2, Push eN Lift Stopper, One-Hole Overflow Plate with Converter Bar and Screw			
64008	Chrome – Bulk Pack	ABA1658	20
64917	Chrome – Retail Carded	ABA1658CARD	20
64925	Polished Brass – Retail Carded	ABA1660CARD	3
64021	Satin Nickel – Bulk Pack	ABA1662SN	20
64930	Satin Nickel – Retail Carded	ABA1662SNCARD	10
64023	Venetian Bronze – Bulk Pack	ABA1662VB	20
64932	Venetian Bronze – Retail Carded	ABA1662VBCARD	10
64019	Oil Rubbed Bronze – Bulk Pack	ABA1662ORB	20
64929	Oil Rubbed Bronze – Retail Carded	ABA1662ORBCARD	10
64015	Polished Nickel – Retail Carded	ABA1662PNCARD	1
64933	White – Retail Carded	ABA1662WCARD	1
With 1-1/2"-16 Fine Thread Strainer, Bushing to 1-1/2"-11-1/2, Push eN Lift Stopper, One-Hole Overflow Plate with Converter Bar and Screw			
64009	Chrome – Bulk Pack	ABA1658L	20
With 1-3/8"-16 Fine Thread Strainer, Bushing to 1-1/2"-11-1/2, Touch Toe Stopper, One-Hole Overflow Plate with Converter Bar and Screw			
64026	Chrome	ABA1700	20
64946	Chrome – Retail Carded	ABA1700CARD	10
With 1-1/2"-11-1/2 Coarse Thread Strainer, "Kohler" Bushing, Push eN Lift Stopper, One-Hole Overflow Plate with Converter Bar and Screw			
63168	Chrome	ABA1673	10
63333	Chrome – Retail Carded	ABA1673CARD	3
63359	Satin Nickel – Retail Carded	ABA1678SNCARD	1
63360	Venetian Bronze – Retail Carded	ABA1678VBCARD	1
63400	Oil Rubbed Bronze – Retail Carded	ABA1678ORBCARD	1

Weld-On®
Guy Gray®
Waater-Tite®
ToughPans®
RTB
Test-Tite®
AB&A®
Studor®
Truebro®
Christy's®
FloodStop®
ProVent®
ProSet®

Finish Kits (Stopper and Strainer Only)

- Stopper and stopper are brass unless noted

PRODUCT	DESCRIPTION	MODEL	UNITS/CASE
Push eN Lift Stopper			
64001	Chrome	ABA1625	20
Push eN Lift Stopper – 1-3/8" – 16 – Fine Thread			
63120	Chrome	ABA1640	20
Push eN Lift Stopper – 3" Wide Flange – 16 Fine Thread			
63242	Chrome	ABA1787	3
Turn Top Stopper – Zinc Stopper/Strainer			
64000	Chrome	ABA1560	20
Turn Top Stopper – 1-3/8" – 16 – Fine Thread			
63055	Chrome	ABA1575	20
Touch Toe Stopper			
63056	Chrome	ABA1580CS	6



64001

"Classic" Press-In Trim Kits

- Stopper is brass unless noted

PRODUCT	DESCRIPTION	MODEL	UNITS/CASE
Press-In Strainer with "Classic" High-flow Capacity Overflow Plate and Push eN Lift Stopper			
60170	Chrome	ABA965033HF	6
60173	Chrome with Classic Solid Overflow Plate	ABA965033SF	6
60111	Satin Nickel	ABA96504SN3HF	6
60325	Satin Nickel with Classic Solid Overflow Plate	ABA96504SN3SF	6
60115	Venetian Bronze	ABA96504VB3HF	6
60108	Oil Rubbed Bronze	ABA965040RB3HF	6
60326	Oil Rubbed Bronze with Classic Solid Overflow Plate	ABA965040RB3SF	6
60116	White	ABA96504W3	6
60322	Champagne Bronze	ABA96504CB3HF	6
60327	Champagne Bronze with Classic Solid Overflow Plate	ABA96504CB3SF	6
60321	Matte Black	ABA96504MB3HF	6
60328	Matte Black with Classic Solid Overflow Plate	ABA96504MB3SF	6
Press-In Strainer with "Classic" High-flow Capacity Overflow Plate and Turn Top Stopper			
60187	Chrome	ABA965073HF	6



60170

One-Hole Press-In Trim Kits



60104

- Stopper is brass unless noted

PRODUCT	DESCRIPTION	MODEL	UNITS/CASE
Press-In Strainer with "One-Hole" Overflow Plate & Matching Screw, Converter Bar, and Push eN Lift Stopper			
60104	Chrome	ABA965031	6
60110	Satin Nickel	ABA96504SN1	6
60114	Venetian Bronze	ABA96504VB1	6
60171	Oil Rubbed Bronze	ABA96504ORB1	6
60345	White	ABA96504W1	6
60324	Champagne Bronze	ABA96504CB1	6
60323	Matte Black	ABA96504MB1	6
Press-In Strainer with "One-Hole" Overflow Plate & Matching Screw, Converter Bar, and Turn Top Stopper			
60185	Chrome	ABA965071	6

Two-Hole Press-In Trim Kits



60169

- Stopper is brass unless noted

PRODUCT	DESCRIPTION	MODEL	UNITS/CASE
Press-In Strainer with "Two-Hole" Overflow Plate & Matching Screws and Push eN Lift Stopper			
60169	Chrome	ABA965032	6
60174	Satin Nickel	ABA96504SN2	6
60177	Venetian Bronze	ABA96504VB2	6
60107	Oil Rubbed Bronze	ABA96504ORB2	6
60255	Champagne Bronze	ABA96504CB2	6
60254	Matte Black	ABA96504MB2	6
Press-In Strainer with "Two-Hole" Overflow Plate & Matching Screws and Turn Top Stopper			
60186	Chrome	ABA965072	6

Cable Driven Tubular Plastic Full Kit



61022

- Strainer and stopper are brass unless noted
- Additional special finish kits available on page 201

PRODUCT	DESCRIPTION	MODEL	UNITS/CASE
PVC Tubular for 17" to 22" Deep Tubs			
61327	Less Trim	ABA652NT	1
61022	Chrome	ABA652	1

Weld-On®
Guy Gray®
Waater-Tite®
ToughPans®
RTB
Test-Tite®
AB&A®
Studor®
Truebro®
Christy's®
FloodStop®
ProVent®
ProSet®

Cable Driven Sched 40 Waste & Overflow Half Kit (Less Pipe & Tee) with Solid Brass Trim

• Additional special finish kits available below

PRODUCT	DESCRIPTION	MODEL	UNITS/CASE
ABS with 27" Cable			
69725	Less Trim	ABA700NT	1
69723	Chrome	ABA700	1
PVC with 27" Cable			
61864	Less Trim	ABA710NT	1
69742	Chrome	ABA710	1
ABS with 35" Cable			
69842	Less Trim	ABA720NT	1
69726	Chrome	ABA720	1
PVC with 35" Cable			
61875	Less Trim	ABA730NT	1
69743	Chrome	ABA730	1
ABS with 45" Cable			
61885	Less Trim	ABA740NT	1
69727	Chrome	ABA740	1
PVC with 45" Cable			
69746	Less Trim	ABA750NT	1
69744	Chrome	ABA750	1



69742

Cable Driven Solid Brass Finish Kits

PRODUCT	DESCRIPTION	MODEL	UNITS/CASE
63300	Chrome	ABA770	1
63306	Satin Nickel	ABA773SN	1
63309	Venetian Bronze	ABA773VB	1
63302	Oil Rubbed Bronze	ABA773ORB	1
63312	White	ABA773W	1



63300

Tubular Plastic Waste & Overflow – ABS



61198



61217

- Strainer and stopper are brass unless noted
- Additional special finish kits for stopper-style available on page 197





- Additional special finish kits for trip lever available on page 213

PRODUCT	DESCRIPTION	MODEL	UNITS/CASE
ABS – Trip Lever			
61198	Chrome	ABA1480	10
61203	Satin Nickel	ABA1484SN	1
61977	Venetian Bronze	ABA1484VB	1
61978	Oil Rubbed Bronze	ABA1484ORB	1
ABS – Simple As ABC Trip Lever			
61199	Chrome	ABA14809	10
61995	Satin Nickel	ABA14849SN	1
61996	Venetian Bronze	ABA14849VB	1
61202	Oil Rubbed Bronze	ABA14849ORB	1
ABS with Push eN Lift Stopper			
61217	Chrome	ABA1501	10
60713	Chrome with Zinc Strainer	ABA1501Z	10
ABS with Turn Top Stopper			
61210	Chrome	ABA1490	10
ABS with Touch Toe Stopper			
60734	Chrome	ABA1470CS	10

Weld-On®
Guy Gray®
ToughPans®
Waater-Tite®
RTB
Test-Tite®
AB&A®
Studor®
Truebro®
Christy's®
FloodStop®
ProVent®
ProSet®

Tubular Plastic Waste & Overflow – PVC

- Strainer and stopper are brass unless noted
- Additional special finish kits for stopper-style available on page 197
- Additional special finish kits for trip lever available on page 213

LISTINGS	PRODUCT	DESCRIPTION	MODEL	UNITS/CASE
	PVC – Trip Lever			
	61006	Chrome	ABA1485	10
	61207	Satin Nickel	ABA1489SN	1
	61209	Venetian Bronze	ABA1489VB	1
	61494	Oil Rubbed Bronze	ABA14890RB	1
	PVC – Simple As ABC Trip Lever			
	61013	Chrome	ABA14859	10
	61206	Satin Nickel	ABA14899SN	1
	60705	Venetian Bronze	ABA14899VB	1
	60706	Oil Rubbed Bronze	ABA148990RB	1
	PVC with Push eN Lift Stopper			
	61001	Chrome	ABA1506	10
	61047	Chrome with Zinc Strainer	ABA1506Z	10
	61221	Satin Nickel	ABA1512SN	1
	61224	Venetian Bronze	ABA1512VB	1
	61659	Oil Rubbed Bronze	ABA15120RB	1
	PVC with Turn Top Stopper			
	61014	Chrome	ABA1495	10
	61016	Chrome with Zinc Strainer and Stopper	ABA1495Z	10
	PVC with Touch Toe Stopper			
61005	Chrome	ABA1475CS	10	



61006



61001

Weld-On®
Guy Gray®
Water-Tite®
ToughPans®
RTB
Test-Tite®
AB&A®
Studor®
Truebro®
Christy's®
FloodStop®
ProVent®
ProSet®

Tubular Plastic Waste & Overflow – Heavy Duty – “Classic” w/ Test Kit – PVC



61245

- “Classic” high-flow capacity slotted overflow plate provides greater drainage through the tub overflow
- Thin gasket included for thick-walled tubs (e.g. marble)
- Thicker drain shoe and overflow elbow
- Includes compression nut
- Heavier gauge on linkage
- Strainer and stopper are brass unless noted
- Additional special finish kits available on page 188

PRODUCT	DESCRIPTION	MODEL	UNITS/CASE
Standard Length			
PVC Standard Length with Push eN Lift Stopper			
61245	Chrome	ABA4018HF	12
61692	Satin Nickel	ABA4021SNHF	12
61716	Venetian Bronze	ABA4021VBHF	12
61246	Oil Rubbed Bronze	ABA4021ORBHF	12
PVC Standard Length with Push eN Lift Stopper Solid Overflow Plate			
61722	Matte Black	ABA4021MBSO	12
PVC Standard Length with Turn Top Stopper			
61251	Chrome	ABA4051HF	12
PVC Standard Length with Touch Toe Stopper			
61249	Chrome	ABA4034CSHF	12

Weld-On®
Guy Gray®
Waater-Tite®
ToughPans®
RTB
Test-Tite®
AB&A®
Studor®
Truebro®
Christy's®
FloodStop®
ProVent®
ProSet®

Tubular Plastic Waste & Overflow – Heavy Duty – ABS

- Thicker drain shoe and overflow elbow
- Includes compression nut
- Heavier gauge on linkage
- Thicker drain shoe and overflow elbow
- Strainer and stopper are brass unless noted

- Additional special finish kits for stopper style available on page 197
- Additional special finish kits for trip lever available on page 213

PRODUCT	DESCRIPTION	MODEL	UNITS/CASE
Standard Length			
ABS Standard Length Trip Lever			
61051	Chrome	ABA4161	12
ABS Standard Length with Push eN Lift Stopper			
61258	Chrome	ABA4146	12
ABS Standard Length with Turn Top Stopper			
61275	Chrome	ABA4165	12
ABS Standard Length with Touch Toe Stopper			
60924	Chrome	ABA4164CS	12
Extra Long			
ABS Extra Long Trip Lever			
61270	Chrome	ABA41619	9
ABS Extra Long with Push eN Lift Stopper			
60887	Chrome	ABA41469	9
ABS Extra Long with Turn Top Stopper			
60917	Chrome	ABA41659	9
ABS Extra Long with Touch Toe Stopper			
60937	Chrome	ABA41649CS	9



61051



61258

Weld-On®
Guy Gray®
Water-Tite®
ToughPans®
RTB
Test-Tite®
AB&A®
Stuor®
Truebro®
Christy's®
FloodStop®
ProVent®
ProSet®

Tubular Plastic Waste & Overflow – Heavy Duty – PVC



61052



61256

- Thicker drain shoe and overflow elbow
- Includes compression nut
- Heavier gauge on linkage
- Thicker drain shoe and overflow elbow
- Strainer and stopper are brass unless noted

- Additional special finish kits for stopper style available on page 197
- Additional special finish kits for trip lever available on page 213

PRODUCT	DESCRIPTION	MODEL	UNITS/CASE
Standard Length			
PVC Standard Length Trip Lever			
61052	Chrome	ABA4151	12
PVC Standard Length with Push eN Lift Stopper			
61256	Chrome	ABA4136	12
PVC Standard Length with Turn Top Stopper			
61264	Chrome	ABA4155	12
PVC Standard Length with Touch Toe Stopper			
61263	Chrome	ABA4154S	12
Extra Long			
PVC Extra Long Trip Lever			
61053	Chrome	ABA41519	9
PVC Extra Long with Push eN Lift Stopper			
61679	Chrome	ABA41369	9
PVC Extra Long with Turn Top Stopper			
60921	Chrome	ABA41559	9
PVC Extra Long with Touch Toe Stopper			
61262	Chrome	ABA41549CS	9

Weld-On®
Guy Gray®
Waater-Tite®
ToughPans®
RTB
Test-Tite®
AB&A®
Studor®
Truebro®
Christy's®
FloodStop®
ProVent®
ProSet®

Tubular Brass Waste & Overflow – “Classic” w/ Test Kit

- Rough-in only available – contact sales representative
- “Classic” high-flow capacity slotted overflow plate provides greater drainage through the tub overflow
- Thin gasket included for thick-walled tubs (e.g. marble)
- Available with half or full ferrules
- Poly washers standard in compression nuts
- Strainer and stopper are brass unless noted
- Additional special finish kits available on page 188

LISTINGS	PRODUCT	DESCRIPTION	MODEL	UNITS/CASE
Standard Length				
20 GA Standard Length with Push eN Lift Stopper				
61002	Chrome		ABA14506HF	12
17 GA Standard Length with Push eN Lift Stopper				
61003	Chrome		ABA1450617GAHF	12
20 GA Standard Length with Turn Top Stopper				
61191	Chrome		ABA14518HF	12
17 GA Standard Length with Turn Top Stopper				
61192	Chrome		ABA1451817GAHF	12
20 GA Standard Length with Touch Toe Stopper				
64502	Chrome		ABA14511SHF	12
17 GA Standard Length with Touch Toe Stopper				
61638	Chrome		ABA1451117GASHF	12
17 GA Standard Length with Touch Toe Stopper (Solid Overflow Plate)				
61723	Chrome		ABA145117GACSO	12
Extra Long				
17 GA Extra Long with Push eN Lift Stopper				
61004	Chrome		ABA1450817GAHF	9
20 GA Extra Long with Turn Top Stopped				
61193	Chrome		ABA1452117GAHF	9
20 GA Extra Long with Touch Toe Stopper				
64519	Chrome		ABA1451517GASHF	9



61002



61723

Weld-On®
Guy Gray®
Water-Tite®
ToughPans®
RTB
Test-Tite®
AB&A®
Studor®
Truebro®
Christy's®
FloodStop®
ProVent®
ProSet®

Tubular Brass Two-Hole Slip Joint Kits with Test Kit



61010



61138

- Strainer and stopper are brass unless noted
- Available with half or full ferrules
- Poly washers standard in compression nuts
- Additional special finish kits for stopper style available on page 197

- Additional special finish kits for trip lever available on page 213

LISTINGS	PRODUCT	DESCRIPTION	MODEL	UNITS/CASE
	Standard Length			
	20 GA Standard Length Trip Lever			
	61010	Chrome	ABA1430G	12
	61123	Satin Nickel	ABA1434SN	3
	64102	Venetian Bronze	ABA1434VB	3
	61122	Oil Rubbed Bronze	ABA1434ORB	3
	17 GA Standard Length Trip Lever			
	61007	Chrome	ABA143017GA	12
	20 GA Standard Length with Push eN Lift Stopper			
	61031	Chrome	ABA1440	12
	17 GA Standard Length with Push eN Lift Stopper			
	61138	Chrome	ABA144017GA	12
	20 GA Standard Length with Turn Top Stopper			
	61046	Chrome	ABA1435	12
	17 GA Standard Length with Turn Top Stopper			
	61125	Chrome	ABA143517GA	12
	20 GA Standard Length with Touch Toe Stopper			
	64198	Chrome	ABA1421CS	12
	17 GA Standard Length with Touch Toe Stopper			
	64205	Chrome	ABA1421CS17GA	12
	Extra Long			
	20 GA Extra Long Trip Lever			
	61008	Chrome	ABA14309G	9
	17 GA Extra Long Trip Lever			
	61009	Chrome	ABA1430917GAG	9
	20 GA Extra Long with Push eN Lift Stopper			
	61144	Chrome	ABA14409	9
	17 GA Extra Long with Push eN Lift Stopper			
	61145	Chrome	ABA1440917GA	9
	20 GA Extra Long with Turn Top Stopper			
	61128	Chrome	ABA14359	9
	17 GA Extra Long with Turn Top Stopper			
	61129	Chrome	ABA1435917GAC	9
	20 GA Extra Long with Touch Toe Stopper			
	64212	Chrome	ABA14219CS	9
	17 GA Extra Long with Touch Toe Stopper			
	64219	Chrome	ABA14219CS17GA	9



Weld-On®
Guy Gray®
Waater-Tite®
ToughPans®
RTB
Test-Tite®
AB&A®
Studor®
Truebro®
Christy's®
FloodStop®
ProVent®
ProSet®

Tubular Brass Waste & Overflow – Side Outlet w/ Bent Tail Piece

- Strainer and stopper are brass unless noted
- Additional special finish kits available on page 197

LISTINGS	PRODUCT	DESCRIPTION	MODEL	UNITS/CASE
		20 GA Standard Length with Push eN Lift Stopper		
	61155	Chrome	ABA14463	1
		17 GA Standard Length with Push eN Lift Stopper		
	64238	Chrome	ABA1446317GA	1
		20 GA Standard Length with Turn Top Stopper		
	61157	Chrome	ABA14459	1
		17 GA Standard Length with Turn Top Stopper		
	61158	Chrome	ABA1445917GA	1
		20 GA Standard Length with Touch Toe Stopper		
	64257	Chrome	ABA14461CS	1
		17 GA Standard Length with Touch Toe Stopper		
	64264	Chrome	ABA14461CS17GA	1



61155

Tubular Brass Waste & Overflow – Drain in Shoe

- Strainer and stopper are brass unless noted
- Additional special finish kits available on page 197

LISTINGS	PRODUCT	DESCRIPTION	MODEL	UNITS/CASE
		20 GA Standard Length with Push eN Lift Stopper		
	61687	Chrome	ABA14473	1
		17 GA Standard Length with Push eN Lift Stopper		
	61694	Chrome	ABA1447317GA	1
		20 GA Standard Length with Turn Top Stopper		
	61165	Chrome	ABA14469	1
		17 GA Standard Length with Turn Top Stopper		
	61166	Chrome	ABA1446917GA	1
		20 GA Standard Length with Touch Toe Stopper		
	64299	Chrome	ABA14471CS	1
		17 GA Standard Length with Touch Toe Stopper		
	64306	Chrome	ABA1447117GACS	1



61687

Tubular Brass Waste & Overflow – Simply Solder Tee, “Classic” w/ Test Kit



61446

- Rough-in only available – contact sales representative
- “Classic” high-flow capacity slotted overflow plate provides greater drainage through the tub overflow
- Thin gasket included for thick-walled tubs (e.g. marble)
- Strainer and stopper are brass unless noted
- Additional special finish kits available on page 188

LISTINGS	PRODUCT	DESCRIPTION	MODEL	UNITS/CASE
Standard Length				
20 GA Standard Length with Push eN Lift Stopper				
61446	Chrome		ABA14407CLSHF	12
17 GA Standard Length with Push eN Lift Stopper				
64538	Chrome		ABA1440717CLSHF	12
20 GA Standard Length with Turn Top Stopper				
64576	Chrome		ABA14357CLSHF	12
17 GA Standard Length with Turn Top Stopper				
61445	Chrome		ABA1435717GACLSHF	12
20 GA Standard Length with Touch Toe Stopper				
64591	Chrome		ABA14217CSCLSHF	12
17 GA Standard Length with Touch Toe Stopper				
64598	Chrome		ABA14217CS17CLSHF	12
Extra Long				
17 GA Extra Long with Push eN Lift Stopper				
61718	Chrome		ABA1440817CLSHF	9
17 GA Extra Long with Turn Top Stopper				
64587	Chrome		ABA1435817CLSHF	9
17 GA Extra Long with Touch Toe Stopper				
64612	Chrome		ABA14218CS17CLSHF	9



Weld-On®
Guy Gray®
Waater-Tite®
ToughPans®
RTB
Test-Tite®
AB&A®
Studor®
Truebro®
Christy's®
FloodStop®
ProVent®
ProSet®

Tubular Brass Waste & Overflow – Simply Solder Tee

- Strainer and stopper are brass unless noted
- Additional special finish kits for stopper style available on page 197
- Additional special finish kits for trip lever available on page 213

LISTINGS	PRODUCT	DESCRIPTION	MODEL	UNITS/CASE
	20 GA Standard Length Trip Lever			
	61101	Chrome	ABA14307	12
	17 GA Standard Length Trip Lever			
	61102	Chrome	ABA1430717GA	12
	20 GA Standard Length with Push eN Lift Stopper			
	61140	Chrome	ABA14407	12
	17 GA Standard Length with Push eN Lift Stopper			
	61141	Chrome	ABA1440717GA	12
	20 GA Standard Length with Turn Top Stopper			
	61126	Chrome	ABA14357	12
	17 GA Standard Length with Turn Top Stopper			
	61000	Chrome	ABA1435717GA	12
	20 GA Standard Length with Touch Toe Stopper			
	64414	Chrome	ABA14217CS	12
	17 GA Standard Length with Touch Toe Stopper			
	64421	Chrome	ABA1421717GACS	12
	Extra Long			
	20 GA Extra Long Trip Lever			
	61103	Chrome	ABA14308	9
	17 GA Extra Long Trip Lever			
	61444	Chrome	ABA1430817GA	9
	20 GA Extra Long with Push eN Lift Stopper			
	61142	Chrome	ABA14408	9
	17 GA Extra Long with Push eN Lift Stopper			
	61717	Chrome	ABA1440817GA	9
	20 GA Extra Long with Turn Top Stopper			
	61127	Chrome	ABA14358	9
	17 GA Extra Long with Turn Top Stopper			
	64410	Chrome	ABA1435817GA	9
	17 GA Extra Long with Touch Toe Stopper			
	64435	Chrome	ABA1421817GACS	9



61101



61140

Weld-On®
Guy Gray®
Water-Tite®
ToughPans®
RTB
Test-Tite®
AB&A®
Studor®
Truebro®
Christy's®
FloodStop®
ProVent®
ProSet®

Tubular Brass Waste & Overflow – Brass “Pop-up”

• Strainer and stopper are brass unless noted

• Additional special finish kits available on page 197

LISTINGS	PRODUCT	DESCRIPTION	MODEL	UNITS/CASE
		20 GA Standard Length Side Outlet w/ Bent Tail Piece		
61153	Chrome		ABA14455	1
		17 GA Standard Length Side Outlet w/ Bent Tail Piece		
61154	Chrome		ABA1445517GA	1
		20 GA Standard Length Drain-in-Shoe		
61162	Chrome		ABA14465	1
		17 GA Standard Length Drain-in-Shoe		
61163	Chrome		ABA1446517GA	1



61153



61162

Weld-On®
Guy Gray®
Waater-Tite®
ToughPans®
RTB
Test-Tite®
AB&A®
Studor®
Truebro®
Christy's®
FloodStop®
ProVent®
ProSet®

Trip Lever Finish Kits with Grid Strainer – Available Carded for Retail Display

PRODUCT	DESCRIPTION	MODEL	UNITS/CASE
Chrome			
64036	Full Kit – Bulk	ABA1720	12
64944	Full Kit – Carded	ABA1720CARD	12
63207	Grid & Screw Only	ABA1720G	12
63208	Trip Lever Plate and Screws Only	ABA1720T	12
Polished Brass			
64936	Full Kit – Carded	ABA1722CARD	12
63211	Full Kit – Bulk	ABA1722	12
Satin Nickel			
64040	Full Kit – Bulk	ABA1723SN	12
64940	Full Kit – Carded	ABA1723SNCARD	12
Venetian Bronze			
63224	Full Kit – Bulk	ABA1723VB	12
64941	Full Kit – Carded	ABA1723VBCARD	12
Oil Rubbed Bronze			
64039	Full Kit – Bulk	ABA1723ORB	12
64938	Full Kit – Carded	ABA1723ORBCARD	12
Polished Nickel			
64939	Full Kit – Carded	ABA1723PNCARD	12
Champagne Bronze			
64043	Full Kit – Bulk	ABA1723CB	12
64044	Full Kit – Carded	ABA1723CBCARD	12
Matte Black			
63228	Matte Black – Bulk	ABA1723MB	12
63374	Matte Black – Carded	ABA1723MBCARD	12



64036

Trip Lever "Pop-up" Finish Kits

PRODUCT	DESCRIPTION	MODEL	UNITS/CASE
61175	Pop-up Strainer Trip Lever Plate and Screws, Chrome	ABA14476	12



61175

Waste & Overflow One Hole Test Kits



PRODUCT	DESCRIPTION	MODEL	UNITS/CASE
68683	One-Hole Test Kit	ABA6916	12
68684	One-Hole Metal Test Kit	ABA6916M	12

Waste & Overflow Two Hole Test Kits



PRODUCT	DESCRIPTION	MODEL	UNITS/CASE
69510	Two-Hole Test Kit (plastic only)	ABA6919	12

Waste & Overflow "Classic" Test Kits



PRODUCT	DESCRIPTION	MODEL	UNITS/CASE
"Classic" Overflow Test Cap			
69601	ABS	ABA2352	15
68210	PVC	ABA2353	15
Strainer Test Stopper			
68685	Plastic	ABA6918	12
68038	Metal	ABA6918M	12

Weld-On®
Guy Gray®
Waater-Tite®
ToughPans®
RTB
Test-Tite®
AB&A®
Studor®
Truebro®
Christy's®
FloodStop®
ProVent®
ProSet®



Brass Waste & Overflow Fittings

PRODUCT	DESCRIPTION	MODEL	UNITS/CASE
Two-Hole Overflow Elbow & Tube			
68184	Standard 20Ga	ABA281	1
68138	Standard 17Ga	ABA282	1
60095	Long 20Ga	ABA281L	1
60096	Long 17Ga	ABA282L	1
Classic Overflow Elbow & Tube			
60098	Standard 20Ga	ABA281CLC	1
60099	Standard 17Ga	ABA282CLC	1
60097	Long 20Ga	ABA281LCLC	1
60094	Long 17Ga	ABA282LCLC	1
Waste Arm & Shoe			
60123	Drain-in-tee Shoe with 5" Tube 20Ga	ABA254	1
60090	Drain-in-tee Shoe with 5" Tube 17Ga	ABA253	1
60064	Drain-in-tee Shoe with 9" Tube 20Ga	ABA254L	1
60122	Drain-in-tee Shoe with 9" Tube 17Ga	ABA253L	1
Brass Waste Tees and Fittings			
68137	Slip Tee	ABA248	1
68080	Simply Solder Tee	ABA3460053C	1
61181	Side Outlet	ABA14482	1
69000	Straight Tailpiece 20Ga	ABA4101820	1
68120	Straight Tailpiece 17Ga	ABA41018	1



61181



Waste & Overflow Accessories

ProSet® ProVent® FloodStop® Christy's® Truebro® Studor® AB&A® Test-Tite® RTB ToughPans® Waater-Tite® Guy Gray® Weld-On®



PRODUCT	DESCRIPTION	MODEL	UNITS/CASE
Linkages			
69607	"G" Style	ABA41857	1
60063	"G" Style – Long	ABA41857XL	1
Slip Nuts & Washers			
68850	1-1/2" Brass Slip Nuts – Rough Brass	ABA285	50
69809	Full Brass Ferrule 1-1/2"	ABA168	50
69578	Half Brass Ferrule 1-1/2"	ABA168H	50
Washers & Gaskets			
69668	"G" Style Overflow Gasket	ABA6855	1
69514	Heavy Overflow Gasket	ABA6854	1
69516	Sponge Overflow Gasket	ABA6859	1
69998	Thin Sponge Overflow Gasket (for thick tubs)	ABA6960	1
69900	Classic Overflow Locking Washer - PVC	ABA2350HF	15
69513	Rubber Strainer Washer	ABA6850	1
63000	Metal Converter Bar – Two-Hole to One-Hole	ABA4227	10
69611	Retaining Clip w/ Screws for Two-Hole Elbow	ABA4230	25
Inside Pipe Cutters			
69604	Inside Pipe Cutter 2" Bulk Pack	ABA2450	12
69501	Inside Pipe Cutter 2" Retail Pack	ABA2450CARD	12
69502	Inside Pipe Cutter 3" Bulk Pack	ABA2451	12
69503	Inside Pipe Cutter 3" Retail Pack	ABA2451CARD	12
69504	Inside Pipe Cutter Replacement Blades – 3 Pack Bulk	ABA2452	12
69505	Inside Pipe Cutter Replacement Blades – 3 Pack Retail	ABA2452CARD	12



Weld-On®

Guy Gray®

Water-Tite®

ToughPans®

RTB

Test-Tite®

AB&A®

Studor®

Truebro®

Christy's®

FloodStop®

ProVent®

ProSet®

Schedule 40 Waste & Overflow Fittings

PRODUCT	DESCRIPTION	MODEL	UNITS/CASE
Overflow Elbows			
69597	Classic (Male Threaded) ABS	ABA2344	15
69598	Classic (Male Threaded) PVC	ABA2345	15
69602	Classic Long (Male Threaded) ABS	ABA2361	15
68457	Classic Long (Male Threaded) PVC	ABA2362	15
68079	Classic (Male Threaded) With Condensate Conx. - Threaded PVC	ABA2356	15
68066	Classic (Male Threaded) With Condensate Conx. - Slip PVC	ABA2359	15
69572	One-Hole ABS	ABA1208A	15
69622	One-Hole PVC	ABA1208P	15
69580	Two-Hole ABS	ABA1508A	15
69582	Two-Hole PVC	ABA1508P	15
Waste Fittings			
69570	Drain Shoe ABS	ABA1204A	15
69571	Drain Shoe PVC	ABA1204P	15
69567	Straight Adapter (H x FPT) ABS	ABA1513	15
69568	Straight Adapter (H x FPT) PVC	ABA1514	15
Direct Drain Tees			
65500	ABS Direct Drain Tee Only, 1-1/2	ABA2227DD	15
65600	PVC Direct Drain Tee Only, 1-1/2	ABA2228DD	15



69598



69622



69582



69567



65600



Waste & Overflow Strainers

Weld-On®
Guy Gray®
ToughPans®
Waater-Tite®
RTB
Test-Tite®
AB&A®
Studor®
Truebro®
Christy's®
FloodStop®
ProVent®
ProSet®



69512



69648



69520

PRODUCT	DESCRIPTION	MODEL	UNITS/CASE
Brass Waste Strainer – 1-1/2" – 11-1/2 Coarse Thread – For 3/8" Post Stopper			
69512	Chrome	ABA6820	15
69642	Polished Brass	ABA6822	1
69645	Satin Nickel	ABA6824SN	15
69646	Venetian Bronze	ABA6824VB	1
69644	Oil Rubbed Bronze	ABA6824ORB	1
69647	White	ABA6824W	1
69016	Champagne Bronze	ABA6824CB	1
68243	Matte Black	ABA6824MB	1
Brass Waste Strainer – 1-1/2" – 11-1/2 Coarse Thread – Flip Top			
69808	Chrome	ABA682088	1
69643	Satin Nickel	ABA6824SN88	1
69333	Venetian Bronze	ABA6824VB88	1
69334	Oil Rubbed Bronze	ABA6824ORB88	1
Brass Waste Strainer – 1-3/8" – 16 Fine Thread – For 3/8" Post Stopper			
69648	Chrome	ABA6830	1
69336	Polished Brass	ABA6832	1
68052	Satin Nickel	ABA6834SN	1
69337	Venetian Bronze	ABA6834VB	1
69649	Oil Rubbed Bronze	ABA6834ORB	1
69338	Polished Nickel	ABA6834PN	1
69342	White	ABA6834W	1
Brass Waste Strainer – 1-1/2" – 14 Fine Thread – For 3/8" Post Stopper			
69638	Chrome	ABA6805	1
Brass Waste Strainer – 1-1/2" – 16 Fine Thread – For 3/8" Post Stopper			
69639	Chrome	ABA6810	1
69640	Chrome – 3" Flange	ABA6812	1
Brass Adapter Bushings			
69520	1.625" – 16 Thread to 1.865" 11-1/2 Thread	ABA6899	20
69767	1.625" – 16 Thread to 1.8" 16 Thread	ABA6901	1
69769	1.865" – 11-1/2 Thread to 2.11 – 16 Thread (Kohler®)	ABA6903	1

Kohler® is a registered trademark of Kohler Co.

Waste & Overflow Strainers

PRODUCT	DESCRIPTION	MODEL	UNITS/CASE
Push eN Lift Stopper – 3/8" Post			
63005	Chrome	ABA1595	20
63071	Chrome – ABS	ABA1595P	20
63072	Polished Brass	ABA1597	1
63074	Satin Nickel	ABA1599SN	20
63077	Venetian Bronze	ABA1599VB	20
63073	Oil Rubbed Bronze	ABA1599ORB	20
69351	Satin Chrome	ABA1599SC	1
68090	White	ABA1599W	1
69017	Champagne Bronze	ABA1599CB	1
68254	Matte Black	ABA1599MB	1
Push eN Lift Stopper – Short Stem – 3/8" Post			
63173	Chrome	ABA1680	1
Push eN Lift Stopper – With 3/8" and 5/16" Posts			
63004	Chrome	ABA1648	20
63126	Polished Brass	ABA1650	1
63127	Satin Nickel	ABA1652SN	1
69357	Venetian Bronze	ABA1652VB	1
Turn Top Stopper – 3/8" Post			
63080	Chrome - Zinc (Flapper Style)	ABA1605	20
68043	Chrome - Zinc (O-Ring Style)	ABA1605ZO	20
Touch Toe Stopper – 3/8" Post			
66828	Chrome (Stopper Only)	ABA1580CSS	20
69367	Polished Brass (Includes Strainer)	ABA1582CS	1
63060	Satin Nickel (Includes Strainer)	ABA1584SNCS	1
63324	Venetian Bronze (Includes Strainer)	ABA1584VBCS	1
68198	Oil Rubbed Bronze (Includes Strainer)	ABA1584ORBCS	1
69369	White (Includes Strainer)	ABA1584WCS	1
69373	Champagne Bronze (Stopper Only)	ABA1584MBCS	1
68419	Matte Black (Stopper Only)	ABA1584CBCS	1
Touch Toe Stopper – Short Stem – 3/8" Post			
63066	Chrome	ABA1590	20
Push eN Lift or Turn Top Post Only			
68075	2" Long – 5/16" Post	ABA6893	20



Weld-On®
Guy Gray®
Water-Tite®
ToughPans®
RTB
Test-Tite®
AB&A®
Studor®
Truebro®
Christy's®
FloodStop®
ProVent®
ProSet®



Overflow Plates

- Classic high-flow capacity slotted overflow plate provides greater drainage through the tub overflow



63002



69991



63001



69656

PRODUCT	DESCRIPTION	MODEL	UNITS/CASE
"Classic" High-flow Capacity Overflow Plate			
63002	Chrome	ABA2340HF	15
69590	Polished Brass	ABA2342PBHF	1
69591	Satin Nickel	ABA2342SNHF	1
69594	Venetian Bronze	ABA2342VBHF	1
69589	Oil Rubbed Bronze	ABA2342ORBHF	1
68551	Polished Nickel	ABA2342PNHF	1
69595	White	ABA2342WHF	1
69957	Champagne Bronze	ABA2342CBHF	1
69596	Matte Black	ABA2342MBHF	1
"Classic" Solid Overflow Plate			
69991	Chrome	ABA2550	15
69992	Satin Nickel	ABA2551	15
69993	Venetian Bronze	ABA2552	15
69994	Oil-Rubbed Bronze	ABA2553	15
69990	Champagne Bronze	ABA2551MB	15
69989	Matte Black	ABA2551CB	15
"One-Hole" Overflow Plate with 2-1/4" Screw			
63001	Chrome	ABA6835	15
69653	Satin Nickel	ABA6841SN	1
69654	Venetian Bronze	ABA6841VB	1
69652	Oil Rubbed Bronze	ABA6841ORB	1
68215	Polished Nickel	ABA6841PN	1
68246	Satin Chrome	ABA6841SC	1
69655	White	ABA6841W	1
69372	Champagne Bronze	ABA6841CB	1
69380	Matte Black	ABA6841MB	1
"Two-Hole" Overflow Plate with two 2-1/4" Screws			
69656	Chrome	ABA6845	15
69658	Polished Brass	ABA6847	1
69662	Satin Nickel	ABA6849SN	1
69664	Venetian Bronze	ABA6849VB	1
69661	Oil Rubbed Bronze	ABA6849ORB	1
68143	Satin Chrome	ABA6849SC	1
69375	Satin Pearl	ABA6849SP	1
60568	Champagne Bronze	ABA6849MB	1
60567	Matte Black	ABA6849CB	1

Lavatory Drains

PRODUCT	DESCRIPTION	MODEL	UNITS/CASE
Brass Body with Push on Lift Stopper			
68304	Chrome With Overflow	ABA1728	12
68319	Chrome Less Overflow	ABA1728S	1
Brass Body with Flip Top Stopper			
68363	Chrome With Overflow	ABA1748	12
68364	Chrome Less Overflow	ABA1748S	1
Heavy Brass Grid Drain with 6" 17Ga Tailpiece and Brass Locknut			
68309	Chrome With Overflow	ABA1736	20
68349	Chrome Less Overflow	ABA1736S	1
68355	Satin Nickel With Overflow	ABA1738SN	1
68356	Satin Nickel Less Overflow	ABA1738SNS	1
Heavy Brass Offset Lavatory Strainer 17Ga – ADA Compliant			
68361	Chrome With Overflow	ABA1739	20
Brass Lavatory Drain – "Pop-up"			
68308	Chrome With Overflow	ABA1733	20
68343	Chrome Less Overflow	ABA1733S	1



68304



68309



68308

Tub Spouts

PRODUCT	DESCRIPTION	MODEL	UNITS/CASE
68375	5" Zinc – 1/2" FIPS at Nose End – No Diverter	ABA1920	12
68376	5" Zinc – 1/2" Slide Conx. – No Diverter	ABA1930	12
68377	5" Zinc – 1/2" FIPS at Nose End – With Diverter	ABA1935	12
68762	5" Zinc – 1/2" Slide Conx. – With Diverter	ABA1945	12
68382	5" Brass – 1/2" x 3/4" FIPS at Nose End – With Diverter	ABA1960	12



68762

Weld-On®
Guy Gray®
Water-Tite®
ToughPans®
RTB
Test-Tite®
AB&A®
Studor®
Truebro®
Christy's®
FloodStop®
ProVent®
ProSet®

Los Angeles Style P-Traps



68310



69511

PRODUCT	DESCRIPTION	MODEL	UNITS/CASE
Heavy Duty Cast Brass with Cast Brass Slip Joint Nut			
68300	Rough Brass 1-1/2" x 1-1/2"	ABA102	10
68301	Chrome Plated 1-1/2" x 1-1/2"	ABA107	10
68302	Chrome Plated 1-1/4" x 1-1/2"	ABA108	10
Heavy Duty Cast Brass Extra Low Seal "G" Trap			
68310	Rough Brass 1-1/2" x 1-1/2"	ABA120	1
Heavy Duty Cast Brass Low Pattern Trap			
68313	Rough Brass 1-1/2" x 1-1/2"	ABA130	1
ABS LA Pattern Trap with Union			
69511	1-1/2" x 1-1/2"	ABA3221A	50
69605	1-1/2" x 1-1/4"	ABA3221B	50
ABS Slip Joint Nut			
69508	1-1/2" x 1-1/2"	ABA3931	50
69509	1-1/2" x 1-1/4"	ABA3933	50

Weld-On®
Guy Gray®
Waater-Tite®
ToughPans®
RTB
Test-Tite®
AB&A®
Studor®
Truebro®
Christy's®
FloodStop®
ProVent®
ProSet®

Cleanout Covers

PRODUCT	DESCRIPTION	MODEL	UNITS/CASE
Plastic Flat with 2-1/2" Wood Screw			
68400	Chrome – 4-1/2"	ABA1645	25
68401	Chrome – 5 1/2"	ABA1655	25
68402	Chrome – 7 1/2"	ABA1675	10
68870	Chrome – 9-1/2"	ABA1695	5
68403	White – 4-1/2"	ABA1646	25
68404	White – 5 1/2"	ABA1656	25
68869	White – 7 1/2"	ABA1676	10
68871	White – 9-1/2"	ABA1696	5
Plastic Bell with 2-1/2" Wood Screw			
68450	Chrome – 4-1/2"	ABA1745	25
68451	Chrome – 5 1/2"	ABA1755	25
68452	Chrome – 7 1/2"	ABA1775	25
68453	White – 4-1/2"	ABA1746	25
68454	White – 5 1/2"	ABA1756	25
68455	White – 7 1/2"	ABA1776	25
24-gauge Stainless Steel Cleanout Cover			
68813	3" with 1/4" x 20 Screw	ABA1840	25
68480	4" with 1/4" x 20 Screw	ABA1841	25
68481	5" with 1/4" x 20 Screw	ABA1842	25
68482	6" with 1/4" x 20 Screw	ABA1843	25
68819	7" with 1/4" x 20 Screw	ABA1844	25
68820	8" with 1/4" x 20 Screw	ABA1845	25
68823	10" with 1/4" x 20 Screw	ABA1848	25
69254	4" with 5/16" Screw	ABA18416865516	25
69262	5" with 5/16" Screw	ABA18426865516	25
Cleanout & Cover Packages with ABS Quick-Fit Cleanout Fitting and Tapped Plug			
69574	4-1/2" White Bell Cover – 2" DWV Pipe	ABAKCOB2	25
69575	4-1/2" White Bell Cover – 3" DWV Pipe	ABAKCOB3	25



68400



68450



68813

Weld-On®

Guy Gray®

Water-Tite®

ToughPans®

RTB

Test-Tite®

AB&A®

Studor®

Truebro®

Christy's®

FloodStop®

ProVent®

ProSet®

Los Angeles Style Brass Cleanout Plugs



68604



68652

PRODUCT	DESCRIPTION	MODEL	UNITS/CASE
Raised Head			
68600	Raised Head 1-1/2"	ABA175	5
68601	Raised Head 2"	ABA176	10
68602	Raised Head 2-1/2"	ABA177	10
68603	Raised Head 3"	ABA178	10
68604	Raised Head 3-1/2"	ABA179	10
68605	Raised Head 4"	ABA180	5
68812	Raised Head 6"	ABA182	1
Countersunk			
68828	Countersunk – Slotted Head 1-1/2"	ABA201	5
68650	Countersunk – Slotted Head 2"	ABA202	10
68651	Countersunk – Slotted Head 2-1/2"	ABA203	10
68652	Countersunk – Slotted Head 3"	ABA204	10
68653	Countersunk – Slotted Head 3-1/2"	ABA205	10
68654	Countersunk – Slotted Head 4"	ABA206	5
68830	Countersunk – Slotted Head 6"	ABA208	1
68655	Countersunk – Slotted Head 1-1/2" – Tapped 5/16"	ABA215	5
68656	Countersunk – Slotted Head 2" – Tapped 5/16"	ABA216	10
68831	Countersunk – Slotted Head 2-1/2" – Tapped 5/16"	ABA217	10
68657	Countersunk – Slotted Head 3" – Tapped 5/16"	ABA218	10
68658	Countersunk – Slotted Head 3-1/2" – Tapped 5/16"	ABA219	10
68659	Countersunk – Slotted Head 4" – Tapped 5/16"	ABA220	5
68832	Countersunk – Slotted Head 5" – Tapped 5/16"	ABA221	1
68833	Countersunk – Slotted Head 6" – Tapped 5/16"	ABA222	1
69257	Countersunk – Slotted Head 1-1/2" – Tapped 1/4"	ABA21514	10
69267	Countersunk – Slotted Head 2" – Tapped 1/4"	ABA21614	10
69258	Countersunk – Slotted Head 2-1/2" – Tapped 1/4"	ABA21714	10
69284	Countersunk – Slotted Head 3" – Tapped 1/4"	ABA21814	10
69290	Countersunk – Slotted Head 3-1/2" – Tapped 1/4"	ABA21914	10
69291	Countersunk – Slotted Head 4" – Tapped 1/4"	ABA22014	5

Weld-On®
Guy Gray®
Waater-Tite®
ToughPans®
RTB
Test-Tite®
AB&A®
Studor®
Truebro®
Christy's®
FloodStop®
ProVent®
ProSet®

Southern Style Brass Cleanout Plugs

PRODUCT	DESCRIPTION	MODEL	UNITS/CASE
Raised Head			
68700	Raised Head 1-1/2"	ABA235	5
68701	Raised Head 2"	ABA236	5
68837	Raised Head 2-1/2"	ABA237	20
68839	Raised Head 3"	ABA238	20
68702	Raised Head 3-1/2"	ABA239	20
68703	Raised Head 4"	ABA240	15
68843	Raised Head 5"	ABA241	10
68845	Raised Head 6"	ABA242	5
69778	Raised Head 8"	ABA243	5
69779	Raised Head 10"	ABA244	1
Countersunk			
68834	Countersunk – 1-1/2"	ABA235CS	25
68750	Countersunk – 2"	ABA236CS	25
68751	Countersunk – 2-1/2"	ABA237CS	20
68492	Countersunk – 3"	ABA238CS	20
68753	Countersunk – 3-1/2"	ABA239CS	20
68754	Countersunk – 4"	ABA240CS	15
68846	Countersunk – 6"	ABA242CS	5

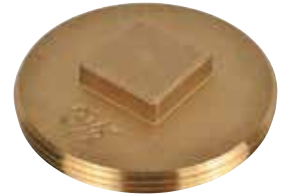

68702

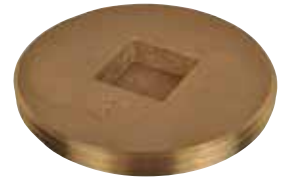

68492

Quick-Fit Cleanout Fitting with Plastic Countersunk Plug (Fits inside Sched 40 DWV Pipe)

PRODUCT	DESCRIPTION	MODEL	UNITS/CASE
68500	ABS – 2" (with 1-1/2" plug)	ABA200CA	50
68501	ABS – 3" (with 2-1/2" plug)	ABA300CA	50
68502	ABS – 4" (with 3-1/2" plug)	ABA400CA	50
68503	PVC – 2" (with 1-1/2" plug)	ABA200CP	50
68504	PVC – 3" (with 2-1/2" plug)	ABA300CP	50
68505	PVC – 4" (with 3-1/2" plug)	ABA400CP	50



68500

68504

Quick-Fit Cleanout Fitting Only (Fits inside Sched 40 DWV Pipe)

PRODUCT	DESCRIPTION	MODEL	UNITS/CASE
68800	ABS – 2"	68800	50
68801	ABS – 3"	68801	50
68802	ABS – 4"	68802	50
68827	PVC – 2"	68827	50
68872	PVC – 3"	68872	50
68864	PVC – 4"	68864	50



68800

68827

Plastic Countersunk Plug



68512

PRODUCT	DESCRIPTION	MODEL	UNITS/CASE
68506	ABS – 1-1/2"	ABA3051CA	50
68507	ABS – 2"	ABA3052CA	50
68512	ABS – 2-1/2"	ABA3055CA	50
68509	ABS – 3"	ABA3053CA	50
68513	ABS – 3-1/2"	ABA3056CA	25
68511	ABS – 4"	ABA3054CA	25
68514	PVC – 1-1/2"	ABA3051CP	50
68515	PVC – 2"	ABA3052CP	50
68860	PVC – 2-1/2"	ABA3055CP	50
68516	PVC – 3"	ABA3053CP	50
68518	PVC – 3-1/2"	ABA3056CP	25
68517	PVC – 4"	ABA3054CP	25

Plastic Countersunk Plug with 1/4" x 20 Threaded Brass Insert



68508

PRODUCT	DESCRIPTION	MODEL	UNITS/CASE
68853	ABS – 1-1/2" – with 1/4" Threaded Insert	ABA3051CAI	20
68508	ABS – 2" – with 1/4" Threaded Insert	ABA3052CAI	20
68859	ABS – 2-1/2" – with 1/4" Threaded Insert	ABA3055CAI	20
68510	ABS – 3" – with 1/4" Threaded Insert	ABA3053CAI	20
69780	ABS – 3-1/2" – with 1/4" Threaded Insert	ABA3056CAI	20
68857	ABS – 4" – with 1/4" Threaded Insert	ABA3054CAI	20
68854	PVC – 1-1/2" – with 1/4" Threaded Insert	ABA3051CPI	20
68855	PVC – 2" – with 1/4" Threaded Insert	ABA3052CPI	20
68407	PVC – 2-1/2" – with 1/4" Threaded Insert	ABA3055CPI	20
68856	PVC – 3" – with 1/4" Threaded Insert	ABA3053CPI	20
68861	PVC – 3-1/2" – with 1/4" Threaded Insert	ABA3056CPI	20
68858	PVC – 4" – with 1/4" Threaded Insert	ABA3054CPI	20

Weld-On®
Guy Gray®
Waater-Tite®
ToughPans®
RTB
Test-Tite®
AB&A®
Studor®
Truebro®
Christy's®
FloodStop®
ProVent®
ProSet®

Plastic Square Head Plug

PRODUCT	DESCRIPTION	MODEL	UNITS/CASE
68490	ABS – 1-1/2"	ABA3051RA	50
68491	ABS – 2"	ABA3052RA	50
68494	ABS – 2-1/2"	ABA3055RA	50
68752	ABS – 3"	ABA3053RA	50
68755	ABS – 3-1/2"	ABA3056RA	25
68493	ABS – 4"	ABA3054RA	25
68756	PVC – 1-1/2"	ABA3051RP	50
68757	PVC – 2"	ABA3052RP	50
68760	PVC – 2-1/2"	ABA3055RP	50
68758	PVC – 3"	ABA3053RP	50
68761	PVC – 3-1/2"	ABA3056RP	25
68759	PVC – 4"	ABA3054RP	25



68758

Press In Cleanout Fitting – For Use with Sched 40 DWV Pipe (Plastic)

PRODUCT	DESCRIPTION	MODEL	UNITS/CASE
ABS			
68550	ABS 2" x 3" with Countersunk Plastic Plug	ABA450	20
85919	ABS 3" x 4" with Countersunk Plastic Plug	5896	10
PVC			
85916	PVC 2" x 3" with Countersunk Plastic Plug	4895	10
85918	PVC 3" x 4" with Countersunk Plastic Plug	4896	10



85918

Press In Cleanout Fitting – For Use with Sched 40 DWV Pipe (Brass)

PRODUCT	DESCRIPTION	MODEL	UNITS/CASE
ABS			
64648	ABS 2" x 3" with Countersunk Brass Plug	ABA451	20
PVC			
68866	PVC 2" x 3" with Countersunk Brass Plug	ABA457	20
68867	PVC 3" x 4" with Countersunk Brass Plug	ABA459	20

Trap-Tite™ Waterless Trap Seal



69420

- Mitigates trap seal loss due to evaporation
- Prevents harmful sewer gases from entering building
- Protects against entry of vermin into habitable spaces
- Sealing rings on the outer edge of the Trap-Tite™ will keep device in place for the life of the product while the inner flaps will open when liquids pour down the drain.
- ASSE 1072 rated AF-GW
- Rated for grease-laden waste applications

PRODUCT	DESCRIPTION	MODEL	UNITS/CASE
69420	2" Waterless Trap Seal	TT2	24
69430	3" Waterless Trap Seal	TT3	24
69435	3-1/2" Waterless Trap Seal	TT35	24
69440	4" Waterless Trap Seal	TT4	24

Cast Iron Shower Drain



60210

- Shower drain for tile and marble showers
- Rugged two-piece construction with included 3-1/4-inch steel strainer

LISTINGS	PRODUCT	DESCRIPTION	MODEL	UNITS/CASE
	60210	2" Quick-Set Replaces AB&A® 564-S (7120 Series)	ABA564	1

Strainers

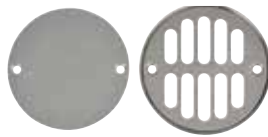

69569

- Includes protection plate
- Replacement grate for shower drains
- Includes all parts necessary for quick and easy installation
- Pick from a variety of finishes

PRODUCT	DESCRIPTION	MODEL	UNITS/CASE
Round 3-1/4" Steel Grate w/ Screws – 2 7/8" Center to Center (7120 Series)			
69569	Chrome Grate & Crown	ABA5145	15
69615	Satin Nickel Grate & Crown	ABA5149SN	1
69614	Oil Rubbed Bronze Grate & Crown	ABA5149ORB	1
69685	Matte Black Grate & Crown	ABA5149MB	1
69686	Champagne Bronze Grate & Crown	ABA5149CB	1

Cast Iron Floor Cleanout



60300

- Non-adjustable nickel bronze top

PRODUCT	DESCRIPTION	MODEL	UNITS/CASE
60309	3" No-Hub	ABA553	12
60300	4" No-Hub	ABA554	8

Cast Iron Cesspool Drain

- 8-1/2-inch-wide drain
- Slotted grate
- Connects to existing cast-iron pipes via a 4-inch no-hub connection

PRODUCT	DESCRIPTION	MODEL	UNITS/CASE
60226	4" No-Hub x 8-1/2" Top	ABA634	1



60226

Cast Iron "Set-N-Go" Closet Ring

- Simple installation
- Creates a reliable foundation for your toilet installation
- Securely connects the toilet to the drain pipe
- Includes a test cap that can be easily removed once the system has been properly tested

PRODUCT	DESCRIPTION	MODEL	UNITS/CASE
60002	4" x 2" with Test Cap	ABA042	1
60005	4" x 4" with Test Cap	ABA044	1



60002

Cast Iron Roof Drain

- 6-1/2-inch cast-iron dome
- Prevents branches and other debris from entering the piping system
- Connects to existing cast-iron pipes via a 3-inch no-hub bottom outlet connection

LISTINGS	PRODUCT	DESCRIPTION	MODEL	UNITS/CASE
	60213	3" No-hub Bottom Outlet	ABA573	1
	60214	4" No-hub Bottom Outlet	ABA574	1



60214

Cast Iron Roof Drain with Overflow Combo

- Durable cast-iron roof drain and overflow combo ideal for flat roofs
- 6-1/2-inch cast-iron dome prevents unwanted materials from entering the drain
- Connects via 3-inch no-hub connection

LISTINGS	PRODUCT	DESCRIPTION	MODEL	UNITS/CASE
	60219	2" No-hub Outlet	ABA602	1
	60220	3" No-hub Outlet	ABA603	1
	60222	4" No-hub Outlet	ABA604	1
	60218	6-1/2" Dome with Ring & Hardware	ABA586	1



60220

Cast Iron Floor Drain



60233

- Durable cast-iron floor drain
- 4-inch adjustable nickel-bronze grate for preventing unwanted materials from entering drain
- Connects via 2-inch no-hub connection

PRODUCT	DESCRIPTION	MODEL	UNITS/CASE
60233	2" No-Hub	ABA512	1

Cast Iron Floor Drain with Trap Primer



60200

- Reliable drainage for basements, workshops, boiler rooms, and more.
- Features a 5-inch adjustable nickel-bronze
- Connects to existing cast-iron pipes via a 2-inch no-hub connection
- Built-in trap primer prevents unpleasant sewer gases from exiting the drain

LISTINGS	PRODUCT	DESCRIPTION	MODEL	UNITS/CASE
	60200	2" No-Hub	ABA502	1
	60231	3" No-Hub	ABA503	1
	60232	4" No-Hub	ABA504	1
	60227	Round Replacement Grate	ABA8612	8

Floor Sinks



60403

- Durable cast-iron floor sink with porcelain coating to resist grime
- Ensures pipe backups don't contaminate food preparation areas
- Connects via 2-inch no-hub connection

LISTINGS	PRODUCT	DESCRIPTION	MODEL	UNITS/CASE
	Square – 12" x 12" Flange Dimension – 6" Deep			
	60400	2" No-hub Conx.	ABA302	1
	60401	3" No-hub Conx.	ABA303	1
	60402	3" Push-On Conx.	ABA303PO	1
	60403	4" No-hub Conx.	ABA304	1
	Square – 12" x 12" Flange Dimension – 8" Deep			
	60405	2" No-hub Conx.	ABA312	1
	60406	3" No-hub Conx.	ABA313	1
	Round- 8" Flange Dimension – 6" Deep			
	60414	2" No-hub Conx.	ABA352	1
	60415	3" No-hub Conx.	ABA353	1



60414

Weld-On®
Guy Gray®
Waater-Tite®
ToughPans®
RTB
Test-Tite®
AB&A®
Studor®
Truebro®
Christy's®
FloodStop®
ProVent®
ProSet®

Floor Sink Grates

- Porcelain-coated cast iron
- UPC Listed

LISTINGS	PRODUCT	DESCRIPTION	MODEL	UNITS/CASE
	Square Grate – 12"			
	60500	Half Grate	ABA402	1
	60501	Three-quarter Grate	ABA403	1
	60502	Full Grate	ABA404	1
	Round Grate – 8"			
	60512	Half Grate	ABA432	1
60514	Full Grate	ABA434	1	



60500



60502



60514

Floor Sink Accessories

- Porcelain-coated cast iron
- UPC Listed

LISTINGS	PRODUCT	DESCRIPTION	MODEL	UNITS/CASE
	Sediment Baskets For Cast Iron Sinks			
	65800	For 12" Square	ABA480	6
	Dome Strainers			
67100	4" Aluminum Dome Strainer for Cast Iron Sinks	ABA489	6	



65800

Drain Strainers & Cleanout Covers, & Crowns



69208



69214

PRODUCT	DESCRIPTION	MODEL	UNITS/CASE
Nickel Bronze Drain Strainer			
69207	4"	ABA8595	3
69208	5"	ABA8600	3
69209	6"	ABA8610	3
Nickel Bronze Cleanout Cover			
69214	5"	ABA8637	3
69215	6"	ABA8640	3
Nickel Bronze Round Crown			
68102	5"	ABA8620	3
69212	6"	ABA8630	3
Screws			
69228	Stainless Steel Screws	ABA8825	100

Adjustable General Purpose Drains with Crown



65002

PRODUCT	DESCRIPTION	MODEL	UNITS/CASE
5" Nickel Bronze Drain Tapped & Plugged w/ Crown – 3" x 4" Bushing			
65319	ABS	ABA8190	6
65804	PVC	ABA8195	6
6" Nickel Bronze Drain Tapped & Plugged w/ Crown – 3" x 4" Bushing			
65002	PVC	ABA8225	6
6" Nickel Bronze Drain w/ Crown – 4" Fitting Adapter			
65493	PVC	ABA8135	6
6" Chrome Cover-all Strainer – 4" Fitting Adapter			
85895	PVC	4841B	6

Adjustable General Purpose Drains without Crown

PRODUCT	DESCRIPTION	MODEL	UNITS/CASE
5" Nickel Bronze Drain Tapped & Plugged Less Crown – 3" x 4" Bushing			
65805	PVC	ABA8205	6
6" Nickel Bronze Drain Tapped & Plugged Less Crown – 3" x 4" Bushing			
65323	PVC	ABA8235	6



65805

Adjustable General Purpose Cleanouts with Crown

PRODUCT	DESCRIPTION	MODEL	UNITS/CASE
5" Nickel Bronze CO Tapped & Plugged w/ Crown – 3" x 4" Bushing			
65326	ABS	ABA82505	6
65806	PVC	ABA82555	6
6" Nickel Bronze CO Tapped & Plugged w/ Crown – 3" x 4" Bushing			
65301	PVC	ABA8255	6
6" Nickel Bronze CO w/ Crown – 4" Fitting Adapter			
65003	PVC	ABA8165	6
6" Scored Skid Resistant Brass Cover-all Cover – 4" Fitting Adapter			
85910	ABS	5841A4	10
85905	PVC	4841A4	10



65806



65003

Adjustable General Purpose Cleanouts without Crown

PRODUCT	DESCRIPTION	MODEL	UNITS/CASE
6" Nickel Bronze Cleanout Less Crown – 4" Fitting Adapter			
65317	PVC	ABA8175	6
6" Polished Brass Cleanout Crown - 4" Fitting Adapter			
65300	PVC	ABA8176	6



65317

ABACO Floor Cleanout Access Covers

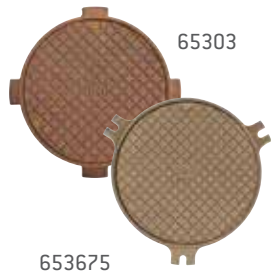

- Bronze frame and solid scoriated cover
- Used where a solid cover is required
- Frame includes anchor lugs, screws included

PRODUCT	DESCRIPTION	MODEL	UNITS/CASE
65303	Round Crown 6" with Screws	ABA8880	6
65365	Round Crown 7" with Screws	ABA8884	6

General Purpose Drains



85960



85951



85815

LISTINGS	PRODUCT	DESCRIPTION	MODEL	UNITS/CASE
	Snap-In Plastic Drain			
	85945	ABS For 2" Pipe	5802	20
	85955	ABS For 3" Pipe	5803	20
	85965	ABS For 4" Pipe	5804	20
	85940	PVC For 2" Pipe	4802	20
	85950	PVC For 3" Pipe	4803	20
	85960	PVC For 4" Pipe	4804	20
	Snap-In Plastic Drain with Stainless Steel Cover			
	85951	PVC For 3" Pipe	4803S	20
	85961	PVC For 4" Pipe	4804S	20
	2" X 3" (Fits 2" or 3" DWV Pipe)			
	85820	ABS with Stainless Steel Cover-all Strainer	5840S2	20
	82151	ABS with SS Cover-all Strainer – Display Pack	R5842S	6
	85830	ABS with Chromed Brass Cover-all Strainer	5840B2	20
	85815	PVC with Stainless Steel Cover-all Strainer	4840S2	20
	82150	PVC with SS Cover-all Strainer – Display Pack	R4842S	6
	85816	PVC with Stainless Steel Strainer	4840PS2	20
	85825	PVC with Chromed Brass Cover-all Strainer	4840B2	20
	3" X 4" (Fits 3" or 4" DWV Pipe)			
	85840	ABS with Stainless Steel Strainer	5840S3	20
	85835	PVC with Stainless Steel Strainer	4840S3	20
	4" (Fits over 4" DWV Pipe)			
	85855	PVC with Chromed Brass Strainer	4840B4	20



Weld-On®
Guy Gray®
Waater-Tite®
ToughPans®
RTB
Test-Tite®
AB&A®
Studor®
Truebro®
Christy's®
FloodStop®
ProVent®
ProSet®

General Purpose Area Drain

PRODUCT	DESCRIPTION	MODEL	UNITS/CASE
82338	2" x 3" PVC	4880	10
82339	2" x 3" ABS	5880	10



82338

Press-In Stainless Steel Drain Covers

- Fits inside DWV plastic and cast-iron pipe – both service weight and extra heavy.
- Clips slide easily in place, holding it in position.
- Cover sits flush against the top of the pipe.
- Cover extends past the edge of the pipe for secure coverage.
- Simple press-in installation
- Prevents large debris from entering pipe while letting water flow through.
- Made of durable stainless steel.

PRODUCT	DESCRIPTION	MODEL	UNITS/CASE
67033	3" for 1-1/2" Pipe	ABA2462	25
67034	3" for 2" Pipe	ABA2463	25
67035	4" for 3" Pipe	ABA2464	25
67036	5" for 4" Pipe	ABA2465	25



67034

Bell Trap Drain

PRODUCT	DESCRIPTION	MODEL	UNITS/CASE
82320	6" x 6" with Outlet for 1-1/2" or 2" PVC Pipe*	BTP612	20
82325	9" x 9" with Outlet for 3" or 4" PVC Pipe	BTP934	10
82330	9" x 9" with Outlet for 4" PVC Pipe (Hub Fit)	BTP940	10

*Use 2" Coupling to Convert to 2" Outlet



82320

Heavy-Duty Traffic Floor Drain

- PVC with Grate
- Optimum durability for high traffic areas
- Complete with full grate and debris bucket
- Fits 3" or 4" Sch. 40 DWV

LISTINGS	PRODUCT	DESCRIPTION	MODEL	UNITS/CASE
	65810	3" PVC with PVC Grate	ABA8510	1



65810

Commercial Roof Drains



86095



86096

- Plastic drain assemblies with cast iron or plastic domes
- Drain kits include 86125 underdeck clamping collar
- Underdeck clamping collar available.

PRODUCT	DESCRIPTION	MODEL	UNITS/CASE
86120	With Plastic Dome for 3" ABS Pipe	5865	1
86122	With Plastic Dome for 4" ABS Pipe	5866	1
86100	With Cast Iron Dome for 3" ABS Pipe	5863	1
86110	With Cast Iron Dome for 4" ABS Pipe	5864	1
86115	With Plastic Dome for 3" PVC Pipe	4865	1
86121	With Plastic Dome for 4" PVC Pipe	4866	1
86095	With Cast Iron Dome for 3" PVC Pipe	4863	1
86105	With Cast Iron Dome for 4" PVC Pipe	4864	1
86125	Underdeck Clamping Collar for Above Roof Drains	5555	1
86097	Drain Kit, Plastic Dome for 3" PVC Pipe	4863PK	1
86107	Drain Kit, Plastic Dome for 4" PVC Pipe	4864PK	1
86096	Drain Kit, Cast Iron Dome for 3" PVC Pipe	4863K	1
86106	Drain Kit, Cast Iron Dome for 4" PVC Pipe	4864K	1

Integral Trap Floor Drain



82331

- One piece ABS or PVC drain body
- Conforms to ASTM D2661 (ABS) / ASTM D2665 (PVC)
- Factory installed 1-1/2" cleanout plug
- 3-3/4" deep sump bowl
- 3" trap seal
- Available with or without backwater device

PRODUCT	DESCRIPTION	MODEL	UNITS/CASE
82332	2" ABS Floor Drain with Integral Trap	5878	10
82334	2" ABS Floor Drain with Trap/ Backwater Device	5879	10
82331	2" PVC Floor Drain with Integral Trap	4878	10
82336	2" PVC Floor Drain with Integral Trap – Bulk Pack	4878B	90
82333	2" PVC Floor Drain with Trap/ Backwater Device	4879	10
82335	Backwater Device for 2" FIP Threads	BD2	10

Pop Valve™ Sewer Relief Valve



86010

- Automatic relief valve for sewer cleanout riser. Relieves blocked sewage outside house, preventing potentially costly property damage inside.
- For standard 3" or 4" cleanout connections
- Individually boxed

PRODUCT	DESCRIPTION	MODEL	UNITS/CASE
86010	Pop Valve™ Relief Valve	RSP1	12

Weld-On®
Guy Gray®
Waater-Tite®
ToughPans®
RTB
Test-Tite®
AB&A®
Studor®
Truebro®
Christy's®
FloodStop®
ProVent®
ProSet®

Plastic Saddle Tee Kits

- Includes saddle tee, V-bolts, nuts and washer
- Individually bagged
- Used for tapping into a 3" or 4" DWV line

PRODUCT	DESCRIPTION	MODEL	UNITS/CASE
82650	2" Inlet for 3" Sch. 40 DWV PVC Pipe	4870K	20
82655	2" Inlet for 4" Sch. 40 DWV PVC Pipe	4871K	20
82660	3" Inlet for 4" Sch. 40 DWV PVC Pipe	R4873K	10
82652	4" Inlet for 4" Sch. 40 DWV PVC Pipe	4872K	10
86310	Sponge Saddle Gasket for Saddle Tees	SADGAS	20



82650

Floor Sinks – PVC – 12" x 12" Flange Dimension

- 3/4" top grate available in three styles: full, three-quarter and half
- Aluminum dome strainers or flat strainers available

LISTINGS	PRODUCT	DESCRIPTION	MODEL	UNITS/CASE
Single Size Floor Sinks				
	60527	2" Sink Base Only	ABA8575	3
	60533	2" Sink with Full Grate and Dome Strainer	ABA8576	1
	60954	2" Sink with Full Grate and Flat Bottom Strainer	ABA8592	1
	65801	3" Sink Base Only	ABA8579	3
	60525	3" Sink with Full Grate and Dome Strainer	ABA8580	1
	60949	3" Sink with Full Grate and Flat Bottom Strainer	ABA8591	1
	60528	4" Sink Base Only	ABA8583	3
	60535	4" Sink with Full Grate and Dome Strainer	ABA8584	1
	60955	4" Sink with Full Grate and Flat Bottom Strainer	ABA8593	1
Multi-Size Floor Sinks				
	60540	2" x 3" Sink Base Only	ABA8560	1
	60541	2" x 3" Sink with Full Grate and Dome Stainer	ABA8561	1
	60542	2" x 3" Sink with Full Grate and Flat Bottom Stainer	ABA8562	1
	60543	3" x 4" Sink Base Only	ABA8563	1
	60544	3" x 4" Sink with Full Grate and Dome Stainer	ABA8564	1
	60545	3" x 4" Sink with Full Grate and Flat Bottom Stainer	ABA8565	1
Floor Sink Accessories				
	69223	Full Grate Only	ABA8810	12
	69224	Three-quarter Grate Only	ABA8811	12
	65802	Half Grate Only	ABA8812	12
	69245	2" Aluminum Dome Strainer	ABA8587	1
	69246	3" Aluminum Dome Strainer	ABA8588	1
	69705	4" Aluminum Dome Strainer	ABA8589	1



65801



69223



69246

AB&A Legacy Backwater Valves

- Designed to protect low areas or basements from the backflow of waste from the street sewers
- Available in 3", 4", and 6" Hub
- Fits 3", 4", and 6" DWV Schedule 40 Pipe
- Cap with O-Ring screws directly in to Backwater valve
- Available with 16" Riser and Snap-on cover
- Certified to ASME A112.14.1



66200



66200



66213

LISTINGS	PRODUCT	DESCRIPTION	MODEL	UNITS/CASE
	Valve Only			
	66200	3" PVC BWV	ABABWV3P	4
	66201	3" ABS BWV	ABABWV3A	4
	66202	4" PVC BWV	ABABWV4P	2
	66203	4" ABS BWV	ABABWV4A	2
	66204	6" PVC BWV	ABABWV6P	1
	66205	6" ABS BWV	ABABWV6A	1
	BWV with Riser Kit (Valve, Adapter, Riser, and Lid)			
	66206	3" PVC BWV With Riser Kit	ABABWV3PAS	1
	66207	3" ABS BWV With Riser Kit	ABABWV3AS	1
	66208	4" PVC BWV With Riser Kit	ABABWV4PAS	1
	66209	4" ABS BWV With Riser Kit	ABABWV4AS	1
	BWV Adapter Kit (Only Adapter and Lid)			
	66210	3" PVC BWV Adapter Kit	ABABWV3ADAPT	1
	66211	4" PVC BWV Adapter Kit	ABABWV4ADAPT	1
	66212	6" PVC BWV Adapter Kit	ABABWV6ADAPT	1
	BWV Rebuild Kit (Flapper, Cap, and O-Rings)			
	66213	3" PVC BWV Rebuild Kit	ABABWV3PRBK	1
	66214	3" ABS BWV Rebuild Kit	ABABWV3ARBK	1
	66215	4" PVC BWV Rebuild Kit	ABABWV4PRBK	1
	66216	4" ABS BWV Rebuild Kit	ABABWV4ARBK	1
	66217	6" PVC BWV Rebuild Kit	ABABWV6PRBK	1
	66218	6" ABS BWV Rebuild Kit	ABABWV6ARBK	1
	BWV O-Ring Kit (Flapper And Cap O-Rings Only)			
	66219	3" BWV O-Ring Kit	ABABWV3ORINGS	1
	66220	4" BWV O-Ring Kit	ABABWV4ORINGS	1
	66221	6" BWV O-Ring Kit	ABABWV6ORINGS	1



Weld-On®
Guy Gray®
Waater-Tite®
ToughPans®
RTB
Test-Tite®
AB&A®
Studor®
Truebro®
Christy's®
FloodStop®
ProVent®
ProSet®

Mainline® Top Check Backwater Valves

LISTINGS	PRODUCT	DESCRIPTION	MODEL	UNITS/CASE
	66023	4" ABS Mainline Top Check Backwater Valve	ABAML4TCA	1
	66024	4" PVC Mainline Top Check Backwater Valve	ABAML4TCP	1



66023

Mainline® Fullport Backwater Valves

LISTINGS	PRODUCT	DESCRIPTION	MODEL	UNITS/CASE
	4" Fullport Backwater Valve			
	66000	4" ABS Mainline Fullport Backwater Valve	ABAML4963A	1
	66001	4" PVC Mainline Fullport Backwater Valve	ABAML4963P	1
	4" Fullport Backwater Valve - Parts			
	66100	4" Mainline Gate	ABAPA4963G	1
	66101	Clear Lid & Cleanout	ABAPA4963LCO	1
	66102	Refurbish Kit Bolts / Gasket / O-ring	ABAPA4963RK	1



66000



66001

Mainline® Automatic Backwater Valves

PRODUCT	DESCRIPTION	MODEL	UNITS/CASE
4" ML-FR4 Backwater Valve			
66002	4" Mainline Automatic Backwater Valve	ABAMLFR4	2
4" ML-FR4 Backwater Valve - Parts			
66103	ML-FR4 Full Kit	ABAPA4FRFULL	1
66104	ML-FR4 External Kit	ABAPA4FREXT	1
66105	ML-FR4 Internal Kit	ABAPA4FRINT	1



66002

Access Box

PRODUCT	DESCRIPTION	MODEL	UNITS/CASE
66003	20 x 13 Plastic Access Box	ABAPE2013	1
66106	Access Box Lid	ABAPE2013LID	1



66003

Mainline® Extendable Adapt-A-Valve



66005



66006

LISTINGS	PRODUCT	DESCRIPTION	MODEL	UNITS/CASE
Extendable 3" Adapt-A-Valve				
66004	3" ABS Backwater Valve Body + (Normally Closed) Cassette		ABAML3XAC	1
66005	3" PVC Backwater Valve Body + (Normally Closed) Cassette		ABAML3XPC	1
66006	3" ABS Backwater Valve Body + (Normally Open) Cassette		ABAML3XA0	1
66007	3" PVC Backwater Valve Body + (Normally Open) Cassette		ABAML3XP0	1
Extendable 3" Adapt-A-Valve - Parts				
66107	Backwater Valve Cassette (Normally Closed)		ABAPA3CASS1NC	24
66108	Backwater Valve Cassette (Normally Open)		ABAPA3CASS1NO	24
66109	Test-Eze™ Gate / Pressure testing		ABAML3TZ	24
66110	ABS Body Housing Only		ABAML3BDY1A	24
66111	PVC Body Housing Only		ABAML3BDY1P	24
Extendable 4" Adapt-A-Valve				
66008	4" ABS Backwater Valve Body + (Normally Closed) Cassette		ABAML4XAC	1
66009	4" PVC Backwater Valve Body + (Normally Closed) Cassette		ABAML4XPC	1
66010	4" ABS Backwater Valve Body + (Normally Open) Cassette		ABAML4XA0	1
66011	4" PVC Backwater Valve Body + (Normally Open) Cassette		ABAML4XP0	1
Extendable 4" Adapt-A-Valve - Parts				
66112	Backwater Valve Cassette (Normally Closed)		ABAPA4CASS1NC	8
66113	Backwater Valve Cassette (Normally Open)		ABAPA4CASS1NO	8
66114	Test-Eze™ Gate/pressure testing		ABAML4TZ	24
66115	Test-Eze™ Gate/pressure testing (bagged with key)		ABAML4TZB	24
66116	ABS Body Housing Only		ABAML4BDY1A	8
66117	PVC Body Housing Only		ABAML4BDY1P	8



Weld-On®
Guy Gray®
Waater-Tite®
ToughPans®
RTB
Test-Tite®
AB&A®
Studor®
Truebro®
Christy's®
FloodStop®
ProVent®
ProSet®

Mainline® Fullport Backwater Valves

PRODUCT	DESCRIPTION	MODEL	UNITS/CASE
66118	4x4x8 IC Body Housing Only	ABAML448IC	1
66119	Lid ONLY - red	ABA8ICLIDR	1
66120	Lid ONLY - green	ABA8ICLIDG	1
66121	Lid ONLY - blue	ABA8ICLIDB	1
66122	IC Collar PVC	ABA8AAVCOL	1
66123	Combo Lid / Collar - red	ABA8ICLIDCOLR	6
66124	Combo Lid / Collar - green	ABA8ICLIDCOLG	6
66125	Combo Lid / Collar - blue	ABA8ICLIDCOLB	6
66126	4" PVC Sewer Adapter	ABA44SWRADP	45
66127	6" PVC Sewer Adapter	ABA66SWRADP	32
66128	8" PVC Sewer Adapter	ABA88SWRADP	12



66118

TERMEX Valve

PRODUCT	DESCRIPTION	MODEL	UNITS/CASE
66129	TERMEX Valve Normally Closed	ABATERMEXC	1
66130	TERMEX Valve Normally Open	ABATERMEXO	1
66131	3" ABS Extendable TERMEX Valve Normally Closed	ABATERMEX3SFA	1
66132	3" PVC Extendable TERMEX Valve Normally Open	ABATERMEX3SFP	1
66133	4" ABS Extendable TERMEX Valve Normally Closed	ABATERMEX4SFA	1
66134	4" PVC Extendable TERMEX Valve Normally Open	ABATERMEX4SFP	1
66135	6" ABS Extendable TERMEX Valve Normally Closed	ABATERMEX6SFA	1
66136	6" PVC Extendable TERMEX Valve Normally Open	ABATERMEX6SFP	1

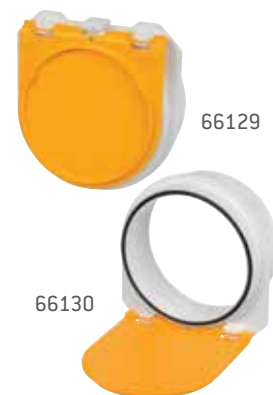

66129

66130

Test-Eze™ Pressure Testing Devices

PRODUCT	DESCRIPTION	MODEL	UNITS/CASE
66137	ABS Pressure Testing Device - Housing	ABAML3TTA	24
66138	PVC Pressure testing Device - Housing	ABAML3TTP	24
66139	Test Gate	ABAML3TTG	24
66140	Spacer Gate	ABAML3BLG	24
66141	3" Pipe Plug	ABAML3TEPP	1
66142	4" Pipe Plug	ABAML4TEPP	1
66143	3" Pipe Plug w/ float and string	ABAML3TEPPA	1
66144	4" Pipe Plug w/ float and String	ABAML4TEPPA	1



66138

Extendable Straight Fit Valves



66013



66016

LISTINGS	PRODUCT	DESCRIPTION	MODEL	UNITS/CASE
Extendable Straight Fit Valves				
66012	3x3x4 ABS Straight Fit Valve		ABAMLSF334A	1
66013	3x3x4 PVC Straight Fit Valve		ABAMLSF334P	1
66014	4x4x6 ABS Straight Fit Valve		ABAMLSF446A	1
66015	4x4x6 PVC Straight Fit Valve		ABAMLSF446P	1
66016	6x6x8 ABS Straight Fit Valve		ABAMLSF668A	1
66017	6x6x8 PVC Straight Fit Valve		ABAMLSF668P	1
Extendable Straight Fit Valves - Parts				
66145	3" Straight Fit Gate Closed		ABAPA3SFGATE	1
66146	3" SMART CURVE Snake Guide		ABAPA3SFSG	1
66147	3" Gate for Pressure testing		ABAMLSF3TG	1
66148	4" Straight Fit Gate Closed		ABAPA4SFGATE	1
66149	4" SMART CURVE Snake Guide		ABAPA4SFSG	1
66150	4" Gate for Pressure testing		ABAMLSF4TG	1
66151	6" Straight Fit Gate Closed		ABAPA6SFGATE	1
66152	6" SMART CURVE Snake Guide		ABAPA6SFSG	1
66153	6" Gate for Pressure testing		ABAMLSF6TG	1

Flush Cap Clean Outs



66022

LISTINGS	PRODUCT	DESCRIPTION	MODEL	UNITS/CASE
66018	4" ABS Flush Cap Cleanout		ABAML4FCADWW	20
66019	4" PVC Flush Cap Cleanout		ABAML4FCPDWW	20
66020	6" ABS Flush Cap Cleanout		ABAML6FCADWW	14
66021	6" PVC Flush Cap Cleanout		ABAML6FCPDWW	14
66022	6" SDR Flush Cap Cleanout		ABAML6FCPSDR	14

Weld-On®
Guy Gray®
Waater-Tite®
ToughPans®
RTB
Test-Tite®
AB&A®
Studor®
Truebro®
Christy's®
FloodStop®
ProVent®
ProSet®

White Plastic Snap-In

- Plastic snap-in access door
- ABS molded high impact, non-corrosive plastic

- Surface or flush mounting
- Reversible frame

PRODUCT	DESCRIPTION	MODEL	UNITS/CASE
67906	6" x 9"	ABA6715	12
85150	8" x 8"	RAP8X8	10
85152	12" x 12"	ABA6712	12
85155	14" x 14"	RAP1414	10
67908	14" x 29"	ABA6718	6



85155

16Ga Mild Steel - White Prime Coated

- Full length hinge
- Rounded corners to minimize bent corners

- Interchangeable locks

PRODUCT	DESCRIPTION	MODEL	UNITS/CASE
67909	6" x 6" w/ Screwdriver Lock	ABA6724	1
67900	8" x 8" w/ Screwdriver Lock	ABA6725	1
67901	10" x 10" w/ Screwdriver Lock	ABA6727	1
67902	12" x 12" w/ Screwdriver Lock	ABA6729	1
67903	14" x 14" w/ Screwdriver Lock	ABA6731	1
67913	14" x 14" Mesh w/ Screwdriver Lock	ABA6731M	1
67904	16" x 16" w/ Screwdriver Lock	ABA6733	1
67929	18" x 18" w/ Screwdriver Lock	ABA6748	1
67930	24" x 24" w/ Screwdriver Lock	ABA6749	1
69930*	24" x 24" w/Screwdriver Lock	ABA9924	1

*Vertical or horizontal installation



67901

16Ga #304 Stainless Steel

- Full length hinge
- Rounded corners to minimize bent corners

- Interchangeable locks

PRODUCT	DESCRIPTION	MODEL	UNITS/CASE
67915	6" x 6" w/ Screwdriver Lock	ABA6734	1
67905	8" x 8" w/ Screwdriver Lock	ABA6735	1
67920	10" x 10" w/ Screwdriver Lock	ABA6737	1
67922	12" x 12" w/ Screwdriver Lock	ABA6739	1
67925	14" x 14" w/ Screwdriver Lock	ABA6741	1
67926	16" x 16" w/ Screwdriver Lock	ABA6743	1
67927	18" x 18" w/ Screwdriver Lock	ABA6744	1
67928	24" x 24" w/ Screwdriver Lock	ABA6745	1



67922

Replacement Locks

- Full length hinge
- Rounded corners to minimize bent corners

- Interchangeable locks

PRODUCT	DESCRIPTION	MODEL	UNITS/CASE
69771	5-Pack of Assorted Keys	ABA6773	1
67991	Cylinder Lock only (same key)	ABA6776	1



ProSet®

ProVent®

FloodStop®

Christy's®

Truebro®

Studor®

AB&A®

Test-Tite®

RTB

ToughPans®

Waater-Tite®

Guy Gray®

Weld-On®

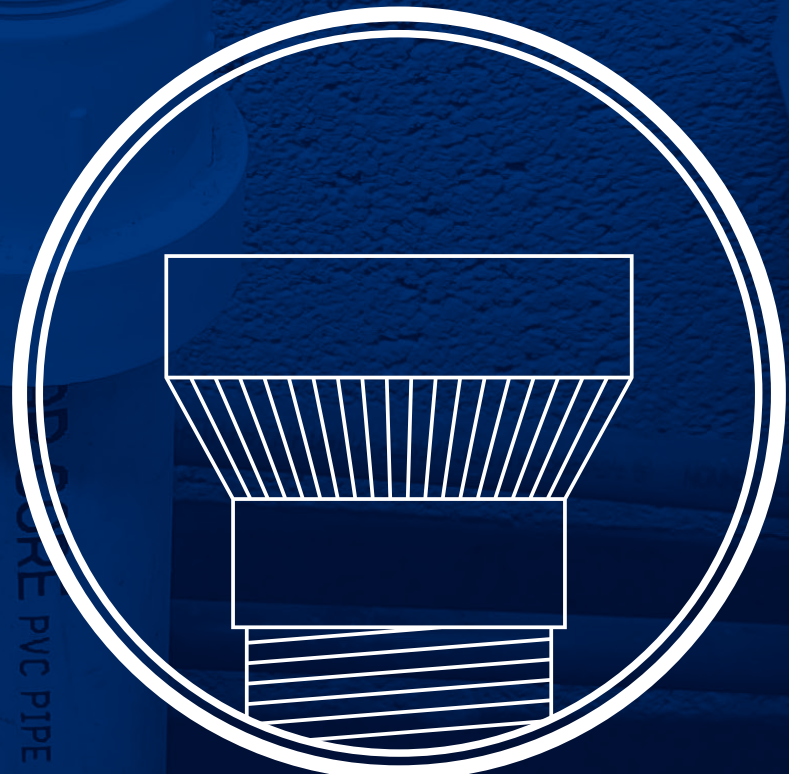

STUDOR®

STUDOR® PVC PIPE DWV IPS SCH 40 SERIES NSF/dwv 95T

BRAND OVERVIEW

There's a reason everyone calls AAVs "Studor" vents

When Studor® developed the first Air Admittance Valves in the 1970's, it was developing AAV technology that would become the standard. The technology provides Drainage Waste and Vent systems the option to reduce the number of vents through the roof and allows for only one open vent to the atmosphere per building system.

Still the only specialized AAV manufacturer in the world

Studor AAVs were introduced to the U.S. in 1986, and Studor engineers have been refining the technology ever since. Today, the Studor line of specialized AAVs is bigger than ever, offering the most complete AAV line on the market – with millions of valves installed in North America and worldwide.







Maxi-Vent®



20342

The unique design of the Studor Maxi-Vent provides plumbing ventilation to prevent the loss of water seals in traps without the need for costly roof penetration and vent piping.

- Can be used as an individual, branch, circuit or stack vent
- Will vent up to 500 DFUs on a 4" stack
- Fits 3" DWV pipe with no-hub type coupling (not provided)
- Fits inside 4" DWV pipe with rubber gasket provided
- Reduces the number of fire-stopping applications
- ASSE 1051, ASSE 1050, ANSI/NSF 14, ETL, ICC-ES PMG-1025, C-IAPMO
- Exclusive vermin protection system
- Limited lifetime warranty for replacement of defective valves
- Residential or commercial use
- Expands architectural design limits
- When Maxi-Vent will be exposed to extreme temperatures, leave top half of polystyrene packaging on the Maxi-Vent for thermal protection.

LISTINGS	PRODUCT	DESCRIPTION	MODEL	UNITS/CASE
  	20342	Maxi-Vent AAV with 4" Push-fit Rubber Conx. – 6-pk	20342	6
 	20302	Maxi-Vent AAV with 4" Push-fit Rubber Conx. – 24-pk	20302	24

Maxi-Cap™



20398

The Studor Maxi-Cap provides protection from harmful UV rays when the Maxi-Vent is installed outdoors.





- Prior to installing a Maxi-Vent, Maxi-Cap can be painted to match roof color for aesthetics.
- Studor recommends the use of the Maxi-Cap when installing the Maxi-Vent outdoors
- Do not paint Maxi-Vent
- Maxi-Cap fits over polystyrene piece that comes with the Maxi-Vent as part of the packaging

PRODUCT	DESCRIPTION	MODEL	UNITS/CASE
20398	Maxi-Cap Aluminum Cover for Maxi-Vent	20398	1

Mini-Vent®

The unique design of the Studor Mini-Vent provides plumbing ventilation to prevent the loss of water seals in traps without the need for costly roof penetration and vent piping.

- Can be used as an individual, branch, circuit or stack vent
- PVC or ABS adapter provided; fits 1-1/2" and 2" pipe sizes
- Will vent up to 160 DFUs on a 4" branch
- Will vent up to 24 DFUs on 2" stack
- Expands architectural design limits
- Reduces the number of fire-stopping applications
- Exclusive vermin protection system
- Limited lifetime warranty for replacement of defective valves
- Residential or commercial use
- ASSE 1051, ASSE 1050, ANSI/NSF 14, ETL, ICC-ES PMG-1025, C-IAPMO

LISTINGS	PRODUCT	DESCRIPTION	MODEL	UNITS/CASE
    	20341	Mini-Vent AAV with 1-1/2" or 2" PVC Adapter – 6-pk	20341	6
	20340	Mini-Vent AAV with 1-1/2" or 2" ABS Adapter – 6-pk	20340	6
	20301	Mini-Vent AAV with 1-1/2" or 2" PVC Adapter – 24-pk	20301	24
	20300	Mini-Vent AAV with 1-1/2" or 2" ABS Adapter – 24-pk	20300	24



20341

Weld-On®
Guy Gray®
Water-Tite®
ToughPans®
RTB
Test-Tite®
AB&A®
Studor®
Truebro®
Christy's®
FloodStop®
ProVent®
ProSet®

Redi-Vent®



20346

Simplify drainage and waste venting with the Studor Redi-Vent Air Admittance Valve. The unique design of the Studor Redi-Vent provides ventilation to prevent the loss of water seals in traps without the need for expensive roof penetration and vent piping.

- For venting single fixtures, kitchen sinks and bathroom groups including back to back applications up to 20 DFUs on a 2" branch
- Exclusive vermin protection system
- Expands architectural design limits
- Compact design for tight applications
- Fits 1-1/2" and 2" pipe sizes
- Limited lifetime warranty for replacement of defective valves
- Residential or commercial use
- ASSE 1051, ASSE 1050, ANSI/NSF 14, ETL, ICC-ES PMG-1025, C-IAPMO

LISTINGS	PRODUCT	DESCRIPTION	MODEL	UNITS/CASE
Standard Pack				
	20346	Redi-Vent AAV with 1-1/2" or 2" PVC Adapter – 24-pk	20346	24
	20349	Redi-Vent AAV with 1-1/2" or 2" ABS Adapter – 24-pk	20349	24
Bulk Pack				
	20299	Redi-Vent AAV with 1-1/2" or 2" PVC Adapter – 60-pk	20299	60
	20298	Redi-Vent AAV with 1-1/2" or 2" ABS Adapter – 60-pk	20298	60
Redi-Vent Adapter*				
	44833	Redi-Vent PVC 2" Inside Pipe Adapter [old style]	44833	25

* Redi-Vent Adapter is specially designed for use in DU-All washer box

AAV-TEE



20391



- Tubular tee installs in-line with 1-1/2 or 1 1/4 tubular trap
- Includes Redi-Vent air admittance valve capable of venting up to 20 DFUs on a 2" branch
- Tee branch mounts Redi-Vent the required 4" above the horizontal drain line

LISTINGS	PRODUCT	DESCRIPTION	MODEL	UNITS/CASE
	20391	AAV Tubular Tee with Redi-Vent	20391	6
	40800	AAV Tubular Tee Only	40800	24

Recessed Air Admittance Valve Boxes

The unique design of the Studor Mini-Vent® provides plumbing ventilation to prevent the loss of water seals in traps without the need for costly roof penetration and vent piping.

- Can be used with any Mini-Vent, Tec-Vent® or Redi-Vent®
- Fire-rated box does not come with an AAV
- Can also be used as the termination point for an open pipe side wall vent as an alternative to venting through the roof

LISTINGS	PRODUCT	DESCRIPTION	MODEL	UNITS/CASE
	20380	Studor AAV Recess Box w/ Faceplate	20380	10
	20381	Studor AAV Recess Box with Redi-Vent®	20381	10
	20385	Louvered Faceplate Only	20385	20
	Fire-rated			
	82456*	Fire-rated Air Admittance Valve Outlet Box, with 1-1/2" female adaptor (AAV not included)	FRAAV12	5
	48254	9-1/2" x 9-1/2" Replacement Grill	48254	1

* Category 5 product.



20380



82456

Studor Air Admittance Valve Box Kit

- Integrated mounting flanges - no clips to lose or hassle with
- Top and bottom stabilizer bar slots
- Optional nail slots
- MultiBox faceplates fit any MultiBox configuration, including fire-rated
- All faceplates fit up to two sheets of 5/8" drywall
- Only receives the Redi-Vent
- Box is IAPMO Listed; see "Redi-Vent®" on page 248 for Redi-Vent listings and certifications

LISTINGS	PRODUCT	DESCRIPTION	MODEL	UNITS/CASE
	82939	Studor Aux. Drain Box, Redi-Vent, Louvered Frame	MBS1200AAV	10
	82947	Replacement Louvered Faceplate	MBF1222	1



82939

FR Studor® Air Admittance Valve Box Kit

- Intumescent pad attached to back of outlet box
- 1hr & 2hr rated
- ETL Listed
- Integrated mounting flanges - no clips to lose or hassle with
- Top and bottom stabilizer bar slots
- Optional nail slots
- MultiBox faceplates fit any MultiBox configuration, including fire-rated
- Anti-rotational valve design
- All faceplates fit up to two sheets of 5/8" drywall
- Standard faceplate includes cable tie bosses to secure drain hose
- Box is IAPMO Listed; see "Redi-Vent®" on page 248 for Redi-Vent listings and certifications

LISTINGS	PRODUCT	DESCRIPTION	MODEL	UNITS/CASE
	83085	FR Studor Aux. Drain Box, Redi-Vent, Louvered Frame	MBFRS1200AAV	10
	82947	Replacement Faceplate Louvered ¹	MBF1222	1



83085





Tec-Vent®



20344

Simplify drainage and waste venting with the air admittance valve designed specifically for commercial applications. The unique design of the Studor Tec-Vent provides plumbing ventilation to prevent the loss of water seals in traps without the need for costly roof penetration and vent piping.

- Classified in accordance with UL2043 for installation in plenums when the system is designed by a design professional and approved by local inspector
- Manufactured from flame-retardant polycarbonate resin
- High tensile strength
- Will vent up to 160 DFUs on a 4" branch
- Exclusive vermin protection system
- Expands architectural design limits
- Reduces the number of fire-stopping applications
- UV rated for outside installations
- Limited lifetime warranty for replacement of defective valves
- Residential or Commercial Use
- ASSE 1051, ASSE 1050, ANSI/NSF 14, UL 2043, C-IAPMO, ICC-ES-PMG-1025

LISTINGS	PRODUCT	DESCRIPTION	MODEL	UNITS/CASE
    	20344	Tec-Vent (No Adapter)	20344	24

P.A.P.A.®



20357

The Studor P.A.P.A. is the perfect compliment to the existing range of Studor Air Admittance Valves (AAVs). Together they form the Studor Single Pipe System (SSPS), a Total Solution to a building's venting requirements. Studor Air Admittance Valves will protect the water seal of the system's branch fixtures while the P.A.P.A. effectively deals with positive pressure.

The Advantages:

- Provides complete protection against positive pressures in the system
- Replaces extensive vent piping saving material and installation costs
- Provides greater freedom of design for engineers, architects and design professionals
- Reduces the need for fire stopping devices preventing the chimney effect in the pipes, reducing the risk of fire spreading upwards between floors
- Eliminates leak prone roof penetrations –only one roof penetration is required no matter how tall the building
- Can be retrofitted into an existing drainage system to solve positive pressure problems
- Prevents propagation of odorous sewer gases
- Requires no maintenance, as all Studor® products are non-mechanical devices
- Is guaranteed for a lifetime equivalent to that of the drainage system in which it is installed
- Listed to ASSE 1030
- Commercial use only

PRODUCT	DESCRIPTION	MODEL	UNITS/CASE
20357	P.A.P.A. (Positive Air Pressure Attenuator)	20357	1

Chem-Vent®

Simplify drainage and waste venting with the air admittance valve designed specifically for chemical waste systems. The unique design of the Studor Chem-Vent provides plumbing ventilation to prevent the loss of water seals in traps within chemical waste systems

- Can be installed in chemical waste systems when the system is designed by a design professional
- **WARNING!** Studor Chem-Vent cannot be installed in applications where vented fumes are required to pass through biological and/or chemical filters before being released to the atmosphere
- Will vent up to 6 DFUs on a 2" branch
- Exclusive vermin protection system
- Expands architectural design limits
- ASSE 1049, ANSI/NSF 14
- Manufactured from Flame Retardant Polypropylene conforming to ASTM D-4101
- The Sch 40 dimensions of the valve tail piece allows direct mounting on any fusion or MJ fitting
- Through the use of readily available adapters, the valve can also be connected to CPVC, glass and Duriron® systems (designer to check for chemical comparability)
- Limited lifetime warranty for replacement of defective valves
- Commercial use



20345

LISTINGS	PRODUCT	DESCRIPTION	MODEL	UNITS/CASE
 	20345	Chem-Vent with Intregal FR-PP Sch. 40 Tailpiece	20345	12

Maxi-Filtra®

The Studor Maxi-Filtra operates as a two-way vent, which filters air in both directions. Its replaceable active carbon filter is designed to eliminate bad odors produced by the plumbing drainage system. The Maxi-Filtra is for outdoor use only, particularly for use with septic systems, but can also be installed on existing open vent pipes and in systems in which air admittance valves (AAVs) are installed.

- Can be installed vertically or horizontally
- Contains replaceable carbon filter that can last up to two years
- Outdoor use only
- Fits 3" DWV pipe with no-hub type coupling (not provided)
- Fits inside 4" DWV pipe with rubber gasket (provided)
- UV Rated



20297

PRODUCT	DESCRIPTION	MODEL	UNITS/CASE
20297	Maxi-Filtra Two-Way Vent with Active Carbon Filter and 4" Gasket	20297	25
20700	Maxi-Filtra Replacement Cartridge – Active Carbon Filter	20700	20



20700

ProSet®

ProVent®

FloodStop®

Christy's®

Truebro®

Studor®

AB&A®

Test-Tite®

RTB

ToughPans®

Waater-Tite®

Guy Gray®

Weld-On®



TRUEBRO®

BRAND OVERVIEW

Dedicated to "Making America Accessible"

The Truebro® product line consists of protective undersink pipe covers and plumbing enclosures for ADA compliance in handicap-accessible lavatories and sinks – for both new construction and retrofit markets.

Solutions for ADA-mandated undersink accessibility

The Lav Guard 2®, Lav Shield®, Basin Guard™, and Soft-Guard Plus™ are professional ADA-mandated protection systems designed for durability, aesthetics and sanitary installations. Specifying, stocking or installing Truebro® is your assurance of protecting people with disabilities while providing quality, durability and improved aesthetics.



Lav Guard 2®



82193

Lav Guard 2® E-Z series provides the durable, attractive, ADA-compliant undersink protection that the original Truebro® Lav Guard® is famous for. Built-in E-Z Grip fasteners and internal E-Z Tear-To-Fit trimming features eliminate the need for tools, and provide for a clean, tamper-resistant, super-fast professional installation.

- E-Z Tear-To-Fit feature makes trimming super-fast and contractor-friendly—no tools required
- E-Z Grip built-in fasteners are quick, strong, and reusable
- Universal design fits more P-traps and thumb wings on plastic compression nuts

LISTINGS	PRODUCT	DESCRIPTION	MODEL	UNITS/CASE
100 Series - Fits all 1-1/4" or 1-1/2" Cast Brass or Tubular P-traps				
	82188	One Angle Valve and Supply Cover	99EZ	15
	82190	One P-Trap Cover	100EZ	15
	82192	One P-Trap Cover, One angle Valve & Supply Cover	101EZ	15
	82193	One P-Trap Cover, Two angle Valve & Supply Cover	102EZ	15
	82194	One P-Trap Cover, Two angle Valve & One offset cover	103EZ	15
	82189	One 14" Extension for Water Supply	EX99EZ	15
	82191	One 14" Extension for Drain Waste Arm or Tailpiece	EX100EZ	15
	82195	One 5" Offset Tailpiece Wheelchair Strainer Assembly	105EZ	15
	82196	Kohler 6" Offset	105K	15
	82197	One Basket Strainer Cover & Offset Waste Cover	106EZ	15
	82198	Two Basket Strainer Covers & Center or End Outlet Waste Cover	107EZ	1
400 Series - Fits all 1-1/2" Schedule 40 Plastic P-traps				
	82199	One P-Trap Cover	400	15
	82200	One P-Trap Cover, One angle Valve & Supply Cover	401	15
	82201*	One P-Trap Cover, Two angle Valve & Supply Cover	402	15



* 105-EZ can be used in conjunction with the 400 series if a tailpiece is required.



99EZ



EX99EZ



100EZ



EX100EZ



101EZ



102EZ



103EZ



105EZ



106EZ



107EZ

Weld-On®
Guy Gray®
Waater-Tite®
ToughPans®
RTB
Test-Tite®
AB&A®
Studor®
Truebro®
Christy's®
FloodStop®
ProVent®
ProSet®

Basin Guard™

Basin Guard™ is an ADA-compliant undersink piping enclosure for kitchen, classroom and lavatory sinks. Basin Guard can be installed where ever counter tops and sidewalls are present and the proper ADA sink is installed. Provides an attractive way to conceal piping and mechanical connections. Bottom opening allows for easy service access.

- ADA-conforming design protects wheelchair users from scalding and sharp, abrasive surfaces. When installed, all plumbing and mechanical components are concealed
- Strict code compliance minimizes risk. The Basin Guard complies with ADA article 4.19.4, California Plumbing Code
- 1504.2.1, ANSI A117.1, and other state and local regulations. Basin Guard also has a flammability resistance base material, tested in accordance with Underwriters Laboratories for the UL 94 standard with a V-0 rating
- 36" and 42" enclosures are easy to specify, stock and install. May be used with virtually any ADA-compliant sink or restroom lavatory where countertops and sidewalls are present
- High-impact, UV-protected vinyl maximizes product life cycle. The Basin Guard is molded from impact-resistant, stain-resistant and chemical-resistant protective vinyl for durability, safety and long life



82234

LISTINGS	PRODUCT	DESCRIPTION	MODEL	UNITS/CASE
	82234	36" Basin Guard-White	36W	12
	82236	42" Basin Guard-White	42W	14

Lav Shield®

Lav Shield® provides ADA-compliant undersink protection and meets requirements for wheelchair accessibility. Durable, single-piece construction conceals piping, electronic faucet connections, mixing valves, trap primers and instantaneous hot water heaters. (Lavatory "rough in" should be considered to allow mounting room for water heater—contact us for specifications.) Pre-cut Lav Shields are cut to fit various lavatory models, field adjustment may be needed for exact fit.

- "Total enclosure" deters tampering
- Pre-cut Lav Shields are not stocked and not available for return
- Single-piece configuration for easy service
- High-impact, UV-protected vinyl



Exposed



Enclosed



Standard Lav Shield®



LISTINGS	PRODUCT	DESCRIPTION	MODEL	UNITS/CASE
Standard Lav Shield®				
82202	Standard Lav Shield®		20181	1
97775	Standard Lav Shield® Bulk		20184	4
Pre-Cut Lav Shield®				
82203	American Standard Comrade		2018ASC1	1
97768	American Standard Comrade Bulk		2018ASC4	4
82204	American Standard Declyn		2018ASD1	1
97783	American Standard Declyn Bulk		2018ASD4	4
82205	American Standard Lucerne		2018ASL1	1
97717	American Standard Lucerne Bulk		2018ASL4	4
82206	American Standard Murro		2018ASM1	1
97790	American Standard Murro Bulk		2018ASM4	4
82207	American Standard Lucerne (Old)		2018ASOL	1
97710	American Standard Lucerne (Old) Bulk		2018ASOL4	4
97964	American Standard Penlyn Bulk		2018ASP4	4
82208	American Standard Roxalyn		2018ASR1	1
97797	American Standard Roxalyn Bulk		2018ASR4	4
97966	American Standard Regalyn		2018ASRG1	1
97967	American Standard Regalyn Bulk		2018ASRG4	4
82209	Bradley Imperial		2018BDI1	1
97804	Bradley Imperial Bulk		2018BDI4	4
97916	Briggs Milton		2018BM1	1
97912	Briggs Milton Bulk		2018BM4	4
82210	Briggs Whitman		2018BRW1	1
97811	Briggs Whitman Bulk		2018BRW4	4
82211	Crane Harwich		2018CRH1	1
97723	Crane Harwich Bulk		2018CRH4	4
82212	Crane Norwich		2018CRN1	1
97818	Lav Shield® Crane Norwich 4 Bulk		2018CRN4	4
82213	Crane Westmont		2018CRW1	1
97730	Crane Westmont Bulk		2018CRW4	4
82214	Crane Yorkshire		2018CRY1	1
97825	Crane Yorkshire Bulk		2018CRY4	4
82215	Eljer Blair		2018ELB1	1
97832	Eljer Blair Bulk		2018ELB4	4

Lav Shield® (continued)

LISTINGS	PRODUCT	DESCRIPTION	MODEL	UNITS/CASE
Pre-Cut Lav Shield® (Continued)				
	82216	Eljer Delwyn	2018ELD1	1
	97839	Eljer Delwyn Bulk	2018ELD4	4
	82217	Eljer Mayburne	2018ELM1	1
	97846	Eljer Mayburne Bulk	2018ELM4	4
	82218	Eljer Signature	2018ELS1	1
	97737	Eljer Signature Bulk	2018ELS4	4
	82219	Eljer Bucknell	2018ELU1	1
	97853	Eljer Bucknell Bulk	2018ELU4	4
	82220	Gerber Hayes	2018GRH1	1
	97860	Gerber Hayes Bulk	2018GRH4	4
	82324	Gerber Monticello Bulk	2018GRM4	4
	82221	Gerber Plymouth	2018GRP1	1
	97867	Gerber Plymouth Bulk	2018GRP4	4
	97962	Kohler Brenham	2018KOB1	1
	82222	Kohler Chesapeake	2018KOC1	1
	97874	Kohler Chesapeake Bulk	2018KOC4	4
	82223	Kohler Greenwich, Model 202	2018KOG1	1
	97744	Kohler Greenwich, Model 202 Bulk	2018KOG4	4
	97922	Kohler Greenwich, Model 203	2018KONG1	1
	97923	Kohler Greenwich, Model 203 Bulk	2018KONG4	4
	82224	Kohler Hudson	2018KOH1	1
	97881	Kohler Hudson Bulk	2018KOH4	4
	82225	Kohler Kingston	2018KOK1	1
	97751	Kohler Kingston Bulk	2018KOK4	4
	97911	Kohler Pinoir	2018KOP1	1
	97915	Kohler Pinoir Bulk	2018KOP4	4
	82226	Kohler Soho	2018KOS1	1
	97888	Kohler Soho Bulk	2018KOS4	4
	82228	Mansfield 2018 HB-NS	2018MAN1	1
	97902	Mansfield 2018 HB-NS Bulk	2018MAN4	4
	82401	Sloan SS-3003	2018SLSS3003	1
	82404	Sloan SS-3003 Bulk	2018SLSS30034	4
	82229	Toto LT307	2018TOL1	1
	97758	Toto LT307 Bulk	2018TOL4	4
	97937	New Zurn Z5340	2018ZNNZ1	1
	97938	New Zurn Z5340 Bulk	2018ZNNZ4	4
	97940	Zurn Lav Z5430	Z53401	1
	97941	Zurn Lav Z5430 Bulk	Z53404	4



Exposed



Enclosed



Standard Lav Shield®

Weld-On®
Guy Gray®
Water-Tite®
ToughPans®
RTB
Test-Tite®
AB&A®
Studor®
Truebro®
Christy's®
FloodStop®
ProVent®
ProSet®

Lav Shield® Accessories

PRODUCT	DESCRIPTION	MODEL	UNITS/CASE
82187	Lav Shield® Standard Fasteners [?]	20184F	1
82292	Tamper Resistant Fasteners [?]	TRFAST	1

Custom Finished Lav Shield®



82721

Lav Shield® represents the “next generation” of ADA compliant undersink protection by meeting mandated knee and toe clearance requirements for wheelchair users. Durable, single-piece construction prevents pipe and component tampering, and conceals all lavatory piping, electronic faucet connections, mixing valves, trap primers, and instantaneous water heaters — a truly attractive alternative to individual component covers that will satisfy even the most discriminating designer.

- “Total enclosure” deters tampering
- Custom finished Lav Shields are not stocked
- Single-piece configuration for easy service
- High-impact, UV-protected vinyl

LISTINGS	PRODUCT	DESCRIPTION	MODEL	UNITS/CASE
	82721	Dipped Lav Shield® – 1 Pk Architectural Brushed Aluminum	WTP-907	1
	82722	Dipped Lav Shield® – 1 Pk Stainless Steel	WTP-270	1
	82723	Dipped Lav Shield® – 1 Pk Stainless Steel Over Black	WTP-270B	1
	82726	Dipped Lav Shield® – 1 Pk Rosewood	WTP-488	1
	82727	Dipped Lav Shield® – 1 Pk Burlwood	WTP-496	1
	82728	Dipped Lav Shield® – 1 Pk Monaco Walnut	WTP-538	1
	82731	Dipped Lav Shield® – 1 Pk Black Marble	WTP-512	1
	82732	Dipped Lav Shield® – 1 Pk Gray Marble	WTP-659G	1
	82733	Dipped Lav Shield® – 1 Pk Architectural White Marble	WTP-659W	1
	82736	Dipped Lav Shield® – 1 Pk Italian Leather Espresso	WTP-715	1
	82741	Dipped Lav Shield® – 1 Pk Sport Carbon	WTP-940	1



Available Finishes



Architectural Brushed Aluminum Stainless Steel Stainless Steel Over Black Rosewood Burlwood Monaco Walnut



Black Marble Gray Marble Architectural White Marble Italian Leather Espresso Sport Carbon

Weld-On®
Guy Gray®
Waater-Tite®
ToughPans®
RTB
Test-Tite®
AB&A®
Studor®
Truebro®
Christy's®
FloodStop®
ProVent®
ProSet®

Soft Guard Plus™

Soft Guard Plus™ provides undersink pipe protection that should be specified for installation to all drainage piping including hot and cold water valves and supplies under lavatories to meet ADA compliance. Soft Guard Plus features a base material that has been tested in accordance with testing standard ASTM E84-07 with a 25 flame spread/450 smoke index and a 1/8" soft PVC vinyl material to maximize ADA and UPC compliance.

- 25 Flame/450 smoke index
- Anti-microbial finish
- Hook and loop fastening system
- Available in white or black
- Optional snap-to-lock fasteners provide tamper resistance
- Buy American Act Compliant
- Fits Sch. 40 P-traps and flexible braided hoses



82496

LISTINGS	PRODUCT	DESCRIPTION	MODEL	UNITS/CASE
	82521	Supply and valve cover – White	82521	10
	82522	P-Trap cover only – White	82522	10
	82523	Offset cover only – White	82523	10
	82524	P-Trap/1 valve – White	82524	10
	82525	P-Trap/2 valve covers – White	82525	10
	82527	P-Trap/2 valve covers & 1 offset cover – White	82527	10
	82528	Soft-Guard™ Plus Disposal Cover, White	82528	4



Supply and valve cover



P-Trap cover



Disposal cover



Offset cover

ProSet®

ProVent®

FloodStop®

Christy's®

Truebro®

Studor®

AB&A®

Test-Tite®

RTB

ToughPans®

Waater-Tite®

Guy Gray®

Weld-On®

CHRISTY'S®



BRAND OVERVIEW

Christy's®

In 2019, IPS Corporation® acquired T. Christy Enterprises, one of North America's premier manufacturers of solvent cements and provider of a broad range of accessories. IPS has integrated the Christy's® brand and added parts of the product line into the Water-Tite®, Weld-On®, and Test-Tite® brands.

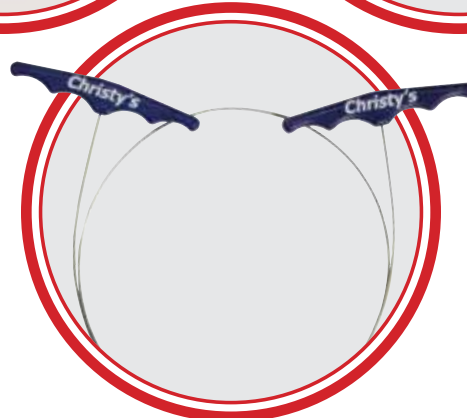

SuperSaws



513139

- Made from domestic stainless steel aircraft cable
- Heavy duty ergonomic "T" handles
- Designed for cutting PVC pipe in confined spaces
- Ideal for irrigation and plumbing applications

PRODUCT	DESCRIPTION	MODEL	UNITS/CASE
513137	SuperSaw 24" Cable Saw	SCS-24	100
513139	SuperSaw 36" Cable Saw	SCS-36	12
513141	SuperSaw 48" Cable Saw	SCS-48	100

High Tension Hacksaw



510166

- 12" - 18 TPI
- High tension durable hacksaw
- Rubber grip handle
- Bi-metal blade, cuts on both 45 or 90 degree angles

PRODUCT	DESCRIPTION	MODEL	UNITS/CASE
510166	High Tension Hacksaw	225X-2	24

PVC-ABS Hand Saw



514534

- Aluminum handle saw with rubber cushion grip
- Suitable for plywood, asbestos, plastics, hardboard, metals, wood and plastic & fiber pipe

PRODUCT	DESCRIPTION	MODEL	UNITS/CASE
514534	Saw, Hand, 12" PVC/ABS	ABAB1238BW	12
514535	Saw, Hand, 18" PVC/ABS	ABAB1240BBW	12

Replacement Blades



514623

- Industrial Quality
- Bi-Metal Construction, Spring Steel Back
- Shatter/Shock/High Heat Resistant
- Red Vinyl pack

PRODUCT	DESCRIPTION	MODEL	UNITS/CASE
VIPER HACKSAW BLADES			
514623	Viper Hacksaw Blades 12" – 18 TPI	TC1218	10/100
514626	Viper Hacksaw Blades 12" – 24 TPI	TC1224	10/100
514628	Viper Hacksaw Blades 12" – 32 TPI	TC1232	10/100
HANDSAW BLADES			
514536	Handsaw Replacement 12" Blade	HS433BD-12	6/24
514537	Handsaw Replacement 18" Blade	HS433BD-18	6/24
RECIPROCATING BLADES			
514640	Reciprocating Blade 6" - 6 TPI	TC656R	5
514635	Reciprocating Blade 6" - 14 TPI	TC614R	5
514636	Reciprocating Blade 6" - 18 TPI	TC618R	5
514638	Reciprocating Blade 6" - 24 TPI	TC624R	5
514643	Reciprocating Blade 8" - 10 TPI	TC810R	5
514630	Reciprocating Blade 12" - 6 TPI	TC156R	5
514621	Reciprocating Blade 12" - 14 TPI	TC110R	5



514536



514638

Red Razor Cutter

- Radius blade for cleaner cuts
- Industrial Quality
- Ratchet action PVC pipe cutter to 1-5/8"
- Heat treated high carbon steel blade, chrome plating
- Vinyl Hang Pouch

PRODUCT	DESCRIPTION	MODEL	UNITS/CASE
513860	PVC Pipe Cutter, Christy's®, Red Razor, Cuts up to 1-5/8"	TC-PC-158	1



513860

EZ-CUT Pipe & Hose Cutter

- Durable stainless steel blade
- Finger indentation for a firm grip

PRODUCT	DESCRIPTION	MODEL	UNITS/CASE
513569	EZ-CUT 1 1/8" Pipe & Hose Cutter	TC118SS	6
513597	EZ-CUT 2" Pipe & Hose Cutter	TC200SS	6
513581	EZ-CUT 1-1/2" Pipe & Hose Cutter	TC150SS	1



513569

Spring Loaded Pipe & Hose Cutter

- Spring Loaded Pipe and Tubing Cutter
- Spring Loaded Cutter
- Ideal for Pipe and Hose up to 1-3/8"
- Easy Grip Handle with Reversible Steel Blade
- Vinyl Hang Pouch

PRODUCT	DESCRIPTION	MODEL	UNITS/CASE
514664	Spring Loaded Pipe & Hose Cutter	TC-PCSL-138	1



514664

Replacement Blades

- Heat treated carbon steel, with chrome plating

PRODUCT	DESCRIPTION	MODEL	UNITS/CASE
513598	Replacement Blade for Red Razor Cutter 2 (TC-PC-2)	TC-2-BLADE	50
513585	Replacement blade for Red Razor Cutter 1-5/8" (TC-PC-158)	TC-158-BLADE	100
510735	Replacement Blade for EZ-CUT 1-1/2" Pipe & Hose Cutter (TC150SS)	BT150SS	200
513873	Replacement Blade for 2" Long Handle PVC Pipe	TC-PCHD-2-BD	25



513598



513585



513873

Self-Locking Tape Measure



513577

- 1" x 25' Self-Locking Tape Measure
- Revolutionary Self-Locking Tape Measure
- Hang Pack

PRODUCT	DESCRIPTION	MODEL	UNITS/CASE
513577	1" x 25' Self-Locking Tape Measure	TC-125SL	12/24

Tape Measure w/ Chrome Plated Case



513601

- 1" x 25' Tape Measure
- Chrome Plated Case
- Hang Pack

PRODUCT	DESCRIPTION	MODEL	UNITS/CASE
513601	1" x 25' Tape Measure with Chrome Plated Case	TC425	10

Duct Tape



513200

- 9 mil
- Individually Shrink Wrapped

PRODUCT	DESCRIPTION	MODEL	UNITS/CASE
513200	2" x 60 YD Silver Cloth Duct Tape	TA-33-DT398	24
513229	2" x 60 YD Red Cloth Duct Tape	TA-DT260R	24
513226	2" x 60 YD Black Cloth Duct Tape	TA-DT260BLK	24

Abrasion Cloth



81400

- Long Lasting and Waterproof
- Usable on Both Sides

PRODUCT	DESCRIPTION	MODEL	UNITS/CASE
81505	10 Yds. x 1-1/2" Open Mesh Cloth	R5503	24
81500	5 Yds. x 1-1/2" Open Mesh Cloth	R5501	24
81405	10 Yds. x 1-1/2" Sand Cloth	R5455	24
81400	2 Yds. x 1-1/2" Sand Cloth	R5451	24
81410	25 Yds. x 1-1/2" Sand Cloth	R5460	24

4-Way Faucet Key

- Valve/ Faucet/ Sillcock Sizes 1/4

PRODUCT	DESCRIPTION	MODEL	UNITS/CASE
510328	Universal 4-Way Faucet Key	4WKEY	6



510328

No Hub Torque Wrench

- 5/16" Hex Socket

PRODUCT	DESCRIPTION	MODEL	UNITS/CASE
512567	No Hub Torque Wrench	NH7020	6



512567

Plumber's Tape

- Galvanized Steel Strap with Alternate Nail and Bolt Holes
- Bulk Pack
- 3/4" x10' 28 Gauge – Light

PRODUCT	DESCRIPTION	MODEL	UNITS/CASE
84025	Plumbers Tape – 3/4" x10' 28 Gauge – Light	RGS7	50



84025

Weld-On®
Guy Gray®
Waater-Tite®
ToughPans®
RTB
Test-Tite®
AB&A®
Studor®
Truebro®
Christy's®
FloodStop®
ProVent®
ProSet®

Terry Rags



513893

- 100% White Cotton – Good Quality
- Absorbent and Re-Washable
- Measures 14" x 17" Fully Hemmed

PRODUCT	DESCRIPTION	MODEL	UNITS/CASE
513893	Terry Rags	TC-RAGS	16

Reclaimed Flannel Wipes



512931

- Soft and Absorbent
- Idea for Single-Use Applications

PRODUCT	DESCRIPTION	MODEL	UNITS/CASE
512931	Reclaimed Flannel Wipes – 5 lbs.	RFW5	1

Multi-Purpose Towels



512975

- Heavy Duty/ Pre-Moistened
- Removes Embedded Grime Easily
- 90 Towels Per Dispenser

PRODUCT	DESCRIPTION	MODEL	UNITS/CASE
512975	Multi-Purpose Towels	RH-PW1	6

Load Buster Clean-Up Bags



513836

- Black
- Durable Trash Bags for Multi-Use Applications
- 3 mil/ 32" x 50"
- 45 gallon
- 20/box

PRODUCT	DESCRIPTION	MODEL	UNITS/CASE
513836	Load Buster Clean-Up Bags	TC-GB-320	1/200

Rough Surface Non-Slip Glove

- A Unique Process Allows the Surface of the Gloves to be Coated with Small PVC Chips
- They are Coated with a PVC/NBR Blend for Added Chemical Resistance
- Great for Ugly, Dirty Jobs! Provides Better Grip and Hand Protection
- Preferred by Plumbers for Use with Drain Snakes
- Use with Nitrile Gloves Underneath for Added Protection

PRODUCT	DESCRIPTION	MODEL	UNITS/CASE
510264	Rough Surface Non-Slip Gauntlet Cuff Glove – Large	4112	12/72
510262	Rough Surface Non-Slip Knit Wrist Glove – Large	4100	12/72



Black Foam Nitrile Breathable Nylon Knit Glove

- Tight Fit Provides Tactile Sensitivity
- Revolutionary Nitrile-Foam Coating Provides Breathability and Long-Lasting Grip
- Materials: Nylon Liner, Nitrile-Foam Coating

PRODUCT	DESCRIPTION	MODEL	UNITS/CASE
512568	Black Foam Nitrile Breathable Nylon Knit Glove – Large	NITEXP200L	12
512570	Black Foam Nitrile Breathable Nylon Knit Glove – Extra-Large	NITEXP200XL	12



Coated Palm Gloves

- Tight Weave Cotton String Knit with Palm and Fingers Coated in Natural Blue Latex
- Highly Durable with Excellent Wet Grip
- Open Back for superior Ventilation
- Hang Tag

PRODUCT	DESCRIPTION	MODEL	UNITS/CASE
514509	Blue Flex Coated Palm Gloves – Large	9680-L	12/144
514516	Blue Flex Coated Palm Gloves – Extra-Large	9680-XL	12/144



Latex Gloves – Heavy Duty

- Heavy Duty/ Blue Latex with a Longer, Beaded Cuff and Heavier Latex for High Risk Situations
- 13 mil Palm Thickness, 15 mil fingertip thickness
- Textured Finish Allows for a Better Wet and Dry Grip
- Ideal for Industrial Applications
- Powder free
- NFPA Certified
- 50 Pieces Per Box
- Box Quantity Only

PRODUCT	DESCRIPTION	MODEL	UNITS/CASE
510180	Professional Blue Latex Gloves, Powder Free – Large	2815-L	10
510182	Professional Blue Latex Gloves, Powder Free – X-Large	2815-XL	10



Weld-On®
Guy Gray®
Waater-Tite®
ToughPans®
RTB
Test-Tite®
AB&A®
Studor®
Truebro®
Christy's®
FloodStop®
ProVent®
ProSet®

Nitrile Gloves



510146

- 4 mil/ Disposable Ultra Strong Gloves
- 100 Pieces Per Box
- Box Quantity Only

PRODUCT	DESCRIPTION	MODEL	UNITS/CASE
510146	Blue Nitrile Industrial Gloves – Large	2010W-L	10
510148	Blue Nitrile Industrial Gloves – Extra-Large	2010W-XL	10

Latex Gloves – Disposable



510176

- 5mil / Latex Disposable Gloves
- Ideal for Hand Protection During Solvent Cementing
- 100 Pieces Per Box
- Box Quantity Only

PRODUCT	DESCRIPTION	MODEL	UNITS/CASE
510176	Latex Disposable Gloves, 5 Mil (100/Bx) – Large	2800-L	10
510179	Latex Disposable Gloves, 5 Mil (100/Bx) – Extra-Large	2800-XL	10

Work Gloves



513594

- Non-Slip Palm Ideal for Carrying Soil Pipe and Sprinkler Pipe
- Heavy Duty Band for Wrist Protection

PRODUCT	DESCRIPTION	MODEL	UNITS/CASE
513594	Grip Pro Work Glove – Medium	TC-1960L	12/144
513596	Grip Pro Work Glove – Large	TC-1960XL	12/144
513595	Grip Pro Work Glove – Extra-Large	TC-1960M	12/144

Leather Double Palm Work Glove



510778

- Joint Palm Construction
- Select Shoulder Split Leather
- 2.5 inch Rubberized Safety Cuff
- Gunn Cut Pattern
- Hang Pack

PRODUCT	DESCRIPTION	MODEL	UNITS/CASE
510778	Gloves, Leather Double Palm – Large	CL5012DP	12/72

Leather Drivers Glove



510372

- Quality smooth leather
- Unlined
- Shirred Elastic Wrist, Keystone Thumb
- Hang Tag

PRODUCT	DESCRIPTION	MODEL	UNITS/CASE
510372	Leather Drivers Glove – Large	6110-L	12/72
510375	Leather Drivers Glove – Extra-Large	6110-XL	12/72

Leather Palm Work Glove

- Split Cowhide Leather Palm Gloves
- 2.5 inch Rubberized Safety Cuff
- Gunn Cut Pattern
- Hang Tag

PRODUCT	DESCRIPTION	MODEL	UNITS/CASE
510207	Leather Palm Work Glove – Large	3260	12/120



Foil Tape

- Aluminum Foil Backed Tape with Aggressive Adhesive
- Ideal for Sealing Heating and Air Conditioning Ducts and Vents/ and can be Used for Electro-Plating
- Temperature Range -20°F to 150°F
- Shrink Wrapped
- 2.7 mil

PRODUCT	DESCRIPTION	MODEL	UNITS/CASE
513548	2" x 50 YD Foil Tape	TA-UT250FT	24



Caution Tape

- 3 inch, 4 mil – Non-Detectable
- Yellow

PRODUCT	DESCRIPTION	MODEL	UNITS/CASE
513208	3" x 1000 ft Roll/ 4 mil – Non-Detectable	TA-CTN-3-1000	1
513210	3" x 300 ft Roll/ 4 mil – Non-Detectable	TA-CTN-3-300	30



Barricade Tape

- Elongation is >400% at Break Point
- 3 mil Virgin LLDPE/LDPE

PRODUCT	DESCRIPTION	MODEL	UNITS/CASE
513214	3" Red "Danger Do Not Enter" Tape, 300 ft	TA-DNG-3-300	30
513213	3" Red "Danger Do Not Enter" Tape, 1000 ft	TA-DNG-3-1000	10



Liquid Filled Pressure Gauges



513999



513997

- For Service Applications Where Pulsation/ Corrosion/ or Vibration is Present
- Stainless Steel Case
- Glycerin Filled
- Brass 1/4" NPT Connection
- CRN Registered

PRODUCT	DESCRIPTION	MODEL	UNITS/CASE
2-1/2 Inch Face			
513990	2-1/2 inch Liquid Filled DIAL/ 0-15 PSI (1/10th)	TG-LF-15-25	50
513999	2-1/2 inch Liquid Filled DIAL/ 0-30 PSI	TG-LF-30-25	50
514003	2-1/2 inch Liquid Filled DIAL/ 0-60 PSI	TG-LF-60-25	50
513988	2-1/2 inch Liquid Filled DIAL/ 0-100 PSI	TG-LF-100-25	50
513992	2-1/2 inch Liquid Filled DIAL/ 0-160 PSI	TG-LF-160-25	50
513995	2-1/2 inch Liquid Filled DIAL/ 0-200 PSI	TG-LF-200-25	50
513997	2-1/2 inch Liquid Filled DIAL/ 0-300 PSI	TG-LF-300-25	50
514000	2-1/2 inch Liquid Filled DIAL/ 0-400 PSI	TG-LF-400-25	50
514004	Vacuum Gauge LIQUID FILLED/ -30 to 0 Hg	TG-LFVG-30-25	1
4 Inch Face			
513991	4 inch Liquid Filled DIAL/ 0-15 PSI (1/10th)	TG-LF-15-4	50
513989	4 inch Liquid Filled DIAL/ 0-100 PSI	TG-LF-100-4	50
513993	4 inch Liquid Filled DIAL/ 0-160 PSI	TG-LF-160-4	50
513998	4 inch Liquid Filled DIAL/ 0-300 PSI	TG-LF-300-4	50

No Bottom Pressure Gauges



514010



514011

- Steel Case with Shatterproof Dial
- Brass 1/4" NPT Connection
- Use Air/ H2O/ Oil/ Gas or Anything Non-Corrosive to Brass
- Not for Oxygen Service
- CRN Registered

PRODUCT	DESCRIPTION	MODEL	UNITS/CASE
2 Inch Face			
514010	2 inch Pressure Gauge/ 0-15 PSI (1/10th)	TG-NB-15-20	100
514021	2 inch Pressure Gauge/ 0-30 PSI	TG-NB-30-20	100
514026	2 inch Pressure Gauge/ 0-60 PSI	TG-NB-60-20	100
514007	2 inch Pressure Gauge/ 0-100 PSI	TG-NB-100-20	100
514012	2 inch Pressure Gauge/ 0-160 PSI	TG-NB-160-20	100
514015	2 inch Pressure Gauge/ 0-200 PSI	TG-NB-200-20	100
2-1/2 inch face			
514011	2-1/2 inch Pressure Gauge/ 0-15 PSI (1/10th)	TG-NB-15-25	100
514022	2-1/2 inch Pressure Gauge/ 0-30 PSI	TG-NB-30-25	100
514027	2-1/2 inch Pressure Gauge/ 0-60 PSI	TG-NB-60-25	100
514008	2-1/2 inch Pressure Gauge/ 0-100 PSI	TG-NB-100-25	100
514013	2-1/2 inch Pressure Gauge/ 0-160 PSI	TG-NB-160-25	50
514016	2-1/2 inch Pressure Gauge/ 0-200 PSI	TG-NB-200-25	100
514019	2-1/2 inch Pressure Gauge/ 0-300 PSI	TG-NB-300-25	100
514024	2-1/2 inch Pressure Gauge/ 0-600 PSI	TG-NB-600-25	50

Weld-On®
Guy Gray®
ToughPans®
Waater-Tite®
RTB
Test-Tite®
AB&A®
Studor®
Truebro®
Christy's®
FloodStop®
ProVent®
ProSet®

No Bottom Pressure Gauges (continued)

PRODUCT	DESCRIPTION	MODEL	UNITS/CASE
3-1/2 inch face			
514023	3-1/2 inch Pressure Gauge/ 0-30 PSI	TG-NB-30-35	50
514009	3-1/2 inch Pressure Gauge/ 0-100 PSI	TG-NB-100-35	50
514020	3-1/2 inch Pressure Gauge/ 0-300 PSI	TG-NB-300-35	50



514023

Low Pressure Air Test Gauge

- Suited for Low Pressure Measurement Where the Conventional Bourdon Tube Cannot Perform Reliably
- CRN Registered
- 2-1/2" Dial

PRODUCT	DESCRIPTION	MODEL	UNITS/CASE
514006	2 1/2 inch Low Pressure Air Test Gauge – 0-5 PSI	TG-LP-05-25	1



514006

Air Test Gauges

- Steel Case with 2" Shatterproof Dial
- Precision Made Parts
- NPT Connection
- Steel Body
- CRN Registered

PRODUCT	DESCRIPTION	MODEL	UNITS/CASE
513977	2 inch Air Test Gauge 0-15 PSI (1/10th)	TG-A-15-20	100
513978	2 inch Air Test Gauge 0-30 PSI	TG-A-30-20	50
513979	2 inch Air Test Gauge 0-60 PSI	TG-A-60-20	50
513976	2 inch Air Test Gauge 0-100 PSI	TG-A-100-20	50
513980	Air Test Gauge Body w/ Air Valve	TG-A-BAV	100
513987	Air Valve with Cap	TG-A-VCAP	100



513977

Water Test Gauge

- Precision Made
- Steel Case
- Brass FHT Connection
- CRN Registered

PRODUCT	DESCRIPTION	MODEL	UNITS/CASE
2 Inch Face			
514030	Water Test Gauge 2 inch DIAL/ 0-160 PSI	TG-W-160-20	50
514034	Water Test Gauge 2 inch DIAL/ 0-160 PSI Lazy Hand	TG-WLH-160-20	50
514032	Water Test Gauge 2 inch DIAL/ 0-300 PSI	TG-W-300-20	50
514035	Water Test Gauge 2 inch DIAL/ 0-300 PSI Lazy Hand	TG-WLH-300-20	50
2-1/2 Inch Face			
514031	Water Test Gauge 2-1/2 inch DIAL/ 0-160 PSI	TG-W-160-25	50
514033	Water Test Gauge 2-1/2 inch DIAL/ 0-300 PSI	TG-W-300-25	50



514033

ProSet®

ProVent®

FloodStop®

Christy's®

Truebro®

Studor®

AB&A®

Test-Tite®

RTB

ToughPans®

Waater-Tite®

Guy Gray®

Weld-On®

FLOODSTOP®

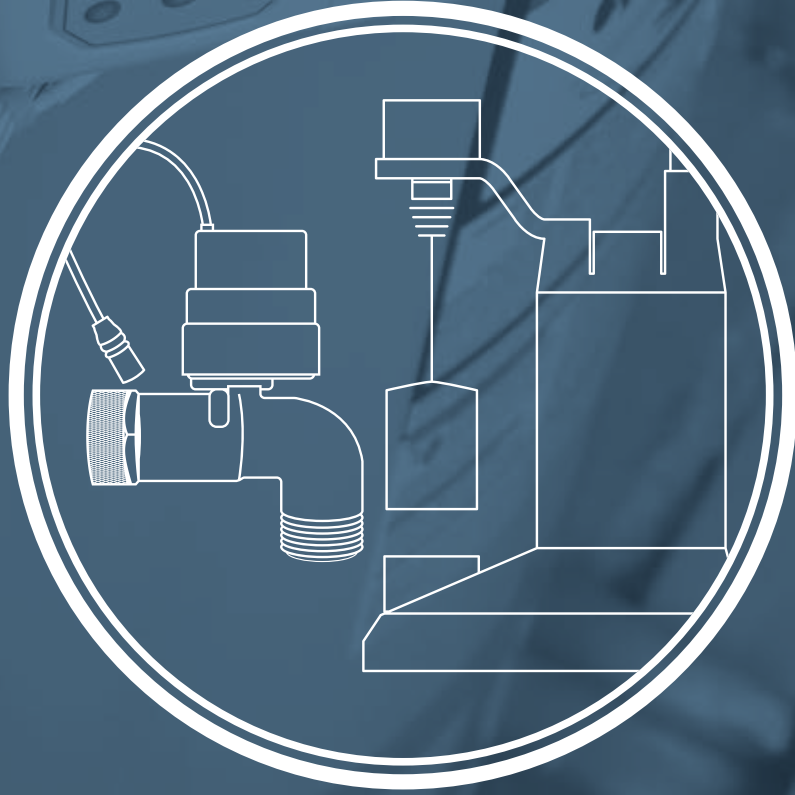

BRAND OVERVIEW

FloodStop®

FloodStop is an innovative brand of product solutions designed to help STOP FLOOD DAMAGE BEFORE IT EVER STARTS™.

The FloodStop point-of-use leak detection devices automatically shut off the water supply to the appliance the moment a leak is detected. Once water is detected, the motorized ball valves close and sound an alarm. FloodStop devices limit potentially devastating flood damage, allowing the plumber, builder, and homeowner to have peace-of-mind knowing no flood caused by an appliance will go unnoticed.

FloodStop has you covered with pumps in various types and models, each offering unique advantages to suit different needs. Alongside these pumps, a range of accessories—such as backup systems, alarms, and discharge hoses—enhances their functionality and reliability.





FloodStop® Leak Detection Device

FloodStop® Leak detection devices automatically shut off the water supply to an appliance or fixture the moment a leak is detected. Once water is detected, the motorized ball valves close and sound an alarm. FloodStop® Leak Detection Kits are durable and multi-use, which limits potentially devastating flood damage, allowing the plumber, builder, and homeowner to have peace-of-mind knowing no flood caused by an appliance or fixture will go unnoticed.

- Motorized Lead-Free, CNC-machined, Full-Port Ball Valve
- Control Unit is powered by the included AC power supply. Optionally, it may be powered with 4 AA batteries (not included). Batteries used in conjunction with the AC power supply provide backup should AC power fail.
- Water/Leak Sensor (1.25" X 7.5")
- Includes screws and drywall anchors, plus a hook and loop, self-adhesive mounting pad for multiple mounting options
- FloodStop's pigtail ties into Building Maintenance Systems (BMS) and sends a relay to notify of alarm and valve closure



20000



20010



20020

LISTINGS	PRODUCT	DESCRIPTION	MODEL	UNITS/ CASE
FloodStop® Water Heater Kits				
20000	Water Heater Kit, 1/2" NPT MIP x FIP Full Port Motorized Ball Valve		FS12NPT	12
20001	Water Heater Kit, 3/4" NPT MIP x FIP Full Port Motorized Ball Valve		FS34NPT	12
20015	Water Heater Kit, 3/4" Press x Press Motorized Ball Valve		FS34PRESS	12
20016	Water Heater Kit, 3/4" Press x MPT Motorized Ball Valve		FS34PRESSMPT	12
20002	Water Heater Kit, 3/4" Compression Full Port Motorized Ball Valve		FS34C	12
20007	Water Heater Kit, 3/4" Push-to-Connect Full Port Motorized Ball Valve		FS34P	12
20003	Water Heater Kit, 1" NPT MIP x FIP FIP Full Port Motorized Ball Valve		FS1NPT	12
20004	Water Heater Kit, 1-1/4" NPT MIP x FIP Full Port Motorized Ball Valve		FS125NPT	12
20005	Water Heater Kit, 1-1/2" NPT MIP x FIP Full Port Motorized Ball Valve		FS150NPT	12
FloodStop® Washing Machine Kits				
20010	Washing Machine Kit, 90° 3/4" Motorized Ball Valves		FS34H90	12
20011	Washing Machine Kit, Straight 3/4" Motorized Ball Valves		FS34H	12
FloodStop® Ice Maker, Dish Washer/Toilet, and Sink Kits				
20020	Ice Maker Kit, 1/4" Motorized Compression Valve		FS14C	12
20021	Toilet/Dishwasher Kit, 3/8" Motorized Compression Valve		FS38C	12
20006	Sink Kit, (2) 1/2" NPT MIP x FIP, Full Port Motorized Ball Valves		FS12NPTD	12
20022	Sink Kit, (2) 3/8" Compression Motorized Compression Valves		FS38CD	12

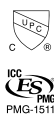

Weld-On®
Guy Gray®
Waater-Tite®
ToughPans®
RTB
Test-Tite®
AB&A®
Studor®
Truebro®
Christy's®
FloodStop®
ProVent®
ProSet®



FloodStop® Leak Detection Accessories

PRODUCT	DESCRIPTION	MODEL	UNITS/CASE
FloodStop® Controllers			
20070	Controller for FloodStop® Kits with Single Valve	FSACONT1	1
20071	Controller for FloodStop® Kits with Two Valves	FSACONT2	1
Sensor			
20072	Extra Sensor to Extra Sensor with 3' Wire	FSAXS01	1
20079	Sensor Manifold	FSASMO1	1
Wiring Harness to Sensor and Valve(s)			
20075	Wiring Harness for Single Valve (84" to Sensor / 33" to Valve)	FSAWHS	1
20076	Wiring Harness for Dual Valve (84" to Sensor / 33" to Valve)	FSAWHD33	1
20095	Wiring Harness for Dual Valve (84" to Sensor / 72" to Valve)	FSAWHD72	1
20092	Wiring Harness, Plenum Rated, Single Valve (18' to Sensor / 26' to Valve)	FSASVHARNP25	1
Wall Adapter			
20073	Wall Adapter, 9VDC, White, 5-1/2" Wire	FSAWA	1
20091	9' Wall Adapter Extension Wire	FSAWAE9	1
Sensor to Sensor Extensions Wires			
20077	Sensor to Sensor Extension Wire, 10'	FSASEXT10	1
20078	Sensor to Sensor Extension Wire, 22'	FSASEXT22	1
Controller to Valve Extension Wire			
20074	Controller to Valve Extension Wire, 9'	FSACEXT9	1
Motors			
20093	Motor 5 Stage Gearbox for 1" diameter and smaller kits	FSAMOTOR5M	1
20094	Motor 6 Stage Gearbox for 1.25" diameter	FSAMOTOR6M	1
Wi-Fi Module			
20052	Wi-Fi Module	FSWIFE	1



20070



20070



20073



20077



20093



20052

FloodStop® Leak Detection Valves Only

LISTINGS	PRODUCT	DESCRIPTION	MODEL	UNITS/CASE
	20080	Valve Only 1/4" Compression	FSAV14C	1
	20081	Valve Only 1/2" NPT	FSAV12NPT	1
	20082	Valve Only 3/4" 90°, Washing Machine	FSAV34H90	1
	20083	Valve Only 3/4" Straight, Washing Machine	FSAV34H	1
	20084	Valve Only 3/4" NPT, Water Heater	FSAV34NPT	1
	20085	Valve Only 3/8" Compression	FSAV38C	1
	20086	Valve Only 1" NPT	FSAV1NPT	1
	20087	Valve Only 1-1/4" NPT	FSAV125NPT	1
	20088	Valve Only 1-1/2" NPT	FSAV150NPT	1
	20089	Valve Only 3/4" Compression	FSAV34C	1
	20090	Valve Only 3/4" Push-to-Connect	FSAV34P	1
	20096	Valve Only 3/4" Press x Press	FSAV34PRESS	1
	20097	Valve Only 3/4" Press x MPT	FSAV34PRESSMPT	1



20084



20082

Weld-On®
Guy Gray®
Water-Tite®
ToughPans®
RTB
Test-Tite®
AB&A®
Studor®
Truebro®
Christy's®
FloodStop®
ProVent®
ProSet®

Weld-On®
Guy Gray®
Waater-Tite®
ToughPans®
RTB
Test-Tite®
AB&A®
Studor®
Truebro®
Christy's®
FloodStop®
ProVent®
ProSet®

Top Suction Thermoplastic Sump Pump



22201

- Top suction design filters debris and minimizes clogging, reduces airlocks
- Heavy-duty, energy efficient PSC motor with thermal overload protection
- Oil-filled motor provides continuous lubrication and extends the life of the pump

PRODUCT	DESCRIPTION	MODEL	UNITS/CASE
22201	Sump Pump, Primary, 1/3HP, TP Housing, TP Volute, 10' VFS	FSPP33TTDV10	1

Top Suction Thermo Cast Sump Pump



22202

- Cast iron base and corrosion-resistant motor housing
- Volute top suction design filters debris and minimizes clogging, reduces airlocks
- Lubricated ball bearings and shaft seal for long life
- Energy-efficient PSC motor
- Oil-filled motor for maximum heat dissipation
- Built-in automatic overload thermal protector

PRODUCT	DESCRIPTION	MODEL	UNITS/CASE
22202	Sump Pump, Primary, 1/2HP TP Housing, CI Volute, 10' VFS	FSPP50TCDV10	1
22205	Sump Pump, Primary, 1/3HP TP Housing, CI Volute, 10' VFS	FSPP33TCDV10	1

Bottom Suction Cast Iron Sump Pump



22208

- Heavy-duty cast iron construction ideal for applications requiring a rugged submersible pump
- Piggyback Vertical or Tethered Switch for automatic and manual operation
- Lubricated ball bearings and shaft seal for long life
- Energy-efficient, PSC oil-free motor with thermal overload protection
- Non-clog Vortex Impeller

PRODUCT	DESCRIPTION	MODEL	UNITS/CASE
22208	Cast Iron Sump Pump, 1/2 HP, Vertical Float Switch, 10' Cords	FSPP50CCPV10	1
22212	Cast Iron Sump Pump, 1/2 HP, Vertical Float Switch, 20' Cords	FSPP50CCPV20	1
22213	Cast Iron Sump Pump, 1/2 HP, Tethered Float Switch, 20' Cords	FSPP50CCPT20	1
22209	Cast Iron Sump Pump, 1/3 HP, Vertical Float Switch, 10' Cords	FSPP33CCPV10	1
22214	Cast Iron Sump Pump, 1/3 HP, Vertical Float Switch, 20' Cords	FSPP33CCPV20	1
22215	Cast Iron Sump Pump, 1/3 HP, Tethered Float Switch, 20' Cords	FSPP33CCPT20	1

WiFi-Enabled Battery Backup Sump Pump



22100

- High flow battery backup DC pump
- Corrosion-resistant construction
- Water-cooled, high efficiency motor
- Monitors for high water, pump malfunctions, and battery health

PRODUCT	DESCRIPTION	MODEL	UNITS/CASE
22100	Sump Pump, BBU 2400GPH WiFi Enabled, 12v	FSBB2400W	1
22102	Sump Pump, BBU 1850GPH WiFi Enabled, 12v	FSBB1850W	1

Standard Battery Backup Sump Pump

- High flow battery backup DC pump
- Corrosion-resistant construction
- Water-cooled, high efficiency motor

PRODUCT	DESCRIPTION	MODEL	UNITS/CASE
22101	Sump Pump, BBU 2400GPH 12v	FSBB2400	1
22103	Sump Pump, BBU 1850GPH 12v	FSBB1850	1



22101

WiFi-Enabled Sump Pump Combo System — Cast Iron

Primary Pump

- Heavy duty cast iron construction
- Piggyback vertical float switch for automatic and manual operation
- Lubricated ball bearings and shaft seal for longevity
- Energy-efficient, PSC motor with thermal overload protection

Backup Pump

- High flow battery backup DC pump
- Corrosion-resistant construction
- Water-cooled, high efficiency motor
- Monitors for high water, pump malfunctions, and battery health

PRODUCT	DESCRIPTION	MODEL	UNITS/CASE
22306	Sump Pump Combo, 1/2HP CI/CI, BBU-2400 BU TP, WiFi	FSC50CC2400W	1
22308	Sump Pump Combo, 1/3HP CI/CI, BBU-2400 BU TP, WiFi	FSC33CC2400W	1



22308

Standard Sump Pump Combo System - Thermoplastic

Primary Pump

- Cast iron base and corrosion-resistant motor housing
- Vertical float switch for automatic operation
- Lubricated ball bearings and shaft seal for longevity
- Energy-efficient, PSC motor with thermal overload protection

Backup Pump

- High flow battery backup DC pump
- Corrosion-resistant construction
- Water-cooled, high efficiency motor

PRODUCT	DESCRIPTION	MODEL	UNITS/CASE
22304	Sump Pump Combo, 1/3H P TP/CI, BBU-1850 BU TP	FSPC13TC1850	1



22304

Standard Sump Pump Combo System - Cast Iron

Primary Pump

- Heavy duty cast iron construction
- Piggyback vertical float switch for automatic and manual operation
- Lubricated ball bearings and shaft seal for longevity
- Energy-efficient, PSC motor with thermal overload protection

Backup Pump

- High flow battery backup DC pump
- Corrosion-resistant construction
- Water-cooled, high efficiency motor
- Monitors for high water, pump malfunctions, and battery health

PRODUCT	DESCRIPTION	MODEL	UNITS/CASE
22309	Sump Pump Combo, 1/3H CI/CI, BBU-2400 BU TP	FSC33CC2400	1
22310	Sump Pump Combo, 1/3H CI/CI, BBU-1850 BU TP	FSC33CC1850	1



22309

Effluent Pump



22407

- Rugged cast iron pump housing and base
- Non-clog Vortex Impeller handles up to 3/4" solids
- Piggyback Tethered Float Switch for automatic or manual operation
- Energy-efficient, PSC motor with automatic reset thermal overload protection
- Oil-filled motor provides maximum heat dissipation and permanent lubrication
- 2" female NPT discharge with 20' or 35' power cord
- 2" to 1-1/2" reducer included for installation versatility
- high efficiency motor

PRODUCT	DESCRIPTION	MODEL	UNITS/CASE
22407	Effluent Pump, 3/4 HP, Tethered Float Switch, 20' Cords	FSEP75T20	1
22408	Effluent Pump, 1/2 HP, Tethered Float Switch, 20' Cords	FSEP50T20	1
22409	Effluent Pump, 3/4 HP, Tethered Float Switch, 35' Cords	FSEP75T35	1
22410	Effluent Pump, 1/2 HP, Tethered Float Switch, 35' Cords	FSEP50T35	1

Sewage Pump



22402

- Heavy-duty cast iron construction maximizes pump life
- Piggyback tethered or vertical float switch for automatic and manual operation
- Non-clog vortex impeller handles up to 2" solids
- Energy-efficient PSC motor with automatic reset thermal overload protection
- Ball bearings for quiet operation
- Oil-filled motor provides maximum heat dissipation and permanent lubrication

PRODUCT	DESCRIPTION	MODEL	UNITS/CASE
22402	Sewage Pump, 1/2 HP, Tethered Float Switch, 10' Cords	FSSW50T10	1
22404	Sewage Pump, 1/2 HP, Vertical Float Switch 10' Cords	FSSW50V10	1
22403	Sewage Pump, 4/10 HP, Tethered Float Switch, 10' Cords	FSSW40T10	1
22405	Sewage Pump, 1/2 HP, Tethered Float Switch, 20' Cords	FSSW50T20	1
22406	Sewage Pump, 1/2 HP, Vertical Float Switch 20' Cords	FSSW50V20	1

Grinder Pump



22400

- Vortex impeller reduces clogging
- Special stainless steel cutter with heavy abrasive resistance
- Reliable and durable double mechanical seal
- Internal disc overload protection protects pump from overheating or other mechanical fault
- High head enables moving water to far distance
- Piggyback tethered float switch for automatic or manual operation
- 230 volt, single phase, 3450 RPM, 15 AMPs

PRODUCT	DESCRIPTION	MODEL	UNITS/CASE
22400	Grinder Pump, 2 HP, Tethered Float Switch, 20' Cords	FSGP200	1

Weld-On®
Guy Gray®
ToughPans®
Waater-Tite®
RTB
Test-Tite®
AB&A®
Studor®
Truebro®
Christy's®
FloodStop®
ProVent®
ProSet®

Pre-Plumbed Sewage Pump System - 45 Gallon

- 4/10 HP or 1/2 HP cast iron sewage pump with non-clog vortex impeller, tethered float and piggyback plug
- Polyethylene structural foam sewage basin (24 x 24 in. / 45 gal.)
- Polyethylene structural foam sewage cover (2 in. threaded discharge flange, 2 in. threaded vent flange, 6 in. access opening and 2-hole cord grommet)
- 2 in. silent shutoff check valve
- 4 in. water-tight inlet hub with stainless steel clamp (Fits 4 in. DWV Schedule 40/80 pipe)



22500

PRODUCT	DESCRIPTION	MODEL	UNITS/CASE
22500	Pre-Plumbed Sewage System, 45 Gal, 1/2HP Tethered Float Switch, 20' cords	FSSW50T20B45	1
22501	Pre-Plumbed Sewage System, 45 Gal, 4/10HP Tethered Float Switch, 20' cords	FSSW40T20B45	1
22503	Pre-Plumbed Sewage System, 45 Gal, 1/2HP TFS, 20' cord	FSSW50T20B45A	1
22504	Pre-Plumbed Sewage System, 45 Gal, 4/10HP TFS, 20' cord	FSSW40T20B45A	1

Pre-Plumbed Sewage Pump System - 30 Gallon

- 1/2 HP cast iron sewage pump with non-clog vortex impeller, tethered float and piggyback plug
- Polyethylene structural foam sewage basin (18 x 30 in. / 30 gal.)
- Polyethylene structural foam sewage cover (2 in. threaded discharge flange, 2 in. threaded vent flange, 6 in. access opening and 2-hole cord grommet)
- 2 in. silent shutoff check valve
- 4 in. water-tight inlet hub with stainless steel clamp (Fits 4 in. DWV Schedule 40/80 pipe)



22502

PRODUCT	DESCRIPTION	MODEL	UNITS/CASE
22502	Pre-Plumbed Sewage System, 30 Gal, 1/2HP TFS, 20' cord	FSSW50T20B30	1

Utility Pump

- Automatically turns ON when water reaches 1-1/4", and OFF at 1/4" water level
- Energy-efficient PSC motor with thermal overload protection
- Water-cooled, oil free motor design is safe to use around fish and plants
- Corrosion-resistant thermoplastic construction
- Use to drain water from window wells, flooded basements, water gardens, stock tanks, flat roofs, pool covers and more
- Flexible rubber impeller helps prevent clogging and handles up to 1/8" spherical solids
- 1" NPT discharge with garden hose adapter included



22801

PRODUCT	DESCRIPTION	MODEL	UNITS/CASE
22801	Utility Pump, 1/4 HP	FSUP25TA	1

Transfer Pump



22802

- Portable, non-submersible utility/transfer pump
- Multi-purpose pump with high-capacity performance
- Self-priming up to 25'
- Removes water down to 1/16" with suction strainer (not included)
- Constructed of durable, heavy-duty cast iron, with stainless steel motor shaft
- Comes with 3/4" NPT Suction and Discharge size, and 10' power cord

PRODUCT	DESCRIPTION	MODEL	UNITS/CASE
22802	Cast Iron Transfer Pump, 1/2 HP	FSTP50	1

Condensate Pump with Safety Switch



22600

- Ideal for furnace or air conditioner
- Automatic, maintenance free operation for removing condensation buildup from furnaces, ice makers, and dehumidifiers
- Corrosion-resistant construction designed to resist high-humidity environments
- Safety switch provides automatic shutoff of connected appliances, such as air conditioners, dehumidifiers, and furnaces
- 20' tubing included for quick, easy installation

PRODUCT	DESCRIPTION	MODEL	UNITS/CASE
22600	Condensate Pump, 1/20HP	FSCP120	4

Sink Drain System



22601

- Pump**
- Heavy-duty cast iron construction ideal for applications requiring a rugged submersible pump
 - Piggyback Vertical Switch for automatic and manual operation
 - Lubricated ball bearings and shaft seal for long life
 - Energy-efficient, PSC oil-free motor with thermal overload protection
 - Non-clog Vortex Impeller
 - Silent threaded check valve included

- Basin**
- Tough polyethylene structural foam construction
 - Gasket sealed liquid and airtight cover with 8 bolts
 - 1-1/2" Inlet, discharge & vent

PRODUCT	DESCRIPTION	MODEL	UNITS/CASE
22601	1/3 HP Sink Drain System	FSSP33V10	1

Descaler Kit



22901

- Makes it easy to flush a tankless heater
- Includes 5 Gal. bucket, pump, two 6-1/2' hoses, and 7 oz descaler powder
- Easy convenient kit
- Pumps up to 27 GPM through the system
- Bucket is made from durable plastic

PRODUCT	DESCRIPTION	MODEL	UNITS/CASE
22900	Descaler Powder, 7 OZ	FSADES07	24
22901	Descaler Kit	FDSKIT	1

Weld-On®
Guy Gray®
Waater-Tite®
ToughPans®
RTB
Test-Tite®
AB&A®
Studor®
Truebro®
Christy's®
FloodStop®
ProVent®
ProSet®

FloodStop® Pump Monitor

Your home isn't complete without the smart technology to protect its very structure. FloodStop's innovative Pump Monitor will help keep your basement dry and your mind at ease. The FloodStop® Pump Monitor detects problems and automatically sends alerts as soon as a problem is detected.

- Monitor your pump anywhere with an internet connection.
- Receive alerts when there are issues with the connected pump.
- Provides peace of mind when away from home.
- Works with any sump pump.
- Pairs with the free and easy-to-use FloodStop® app. Available from Apple App Store or Google Play.

PRODUCT	DESCRIPTION	MODEL	UNITS/CASE
22002	FloodStop® Pump Monitor	FSPM	16



Upgrade Kit w/ UPS

- Used to convert standard FloodStop Battery Backup Systems (Models FSBB1850 & FSBB2400) into WiFi-enabled systems (Compare to models FSBB1850W & FSBB2400W)
- Includes an uninterruptible power supply for routers and modems, ensuring WiFi connectivity during a power outage

PRODUCT	DESCRIPTION	MODEL	UNITS/CASE
22000	WiFi Kit, Battery Box, WiFi, Router, and UPS Back-Up	FSUG1	1



Upgrade Kit

- Used to convert standard FloodStop Battery Backup Systems (Models FSBB1850 & FSBB2400) into WiFi-enabled systems (Compare to models FSBB1850W & FSBB2400W)

PRODUCT	DESCRIPTION	MODEL	UNITS/CASE
22001	WiFi Kit, Battery Box, WiFi, No Router or UPS Back-Up	FSUG2	1



Weld-On®
Guy Gray®
Water-Tite®
ToughPans®
RTB
Test-Tite®
AB&A®
Studor®
Truebro®
Christy's®
FloodStop®
ProVent®
ProSet®

Backup Power System



- Automatically switches over to battery power during a power outage
- Supports up to two pumps
- Built-in 5 Amp charger that quickly charges any connected batteries without damage
- Easy to read LCD with battery information
- Safety features designed to protect connected pumps and batteries
- Status LEDs to indicate power, charging, and input faults
- 5V USB for charging mobile devices
- Connects to deep cycle batteries
- FloodStop® AGM Maintenance Free batteries are recommended
- Multiple batteries can be connected in parallel

PRODUCT	DESCRIPTION	MODEL	UNITS/CASE
22700	Backup Power System, 2000W	FSAINV2000	1
22701	Backup Power System, 1500W	FSAINV1500	1

Backup Power Kit



Primary Sump Pump

- Heavy duty cast iron construction
- Piggyback vertical float switch for automatic and manual operation
- Lubricated ball bearings and shaft seal for longevity
- Energy-efficient, PSC motor with thermal overload protection

Backup Power System

- Automatically switches over to battery power when AC power goes out.
- Generates a Pure Sine Wave
- Automatically recharges a battery when AC power is restored

PRODUCT	DESCRIPTION	MODEL	UNITS/CASE
22743	Backup Power Kit, One Pump	FSCINVKIT1	1
22738	Backup Power Kit, Two Pumps	FSCINVKIT2	1

Deep Cycle Battery



- Maintenance-free design does not require regular addition of water or acid for proper operation
- Sealed enclosure eliminates spilled acid from tipped battery and hydrogen gas venting
- Absorbent glass mat technology for superior performance; valve-regulated, spill-proof construction allows safe operation in any position
- The sealed design is easy to transport and install without worrying about spills

PRODUCT	DESCRIPTION	MODEL	UNITS/CASE
22702	Deep Cycle Battery 12VDC/100AH	FSAB100	1
22736	Deep Cycle Battery 12VDC/100AH – Pallet Quantities / 52 per pallet	FSAB100-LTL	1
22703	Deep Cycle Battery 12VDC/75AH	FSAB75	1

Uninterruptible Power Supply



- Provides a battery backup for router and modem
- Can be used as a dedicated modem and router UPS, providing power for up to 6 hours during a power outage
- The UPS surge protector will keep your devices safe from power spikes
- Capacity: 650VA / 360W, Input: 120V, Battery: 12V / 7Ah

PRODUCT	DESCRIPTION	MODEL	UNITS/CASE
22704	Uninterruptible Power Supply	FSAUPS	1

Weld-On®
Guy Gray®
Waater-Tite®
ToughPans®
RTB
Test-Tite®
AB&A®
Studor®
Truebro®
Christy's®
FloodStop®
ProVent®
ProSet®

FloodStop® Pump Check Valve

Engineered to allow for maximum flow from your sump pump. The FloodStop® "full-flow" check valves prevent the water that remains in the sump discharge pipe from falling back into the sump pit. This avoids pumping the same water twice, extending the life of your pump. The pump check valves features a unique spring loaded flapper that eliminates the annoying water hammer noise of standard check valves. Constructed with durable ABS for years of service and reliability. Includes all stainless steel hose clamps to prevent rust and corrosion for a secure, leak proof connection.

- Quiet sump pump threaded check valve
- The unique spring loaded flapper eliminates the water hammer noise of standard check valves
- 100% Stainless steel clamps included
- Threads directly into the pump's outlet to connect it to a 1-1/2" Pipe
- Pre-drilled weep hole to eliminate air lock that may occur in bottom suction pumps

PRODUCT	DESCRIPTION	MODEL	UNITS/CASE
Threaded Pump Check Valve			
22725	FloodStop® 1.5" Threaded Black Pump Check Valve	FSCV15TB	20
In-line Pump Check Valves			
22726	FloodStop® 1-1/2" In-line Clear Pump Check Valve	FSCV15IC	15
22727	FloodStop® 1-1/2" In-line Black Pump Check Valve	FSCV15IB	15
22728	FloodStop® 2" In-line Clear Sump Pump Check Valve	FSCV21C	12
22739	FloodStop® 2" In-line Black Sump Pump Check Valve	FSCV21B	12



22725



22728

1-1/4" or 1-1/2" Sump Pump Check Valve

- Compatible with 1-1/4" or 1-1/2" discharge piping.
- Engineered to allow maximum flow from pumps.
- Constructed from durable ABS material.
- Includes Buna-N rubber couplings for easy inline connections
- 100% stainless steel hose clamps prevent rust and corrosion while providing a secure, leak-proof connection.

PRODUCT	DESCRIPTION	MODEL	UNITS/CASE
22734	Check Valve 1-1/4" or 1-1/2", Solid	FSCV125-151B	10



22734

1-1/2" Silent Check Valves - Solvent Weld Connections

- Unique spring-loaded flapper eliminates the water hammer noise of standard check valves
- Engineered to allow maximum flow from pumps
- Constructed from durable ABS and PVC material
- Solvent weld connections with unions allow for easy and secure installation
- Clear valve body allows visibility to ensure proper operation (Clear items only – 22729)

PRODUCT	DESCRIPTION	MODEL	UNITS/CASE
22729	Check Valve 1.5" Solvent Weld , Clear, Silent	FSCV15SWC	12
22730	Check Valve 1.5" Solvent Weld , Solid, Silent	FSCV15SWS	12
22733	Check Valve 1.5" Solvent Weld , Shutoff, Solid, Silent	FSCV15SWSSO	12



22729



22730



22733

Weld-On®

Guy Gray®

Water-Tite®

ToughPans®

RTB

Test-Tite®

AB&A®

Studor®

Truebro®

Christy's®

FloodStop®

ProVent®

ProSet®

2" Silent Check Valves - Solvent Weld Connections



- Unique spring-loaded flapper eliminates the water hammer noise of standard check valves
- Engineered to allow maximum flow from pumps
- Constructed from durable ABS and PVC material
- Solvent weld connections with unions allow for easy and secure installation

PRODUCT	DESCRIPTION	MODEL	UNITS/CASE
22731	Check Valve 2" Solvent Weld , Solid, Silent	FSCV2SWS	12
22732	Check Valve 2" Solvent Weld , Shutoff, Solid, Silent	FSCV2SWSSO	12

FloodStop® Vertical Float Switches



Engineered for ultimate reliability, the FloodStop® Vertical Float Switch uses gold plated electrical contacts that resist pitting and wear. Advanced material technology to reduce buildup on the switch allowing it to operate freely without sticking. This switch can easily be installed by mounting it onto a pump's discharge pipe with the included mounting bracket and 100% stainless steel hose clamp. A 10' or 20' power cord with a piggyback plug makes this switch a universal replacement.

- Tested to 1 million cycles for ultimate reliability.
- Universal Replacement comes completely assembled and ready to mount on pump discharge pipe.
- Ideal replacement for sump, sewage, and effluent applications.
- Long power cord with a piggyback plug for easy installation and replacement.

PRODUCT	DESCRIPTION	MODEL	UNITS/CASE
22705	FloodStop® Vertical Float Switch 10' Cord	FSAVFS10	12
22706	FloodStop® Vertical Float Switch 20' Cord	FSAVFS20	12

FloodStop® Tethered Float Switch



Engineered for ultimate reliability, the FloodStop® Tethered Float Switch uses gold plated electrical contacts that resist pitting and wear. This switch can easily be installed by mounting it onto the pump's discharge pipe or directly to a pump. A 10' or 20' power cord with a piggyback plug makes this switch a universal replacement.

- Universal replacement for most tether switch applications
- Suitable for use with Sump, Sewage, or Effluent Pumps
- 10- or 20-foot power cord with piggyback plug for ease of installation
- Rated for up to 15 amps
- Includes hose clamp and cord grip for easy installation onto the pump's discharge pipe

PRODUCT	DESCRIPTION	MODEL	UNITS/CASE
22707	FloodStop® Tethered Float Switch 10' Cord	FSATFS10	22
22708	FloodStop® Tethered Float Switch 20' Cord	FSATFS20	22

FloodStop® WYE, 2 x 1.5 x 1.5 Connection



FloodStop's PVC Manifold Wye is a versatile solution to your plumbing needs! This PVC Manifold Wye, also known as a Y-connector, contains two 1-1/2" male slips that join to a single 2" female slip. Designed to perform and be adapted to a variety of plumbing applications. This is also a useful tool when combining two pumps to a single discharge line.

- Ideal for connecting two PVC channels into one
- Can be used in a variety of plumbing applications
- Useful for connecting two sump pumps to a single discharge
- Includes (2) 1-1/2" male slips and (1) 2" female slip

PRODUCT	DESCRIPTION	MODEL	UNITS/CASE
22709	FloodStop® WYE, 2 x 1.5 x 1.5 Connection	FSAWYE	12

FloodStop® Dual Pump Install Kit

Installing a second sump pump has never been easier. The FloodStop® Dual Pump Install Kit has everything you need to connect 2 sump pumps to a single discharge line. There's no need to purchase PVC pipe, elbows, couplings and cement. No cutting or messy glue. Simply screw the check valves into both pumps, drop the Y-connector into the check valve boots, attach the rubber boot to the top of the Y-connector and then to your existing discharge line. Tighten all the stainless steel clamps with a screwdriver and you're done. Install your pumps in a fraction of the time, since there's no cutting or gluing required. The Dual Pump Install Kit includes: Y-Connector, (2) 1-1/2" Threaded Silent Check Valves, Stainless Steel Clamps and Buna-N Rubber Couplings. This kit is compatible with all pumps that have a standard 1-1/2" NPT pump discharge/output.

- Everything you need to connect 2 sump pumps to a single 1-1/2" discharge line.
- Connects 2 primary sump pumps OR primary and backup pump.
- Easy installation with a standard screwdriver. No glue or cement required.

- Full flow 1-1/2" check valves and Y-connector allows maximum pump output.
- Silent check valves eliminate water hammering for quiet operation.



22710

PRODUCT	DESCRIPTION	MODEL	UNITS/CASE
22710	FloodStop® Dual Pump Install Kit	FSADPIK	9

FloodStop® Freeze Drain

The FloodStop® Freeze Drain allows water to escape through its perforations when a sump pump discharge line gets clogged. By giving the water a secondary escape route, the Freeze Drain will prevent the pump from overworking and the basement from flooding.

- Prevents pump failures with discharge line clogging occurs.
- Engineered to divert water away from the home's foundation.
- Thick-walled, durable PVC for excellent impact resistance.
- Easy installation on new and existing systems.
- Will not become brittle or rust in cold/wet weather.

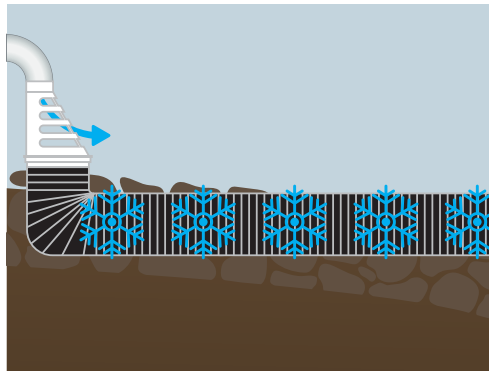

22716

PRODUCT	DESCRIPTION	MODEL	UNITS/CASE
22716	FloodStop® Freeze Drain	FSAFD	18

FloodStop® Yard Drain Emitter

The FloodStop® Yard Drain Emitter is the perfect solution to emit water away from a foundation. This versatile emitter can be used in a variety of applications – including sump pump discharges, downspouts, detention ponds, and culverts. The grated cover allows water to flow naturally, eliminating stagnant water. The open design makes this a favorable solution in cold and freezing conditions. Compatible with 4-inch connections. Durably constructed and easy to install.

- Designed for sump pump discharges, downspouts, detention ponds, culverts, and similar applications.
- Directs drainage away from the home or building's foundation.

- Reduces stagnant water in the pipe.
- Performs well in cold and frozen conditions.
- Compatible with 4-inch connections.



22715

PRODUCT	DESCRIPTION	MODEL	UNITS/CASE
22715	FloodStop® Yard Drain Emitter	FSAYD	12

Buna-N Rubber Couplings



22711



22712

- Used to quickly connect PVC or ABS pipe
- Constructed of flexible Buna-N rubber for durable and long-lasting connections
- Features 100% stainless steel hose clamps

PRODUCT	DESCRIPTION	MODEL	UNITS/CASE
22711	Coupling Buna-N Rubber 1-1/2", Stainless Steel Clamp	FSARC115	57
22712	Coupling Buna-N Rubber 2", Stainless Steel Clamp	FSARC2	37

FloodStop® High Water Alarm



22717

The FloodStop® Battery Powered High Water Alarm minimizes the risk of water damage by providing an immediate warning when water is detected. Best for installation near sump pumps, hot water heaters, dehumidifiers, washing machines, toilets, or under sinks. The High Water Alarm requires a 9-Volt battery, which is included.

- Reliable sensor ensures you will be notified of any detected water.
- The sensor is attached to a 6-foot wire, allowing hard-to-reach areas to be monitored, making this a perfect sump pump alarm.
- Can be stood on floor or mount to a wall.
- Loud, 100 dB alarm, can be heard throughout entire home.
- Power-saver feature helps the battery (included) last longer, ensuring greater protection for your home.

PRODUCT	DESCRIPTION	MODEL	UNITS/CASE
22717	FloodStop® High Water Alarm	FSWA	24

ProSet®
FloodStop®
Christy's®
Truebro®
Studor®
AB&A®
Test-Tite®
RTB
ToughPans®
Waater-Tite®
Guy Gray®
Weld-On®

Pump Stand

- Provides added protection and efficiency to your sump pump by adding extra elevation - preventing clogs due to sediment buildup
- Extends the sump pump life expectancy by reducing the amount of sediment that can be trapped
- Easy to install
- Compatible with most sump pumps
- Made from quality material that will stand the test of time



22718

PRODUCT	DESCRIPTION	MODEL	UNITS/CASE
22718	Pump Stand	FSAPS	12

Positive/Negative Battery Cable Set

- 18" cables
- Used to connect multiple deep cycle batteries together in parallel



22735

PRODUCT	DESCRIPTION	MODEL	UNITS/CASE
22735	Battery Cable Set, Pos / Neg	FSABC	12

ProSet®

ProVent®

FloodStop®

Christy's®

Truebro®

Studor®

AB&A®

Test-Tite®

RTB

ToughPans®

Waater-Tite®

Guy Gray®

Weld-On®



PROVENT®

BRAND OVERVIEW

ProVent®

The ProVent Single Stack System is an innovative DWV (drain, waste and vent) system that ensures a smooth, safe flow without any additional vent piping. The system functions as well or better than conventional two-stack systems, but cuts piping requirements in half while slashing labor and materials costs by up to 40%.

Fabricated from high grade PVC, the ProVent Single Stack System also installs much more quickly and easily than conventional systems, eliminating floor penetrations, and requiring fewer hangers and supports, helping to keep projects on schedule.

Modeled on a proven DWV solution backed by 60+ years in the field, the system features corrosion-proof StackVent and BaseVent fittings and PVC piping that can be easily engineered to accommodate a wide range of multistory projects.



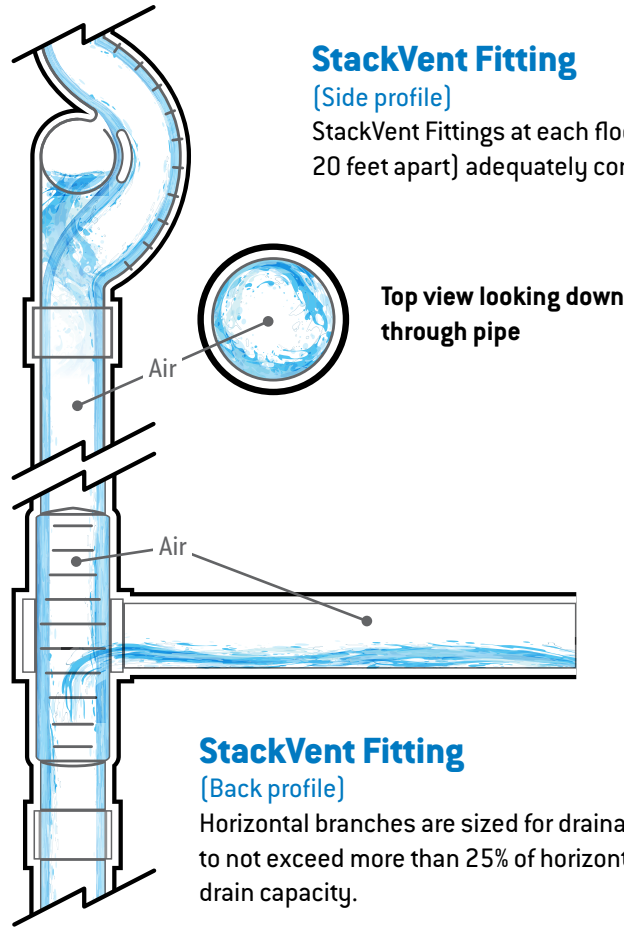

StackVent Fitting
[Back profile]
Horizontal branches are sized for drainage to not exceed more than 25% of horizontal drain capacity.

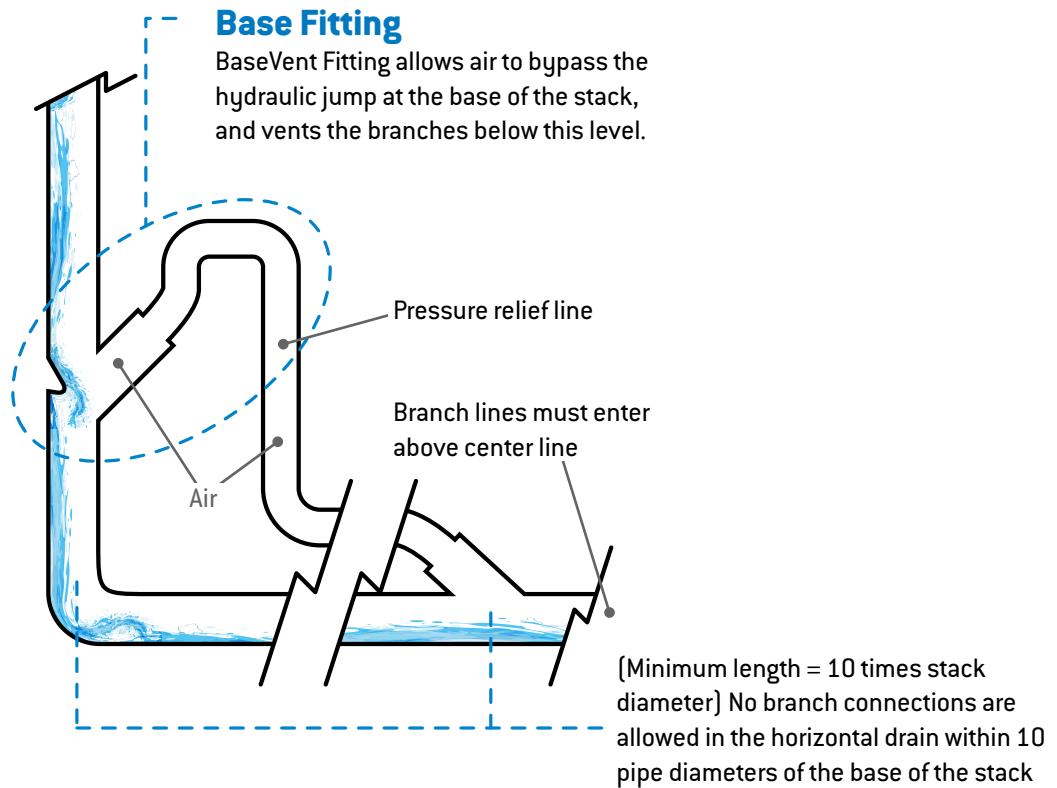

ProVent Stack Fitting

- Unique spring-loaded flapper eliminates the water hammer noise of standard check valves
- Engineered to allow maximum flow from pumps
- Constructed from durable ABS and PVC material
- Solvent weld connections with unions allow for easy and secure installation
- Clear valve body allows visibility to ensure proper operation (Clear items only – 22729)

PRODUCT	DESCRIPTION	MODEL
45500	3" ProVent Stack Fitting, Double Open - Female/Female	P3542SDFF
45501	3" ProVent Stack Fitting, Double Open - Female/Male	P3542SDFM
45502	3" ProVent Stack Fitting, Double Open - Male/Female	P3542SDMF
45503	3" ProVent Stack Fitting, Double Open - Male/Male	P3542SDMM
45504	3" ProVent Stack Fitting, Left Open - Female/Female	P3542SLFF
45505	3" ProVent Stack Fitting, Left Open - Female/Male	P3542SLFM
45506	3" ProVent Stack Fitting, Left Open - Male/Female	P3542SLMF
45507	3" ProVent Stack Fitting, Left Open - Male/Male	P3542SLMM
45508	3" ProVent Stack Fitting, Right Open - Female/Female	P3542SRFF
45509	3" ProVent Stack Fitting, Right Open - Female/Male	P3542SRFM
45510	3" ProVent Stack Fitting, Right Open - Male/Female	P3542SRMF
45511	3" ProVent Stack Fitting, Right Open - Male/Male	P3542SRMM
45512	3" ProVent Stack Fitting, Both Capped - Female/Female	P3542SXFF
45513	4" ProVent Stack Fitting, Double Open - Female/Female	P4542SDFF
45514	4" ProVent Stack Fitting, Double Open - Female/Male	P4542SDFM
45515	4" ProVent Stack Fitting, Double Open - Male/Female	P4542SDMF
45516	4" ProVent Stack Fitting, Double Open - Male/Male	P4542SDMM
45517	4" ProVent Stack Fitting, Left Open - Female/Female	P4542SLFF
45518	4" ProVent Stack Fitting, Left Open - Female/Male	P4542SLFM
45519	4" ProVent Stack Fitting, Left Open - Male/Female	P4542SLMF
45520	4" ProVent Stack Fitting, Left Open - Male/Male	P4542SLMM
45521	4" ProVent Stack Fitting, Right Open - Female/Female	P4542SRFF
45522	4" ProVent Stack Fitting, Right Open - Female/Male	P4542SRFM
45523	4" ProVent Stack Fitting, Right Open - Male/Female	P4542SRMF
45524	4" ProVent Stack Fitting, Right Open - Male/Male	P4542SRMM
45525	4" ProVent Stack Fitting, Both Capped - Female/Female	P4542SXFF
45526	3" X 2" ProVent PVC Base Assembly	P3542B
45527	4" X 3" ProVent PVC Base Assembly	P4542B
45528	3" X 2" Double Wye DWV	P35392
45529	3" EZ Mechanical Coupling (Black)	P35470D
45530	4" EZ Mechanical Coupling (Black)	P45470D
45531	3" EZ Water Tester Device	P35470WT
45532	4" EZ Water Tester Device	P45470WT
45533	3" ProVent Cap	P3542C
45534	4" ProVent Cap	P4542C



45500



45526



45533

Weld-On®

Guy Gray®

Water-Tite®

ToughPans®

RTB

Test-Tite®

AB&A®

Studor®

Truebro®

Christy's®

FloodStop®

ProVent®

ProSet®

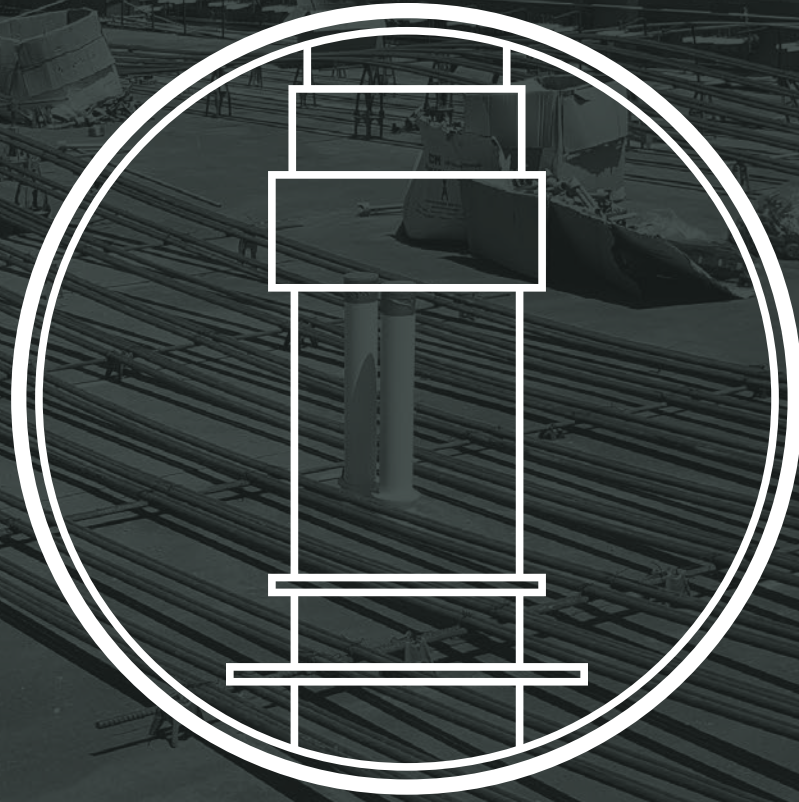

PROSET®

BRAND OVERVIEW

ProSet®

In 2024, IPS Corporation® acquired the ProSet Systems, the oldest and most experienced in firestop devices for the piping trades. The complete line of firestop penetrators equals or surpasses all the current building and life safety codes.

In addition to be Fire-rated, ProSet penetrators provide for pipe expansion and contraction, waterproofs smokeproofs and reduces pipe noise. ProSet out performs any metallic or nonmetallic sleeving. Their versatility and combination function creates remarkable solutions.

Most ProSet firestopping methods are accomplished by simply installing pipe, fittings and hangers. This makes the process of firestopping easy for pipe mechanics to install. The firestopping is automatically done while installing the piping system which improves productivity and fast track scheduling.

ProSet penetrators can also be used in a variety of other non-Fire-rated applications. They are excellent for waterproofing roof penetrations and unique swimming pool inlets and outlets.



ProSet — System "A" For Water, Gas & Electrical Penetrations



46017

System "A" is used mainly for pressure type piping such as water, gas or electrical. Blanks to 1-1/2" pipes pass through the plug & sleeve. The split ProSeal Plug driven into the topside of the sleeve will complete the securing and the firestopping of the pipe. The same process is used with pipes 2" through 10" pipe. However, instead of using the ProSeal Plug, a ProSet Riser Clamp is used. The system can be used with insulated pipe by using an intumescent strip around the bottom of the sleeve.

- Provides a secure, water, smoke, and fire resistant penetration
- Allows for pipe expansion and contraction
- Eliminates clumsy riser clamps
- Reduces pipe noise through the penetration
- Simple system for a pipe mechanic to properly install
- Both metallic and non-metallic pipe.

PRODUCT	DESCRIPTION	MODEL
46015	2" Cast-In Sleeve	P2543HG
46017	2" Cored Sleeve Fits 2-3/4" Hole	P2543HGCH
46018	2" Cast-In Sleeve Coupling	P2543HR
46019	2" Cast-In Sleeve W/Red Extension Coupling	P2543HRC
46020	2" Cored Coupling fits 2-3/4" Hole	P2543HRCH
46021	2" Sleeve w/Red Coupling & Water Ring	P2543HRCR
46022	3" Cored Hole Closet Flange	P3534HCH
46023	3" Closet Flange Spigot End	P3534SX
46024	4" Cast-In Sleeve Pass Through	P4543HB
46025	4" Cast-In Sleeve	P4543HG
46026	4" Cast-In Sleeve w/Green Extension Coupling	P4543HGC
46027	4" Cast-In Sleeve Coupling	P4543HR

ProSet — System "B" For Cast Iron DWV Penetrations



46013

System "B" Penetrations are for cast iron. There are many variations depending on how you want to connect the piping to the sleeve couplings. Choices are usually based upon pipe fabrications and ease of installation. Whatever approach you use, ProSet has a specifically designed penetration sleeve, eliminating the time and nuisance of jury-rigging. Firestopping is accomplished by simply connecting to the sleeve coupling or running the pipe through the sleeve. The penetrations can be used through floors or walls. By using the ProSet sleeves, the piping is much easier to install. All the openings are connected at the same piping the system.

- Provides a water, smoke and fire resistant penetration
- Secures the entire DWV stack & branch piping
- Has a "Fixed Point" fabrication system
- Allows an easy one-man installation
- There is no other firestopping required
- Installs easily, costs less, and produces a much better job.

PRODUCT	DESCRIPTION	MODEL
46013	2" Cast-In Sleeve Pass Through	P2543HB
46028	6" Cast-In Sleeve Coupling	P6543HR
46029	6" Sleeve Coupling w/4" Recess	S6543HR
46030	5" Sleeve w/Extension Coupling	P6843HC
46031	2" Riser Clamp for 2" Cast Iron	A02214CI
46032	2" Stack Stub-In	P2548H
46033	2" x 2" P90 Fire-rated Nipple	P25902
46034	3" x 3" P90 Fire-rated Nipple	P35903
46035	4" x 3" P90 Fire-rated Nipple	P45904
46036	6" Stack Stub-In	P6548H
46037	6" x 6" P90 Fire-rated Nipple	P65906
46038	3" E-Z No-Hub Coupling	S35470

Weld-On®
Guy Gray®
Waater-Tite®
ToughPans®
RTB
Test-Tite®
AB&A®
Studor®
Truebro®
Christy's®
FloodStop®
ProVent®
ProSet®

ProSet — System "C" For PVC DWV Penetrations

System "C" Penetrators for combustible piping are fire protected with a built-in intumescent wrap strip in the bottom portion of the mounting flange. The sleeve coupling extends up from the mounting flange to fit flush with the concrete. They can be used through floors and walls. By using the ProSet sleeves, the piping is much easier to install. As with System "B", all the openings are connected at the same time you are piping the system.

- Provides for water, smoke and fire resistant penetrations
- Eliminates normal pipe expansion and contraction problems
- Secures the entire DWV stack and branch piping
- Has a "Fixed Point" fabrication system
- Allows for an easy, one-man installation
- There is no other firestopping required
- Installs easily, cost less, and produces a much better job

PRODUCT	Description	MODEL
46050	3" E-Z Mechanical Coupling (Blk)	P35470D
46051	3" Stack Stub-In	P3548H
46052	4" Closet Stub For Metal Deck	P4544HCMSX
46053	4" Closet Stub w/Test Cap & Flng	P4544HSX
46054	4" E-Z Flex Coupling	P45470
46055	4" E-Z Mechanical Coupling (Blk)	P45470D
46056	4" Cast-In-Stack Stub	P4548H
46057	4" Closet Stub Less Flange	P4548HSX
46058	Firestop Box for Mixing Valves	P25410P
46059	2" Self-seal Stack Stub-In	P2548HSSW
46060	2" x 10" Cored Hole Self-seal Sleeve	P254910CH
46061	2" x 12" Cored Hole Self-seal Wrap Sleeve	P254912CH
46063	2" x 4-1/2" Cored Hole Self-seal Sleeve	P2549412CH
46064	2" x 8" Cored Hole Self-seal Sleeve	P25498CH
46065	2" Self-seal Pass Through Sleeve	P2549HB
46066	2" Self-seal Sleeve w/Black Extension Coupling	P2549HBC
46067	2" Self-seal Flush Fit Stack Sleeve	P2549HFF
46068	2" Self-seal Pass Through Sleeve	P2549HG
46069	2" Self-seal Sleeve w/Green Extension Coupling	P2549HGC
46070	2" Self-seal Sleeve Corrugated Metal Deck	P2549HGCM
46071	2" Cored Shower Drain Self-seal Wrap w/o Strainer	P2563HCHSSWLS
46072	2" Cast-In Shwr Drain Less Strainer	P2563HLS
46073	2" Cast-In Nb Shower Drain	P2563HNB
46074	2" Cast-In Cp Shower Drain w/Self-seal Wrap	P2563HSSSW
46075	2" Cast-In Sq Cp Shwr Drn w/Self-seal Wrap	P2563HSSWSQCP
46076	2" Cast-In Shwr Drn Self-seal Wrap Less Strn	P2563HSSWLS
46077	2" Cast-In 5" Nb Floor Drain Self-seal Wrap	P2563HXFNBSSW
46078	3" Cast-In Sleeve	P3543HG
46079	3" Cast-In Sleeve w/Green Extension Coupling	P3543HGC
46080	3" Cast-In Sleeve Coupling	P3543HR
46081	3" Self-seal Stack Stub-In	P3548HSSW
46082	3" x 12" Cored Hole Self-seal Wrap Sleeve	P354912CH
46083	3" x 4-1/2" Cored Hole Self-seal Sleeve	P3549412CH
46084	3" x 8" Cored Hole Self-seal Sleeve	P35498CH



46082



46063

continued on next page

ProSet — System "C" For PVC DWV Penetrations (cont.)



46088

PRODUCT	Description	MODEL
46085	3" Self-seal Pass Through Sleeve	P3549HB
46086	3" Self-seal Sleeve W/Ext Coupling	P3549HBC
46087	3" Self-seal Flush Fit Cored Sleeve	P3549HFFCH
46088	3" Self-seal Pass Through Sleeve	P3549HG
46089	3" Self-seal Sleeve W/Grn Ext Cplg	P3549HGC
46090	3" Self-seal Sleeve Cm Deck	P3549HGCM
46091	3" Cast-In Chrome Plated Floor Drain Self-seal Wrap w/5" Top	P3563HXFCPSSW
46092	3" Cast-In Nickle Bronze Floor Drain Self-seal Wrap w/5" NB Square Top	P3563HXFNBSQSSW
46093	3" Cast-In Nickle Bronze Floor Drain Self-seal Wrap w/5" Top	P3563HXFNBSW
46094	4" Self-seal Stack Stub-In	P4548HSSW
46095	4" x 8" Cored Hole Self-seal Sleeve	P45498CH
46096	4" Self-seal Pass Through Sleeve	P4549HB
46097	4" Self-seal Sleeve w/Black Extension Coupling	P4549HBC
46098	4" Self-seal Flush Fit Stack Sleeve	P4549HFF
46099	4" Self-seal 2.5" Recess Stack Sleeve	P4549HFF2.5S
46250	4" Self-seal Pass Through Sleeve	P4549HG
46253	4" Self-seal Sleeve Corrugated Metal Deck	P4549HGCM
46255	6" Cored Hole CHE Assmly in 9" Hole	P6549HBCHE
46256	Precast Shower Drain Cored Hole (w/Tab)	S35498DWT
46257	6" Stack Stub-In Self-seal	S6548HSSW
46262	1/2" Black Concrete Insert	A00112BLK
45285	3" Fire-Rate Sleeve Pipe, Large Inside Diameter	P3B43

Weld-On®
Guy Gray®
Waater-Tite®
ToughPans®
RTB
Test-Tite®
AB&A®
Studor®
Truebro®
Christy's®
FloodStop®
ProVent®
ProSet®

ProSet — System "B & C" For Water, Gas, Electrical and PVC DWV Penetrations

These finished goods can be used in either System B or System C. System "B" Penetrations are for cast iron. There are many variations depending on how you want to connect the piping to the sleeve couplings. System "C" Penetrators for combustible piping are fire protected with a built-in intumescent wrap strip in the bottom portion of the mounting flange. The sleeve coupling extends up from the mounting flange to fit flush with the concrete. They can be used through floors and walls. By using the ProSet sleeves, the piping is much easier to install. As with System "B", all the openings are connected at the same time you are piping the system.



46047

PRODUCT	Description	MODEL
46039	4" Metal Sovent Box w/E-Z Flex	S4542HEZ
46040	4" Metal Sovent Box w/Coupling	S4542HR
46041	4" E-Z No-Hub Coupling	S45470
46042	6" E-Z No-Hub Coupling	S65470
46043	Tub Box w/1" Extra Foam	P2562H1EF
46044	Tub Box w/2" Extra Foam	P2562H2EF
46045	Tub Box 1" Foam w/Red Coupling & Stop	P2562H451EF
46046	Tub Box Assembly For Hambro	P2562HHAM
46047	3" Flush Fit Closet Flange	P35340
46048	3" Closet Stub w/Test Cap & Flng	P3544HSX
46049	3" E-Z Flex Coupling	P35470
46314	2" Coupling NSF - DWV	P25140

Weld-On®
Guy Gray®
Water-Tite®
ToughPans®
RTB
Test-Tite®
AB&A®
Studor®
Truebro®
Christy's®
FloodStop®
ProVent®

INDEX BY PRODUCT NUMBER / 10003 – 46023

Product	Page	Product	Page	Product	Page	Product	Page	Product	Page
10003	32	10160	21	10282	19	12498	18	14111	32
10004	32	10161	21	10283	19	12656	31	14112	32
10005	32	10162	21	10810	32	12658	22	14147	34
10006	32	10163	21	10811	32	12817	25	14550	34
10007	32	10164	23	10812	32	12818	25	15900	16
10008	32	10165	23	10813	32	12891	34	16161	24
10009	32	10166	23	10832	32	13078	22	16162	24
10010	34	10167	23	10833	32	13199	32	16163	24
10012	34	10200	31	10835	179	13360	32	16164	24
10014	34	10201	31	10840	18	13369	28	16165	24
10015	34	10202	31	10841	18	13531	25	16183	17
10050	36	10203	31	10842	18	13750	23	16184	17
10051	36	10204	31	10844	26	13751	23	16185	17
10063	36	10208	29	10845	26	13752	23	16212	29
10064	36	10210	29	10849	21	13753	23	16213	29
10068	36	10212	29	10850	23	13754	23	20000	274
10076	32	10214	29	10871	31	14000	16	20001	274
10077	32	10216	29	10872	31	14001	16	20002	274
10085	20	10220	30	10873	31	14002	16	20003	274
10086	20	10221	30	10874	31	14003	16	20004	274
10089	20	10222	30	10875	31	14004	16	20005	274
10090	20	10223	30	10965	27	14005	16	20006	274
10093	20	10224	30	10966	27	14006	16	20007	274
10094	20	10225	30	10967	27	14007	16	20010	274
10097	20	10226	30	10968	27	14008	16	20011	274
10098	20	10227	30	10969	27	14009	16	20015	274
10100	20	10228	30	10988	18	14010	16	20016	274
10101	20	10229	30	10989	18	14011	16	20020	274
10111	19	10230	27	10990	18	14012	16	20021	274
10112	19	10232	27	11025	24	14013	16	20022	274
10113	19	10233	27	11026	24	14014	16	20052	275
10114	19	10241	27	11027	24	14015	17	20070	275
10115	19	10243	27	11028	24	14016	17	20071	275
10117	21	10244	27	11029	24	14017	17	20072	275
10119	21	10245	27	11248	28	14018	17	20073	275
10121	21	10246	27	11659	26	14019	17	20074	275
10123	21	10247	30	11727	19	14020	17	20075	275
10126	24	10248	30	11831	32	14021	17	20076	275
10127	24	10249	30	11890	26	14022	17	20077	275
10128	24	10250	30	11905	19	14023	17	20078	275
10129	24	10257	28	11957	32	14024	29	20079	275
10130	25	10258	28	11984	18	14025	29	20080	275
10131	25	10259	28	11985	18	14026	29	20081	275
10132	25	10260	28	12071	32	14027	29	20082	275
10134	25	10272	28	12121	32	14028	29	20083	275
10135	25	10273	28	12233	26	14029	29	20084	275
10137	25	10274	28	12429	32	14030	29	20085	275
10155	22	10275	28	12494	18	14031	29	20086	275
10156	22	10278	19	12495	18	14032	29	20087	275
10157	22	10280	19	12496	18	14033	29	20088	275
10159	22	10281	19	12497	18	14108	32	20089	275

Product	Page	Product	Page	Product	Page	Product	Page	Product	Page
20090	275	22403	278	40800	248	46026	294	46078	295
20091	275	22404	278	42443	162	46027	294	46079	295
20092	275	22405	278	42450	162	46028	294	46080	295
20093	275	22406	278	44833	248	46029	294	46081	295
20094	275	22407	278	45285	296	46030	294	46082	295
20095	275	22408	278	45500	291	46031	294	46083	295
20096	275	22409	278	45501	291	46032	294	46084	295
20097	275	22410	278	45502	291	46033	294	46085	296
20297	251	22500	279	45503	291	46034	294	46086	296
20298	248	22501	279	45504	291	46035	294	46087	296
20299	248	22502	279	45505	291	46036	294	46088	296
20300	247	22503	279	45506	291	46037	294	46089	296
20301	247	22504	279	45507	291	46038	294	46090	296
20302	246	22600	280	45508	291	46039	297	46091	296
20340	247	22601	280	45509	291	46040	297	46092	296
20341	247	22700	282	45510	291	46041	297	46093	296
20342	246	22701	282	45511	291	46042	297	46094	296
20344	250	22702	282	45512	291	46043	297	46095	296
20345	251	22703	282	45513	291	46044	297	46096	296
20346	248	22704	282	45514	291	46045	297	46097	296
20349	248	22705	284	45515	291	46046	297	46098	296
20357	250	22706	284	45516	291	46047	297	46099	296
20380	249	22707	284	45517	291	46048	297	46250	296
20381	249	22708	284	45518	291	46049	297	46253	296
20385	249	22709	284	45519	291	46050	295	46255	296
20391	248	22710	285	45520	291	46051	295	46256	296
20398	246	22711	286	45521	291	46052	295	46257	296
20700	251	22712	286	45522	291	46053	295	46262	296
22000	281	22715	285	45523	291	46054	295	46314	297
22001	281	22716	285	45524	291	46055	295	48254	249
22002	281	22717	286	45525	291	46056	295	53990	162
22100	276	22718	287	45526	291	46057	295	53991	163
22101	277	22725	283	45527	291	46058	295	60002	229
22102	276	22726	283	45528	291	46059	295	60005	229
22103	277	22727	283	45529	291	46060	295	60053	175
22201	276	22728	283	45530	291	46061	295	60063	216
22202	276	22729	283	45531	291	46063	295	60064	215
22205	276	22730	283	45532	291	46064	295	60090	215
22208	276	22731	284	45533	291	46065	295	60093	175
22209	276	22732	284	45534	291	46066	295	60094	215
22212	276	22733	283	46013	294	46067	295	60095	215
22213	276	22734	283	46015	294	46068	295	60096	215
22214	276	22735	287	46017	294	46069	295	60097	215
22215	276	22736	282	46018	294	46070	295	60098	215
22304	277	22738	282	46019	294	46071	295	60099	215
22306	277	22739	283	46020	294	46072	295	60104	200
22308	277	22743	282	46021	294	46073	295	60107	200
22309	277	22801	279	46022	294	46074	295	60108	199
22310	277	22802	280	46023	294	46075	295	60110	200
22400	278	22900	280	46024	294	46076	295	60111	199
22402	278	22901	280	46025	294	46077	295	60114	200

INDEX BY PRODUCT NUMBER / 63127 – 67154

Product	Page	Product	Page	Product	Page	Product	Page	Product	Page
60115	199	60514	231	61038	193	61221	203	61723	207
60116	199	60525	237	61040	189	61224	203	61731	181
60122	215	60527	237	61041	193	61226	182	61741	182
60123	215	60528	237	61042	189	61231	180	61758	180
60169	200	60533	237	61043	193	61236	182	61783	189
60170	199	60535	237	61046	208	61237	180	61784	189
60171	200	60540	237	61047	203	61245	204	61793	189
60173	199	60541	237	61050	187	61246	204	61799	189
60174	200	60542	237	61051	205	61249	204	61825	193
60177	200	60543	237	61052	206	61251	204	61864	201
60185	200	60544	237	61053	206	61256	206	61875	201
60186	200	60545	237	61054	189	61258	205	61885	201
60187	199	60567	220	61101	211	61262	206	61977	202
60200	230	60568	220	61102	211	61263	206	61978	202
60210	228	60705	203	61103	211	61264	206	61986	183
60213	229	60706	203	61122	208	61268	189	61988	183
60214	229	60713	202	61123	208	61270	205	61991	181
60218	229	60734	202	61125	208	61275	205	61992	183
60219	229	60887	205	61126	211	61281	189	61993	183
60220	229	60917	205	61127	211	61287	189	61994	183
60222	229	60921	206	61128	208	61288	189	61995	202
60226	229	60924	205	61129	208	61289	189	61996	202
60227	230	60925	165	61138	208	61292	189	61997	183
60231	230	60937	205	61140	211	61293	189	61998	182
60232	230	60948	180	61141	211	61294	189	61999	183
60233	230	60949	237	61142	211	61295	189	62000	184
60254	200	60954	237	61144	208	61297	189	62001	183
60255	200	60955	237	61145	208	61301	189	62002	183
60300	228	61000	211	61153	212	61302	189	62003	183
60309	228	61001	203	61154	212	61303	193	62004	183
60321	199	61002	207	61155	209	61306	193	62005	183
60322	199	61003	207	61157	209	61327	200	62006	183
60323	200	61004	207	61158	209	61415	180	62007	184
60324	200	61005	203	61162	212	61444	211	62008	184
60325	199	61006	203	61163	212	61445	210	62009	184
60326	199	61007	208	61165	209	61446	210	62012	183
60327	199	61008	208	61166	209	61494	203	62013	184
60328	199	61009	208	61175	213	61637	189	62014	184
60345	200	61010	208	61181	215	61638	207	62015	183
60400	230	61013	203	61191	207	61659	203	62016	184
60401	230	61014	203	61192	207	61666	180	62017	184
60402	230	61016	203	61193	207	61679	206	62018	195
60403	230	61022	200	61198	202	61687	209	62021	190
60405	230	61023	182	61199	202	61692	204	62022	190
60406	230	61024	182	61202	202	61694	209	62023	190
60414	230	61025	182	61203	202	61711	189	62024	190
60415	230	61026	189	61206	203	61715	180	62026	190
60500	231	61029	189	61207	203	61716	204	62027	190
60501	231	61030	189	61209	203	61717	211	62029	190
60502	231	61031	208	61210	202	61718	210	62030	191
60512	231	61034	189	61217	202	61722	204	62032	191

Product	Page	Product	Page	Product	Page	Product	Page	Product	Page
62033	191	62190	191	62429	194	63102	193	63500	166
62034	196	62191	191	62436	195	63105	193	63501	166
62036	195	62197	191	62439	195	63106	193	63600	167
62037	184	62198	191	62441	195	63120	199	63601	167
62038	184	62199	191	62442	190	63126	219	63602	168
62039	191	62202	194	62444	190	63127	219	63603	169
62040	191	62203	194	62454	191	63168	198	63604	170
62041	192	62205	194	62461	194	63173	219	63605	170
62042	192	62207	194	62480	183	63207	213	63606	170
62043	196	62212	195	62486	183	63208	213	63607	167
62044	192	62216	195	62487	184	63211	213	63608	167
62045	195	62219	195	62489	183	63224	213	63609	168
62048	191	62223	195	62492	186	63228	213	63610	169
62050	192	62236	187	62493	187	63242	199	63611	170
62051	192	62244	180	62497	186	63246	188	63612	167
62054	192	62249	186	62501	183	63250	188	63613	167
62055	196	62250	192	62510	196	63251	188	63614	167
62058	191	62262	184	62565	190	63255	188	63615	167
62059	191	62264	187	62815	194	63260	188	63616	167
62062	195	62271	187	62818	194	63261	188	63617	167
62066	195	62273	187	62915	183	63262	188	63618	167
62070	186	62276	185	62934	190	63263	188	63619	167
62072	186	62278	185	62958	190	63276	188	63620	167
62073	186	62280	184	62970	191	63281	188	63621	167
62074	186	62281	183	62972	196	63282	188	63622	169
62075	186	62282	184	62982	191	63283	188	63623	169
62076	186	62283	183	62988	196	63285	188	63624	169
62078	186	62286	184	63000	216	63287	188	63625	169
62082	187	62287	183	63001	220	63300	201	63626	168
62084	187	62288	191	63002	220	63302	201	63627	168
62087	187	62289	190	63004	219	63306	201	63628	168
62088	186	62291	186	63005	219	63309	201	63629	168
62092	184	62292	186	63015	197	63312	201	63630	168
62093	184	62295	194	63016	197	63324	219	63631	168
62094	182	62296	194	63019	197	63333	198	63632	168
62096	187	62297	186	63021	197	63342	188	63633	168
62104	183	62298	186	63055	199	63348	165	63634	168
62109	183	62299	194	63056	199	63349	171	63635	170
62117	184	62300	187	63060	219	63359	198	63636	170
62124	184	62301	187	63066	219	63360	198	63637	170
62127	183	62305	195	63071	219	63374	213	63638	170
62139	180	62313	194	63072	219	63386	193	63639	168
62142	185	62325	187	63073	219	63387	193	63641	167
62145	185	62339	191	63074	219	63391	193	63642	167
62164	190	62346	195	63077	219	63392	193	63643	167
62169	190	62350	196	63080	219	63394	193	63644	169
62171	190	62374	186	63084	193	63396	193	63645	170
62172	190	62400	190	63085	193	63400	198	63646	167
62176	192	62412	191	63090	197	63408	180	63647	169
62182	192	62416	191	63094	197	63490	166	63648	170
62183	191	62421	195	63095	197	63491	166	63649	168

INDEX BY PRODUCT NUMBER / 69367 – 81592

Product	Page	Product	Page	Product	Page	Product	Page	Product	Page
63650	168	64040	213	64978	197	65569	182	66106	239
63651	168	64043	213	64991	165	65599	181	66107	240
63652	168	64044	213	65002	232	65600	217	66108	240
63660	170	64048	197	65003	233	65601	181	66109	240
63661	169	64050	197	65300	233	65602	185	66110	240
63662	169	64051	197	65301	233	65603	185	66111	240
63663	169	64052	197	65303	234	65604	191	66112	240
63664	169	64053	197	65317	233	65605	196	66113	240
63665	169	64054	188	65319	232	65606	181	66114	240
63666	169	64055	188	65323	233	65607	181	66115	240
63667	170	64056	188	65326	233	65608	181	66116	240
63668	170	64058	188	65362	162	65609	181	66117	240
63669	170	64059	188	65363	162	65610	186	66118	241
63694	172	64102	208	65365	234	65800	231	66119	241
63695	172	64198	208	65493	232	65801	237	66120	241
63696	172	64205	208	65500	217	65802	237	66121	241
63800	171	64212	208	65501	181	65804	232	66122	241
63801	172	64219	208	65502	185	65805	233	66123	241
63802	171	64238	209	65503	185	65806	233	66124	241
63803	172	64257	209	65504	191	65810	235	66125	241
63804	171	64264	209	65505	196	66000	239	66126	241
63805	171	64299	209	65506	181	66001	239	66127	241
63806	171	64306	209	65508	181	66002	239	66128	241
63807	172	64410	211	65509	181	66003	239	66129	241
63808	172	64414	211	65510	181	66004	240	66130	241
63809	172	64421	211	65513	186	66005	240	66131	241
63810	171	64435	211	65540	181	66006	240	66132	241
63811	171	64502	207	65541	181	66007	240	66133	241
63812	171	64519	207	65542	181	66008	240	66134	241
63813	172	64538	210	65543	181	66009	240	66135	241
63814	172	64576	210	65544	181	66010	240	66136	241
63815	172	64587	210	65545	181	66011	240	66137	241
64000	199	64591	210	65546	181	66012	242	66138	241
64001	199	64598	210	65547	181	66013	242	66139	241
64002	193	64612	210	65548	181	66014	242	66140	241
64003	193	64648	227	65549	181	66015	242	66141	241
64004	193	64917	198	65550	181	66016	242	66142	241
64005	197	64925	198	65551	182	66017	242	66143	241
64008	198	64929	198	65552	182	66018	242	66144	241
64009	198	64930	198	65553	182	66019	242	66145	242
64010	193	64932	198	65554	182	66020	242	66146	242
64011	193	64933	198	65555	182	66021	242	66147	242
64015	198	64936	213	65556	182	66022	242	66148	242
64016	197	64938	213	65557	182	66023	239	66149	242
64017	197	64939	213	65558	182	66024	239	66150	242
64019	198	64940	213	65559	182	66100	239	66151	242
64021	198	64941	213	65560	182	66101	239	66152	242
64023	198	64944	213	65565	182	66102	239	66153	242
64026	198	64946	198	65566	182	66103	239	66200	238
64036	213	64969	193	65567	182	66104	239	66201	238
64039	213	64976	197	65568	182	66105	239	66202	238

Product	Page	Product	Page	Product	Page	Product	Page	Product	Page
66203	238	67076	166	67927	243	68376	221	68605	224
66204	238	67100	231	67928	243	68377	221	68650	224
66205	238	67136	176	67929	243	68382	221	68651	224
66206	238	67138	176	67930	243	68400	223	68652	224
66207	238	67140	176	67991	243	68401	223	68653	224
66208	238	67144	176	67993	187	68402	223	68654	224
66209	238	67146	176	67994	187	68403	223	68655	224
66210	238	67147	176	67995	187	68404	223	68656	224
66211	238	67148	176	67996	187	68407	226	68657	224
66212	238	67149	176	68004	162	68419	219	68658	224
66213	238	67154	177	68005	162	68450	223	68659	224
66214	238	67155	178	68038	186	68451	223	68683	214
66215	238	67159	177	68043	219	68452	223	68684	214
66216	238	67160	177	68052	218	68453	223	68685	186
66217	238	67161	178	68066	217	68454	223	68700	225
66218	238	67175	177	68068	165	68455	223	68701	225
66219	238	67177	173	68075	219	68457	217	68702	225
66220	238	67178	173	68079	217	68480	223	68703	225
66221	238	67179	173	68080	215	68481	223	68750	225
66828	219	67190	174	68090	219	68482	223	68751	225
67000	176	67192	174	68102	232	68490	227	68752	227
67001	176	67193	174	68120	215	68491	227	68753	225
67002	176	67196	174	68137	215	68492	225	68754	225
67003	176	67197	174	68138	215	68493	227	68755	227
67012	164	67205	175	68143	220	68494	227	68756	227
67013	164	67206	175	68184	215	68500	225	68757	227
67014	164	67207	175	68198	219	68501	225	68758	227
67015	164	67218	164	68210	186	68502	225	68759	227
67016	164	67240	175	68215	220	68503	225	68760	227
67017	164	67271	178	68239	175	68504	225	68761	227
67018	164	67298	165	68243	218	68505	225	68762	221
67021	164	67309	171	68246	220	68506	226	68800	225
67022	164	67312	171	68254	219	68507	226	68801	225
67023	178	67315	171	68261	175	68508	226	68802	225
67024	178	67317	171	68300	222	68509	226	68812	224
67025	178	67331	171	68301	222	68510	226	68813	223
67028	173	67900	243	68302	222	68511	226	68819	223
67029	173	67901	243	68304	221	68512	226	68820	223
67032	166	67902	243	68308	221	68513	226	68823	223
67033	235	67903	243	68309	221	68514	226	68827	225
67034	235	67904	243	68310	222	68515	226	68828	224
67035	235	67905	243	68313	222	68516	226	68830	224
67036	235	67906	243	68319	221	68517	226	68831	224
67037	173	67908	243	68343	221	68518	226	68832	224
67038	173	67909	243	68349	221	68550	227	68833	224
67039	173	67913	243	68355	221	68551	220	68834	225
67040	164	67915	243	68356	221	68600	224	68837	225
67041	164	67920	243	68361	221	68601	224	68839	225
67042	164	67922	243	68363	221	68602	224	68843	225
67044	174	67925	243	68364	221	68603	224	68845	225
67065	164	67926	243	68375	221	68604	224	68846	225

INDEX BY PRODUCT NUMBER / 83632 – 86994

Product	Page	Product	Page	Product	Page	Product	Page	Product	Page
68850	216	69258	224	69543	167	69658	220	69926	188
68853	226	69262	223	69544	167	69661	220	69930	243
68854	226	69264	187	69546	167	69662	220	69957	220
68855	226	69267	224	69552	174	69664	220	69989	220
68856	226	69284	224	69554	165	69668	216	69990	220
68857	226	69289	174	69555	165	69685	176	69991	220
68858	226	69290	224	69560	165	69686	176	69992	220
68859	226	69291	224	69567	217	69688	165	69993	220
68860	226	69333	218	69568	217	69689	165	69994	220
68861	226	69334	218	69569	176	69705	237	69998	216
68864	225	69336	218	69570	217	69723	201	80100	37
68866	227	69337	218	69571	217	69725	201	80103	37
68867	227	69338	218	69572	217	69726	201	80105	37
68869	223	69342	218	69574	223	69727	201	80111	37
68870	223	69351	219	69575	223	69742	201	80200	35
68871	223	69357	219	69578	216	69743	201	80310	37
68872	225	69367	219	69580	217	69744	201	80315	37
69000	215	69369	219	69582	217	69746	201	80320	37
69016	218	69372	220	69589	220	69767	218	80325	37
69017	219	69373	219	69590	220	69769	218	80420	38
69054	188	69375	220	69591	220	69770	165	80421	38
69055	188	69380	220	69594	220	69771	243	80424	38
69056	188	69420	228	69595	220	69773	165	80425	38
69057	188	69430	228	69596	220	69774	165	80427	39
69058	188	69435	228	69597	217	69776	165	80600	134
69082	187	69440	228	69598	217	69778	225	80601	134
69087	187	69493	187	69601	186	69779	225	80603	137
69096	187	69494	187	69602	217	69780	226	80604	137
69128	174	69495	187	69604	216	69799	172	80605	136
69130	174	69498	187	69605	222	69802	172	80606	136
69155	165	69500	165	69607	216	69803	172	80607	134
69159	174	69501	216	69611	216	69804	172	80608	137
69181	165	69502	216	69614	176	69808	218	80609	137
69195	172	69503	216	69615	176	69809	216	80610	137
69202	165	69504	216	69622	217	69835	167	80611	136
69203	165	69505	216	69638	218	69840	175	80890	38
69204	165	69508	222	69639	218	69842	201	81255	36
69207	232	69509	222	69640	218	69850	172	81352	38
69208	232	69510	214	69642	218	69900	216	81400	38
69209	232	69511	222	69643	218	69906	184	81405	38
69212	232	69512	218	69644	218	69907	184	81410	38
69214	232	69513	216	69645	218	69908	184	81411	125
69215	232	69514	216	69646	218	69909	184	81412	125
69223	237	69516	216	69647	218	69910	187	81413	125
69224	237	69520	218	69648	218	69911	184	81414	125
69228	232	69521	165	69649	218	69912	184	81415	125
69232	177	69524	165	69652	220	69913	184	81416	125
69245	237	69529	167	69653	220	69914	184	81417	125
69246	237	69530	165	69654	220	69915	184	81418	125
69254	223	69536	165	69655	220	69916	184	81419	125
69257	224	69541	167	69656	220	69917	184	81420	125

Product	Page	Product	Page	Product	Page	Product	Page	Product	Page
81421	125	81477	119	81715	117	81937	120	82069	74
81422	125	81478	119	81716	117	81942	117	82107	71
81423	125	81494	120	81721	121	81957	42	82112	48
81424	125	81495	120	81723	116	81959	51	82113	49
81425	125	81496	120	81725	121	81974	42	82114	48
81426	125	81499	120	81730	121	81975	42	82115	49
81427	125	81500	38	81731	120	81977	74	82116	48
81428	125	81505	38	81732	120	81978	43	82117	49
81429	125	81560	38	81735	121	81979	46	82118	49
81430	125	81565	38	81739	121	81998	72	82119	49
81431	125	81575	122	81740	121	81999	72	82120	49
81432	125	81576	122	81741	121	82000	71	82121	49
81433	125	81577	122	81742	121	82001	71	82122	50
81434	125	81578	122	81743	121	82002	71	82135	47
81435	125	81579	122	81744	121	82003	74	82136	47
81436	125	81580	122	81745	120	82004	74	82137	47
81437	125	81585	122	81750	117	82008	71	82138	47
81438	125	81586	122	81751	117	82013	71	82139	47
81439	126	81587	123	81753	126	82017	71	82140	47
81440	126	81588	123	81755	117	82026	42	82142	44
81441	126	81589	123	81756	117	82028	43	82144	46
81442	126	81590	123	81760	117	82030	44	82145	47
81443	126	81591	123	81765	117	82031	44	82146	50
81444	126	81592	122	81800	117	82032	42	82147	47
81445	126	81593	122	81805	117	82033	42	82148	48
81450	127	81597	123	81810	117	82034	43	82150	234
81451	127	81598	123	81815	117	82035	44	82151	234
81452	127	81601	123	81820	119	82036	42	82152	48
81453	127	81602	123	81821	119	82037	42	82153	48
81455	119	81610	38	81822	119	82038	43	82154	50
81456	119	81620	38	81823	119	82039	44	82157	48
81457	119	81625	38	81824	119	82040	45	82158	47
81458	119	81630	38	81825	119	82041	46	82159	47
81459	119	81635	38	81826	119	82042	46	82161	50
81460	119	81640	38	81828	120	82043	44	82162	50
81461	119	81651	38	81829	120	82044	45	82165	49
81462	119	81680	124	81830	120	82045	46	82170	50
81463	119	81681	124	81845	119	82046	46	82171	50
81464	119	81682	124	81850	118	82047	45	82172	50
81465	119	81684	124	81855	118	82048	45	82174	50
81466	119	81694	123	81860	118	82052	71	82184	49
81467	119	81695	123	81865	118	82053	71	82187	258
81468	119	81696	123	81870	118	82054	71	82188	254
81469	119	81697	123	81879	118	82055	71	82189	254
81470	119	81698	123	81881	116	82056	71	82190	254
81471	119	81700	116	81885	117	82057	71	82191	254
81472	119	81705	116	81900	118	82064	74	82192	254
81473	119	81707	116	81905	118	82065	74	82193	254
81474	119	81709	116	81910	118	82066	74	82194	254
81475	119	81710	116	81915	118	82067	74	82195	254
81476	119	81711	116	81916	118	82068	74	82196	254

INDEX BY PRODUCT NUMBER / 514003 – 61123

Product	Page	Product	Page	Product	Page	Product	Page	Product	Page
82197	254	82335	236	82397	60	82559	163	82721	258
82198	254	82336	236	82398	60	82560	163	82722	258
82199	254	82338	235	82399	60	82561	163	82723	258
82200	254	82339	235	82401	257	82563	163	82726	258
82201	254	82340	48	82404	257	82565	163	82727	258
82202	256	82341	48	82405	164	82566	163	82728	258
82203	256	82342	48	82408	61	82567	54	82731	258
82204	256	82343	48	82409	61	82569	54	82732	258
82205	256	82344	48	82411	61	82571	54	82733	258
82206	256	82345	48	82412	61	82573	54	82736	258
82207	256	82346	48	82413	61	82575	54	82741	258
82208	256	82348	48	82414	61	82577	54	82746	71
82209	256	82353	47	82415	61	82579	54	82747	71
82210	256	82354	47	82416	61	82581	54	82748	72
82211	256	82355	56	82417	62	82583	55	82749	72
82212	256	82356	56	82418	62	82585	55	82752	74
82213	256	82357	56	82419	62	82587	55	82753	74
82214	256	82358	56	82420	62	82589	55	82754	75
82215	256	82359	56	82421	62	82591	55	82755	75
82216	257	82360	56	82422	62	82593	55	82760	83
82217	257	82361	56	82423	62	82631	45	82761	83
82218	257	82362	56	82424	62	82632	43	82762	87
82219	257	82363	57	82425	66	82633	42	82763	87
82220	257	82364	57	82426	66	82634	43	82764	87
82221	257	82365	57	82427	66	82635	44	82765	87
82222	257	82366	57	82428	66	82636	42	82766	87
82223	257	82367	57	82446	63	82637	43	82767	87
82224	257	82368	57	82448	63	82639	46	82768	87
82225	257	82369	57	82451	72	82640	46	82769	87
82226	257	82370	57	82453	72	82643	66	82771	76
82228	257	82371	58	82456	63	82644	66	82772	76
82229	257	82372	58	82458	64	82645	66	82773	77
82234	255	82373	58	82472	49	82646	66	82774	77
82236	255	82374	58	82480	47	82647	66	82821	79
82292	258	82375	58	82481	47	82648	66	82822	79
82306	48	82376	58	82521	259	82650	237	82823	79
82307	50	82377	58	82522	259	82652	237	82824	79
82308	74	82378	58	82523	259	82655	237	82830	111
82311	47	82379	59	82524	259	82660	237	82831	111
82314	49	82380	59	82525	259	82668	45	82832	111
82320	235	82381	59	82527	259	82669	46	82833	111
82321	71	82382	59	82528	259	82670	46	82834	111
82322	71	82383	59	82550	163	82671	44	82835	111
82324	257	82384	59	82551	163	82678	46	82836	111
82325	235	82389	61	82552	163	82679	43	82837	111
82327	50	82390	60	82553	163	82680	46	82838	111
82330	235	82392	60	82554	163	82681	53	82839	111
82331	236	82393	60	82555	163	82688	66	82840	106
82332	236	82394	60	82556	163	82689	66	82841	108
82333	236	82395	60	82557	163	82690	66	82842	108
82334	236	82396	60	82558	163	82691	66	82843	111

Product	Page	Product	Page	Product	Page	Product	Page	Product	Page
82844	111	82930	94	83020	91	83077	100	83196	86
82845	106	82931	94	83021	92	83078	100	83197	86
82846	106	82932	94	83021	92	83079	100	83198	86
82850	106	82933	94	83022	94	83080	100	83199	86
82852	108	82934	94	83025	113	83081	100	83200	133
82854	108	82935	94	83027	91	83082	100	83202	133
82855	106	82936	94	83028	92	83083	100	83203	133
82856	108	82937	94	83029	94	83084	100	83205	133
82860	106	82938	93	83030	113	83085	102	83206	86
82864	106	82939	96	83035	113	83086	99	83207	86
82865	106	82940	96	83036	98	83087	99	83208	86
82890	91	82941	96	83037	98	83088	102	83211	141
82891	91	82942	96	83038	98	83089	102	83212	141
82892	91	82943	97	83039	98	83090	102	83216	141
82893	91	82944	97	83040	98	83091	102	83218	141
82894	91	82945	88	83041	98	83092	101	83225	141
82895	91	82946	88	83042	98	83093	101	83234	141
82896	91	82947	88	83043	98	83094	101	83246	141
82897	91	82951	107	83044	98	83095	101	83248	141
82898	91	82953	91	83045	98	83096	101	83250	114
82899	91	82954	92	83046	98	83097	101	83252	114
82900	91	82955	107	83047	98	83098	101	83253	114
82901	91	82957	106	83048	98	83099	101	83255	114
82902	91	82958	91	83049	98	83123	142	83261	141
82903	91	82959	91	83050	98	83130	112	83268	141
82904	91	82960	107	83051	98	83134	142	83282	141
82905	91	82961	107	83052	99	83135	112	83300	114
82906	92	82962	107	83053	99	83146	142	83301	114
82907	92	82963	107	83054	99	83166	91	83302	114
82908	92	82965	109	83055	99	83167	91	83310	86
82909	92	82966	109	83056	99	83168	91	83311	86
82910	92	82967	109	83057	99	83169	91	83312	86
82911	92	82969	91	83058	99	83172	92	83313	86
82912	92	82970	109	83059	99	83173	92	83314	86
82913	92	82971	109	83060	99	83174	92	83315	86
82914	92	82972	106	83061	99	83175	92	83316	86
82915	92	82973	91	83062	99	83180	133	83317	86
82916	92	82974	88	83063	99	83181	133	83321	99
82917	92	82975	109	83064	99	83183	96	83325	99
82918	92	82977	97	83065	99	83184	96	83326	98
82919	92	82979	106	83066	99	83185	96	83327	98
82920	92	82980	107	83067	99	83186	96	83328	98
82921	92	82981	107	83068	99	83187	95	83329	98
82922	94	82982	107	83069	100	83188	95	83332	99
82923	94	83003	108	83070	100	83189	95	83333	99
82924	94	83008	108	83071	100	83190	95	83334	99
82925	94	83010	108	83072	100	83191	95	83335	99
82926	94	83012	108	83073	100	83192	95	83338	100
82927	94	83013	108	83074	100	83193	95	83339	100
82928	94	83014	108	83075	100	83194	95	83340	100
82929	94	83015	106	83076	100	83195	86	83341	100

INDEX BY PRODUCT NUMBER / 63664 – 82225

Product	Page	Product	Page	Product	Page	Product	Page	Product	Page
83346	100	83470	153	83654	143	83791	148	84356	105
83347	102	83471	153	83656	148	83792	148	84357	105
83348	102	83472	153	83657	148	83795	107	84358	105
83349	102	83473	153	83658	148	83797	107	84359	105
83350	114	83474	153	83659	148	83798	107	84360	105
83352	114	83475	153	83660	148	83799	107	84361	105
83353	114	83500	146	83661	143	83800	107	84362	105
83354	114	83505	146	83662	143	83802	144	84363	105
83355	114	83510	146	83663	143	83803	155	84364	105
83357	114	83515	146	83664	143	83805	107	84365	105
83360	114	83542	142	83671	143	83816	144	84366	105
83361	114	83543	142	83672	143	83818	144	84368	105
83365	114	83544	142	83673	143	83824	144	84369	105
83366	114	83551	140	83674	143	83860	144	84370	105
83367	114	83552	140	83675	143	83861	144	84371	105
83369	114	83553	140	83676	143	83865	144	84372	105
83370	56	83554	140	83678	143	83877	144	84373	105
83371	58	83556	140	83680	143	83921	146	85000	154
83372	98	83557	140	83682	143	83922	146	85005	154
83373	99	83581	140	83685	143	83923	146	85010	154
83374	61	83582	140	83687	150	83948	145	85015	154
83375	62	83583	140	83688	150	83962	145	85125	73
83378	94	83584	140	83689	150	83968	145	85131	71
83379	94	83585	140	83690	150	83974	145	85132	71
83380	94	83586	140	83692	146	83975	145	85150	243
83381	94	83587	140	83693	146	83976	145	85152	243
83384	86	83588	140	83695	146	83978	145	85155	243
83386	86	83591	149	83696	146	83979	145	85450	154
83388	98	83592	149	83697	146	83981	145	85455	154
83389	99	83593	149	83698	146	84000	115	85460	154
83390	100	83594	149	83700	147	84005	115	85465	154
83400	115	83595	149	83703	146	84010	115	85530	179
83404	115	83596	149	83706	155	84025	113	85604	71
83405	115	83597	149	83710	147	84030	113	85610	71
83407	115	83598	149	83711	155	84048	145	85614	71
83409	115	83599	149	83712	155	84055	36	85630	71
83410	115	83625	141	83713	155	84082	145	85632	71
83411	115	83626	141	83714	155	84118	145	85637	71
83412	115	83628	141	83732	147	84124	145	85638	71
83413	115	83630	141	83733	147	84146	145	85682	71
83416	115	83632	141	83734	147	84147	145	85701	72
83417	115	83633	141	83735	147	84148	145	85702	72
83418	115	83635	141	83761	144	84149	145	85703	72
83419	115	83642	142	83782	148	84151	145	85704	72
83440	179	83643	142	83783	148	84152	145	85706	72
83445	179	83644	142	83784	148	84350	105	85707	72
83446	179	83646	142	83785	148	84351	105	85708	75
83447	179	83649	148	83787	148	84352	105	85709	75
83448	179	83651	143	83788	148	84353	105	85711	75
83449	179	83652	143	83789	148	84354	105	85712	75
83450	179	83653	143	83790	148	84355	105	85714	72

Product	Page	Product	Page	Product	Page	Product	Page	Product	Page
85716	75	86125	236	86245	160	86672	104	87033	131
85717	72	86126	158	86246	160	86673	104	87035	131
85718	72	86127	158	86247	160	86675	104	87041	131
85719	72	86128	158	86248	160	86685	104	87074	131
85722	75	86130	158	86310	237	86690	104	87090	130
85723	72	86131	158	86315	151	86694	104	87091	130
85738	75	86132	158	86320	151	86696	104	87092	130
85739	75	86133	162	86335	151	86698	104	87093	130
85741	71	86135	158	86340	151	86699	104	87094	130
85742	71	86137	158	86345	151	86701	104	87095	130
85748	72	86140	158	86350	151	86702	104	87110	130
85749	72	86141	159	86355	151	86703	104	87111	130
85773	75	86142	159	86375	150	86704	104	87112	130
85802	50	86145	158	86385	150	86718	113	87113	130
85815	234	86147	160	86390	150	86726	113	87114	130
85816	234	86148	160	86395	150	86832	113	87115	130
85820	234	86149	158	86400	150	86970	132	87116	130
85825	234	86150	158	86420	150	86975	132	87117	130
85830	234	86151	158	86425	150	86976	132	87118	130
85835	234	86155	158	86435	150	86979	132	87119	130
85840	234	86160	158	86455	150	86980	132	87120	130
85855	234	86161	50	86520	151	86981	132	87121	130
85895	232	86162	50	86526	151	86984	132	87122	130
85905	233	86163	50	86535	151	86985	132	87123	130
85910	233	86164	50	86545	151	86986	132	87124	130
85916	227	86165	159	86590	103	86989	132	87125	130
85918	227	86166	159	86592	103	86990	132	87126	130
85919	227	86170	159	86593	103	86991	132	87127	130
85940	234	86173	159	86595	103	86994	132	87203	74
85945	234	86175	159	86596	103	86995	132	87204	74
85950	234	86177	159	86598	103	86996	132	87349	76
85951	234	86178	159	86599	103	86997	132	87351	76
85955	234	86179	159	86600	103	86998	132	87353	76
85960	234	86180	159	86601	103	86999	132	87355	76
85961	234	86181	160	86603	103	87000	131	87357	76
85965	234	86182	159	86604	103	87001	131	87359	76
86010	236	86185	159	86614	113	87002	131	87361	76
86050	164	86186	160	86615	154	87003	131	87363	76
86055	164	86187	161	86618	113	87004	131	87365	76
86095	236	86191	161	86619	113	87005	131	87367	77
86096	236	86192	161	86620	154	87006	131	87371	77
86097	236	86193	161	86621	103	87007	131	87373	77
86100	236	86194	161	86624	103	87008	131	87374	77
86105	236	86196	160	86626	113	87010	131	87378	76
86106	236	86197	160	86632	113	87011	131	87379	76
86107	236	86198	160	86650	104	87012	131	87380	77
86110	236	86199	160	86651	104	87013	131	87382	76
86115	236	86201	160	86652	104	87014	131	87383	76
86120	236	86203	160	86653	104	87015	131	87384	76
86121	236	86208	162	86655	104	87030	131	87385	76
86122	236	86209	162	86670	104	87031	131	87386	76

INDEX BY PRODUCT NUMBER / 82982 – 87371

Product	Page	Product	Page	Product	Page	Product	Page	Product	Page
87388	77	87800	38	88008	79	88489	80	88759	89
87389	77	87805	38	88017	79	88490	81	88760	89
87390	77	87860	85	88068	80	88491	80	88761	89
87398	76	87861	85	88106	84	88492	80	88762	89
87400	77	87862	85	88107	84	88493	80	88763	89
87401	77	87887	64	88112	64	88494	80	88764	89
87404	77	87888	64	88133	51	88495	81	88769	90
87405	76	87889	64	88158	51	88496	80	88770	90
87407	77	87934	83	88164	52	88497	80	88771	90
87408	77	87935	83	88170	89	88498	81	88772	90
87409	77	87937	83	88177	52	88510	51	88800	90
87417	76	87938	83	88178	51	88512	51	88801	90
87418	77	87939	65	88182	79	88513	52	88804	90
87435	76	87940	65	88242	89	88514	51	88806	90
87503	153	87944	65	88259	89	88515	52	88807	90
87505	153	87952	79	88260	89	88517	51	88825	90
87510	153	87953	79	88261	89	88521	53	88826	90
87515	153	87954	79	88262	89	88522	53	88827	90
87516	153	87955	79	88285	88	88523	53	88828	89
87526	154	87958	79	88290	88	88524	53	88829	89
87527	154	87959	79	88311	88	88525	53	88830	90
87528	154	87960	83	88312	88	88526	53	88838	89
87529	154	87961	83	88313	88	88527	53	88839	89
87531	152	87962	83	88371	133	88528	53	88840	90
87532	152	87964	65	88372	81	88530	51	89075	133
87533	152	87965	65	88373	81	88531	52	89148	109
87534	152	87966	65	88374	82	88532	51	89150	109
87536	152	87967	79	88376	81	88533	52	89151	109
87537	152	87968	79	88377	81	88534	51	89152	109
87660	35	87969	79	88378	81	88535	51	89158	110
87665	35	87970	79	88379	81	88536	89	89160	110
87670	35	87971	79	88380	81	88537	89	89161	110
87685	35	87972	79	88381	81	88538	90	89165	110
87690	35	87973	79	88382	82	88559	81	89166	110
87695	35	87974	79	88384	149	88650	88	89266	88
87705	39	87978	79	88386	149	88651	88	89267	88
87710	39	87979	79	88387	149	88652	88	89275	88
87715	39	87980	79	88388	149	88721	89	89277	88
87717	39	87981	79	88389	149	88722	89	89279	88
87718	39	87982	79	88390	149	88723	89	89282	67
87719	39	87983	79	88399	82	88724	89	89284	67
87720	37	87984	79	88436	52	88725	89	89431	88
87721	39	87985	79	88480	80	88726	89	89917	88
87725	35	87989	82	88481	80	88727	89	90011	89
87730	35	87990	82	88482	80	88728	89	90195	88
87735	35	87991	82	88483	80	88733	90	90254	67
87740	35	87992	82	88484	80	88734	90	90355	67
87750	37	87993	82	88485	80	88735	90	90374	89
87755	37	87994	82	88486	80	88736	90	90442	148
87760	163	87995	82	88487	80	88757	89	90443	148
87795	38	87996	82	88488	80	88758	89	90445	148

Product	Page	Product	Page	Product	Page	Product	Page	Product	Page
90446	148	97768	256	510176	268	513988	270	514640	262
90447	148	97775	256	510179	268	513989	270	514643	262
90448	148	97783	256	510180	267	513990	270	514664	263
90504	67	97790	256	510182	267	513991	270		
93140	112	97797	256	510207	269	513992	270		
93142	112	97804	256	510262	267	513993	270		
93144	112	97811	256	510264	267	513995	270		
93145	112	97818	256	510328	265	513997	270		
93150	112	97825	256	510372	268	513998	270		
93155	112	97832	256	510375	268	513999	270		
93160	112	97839	257	510735	263	514000	270		
93161	112	97846	257	510778	268	514003	270		
93165	112	97853	257	512567	265	514004	270		
93166	112	97860	257	512568	267	514006	271		
93167	112	97867	257	512570	267	514007	270		
93168	112	97874	257	512931	266	514008	270		
93169	112	97881	257	512975	266	514009	271		
96997	67	97888	257	513137	262	514010	270		
96998	67	97902	257	513139	262	514011	270		
96999	67	97911	257	513141	262	514012	270		
97031	67	97912	256	513200	264	514013	270		
97032	67	97915	257	513208	269	514015	270		
97034	67	97916	256	513210	269	514016	270		
97036	67	97922	257	513213	269	514019	270		
97038	67	97923	257	513214	269	514020	271		
97046	67	97937	257	513226	264	514021	270		
97091	67	97938	257	513229	264	514022	270		
97092	67	97940	257	513543	37	514023	271		
97093	67	97941	257	513544	37	514024	270		
97094	67	97962	257	513547	37	514026	270		
97095	67	97964	256	513548	269	514027	270		
97116	67	97966	256	513569	263	514030	271		
97151	67	97967	256	513577	263	514031	271		
97208	66	97983	67	513581	263	514032	271		
97211	66	99577	146	513585	263	514033	271		
97212	66	99694	146	513594	268	514034	271		
97251	83	99751	146	513595	268	514035	271		
97252	83	99752	146	513596	268	514509	267		
97470	148	99851	146	513597	263	514516	267		
97528	148	505195	22	513598	263	514534	262		
97529	148	505196	23	513601	264	514535	262		
97530	148	505197	22	513836	266	514536	262		
97543	148	505199	22	513860	263	514537	262		
97710	256	505200	22	513873	263	514621	262		
97717	256	505201	22	513893	266	514623	262		
97723	256	505208	22	513976	271	514626	262		
97730	256	505209	22	513977	271	514628	262		
97737	257	505210	22	513978	271	514630	262		
97744	257	510146	268	513979	271	514635	262		
97751	257	510148	268	513980	271	514636	262		
97758	257	510166	262	513987	271	514638	262		

INDEX BY MODEL NUMBER / 400 – 83626

Model	Page	Model	Page	Model	Page	Model	Page
400	254	10210	29	15004	87	68827	225
401	254	10212	29	15014	87	68864	225
402	254	10214	29	15024	87	68872	225
1500	83	10216	29	15114	87	80111	37
1501	83	13360	32	15900	16	82521	259
3260	269	13369	28	16161	24	82522	259
4100	267	13531	25	16162	24	82523	259
4112	267	13750	23	16163	24	82524	259
4802	234	13751	23	16164	24	82525	259
4803	234	13752	23	16165	24	82527	259
4804	234	13753	23	16183	17	82528	259
4824	158	13754	23	16184	17	82841	108
4830	158	14000	16	16185	17	82842	108
4831	159	14001	16	16212	29	82852	108
4843	161	14002	16	16213	29	82854	108
4844	161	14003	16	20181	256	82856	108
4863	236	14004	16	20184	256	82967	109
4864	236	14005	16	20297	251	83123	142
4865	236	14006	16	20298	248	83134	142
4866	236	14007	16	20299	248	83146	142
4878	236	14008	16	20300	247	83211	141
4879	236	14009	16	20301	247	83212	141
4880	235	14010	16	20302	246	83216	141
4895	227	14011	16	20340	247	83218	141
4896	227	14012	16	20341	247	83225	141
5062	67	14013	16	20342	246	83234	141
5225	67	14014	16	20344	250	83246	141
5555	236	14015	17	20345	251	83248	141
5802	234	14016	17	20346	248	83261	141
5803	234	14017	17	20349	248	83268	141
5804	234	14018	17	20357	250	83282	141
5824	158	14019	17	20380	249	83542	142
5830	158	14020	17	20381	249	83543	142
5831	159	14021	17	20385	249	83544	142
5843	161	14022	17	20391	248	83551	140
5844	161	14023	17	20398	246	83552	140
5863	236	14024	29	20700	251	83553	140
5864	236	14025	29	40800	248	83554	140
5865	236	14026	29	42443	162	83556	140
5866	236	14027	29	44833	248	83557	140
5878	236	14028	29	48254	249	83581	140
5879	236	14029	29	48301	158	83582	140
5880	235	14030	29	48302	158	83583	140
5896	227	14031	29	53990	162	83584	140
6240	88	14032	29	53991	163	83585	140
6408	89	14033	29	58301	158	83586	140
7003	88	14108	32	58302	158	83587	140
7009	88	14111	32	68800	225	83588	140
7063	67	14112	32	68801	225	83625	141
10208	29	14550	34	68802	225	83626	141

Model	Page	Model	Page	Model	Page	Model	Page
83628	141	83787	148	86614	113	88800	90
83630	141	83788	148	86618	113	88801	90
83632	141	83789	148	86619	113	88804	90
83633	141	83790	148	86621	103	88806	90
83635	141	83791	148	86624	103	88807	90
83642	142	83792	148	86626	113	88825	90
83643	142	83802	144	86632	113	88826	90
83644	142	83816	144	86718	113	88827	90
83646	142	83818	144	86726	113	88828	89
83651	143	83824	144	86832	113	88829	89
83652	143	83860	144	87717	39	88830	90
83653	143	83861	144	87718	39	88838	89
83654	143	83865	144	87719	39	88839	89
83661	143	83877	144	87721	39	88840	90
83662	143	83921	146	88250	89	89075	133
83663	143	83922	146	88251	89	89275	88
83664	143	83923	146	88259	89	89277	88
83671	143	83948	145	88261	89	89279	88
83672	143	83962	145	88262	89	89284	67
83673	143	83968	145	88311	88	89431	88
83674	143	83974	145	88312	88	90355	67
83675	143	83975	145	88371	133	90442	148
83676	143	83976	145	88406	89	90443	148
83678	143	83978	145	88536	89	90445	148
83680	143	83979	145	88537	89	90446	148
83682	143	83981	145	88538	90	90447	148
83685	143	84048	145	88538	90	90448	148
83692	146	84082	145	88650	88	90504	67
83693	146	84118	145	88651	88	93140	112
83695	146	84124	145	88652	88	93142	112
83696	146	84146	145	88721	89	93144	112
83697	146	84147	145	88722	89	93145	112
83698	146	84148	145	88725	89	93150	112
83700	147	84149	145	88726	89	93155	112
83703	146	84151	145	88728	89	93160	112
83706	155	84152	145	88733	90	93161	112
83710	147	86187	161	88734	90	93165	112
83711	155	86208	162	88735	90	93166	112
83712	155	86209	162	88757	89	93167	112
83713	155	86590	103	88758	89	93168	112
83714	155	86592	103	88759	89	93169	112
83732	147	86593	103	88760	89	97116	67
83733	147	86595	103	88761	89	97151	67
83734	147	86596	103	88762	89	97208	66
83735	147	86598	103	88763	89	97211	66
83761	144	86599	103	88764	89	97212	66
83782	148	86600	103	88769	90	97251	83
83783	148	86601	103	88770	90	97252	83
83784	148	86603	103	88771	90	97470	148
83785	148	86604	103	88772	90	97528	148

INDEX BY MODEL NUMBER / 1840000 – 2018ASRG4

Model	Page	Model	Page	Model	Page	Model	Page
97529	148	107100021	19	107370911	18	107940721	28
97530	148	107100031	19	107370921	18	107940731	28
97543	148	107100041	19	107370931	18	107940741	28
97983	67	107100051	19	107370941	18	107950011	19
99577	146	107110111	21	107370951	18	107950021	19
99694	146	107110121	21	107640021	31	107950031	19
99751	146	107110131	21	107640411	31	107950041	19
99752	146	107110141	21	107640421	31	107950051	19
99851	146	107130621	24	107640431	31	107950911	19
1710000	32	107130631	24	107640441	31	107950921	19
1720000	32	107130641	24	107640451	31	127130811	24
1840000	34	107130651	24	107650011	31	127130821	24
1870000	34	107140121	25	107650021	31	127130831	24
6010000	32	107140131	25	107650031	31	127130841	24
6150000	32	107140611	25	107650041	31	127130851	24
6160000	32	107140621	25	107650051	31		133
6170000	32	107140631	25	107700011	30	100EZ	254
6180000	32	107140641	25	107700021	30	101EZ	254
6190000	32	107190115	22	107700031	30	102EZ	254
6200000	32	107190122	22	107700041	30	103EZ	254
6300000	32	107190212	22	107700051	30	105EZ	254
6310000	32	107190222	22	107700411	30	105K	254
6320000	32	107190232	22	107700421	30	106EZ	254
6330000	32	107190266	22	107700431	30	107EZ	254
6340000	32	107210911	21	107700441	30	10810K111	32
6480000	34	107210921	21	107700451	30	10810K121	32
6510000	34	107210931	21	107710511	27	10810K131	32
6530000	34	107210941	21	107710521	27	10810K151	32
6540000	34	107210951	21	107710531	27	15003HA	87
6580000	32	107240111	26	107710811	27	15013HA	87
101820011	36	107240121	26	107710821	27	15023HA	87
101820021	36	107240131	26	107710831	27	15113HA	87
105050022	36	107240611	25	107710841	27	2010W-L	268
105050031	36	107240621	25	107710851	27	2010W-XL	268
105050041	36	107250911	23	107730311	27	20184F	258
106000021	32	107250921	23	107730321	27	2018ASC1	256
106000031	32	107250931	23	107730331	27	2018ASC4	256
106600031	179	107250941	23	107730341	27	2018ASD1	256
107050011	20	107250951	23	107730351	27	2018ASD4	256
107050021	20	107270011	18	107750911	30	2018ASL1	256
107050031	20	107270021	18	107750921	30	2018ASL4	256
107050041	20	107270031	18	107750931	30	2018ASM1	256
107050051	20	107290112	26	107750941	30	2018ASM4	256
107050111	20	107290122	26	107900011	28	2018ASOL	256
107050121	20	107350911	18	107900021	28	2018ASOL4	256
107050131	20	107350921	18	107900031	28	2018ASP4	256
107050141	20	107350931	18	107900041	28	2018ASR1	256
107050151	20	107350941	18	107900051	28	2018ASR4	256
107100011	19	107350951	18	107940711	28	2018ASRG1	256

2018BDI1 – AB9700HACP / INDEX BY MODEL NUMBER

Model	Page	Model	Page	Model	Page	Model	Page
2018ASRG4	256	2018TOL1	257	4872K	237	AB1202HACP	94
2018BDI1	256	2018TOL4	257	4878B	236	AB1205	94
2018BDI4	256	2018ZNNZ1	257	4WKEY	265	AB1205CP	94
2018BM1	256	2018ZNNZ4	257	5817P11/2	154	AB1205HA	94
2018BM4	256	203A04	88	5817P2	154	AB1205HACP	94
2018BRW1	256	225X-2	262	5817P3	154	AB1211	94
2018BRW4	256	2800-L	268	5817P4	154	AB1211CP	94
2018CRH1	256	2800-XL	268	5820G	164	AB1211HA	94
2018CRH4	256	2815-L	267	5824A	159	AB1211HACP	94
2018CRN1	256	2815-XL	267	5830A	159	AB1222	94
2018CRN4	256	34MCL	126	5830A2	159	AB1222HA	94
2018CRW1	256	36W	255	5830AS2	159	AB2	118
2018CRW4	256	42443CDU	162	5830ASTF	159	AB3	118
2018CRY1	256	42W	255	5830K0	158	AB31	117
2018CRY4	256	4803S	234	5830TFK	158	AB4	118
2018ELB1	256	4804S	234	5831A	160	AB41	117
2018ELB4	256	4820G	164	5831M	160	AB5	118
2018ELD1	257	4824A	159	5831MK0	160	AB518	120
2018ELD4	257	4824K0	158	5840B2	234	AB9000A	79
2018ELM1	257	4830A	159	5840S2	234	AB9200	82
2018ELM4	257	4830A2	159	5840S3	234	AB9200CP	82
2018ELS1	257	4830AS2	159	5841A4	233	AB9200D	82
2018ELS4	257	4830ASTF	159	5845P	160	AB9200HA	81
2018ELU1	257	4830ATF	159	5845S	160	AB9200HACP	81
2018ELU4	257	4830K0	158	5846S	160	AB9201	82
2018GRH1	257	4830LP	158	6110-L	268	AB9201CP	82
2018GRH4	257	4830LPK	158	6110-XL	268	AB9201HA	81
2018GRM4	257	4830TFK	158	6401A	89	AB9201HACP	81
2018GRP1	257	4831A	160	6404AVEID	89	AB9202	82
2018GRP4	257	4831M	160	6404AVEIDR	89	AB9202CP	82
2018KOB1	257	4831MK0	160	7003A	88	AB9202HA	81
2018KOC1	257	4840B2	234	903P	67	AB9202HACP	81
2018KOC4	257	4840B4	234	9680-L	267	AB9211	82
2018KOG1	257	4840PS2	234	9680-XL	267	AB9211CP	82
2018KOG4	257	4840S2	234	99EZ	254	AB9211HA	81
2018KOH1	257	4840S3	234	A00112BLK	296	AB9211HACP	81
2018KOH4	257	4841A4	233	A02214CI	294	AB9222	82
2018KOK1	257	4841B	232	AB1	118	AB9222HA	81
2018KOK4	257	4845P	160	AB1200	94	AB9238	82
2018KONG1	257	4845PK0	160	AB1200CP	94	AB9300	83
2018KONG4	257	4845S	160	AB1200HA	94	AB9300HA	83
2018KOP1	257	4845SK0	160	AB1200HACP	94	AB9301	83
2018KOP4	257	4846S	160	AB1201	94	AB9301HA	83
2018KOS1	257	4863K	236	AB1201CP	94	AB9302	83
2018KOS4	257	4863PK	236	AB1201HA	94	AB9302HA	83
2018MAN1	257	4864K	236	AB1201HACP	94	AB9302HACP	83
2018MAN4	257	4864PK	236	AB1202	94	AB9700	79
2018SLSS3003	257	4870K	237	AB1202CP	94	AB9700CP	79
2018SLSS30034	257	4871K	237	AB1202HA	94	AB9700HA	79

INDEX BY MODEL NUMBER / AB9701 – ABA1520CS

Model	Page	Model	Page	Model	Page	Model	Page
AB9700HACP	79	ABA1106	189	ABA1421CS17GA	208	ABA1447317GA	209
AB9701	79	ABA1125	193	ABA143017GA	208	ABA14476	213
AB9701CP	79	ABA1130	193	ABA14307	211	ABA14482	215
AB9701HA	79	ABA120	222	ABA1430717GA	211	ABA1450617GAHF	207
AB9701HACP	79	ABA1200CS	189	ABA14308	211	ABA14506HF	207
AB9702	79	ABA1200CSCT	189	ABA1430817GA	211	ABA1450817GAHF	207
AB9702CP	79	ABA1204A	217	ABA1430917GAG	208	ABA1451117GASHF	207
AB9702HA	79	ABA1204P	217	ABA14309G	208	ABA145117GACSO	207
AB9702HACP	79	ABA1208A	217	ABA1430G	208	ABA14511SHF	207
AB9705	79	ABA1208P	217	ABA14340RB	208	ABA1451517GASHF	207
AB9705CP	79	ABA1210CS	189	ABA1434SN	208	ABA1451817GAHF	207
AB9705HA	79	ABA1210CSCT	189	ABA1434VB	208	ABA14518HF	207
AB9705HACP	79	ABA1230S	193	ABA1435	208	ABA1452117GAHF	207
AB9711	79	ABA1236CS	193	ABA143517GA	208	ABA1470CS	202
AB9711CP	79	ABA1260CS	190	ABA14357	211	ABA1475CS	203
AB9711HA	79	ABA1260CSCT	190	ABA1435717GA	211	ABA1480	202
AB9711HACP	79	ABA1263S	191	ABA1435717GACLSHF	210	ABA14809	202
AB9722	79	ABA1263SCT	191	ABA14357CLSHF	210	ABA148490RB	202
AB9722CP	79	ABA1280S	194	ABA14358	211	ABA14849SN	202
AB9722HA	79	ABA12840RBCS	194	ABA1435817CLSHF	210	ABA14849VB	202
AB9722HACP	79	ABA1284SNCS	194	ABA1435817GA	211	ABA14840RB	202
AB9738	79	ABA1284VBCS	194	ABA14359	208	ABA1484SN	202
AB9738CP	79	ABA1285CS	195	ABA1435917GAC	208	ABA1484VB	202
AB9800	80	ABA12890RBCS	195	ABA1440	208	ABA1485	203
AB9800CP	80	ABA1289SNCS	195	ABA144017GA	208	ABA14859	203
AB9801	80	ABA1289VBCS	195	ABA14407	211	ABA148990RB	203
AB9801CP	80	ABA130	222	ABA1440717CLSHF	210	ABA14899SN	203
AB9802	80	ABA1305	190	ABA1440717GA	211	ABA14899VB	203
AB9802CP	80	ABA1305CT	190	ABA14407CLSHF	210	ABA14890RB	203
AB9811	80	ABA1305Z	190	ABA14408	211	ABA1489SN	203
AB9811CP	80	ABA1305ZCT	190	ABA1440817CLSHF	210	ABA1489VB	203
AB9900	80	ABA1310	191	ABA1440817GA	211	ABA1490	202
AB9900CP	80	ABA1310CT	191	ABA14409	208	ABA1495	203
AB9900HACP	81	ABA1310TKZ	192	ABA1440917GA	208	ABA1495Z	203
AB9901	80	ABA1310Z	191	ABA14455	212	ABA1501	202
AB9901CP	80	ABA1310ZCT	191	ABA1445517GA	212	ABA1501Z	202
AB9902	80	ABA1330	194	ABA14459	209	ABA1506	203
AB9902CP	80	ABA1335	195	ABA1445917GA	209	ABA1506Z	203
AB9902HACP	81	ABA1335TK	196	ABA14461CS	209	ABA1508A	217
AB9911	80	ABA1335ZCT	195	ABA14461CS17GA	209	ABA1508P	217
AB9911CP	80	ABA1421717GACS	211	ABA14463	209	ABA15120RB	203
AB9911HACP	81	ABA14217CS	211	ABA1446317GA	209	ABA1512SN	203
ABA042	229	ABA14217CS17CLSHF	210	ABA14465	212	ABA1512VB	203
ABA044	229	ABA14217CSCLSHF	210	ABA1446517GA	212	ABA1513	217
ABA102	222	ABA1421817GACS	211	ABA14469	209	ABA1514	217
ABA107	222	ABA14218CS17CLSHF	210	ABA1446917GA	209	ABA1520CS	193
ABA108	222	ABA14219CS	208	ABA1447117GACS	209	ABA1524CBCS	193
ABA1101	189	ABA14219CS17GA	208	ABA14471CS	209	ABA1524MBCS	193
ABA1101CT	189	ABA1421CS	208	ABA14473	209	ABA15240RBCS	193

ABA1524CBCS – ABA2218SF / INDEX BY MODEL NUMBER

Model	Page	Model	Page	Model	Page	Model	Page
ABA1524SNCS	193	ABA1634SN	193	ABA1723MB	213	ABA200CP	225
ABA1524VBCS	193	ABA1634VB	193	ABA1723MBCARD	213	ABA201	224
ABA1525S	197	ABA16356899	197	ABA1723ORB	213	ABA202	224
ABA1529CBCS	197	ABA16396899ORB	197	ABA1723ORBCARD	213	ABA203	224
ABA1529MBCS	197	ABA16396899SN	197	ABA1723PNCARD	213	ABA204	224
ABA1529ORB	197	ABA16396899VB	197	ABA1723SN	213	ABA205	224
ABA1529SNS	197	ABA1640	199	ABA1723SNCARD	213	ABA206	224
ABA1529VBS	197	ABA1645	223	ABA1723VB	213	ABA208	224
ABA1555	197	ABA1646	223	ABA1723VBCARD	213	ABA215	224
ABA1560	199	ABA1648	219	ABA1728	221	ABA21514	224
ABA1575	199	ABA1650	219	ABA1728S	221	ABA216	224
ABA1580CS	199	ABA1652SN	219	ABA1733	221	ABA21614	224
ABA1580CSS	219	ABA1652VB	219	ABA1733S	221	ABA217	224
ABA1582CS	219	ABA1655	223	ABA1736	221	ABA21714	224
ABA1584CBCS	219	ABA1656	223	ABA1736S	221	ABA218	224
ABA1584MBCS	219	ABA1658	198	ABA1738SN	221	ABA21814	224
ABA1584ORB	219	ABA1658CARD	198	ABA1738SNS	221	ABA219	224
ABA1584SNCS	219	ABA1658L	198	ABA1739	221	ABA21914	224
ABA1584VBCS	219	ABA1660CARD	198	ABA1745	223	ABA220	224
ABA1584WCS	219	ABA1662ORB	198	ABA1746	223	ABA220OHF	183
ABA1590	219	ABA1662ORBCARD	198	ABA1748	221	ABA22014	224
ABA1595	219	ABA1662PNCARD	198	ABA1748S	221	ABA2201HF	184
ABA1595P	219	ABA1662SN	198	ABA175	224	ABA221	224
ABA1597	219	ABA1662SNCARD	198	ABA1755	223	ABA2210HF	182
ABA1599CB	219	ABA1662VB	198	ABA1756	223	ABA2217HF	183
ABA1599MB	219	ABA1662VBCARD	198	ABA176	224	ABA2217MHF	183
ABA1599ORB	219	ABA1662WCARD	198	ABA177	224	ABA2217PZHF	183
ABA1599SC	219	ABA1673	198	ABA1775	223	ABA2217PZSF	183
ABA1599SN	219	ABA1673CARD	198	ABA1776	223	ABA2217RIHF	186
ABA1599VB	219	ABA1675	223	ABA178	224	ABA2217RIPZHF	186
ABA1599W	219	ABA1676	223	ABA1787	199	ABA2217SF	183
ABA1605	219	ABA1678ORBCARD	198	ABA179	224	ABA2217ZHF	183
ABA1605Z0	219	ABA1678SNCARD	198	ABA180	224	ABA22181RICO SHF	186
ABA1615	193	ABA1678VBCARD	198	ABA182	224	ABA22181RICO THF	186
ABA1617	193	ABA168	216	ABA1840	223	ABA2218HF	184
ABA1619CB	193	ABA1680	219	ABA1841	223	ABA2218MHF	184
ABA1619MB	193	ABA168H	216	ABA18416865516	223	ABA2218PZHF	184
ABA1619ORB	193	ABA1695	223	ABA1842	223	ABA2218PZSF	184
ABA1619SN	193	ABA1696	223	ABA18426865516	223	ABA2218RIHF	186
ABA1619VB	193	ABA1700	198	ABA1843	223	ABA2218RIMHF	186
ABA1620	197	ABA1700CARD	198	ABA1844	223	ABA2218RIZHF	186
ABA1624CB	197	ABA1720	213	ABA1845	223	ABA2218SF	184
ABA1624MB	197	ABA1720CARD	213	ABA1848	223	ABA2218TKHF	187
ABA1624ORB	197	ABA1720G	213	ABA1920	221	ABA2218TKPZHF	187
ABA1624SN	197	ABA1720T	213	ABA1930	221	ABA2218TKPZSF	187
ABA1624VB	197	ABA1722	213	ABA1935	221	ABA2218TKSF	187
ABA1625	199	ABA1722CARD	213	ABA1945	221	ABA2218ZHF	184
ABA1630	193	ABA1723CB	213	ABA1960	221	ABA222	224
ABA1634ORB	193	ABA1723CBCARD	213	ABA200CA	225	ABA2221CBHF	183

INDEX BY MODEL NUMBER / ABA2218TKHF – ABA253

Model	Page	Model	Page	Model	Page	Model	Page
ABA2221CBRIHF	186	ABA2227FLEX145HF	181	ABA2235CSSF	184	ABA2342VBHF	220
ABA2221CBTKHF	187	ABA2227FLEX14HF	181	ABA2235MBTKHF	187	ABA2342WHF	220
ABA2221CBTKSF	187	ABA2227FLEX155HF	181	ABA2238CBCSHF	183	ABA2344	217
ABA2221MBHF	183	ABA2227FLEX15HF	181	ABA2238MBCSHF	183	ABA2345	217
ABA2221MBRIHF	186	ABA2227FLEX16HF	181	ABA2238MBCSSF	183	ABA235	225
ABA2221MBSF	183	ABA2227HF	185	ABA22380RBCSHF	183	ABA2350HF	216
ABA2221MBTKCB	187	ABA2227RIFLEX16HF	181	ABA2238SNCSHF	183	ABA2352	186
ABA2221MBTKHF	187	ABA2227RIHF	186	ABA2238SNCSSF	183	ABA2353	186
ABA2221MBTKMB	187	ABA2228CSHF	185	ABA2238VBBCSHF	183	ABA2356	217
ABA2221MBTKSF	187	ABA2228DD	217	ABA2239CBCSHF	184	ABA2359	217
ABA2221MBTKSN	187	ABA2228FLEX145HF	181	ABA2239CBCSSF	184	ABA235CS	225
ABA2221MBTVB	187	ABA2228FLEX14HF	181	ABA2239MBCSHF	184	ABA236	225
ABA2221ORBHF	183	ABA2228FLEX155HF	181	ABA2239MBCSSF	184	ABA2361	217
ABA2221ORBRIHF	186	ABA2228FLEX15HF	181	ABA22390RBCSHF	184	ABA2362	217
ABA2221ORBTKHF	187	ABA2228FLEX15SF	181	ABA22390RBCSSF	184	ABA2365CSHF	188
ABA2221ORBTKSF	187	ABA2228FLEX16HF	181	ABA2239SNCSHF	184	ABA2366CBCSHF	188
ABA2221SNHF	183	ABA2228HF	185	ABA2239SNCSSF	184	ABA2366MBCSHF	188
ABA2221SNRIHF	186	ABA2228RIFLEX145CBHF	182	ABA2239VBBCSHF	184	ABA23660RBCSHF	188
ABA2221SNSF	183	ABA2228RIFLEX145HF	181	ABA2242CSHF	182	ABA2366PBCSHF	188
ABA2221SNTKSF	187	ABA2228RIFLEX145MBHF	182	ABA2242CSSF	182	ABA2366SNCSHF	188
ABA2221VBHF	183	ABA2228RIFLEX145SNHF	181	ABA2242FLEXCS	180	ABA2366VBBCSHF	188
ABA2221VBTKHF	187	ABA2228RIFLEX145VBHF	182	ABA2243CSHF	182	ABA2366WCSHF	188
ABA2221VBTKSF	187	ABA2228RIFLEX14CBHF	182	ABA2243FLEX24CSHF	180	ABA236CS	225
ABA2221WHF	183	ABA2228RIFLEX14HF	181	ABA2243FLEXCSHF	180	ABA237	225
ABA2222CBHF	184	ABA2228RIFLEX14MBHF	182	ABA2243FLEXCSSF	181	ABA2371HF	188
ABA2222CBRIHF	186	ABA2228RIFLEX14SNHF	181	ABA2250HF	183	ABA2377HF	188
ABA2222CBSF	184	ABA2228RIFLEX14VBHF	182	ABA2250TKHF	187	ABA2377SF	188
ABA2222MBHF	184	ABA2228RIFLEX155HF	181	ABA2250TKSF	187	ABA2378CBHF	188
ABA2222MBRIHF	186	ABA2228RIFLEX155MBHF	182	ABA2250TKZHF	187	ABA2378CBSF	188
ABA2222MBSF	184	ABA2228RIFLEX155SNHF	181	ABA2250ZHF	183	ABA2378MBHF	188
ABA2222ORBHF	184	ABA2228RIFLEX155VBHF	182	ABA2251HF	184	ABA2378MBSF	188
ABA2222ORBRIHF	186	ABA2228RIFLEX15CBHF	182	ABA2251ZHF	184	ABA23780RBHF	188
ABA2222ORBSF	184	ABA2228RIFLEX15HF	181	ABA2258HF	182	ABA23780RBSF	188
ABA2222OWHF	184	ABA2228RIFLEX15MBHF	182	ABA2259FLEX24HF	180	ABA2378PBHF	188
ABA2222SNHF	184	ABA2228RIFLEX15SNHF	181	ABA2259FLEXHF	180	ABA2378PNHF	188
ABA2222SNRIHF	186	ABA2228RIFLEX15VBHF	182	ABA2259HF	182	ABA2378SCHF	188
ABA2222SNSF	184	ABA2228RIFLEX16CBHF	182	ABA2259RIFLEX24HF	180	ABA2378SNHF	188
ABA2222SNTKHF	187	ABA2228RIFLEX16HF	181	ABA2259RIFLEXHF	180	ABA2378SNSF	188
ABA2222VBHF	184	ABA2228RIFLEX16MBHF	182	ABA2282HF	185	ABA2378SPHF	188
ABA2222WRIHF	186	ABA2228RIFLEX16SNHF	181	ABA2283HF	185	ABA2378VBHF	188
ABA2222WTKHF	187	ABA2228RIFLEX16VBHF	182	ABA2298CSHF	185	ABA2378VBSF	188
ABA2225FLEX	180	ABA2228RIFLEX155CBHF	182	ABA2299CSHF	185	ABA2378WHF	188
ABA2225HF	182	ABA2228RIHF	186	ABA22340HF	220	ABA237CS	225
ABA2226FLEX24HF	180	ABA2234CSHF	183	ABA22342CBHF	220	ABA238	225
ABA2226FLEXHF	180	ABA2234CSSF	183	ABA22342MBHF	220	ABA238CS	225
ABA2226FLEXS	181	ABA2234TKSF	187	ABA22342ORBHF	220	ABA239	225
ABA2226HF	182	ABA2234TKSF	187	ABA22342PBHF	220	ABA239CS	225
ABA2227CSHF	185	ABA2235CBTKHF	187	ABA22342PNHF	220	ABA240	225
ABA2227DD	217	ABA2235CSHF	184	ABA22342SNHF	220	ABA2400	165

Model	Page	Model	Page	Model	Page	Model	Page
ABA240CS	225	ABA3052CAI	226	ABA3469	166	ABA44000ORB	167
ABA241	225	ABA3052CP	226	ABA352	230	ABA44000SN	167
ABA242	225	ABA3052CPI	226	ABA3520	164	ABA44000VB	167
ABA242CS	225	ABA3052RA	227	ABA3521	164	ABA44010	167
ABA243	225	ABA3052RP	227	ABA353	230	ABA44010CB	167
ABA244	225	ABA3053CA	226	ABA3601	178	ABA44010MB	167
ABA2450	216	ABA3053CAI	226	ABA3900	178	ABA440100RB	167
ABA2450CARD	216	ABA3053CP	226	ABA3901	178	ABA44010SN	167
ABA2451	216	ABA3053CPI	226	ABA3931	222	ABA44010VB	167
ABA2451CARD	216	ABA3053RA	227	ABA3933	222	ABA44020	169
ABA2452	216	ABA3053RP	227	ABA400CA	225	ABA44020CB	169
ABA2452CARD	216	ABA3054CA	226	ABA400CP	225	ABA44020MB	169
ABA2462	235	ABA3054CAI	226	ABA4018HF	204	ABA440200RB	169
ABA2463	235	ABA3054CP	226	ABA402	231	ABA44020SN	169
ABA2464	235	ABA3054CPI	226	ABA4021MBSO	204	ABA44020VB	169
ABA2465	235	ABA3054RA	227	ABA4021ORBHF	204	ABA44030	168
ABA248	215	ABA3054RP	227	ABA4021SNHF	204	ABA44030CB	168
ABA253	215	ABA3055CA	226	ABA4021VBHF	204	ABA44030MB	168
ABA253L	215	ABA3055CAI	226	ABA403	231	ABA440300RB	168
ABA254	215	ABA3055CP	226	ABA4034CSHF	204	ABA44030SN	168
ABA254L	215	ABA3055CPI	226	ABA404	231	ABA44030VB	168
ABA2550	220	ABA3055RA	227	ABA4051HF	204	ABA44040	170
ABA2551	220	ABA3055RP	227	ABA41018	215	ABA440400CB	170
ABA2551CB	220	ABA3056CA	226	ABA4101820	215	ABA440400MB	170
ABA2551MB	220	ABA3056CAI	226	ABA4136	206	ABA440400RB	170
ABA2552	220	ABA3056CP	226	ABA41369	206	ABA44040SN	170
ABA2553	220	ABA3056CPI	226	ABA4146	205	ABA44040VB	170
ABA281	215	ABA3056RA	227	ABA41469	205	ABA44050	168
ABA281CLC	215	ABA3056RP	227	ABA4151	206	ABA44050CB	168
ABA281L	215	ABA3100	173	ABA41519	206	ABA44050MB	168
ABA281LCLC	215	ABA3101	173	ABA41549CS	206	ABA440500RB	168
ABA282	215	ABA312	230	ABA4154S	206	ABA44050SN	168
ABA282CLC	215	ABA313	230	ABA4155	206	ABA44050VB	168
ABA282L	215	ABA3200	164	ABA41559	206	ABA44601	167
ABA282LCLC	215	ABA3201	164	ABA4161	205	ABA44601CR	167
ABA285	216	ABA3202	164	ABA41619	205	ABA44601SNAP	167
ABA300CA	225	ABA3203	164	ABA41649CS	205	ABA44601SQ	168
ABA300CP	225	ABA3221A	222	ABA4164CS	205	ABA44601SQSNAP	168
ABA302	230	ABA3221B	222	ABA4165	205	ABA44601SQSNAPB	172
ABA303	230	ABA3400	164	ABA41659	205	ABA44603	169
ABA303PO	230	ABA3401	164	ABA41857	216	ABA44603BB	171
ABA304	230	ABA3408	164	ABA41857XL	216	ABA44603BBORB	171
ABA3051CA	226	ABA3409	164	ABA4227	216	ABA44603BBSN	171
ABA3051CAI	226	ABA34490	166	ABA4230	216	ABA44603BBSQ	172
ABA3051CP	226	ABA34490SNAP	166	ABA432	231	ABA44603BBSQORB	172
ABA3051CPI	226	ABA34500	166	ABA434	231	ABA44603BBSQSN	172
ABA3051RA	227	ABA34500SNAP	166	ABA44000	167	ABA44603BBSQVB	172
ABA3051RP	227	ABA3460053C	215	ABA44000CB	167	ABA44603BBVB	171
ABA3052CA	226	ABA3465	166	ABA44000MB	167	ABA44603ORB	169

INDEX BY MODEL NUMBER / ABA44703BB – ABA72132CBCARD

Model	Page	Model	Page	Model	Page	Model	Page
ABA44603SN	169	ABA5085	176	ABA6727	243	ABA6845	220
ABA44603SQ	170	ABA5090	176	ABA6729	243	ABA6847	220
ABA44603SQORB	170	ABA512	230	ABA6731	243	ABA6849CB	220
ABA44603SQSN	170	ABA5145	176	ABA6731M	243	ABA6849MB	220
ABA44603SQVB	170	ABA5149CB	176	ABA6733	243	ABA6849ORB	220
ABA44603VB	169	ABA5149MB	176	ABA6734	243	ABA6849SC	220
ABA44701	167	ABA5149ORB	176	ABA6735	243	ABA6849SN	220
ABA44701CR	167	ABA5149SN	176	ABA6737	243	ABA6849SP	220
ABA44701SNAP	167	ABA52007212	177	ABA6739	243	ABA6849VB	220
ABA44701SQ	168	ABA520072121	178	ABA6741	243	ABA6850	216
ABA44701SQSNAP	168	ABA52047212	177	ABA6743	243	ABA6854	216
ABA44701SQSNAPB	172	ABA520472121	178	ABA6744	243	ABA6855	216
ABA44703	169	ABA52087212	177	ABA6745	243	ABA6859	216
ABA44703BB	171	ABA520872121	178	ABA6748	243	ABA6861	175
ABA44703BBORB	171	ABA5225	177	ABA6749	243	ABA6893	219
ABA44703BBSN	171	ABA553	228	ABA6773	243	ABA6899	218
ABA44703BBSQ	172	ABA554	228	ABA6776	243	ABA6901	218
ABA44703BBSQORB	172	ABA564	228	ABA6805	218	ABA6903	218
ABA44703BBSQSN	172	ABA573	229	ABA6810	218	ABA6910	177
ABA44703BBSQVB	172	ABA574	229	ABA6812	218	ABA6916	214
ABA44703BBVB	171	ABA586	229	ABA6820	218	ABA6916M	214
ABA44703ORB	169	ABA602	229	ABA682088	218	ABA6918	186
ABA44703SN	169	ABA603	229	ABA6822	218	ABA6918M	186
ABA44703SQ	170	ABA604	229	ABA6824CB	218	ABA6919	214
ABA44703SQORB	170	ABA6320	175	ABA6824MB	218	ABA6960	216
ABA44703SQSN	170	ABA634	229	ABA6824ORB	218	ABA700	201
ABA44703SQVB	170	ABA6410	173	ABA6824ORB88	218	ABA7005	165
ABA44703VB	169	ABA6415	173	ABA6824SN	218	ABA7006	165
ABA44701LB	172	ABA6420	173	ABA6824SN88	218	ABA700NT	201
ABA44SWRADP	241	ABA6425	173	ABA6824VB	218	ABA710	201
ABA450	227	ABA6430	173	ABA6824VB88	218	ABA7101CARD	165
ABA451	227	ABA6435	173	ABA6824W	218	ABA7101CBCARD	165
ABA457	227	ABA6500	164	ABA6828	164	ABA7101MBCARD	165
ABA459	227	ABA6508	164	ABA6830	218	ABA7101ORBCARD	165
ABA480	231	ABA652	200	ABA6832	218	ABA7101SNCARD	165
ABA489	231	ABA6520	164	ABA6834ORB	218	ABA7101VBCARD	165
ABA5000	176	ABA652NT	200	ABA6834PN	218	ABA7102CARD	167
ABA5008	176	ABA6600	174	ABA6834SN	218	ABA7102CBCARD	167
ABA502	230	ABA6605	174	ABA6834VB	218	ABA7102MBCARD	167
ABA5020	176	ABA6610	174	ABA6834W	218	ABA7102ORBCARD	167
ABA503	230	ABA6615	174	ABA6835	220	ABA7102SNCARD	167
ABA504	230	ABA6620	174	ABA6841CB	220	ABA7102VBCARD	167
ABA5040	176	ABA6622	174	ABA6841MB	220	ABA7103	165
ABA5045	176	ABA66SWRADP	241	ABA6841ORB	220	ABA7103CARD	165
ABA5065	176	ABA6712	243	ABA6841PN	220	ABA710NT	201
ABA5070	176	ABA6715	243	ABA6841SC	220	ABA7135CARD	174
ABA5073	176	ABA6718	243	ABA6841SN	220	ABA7137CBCARD	174
ABA5074	176	ABA6724	243	ABA6841VB	220	ABA7137MBCARD	174
ABA5080	176	ABA6725	243	ABA6841W	220	ABA7137ORBCARD	174

ABA72132MBCARD – ABA980SN / INDEX BY MODEL NUMBER

Model	Page	Model	Page	Model	Page	Model	Page
ABA7137SNCARD	174	ABA8165	233	ABA8827ORB	175	ABA956	191
ABA720	201	ABA8175	233	ABA8880	234	ABA956CM	191
ABA7200	165	ABA8176	233	ABA8884	234	ABA956CT	191
ABA7200CARD	165	ABA8190	232	ABA88SWRADP	241	ABA956PZ	191
ABA7205CBCARD	165	ABA8195	232	ABA8AAVCOL	241	ABA956PZCT	191
ABA7205MBCARD	165	ABA8205	233	ABA8ICLIDB	241	ABA956RICM	192
ABA7205ORBCARD	165	ABA8225	232	ABA8ICLIDCOLB	241	ABA956RICT	192
ABA7205SNCARD	165	ABA8235	233	ABA8ICLIDCOLG	241	ABA956RIPZCM	192
ABA7205VBCARD	165	ABA82505	233	ABA8ICLIDCOLR	241	ABA956RIPZCT	192
ABA720NT	201	ABA8255	233	ABA8ICLIDG	241	ABA960ORB	191
ABA7210	165	ABA82555	233	ABA8ICLIDR	241	ABA960ORBCT	191
ABA7210CARD	165	ABA851	195	ABA901	196	ABA960SN	191
ABA72121CARD	172	ABA8510	235	ABA902	196	ABA960SNCT	191
ABA7212CARD	171	ABA8545	162	ABA906	189	ABA960VB	191
ABA72132CBCARD	172	ABA8546	162	ABA906CT	189	ABA960VBCT	191
ABA72132MBCARD	172	ABA8548	162	ABA910ORB	189	ABA960W	191
ABA72132ORBCARD	172	ABA8549	162	ABA910ORBCT	189	ABA960WCT	191
ABA72132SNCARD	172	ABA8560	237	ABA910SN	189	ABA965031	200
ABA72132VBCARD	172	ABA8561	237	ABA910SNCT	189	ABA965032	200
ABA7213CBCARD	171	ABA8562	237	ABA910VB	189	ABA965033HF	199
ABA7213MBCARD	171	ABA8563	237	ABA910VBCT	189	ABA965033SF	199
ABA7213ORBCARD	171	ABA8564	237	ABA910W	189	ABA96504CB1	200
ABA7213SNCARD	171	ABA8565	237	ABA911	189	ABA96504CB2	200
ABA7213VBCARD	171	ABA8575	237	ABA911CT	189	ABA96504CB3HF	199
ABA7215	165	ABA8576	237	ABA915ORB	189	ABA96504CB3SF	199
ABA7216	165	ABA8579	237	ABA915ORBCT	189	ABA96504MB1	200
ABA7218	165	ABA8580	237	ABA915SN	189	ABA96504MB2	200
ABA7226	165	ABA8583	237	ABA915SNCT	189	ABA96504MB3HF	199
ABA7232	175	ABA8584	237	ABA915VB	189	ABA96504MB3SF	199
ABA7233	175	ABA8587	237	ABA915VBCT	189	ABA96504ORB1	200
ABA7234	175	ABA8588	237	ABA915W	189	ABA96504ORB2	200
ABA7240	175	ABA8589	237	ABA926	193	ABA96504ORB3HF	199
ABA7242	175	ABA859	195	ABA931	193	ABA96504ORB3SF	199
ABA730	201	ABA8591	237	ABA951	190	ABA96504SN1	200
ABA730NT	201	ABA8592	237	ABA951CT	190	ABA96504SN2	200
ABA740	201	ABA8593	237	ABA951PZ	190	ABA96504SN3HF	199
ABA740NT	201	ABA8595	232	ABA951PZCT	190	ABA96504SN3SF	199
ABA750	201	ABA8600	232	ABA951RICT	192	ABA96504VB1	200
ABA750NT	201	ABA8610	232	ABA951RIPZCT	192	ABA96504VB2	200
ABA770	201	ABA8612	230	ABA951TK	192	ABA96504VB3HF	199
ABA7730ORB	201	ABA8620	232	ABA951TKPZ	192	ABA96504W1	200
ABA773SN	201	ABA8630	232	ABA955ORB	190	ABA96504W3	199
ABA773VB	201	ABA8637	232	ABA955ORBCT	190	ABA965071	200
ABA773W	201	ABA8640	232	ABA955SN	190	ABA965072	200
ABA801	191	ABA8810	237	ABA955SNCT	190	ABA965073HF	199
ABA807	191	ABA8811	237	ABA955VB	190	ABA971	194
ABA808	191	ABA8812	237	ABA955VBCT	190	ABA971CT	194
ABA809	191	ABA8825	232	ABA955W	190	ABA971PZ	194
ABA8135	232	ABA8827	175	ABA955WCT	190	ABA971PZCT	194
						ABA971RIPZCT	196

INDEX BY MODEL NUMBER / ABA980VB – DBSS1DSV

Model	Page	Model	Page	Model	Page	Model	Page
ABA971RIT	196	ABAML3TTP	241	ABAPA4SFSG	242	ASDW1211HA	86
ABA975ORB	194	ABAML3TZ	240	ABAPA6SFGATE	242	B	67
ABA975SN	194	ABAML3XAC	240	ABAPA6SFSG	242	B150	42
ABA975VB	194	ABAML3XA0	240	ABAPAPE2013LID	239	B200	42
ABA976	195	ABAML3XPC	240	ABAPE2013	239	B200C	42
ABA976CT	195	ABAML3XP0	240	ABATERMEX3SFA	241	B200LV	42
ABA976PZ	195	ABAML448IC	241	ABATERMEX3SFP	241	B200X	42
ABA976PZCT	195	ABAML4963A	239	ABATERMEX4SFA	241	BB200TS	42
ABA976RICT	196	ABAML4963P	239	ABATERMEX4SFP	241	BBE200TS	42
ABA976RIZT	196	ABAML4BDY1A	240	ABATERMEX6SFA	241	BBE200TSGF	42
ABA976TK	196	ABAML4BDY1P	240	ABATERMEX6SFP	241	BBED200TS	43
ABA976TKP	196	ABAML4FCADWW	242	ABATERMEXC	241	BBED200TSGF	43
ABA980ORB	195	ABAML4FCPDWW	242	ABATERMEXO	241	BD2	236
ABA980SN	195	ABAML4TCA	239	ADH12	137	BE	67
ABA980VB	195	ABAML4TCP	239	ADH12WH	137	BE200	42
ABA9924	243	ABAML4TEPP	241	AHP18203	131	BE200GF	42
ABAB1238BW	262	ABAML4TEPPA	241	AHP1820C	131	BED	67
ABAB1240BBW	262	ABAML4TZ	240	AHP2022	131	BED150	43
ABABWW3A	238	ABAML4TZB	240	AHP2022C	131	BED150GF	43
ABABWW3ADAPT	238	ABAML4XAC	240	AHP2022NH	131	BED200	43
ABABWW3ARBK	238	ABAML4XA0	240	AHP2224	131	BED200GF	43
ABABWW3AS	238	ABAML4XPC	240	AHP2224C	131	BED200P	43
ABABWW3ORINGS	238	ABAML4XP0	240	AHP2224NH	131	BED200PGF	43
ABABWW3P	238	ABAML6FCADWW	242	AHP2426	131	BEDTRC	67
ABABWW3PAS	238	ABAML6FCPDWW	242	AHP2426C	131	BIM875AB	51
ABABWW3PRBK	238	ABAML6FCPSDR	242	AHP2426NH	131	BIM875LV	51
ABABWW4A	238	ABAMLF4	239	AHP2628	131	BIM875QTSAB	51
ABABWW4ADAPT	238	ABAMLSF334A	242	AHP2628C	131	BIM876QTCAB	51
ABABWW4ARBK	238	ABAMLSF334P	242	AHP2628NH	131	BIM877QTPAB	51
ABABWW4AS	238	ABAMLSF3TG	242	AHP2830	131	BIM878QTWAB	51
ABABWW4ORINGS	238	ABAMLSF446A	242	AHP2830C	131	BT150SS	263
ABABWW4P	238	ABAMLSF446P	242	AHP3032	131	BTP612	235
ABABWW4PAS	238	ABAMLSF4TG	242	AHP3032C	131	BTP934	235
ABABWW4PRBK	238	ABAMLSF668A	242	AHP3032NH	131	BTP940	235
ABABWW6A	238	ABAMLSF668P	242	AHP3234	131	BTRC	67
ABABWW6ADAPT	238	ABAMLSF6TG	242	AHP3234C	131	C601	108
ABABWW6ARBK	238	ABAPA3CASS1NC	240	AS1200	95	C612	108
ABABWW6ORINGS	238	ABAPA3CASS1NO	240	AS1201	95	C614	108
ABABWW6P	238	ABAPA3SFGATE	242	AS1202	95	C615	108
ABABWW6PRBK	238	ABAPA3SFSG	242	AS1211	95	C620	108
ABAKCOB2	223	ABAPA4963G	239	ASDW1200	86	C634	108
ABAKCOB3	223	ABAPA4963LCO	239	ASDW1200HA	86	CB41	117
ABAML3BDY1A	240	ABAPA4963RK	239	ASDW1201	86	CB41S	117
ABAML3BDY1P	240	ABAPA4CASS1NC	240	ASDW1201HA	86	CC61234	106
ABAML3BLG	241	ABAPA4CASS1NO	240	ASDW1202	86	CH1234	106
ABAML3TEPP	241	ABAPA4FREXT	239	ASDW1202HA	86	CH34114	106
ABAML3TEPPA	241	ABAPA4FRFULL	239	ASDW1205	86	CI31234	106
ABAML3TTA	241	ABAPA4FRINT	239	ASDW1205HA	86	CI41234	106
ABAML3TTG	241	ABAPA4SFGATE	242	ASDW1211	86	CI341234	106

DBSS1SV – FSAV34PRESSMPT / INDEX BY MODEL NUMBER

Model	Page	Model	Page	Model	Page	Model	Page
CL5012DP	268	FB2	117	FRAS1201	101	FRM12WS	54
CN200	67	FB200	44	FRAS1202	101	FRMBG1212CSST	102
C0302C	151	FB3	117	FRAS1211	101	FRMBG1212IP	102
C0402	151	FB31	116	FRASDW1200	86	FRMBG1234IP	102
C0402C	151	FB34	116	FRASDW1200HA	86	FRMIB12ABC	60
CS202	151	FB4	117	FRASDW1201	86	FRMIB12ABCHA	60
CS302	151	FBE200	45	FRASDW1201HA	86	FRMIB12ABDS	60
CS4	162	FBED200	46	FRASDW1202	86	FRMIB12ABP	60
DB350	66	FBED200GF	46	FRASDW1202HA	86	FRMIB12ABPHA	60
DB3D	66	FCRP2	150	FRASDW1211	86	FRMIB12ABS	60
DB425	66	FCRP3	150	FRASDW1211HA	86	FRMIB12ABSHA	60
DB4D	66	FCRP35	150	FRDW1200HA	101	FRMIB12ABW	60
DBSS1	66	FCRP4	150	FRDW1201HA	101	FRMIB12ABWHA	60
DBSS1D	66	FR12C	56	FRDW1202HA	101	FRTC1200	102
DBSS1DLV	66	FR12CCP	56	FRDW1211HA	101	FRTC1201	102
DBSS1DSV	66	FR12CHA	58	FRGB12CSST	63	FRTC1202	102
DBSS1SV	66	FR12CHACP	58	FRGB12IP	63	FRTC1211	102
DBSS2	66	FR12CS	57	FRIB12ABC	61	FS125NPT	274
DBSS2D	66	FR12CSCP	57	FRIB12ABCCP	61	FS12NPT	274
DBSS2DLV	66	FR12DS	59	FRIB12ABCHA	62	FS12NPTD	274
DBSS2DSV	66	FR12DSCP	59	FRIB12ABCHACP	62	FS14C	274
DBSS2SV	66	FR12P	56	FRIB12ABDS	61	FS150NPT	274
DLWB1	49	FR12PCP	56	FRIB12ABP	61	FS1NPT	274
DSALUF38	120	FR12PHA	58	FRIB12ABPCP	61	FS34C	274
DW1200HA	95	FR12PHACP	58	FRIB12ABPHA	62	FS34H	274
DW1201HA	95	FR12PS	57	FRIB12ABPHACP	62	FS34H90	274
DW1202HA	95	FR12PSCP	57	FRIB12ABRCP	61	FS34NPT	274
DW1211HA	95	FR12PSHA	59	FRIB12ABRHACP	62	FS34P	274
EB152E	151	FR12PSHACP	59	FRIB12ABS	61	FS34PRESS	274
EB220E	151	FR12RCP	56	FRIB12ABSCP	61	FS34PRESSMPT	274
EB320E	151	FR12RHACP	58	FRIB12ABSHA	62	FS38C	274
EB350E	151	FR12S	56	FRIB12ABSHACP	62	FS38CD	274
EB420E	151	FR12SCP	56	FRIB12ABW	61	FSAB100	282
EFB1	120	FR12SHA	58	FRIB12ABWCP	61	FSAB100-LTL	282
EFB2	120	FR12SHACP	58	FRIB12ABWHA	62	FSAB75	282
EX100EZ	254	FR12SS	57	FRIB12ABWHACP	62	FSABC	287
EX99EZ	254	FR12SSCP	57	FRM12C	54	FSACEXT9	275
F201	107	FR12SSHA	59	FRM12CHA	55	FSACONT1	275
F201LF	107	FR12SSHACP	59	FRM12CS	54	FSACONT2	275
F212	107	FR12W	56	FRM12P	54	FSADES07	280
F212LF	107	FR12WCP	56	FRM12PHA	55	FSADPIK	285
F234	107	FR12WHA	58	FRM12PS	54	FSAFD	285
F234LF	107	FR12WHACP	58	FRM12PSHA	55	FSAINV1500	282
F285914	105	FR12WS	57	FRM12S	54	FSAINV2000	282
F325938	105	FR12WSCP	57	FRM12SHA	55	FSAMOTOR5M	275
F7111312	105	FR7070	67	FRM12SS	54	FSAMOTOR6M	275
F7111338	105	FRAAV12	63	FRM12SSHA	55	FSAPS	287
FB1	117	FRAD12	64	FRM12W	54	FSARC115	286
FB150	44	FRAS1200	101	FRM12WHA	55	FSARC2	286

INDEX BY MODEL NUMBER / FSAV38C – MBFR1205HA

Model	Page	Model	Page	Model	Page	Model	Page
FSAEXT10	275	FSCV2SWS	284	H88113LOK	105	I320	107
FSAEXT22	275	FSCV2SWSSO	284	H8812LOK	105	I334	107
FSASMO1	275	FSDSKIT	280	H8815LOK	105	I401	109
FSASVHARNP25	275	FSEP50T20	278	H8817LOK	105	I412	109
FSATFS10	284	FSEP50T35	278	H8820LOK	105	I434	109
FSATFS20	284	FSEP75T20	278	H8822LOK	105	K012	154
FSAUPS	282	FSEP75T35	278	H8825LOK	105	K034	154
FSAV125NPT	275	FSGP200	278	H8828LOK	105	L2411	67
FSAV12NPT	275	FSPC13TC1850	277	H8832LOK	105	LPC1	121
FSAV14C	275	FSPM	281	H8836LOK	105	LPC15	121
FSAV150NPT	275	FSPP33CCPT20	276	H8840LOK	105	LPC2	121
FSAV1NPT	275	FSPP33CCPV10	276	H8847LOK	105	LPC3	121
FSAV34C	275	FSPP33CCPV20	276	H8851LOK	105	LPC4	121
FSAV34H	275	FSPP33TCDV10	276	H8859LOK	105	LT109	105
FSAV34H90	275	FSPP33TDDV10	276	H8871LOK	105	LT8845	105
FSAV34NPT	275	FSPP50CCPT20	276	H8880LOK	105	LT8885	105
FSAV34P	275	FSPP50CCPV10	276	HB1	117	MB1200	92
FSAV34PRESS	275	FSPP50CCPV20	276	HB1LB	117	MB1200CP	92
FSAV34PRESSMPT	275	FSPP50TCDV10	276	HB2	117	MB1200HA	92
FSAV38C	275	FSSP33V10	280	HB2LB	117	MB1200HACP	92
FSAVFS10	284	FSSW40T10	278	HB3	117	MB1201	92
FSAVFS20	284	FSSW40T20B45	279	HB31	116	MB1201CP	92
FSAWA	275	FSSW40T20B45A	279	HB4	117	MB1201HA	92
FSAWAE9	275	FSSW50T10	278	HB41	116	MB1201HACP	92
FSAWHD33	275	FSSW50T20	278	HP1820	132	MB1202	92
FSAWHD72	275	FSSW50T20B30	279	HP2022	132	MB1202CP	92
FSAWHS	275	FSSW50T20B45	279	HP2022C	132	MB1202HA	92
FSAWYE	284	FSSW50T20B45A	279	HP2022NH	132	MB1202HACP	92
FSAXS01	275	FSSW50V10	278	HP2224	132	MB1205	92
FSAYD	285	FSSW50V20	278	HP2224C	132	MB1205CP	92
FSBB1850	277	FSTP50	280	HP2224NH	132	MB1205HA	92
FSBB1850W	276	FSUG1	281	HP2426	132	MB1205HACP	92
FSBB2400	277	FSUG2	281	HP2426C	132	MB1211	92
FSBB2400W	276	FSUP25TA	279	HP2426NH	132	MB1211CP	92
FSC33CC1850	277	FSPA	286	HP2628	132	MB1211HA	92
FSC33CC2400	277	FSWIFE	275	HP2628C	132	MB1211HACP	92
FSC33CC2400W	277	GB1	118	HP2628NH	132	MB1211SLHACP	92
FSC50CC2400W	277	GB2	118	HP2830	132	MB1222	92
FSCINVKIT1	282	GB3	118	HP2830C	132	MB1222HA	92
FSCINVKIT2	282	GB31	116	HP3032	132	MB1222HA	92
FSCP120	280	GB3118BE	116	HP3032C	132	MB1250AD	97
FSCV125-15IB	283	GB4	118	HP3032NH	132	MB1250WS	97
FSCV15IB	283	GB41	116	HS1	113	MBABFR1222	100
FSCV15IC	283	GB4118BE	116	HS433BD-12	262	MBF1200	88
FSCV15SWC	283	GB5	118	HS433BD-18	262	MBF1211	88
FSCV15SWS	283	GB518	118	HS88242	89	MBF1222	88
FSCV15SWSSO	283	H101	106	I301	107	MBF1233	88
FSCV15TB	283	H112	106	I312	107	MBFR1200	99
FSCV2IB	283	H134	106	I314	107	MBFR1200CP	99
FSCV2IC	283	H138	106	I315	107	MBFR1200HA	99

MBFR1205HACP – MWB5 / INDEX BY MODEL NUMBER

Model	Page	Model	Page	Model	Page	Model	Page
MBFR1200HACP	99	MBFRS1200HACP	98	MBSAB1211HACP	91	MRF3GRD	119
MBFR1201	99	MBFRS1201	98	MBSSB	104	MRF3GRDRF	120
MBFR1201CP	99	MBFRS1201CP	98	MC02	148	MRF3GSQ	119
MBFR1201HA	99	MBFRS1201HA	98	MC02CI	148	MRF3TCSRD	119
MBFR1201HACP	99	MBFRS1201HACP	98	MC03	148	MRF3TCSSQ	119
MBFR1202	99	MBFRS1202	98	MC04	148	MRF4BRD	119
MBFR1202CP	99	MBFRS1202CP	98	MC06	148	MRF4BSQ	119
MBFR1202HA	99	MBFRS1202HA	98	MC06CI	148	MRF4BSSQ	119
MBFR1202HACP	99	MBFRS1202HACP	98	MDWB1AB	65	MRF4GRD	119
MBFR1205	99	MBFRS1205	98	MDWB2AB	65	MRF4GSQ	119
MBFR1205CP	99	MBFRS1205CP	98	MDWB3AB	65	MRF4TCSSQ	119
MBFR1205HA	99	MBFRS1205HA	98	MDWB4AB	65	MRF5BRD	119
MBFR1205HACP	99	MBFRS1205HACP	98	MDWB5AB	65	MRF5BSQ	119
MBFR1211	99	MBFRS1211	98	MDWB6AB	65	MRF5BSRD	119
MBFR1211CP	99	MBFRS1211CP	98	MGB1	64	MRF5GRD	119
MBFR1211HA	99	MBFRS1211HA	98	MH321	111	MRF5GSQ	119
MBFR1211HACP	99	MBFRS1211HACP	98	MH322	111	MRF5TCSRD	119
MBFR1211SLCP	99	MBFRS1222	98	MH323	111	MRF6BRD	119
MBFR1211SLHACP	99	MBFRS1222HA	98	MH324	111	MRF6BSQ	119
MBFR1222	99	MBG1212CSST	96	MH421	111	MRF6GRD	119
MBFR1222HA	99	MBG1212IP	96	MH422	111	MRF6GSQ	119
MBFRAB1200	100	MBG1234IP	96	MH423	111	MRF7BRD	119
MBFRAB1200CP	100	MBS1200	91	MH424	111	MRF7BSQ	119
MBFRAB1200HA	100	MBS1200AAV	96	MH4821	111	MRF7GRD	119
MBFRAB1200HACP	100	MBS1200CP	91	MH4822	111	MRF7GSQ	119
MBFRAB1201	100	MBS1200DB1	93	MH4823	111	MSI1	109
MBFRAB1201CP	100	MBS1200HA	91	MH4824	111	MSI15	110
MBFRAB1201HA	100	MBS1200HACP	91	MIB1AB	51	MSI20	110
MBFRAB1201HACP	100	MBS1201	91	MIB1DAB	51	MSI3	109
MBFRAB1202	100	MBS1201CP	91	MIB1HAAB	52	MSI4	109
MBFRAB1202CP	100	MBS1201HA	91	MIB2AB	51	MSI5	109
MBFRAB1202HA	100	MBS1201HACP	91	MIB2HAAB	52	MSI6	110
MBFRAB1202HACP	100	MBS1202	91	MIB3AB	51	MSI7	110
MBFRAB1205	100	MBS1202CP	91	MIB3HAAB	52	MSP1	110
MBFRAB1205CP	100	MBS1202HA	91	MIB4AB	51	MWB10	49
MBFRAB1205HA	100	MBS1202HACP	91	MIB4HAAB	52	MWB11	49
MBFRAB1205HACP	100	MBS1205	91	MIB5AB	51	MWB12	49
MBFRAB1211	100	MBS1205CP	91	MRF1BRD	119	MWB13	50
MBFRAB1211CP	100	MBS1205HA	91	MRF1BRDRF	120	MWB15	50
MBFRAB1211HA	100	MBS1205HACP	91	MRF1GRD	119	MWB16	48
MBFRAB1211HACP	100	MBS1211	91	MRF1GRDRF	120	MWB17	48
MBFRAB1222HA	100	MBS1211CP	91	MRF2BRD	119	MWB18	48
MBFRF1200	97	MBS1211HA	91	MRF2BRDRF	120	MWB19	50
MBFRS1200	98	MBS1211HACP	91	MRF2GRD	119	MWB1D	50
MBFRS1200AAV	102	MBS1211SLCP	91	MRF2GRDRF	120	MWB20	48
MBFRS1200CP	98	MBS1222	91	MRF3BRD	119	MWB21	50
MBFRS1200DB1	99	MBS1222HA	91	MRF3BRDRF	120	MWB22	50
MBFRS1200DB2	99	MBSAB1202CP	91	MRF3BSQ	119	MWB23	49
MBFRS1200DB3	99	MBSAB1202HACP	91	MRF3BSRD	119	MWB25	49
MBFRS1200HA	98	MBSAB1211CP	91	MRF3BSSQ	119	MWB26	50

INDEX BY MODEL NUMBER / MWB6 – R5575

Model	Page	Model	Page	Model	Page	Model	Page
MWB27	50	P2549HGC	295	P3549HGC	296	P6543HR	294
MWB28	50	P2549HGCM	295	P3549HGCM	296	P6548H	294
MWB3	48	P2562H1EF	297	P3563HXFCPSSW	296	P6549HBCHE	296
MWB30	50	P2562H2EF	297	P3563HXFNBSQSSW	296	P65906	294
MWB4	49	P2562H451EF	297	P3563HXFNBSW	296	P6843HC	294
MWB5	48	P2562HHAM	297	P35903	294	PBS1	104
MWB6	49	P2563HCHSSWLS	295	P3B43	296	PBS2	104
MWB7	48	P2563HLS	295	P441	179	PRI13	137
MWB8	49	P2563HNB	295	P445	179	PS18	104
MWB9	49	P2563HSSW	295	P451	179	PS26	104
MWBRLV	49	P2563HSSWSQCP	295	P454	179	R1523	38
MWN1	149	P2563HSSWLS	295	P4542B	291	R1525	38
MWN10	149	P2563HXFNBSW	295	P4542C	291	R1623	38
MWN11	149	P25902	294	P4542SDFF	291	R1625	38
MWN2	149	P35340	297	P4542SDFM	291	R2012B	71
MWN3	149	P3534HCH	294	P4542SDMF	291	R2512B	71
MWN4	149	P3534SX	294	P4542SDMM	291	R2800B	71
MWN6	149	P35392	291	P4542SLFF	291	R301	39
MWN8	149	P3542B	291	P4542SLFM	291	R4702	74
MWN9	149	P3542C	291	P4542SLMF	291	R4820G	164
NH7020	265	P3542SDFF	291	P4542SLMM	291	R4842S	234
NITEXP200L	267	P3542SDFM	291	P4542SRFF	291	R4873K	237
NITEXP200XL	267	P3542SDMF	291	P4542SRFM	291	R5002	35
NWBED	67	P3542SDMM	291	P4542SRMF	291	R5071	36
NWBED200-3	44	P3542SLFF	291	P4542SRMM	291	R5101	37
NWBED200-4	44	P3542SLFM	291	P4542SXFF	291	R5103	37
NWBED2003GF	44	P3542SLMF	291	P4543HB	294	R5105	37
NWBED2004GF	44	P3542SLMM	291	P4543HG	294	R5123	35
NWBEDTRC	67	P3542SRFF	291	P4543HGC	294	R5124	35
NWFBED2004	46	P3542SRFM	291	P4543HR	294	R5125	35
NWFBED2004GF	46	P3542SRMF	291	P4544HCMSX	295	R5134	35
P25140	297	P3542SRMM	291	P4544HSX	295	R5135	35
P25410P	295	P3542SXFF	291	P45470	295	R5136	35
P2543HB	294	P3543HG	295	P45470D	291	R5163	35
P2543HG	294	P3543HGC	295	P45470D	295	R5164	35
P2543HGCH	294	P3543HR	295	P45470WT	291	R5165	35
P2543HR	294	P3544HSX	297	P4548H	295	R5166	35
P2543HRC	294	P35470	297	P4548HSSW	296	R5175	39
P2543HRCH	294	P35470D	291	P4548HSX	295	R5176	39
P2543HRCR	294	P35470D	295	P45498CH	296	R5177	39
P2548H	294	P35470WT	291	P4549HB	296	R5401	38
P2548HSSW	295	P3548H	295	P4549HBC	296	R5451	38
P254910CH	295	P3548HSSW	295	P4549HFF	296	R5455	38
P254912CH	295	P354912CH	295	P4549HFF2.5S	296	R5460	38
P2549412CH	295	P3549412CH	295	P4549HG	296	R5501	38
P25498CH	295	P35498CH	295	P4549HGCM	296	R5503	38
P2549HB	295	P3549HB	296	P45904	294	R5553	38
P2549HBC	295	P3549HBC	296	P461	179	R5555	38
P2549HFF	295	P3549HFFCH	296	P465	179	R5557	38
P2549HG	295	P3549HG	296	P466K	179	R5559	38

Model	Page	Model	Page	Model	Page	Model	Page
R5561	38	ROL06	136	S4542HEZ	297	SSMIB9AB	53
R5563	38	ROL08	136	S4542HR	297	SSWB1	50
R5566	38	RSG13	115	S45470	297	SSWB1TM	50
R5570	38	RSG15	115	S601	150	SSWB2	50
R5575	38	RSP1	236	S602	150	SSWB2TM	50
R5581	38	RTB01	134	S6543HR	294	SSWB3	50
R5583	38	RW1	67	S65470	297	STP1	155
R5585	38	RWG1	163	S6548HSSW	296	STRO4	137
R5842S	234	RWG10	163	S802	150	T	67
RAB9000B	79	RWG1J	163	SADGAS	237	T200	47
RAP1414	243	RWG1T	163	SC3	123	T200LV	47
RAP8X8	243	RWG2	163	SC3S	123	T200QT	47
RC1	121	RWG2J	163	SC4	123	T200QTF1960	47
RC2	121	RWG3	163	SC4S	123	T200TPABS	47
RC3	121	RWG4	163	SC5	123	T200TPABSLV	47
RC4	121	RWG5	163	SC5S	123	T200TPABSQT	47
RC41	121	RWG6	163	SC6	123	T200TPCVCHA	47
RC5	120	RWG7	163	SC6S	123	T200TPPLV	47
RCPH12	112	RWG8	163	SC79	123	T200TPPVC	47
RCPH34	112	RWGSF1	163	SCB07	134	T200TPPVCCPVC	47
RDF12	146	RWGSF2	163	SCBLAC	124	T200TPVCHA	47
RDF13	146	RWGSFJ	163	SCBLG	124	T200TPVCPHA	47
RDF34	146	RWN1	149	SCBRG	124	T200TPVQCQT	47
RDF36	146	RWN2	149	SCGRG	124	T200TPVCWHA	47
REP1	36	RWN3	149	SCS-24	262	TA-33-DT398	264
RFHA1	115	RWN4	149	SCS-36	262	TA-CTN-3-1000	269
RFS1	38	RWN5	149	SCS-48	262	TA-CTN-3-300	269
RFW5	266	RWN6	149	SDC1	179	TA-DNG-3-1000	269
RGS7	113	S12PH	104	SM106	151	TA-DNG-3-300	269
RGS8	113	S12PV	104	S01	154	TA-DT260BLK	264
RH-PW1	266	S152	150	S02	154	TA-DT260R	264
RH-RHBV-GL-6	22	S20	104	S03	154	TA-S260	37
RH-RHBV-HDYPK-HP-20	23	S2012PH	104	S04	154	TA-S520	37
RH-RHBV-HP-36	22	S2012PV	104	SS501	107	TA-SW260	37
RH-RHBV-PT-24	22	S202	150	SS512	107	TA-SW520	37
RH-RHBV-QP-48	22	S2034PH	104	SS534	107	TA-SX520	37
RH-RHBV-QT-12	22	S2034PV	104	SSDB1	50	TA-USTT1226G	37
RH-RHCV-GL-6	22	S26	104	SSDW1AB	53	TA-USTT1226GRAY	37
RH-RHCV-PT-12	22	S2612PH	104	SSGB12CSST	64	TA-USTT1226P	37
RH-RHCV-QT-12	22	S2612PV	104	SSGB12IP	64	TA-USTT1226Y	37
RH112C	106	S2634PH	104	SSGB34IP	64	TA-USTT1252	37
RH134C	106	S2634PV	104	SSIB1AB	52	TA-UT250FT	269
RHS10	113	S300	150	SSIB2AB	52	TB3	122
RHS25	113	S302	150	SSMIB1AB	53	TB3SP	122
RI412C	109	S34PH	104	SSMIB2AB	53	TB4	122
RI434C	109	S34PV	104	SSMIB3AB	53	TB4SP	122
RMDW1AB	52	S35470	294	SSMIB5AB	53	TB5	122
RNWG1	163	S35498DWT	296	SSMIB6AB	53	TB5SP	122
ROD03	137	S401	150	SSMIB7AB	53	TB6	122
ROL05	136	S402	150	SSMIB8AB	53	TB6SP	122

INDEX BY MODEL NUMBER / TC-125SL – W2801HACP

Model	Page	Model	Page	Model	Page	Model	Page
TB7	122	TD4SPABS	153	TT2	228	VP27PP	130
TB8	122	TD4SPPVC	153	TT200	48	VP27PPNH	130
TC-125SL	263	TG-A-100-20	271	TT200QTS	48	VP27RC	130
TC-158-BLADE	263	TG-A-15-20	271	TT200TPABS	48	VP27RP	130
TC-1960L	268	TG-A-30-20	271	TT200TPABSC	48	VP31PC	130
TC-1960M	268	TG-A-60-20	271	TT200TPPVC	48	VP31PP	130
TC-1960XL	268	TG-A-BAV	271	TT200TPPVCC	48	VP31PPNH	130
TC-2-BLADE	263	TG-A-VCAP	271	TT200TPPVCP	48	W2012	71
TC-GB-320	266	TG-LF-100-25	270	TT200TPPVCS	48	W2122	73
TC-PC-158	263	TG-LF-100-4	270	TT200TPPVCW	48	W2312D	71
TC-PCHD-2-BD	263	TG-LF-15-25	270	TT3	228	W2412	71
TC-PCSL-138	263	TG-LF-15-4	270	TT35	228	W2700	71
TC-RAGS	266	TG-LF-160-25	270	TT4	228	W2700CP	71
TC1	153	TG-LF-160-4	270	TX1	114	W2700HA	72
TC110R	262	TG-LF-200-25	270	TX2	114	W2700HACP	72
TC118SS	263	TG-LF-30-25	270	TX3	114	W2701	71
TC1200	96	TG-LF-300-25	270	VB1	114	W2701CP	71
TC1201	96	TG-LF-300-4	270	VB1S	114	W2701HA	72
TC1202	96	TG-LF-400-25	270	VB1SL	114	W2701HACP	72
TC1211	96	TG-LF-60-25	270	VB2	114	W2702	71
TC1218	262	TG-LFVG-30-25	270	VB2L	114	W2702CP	71
TC1224	262	TG-LP-05-25	271	VB3	114	W2702HA	72
TC1232	262	TG-NB-100-20	270	VB3L	114	W2702HACP	72
TC150SS	263	TG-NB-100-25	270	VB4	114	W2704	71
TC156R	262	TG-NB-100-35	271	VB4L	114	W2705	71
TC1A	154	TG-NB-15-20	270	VB4X	114	W2705CP	71
TC1AD	152	TG-NB-15-25	270	VB5	114	W2705HA	72
TC1D	152	TG-NB-160-20	270	VB5X	114	W2705HACP	72
TC2	153	TG-NB-160-25	270	VC1214	123	W2711	71
TC200SS	263	TG-NB-200-20	270	VC35	123	W2711CP	71
TC2A	154	TG-NB-200-25	270	VC57	123	W2711HA	72
TC2AD	152	TG-NB-30-20	270	VC79	123	W2711HACP	72
TC2D	152	TG-NB-30-25	270	VC911	123	W2713	71
TC3	153	TG-NB-30-35	271	VP19PC	130	W2722	71
TC3A	154	TG-NB-300-25	270	VP19PP	130	W2722CP	71
TC3D	152	TG-NB-300-35	271	VP19PPNH	130	W2722HA	72
TC4	153	TG-NB-60-20	270	VP21PC	130	W2722HACP	72
TC425	264	TG-NB-60-25	270	VP21PP	130	W2738	71
TC4A	154	TG-NB-600-25	270	VP21PPNH	130	W2738CP	71
TC4D	152	TG-W-160-20	271	VP23PC	130	W2800	71
TC6	153	TG-W-160-25	271	VP23PP	130	W2800CP	71
TC614R	262	TG-W-300-20	271	VP23PPNH	130	W2800HA	72
TC618R	262	TG-W-300-25	271	VP23RC	130	W2800HACP	72
TC624R	262	TG-WLH-160-20	271	VP23RP	130	W2800X	71
TC656R	262	TG-WLH-300-20	271	VP25PC	130	W2801	71
TC810R	262	TP1	114	VP25PP	130	W2801CP	71
TD3ABS	153	TP1B	114	VP25PPNH	130	W2801HA	72
TD3PVC	153	TP2	114	VP25RC	130	W2801HACP	72
TD4ABS	153	TP2B	114	VP25RP	130	W2802HA	72
TD4PVC	153	TRFAST	258	VP27PC	130	W2811	71

Model	Page	Model	Page	Model	Page	Model	Page
W2811CP	71	W8902CP	76	WTGS10NPS2	125	WTSB4	115
W2811HA	72	W8902CPTM	76	WTGS12ELB	125	WTSBK	115
W2811HACP	72	W8902HA	77	WTGS12ELR	125	WTSR	115
W4012	74	W8902HACPTM	77	WTGS12HVAC4	125	WTSR10	115
W4015	74	W8902K0CP	76	WTGS12HVAC5	125	WTSR2734	115
W4700	74	W8902LD	77	WTGS12HVAC6	125	WTSR32	115
W4700CP	74	W8904	76	WTGS12NPS3	125	WTSR3210	115
W4700HA	75	W8904CP	76	WTGS12NPS4	125	WTSR4	115
W4700HACP	75	W8905	76	WTGS15HVAC8	125	XTB0224	134
W4701	74	W8905CP	76	WTMLFP4102	125	Z53401	257
W4701CP	74	W8905HA	77	WTMLFP410B	126	Z53404	257
W4701HA	75	W8905HACP	77	WTMLFP410BG	125		
W4701HACP	75	W8911	76	WTMLFP6122	125		
W4702	74	W8911CP	76	WTMLFP6123	125		
W4702CP	74	W8911CPTM	76	WTMLFP612B	126		
W4702HA	75	W8911HACP	77	WTMLFP612BG	125		
W4702HACP	75	W8911HACPTM	77	WTMLFP6162	125		
W4702THACP	75	W8911LD	77	WTMLFP6163	125		
W4705	74	W8912	76	WTMLFP616B	126		
W4705CP	74	W8914CP	76	WTMLFP616BG	125		
W4705HA	75	W8914HACP	77	WTMLFP6615	125		
W4705HACP	75	W8922CPTM	76	WTMLFP662	125		
W4711	74	W8922HACPTM	77	WTMLFP663	125		
W4711CP	74	W9000LV	79	WTMLFP66B	126		
W4711HA	75	W9800LV	80	WTMLFP66BG	125		
W4711HACP	75	WB150	44	WTMLFP66BTH	126		
W4722	74	WB200	44	WTMLFP884	125		
W5700	84	WB200HA	45	WTMLFP88B	126		
W5700CP	84	WBE200	45	WTMLFP88BG	125		
W5912CSST	85	WBE200GF	45	WTMP916	126		
W5912IP	85	WBE200HA	45	WTP-270	258		
W5934IP	85	WBE200HAGF	45	WTP-270B	258		
W7011	88	WBED200	46	WTP-488	258		
W7070	88	WBED200GF	46	WTP-496	258		
W8411	76	WHS1	133	WTP-512	258		
W8900	76	WMP1	133	WTP-538	258		
W8900CP	76	WMP2	133	WTP-659G	258		
W8900CPTM	76	WMP3	133	WTP-659W	258		
W8900HACP	77	WMP4	133	WTP-715	258		
W8900HACPTM	77	WNWBED2003	46	WTP-907	258		
W8900LD	77	WNWBED2003GF	46	WTP-940	258		
W8900LV	76	WNWBED2004	46	WTPFGR20035025PK	127		
W8901	76	WNWBED2004GF	46	WTPFGR2525PK	127		
W8901CP	76	WNWBED2004HA	46	WTPFGR35065025PK	127		
W8901CPTM	76	WNWBED2004HAGF	46	WTPFGR5015025PK	127		
W8901HACP	77	WTGS10NPS05	125	WTSB	115		
W8901LD	77	WTGS10NPS075	125	WTSB10	115		
W8901LDLCP	77	WTGS10NPS1	125	WTSB2734J	115		
W8901LDHACP	77	WTGS10NPS125	125	WTSB32	115		
W8902	76	WTGS10NPS15	125	WTSB3210	115		

WORD SEARCH

Lucky you! We had an extra page to fill. Sure we could have added a notes page (boring) or left it blank (lazy). But where's the fun in that? Take a break and engage your brain in this perfect little IPS puzzle as a proficient problem-solving person. We're a phone call away (800-888-8312) whenever you need help with product information or an order, but the task below would be much more fun for you on your own. Happy hunting!

U K L T W E P K S A F F I R E S T O P P E N E T R A T O R S
 J Q L Z R H O B M T E S T P L U G S F N W P O W J D D N D Y
 S G H Z K U W R O U T L E T B O X E S O S S E C Q N A X K T
 Q L A E U X E W W T F B D N I K F R G J S T Z M Y A U F S P
 C T Y M U K I B U T S C W O F N J F J P T U N O C T I W E U
 V L I P U M P S R I A E V H W J B A L O R D U T W B V J T S
 E N N X Y L L J N O K D P E Y W R D I A Q O S U H F V Y F L
 Y E A F C O N M Q M L S H B I Z G O S F S R S M G S V D A I
 A M Z B J L M G H Q C V K H C L A M P S C H N E H F H A S Z
 K S E U A A O H U R Z V Z N X C M K H I X W I K T Z B T T G
 C O X J U C D S G X K X T T B R U S H E S Z A N R K F E N D
 R L P L T S K D E P R O S E L B Q W I Z W U H W G K W S K D
 X R S X D M B W Z T P R E S S U R E G A U G E S C S A T S V
 E W T R T M W L A A G H A M M E R A R R E S T E R A T T L Z
 R J Y A R G K F V T Q A B O F I Z C A Z Z L P B L S E I X E
 V V U E N O F M P H E D S X G M D H X B I X A B T L R T L W
 H G U M Q Z O X P M B R F K E B K R S Y A V P B W E T E Z E
 Z X A D I A M F A Y U F V N E L X I G I A F G W A A I T N L
 P R I M E R S J T F B Y O A P T Y S D C V J M T S K T X C D
 U L W L K T U A O O X N D A L X S T Q L I Y E X T D E J O O
 F V H X P P J U J Y P V X R Q V F Y E E W J D N E E K V R N
 M J K F R Y V P M E N B H L A V E S F A L E U C S T B V F T
 I E N X K C S T C Q M M L B T I G S K N L S M V Q E B W L V
 R X Z T L G L O V E S E P O U N N F O O W V A J F C U Z O J
 S O L V E N T C E M E N T S X G Q S V U E S M J E T F X O B
 B I H U U V D M R T G B V H O D J R P T V N B J J I R R D C
 P X H C I Y Y M H H V P R O V E N T J S C P X N A O M E S E
 W R X L L E S P A D A R G G J V C O G U Y G R A Y N B O T L
 I D T X F C H O B U J E R O V E R F L O W G R Q X J K J O H
 U L Y A O E U M U N V Y H C N G T O U G H P A N S I L W P N

Firestop Penetrators
 Backwater Valves
 Hammer Arrester
 Solvent Cements
 Pressure Gauges
 Closet Gaskets
 Leak Detection
 ABA (AB&A)
 Outlet Boxes

Roof Top Blox
 Floodstop
 AAV
 Test Plugs
 Water-Tite
 Tough Pans
 ADA
 Test-Tite
 Guy Gray

Overflow
 Truebro
 Provent
 Primers
 SetFast
 Christys
 Brushes
 ProSet
 Flashings

Studor
 Clamps
 Weld-On
 Cleanouts
 Drains
 Waste
 Pumps
 Gloves
 DWV

If you get stuck and still need a little help, see the answer key at ipscorp.com/wordsearchkey.



**THE BRANDS
PROFESSIONAL
PLUMBERS
CHOOSE.**

WELD*ON® GUY GRAY®
WATER*TITE® TOUGH PANS®
FLOODSTOP® PROVENT®
PROSET® TEST*TITE®
AB&A® STUDOR®
TRUEBRO® CHRISTY'S®
ROOF TOP BLOX®



IPS[®] CORPORATION

IPS Corporation[®]
500 Distribution Parkway
Collierville, TN 38017

800-888-8312
901-853-5008 fax

ipscorp.com/plumbing
tncustserv@ipscorp.com

IPS006 03/2025