



FASTENERS & HARDWARE



ANCHORS & KITS



FITTINGS & STAMPINGS



CHEMICALS & TAPE



TOOLS & SPECIALTY ITEMS

50

CELEBRATING FIFTY YEARS





L.H. DOTTIE COMPANY

SINCE THE DAY THE L.H. DOTTIE COMPANY WAS FOUNDED 50 YEARS AGO, WE HAVE FOCUSED ON OUR SINGULAR GOAL, GROWING OUR CUSTOMERS BUSINESS. AS A RESULT, YEAR AFTER YEAR, THAT QUEST HAS LED TO NEW INNOVATIVE PRODUCTS, PACKAGING, MERCHANDISING, PRINT MEDIA AND A BRAND RECOGNIZED ACROSS NORTH AMERICA. YOU CAN COUNT ON US TO CONTINUE TO PROVIDE NEW INDUSTRY LEADING PRODUCTS AND EQUIP YOU WITH THE RESOURCES TO SELL THEM. IN A MARKETPLACE FULL OF SUPPLIERS WHOSE IDEA OF SUPPORT IS FILLING YOUR ORDER DOTTIE IS ON THE FRONT LINES OF REACHING OUT TO YOUR CUSTOMERS AND TRAINING YOUR KEY PERSONNEL.

OVER THESE 50 YEARS WE HAVE HAD THE GRATIFICATION OF HEARING THAT 'DOTTIE IS EASY TO DO BUSINESS WITH...' FROM OUR PERSPECTIVE WE ARE WORKING TO ENSURE THAT YOU THINK THE SAME.



BIGGER FAMILY. BETTER PRODUCTS.

MISSION STATEMENT:

Our mission statement is to exceed the expectations of our customers. We will accomplish this by committing to shared values, and achieving the highest level of customer satisfaction, with competitively priced superior products, quality customer service and an emphasis on value. Through the integration of people, technology and business systems we will ensure our profit, quality and growth goals are met.

CUSTOMER SERVICE:

Dottie has a tradition of serving our customers with prompt, professional service from a knowledgeable staff. We encourage our employees to be informed, get involved, and make a difference. It is our goal to provide a wide, innovative, and cost effective choice of products and a superior level of service. With our Customer Service Call Center and Corporate Headquarters on the West Coast, we are able to serve the other Time Zones later in the day, Monday through Friday until 8:15 PM ET.

At L.H. Dottie our goal is to ship orders quickly, completely and accurately. With our manufacturing facility in Los Angeles, our fully stocked distribution centers in California, Oklahoma and Philadelphia and representatives throughout North America, L.H. Dottie is ready to provide fast service to our customers coast to coast.

Customer Service Hours: 6:00 AM to 5:15 PM PT
Toll-Free Number: 800-982-1901
Phone: 323-725-1000
Fax: 323-721-0000

LETTER FROM THE CEO:

In 1965 my Grandfather and Father founded the L.H. Dottie Company. Over the last 50 years we've established a reputation for first class service and industry leading products. Today with the fourth generation in place we remain one of an increasingly smaller number of family owned and operated manufacturers in our industry. All of us at Dottie owe a debt of gratitude to our loyal and future distributors across North America for your patronage.

I hope you find our new catalog commemorating our 50th Anniversary informative and easy to use. It is because of you that the L.H. Dottie Company is a leading provider of a wide variety of products and a superior level of customer service. As CEO and a member of the third generation of family ownership I'll continue to invest in our most valuable asset our people as well as cutting edge technology to continue our long standing tradition of customers first.

We thank you again for your support,



© 2015 L.H. Dottie Company
All Rights Reserved

A handwritten signature in black ink, appearing to read "Steve V. V. V.", written over a white background.

President & CEO
L.H. Dottie Company

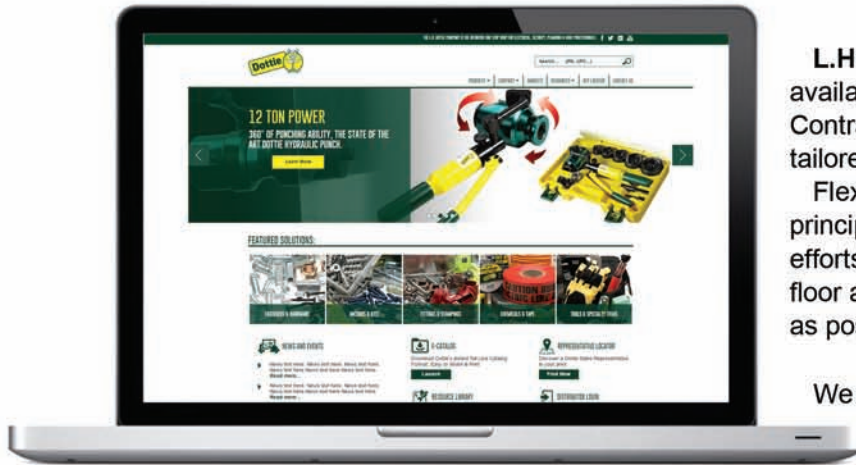

L.H. Dottie embraces the best technology available to provide our Distributors and Contractors with technology solutions tailored to your business practices.

Flexibility, quality and security are the principles that drive our technology efforts to get your order to our warehouse floor and then to your facility as fast as possible.

We provide a variety of interfaces and platforms to meet your daily needs for Order Entry, Tracking, Order

Confirmation and Invoicing.

The **NEW!** lhdottie.com has been redesigned to include an in-depth online catalog housing all technical information including Safety Data Sheets (SDS), Underwriters Laboratory product certifications (UL), International Code Council Evaluation Service (ICC-ES), our product specifications, images for your use in advertising and more.

Our Web Order and Web Portal System provides a wealth of services and information at your fingertips. Our Electronic Data Interchange (EDI) capabilities reduce costs and errors. These systems are always available to accept your orders and L.H. Dottie Customer Service Personnel at our offices in California are conveniently available on the phone from 6:00 AM to 5:15 PM PT.

Invincibox® Color-Coded Labeling System

Our innovative 4 color-coded labeling system featuring a tamper-evident label helps you locate products faster!



| | |
|--|--|
| <p>Dottie HN14 1/4-20 Hex Nuts Zinc Plated</p> <p>100 pcs. China Q 79221</p> | <p>Dottie 2WS61 6 X 1" Pan Head Phillips/Slotted Sheet Metal Screws</p> <p>100 pcs. China Q 79224</p> |
| <p>Dottie 21 #6-8-10 Red Plastic Anchor Tapered with Collar Use 3/16" Drill bit</p> <p>100 pcs. USA Q 79228</p> | <p>Dottie RMC63212 6-32 X 1/2" Round Head Phillips/Slotted Machine Screws</p> <p>100 pcs. China Q 79231</p> |

| Product Type: | Label Color: |
|----------------------------------|--------------|
| Machine Screws | Orange |
| SMS/TEK/DWS/Wood Rockets | Yellow |
| Hex Nuts/Washers | Sky Blue |
| Plastic Anchors/Wire Goods/Misc. | Cool Gray |

GUARANTEE TO SELL:

If you are not completely satisfied with your purchase of Dottie products, you may return any cataloged, resalable item in its original packaging with no restocking fee within one year from the date of original purchase to the Commerce, CA warehouse. Items with a shelf life may be returned within six months of the date of purchase. Customer to prepay freight. Dottie will credit your account.



***The following items have shelf life**

Adhesive Tape Products
ABS & PVC Cement
First Aid Kits

Wire Markers
Cutting Oil
Firststop Products

Handi-Foam
Prest-O-Seal/#68 Sound Pads
Paints & Chemicals

RTV Sealant
Tuf Towels
Rain-Kote Roof Mastic

WARRANTY:

Subject to and conditional upon the following terms and conditions, L.H. Dottie Company warrants to those authorized distributors that purchase product directly from L.H. Dottie ("Distributors") that at the time of shipment, such products shall be free of defects in material or workmanship ("Limited Warranty"). L.H. Dottie Company will, at its option, repair, replace, or refund the purchase price; provided, however, the product, and an invoice or other proof of purchase satisfying conditions of this Limited Warranty, are received by L.H. Dottie Company during the Warranty Period (defined below).

Except for products with a stated shelf life (in which case the warranty period will be the lesser of one year or the stated shelf life), this Limited Warranty runs for a period of one year from the date the Distributor purchased the product from L.H. Dottie Company ("Warranty Period"). Warranty claims received by L.H. Dottie Company after the expiration of the Warranty Period will not be honored.

THE WARRANTY AND REMEDIES SET FORTH ABOVE ARE EXCLUSIVE AND IN LIEU OF ALL OTHERS, WHETHER ORAL OR WRITTEN, EXPRESS OR IMPLIED, INCLUDING, WITHOUT LIMITATION, ANY IMPLIED WARRANTY OF MERCHANTABILITY OR FITNESS FOR A PARTICULAR PURPOSE, OR OF NON-INFRINGEMENT OF THIRD-PARTY RIGHTS (INCLUDING, BUT NOT LIMITED TO, PATENT AND COPYRIGHT RIGHTS), ALL OF WHICH OTHER WARRANTIES ARE HEREBY EXPRESSLY DISCLAIMED.

L.H. DOTTIE COMPANY'S TOTAL LIABILITY, WHETHER IN TORT, UNDER ANY WARRANTY, IN NEGLIGENCE, OR OTHERWISE SHALL NOT EXCEED THE COST OF REPAIR OR REPLACEMENT OF THE PRODUCT COVERED BY THIS LIMITED WARRANTY, AND TO THE FULLEST EXTENT PERMITTED BY APPLICABLE LAW, L.H. DOTTIE COMPANY SHALL NOT HAVE ANY LIABILITY FOR ANY CONSEQUENTIAL, INCIDENTAL, SPECIAL, DIRECT, INDIRECT, EXEMPLARY OR PUNITIVE DAMAGES, INCLUDING WITHOUT LIMITATION COST OF DEFENSE, LOST REVENUES, LOST PROFITS, LOSS OF GOODWILL OR LOST PRODUCTION, DAMAGE TO EQUIPMENT AND PROPERTY, OR ANY COSTS OF REPAIRS OR DAMAGE RELATING TO PRODUCT.

Some states do not allow the exclusion or limitation of incidental or consequential damages, so the foregoing limitation or exclusion may not apply to all Distributors.

This Limited Warranty does not cover ordinary wear and tear; or, product that has been damaged by accident, abuse, misuse, misapplication, overloading, altered or modified without prior written permission of L.H. Dottie Company; or, product that has not been installed, used, operated, or maintained in accordance with L.H. Dottie Company's written instructions. This Limited Warranty is not transferable or applicable to any person other than Distributor purchasing produce directly from L.H. Dottie Company. No L.H. Dottie Company distributor, agent, or employee is authorized to make any modification, extension, or addition to this Limited Warranty.

A: FASTENERS & HARDWARE

| | |
|---|------------|
| Machine Screws..... | A1-A4, A11 |
| Stove Bolts..... | A4 |
| Wall Plate & Ground Screws..... | A5 |
| Toggle Bolts..... | A6 |
| Tamper Proof..... | A7-A9 |
| Tamperproof Screws, Bits & Drivers..... | A10 |
| Wood Screws..... | A12 |
| Drywall Screws..... | A13 |
| Sheet Metal Screws..... | A14-A16 |
| Framer Screws..... | A16 |
| K-Lath Screws..... | A17 |
| Self Drilling Screws..... | A18-A20 |
| Metal Piercing..... | A20 |
| Tap Bolts..... | A21, A23 |
| Cap Screws..... | A22, A23 |
| Lag Screws..... | A24 |
| Threaded Rod & Couplings..... | A25 |
| Hex Nuts..... | A26 |
| Lock Washers..... | A27 |
| Flat Washers..... | A28 |
| Fender Washers & "S" Hooks..... | A29 |
| Fixture Accessories..... | A30-A31 |
| Chain & U-Bolts..... | A32 |

B: ANCHORS & KITS

| | |
|---|---------|
| Plastic Anchors..... | B1 |
| Wallboard Anchors..... | B2 |
| Zamac Anchors..... | B3 |
| Drive Pins..... | B3 |
| Machine Screw Anchors..... | B4 |
| Toggle Anchors & Harness Toggles..... | B4 |
| Drive Anchors & Lag Shields..... | B5 |
| Threaded Rod Spike..... | B5 |
| Drop In Anchors..... | B6 |
| Sleeve Anchors..... | B6 |
| Wedge Anchors..... | B7 |
| Rod Hanging System..... | B8-B10 |
| Telescoping Pole Tools & Accessories..... | B11 |
| Concrete Anchoring System..... | B12 |
| Anchor Kits..... | B13-B15 |
| Fastener Kits..... | B16-B17 |
| Screw & Washer Kits..... | B18 |

C: FITTINGS & STAMPINGS

| | |
|---|---------|
| Staples..... | C1 |
| Safety Plates, Plate Straps & Nail Straps..... | C2 |
| Plumber's Tape, Hook on Clips & Straps and Wire Hanger..... | C3 |
| One & Two Hole Straps..... | C4 |
| Conduit Hangers..... | C5 |
| Strut Clamps, Channel Nuts & U-Bolt Beam Clamps..... | C6 |
| Flat Plate, Angle, Zee & U Fitting & Post Bases..... | C7 |
| Roof Jacks & Tie Wire..... | C8 |
| Beam Clamps, Floor Flanges, Box Supports & Cover Plates..... | C9 |
| Reducing, Plastic & EMT Bushings..... | C10 |
| Nylon Bushings, Anti-Short Bushings & K.O. Seals..... | C11 |
| Reducing Washers & Universal Stud Bushings..... | C12 |
| Locknuts, Sealing Locknuts, Offset & Conduit Nipples..... | C13 |
| Cable Connectors, Device Spacer & Wall Plate Gaskets..... | C14 |
| Strain Relief Connectors & Steel Combo Couplings..... | C15 |
| Die Cast & PVC Liquid Tite Connectors..... | C16 |
| Steel Liquid Tite Connectors..... | C17 |
| Weathertight Hubs & No Thread Connectors & Couplings..... | C18 |
| Insulated Ground Bushings, Ground Rods & Ground Rod Clamps..... | C19 |
| Ground Clamps & Hubs..... | C20-C21 |
| Ground Screws, Ground Pigtails, Ground Clips & Crimp Sleeves..... | C22 |
| Entrance Caps, Entrance Ells & Pullings Ells..... | C23 |
| Threaded Conduit Bodies..... | C24 |
| Conduit Bodies With Cover & Gasket..... | C25 |
| Gaskets & Covers..... | C26 |
| Multi-Guard Covers..... | C27 |

D: CHEMICALS & TAPE

| | |
|--|-------|
| Tape..... | D1-D2 |
| Barricade Tape..... | D2 |
| Underground & Detectable Tape..... | D3 |
| Cable Ties & Mounting Bases..... | D4 |
| Cable Tie Packs & Air Handling Ties..... | D5 |
| Pull Rope, Pull Line & Nylon Line..... | D6 |
| Conduit Measuring Tape, Pull Line & Premise Tape..... | D7 |
| Line Packages & Power Fishing Pistons..... | D8 |
| PVC Cement/Primer, Roof Mastic & Dark Cutting Oil..... | D9 |
| Fire Stop/Caulk, Putty Pads & Firesticks..... | D10 |
| Insulpads, Duct Seal, Handi-Foam, Silicon Sealant & Caulking Guns..... | D11 |
| Tuf Towels, Wiping Rags & Warehouse Supplies..... | D12 |
| Wire Marker Books, Wire Terminal Kit & Lumber Crayons..... | D13 |
| Marking, Invert-A-Caps & All Purpose Paints..... | D14 |
| Rust Proof Paint & Color Selector..... | D15 |
| Tef-Lube, All-4, Component & Contact Cleaners & Safety Solvents..... | D16 |
| Degreaser, Safety Solvent, Dust Air, Rust-Solv & Lubricants..... | D17 |
| Cutting Oil, Galvanize, Epoxy Coating, Wasp Spray..... | D18 |

E: TOOLS & SPECIALTY ITEMS

| | |
|--|---------|
| Step Drills..... | E1 |
| Drill/Tap, Screw Removal Kits & Nut Driver..... | E2 |
| High Speed Drills & Kits..... | E3 |
| Masonry & SDS 4 Plus Rotary Hammer Drill Bits..... | E4 |
| Ship Augers, Extensions & Auger Bit File..... | E5 |
| Spade Drills, Bell Hanger Drills & Pilot Drills..... | E6 |
| Speed D Feed Bits, Flex-A-Bit, Pilot Drills & Accessories..... | E7 |
| Hole Saws..... | E8 |
| Hole Saw Kits & Arbors..... | E9 |
| Punch Kits & Accessories..... | E10-E11 |
| Reciprocals..... | E12 |
| Drywall Saws, PVC Saw & Cable Saw..... | E13 |
| LBK Knife, Tool Sharpener, PVC Cutter & Wire Stripper..... | E14 |
| Quick Sticks & Quick Leaders..... | E15 |
| First Aid Kits..... | E16-E17 |
| Safety Helmets, Rain Suit & Safety Vests..... | E18 |
| Protective Eyewear, Ear Protections & Dust Masks..... | E19 |
| Megapro Screwdrivers..... | E20-E21 |
| Replacement Bits & Socket Adapters..... | E22 |
| Bit Kits & Hand Drivers..... | E23 |
| Carded Insert & Power Bits..... | E24 |
| Bits & Tools, Magnetic Holder & Multi-Drive..... | E25 |
| Tamper Proof Insert Bits..... | E25 |
| Insert & Power Bits..... | E26 |
| Telescoping Pole Tool & Accessories..... | E27 |
| Shovels, Sledges & Pick, Caulking Guns..... | E28 |
| Wire Dispensers, Dollies & Hand Totes..... | E29 |
| Work Gloves & Latex Gloves..... | E30 |
| Flex Grip & Hybrid Gloves..... | E31 |
| Cut Level Gloves..... | E32 |
| Tool Belt & Pouches..... | E32 |
| Tool Holders Tech Gear™ & Accessories..... | E33 |
| Tool Holders & Organizers..... | E34 |
| Accessories & Web Straps..... | E35 |
| Dottie Pipe Supports..... | E36 |



FASTENERS & HARDWARE

SECTION **A**



FASTENERS & HARDWARE



FASTENERS & HARDWARE

SECTION **A**



FLAT HEAD SLOTTED

Flat head machine screws provide a flush surface. Length is determined from the top of the fastener head.



6-32

| CAT. NO. | UPC | SIZE | STD | SLV | MSTR | WT/STD |
|----------|-------|--------------|-----|-----|------|--------|
| FM63238 | 65000 | 6-32 x 3/8 | 100 | 500 | 4000 | 0.19# |
| FM63212 | 65002 | 6-32 x 1/2 | 100 | 500 | 4000 | 0.24# |
| FM63234 | 65004 | 6-32 x 3/4 | 100 | 500 | 4000 | 0.30# |
| FM6321 | 65006 | 6-32 x 1 | 100 | 500 | 4000 | 0.38# |
| FM632114 | 65008 | 6-32 x 1-1/4 | 100 | 500 | 4000 | 0.44# |
| FM632112 | 65010 | 6-32 x 1-1/2 | 100 | 500 | 4000 | 0.52# |
| FM6322 | 65012 | 6-32 x 2 | 100 | 500 | 3000 | 0.65# |
| FM632212 | 65014 | 6-32 x 2-1/2 | 100 | | 1000 | 0.79# |
| FM6323 | 65016 | 6-32 x 3 | 100 | | 1000 | 0.97# |

8-32

| | | | | | | |
|----------|-------|--------------|-----|-----|------|-------|
| FM83238 | 65050 | 8-32 x 3/8 | 100 | 500 | 4000 | 0.29# |
| FM83212 | 65052 | 8-32 x 1/2 | 100 | 500 | 4000 | 0.34# |
| FM83234 | 65054 | 8-32 x 3/4 | 100 | 500 | 4000 | 0.42# |
| FM8321 | 65056 | 8-32 x 1 | 100 | 500 | 4000 | 0.52# |
| FM832114 | 65058 | 8-32 x 1-1/4 | 100 | 500 | 4000 | 0.64# |
| FM832112 | 65060 | 8-32 x 1-1/2 | 100 | 500 | 3000 | 0.77# |
| FM8322 | 65062 | 8-32 x 2 | 100 | 500 | 3000 | 0.94# |
| FM832212 | 65064 | 8-32 x 2-1/2 | 100 | | 1000 | 1.25# |
| FM8323 | 65066 | 8-32 x 3 | 100 | | 1000 | 1.36# |

10-24

| | | | | | | |
|-----------|-------|---------------|-----|-----|------|-------|
| FM102438 | 65100 | 10-24 x 3/8 | 100 | 500 | 4000 | 0.36# |
| FM102412 | 65102 | 10-24 x 1/2 | 100 | 500 | 4000 | 0.45# |
| FM102434 | 65104 | 10-24 x 3/4 | 100 | 500 | 4000 | 0.57# |
| FM10241 | 65106 | 10-24 x 1 | 100 | 500 | 4000 | 0.73# |
| FM1024114 | 65108 | 10-24 x 1-1/4 | 100 | 500 | 4000 | 0.86# |
| FM1024112 | 65110 | 10-24 x 1-1/2 | 100 | 500 | 3000 | 0.94# |
| FM10242 | 65112 | 10-24 x 2 | 50 | 250 | 1500 | 0.65# |

10-32

| | | | | | | |
|-----------|-------|---------------|-----|-----|------|-------|
| FM103238 | 65150 | 10-32 x 3/8 | 100 | 500 | 4000 | 0.37# |
| FM103212 | 65152 | 10-32 x 1/2 | 100 | 500 | 4000 | 0.42# |
| FM103234 | 65154 | 10-32 x 3/4 | 100 | 500 | 4000 | 0.57# |
| FM10321 | 65156 | 10-32 x 1 | 100 | 500 | 4000 | 0.75# |
| FM1032114 | 65158 | 10-32 x 1-1/4 | 100 | 500 | 3000 | 0.87# |
| FM1032112 | 65160 | 10-32 x 1-1/2 | 100 | 500 | 3000 | 0.99# |
| FM10322 | 65162 | 10-32 x 2 | 50 | 250 | 1500 | 0.68# |
| FM10323 | 65151 | 10-32 x 3 | 100 | | 1000 | 2.03# |

1/4-20

| | | | | | | |
|---------|-------|-------------|-----|-----|------|-------|
| FM1438 | 65200 | 1/4 x 3/8 | 100 | 500 | 4000 | 0.69# |
| FM1412 | 65202 | 1/4 x 1/2 | 100 | 500 | 4000 | 0.78# |
| FM1434 | 65204 | 1/4 x 3/4 | 100 | 500 | 3000 | 1.12# |
| FM141 | 65206 | 1/4 x 1 | 100 | 500 | 3000 | 1.48# |
| FM14114 | 65208 | 1/4 x 1-1/4 | 100 | 500 | 3000 | 1.51# |
| FM14112 | 65210 | 1/4 x 1-1/2 | 50 | 250 | 1500 | 0.93# |
| FM142 | 65212 | 1/4 x 2 | 50 | 250 | 1500 | 1.13# |
| FM14212 | 65214 | 1/4 x 2-1/2 | 100 | | 1000 | 2.73# |
| FM143 | 65216 | 1/4 x 3 | 100 | | 1000 | 3.44# |
| FM144 | 65218 | 1/4 x 4 | 100 | | 1000 | 3.99# |

3/8-16

| | | | | | | |
|---------|-------|-------------|-----|--|------|--------|
| FM3834 | 65250 | 3/8 x 3/4 | 100 | | 1000 | 3.00# |
| FM381 | 65252 | 3/8 x 1 | 100 | | 1000 | 3.37# |
| FM38114 | 65254 | 3/8 x 1-1/4 | 100 | | 1000 | 4.82# |
| FM38112 | 65256 | 3/8 x 1-1/2 | 100 | | 1000 | 5.22# |
| FM382 | 65258 | 3/8 x 2 | 100 | | 1000 | 6.16# |
| FM38212 | 65260 | 3/8 x 2-1/2 | 100 | | 400 | 6.89# |
| FM383 | 65262 | 3/8 x 3 | 100 | | 400 | 8.52# |
| FM384 | 65264 | 3/8 x 4 | 100 | | 400 | 10.94# |

6-32 TUFF PACK

| | | | | | | |
|-----------|-------|--------------|-----|--|------|-------|
| FMT6321 | 65020 | 6-32 x 1 | 500 | | 3000 | 2.05# |
| FMT632114 | 65021 | 6-32 x 1-1/4 | 500 | | 3000 | 2.35# |
| FMT632112 | 65022 | 6-32 x 1-1/2 | 500 | | 3000 | 2.75# |
| FMT6322 | 65023 | 6-32 x 2 | 300 | | 1800 | 3.40# |

FEATURES:

- Machine Screws
- Flat Head
- Slotted
- Zinc Plated Steel
- Invincibox™ Up To 2"
- Tuff Pack

PACKAGING:



STD

SLV

MSTR

TUFF PACK

ROUND HEAD SLOTTED/PHILLIPS

PC 4000



Round head machine screws project above the material surface. This head style is used when clearance is not an important factor. Length is determined from the base of the fastener head.

FEATURES:

- Machine Screws
- Round Head
- Slotted/Phillips
- Zinc Plated Steel
- Invincibox™ Up To 2"
- Tuff Pack

PACKAGING:



STD



SLV



MSTR



TUFF PACK

6-32

| CAT. NO. | UPC | SIZE | STD | SLV | MSTR | WT/STD |
|-----------|-------|--------------|-----|-----|------|--------|
| RMC63212 | 55820 | 6-32 x 1/2 | 100 | 500 | 4000 | 0.20# |
| RMC63234 | 55822 | 6-32 x 3/4 | 100 | 500 | 4000 | 0.26# |
| RMC6321 | 55824 | 6-32 x 1 | 100 | 500 | 4000 | 0.37# |
| RMC632114 | 55825 | 6-32 x 1-1/4 | 100 | 500 | 4000 | 0.40# |
| RMC632112 | 55826 | 6-32 x 1-1/2 | 100 | 500 | 4000 | 0.49# |
| RMC6322 | 55827 | 6-32 x 2 | 100 | 500 | 3000 | 0.62# |
| RMC632212 | 55821 | 6-32 x 2-1/2 | 100 | | 1000 | 0.75# |
| RMC6323 | 55823 | 6-32 x 3 | 100 | | 1000 | 0.92# |

8-32

| | | | | | | |
|-----------|-------|--------------|-----|-----|------|-------|
| RMC83212 | 55840 | 8-32 x 1/2 | 100 | 500 | 4000 | 0.29# |
| RMC83234 | 55842 | 8-32 x 3/4 | 100 | 500 | 4000 | 0.40# |
| RMC8321 | 55844 | 8-32 x 1 | 100 | 500 | 4000 | 0.50# |
| RMC832114 | 55845 | 8-32 x 1-1/4 | 100 | 500 | 4000 | 0.72# |
| RMC832112 | 55846 | 8-32 x 1-1/2 | 100 | 500 | 3000 | 0.82# |
| RMC8322 | 55847 | 8-32 x 2 | 100 | 500 | 3000 | 1.03# |
| RMC832212 | 55880 | 8-32 x 2-1/2 | 100 | | 1000 | 1.25# |
| RMC8323 | 55884 | 8-32 x 3 | 100 | | 1000 | 1.52# |

10-24

| | | | | | | |
|------------|-------|---------------|-----|-----|------|-------|
| RMC102412 | 55860 | 10-24 x 1/2 | 100 | 500 | 4000 | 0.65# |
| RMC102434 | 55862 | 10-24 x 3/4 | 100 | 500 | 4000 | 0.66# |
| RMC10241 | 55864 | 10-24 x 1 | 100 | 500 | 4000 | 0.80# |
| RMC1024114 | 55865 | 10-24 x 1-1/4 | 100 | 500 | 3000 | 0.83# |
| RMC1024112 | 55866 | 10-24 x 1-1/2 | 100 | 500 | 3000 | 1.04# |
| RMC10242 | 55867 | 10-24 x 2 | 50 | 250 | 1500 | 1.38# |
| RMC10243 | 55869 | 10-24 x 3 | 100 | 500 | 3000 | 1.98# |

10-32

| | | | | | | |
|------------|-------|---------------|-----|-----|------|-------|
| RMC103212 | 55870 | 10-32 x 1/2 | 100 | 500 | 4000 | 0.40# |
| RMC103234 | 55872 | 10-32 x 3/4 | 100 | 500 | 4000 | 0.69# |
| RMC10321 | 55874 | 10-32 x 1 | 100 | 500 | 4000 | 0.82# |
| RMC1032114 | 55875 | 10-32 x 1-1/4 | 100 | 500 | 3000 | 0.99# |
| RMC1032112 | 55876 | 10-32 x 1-1/2 | 100 | 500 | 3000 | 1.15# |
| RMC10322 | 55877 | 10-32 x 2 | 50 | 250 | 1500 | 0.72# |

1/4-20

| | | | | | | |
|----------|-------|-------------|-----|-----|------|-------|
| RMC1438 | 55801 | 1/4 x 3/8 | 100 | 500 | 4000 | 0.88# |
| RMC1412 | 55800 | 1/4 x 1/2 | 100 | 500 | 4000 | 1.04# |
| RMC1434 | 55802 | 1/4 x 3/4 | 100 | 500 | 3000 | 1.21# |
| RMC141 | 55804 | 1/4 x 1 | 100 | 500 | 3000 | 1.51# |
| RMC14114 | 55805 | 1/4 x 1-1/4 | 100 | 500 | 3000 | 1.76# |
| RMC14112 | 55806 | 1/4 x 1-1/2 | 50 | 250 | 1500 | 1.02# |
| RMC142 | 55807 | 1/4 x 2 | 50 | 250 | 1500 | 1.27# |
| RMC14212 | 55812 | 1/4 x 2-1/2 | 100 | | 1000 | 2.92# |
| RMC143 | 55813 | 1/4 x 3 | 100 | | 1000 | 3.43# |
| RMC144 | 55814 | 1/4 x 4 | 100 | | 1000 | 4.59# |

3/8-16

| | | | | | | |
|----------|-------|-------------|-----|--|------|-------|
| RMC3834 | 55832 | 3/8 x 3/4 | 100 | | 1000 | 4.25# |
| RMC381 | 55833 | 3/8 x 1 | 100 | | 1000 | 4.28# |
| RMC38114 | 55834 | 3/8 x 1-1/4 | 100 | | 1000 | 4.77# |
| RMC38112 | 55835 | 3/8 x 1-1/2 | 100 | | 1000 | 5.22# |
| RMC382 | 55836 | 3/8 x 2 | 100 | | 1000 | 6.41# |
| RMC38212 | 55837 | 3/8 x 2-1/2 | 100 | | 400 | 7.57# |
| RMC383 | 55838 | 3/8 x 3 | 50 | | 200 | 4.22# |
| RMC384 | 55839 | 3/8 x 4 | 50 | | 200 | 5.01# |

6-32 TUFF PACK

| | | | | | | |
|------------|-------|--------------|-----|--|------|-------|
| RMCT6321 | 55828 | 6-32 x 1 | 500 | | 3000 | 2.04# |
| RMCT632114 | 55829 | 6-32 x 1-1/4 | 500 | | 3000 | 2.46# |
| RMCT632112 | 55830 | 6-32 x 1-1/2 | 500 | | 3000 | 2.72# |
| RMCT6322 | 55831 | 6-32 x 2 | 300 | | 1800 | 2.11# |

8-32 TUFF PACK

| | | | | | | |
|------------|-------|--------------|-----|--|------|-------|
| RMCT8321 | 55848 | 8-32 x 1 | 500 | | 3000 | 3.05# |
| RMCT832114 | 55849 | 8-32 x 1-1/4 | 500 | | 3000 | 3.65# |
| RMCT832112 | 55850 | 8-32 x 1-1/2 | 500 | | 3000 | 4.09# |
| RMCT8322 | 55851 | 8-32 x 2 | 300 | | 1800 | 3.20# |

1/4-20 TUFF PACK

| | | | | | | |
|-----------|-------|-------------|-----|--|------|-------|
| RMCT141 | 55808 | 1/4 x 1 | 300 | | 1800 | 7.69# |
| RMCT14114 | 55809 | 1/4 x 1-1/4 | 300 | | 1800 | 5.15# |
| RMCT14112 | 55810 | 1/4 x 1-1/2 | 250 | | 1500 | 5.15# |
| RMCT142 | 55811 | 1/4 x 2 | 150 | | 900 | 3.73# |

ROUND HEAD SQUARE/SLOTTED

PC 4020

Round head machine screws project above the material surface. This head style is used when clearance is not an important factor. Length is determined from the base of the fastener head.



6-32

| CAT. NO. | UPC | SIZE | STD | SLV | MSTR | WT/STD |
|------------|-------|--------------|-----|-----|------|--------|
| RMDS63238 | 65480 | 6-32 x 3/8 | 100 | 500 | 4000 | 0.19# |
| RMDS63212 | 65484 | 6-32 x 1/2 | 100 | 500 | 4000 | 0.26# |
| RMDS63234 | 65488 | 6-32 x 3/4 | 100 | 500 | 4000 | 0.26# |
| RMDS6321 | 65492 | 6-32 x 1 | 100 | 500 | 4000 | 0.33# |
| RMDS632114 | 65496 | 6-32 x 1-1/4 | 100 | 500 | 4000 | 0.40# |
| RMDS632112 | 65501 | 6-32 x 1-1/2 | 100 | 500 | 4000 | 0.49# |
| RMDS6322 | 65505 | 6-32 x 2 | 100 | 500 | 3000 | 0.62# |

8-32

| CAT. NO. | UPC | SIZE | STD | SLV | MSTR | WT/STD |
|------------|-------|--------------|-----|-----|------|--------|
| RMDS83238 | 65512 | 8-32 x 3/8 | 100 | 500 | 4000 | 0.23# |
| RMDS83212 | 65511 | 8-32 x 1/2 | 100 | 500 | 4000 | 0.29# |
| RMDS83234 | 65515 | 8-32 x 3/4 | 100 | 500 | 4000 | 0.40# |
| RMDS8321 | 65519 | 8-32 x 1 | 100 | 500 | 4000 | 0.50# |
| RMDS832114 | 65523 | 8-32 x 1-1/4 | 100 | 500 | 4000 | 0.72# |
| RMDS832112 | 65430 | 8-32 x 1-1/2 | 100 | 500 | 3000 | 0.82# |
| RMDS8322 | 65520 | 8-32 x 2 | 100 | 500 | 3000 | 0.93# |

10-24

| CAT. NO. | UPC | SIZE | STD | SLV | MSTR | WT/STD |
|-------------|-------|---------------|-----|-----|------|--------|
| RMDS102412 | 65434 | 10-24 x 1/2 | 100 | 500 | 4000 | 0.49# |
| RMDS102434 | 65438 | 10-24 x 3/4 | 100 | 500 | 4000 | 0.62# |
| RMDS10241 | 65442 | 10-24 x 1 | 100 | 500 | 4000 | 0.75# |
| RMDS1024114 | 65446 | 10-24 x 1-1/4 | 100 | 500 | 3000 | 0.95# |
| RMDS1024112 | 65450 | 10-24 x 1-1/2 | 100 | 500 | 3000 | 1.03# |
| RMDS10242 | 65454 | 10-24 x 2 | 50 | 250 | 1500 | 0.66# |

10-32

| CAT. NO. | UPC | SIZE | STD | SLV | MSTR | WT/STD |
|-------------|-------|---------------|-----|-----|------|--------|
| RMDS103238 | 65458 | 10-32 x 3/8 | 100 | 500 | 4000 | 0.32# |
| RMDS103212 | 65457 | 10-32 x 1/2 | 100 | 500 | 4000 | 0.49# |
| RMDS103234 | 65464 | 10-32 x 3/4 | 100 | 500 | 4000 | 0.62# |
| RMDS10321 | 65468 | 10-32 x 1 | 100 | 500 | 4000 | 0.75# |
| RMDS1032114 | 65469 | 10-32 x 1-1/4 | 100 | 500 | 3000 | 0.85# |
| RMDS1032112 | 65471 | 10-32 x 1-1/2 | 100 | 500 | 3000 | 0.94# |
| RMDS10322 | 65467 | 10-32 x 2 | 50 | 250 | 1500 | 0.66# |

1/4-20

| CAT. NO. | UPC | SIZE | STD | SLV | MSTR | WT/STD |
|-----------|-------|-------------|-----|-----|------|--------|
| RMDS1412 | 65400 | 1/4 x 1/2 | 100 | 500 | 4000 | 0.97# |
| RMDS1434 | 65404 | 1/4 x 3/4 | 100 | 500 | 3000 | 1.19# |
| RMDS141 | 65408 | 1/4 x 1 | 100 | 500 | 3000 | 1.45# |
| RMDS14114 | 65412 | 1/4 x 1-1/4 | 100 | 500 | 3000 | 1.69# |
| RMDS14112 | 65416 | 1/4 x 1-1/2 | 50 | 250 | 1500 | 0.99# |
| RMDS142 | 65420 | 1/4 x 2 | 50 | 250 | 1500 | 1.21# |
| RMDS14212 | 65424 | 1/4 x 2-1/2 | 100 | | 1000 | 2.73# |

FEATURES:

- Machine Screws
- Round Head
- Square/Slotted
- Zinc Plated Steel
- Invincibox™ Up To 2"
- Tuff Pack

PACKAGING:



STD

SLV



MSTR



TUFF PACK

TRUSS HEAD SLOTTED/PHILLIPS (COMBO)

PC 4005

Truss Head Machine Screws are needed when installing wiring devices behind wall plates. The perfect screw when a low profile fastener is needed.



6-32

| CAT. NO. | UPC | SIZE | STD | SLV | MSTR | WT/STD |
|-----------|-------|--------------|-----|-----|------|--------|
| TMC63212 | 11646 | 6-32 x 1/2 | 100 | 500 | 4000 | 0.20# |
| TMC63234 | 11647 | 6-32 x 3/4 | 100 | 500 | 4000 | 0.26# |
| TMC6321 | 11648 | 6-32 x 1 | 100 | 500 | 4000 | 0.37# |
| TMC632114 | 11649 | 6-32 x 1-1/4 | 100 | 500 | 4000 | 0.40# |
| TMC632112 | 11650 | 6-32 x 1-1/2 | 100 | 500 | 4000 | 0.49# |
| TMC6322 | 11651 | 6-32 x 2 | 100 | 500 | 3000 | 0.68# |
| TMC6323 | 81479 | 6-32 x 3 | 100 | | 1000 | 0.96# |
| TMC6324 | 81480 | 6-32 x 4 | 100 | | 1000 | 1.23# |

FEATURES:

- Machine Screws
- Truss Head
- Slotted/Phillips
- Zinc Plated Steel
- Invincibox™ Up To 2"
- Tuff Pack

FLAT HEAD SQUARE/PHILLIPS

PC 4020



Flat head machine screws provide a flush surface. Length is determined from the top of the fastener head.

FEATURES:

- Machine Screws
- Flat Head
- Square/Phillips
- Zinc Plated Steel
- Invincibox™ Up To 2"
- Tuff Pack

PACKAGING:



STD



SLV



MSTR



TUFF PACK

6-32

| CAT. NO. | UPC | SIZE | STD | SLV | MSTR | WT/STD |
|------------|-------|--------------|-----|-----|------|--------|
| FMDD63212 | 65482 | 6-32 x 1/2 | 100 | 500 | 4000 | 0.20# |
| FMDD63234 | 65486 | 6-32 x 3/4 | 100 | 500 | 4000 | 0.26# |
| FMDD6321 | 65490 | 6-32 x 1 | 100 | 500 | 4000 | 0.33# |
| FMDD632114 | 65494 | 6-32 x 1-1/4 | 100 | 500 | 4000 | 0.40# |
| FMDD632112 | 65498 | 6-32 x 1-1/2 | 100 | 500 | 4000 | 0.49# |
| FMDD6322 | 65503 | 6-32 x 2 | 100 | 500 | 3000 | 0.62# |

8-32

| | | | | | | |
|------------|-------|--------------|-----|-----|------|-------|
| FMDD83212 | 65509 | 8-32 x 1/2 | 100 | 500 | 4000 | 0.29# |
| FMDD83234 | 65513 | 8-32 x 3/4 | 100 | 500 | 4000 | 0.40# |
| FMDD8321 | 65517 | 8-32 x 1 | 100 | 500 | 4000 | 0.50# |
| FMDD832114 | 65521 | 8-32 x 1-1/4 | 100 | 500 | 4000 | 0.61# |
| FMDD832112 | 65525 | 8-32 x 1-1/2 | 100 | 500 | 4000 | 0.72# |

10-24

| | | | | | | |
|-------------|-------|---------------|-----|-----|------|-------|
| FMDD102412 | 65435 | 10-24 x 1/2 | 100 | 500 | 4000 | 0.49# |
| FMDD102434 | 65436 | 10-24 x 3/4 | 100 | 500 | 4000 | 0.62# |
| FMDD10241 | 65440 | 10-24 x 1 | 100 | 500 | 4000 | 0.75# |
| FMDD1024114 | 65444 | 10-24 x 1-1/4 | 100 | 500 | 3000 | 0.95# |
| FMDD1024112 | 65448 | 10-24 x 1-1/2 | 100 | 500 | 3000 | 1.03# |
| FMDD10242 | 65452 | 10-24 x 2 | 50 | 250 | 1500 | 0.66# |

10-32

| | | | | | | |
|------------|-------|-------------|-----|-----|------|-------|
| FMDD103212 | 65460 | 10-32 x 1/2 | 100 | 500 | 4000 | 0.49# |
| FMDD10321 | 65466 | 10-32 x 1 | 100 | 500 | 4000 | 0.75# |

1/4-20

| | | | | | | |
|-----------|-------|-------------|-----|-----|------|-------|
| FMDD1412 | 65476 | 1/4 x 1/2 | 100 | 500 | 4000 | 0.76# |
| FMDD1434 | 65402 | 1/4 x 3/4 | 100 | 500 | 3000 | 1.19# |
| FMDD141 | 65406 | 1/4 x 1 | 100 | 500 | 3000 | 1.45# |
| FMDD14114 | 65410 | 1/4 x 1-1/4 | 100 | 500 | 3000 | 1.69# |
| FMDD14112 | 65414 | 1/4 x 1-1/2 | 50 | 250 | 1500 | 0.99# |
| FMDD142 | 65418 | 1/4 x 2 | 50 | 250 | 1500 | 1.21# |
| FMDD14212 | 65422 | 1/4 x 2-1/2 | 100 | | 1000 | 2.73# |

TRUSS HEAD SLOTTED STOVE BOLTS WITH NUTS

PC 4022



Stove bolts have a truss head and are furnished with hex nuts. The head projects above the material surface. This head style is used when clearance is an important factor. Length is determined from the base of the fastener head.

FEATURES:

- Stove Bolts
- Truss Head
- Slotted
- Includes Nuts
- Zinc Plated Steel
- Invincibox™ Up To 2"
- Tuff Pack

3/16 (10-24)

| CAT. NO. | UPC | SIZE | STD | SLV | MSTR | WT/STD |
|----------|-------|--------------|-----|-----|------|--------|
| SB31612 | 57900 | 3/16 x 1/2 | 100 | 500 | 4000 | 0.89# |
| SB31634 | 57902 | 3/16 x 3/4 | 100 | 500 | 4000 | 1.04# |
| SB3161 | 57904 | 3/16 x 1 | 100 | 500 | 3000 | 1.18# |
| SB316114 | 57906 | 3/16 x 1-1/4 | 100 | 500 | 3000 | 1.33# |
| SB316112 | 57908 | 3/16 x 1-1/2 | 100 | 500 | 3000 | 1.47# |
| SB3162 | 57910 | 3/16 x 2 | 100 | 500 | 3000 | 1.76# |

1/4-20

| | | | | | | |
|---------|-------|-------------|-----|-----|------|-------|
| SB1412 | 57950 | 1/4 x 1/2 | 100 | 500 | 3000 | 1.74# |
| SB1434 | 57952 | 1/4 x 3/4 | 100 | 500 | 3000 | 2.11# |
| SB141 | 57954 | 1/4 x 1 | 100 | 500 | 3000 | 2.26# |
| SB14114 | 57956 | 1/4 x 1-1/4 | 100 | 500 | 1000 | 2.52# |
| SB14112 | 57958 | 1/4 x 1-1/2 | 100 | | 1000 | 2.78# |
| SB142 | 57960 | 1/4 x 2 | 100 | | 1000 | 3.30# |

WALL PLATE SLOTTED OVAL HEAD

PC 4040

Oval Head Wall Plate screws are available in a variety of painted finishes such as Ivory, White, Brown and Almond. They are also available in tamperproof stainless steel or slotted stainless steel, nylon and brass plated. Selected items in lengths of 5/16", 1/2", 3/4" and 1".



| CAT. NO. | UPC | SIZE | COLOR | STD | SLV | MSTR | WT/STD |
|----------|-------|-------------|--------------|-----|-----|------|--------|
| 413BRN | 15892 | 6-32 x 5/16 | Brown | 100 | 500 | 4000 | 0.18# |
| 413IV | 15894 | 6-32 x 5/16 | Ivory | 100 | 500 | 4000 | 0.18# |
| 413WHT | 15896 | 6-32 x 5/16 | White | 100 | 500 | 4000 | 0.18# |
| 413ALD | 15898 | 6-32 x 5/16 | Almond | 100 | 500 | 4000 | 0.18# |
| 414BRS | 15900 | 6-32 x 1/2 | Brass | 100 | 500 | 4000 | 0.24# |
| 414BRN | 15905 | 6-32 x 1/2 | Brown | 100 | 500 | 4000 | 0.24# |
| 414IV | 15910 | 6-32 x 1/2 | Ivory | 100 | 500 | 4000 | 0.24# |
| 414NY | 15913 | 6-32 x 1/2 | Nylon | 100 | 500 | 4000 | 0.24# |
| 414SS | 15915 | 6-32 x 1/2 | Stainless | 100 | 500 | 4000 | 0.24# |
| 414TP | 15917 | 6-32 x 1/2 | Tamper Proof | 100 | 500 | 4000 | 0.24# |
| 414WHT | 15920 | 6-32 x 1/2 | White | 100 | 500 | 4000 | 0.24# |
| 414ALD | 15922 | 6-32 x 1/2 | Almond | 100 | 500 | 4000 | 0.24# |
| 415IV | 15925 | 6-32 x 3/4 | Ivory | 50 | 250 | 2000 | 0.16# |
| 415BRN | 15930 | 6-32 x 3/4 | Brown | 50 | 250 | 2000 | 0.16# |
| 415WHT | 15935 | 6-32 x 3/4 | White | 50 | 250 | 2000 | 0.16# |
| 415ALD | 15937 | 6-32 x 3/4 | Almond | 50 | 250 | 2000 | 0.16# |
| 416IV | 15940 | 6-32 x 1 | Ivory | 50 | 250 | 2000 | 0.20# |
| 416BRN | 15945 | 6-32 x 1 | Brown | 50 | 250 | 2000 | 0.20# |
| 416WHT | 15950 | 6-32 x 1 | White | 50 | 250 | 2000 | 0.20# |
| 416ALD | 15955 | 6-32 x 1 | Almond | 50 | 250 | 2000 | 0.20# |

FEATURES:

- Wall Plate Screws
- Oval Head
- Chip Resistant
- Slotted
- Painted or Plated

Wall Plate Screw Kits... Page B17



APS1 12 Compartment consisting of 450 assorted screws: White, Ivory, Almond, Stainless, Brass & Nylon

APS2 6 Compartment consisting of 450 assorted screws: White, Almond & Ivory

GROUND SCREWS

PC 5620

Ground screws are plated green for identification purposes and are used for grounding pigtails or wire. They have either a 1/4" or 5/16" head with Hex/Slotted/Phillips/Square drive. The 1/4" (1032G & 1032GTP) has a leader point; the 5/16" (1032TC & 1032TCTP) has a thread cutting point.



| CAT. NO. | UPC | DESCRIPTION | HEX SIZE | SCREW SIZE | SLV | MSTR | WT/STD |
|----------|-------|--|----------|--------------|-----|------|--------|
| 1032G | 14107 | Leader Point Hex/Slotted/Phillips/Square | 1/4" | 10-32 x 3/8" | 100 | 1000 | 0.44# |
| 1032GTP | 14108 | Tuff Pack | 1/4" | 10-32 x 3/8" | 500 | 3000 | 2.20# |
| 1032TC | 14109 | Thread Cutting Pt. Hex/Slotted/Phillips/Square | 5/16" | 10-32 x 3/8" | 100 | 1000 | 0.50# |
| 1032TCTP | 14111 | Tuff Pack | 5/16" | 10-32 x 3/8" | 500 | 3000 | 2.55# |

FEATURES:

- Steel
- Green Zinc Plated
- 1/4" or 5/16" Head
- Leader or Thread Cutting Point
- Hex/Slotted/Phillips/Square
- Invincibox™
- Tuff Pack

MUSHROOM HEAD WITH SPRING WING

PC 4050

FASTENERS & HARDWARE



Light to medium duty anchors for use in hollow walls. Mushroom head provides a large bearing surface.

1/8 (6-32)

| CAT. NO. | UPC | SIZE | DRILL | DESCRIPTION | STD | MSTR | WT/STD |
|----------|-------|---------|-------|--------------------------|-----|------|--------|
| TBC82 | 16848 | 1/8 x 2 | 3/8" | Slotted/Phillips (Combo) | 50 | 500 | 0.75# |
| TB82DS | 15392 | 1/8 x 2 | | Square/Slotted (Combo) | 50 | 500 | 0.75# |
| TBC83 | 16846 | 1/8 x 3 | | Slotted/Phillips (Combo) | 50 | 500 | 0.88# |
| TB83DS | 15397 | 1/8 x 3 | | Square/Slotted (Combo) | 50 | 500 | 1.00# |
| TBC84 | 16847 | 1/8 x 4 | | Slotted/Phillips (Combo) | 50 | 500 | 1.02# |
| TB84DS | 15402 | 1/8 x 4 | | Square/Slotted (Combo) | 50 | 500 | 1.00# |

3/16 (10-24)

| CAT. NO. | UPC | SIZE | DRILL | DESCRIPTION | STD | MSTR | WT/STD |
|----------|-------|----------|---------|--------------------------|-----|-------|--------|
| TBC362 | 16849 | 3/16 x 2 | 1/2" | Slotted/Phillips (Combo) | 50 | 500 | 1.63# |
| TB362DS | 16792 | 3/16 x 2 | | Square/Slotted (Combo) | 50 | 500 | 1.63# |
| TBC363 | 16850 | 3/16 x 3 | | Slotted/Phillips (Combo) | 50 | 500 | 1.84# |
| TB363DS | 16797 | 3/16 x 3 | | Square/Slotted (Combo) | 50 | 500 | 1.84# |
| TBC364 | 16855 | 3/16 x 4 | | Slotted/Phillips (Combo) | 50 | 500 | 2.50# |
| TB364DS | 16802 | 3/16 x 4 | | Square/Slotted (Combo) | 50 | 500 | 2.50# |
| TB366 | 16810 | 3/16 x 6 | Slotted | 50 | 500 | 3.28# | |

1/4-20

| CAT. NO. | UPC | SIZE | DRILL | DESCRIPTION | STD | MSTR | WT/STD |
|----------|-------|---------|---------|--------------------------|-----|-------|--------|
| TBC42 | 16859 | 1/4 x 2 | 5/8" | Slotted/Phillips (Combo) | 50 | 500 | 2.65# |
| TBC43 | 16860 | 1/4 x 3 | | Slotted/Phillips (Combo) | 50 | 500 | 3.22# |
| TB43DS | 15197 | 1/4 x 3 | | Square/Slotted (Combo) | 50 | 500 | 3.25# |
| TBC44 | 16865 | 1/4 x 4 | | Slotted/Phillips (Combo) | 50 | 500 | 3.80# |
| TB44DS | 15202 | 1/4 x 4 | | Square/Slotted (Combo) | 50 | 500 | 3.50# |
| TB45 | 15205 | 1/4 x 5 | | Slotted | 50 | 500 | 3.98# |
| TB46 | 15210 | 1/4 x 6 | Slotted | 50 | 500 | 4.50# | |

3/8-16

| CAT. NO. | UPC | SIZE | DRILL | DESCRIPTION | STD | MSTR | WT/STD |
|----------|-------|---------|-------|-------------|-----|------|--------|
| TB383 | 16815 | 3/8 x 3 | 7/8" | Slotted | 50 | 500 | 6.68# |
| TB384 | 16820 | 3/8 x 4 | | Slotted | 50 | 200 | 8.55# |
| TB385 | 16825 | 3/8 x 5 | | Slotted | 25 | 100 | 5.10# |
| TB386 | 16830 | 3/8 x 6 | | Slotted | 25 | 100 | 8.89# |

1/2-13

| CAT. NO. | UPC | SIZE | DRILL | DESCRIPTION | STD | MSTR | WT/STD |
|----------|-------|---------|--------|-------------|-----|------|--------|
| TB124 | 16835 | 1/2 x 4 | 1-1/4" | Slotted | 25 | 100 | 11.12# |
| TB125 | 16840 | 1/2 x 5 | | Slotted | 25 | 100 | 11.09# |
| TB126 | 16845 | 1/2 x 6 | | Slotted | 25 | 100 | 11.06# |

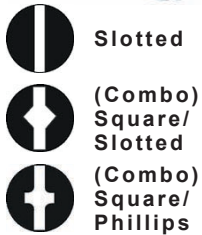

FEATURES:

- Toggle Bolts
- Mushroom Head
- Zinc Plated Steel
- Slotted/Phillips Combo
- Square/Slotted Combo
- Slotted



ALLOWABLE LOAD CAPACITIES FOR TOGGLE BOLTS IN WALLBOARD

| ANCHOR DIAMETER | 3/8 WALLBOARD | | 1/2 WALLBOARD | | 5/8 WALLBOARD | | 3/4 WALLBOARD | |
|-----------------|---------------|-------|---------------|-------|---------------|-------|---------------|-------|
| | TENSION | SHEER | TENSION | SHEER | TENSION | SHEER | TENSION | SHEER |
| | LBS. | | LBS. | | LBS. | | LBS. | |
| 1/8" | 30 | 30 | 40 | 35 | 50 | 45 | 55 | 55 |
| 3/16" | 35 | 30 | 45 | 50 | 60 | 60 | 75 | 70 |
| 1/4" | 55 | 55 | 60 | 60 | 65 | 65 | 80 | 75 |
| 3/8" | 60 | 65 | 65 | 75 | 75 | 80 | 85 | 90 |
| 1/2" | 65 | 70 | 80 | 80 | 100 | 95 | 105 | 100 |

Allowable load capacities listed are calculated using an applied safest factor of 4.0.

TECH TALK

Zinc Chromate & Stainless Steel

Zinc Chromate plating is the most widely used plating, and is designated in our catalog as Zinc plated. It has good to excellent corrosion resistance and is relatively non-toxic.

Stainless Steel is provided in 18-8 unless other grades are requested. 18-8 is durable, non-magnetic and highly corrosion resistant. It is the most popular and readily available.

ONE WAY MACHINE SCREWS-STAINLESS

PC 6680

One way round head screws can be installed with a conventional slotted screwdriver, but can only be removed with a one-way tamper proof removal tool. Note: This tool has two protruding carbide tips which dig in and grip the screw for removal. While similar in appearance, it is not a spanner driver.



6-32

| CAT. NO. | UPC | SIZE | DRIVER | STD | WT/STD |
|-----------|-------|--------------|--------|-----|--------|
| T63212OR | 09968 | 6-32 x 1/2 | OW68 | 100 | 0.24# |
| T63234OR | 09978 | 6-32 x 3/4 | OW68 | 100 | 0.32# |
| T6321OR | 09972 | 6-32 x 1 | OW68 | 100 | 0.39# |
| T632112OR | 09962 | 6-32 x 1-1/2 | OW68 | 100 | 0.53# |
| T6322OR | 09975 | 6-32 x 2 | OW68 | 100 | 0.68# |

8-32

| CAT. NO. | UPC | SIZE | DRIVER | STD | WT/STD |
|-----------|-------|--------------|--------|-----|--------|
| T83212OR | 09990 | 8-32 x 1/2 | OW810 | 100 | 0.39# |
| T83234OR | 10001 | 8-32 x 3/4 | OW810 | 100 | 0.50# |
| T8321OR | 09994 | 8-32 x 1 | OW810 | 100 | 0.62# |
| T832112OR | 09982 | 8-32 x 1-1/2 | OW810 | 100 | 0.83# |
| T8322OR | 09998 | 8-32 x 2 | OW810 | 100 | 1.06# |

10-24

| CAT. NO. | UPC | SIZE | DRIVER | STD | WT/STD |
|------------|-------|---------------|--------|-----|--------|
| T102412OR | 09905 | 10-24 x 1/2 | OW810 | 100 | 0.54# |
| T102434OR | 09915 | 10-24 x 3/4 | OW810 | 100 | 0.69# |
| T10241OR | 09909 | 10-24 x 1 | OW810 | 100 | 0.83# |
| T1024112OR | 09897 | 10-24 x 1-1/2 | OW810 | 100 | 1.11# |
| T10242OR | 09912 | 10-24 x 2 | OW810 | 50 | 0.69# |

10-32

| CAT. NO. | UPC | SIZE | DRIVER | STD | WT/STD |
|------------|-------|---------------|--------|-----|--------|
| T103212OR | 09925 | 10-32 x 1/2 | OW810 | 100 | 0.54# |
| T103234OR | 09936 | 10-32 x 3/4 | OW810 | 100 | 0.69# |
| T10321OR | 09930 | 10-32 x 1 | OW810 | 100 | 0.83# |
| T1032112OR | 09919 | 10-32 x 1-1/2 | OW810 | 100 | 1.11# |
| T10322OR | 09933 | 10-32 x 2 | OW810 | 50 | 0.69# |

1/4-20

| CAT. NO. | UPC | SIZE | DRIVER | STD | WT/STD |
|----------|-------|-------------|--------|-----|--------|
| T1412OR | 09948 | 1/4 x 1/2 | OW1214 | 100 | 1.11# |
| T1434OR | 09958 | 1/4 x 3/4 | OW1214 | 100 | 1.36# |
| T141OR | 09952 | 1/4 x 1 | OW1214 | 100 | 1.61# |
| T14112OR | 09940 | 1/4 x 1-1/2 | OW1214 | 50 | 1.06# |

FEATURES:

- Machine Screws
- Round Head
- 18-8 Stainless Steel
- One Way Tamper Proof
- Invincibox™ Up To 2"

PACKAGING:



ONE WAY HAND DRIVER (REMOVAL TOOL)

PC 6670

This tool has two protruding carbide tips which dig in and grip the screw for removal. While similar in appearance, it is not a spanner driver.



| CAT. NO. | UPC | SIZE | DESCRIPTION | STD | MSTR | WT/STD |
|----------|-------|---------|--------------|-----|------|--------|
| OW68 | 23000 | #6-#8 | Removal Tool | 1 | 10 | 0.25# |
| OW810 | 23005 | #8-#10 | Removal Tool | 1 | 10 | 0.31# |
| OW1214 | 23010 | #12-#14 | Removal Tool | 1 | 10 | 0.35# |

FEATURES:

- Hard Drivers Tamper Proof
- One Way

TECH TALK

Dottie Provides the Four Most Popular Types of Tamper Proof Screws and Related Tools

They are: One Way, Spanner, Hex Pin, and Star Pin (Torx®). Tamperproof screws are available in stainless steel and black or alloy steel, stainless being the most preferred. We will provide stainless screws unless otherwise requested – subject to availability.



SPANNER MACHINE SCREWS-STAINLESS

PC 6680



FEATURES:

- Machine Screws
- Pan or Flat Head*
- 18-8 Stainless Steel
- Spanner Tamper Proof
- Invincibox™ Up To 2"

PACKAGING:



STD



SLV



MSTR

Tamper resistant screws are designed to prevent vandalism and theft. Use proper bit or driver to remove (one way, hex pin, star pin or spanner). Choose from the head style available: Pan or Flat.

6-32

| CAT. NO. | UPC | SIZE | INSERT BIT | DRIVER STD | WT/STD |
|-----------|-------|--------------|------------|------------|--------|
| T63212SP | 11730 | 6-32 x 1/2 | 115-6 | SPN6 100 | 0.24# |
| T63234SP | 11731 | 6-32 x 3/4 | 115-6 | SPN6 100 | 0.32# |
| T6321SP | 11732 | 6-32 x 1 | 115-6 | SPN6 100 | 0.39# |
| T632114SP | 11733 | 6-32 x 1-1/4 | 115-6 | SPN6 100 | 0.46# |
| T632112SP | 11734 | 6-32 x 1-1/2 | 115-6 | SPN6 100 | 0.53# |
| T6322SP | 11735 | 6-32 x 2 | 115-6 | SPN6 100 | 0.68# |

8-32

| CAT. NO. | UPC | SIZE | INSERT BIT | DRIVER STD | WT/STD |
|-----------|-------|--------------|------------|------------|--------|
| T83212SP | 11736 | 8-32 x 1/2 | 115-8 | SPN8 100 | 0.39# |
| T83234SP | 11737 | 8-32 x 3/4 | 115-8 | SPN8 100 | 0.50# |
| T8321SP | 11738 | 8-32 x 1 | 115-8 | SPN8 100 | 0.62# |
| T832114SP | 11739 | 8-32 x 1-1/4 | 115-8 | SPN8 100 | 0.73# |
| T832112SP | 11740 | 8-32 x 1-1/2 | 115-8 | SPN8 100 | 0.83# |
| T8322SP | 11741 | 8-32 x 2 | 115-8 | SPN8 100 | 1.06# |

10-24

| CAT. NO. | UPC | SIZE | INSERT BIT | DRIVER STD | WT/STD |
|------------|-------|---------------|------------|------------|--------|
| T102412SP | 11742 | 10-24 x 1/2 | 115-10 | SPN10 100 | 0.54# |
| T102434SP | 11743 | 10-24 x 3/4 | 115-10 | SPN10 100 | 0.69# |
| T10241SP | 11744 | 10-24 x 1 | 115-10 | SPN10 100 | 0.83# |
| T1024114SP | 11745 | 10-24 x 1-1/4 | 115-10 | SPN10 100 | 0.97# |
| T1024112SP | 11746 | 10-24 x 1-1/2 | 115-10 | SPN10 100 | 1.11# |
| T10242SP | 11747 | 10-24 x 2 | 115-10 | SPN10 50 | 0.69# |

10-32

| CAT. NO. | UPC | SIZE | INSERT BIT | DRIVER STD | WT/STD |
|------------|-------|---------------|------------|------------|--------|
| T103212SP | 11748 | 10-32 x 1/2 | 115-10 | SPN10 100 | 0.54# |
| T103234SP | 11749 | 10-32 x 3/4 | 115-10 | SPN10 100 | 0.69# |
| T10321SP | 11750 | 10-32 x 1 | 115-10 | SPN10 100 | 0.83# |
| T1032114SP | 11751 | 10-32 x 1-1/4 | 115-10 | SPN10 100 | 0.97# |
| T1032112SP | 11752 | 10-32 x 1-1/2 | 115-10 | SPN10 100 | 1.11# |
| T10322SP | 11753 | 10-32 x 2 | 115-10 | SPN10 50 | 0.69# |

1/4-20

| CAT. NO. | UPC | SIZE | INSERT BIT | DRIVER STD | WT/STD |
|----------|-------|-------------|------------|------------|--------|
| T1412SP | 11754 | 1/4 x 1/2 | 115-14 | SPN14 100 | 1.11# |
| T1434SP | 11755 | 1/4 x 3/4 | 115-14 | SPN14 100 | 1.36# |
| T141SP | 11756 | 1/4 x 1 | 115-14 | SPN14 100 | 1.61# |
| T14114SP | 11757 | 1/4 x 1-1/4 | 115-14 | SPN14 100 | 1.87# |
| T14112SP | 11758 | 1/4 x 1-1/2 | 115-14 | SPN14 50 | 1.06# |
| T142SP | 11759 | 1/4 x 2 | 115-14 | SPN14 50 | 1.31# |

* Flat head available on special order, when ordering replace suffix 'P' with 'F'.

SPANNER INSERT BITS & HAND DRIVERS

PC 6720, 6710, 6670



Spanner Screws must be installed or removed using a matching drive which reduces the chances of unauthorized removal. Available in Hand Drivers and Insert Bits.

FEATURES:

- Insert Bits Spanner
- Hand Drivers Spanner
- Magnetic Bit Holder
- Magnetic Hand Driver

INSERT BITS - PC 6720

| CAT. NO. | UPC | SCREW SIZE | DESCRIPTION | STD | MSTR | WT/STD |
|----------|-------|------------|-------------|-----|------|--------|
| 1156 | 31156 | #6 | Spanner Bit | 1 | 5 | 0.01# |
| 1158 | 31158 | #8 | Spanner Bit | 1 | 5 | 0.01# |
| 11510 | 31150 | #10 | Spanner Bit | 1 | 5 | 0.02# |
| 11512 | 31152 | #12 | Spanner Bit | 1 | 5 | 0.02# |
| 11514 | 31154 | #14 | Spanner Bit | 1 | 5 | 0.02# |

HAND DRIVERS - PC 6670

| CAT. NO. | UPC | SCREW SIZE | DESCRIPTION | STD | MSTR | WT/STD |
|----------|-------|------------|---------------------|-----|------|--------|
| SPN6 | 23015 | #6 | Spanner Hand Driver | 1 | 10 | 0.22# |
| SPN8 | 23020 | #8 | Spanner Hand Driver | 1 | 10 | 0.22# |
| SPN10 | 23025 | #10 | Spanner Hand Driver | 1 | 10 | 0.22# |

MAGNETIC BIT HOLDER - PC 6710

| CAT. NO. | UPC | DESCRIPTION | STD | MSTR | WT/STD |
|----------|-------|------------------------------|-----|------|--------|
| MBH | 16948 | 1/4 x 3" Magnetic Bit Holder | 1 | 10 | 0.11# |

MAGNETIC HAND DRIVER - PC 6720

| CAT. NO. | UPC | DESCRIPTION | STD | MSTR | WT/STD |
|----------|-------|-------------------------|-----|------|--------|
| MHD | 16949 | 8" Magnetic Hand Driver | 1 | 1 | 0.20# |

HEX PIN MACHINE SCREWS-STAINLESS

PC 6680

Tamper resistant screws are designed to prevent vandalism and theft. Use proper bit or driver to remove (one way, hex pin, star pin or spanner). Choose from the head style available: Button or Flat.



6-32

| CAT. NO. | UPC | SIZE | INSERT BIT | DRIVER STD | WT/STD |
|-----------|-------|--------------|------------|------------|-----------|
| T63212HB | 11787 | 6-32 x 1/2 | 73TR4 | HPD18 | 100 0.24# |
| T63234HB | 11788 | 6-32 x 3/4 | 73TR5 | HPD18 | 100 0.32# |
| T6321HB | 11789 | 6-32 x 1 | 73TR5 | HPD18 | 100 0.39# |
| T632114HB | 11790 | 6-32 x 1-1/4 | 73TR5 | HPD18 | 100 0.46# |
| T632112HB | 11791 | 6-32 x 1-1/2 | 73TR5 | HPD18 | 100 0.53# |

8-32

| CAT. NO. | UPC | SIZE | INSERT BIT | DRIVER STD | WT/STD |
|-----------|-------|--------------|------------|------------|-----------|
| T83212HB | 11792 | 8-32 x 1/2 | 73TR7 | HPD532 | 100 0.39# |
| T83234HB | 11793 | 8-32 x 3/4 | 73TR7 | HPD532 | 100 0.50# |
| T8321HB | 11794 | 8-32 x 1 | 73TR7 | HPD532 | 100 0.62# |
| T832114HB | 11795 | 8-32 x 1-1/4 | 73TR7 | HPD532 | 100 0.73# |
| T832112HB | 11796 | 8-32 x 1-1/2 | 73TR7 | HPD532 | 100 0.83# |
| T8322HB | 11797 | 8-32 x 2 | 73TR7 | HPD532 | 100 1.06# |

10-24

| CAT. NO. | UPC | SIZE | INSERT BIT | DRIVER STD | WT/STD |
|------------|-------|---------------|------------|------------|-----------|
| T102412HB | 11798 | 10-24 x 1/2 | 73TR7 | HPD532 | 100 0.54# |
| T102434HB | 11799 | 10-24 x 3/4 | 73TR7 | HPD532 | 100 0.69# |
| T10241HB | 11800 | 10-24 x 1 | 73TR7 | HPD532 | 100 0.83# |
| T1024114HB | 11801 | 10-24 x 1-1/4 | 73TR7 | HPD532 | 100 0.97# |
| T1024112HB | 11802 | 10-24 x 1-1/2 | 73TR7 | HPD532 | 100 1.11# |

10-32

| CAT. NO. | UPC | SIZE | INSERT BIT | DRIVER STD | WT/STD |
|------------|-------|---------------|------------|------------|-----------|
| T103212HB | 11803 | 10-32 x 1/2 | 73TR7 | HPD532 | 100 0.54# |
| T103234HB | 11804 | 10-32 x 3/4 | 73TR7 | HPD532 | 100 0.69# |
| T10321HB | 11805 | 10-32 x 1 | 73TR7 | HPD532 | 100 0.83# |
| T1032114HB | 11806 | 10-32 x 1-1/4 | 73TR7 | HPD532 | 100 0.97# |
| T1032112HB | 11807 | 10-32 x 1-1/2 | 73TR7 | HPD532 | 100 1.11# |

1/4-20

| CAT. NO. | UPC | SIZE | INSERT BIT | DRIVER STD | WT/STD |
|----------|-------|-------------|------------|------------|-----------|
| T1412HB | 11808 | 1/4 x 1/2 | 73TR7 | HPD532 | 100 1.11# |
| T1434HB | 11809 | 1/4 x 3/4 | 73TR7 | HPD532 | 100 1.36# |
| T141HB | 11810 | 1/4 x 1 | 73TR7 | HPD532 | 100 1.61# |
| T14114HB | 11811 | 1/4 x 1-1/4 | 73TR7 | HPD532 | 100 1.87# |
| T14112HB | 11812 | 1/4 x 1-1/2 | 73TR7 | HPD532 | 50 1.06# |
| T142HB | 11813 | 1/4 x 2 | 73TR7 | HPD532 | 50 1.31# |

* Flat head available on special order, when ordering replace suffix 'B' with 'F'.

FEATURES:

- Machine Screws
- Button or Flat Head*
- Hex Pin Tamper Proof
- 18-8 Stainless Steel
- Invincibox™ Up To 2"

PACKAGING:



HEX PIN INSERT BITS & HAND DRIVERS

PC 6720, 6710, 6670

Hex Pin Screws must be installed or removed using a matching drive which reduces the chances of unauthorized removal. Available in Hand Drivers and Insert Bits.



INSERT BITS - PC 6720

| CAT. NO. | UPC | SCREW SIZE | DRIVER DESCRIPTION | STD | MSTR | WT/STD |
|----------|-------|-------------|--------------------|-----|------|--------|
| 73TR3 | 22733 | #4-5 | 3/32" | 1 | 5 | 0.01# |
| 73TR5 | 22735 | #6 | 1/8" | 1 | 5 | 0.01# |
| 73TR7 | 22737 | #8,10,12,14 | 5/32" | 1 | 5 | 0.01# |
| 73TR8 | 22738 | 5/16" | 3/16" | 1 | 5 | 0.01# |
| 73TR9 | 22739 | 3/8" | 7/32" | 1 | 5 | 0.01# |

HAND DRIVERS - PC 6670

| CAT. NO. | UPC | SCREW SIZE | DRIVER DESCRIPTION | STD | MSTR | WT/STD |
|----------|-------|------------|--------------------|-----|------|--------|
| HPD18 | 81487 | #6 | 1/8" | 1 | 10 | 0.20# |
| HPD532 | 81488 | #8-14 | 5/32" | 1 | 10 | 0.20# |

MAGNETIC BIT HOLDER - PC 6710

| CAT. NO. | UPC | DRIVER DESCRIPTION | STD | MSTR | WT/STD |
|----------|-------|------------------------------|-----|------|--------|
| MBH | 16948 | 1/4 x 3" Magnetic Bit Holder | 1 | 10 | 0.11# |

MAGNETIC HAND DRIVER - PC 6720

| CAT. NO. | UPC | DRIVER DESCRIPTION | STD | MSTR | WT/STD |
|----------|-------|-------------------------|-----|------|--------|
| MHD | 16949 | 8" Magnetic Hand Driver | 1 | 1 | 0.20# |

FEATURES:

- Insert Bits Hex Pin
- Hand Drivers Hex Pin
- Magnetic Bit Holder
- Magnetic Hand Driver



TAMPER PROOF SCREWS, BITS & DRIVERS

STAR PIN MACHINE SCREWS - STAINLESS

PC 6680



Tamper resistant screws are designed to prevent vandalism and theft. Use proper bit or driver to remove (one way, hex pin, star pin or spanner). Choose from the type head style available: Button or Flat.



6-32

| CAT. NO. | UPC | SIZE | HAND DRIVER | | INSERT BIT | | STD | WT/STD |
|-----------|-------|--------------|-------------|---------|------------|---------|-----|--------|
| | | | BUTTON HD | FLAT HD | BUTTON HD | FLAT HD | | |
| T63212TB | 11838 | 6-32 x 1/2 | 60TR10 | 60TR15 | STR10 | STR15 | 100 | 0.24# |
| T63234TB | 11839 | 6-32 x 3/4 | 60TR10 | 60TR15 | STR10 | STR15 | 100 | 0.32# |
| T6321TB | 11840 | 6-32 x 1 | 60TR10 | 60TR15 | STR10 | STR15 | 100 | 0.39# |
| T632112TB | 11841 | 6-32 x 1-1/2 | 60TR10 | 60TR15 | STR10 | STR15 | 100 | 0.53# |

8-32

| | | | | | | | | |
|-----------|-------|--------------|--------|--------|-------|-------|-----|-------|
| T83212TB | 11842 | 8-32 x 1/2 | 60TR15 | 60TR20 | STR15 | STR20 | 100 | 0.39# |
| T83234TB | 11843 | 8-32 x 3/4 | 60TR15 | 60TR20 | STR15 | STR20 | 100 | 0.50# |
| T8321TB | 11844 | 8-32 x 1 | 60TR15 | 60TR20 | STR15 | STR20 | 100 | 0.62# |
| T832114TB | 11845 | 8-32 x 1-1/4 | 60TR15 | 60TR20 | STR15 | STR20 | 100 | 0.73# |
| T832112TB | 11846 | 8-32 x 1-1/2 | 60TR15 | 60TR20 | STR15 | STR20 | 100 | 0.83# |

10-24

| | | | | | | | | |
|------------|-------|---------------|--------|--------|-------|-------|-----|-------|
| T102412TB | 11847 | 10-24 x 1/2 | 60TR25 | 60TR25 | STR25 | STR25 | 100 | 0.54# |
| T102434TB | 11848 | 10-24 x 3/4 | 60TR25 | 60TR25 | STR25 | STR25 | 100 | 0.69# |
| T10241TB | 11849 | 10-24 x 1 | 60TR25 | 60TR25 | STR25 | STR25 | 100 | 0.83# |
| T1024114TB | 11850 | 10-24 x 1-1/4 | 60TR25 | 60TR25 | STR25 | STR25 | 100 | 0.97# |
| T1024112TB | 11851 | 10-24 x 1-1/2 | 60TR25 | 60TR25 | STR25 | STR25 | 100 | 1.11# |

10-32

| | | | | | | | | |
|------------|-------|---------------|--------|--------|-------|-------|-----|-------|
| T103212TB | 11852 | 10-32 x 1/2 | 60TR25 | 60TR25 | STR25 | STR25 | 100 | 0.54# |
| T103234TB | 11853 | 10-32 x 3/4 | 60TR25 | 60TR25 | STR25 | STR25 | 100 | 0.69# |
| T10321TB | 11854 | 10-32 x 1 | 60TR25 | 60TR25 | STR25 | STR25 | 100 | 0.83# |
| T1032114TB | 11855 | 10-32 x 1-1/4 | 60TR25 | 60TR25 | STR25 | STR25 | 100 | 0.97# |
| T1032112TB | 11856 | 10-32 x 1-1/2 | 60TR25 | 60TR25 | STR25 | STR25 | 100 | 1.11# |

1/4-20

| | | | | | | | | |
|----------|-------|-------------|--------|--------|-------|-------|-----|-------|
| T1412TB | 11857 | 1/4 x 1/2 | 60TR27 | 60TR27 | STR27 | STR27 | 100 | 1.11# |
| T1434TB | 11858 | 1/4 x 3/4 | 60TR27 | 60TR30 | STR27 | STR30 | 100 | 1.36# |
| T141TB | 11859 | 1/4 x 1 | 60TR27 | 60TR30 | STR27 | STR30 | 100 | 1.61# |
| T14114TB | 11860 | 1/4 x 1-1/4 | 60TR27 | 60TR30 | STR27 | STR30 | 100 | 1.87# |
| T14112TB | 11861 | 1/4 x 1-1/2 | 60TR27 | 60TR30 | STR27 | STR30 | 50 | 1.06# |

* Flat head available on special order, when ordering replace suffix 'B' with 'F'.

FASTENERS & HARDWARE

FEATURES:

- Machine Screws
- Button or Flat Head*
- 18-8 Stainless Steel
- Star Pin Tamper Proof
- Invincibox™ Up To 2"

PACKAGING:



STD



SLV



MSTR

STAR PIN INSERT BITS & HAND DRIVERS

PC 6720, 6710, 6670



Star Pin Screws must be installed or removed using a matching drive which reduces the chances of unauthorized removal. Available in Hand Drivers and Insert Bits.

INSERT BITS - PC 6720

| CAT. NO. | UPC | SCREW SIZE | DESCRIPTION | STD | MSTR | WT/STD |
|----------|-------|--------------|------------------|-----|------|--------|
| 60TR10 | 22610 | #6BH | T10 Star Pin Bit | 1 | 5 | 0.01# |
| 60TR15 | 22615 | #6FH, #8BH | T15 Star Pin Bit | 1 | 5 | 0.01# |
| 60TR20 | 22620 | #8FH | T20 Star Pin Bit | 1 | 5 | 0.01# |
| 60TR25 | 22625 | #10FH, #10BH | T25 Star Pin Bit | 1 | 5 | 0.01# |
| 60TR27 | 22627 | 1/4FH, 1/4BH | T27 Star Pin Bit | 1 | 5 | 0.01# |
| 60TR30 | 22630 | 1/4FH | T30 Star Pin Bit | 1 | 5 | 0.01# |

FEATURES:

- Insert Bits Star Pin
- Hand Drivers Star Pin
- Magnetic Bit Holder
- Magnetic Hand Driver

HAND DRIVERS - PC 6670

| | | | | | | |
|-------|-------|--------------|---------------------|---|----|-------|
| STR10 | 23030 | #6BH | T10 Star Pin Driver | 1 | 10 | 0.18# |
| STR15 | 23035 | #6FH, #8BH | T15 Star Pin Driver | 1 | 10 | 0.18# |
| STR20 | 23040 | #8FH | T20 Star Pin Driver | 1 | 10 | 0.18# |
| STR25 | 23045 | #10FH, #10BH | T25 Star Pin Driver | 1 | 10 | 0.19# |
| STR27 | 23050 | 1/4FH, 1/4BH | T27 Star Pin Driver | 1 | 10 | 0.21# |
| STR30 | 23052 | 1/4FH | T30 Star Pin Driver | 1 | 10 | 0.22# |

MAGNETIC BIT HOLDER - PC 6710

| | | | | | | |
|-----|-------|--|------------------------------|---|----|-------|
| MBH | 16948 | | 1/4 x 3" Magnetic Bit Holder | 1 | 10 | 0.11# |
|-----|-------|--|------------------------------|---|----|-------|

MAGNETIC HAND DRIVER - PC 6720

| | | | | | | |
|-----|-------|--|-------------------------|---|----|-------|
| MHD | 16949 | | 8" Magnetic Hand Driver | 1 | 10 | 0.20# |
|-----|-------|--|-------------------------|---|----|-------|

A10

CELEBRATING 50 YEARS

PAN HEAD PHILLIPS - STAINLESS

PC 4010

Stainless steel pan head machine screws project above the material surface. This head style is used when clearance is not an important factor. Length is determined from the base of the fastener head. Stainless steel resists corrosion and is ideal for applications where chemical resistance is required.



6-32

| CAT. NO. | UPC | SIZE | STD | SLV | MSTR | WT/STD |
|-----------|-------|--------------|-----|-----|------|--------|
| PMS63238 | 70104 | 6-32 x 3/8 | 100 | 500 | 4000 | 0.19# |
| PMS63212 | 70106 | 6-32 x 1/2 | 100 | 500 | 4000 | 0.22# |
| PMS63234 | 70108 | 6-32 x 3/4 | 100 | 500 | 4000 | 0.30# |
| PMS6321 | 70110 | 6-32 x 1 | 100 | 500 | 4000 | 0.37# |
| PMS632114 | 70112 | 6-32 x 1-1/4 | 100 | 500 | 4000 | 0.43# |
| PMS632112 | 70114 | 6-32 x 1-1/2 | 100 | 500 | 4000 | 0.51# |
| PMS6322 | 70116 | 6-32 x 2 | 100 | 500 | 3000 | 0.67# |

8-32

| | | | | | | |
|-----------|-------|--------------|-----|-----|------|-------|
| PMS83238 | 70120 | 8-32 x 3/8 | 100 | 500 | 4000 | 0.30# |
| PMS83212 | 70122 | 8-32 x 1/2 | 100 | 500 | 4000 | 0.35# |
| PMS83234 | 70124 | 8-32 x 3/4 | 100 | 500 | 4000 | 0.46# |
| PMS8321 | 70126 | 8-32 x 1 | 100 | 500 | 4000 | 0.56# |
| PMS832114 | 70128 | 8-32 x 1-1/4 | 100 | 500 | 4000 | 0.67# |
| PMS832112 | 70130 | 8-32 x 1-1/2 | 100 | 500 | 3000 | 0.77# |
| PMS8322 | 70132 | 8-32 x 2 | 100 | 500 | 3000 | 1.01# |

10-24

| | | | | | | |
|-----------|-------|-------------|-----|-----|------|-------|
| PMS102438 | 70140 | 10-24 x 3/8 | 100 | 500 | 4000 | 0.41# |
| PMS102412 | 70142 | 10-24 x 1/2 | 100 | 500 | 4000 | 0.49# |
| PMS102434 | 70144 | 10-24 x 3/4 | 100 | 500 | 4000 | 0.62# |
| PMS10241 | 70146 | 10-24 x 1 | 100 | 500 | 4000 | 0.75# |

10-32

| | | | | | | |
|-----------|-------|-------------|-----|-----|------|-------|
| PMS103238 | 70160 | 10-32 x 3/8 | 100 | 500 | 4000 | 0.41# |
| PMS103212 | 70162 | 10-32 x 1/2 | 100 | 500 | 4000 | 0.49# |
| PMS103234 | 70164 | 10-32 x 3/4 | 100 | 500 | 4000 | 0.62# |
| PMS10321 | 70168 | 10-32 x 1 | 100 | 500 | 4000 | 0.75# |

1/4-20

| | | | | | | |
|----------|-------|-------------|-----|-----|------|-------|
| PMS1438 | 70180 | 1/4 x 3/8 | 100 | 500 | 4000 | 0.84# |
| PMS1412 | 70182 | 1/4 x 1/2 | 100 | 500 | 4000 | 0.97# |
| PMS1434 | 70184 | 1/4 x 3/4 | 100 | 500 | 3000 | 1.19# |
| PMS141 | 70186 | 1/4 x 1 | 100 | 500 | 3000 | 1.45# |
| PMS14114 | 70188 | 1/4 x 1-1/4 | 100 | 500 | 3000 | 1.69# |
| PMS14112 | 70190 | 1/4 x 1-1/2 | 50 | 250 | 1500 | 0.99# |
| PMS142 | 70192 | 1/4 x 2 | 50 | 250 | 1500 | 1.21# |

FEATURES:

- Machine Screws
- Pan Head
- Phillips
- 18-8 Stainless Steel
- Invincibox™ Up To 2"

PACKAGING:



STD

SLV

MSTR

ROUND HEAD SLOTTED - SOLID BRASS

PC 4270

Brass round head machine screws project above the material surface. This head style is used when clearance is not an important factor. Length is determined from the base of the fastener head. Brass has good corrosion and rust resistance, especially in salt water and salt air. It is non magnetic.



6-32

| CAT. NO. | UPC | SIZE | STD | SLV | MSTR | WT/STD |
|-----------|-------|--------------|-----|-----|------|--------|
| RMB63212 | 55500 | 6-32 x 1/2 | 100 | 500 | 4000 | 0.22# |
| RMB63234 | 55502 | 6-32 x 3/4 | 100 | 500 | 4000 | 0.30# |
| RMB6321 | 55504 | 6-32 x 1 | 100 | 500 | 4000 | 0.37# |
| RMB632114 | 55506 | 6-32 x 1-1/4 | 100 | 500 | 4000 | 0.43# |
| RMB632112 | 55508 | 6-32 x 1-1/2 | 100 | 500 | 4000 | 0.51# |
| RMB6322 | 55510 | 6-32 x 2 | 100 | 500 | 3000 | 0.67# |

8-32

| | | | | | | |
|-----------|-------|--------------|-----|-----|------|-------|
| RMB83212 | 55550 | 8-32 x 1/2 | 100 | 500 | 4000 | 0.35# |
| RMB83234 | 55552 | 8-32 x 3/4 | 100 | 500 | 4000 | 0.46# |
| RMB8321 | 55554 | 8-32 x 1 | 100 | 500 | 4000 | 0.56# |
| RMB832114 | 55556 | 8-32 x 1-1/4 | 100 | 500 | 4000 | 0.67# |
| RMB832112 | 55558 | 8-32 x 1-1/2 | 100 | 500 | 3000 | 0.77# |
| RMB8322 | 55560 | 8-32 x 2 | 100 | 500 | 3000 | 1.01# |

1/4-20

| | | | | | | |
|----------|-------|-------------|-----|-----|------|-------|
| RMB1412 | 55700 | 1/4 x 1/2 | 100 | 500 | 4000 | 0.97# |
| RMB1434 | 55702 | 1/4 x 3/4 | 100 | 500 | 3000 | 1.19# |
| RMB141 | 55704 | 1/4 x 1 | 100 | 500 | 3000 | 1.45# |
| RMB14114 | 55706 | 1/4 x 1-1/4 | 100 | 500 | 3000 | 1.69# |
| RMB14112 | 55708 | 1/4 x 1-1/2 | 50 | 250 | 1500 | 0.99# |
| RMB142 | 55710 | 1/4 x 2 | 50 | 250 | 1500 | 1.21# |

FEATURES:

- Machine Screws
- Round Head
- Slotted
- Solid Brass
- Invincibox™ Up To 2"

* RMB10-24 and 10-32 available upon request.



WOOD SCREWS

FASTENERS & HARDWARE

FLAT HEAD PHILLIPS - SOLID BRASS

PC 4290



Brass flat head wood screws provide a flush surface. Length is determined from the top of the fastener head. Brass is non-magnetic and rust resistant.

FEATURES:

- Wood Screws
- Flat Head
- Phillips
- Solid Brass
- Invincibox™ Up To 2"

PACKAGING:



STD

SLV



MSTR

#6

| CAT. NO. | UPC | SIZE | STD | SLV | MSTR | WT/STD |
|----------|-------|---------|-----|-----|------|--------|
| PHFWB634 | 38104 | 6 x 3/4 | 100 | 500 | 4000 | 0.24# |
| PHFWB61 | 38106 | 6 x 1 | 100 | 500 | 4000 | 0.33# |

#8

| | | | | | | |
|-----------|-------|-----------|-----|-----|------|-------|
| PHFWB834 | 38204 | 8 x 3/4 | 100 | 500 | 4000 | 0.34# |
| PHFWB81 | 38206 | 8 x 1 | 100 | 500 | 4000 | 0.46# |
| PHFWB8114 | 38208 | 8 x 1-1/4 | 100 | 500 | 4000 | 0.58# |
| PHFWB8112 | 38210 | 8 x 1-1/2 | 100 | 500 | 3000 | 0.67# |
| PHFWB82 | 38212 | 8 x 2 | 100 | 500 | 3000 | 0.91# |

#10

| | | | | | | |
|------------|-------|------------|-----|-----|------|-------|
| PHFWB1034 | 38302 | 10 x 3/4 | 100 | 500 | 4000 | 0.47# |
| PHFWB101 | 38304 | 10 x 1 | 100 | 500 | 4000 | 0.61# |
| PHFWB10114 | 38306 | 10 x 1-1/4 | 100 | 500 | 3000 | 0.78# |
| PHFWB10112 | 38308 | 10 x 1-1/2 | 100 | 500 | 3000 | 0.92# |
| PHFWB102 | 38310 | 10 x 2 | 50 | 250 | 1500 | 0.60# |
| PHFWB10212 | 38312 | 10 x 2-1/2 | 100 | | 1000 | 1.56# |

#12

| | | | | | | |
|------------|-------|------------|-----|-----|------|-------|
| PHFWB121 | 38354 | 12 x 1 | 100 | 500 | 3000 | 0.81# |
| PHFWB12114 | 38356 | 12 x 1-1/4 | 100 | 500 | 3000 | 0.99# |
| PHFWB12112 | 38358 | 12 x 1-1/2 | 100 | 500 | 3000 | 1.18# |
| PHFWB122 | 38360 | 12 x 2 | 50 | 250 | 1500 | 0.80# |
| PHFWB12212 | 38362 | 12 x 2-1/2 | 100 | | 1000 | 1.94# |
| PHFWB123 | 38364 | 12 x 3 | 100 | | 1000 | 2.31# |

Also available as zinc plated Phillips drive - Check your price master

FLAT HEAD SQUARE DRIVE WOOD SCREWS

PC 4025



Zinc plated flat head wood screws provide a flush surface. Length is determined from the top of the fastener head.

FEATURES:

- Wood Screws
- Flat Head
- Square Drive
- Zinc Plated Steel
- Invincibox™ Up To 2"

#6

| CAT. NO. | UPC | SIZE | STD | SLV | MSTR | WT/STD |
|----------|-------|-----------|-----|-----|------|--------|
| DDFW634 | 82080 | 6 x 3/4 | 100 | 500 | 4000 | 0.24# |
| DDFW61 | 82081 | 6 x 1 | 100 | 500 | 4000 | 0.33# |
| DDFW6114 | 82082 | 6 x 1-1/4 | 100 | 500 | 4000 | 0.42# |
| DDFW6112 | 82083 | 6 x 1-1/2 | 100 | 500 | 4000 | 0.49# |
| DDFW62 | 82084 | 6 x 2 | 100 | 500 | 4000 | 0.69# |

#8

| | | | | | | |
|----------|-------|-----------|-----|-----|------|-------|
| DDFW812 | 82085 | 8 x 1/2 | 100 | 500 | 4000 | 0.31# |
| DDFW834 | 82086 | 8 x 3/4 | 100 | 500 | 4000 | 0.34# |
| DDFW81 | 82087 | 8 x 1 | 100 | 500 | 4000 | 0.46# |
| DDFW8114 | 82088 | 8 x 1-1/4 | 100 | 500 | 4000 | 0.58# |
| DDFW8112 | 82089 | 8 x 1-1/2 | 100 | 500 | 3000 | 0.67# |
| DDFW82 | 82090 | 8 x 2 | 100 | 500 | 3000 | 0.91# |
| DDFW8212 | 82091 | 8 x 2-1/2 | 100 | | 1000 | 1.11# |
| DDFW83 | 82092 | 8 x 3 | 100 | | 1000 | 1.33# |

#10

| | | | | | | |
|-----------|-------|------------|-----|-----|------|-------|
| DDFW1034 | 82093 | 10 x 3/4 | 100 | 500 | 4000 | 0.47# |
| DDFW101 | 82094 | 10 x 1 | 100 | 500 | 4000 | 0.61# |
| DDFW10114 | 82095 | 10 x 1-1/4 | 100 | 500 | 3000 | 0.78# |
| DDFW10112 | 82096 | 10 x 1-1/2 | 100 | 500 | 3000 | 0.92# |
| DDFW102 | 82097 | 10 x 2 | 50 | 250 | 1500 | 1.19# |
| DDFW10212 | 82098 | 10 x 2-1/2 | 100 | | 1000 | 1.56# |
| DDFW103 | 82099 | 10 x 3 | 100 | | 1000 | 1.81# |

#12

| | | | | | | |
|-----------|-------|------------|-----|--|------|-------|
| DDFW12212 | 83494 | 12 x 2-1/2 | 100 | | 1000 | 1.94# |
| DDFW123 | 83493 | 12 x 3 | 100 | | 1000 | 2.31# |

A12

"BUILDING A BETTER BRAND"

PHILLIPS BUGLE HEAD FINE THREAD

PC 4260

Fine thread Bugle head drywall screws are self piercing and are used for wood, drywall and aluminum. Length is determined from the top of the fastener head.

#6

| CAT. NO. | UPC | SIZE | STD | SLV | MSTR | WT/STD |
|-----------|-------|-----------|-----|-----|------|--------|
| DWSBX61 | 58100 | 6 x 1 | 100 | 500 | 4000 | 0.35# |
| DWSBX6118 | 58102 | 6 x 1-1/8 | 100 | 500 | 4000 | 0.36# |
| DWSBX6114 | 58104 | 6 x 1-1/4 | 100 | 500 | 4000 | 0.40# |
| DWSBX6158 | 58106 | 6 x 1-5/8 | 100 | 500 | 4000 | 0.64# |
| DWSBX62 | 58108 | 6 x 2 | 100 | 500 | 3000 | 0.64# |
| DWSBX6214 | 58110 | 6 x 2-1/4 | 100 | | 1000 | 0.69# |

#8

| | | | | | | |
|-----------|-------|-----------|-----|--|------|-------|
| DWSBX8212 | 58112 | 8 x 2-1/2 | 100 | | 1000 | 1.04# |
| DWSBX83 | 58114 | 8 x 3 | 100 | | 1000 | 1.30# |

#6 TUFF PACK

| | | | | | | |
|---------|-------|-----------|-----|--|------|-------|
| DWT61 | 58120 | 6 x 1 | 500 | | 3000 | 1.64# |
| DWT6118 | 58122 | 6 x 1-1/8 | 500 | | 3000 | 1.82# |
| DWT6114 | 58124 | 6 x 1-1/4 | 500 | | 3000 | 1.93# |
| DWT6158 | 58126 | 6 x 1-5/8 | 500 | | 3000 | 2.39# |
| DWT62 | 58128 | 6 x 2 | 300 | | 1800 | 1.68# |

#6 BULK PACK

| | | | | | | |
|-----------|-------|-----------|-------|--|-------|--------|
| DWSBK61 | 58050 | 6 x 1 | 10000 | | 10000 | 35.00# |
| DWSBK6118 | 58052 | 6 x 1-1/8 | 10000 | | 10000 | 36.00# |
| DWSBK6114 | 58054 | 6 x 1-1/4 | 8000 | | 8000 | 28.80# |
| DWSBK6158 | 58056 | 6 x 1-5/8 | 5000 | | 5000 | 20.00# |
| DWSBK62 | 58058 | 6 x 2 | 3500 | | 3500 | 22.40# |
| DWSBK6214 | 58060 | 6 x 2-1/4 | 3000 | | 3000 | 20.40# |

#8 BULK PACK

| | | | | | | |
|-----------|-------|-----------|------|--|------|--------|
| DWSBK8212 | 58062 | 8 x 2-1/2 | 2500 | | 2500 | 26.00# |
| DWSBK83 | 58064 | 8 x 3 | 2000 | | 2000 | 26.00# |

PHILLIPS BUGLE HEAD WOOD ROCKETS COARSE THREAD

PC 4260

Coarse thread Bugle head drywall screws (Wood Rockets) are self piercing and are used for drywall, particle board and wood. The coarse threads provide for a quicker installation.

#6

| CAT. NO. | UPC | SIZE | STD | SLV | MSTR | WT/STD |
|----------|-------|-----------|-----|-----|------|--------|
| WR61 | 16200 | 6 x 1 | 100 | 500 | 4000 | 0.35# |
| WR6118 | 16202 | 6 x 1-1/8 | 100 | 500 | 4000 | 0.38# |
| WR6114 | 16204 | 6 x 1-1/4 | 100 | 500 | 4000 | 0.40# |
| WR6158 | 16206 | 6 x 1-5/8 | 100 | 500 | 4000 | 0.54# |
| WR62 | 16208 | 6 x 2 | 100 | 500 | 3000 | 0.64# |
| WR6214 | 16210 | 6 x 2-1/4 | 100 | | 1000 | 0.68# |

#8

| | | | | | | |
|--------|-------|-----------|-----|--|------|-------|
| WR8212 | 16209 | 8 x 2-1/2 | 100 | | 1000 | 1.04# |
| WR83 | 16211 | 8 x 3 | 100 | | 1000 | 1.30# |

#6 TUFF PACK

| | | | | | | |
|---------|-------|-----------|-----|--|------|-------|
| WRT61 | 16212 | 6 x 1 | 500 | | 3000 | 1.58# |
| WRT6118 | 16214 | 6 x 1-1/8 | 500 | | 3000 | 1.79# |
| WRT6114 | 16216 | 6 x 1-1/4 | 500 | | 3000 | 2.00# |
| WRT6158 | 16215 | 6 x 1-5/8 | 500 | | 3000 | 2.46# |
| WRT62 | 16217 | 6 x 2 | 300 | | 1800 | 1.81# |

#6 BULK PACK

| | | | | | | |
|----------|-------|-----------|-------|--|-------|--------|
| WRBK61 | 16218 | 6 x 1 | 10000 | | 10000 | 35.00# |
| WRBK6118 | 16220 | 6 x 1-1/8 | 10000 | | 10000 | 38.00# |
| WRBK6114 | 16222 | 6 x 1-1/4 | 8000 | | 8000 | 43.20# |
| WRBK6158 | 16224 | 6 x 1-5/8 | 5000 | | 5000 | 20.00# |
| WRBK62 | 16226 | 6 x 2 | 3500 | | 3500 | 22.40# |
| WRBK6214 | 16228 | 6 x 2-1/4 | 3000 | | 3000 | 20.40# |

#8 BULK PACK

| | | | | | | |
|----------|-------|-----------|------|--|------|--------|
| WRBK8212 | 16230 | 8 x 2-1/2 | 2500 | | 2500 | 26.00# |
| WRBK83 | 16232 | 8 x 3 | 2000 | | 2000 | 26.00# |



FEATURES:

- Drywall Screws
- Bugle Head
- Phillips
- Fine Thread
- Black Oxide
- Invincibox™ Up To 2"
- Tuff Pack
- Bulk Pack

PACKAGING:



FEATURES:

- Wood Rockets
- Bugle Head
- Phillips
- Coarse Thread
- Yellow Zinc
- Invincibox™ Up To 2"
- Tuff Pack

PAN HEAD SLOTTED/PHILLIPS (2 WAY)

PC 4000



Pan head combo (slotted/phillips) sheet metal screws will tap their own mating threads when driven into preformed holes in metal. Length is determined from the base of the fastener head.

#6

| CAT. NO. | UPC | SIZE | STD | SLV | MSTR | WT/STD |
|----------|-------|-----------|-----|-----|------|--------|
| 2WS612 | 58162 | 6 x 1/2 | 100 | 500 | 4000 | 0.20# |
| 2WS634 | 58164 | 6 x 3/4 | 100 | 500 | 4000 | 0.27# |
| 2WS61 | 58166 | 6 x 1 | 100 | 500 | 4000 | 0.34# |
| 2WS6114 | 58168 | 6 x 1-1/4 | 100 | 500 | 4000 | 0.42# |
| 2WS6112 | 58170 | 6 x 1-1/2 | 100 | 500 | 4000 | 0.49# |
| 2WS62 | 58172 | 6 x 2 | 100 | 500 | 3000 | 0.64# |

FEATURES:

- Sheet Metal Screws
- Zinc Plated Steel
- Slotted/Phillips
- Invincibox™ Up To 2"
- Tuff Pack

PACKAGING:



STD

SLV



MSTR



TUFF PACK

#8

| | | | | | | |
|---------|-------|-----------|-----|-----|------|-------|
| 2WS812 | 58150 | 8 x 1/2 | 100 | 500 | 4000 | 0.31# |
| 2WS834 | 58152 | 8 x 3/4 | 100 | 500 | 4000 | 0.41# |
| 2WS81 | 58154 | 8 x 1 | 100 | 500 | 4000 | 0.51# |
| 2WS8114 | 58156 | 8 x 1-1/4 | 100 | 500 | 4000 | 0.61# |
| 2WS8112 | 58158 | 8 x 1-1/2 | 100 | 500 | 3000 | 0.69# |
| 2WS82 | 58160 | 8 x 2 | 100 | 500 | 3000 | 0.89# |

#10

| | | | | | | |
|----------|-------|------------|-----|-----|------|-------|
| 2WS1012 | 58200 | 10 x 1/2 | 100 | 500 | 4000 | 0.43# |
| 2WS1034 | 58202 | 10 x 3/4 | 100 | 500 | 4000 | 0.54# |
| 2WS101 | 58204 | 10 x 1 | 100 | 500 | 4000 | 0.69# |
| 2WS10114 | 58206 | 10 x 1-1/4 | 100 | 500 | 3000 | 0.80# |
| 2WS10112 | 58208 | 10 x 1-1/2 | 100 | 500 | 3000 | 0.91# |
| 2WS102 | 58210 | 10 x 2 | 50 | 250 | 1500 | 0.63# |

#12

| | | | | | | |
|----------|-------|------------|-----|-----|------|-------|
| 2WS1212 | 58174 | 12 x 1/2 | 100 | 500 | 4000 | 0.61# |
| 2WS1234 | 58176 | 12 x 3/4 | 100 | 500 | 4000 | 0.81# |
| 2WS121 | 58178 | 12 x 1 | 100 | 500 | 3000 | 0.96# |
| 2WS12114 | 58180 | 12 x 1-1/4 | 100 | 500 | 3000 | 1.15# |
| 2WS12112 | 58182 | 12 x 1-1/2 | 100 | 500 | 3000 | 1.30# |
| 2WS122 | 58184 | 12 x 2 | 50 | 250 | 1500 | 0.81# |

#14

| | | | | | | |
|----------|-------|------------|-----|-----|------|-------|
| 2WS1412 | 58186 | 14 x 1/2 | 100 | 500 | 3000 | 0.86# |
| 2WS1434 | 58188 | 14 x 3/4 | 100 | 500 | 3000 | 1.09# |
| 2WS141 | 58190 | 14 x 1 | 100 | 500 | 3000 | 1.28# |
| 2WS14114 | 58192 | 14 x 1-1/4 | 100 | 500 | 3000 | 1.57# |
| 2WS14112 | 58194 | 14 x 1-1/2 | 50 | 250 | 1500 | 0.89# |
| 2WS142 | 58196 | 14 x 2 | 50 | 250 | 1500 | 1.11# |

#8 TUFF PACK

| | | | | | | |
|---------|-------|---------|-----|--|------|-------|
| 2WST834 | 58161 | 8 x 3/4 | 500 | | 3000 | 2.24# |
| 2WST81 | 58163 | 8 x 1 | 500 | | 3000 | 3.29# |

#10 TUFF PACK

| | | | | | | |
|----------|-------|----------|-----|--|------|-------|
| 2WST1034 | 58165 | 10 x 3/4 | 500 | | 3000 | 3.70# |
| 2WST101 | 58167 | 10 x 1 | 500 | | 3000 | 3.60# |

PAN HEAD PHILLIPS - STAINLESS

PC 4010



Stainless steel pan head phillips sheet metal screws will tap their own mating threads when driven into preformed holes in metal. Length is determined from the base of the fastener head. Stainless steel resists corrosion and is ideal for applications where chemical resistance is required.

#6

| CAT. NO. | UPC | SIZE | STD | SLV | MSTR | WT/STD |
|------------|-------|-----------|-----|-----|------|--------|
| PHSMSS612 | 70204 | 6 x 1/2 | 100 | 500 | 4000 | 0.20# |
| PHSMSS634 | 70206 | 6 x 3/4 | 100 | 500 | 4000 | 0.27# |
| PHSMSS61 | 70208 | 6 x 1 | 100 | 500 | 4000 | 0.34# |
| PHSMSS6114 | 70210 | 6 x 1-1/4 | 100 | 500 | 4000 | 0.42# |
| PHSMSS6112 | 70212 | 6 x 1-1/2 | 100 | 500 | 4000 | 0.49# |
| PHSMSS62 | 70214 | 6 x 2 | 100 | 500 | 3000 | 0.64# |

FEATURES:

- Sheet Metal Screws
- Phillips
- 18-8 Stainless Steel
- Invincibox™ Up To 2"

#8

| | | | | | | |
|------------|-------|-----------|-----|-----|------|-------|
| PHSMSS812 | 70220 | 8 x 1/2 | 100 | 500 | 4000 | 0.31# |
| PHSMSS834 | 70222 | 8 x 3/4 | 100 | 500 | 4000 | 0.41# |
| PHSMSS81 | 70224 | 8 x 1 | 100 | 500 | 4000 | 0.51# |
| PHSMSS8114 | 70226 | 8 x 1-1/4 | 100 | 500 | 4000 | 0.61# |
| PHSMSS8112 | 70228 | 8 x 1-1/2 | 100 | 500 | 3000 | 0.69# |
| PHSMSS82 | 70230 | 8 x 2 | 100 | 500 | 3000 | 0.89# |

#10

| | | | | | | |
|-------------|-------|------------|-----|-----|------|-------|
| PHSMSS1012 | 70240 | 10 x 1/2 | 100 | 500 | 4000 | 0.43# |
| PHSMSS1034 | 70242 | 10 x 3/4 | 100 | 500 | 4000 | 0.54# |
| PHSMSS101 | 70244 | 10 x 1 | 100 | 500 | 4000 | 0.69# |
| PHSMSS10114 | 70246 | 10 x 1-1/4 | 100 | 500 | 3000 | 0.80# |
| PHSMSS10112 | 70248 | 10 x 1-1/2 | 100 | 500 | 3000 | 0.91# |
| PHSMSS102 | 70250 | 10 x 2 | 50 | 250 | 1500 | 0.85# |

PAN HEAD SQUARE DRIVE

PC 4000

Square drive pan head sheet metal screws will tap their own mating threads when driven into preformed holes in metal. Square drive screws provide a positive grip and resist cam out. Length is determined from the base of the fastener head.



#6

| CAT. NO. | UPC | SIZE | BIT SIZE | STD | SLV | MSTR | WT/STD |
|-----------|-------|-----------|----------|-----|-----|------|--------|
| DDSMS612 | 16960 | 6 x 1/2 | #1 | 100 | 500 | 4000 | 0.20# |
| DDSMS634 | 16961 | 6 x 3/4 | #1 | 100 | 500 | 4000 | 0.27# |
| DDSMS61 | 16962 | 6 x 1 | #1 | 100 | 500 | 4000 | 0.34# |
| DDSMS6114 | 16963 | 6 x 1-1/4 | #1 | 100 | 500 | 4000 | 0.42# |
| DDSMS6112 | 16964 | 6 x 1-1/2 | #1 | 100 | 500 | 4000 | 0.49# |

#8

| | | | | | | | |
|-----------|-------|-----------|----|-----|-----|------|-------|
| DDSMS812 | 16965 | 8 x 1/2 | #2 | 100 | 500 | 4000 | 0.31# |
| DDSMS834 | 16970 | 8 x 3/4 | #2 | 100 | 500 | 4000 | 0.46# |
| DDSMS81 | 16971 | 8 x 1 | #2 | 100 | 500 | 4000 | 0.51# |
| DDSMS8114 | 16972 | 8 x 1-1/4 | #2 | 100 | 500 | 4000 | 0.61# |
| DDSMS8112 | 16973 | 8 x 1-1/2 | #2 | 100 | 500 | 3000 | 0.69# |
| DDSMS82 | 16974 | 8 x 2 | #2 | 100 | 500 | 3000 | 0.89# |
| DDSMS8212 | 16990 | 8 x 2-1/2 | #2 | 100 | | 1000 | 1.33# |
| DDSMS83 | 16991 | 8 x 3 | #2 | 100 | | 1000 | 1.34# |

#10

| | | | | | | | |
|------------|-------|------------|----|-----|-----|------|-------|
| DDSMS1012 | 16975 | 10 x 1/2 | #2 | 100 | 500 | 4000 | 0.43# |
| DDSMS1034 | 16981 | 10 x 3/4 | #2 | 100 | 500 | 4000 | 0.54# |
| DDSMS101 | 16982 | 10 x 1 | #2 | 100 | 500 | 4000 | 0.69# |
| DDSMS10114 | 16983 | 10 x 1-1/4 | #2 | 100 | 500 | 3000 | 0.80# |
| DDSMS10112 | 16984 | 10 x 1-1/2 | #2 | 100 | 500 | 3000 | 0.91# |
| DDSMS102 | 16985 | 10 x 2 | #2 | 50 | 250 | 1500 | 0.85# |
| DDSMS10212 | 16986 | 10 x 2-1/2 | #2 | 100 | | 1000 | 1.44# |
| DDSMS103 | 16987 | 10 x 3 | #2 | 100 | | 1000 | 1.81# |

#12

| | | | | | | | |
|------------|-------|------------|----|-----|-----|------|-------|
| DDSMS1234 | 60100 | 12 x 3/4 | #3 | 100 | 500 | 4000 | 0.81# |
| DDSMS121 | 60102 | 12 x 1 | #3 | 100 | 500 | 3000 | 0.96# |
| DDSMS12114 | 60104 | 12 x 1-1/4 | #3 | 100 | 500 | 3000 | 1.15# |
| DDSMS12112 | 60106 | 12 x 1-1/2 | #3 | 100 | 500 | 3000 | 1.30# |
| DDSMS122 | 60108 | 12 x 2 | #3 | 50 | 250 | 1500 | 0.81# |
| DDSMS12212 | 16988 | 12 x 2-1/2 | #3 | 100 | | 1000 | 1.98# |
| DDSMS123 | 16989 | 12 x 3 | #3 | 100 | | 1000 | 2.33# |

#8 TUFF PACK

| | | | | | | | |
|-----------|-------|---------|----|-----|--|------|-------|
| DDSMST834 | 16976 | 8 x 3/4 | #2 | 500 | | 3000 | 2.30# |
| DDSMST81 | 16977 | 8 x 1 | #2 | 500 | | 3000 | 2.69# |

#10 TUFF PACK

| | | | | | | | |
|------------|-------|----------|----|-----|--|------|-------|
| DDSMST1034 | 16978 | 10 x 3/4 | #2 | 500 | | 3000 | 3.03# |
| DDSMST101 | 16979 | 10 x 1 | #2 | 500 | | 3000 | 3.68# |

FEATURES:

- Sheet Metal Screws
- Pan Head
- Square Drive
- Zinc Plated Steel
- Invincibox™ Up To 2"
- Tuff Pack

PACKAGING:



TECH TALK

Square Drive Screws

Square Drive screws resist cam out and stripping far better than phillips or slotted screws and are popular with manufacturers who value their speed and efficiency. Due to its snug fit, it can be driven easily with no need to actually hold the screw. Developed and used in Canada, it has gained increased popularity with the U.S. contracting trade.

SLOTTED/PHILLIPS HEX WASHER HEAD

PC 4000



Hex washer head sheet metal screws will tap their own mating threads when driven into preformed holes in metal. Length is determined from the base of the fastener head.

FEATURES:

- Sheet Metal Screws
- Hex Washer Head
- Slotted/Phillips
- Zinc Plated Steel
- Invincibox™ Up To 2"
- Tuff Pack

PACKAGING:



#6

| CAT. NO. | UPC | SIZE | HEX SIZE | STD | SLV | MSTR | WT/STD |
|-----------|-------|-----------|----------|-----|-----|------|--------|
| HWSMS612 | 56500 | 6 x 1/2 | 1/4" | 100 | 500 | 4000 | 0.25# |
| HWSMS634 | 56502 | 6 x 3/4 | 1/4" | 100 | 500 | 4000 | 0.30# |
| HWSMS61 | 56504 | 6 x 1 | 1/4" | 100 | 500 | 4000 | 0.38# |
| HWSMS6114 | 56506 | 6 x 1-1/4 | 1/4" | 100 | 500 | 4000 | 0.45# |
| HWSMS6112 | 56508 | 6 x 1-1/2 | 1/4" | 100 | 500 | 4000 | 0.62# |

#8

| | | | | | | | |
|-----------|-------|-----------|------|-----|-----|------|-------|
| HWSMS812 | 56550 | 8 x 1/2 | 1/4" | 100 | 500 | 4000 | 0.33# |
| HWSMS834 | 56552 | 8 x 3/4 | 1/4" | 100 | 500 | 4000 | 0.43# |
| HWSMS81 | 56554 | 8 x 1 | 1/4" | 100 | 500 | 4000 | 0.53# |
| HWSMS8114 | 56556 | 8 x 1-1/4 | 1/4" | 100 | 500 | 4000 | 0.69# |
| HWSMS8112 | 56558 | 8 x 1-1/2 | 1/4" | 100 | 500 | 3000 | 0.73# |
| HWSMS82 | 56560 | 8 x 2 | 1/4" | 100 | 500 | 3000 | 0.92# |
| HWSMS8212 | 56562 | 8 x 2-1/2 | 1/4" | 100 | | 1000 | 1.30# |
| HWSMS83 | 56564 | 8 x 3 | 1/4" | 100 | | 1000 | 1.34# |

#10

| | | | | | | | |
|------------|-------|------------|-------|-----|-----|------|-------|
| HWSMS1012 | 56600 | 10 x 1/2 | 5/16" | 100 | 500 | 4000 | 0.46# |
| HWSMS1034 | 56602 | 10 x 3/4 | 5/16" | 100 | 500 | 4000 | 0.57# |
| HWSMS101 | 56604 | 10 x 1 | 5/16" | 100 | 500 | 4000 | 0.73# |
| HWSMS10114 | 56606 | 10 x 1-1/4 | 5/16" | 100 | 500 | 3000 | 0.84# |
| HWSMS10112 | 56608 | 10 x 1-1/2 | 5/16" | 100 | 500 | 3000 | 0.96# |
| HWSMS102 | 56610 | 10 x 2 | 5/16" | 50 | 250 | 1500 | 0.61# |
| HWSMS10212 | 56612 | 10 x 2-1/2 | 5/16" | 100 | | 1000 | 1.44# |
| HWSMS103 | 56614 | 10 x 3 | 5/16" | 100 | | 1000 | 1.81# |

#12

| | | | | | | | |
|------------|-------|------------|-------|-----|-----|------|-------|
| HWSMS1234 | 56650 | 12 x 3/4 | 5/16" | 100 | 500 | 4000 | 0.85# |
| HWSMS121 | 56652 | 12 x 1 | 5/16" | 100 | 500 | 3000 | 0.98# |
| HWSMS12114 | 56654 | 12 x 1-1/4 | 5/16" | 50 | 250 | 1500 | 1.14# |
| HWSMS12112 | 56656 | 12 x 1-1/2 | 5/16" | 50 | 250 | 1500 | 1.31# |
| HWSMS122 | 56658 | 12 x 2 | 5/16" | 50 | 250 | 1500 | 0.81# |
| HWSMS12212 | 56660 | 12 x 2-1/2 | 5/16" | 100 | | 1000 | 1.98# |
| HWSMS123 | 56662 | 12 x 3 | 5/16" | 100 | | 1000 | 2.33# |

#8 TUFF PACK

| | | | | | | | |
|-----------|-------|---------|------|-----|--|------|-------|
| HWSMST834 | 17267 | 8 x 3/4 | 1/4" | 500 | | 3000 | 2.21# |
| HWSMST81 | 17268 | 8 x 1 | 1/4" | 500 | | 3000 | 2.71# |

#10 TUFF PACK

| | | | | | | | |
|------------|-------|----------|-------|-----|--|------|-------|
| HWSMST1034 | 17269 | 10 x 3/4 | 5/16" | 500 | | 3000 | 3.10# |
| HWSMST101 | 17270 | 10 x 1 | 5/16" | 500 | | 3000 | 3.59# |

PAN HEAD PHILLIPS FRAMER SCREWS

PC 4260



Phillips pan head framer screws are ideal for light duty aluminum and steel metal to metal applications. Will penetrate through 20 gauge steel studs. Length is determined from base of the fastener head. Black oxide finish.

#6

| CAT. NO. | UPC | SIZE | STD | SLV | MSTR | WT/STD |
|----------|-------|----------|-----|-----|------|--------|
| F6716 | 67160 | 6 x 7/16 | 100 | 500 | 4000 | 0.22# |
| FT6716 | 16390 | 6 x 7/16 | 500 | | 3000 | 1.10# |

FEATURES:

- Pan Head
- Phillips
- Black Oxide
- Metal Piercing
- Invincibox™
- Tuff Pack

WAFER HEAD PHILLIPS METAL PIERCING SCREWS

PC 4200

K-Lath screws are metal piercing and will tap up to 20 gauge steel studs. Phillips wafer head provides large bearing surface. Length is determined from the base of the fastener head. Used for framing, electrical, plumbing and sheet metal applications.



#8

| CAT. NO. | UPC | SIZE | BIT SIZE | STD | SLV | MSTR | WT/STD |
|----------|-------|-----------|----------|-----|-----|------|--------|
| KW812 | 15604 | 8 x 1/2 | #2 | 100 | 500 | 4000 | 0.38# |
| KW834 | 15605 | 8 x 3/4 | #2 | 100 | 500 | 4000 | 0.45# |
| KW81 | 15606 | 8 x 1 | #2 | 100 | 500 | 4000 | 0.56# |
| KW8114 | 15607 | 8 x 1-1/4 | #2 | 100 | 500 | 4000 | 0.67# |
| KW8158 | 15609 | 8 x 1-5/8 | #2 | 100 | 500 | 3000 | 0.75# |

#8 TUFF PACK

| | | | | | | | |
|---------|-------|-----------|----|-----|--|------|-------|
| KWT812 | 15704 | 8 x 1/2 | #2 | 500 | | 3000 | 3.88# |
| KWT834 | 15705 | 8 x 3/4 | #2 | 500 | | 3000 | 4.88# |
| KWT81 | 15706 | 8 x 1 | #2 | 500 | | 3000 | 3.12# |
| KWT8114 | 15707 | 8 x 1-1/4 | #2 | 500 | | 3000 | 3.68# |
| KWT8158 | 15709 | 8 x 1-5/8 | #2 | 300 | | 1800 | 1.58# |

#8 BULK PACK

| | | | | | | | |
|----------|-------|-----------|----|-------|--|-------|--------|
| KWBK812 | 15804 | 8 x 1/2 | #2 | 10000 | | 10000 | 38.00# |
| KWBK834 | 15805 | 8 x 3/4 | #2 | 10000 | | 10000 | 45.00# |
| KWBK81 | 15806 | 8 x 1 | #2 | 8000 | | 8000 | 44.80# |
| KWBK8114 | 15807 | 8 x 1-1/4 | #2 | 5000 | | 5000 | 34.60# |
| KWBK8158 | 15809 | 8 x 1-5/8 | #2 | 5000 | | 5000 | 42.28# |

FEATURES:

- K-Lath Screws
- Wafer Head
- Phillips
- Zinc Plated Steel
- Metal Piercing
- Invincibox™ Up To 1-5/8"
- Tuff Pack
- Bulk Pack

PACKAGING:



WAFER HEAD SQUARE DRIVE METAL PIERCING SCREWS

PC 4200

K-Lath screws are metal piercing and will tap up to 20 gauge steel studs. Square Drive wafer head provides large bearing surface. Length is determined from the base of the fastener head. Used for framing, electrical, plumbing and sheet metal applications.



#8

| CAT. NO. | UPC | SIZE | BIT SIZE | STD | SLV | MSTR | WT/STD |
|----------|-------|-----------|----------|-----|-----|------|--------|
| KWDD812 | 15620 | 8 x 1/2 | #2 | 100 | 500 | 4000 | 0.44# |
| KWDD834 | 15621 | 8 x 3/4 | #2 | 100 | 500 | 4000 | 0.52# |
| KWDD81 | 15622 | 8 x 1 | #2 | 100 | 500 | 4000 | 0.60# |
| KWDD8114 | 15636 | 8 x 1-1/4 | #2 | 100 | 500 | 4000 | 0.67# |
| KWDD8112 | 15637 | 8 x 1-1/2 | #2 | 100 | 500 | 3000 | 0.75# |
| KWDD82 | 15638 | 8 x 2 | #2 | 100 | 500 | 3000 | 0.89# |

#10

| | | | | | | | |
|-----------|-------|------------|----|-----|-----|------|-------|
| KWDD1012 | 15623 | 10 x 1/2 | #2 | 100 | 500 | 4000 | 0.56# |
| KWDD1034 | 15624 | 10 x 3/4 | #2 | 100 | 500 | 4000 | 0.67# |
| KWDD101 | 15625 | 10 x 1 | #2 | 100 | 500 | 4000 | 0.78# |
| KWDD10114 | 15626 | 10 x 1-1/4 | #2 | 100 | 500 | 3000 | 0.93# |
| KWDD10112 | 15627 | 10 x 1-1/2 | #2 | 100 | 500 | 3000 | 1.19# |
| KWDD102 | 15628 | 10 x 2 | #2 | 50 | 250 | 1500 | 0.75# |

#8 TUFF PACK

| | | | | | | | |
|----------|-------|---------|----|-----|--|------|-------|
| KWDDT812 | 15629 | 8 x 1/2 | #2 | 500 | | 3000 | 2.35# |
| KWDDT834 | 15630 | 8 x 3/4 | #2 | 500 | | 3000 | 2.81# |
| KWDDT81 | 15631 | 8 x 1 | #2 | 500 | | 3000 | 3.01# |

#10 TUFF PACK

| | | | | | | | |
|------------|-------|------------|----|-----|--|------|-------|
| KWDDT1012 | 15632 | 10 x 1/2 | #2 | 500 | | 3000 | 2.95# |
| KWDDT1034 | 15633 | 10 x 3/4 | #2 | 500 | | 3000 | 3.75# |
| KWDDT101 | 15634 | 10 x 1 | #2 | 500 | | 3000 | 4.31# |
| KWDDT10114 | 15635 | 10 x 1-1/4 | #2 | 400 | | 2400 | 5.04# |

FEATURES:

- K-Lath Screws
- Wafer Head
- Square Drive
- Zinc Plated Steel
- Metal Piercing
- Invincibox™ Up To 2"
- Tuff Pack

PAN HEAD PHILLIPS

PC 4220



Self drilling phillips pan head screws drill a hole and tap threads in one operation. The drilling operation removes metal and can be used with heavier gauge metals. Length is determined from the base of the fastener head.

FEATURES:

- Self Drilling
- Pan Head
- Phillips
- Zinc Plated Steel
- Invincibox™ Up To 2"

#6

| CAT. NO. | UPC | SIZE | BIT SIZE | STD | SLV | MSTR | WT/STD |
|----------|-------|---------|----------|-----|-----|------|--------|
| TEKPH612 | 17370 | 6 x 1/2 | #1 | 100 | 500 | 4000 | 0.26# |
| TEKPH634 | 17375 | 6 x 3/4 | #1 | 100 | 500 | 4000 | 0.30# |
| TEKPH61 | 17380 | 6 x 1 | #1 | 100 | 500 | 4000 | 0.34# |

#8

| | | | | | | | |
|-----------|-------|-----------|----|-----|-----|------|-------|
| TEKPH812 | 17410 | 8 x 1/2 | #2 | 100 | 500 | 4000 | 0.36# |
| TEKPH834 | 17415 | 8 x 3/4 | #2 | 100 | 500 | 4000 | 0.43# |
| TEKPH81 | 17420 | 8 x 1 | #2 | 100 | 500 | 4000 | 0.58# |
| TEKPH8114 | 17385 | 8 x 1-1/4 | #2 | 100 | 500 | 4000 | 0.61# |
| TEKPH8112 | 17390 | 8 x 1-1/2 | #2 | 100 | 500 | 3000 | 0.72# |
| TEKPH82 | 17395 | 8 x 2 | #2 | 100 | 500 | 3000 | 0.92# |

#10

| | | | | | | | |
|------------|-------|------------|----|-----|-----|------|-------|
| TEKPH1012 | 17425 | 10 x 1/2 | #2 | 100 | 500 | 4000 | 0.47# |
| TEKPH1034 | 17430 | 10 x 3/4 | #2 | 100 | 500 | 4000 | 0.59# |
| TEKPH101 | 17435 | 10 x 1 | #2 | 100 | 500 | 4000 | 0.76# |
| TEKPH10114 | 17440 | 10 x 1-1/4 | #2 | 100 | 500 | 3000 | 0.82# |
| TEKPH10112 | 17445 | 10 x 1-1/2 | #2 | 100 | 500 | 3000 | 0.93# |
| TEKPH102 | 17450 | 10 x 2 | #2 | 50 | 250 | 1500 | 0.61# |

PAN HEAD SQUARE DRIVE

PC 4220



Self drilling square drive pan head screws drill a hole and tap threads in one operation. The drilling operation removes metal and can be used with heavier gauge metals. Length is determined from the base of the fastener head.

FEATURES:

- Self Drilling
- Pan Head
- Square Drive
- Zinc Plated Steel
- Invincibox™ Up To 2"
- Tuff Pack

#8

| CAT. NO. | UPC | SIZE | BIT SIZE | STD | SLV | MSTR | WT/STD |
|-----------|-------|-----------|----------|-----|-----|------|--------|
| TEKDD812 | 59500 | 8 x 1/2 | #2 | 100 | 500 | 4000 | 0.36# |
| TEKDD834 | 59502 | 8 x 3/4 | #2 | 100 | 500 | 4000 | 0.43# |
| TEKDD81 | 59504 | 8 x 1 | #2 | 100 | 500 | 4000 | 0.58# |
| TEKDD8114 | 59517 | 8 x 1-1/4 | #2 | 100 | 500 | 4000 | 0.82# |
| TEKDD8112 | 59518 | 8 x 1-1/2 | #2 | 100 | 500 | 3000 | 0.93# |
| TEKDD82 | 59519 | 8 x 2 | #2 | 100 | 500 | 3000 | 1.22# |

#10

| | | | | | | | |
|------------|-------|------------|----|-----|-----|------|-------|
| TEKDD1012 | 59506 | 10 x 1/2 | #2 | 100 | 500 | 4000 | 0.47# |
| TEKDD1034 | 59508 | 10 x 3/4 | #2 | 100 | 500 | 4000 | 0.59# |
| TEKDD101 | 59510 | 10 x 1 | #2 | 100 | 500 | 4000 | 0.76# |
| TEKDD10114 | 59520 | 10 x 1-1/4 | #2 | 100 | 500 | 3000 | 0.82# |
| TEKDD10112 | 59521 | 10 x 1-1/2 | #2 | 100 | 500 | 3000 | 0.93# |
| TEKDD102 | 59522 | 10 x 2 | #2 | 50 | 250 | 1500 | 0.61# |

#8 TUFF PACK

| | | | | | | | |
|-----------|-------|---------|----|-----|--|------|-------|
| TEKDDT812 | 59511 | 8 x 1/2 | #2 | 500 | | 3000 | 1.76# |
| TEKDDT834 | 59512 | 8 x 3/4 | #2 | 500 | | 3000 | 2.28# |
| TEKDDT81 | 59513 | 8 x 1 | #2 | 500 | | 3000 | 2.76# |

#10 TUFF PACK

| | | | | | | | |
|------------|-------|----------|----|-----|--|------|-------|
| TEKDDT1012 | 59514 | 10 x 1/2 | #2 | 500 | | 3000 | 2.48# |
| TEKDDT1034 | 59515 | 10 x 3/4 | #2 | 500 | | 3000 | 3.10# |
| TEKDDT101 | 59516 | 10 x 1 | #2 | 500 | | 3000 | 3.60# |

PACKAGING:



STD



SLV



MSTR



TUFF PACK

TECH TALK



Self Drilling Screws

- Manufactured from high quality cold headed material and heat treated under controlled conditions yielding optimum drill performance.
- Better thread engagement and optimum holding powers are achieved by using a product which self-drills its own hole size.
- Available in a variety of head styles and drive systems to meet special application and installation demands.

HEX WASHER HEAD

PC 4220

Hex washer head self drilling screws drill a hole and tap threads in one operation. The drilling operation removes metal and can be used in heavier gauge metals. Length is determined from the base of the fastener head.



#6

| CAT. NO. | UPC | SIZE | HEX SIZE | STD | SLV | MSTR | WT/STD |
|----------|-------|---------|----------|-----|-----|------|--------|
| TEKHW612 | 17455 | 6 x 1/2 | 1/4" | 100 | 500 | 4000 | 0.26# |
| TEKHW634 | 17460 | 6 x 3/4 | 1/4" | 100 | 500 | 4000 | 0.31# |
| TEKHW61 | 17465 | 6 x 1 | 1/4" | 100 | 500 | 4000 | 0.37# |

#8

| | | | | | | | |
|-----------|-------|-----------|------|-----|-----|------|-------|
| TEKHW812 | 17500 | 8 x 1/2 | 1/4" | 100 | 500 | 4000 | 0.36# |
| TEKHW834 | 17505 | 8 x 3/4 | 1/4" | 100 | 500 | 4000 | 0.46# |
| TEKHW81 | 17510 | 8 x 1 | 1/4" | 100 | 500 | 4000 | 0.56# |
| TEKHW8114 | 17515 | 8 x 1-1/4 | 1/4" | 100 | 500 | 4000 | 0.68# |
| TEKHW8112 | 17520 | 8 x 1-1/2 | 1/4" | 100 | 500 | 3000 | 0.74# |
| TEKHW82 | 17523 | 8 x 2 | 1/4" | 100 | 500 | 3000 | 0.91# |

#10

| | | | | | | | |
|------------|-------|------------|-------|-----|-----|------|-------|
| TEKHW1012 | 17525 | 10 x 1/2 | 5/16" | 100 | 500 | 4000 | 0.51# |
| TEKHW1034 | 17530 | 10 x 3/4 | 5/16" | 100 | 500 | 4000 | 0.62# |
| TEKHW101 | 17535 | 10 x 1 | 5/16" | 100 | 500 | 4000 | 0.79# |
| TEKHW10114 | 17540 | 10 x 1-1/4 | 5/16" | 100 | 500 | 3000 | 0.92# |
| TEKHW10112 | 17545 | 10 x 1-1/2 | 5/16" | 100 | 500 | 3000 | 1.06# |
| TEKHW102 | 17547 | 10 x 2 | 5/16" | 50 | 250 | 1500 | 0.66# |

#12

| | | | | | | | |
|------------|-------|------------|-------|-----|-----|------|-------|
| TEKHW1234 | 17550 | 12 x 3/4 | 5/16" | 100 | 500 | 4000 | 0.89# |
| TEKHW121 | 17555 | 12 x 1 | 5/16" | 100 | 500 | 3000 | 1.08# |
| TEKHW12112 | 17560 | 12 x 1-1/2 | 5/16" | 100 | 500 | 3000 | 1.44# |
| TEKHW122 | 17562 | 12 x 2 | 5/16" | 50 | 250 | 1500 | 0.89# |

#14

| | | | | | | | |
|------------|-------|------------|------|-----|-----|------|-------|
| TEKHW1434 | 17565 | 14 x 3/4 | 3/8" | 100 | 500 | 3000 | 1.35# |
| TEKHW141 | 17570 | 14 x 1 | 3/8" | 100 | 500 | 3000 | 1.39# |
| TEKHW14114 | 17575 | 14 x 1-1/4 | 3/8" | 50 | 250 | 1500 | 1.86# |
| TEKHW14112 | 17580 | 14 x 1-1/2 | 3/8" | 50 | 250 | 1500 | 1.04# |
| TEKHW142 | 17585 | 14 x 2 | 3/8" | 50 | 250 | 1500 | 1.16# |

#8 TUFF PACK

| | | | | | | | |
|----------|-------|---------|------|-----|--|------|-------|
| TEKHT812 | 17800 | 8 x 1/2 | 1/4" | 500 | | 3000 | 2.04# |
| TEKHT834 | 17802 | 8 x 3/4 | 1/4" | 500 | | 3000 | 2.22# |
| TEKHT81 | 17804 | 8 x 1 | 1/4" | 500 | | 3000 | 2.76# |

#10 TUFF PACK

| | | | | | | | |
|-----------|-------|----------|-------|-----|--|------|-------|
| TEKHT1012 | 17806 | 10 x 1/2 | 5/16" | 500 | | 3000 | 2.48# |
| TEKHT1034 | 17808 | 10 x 3/4 | 5/16" | 500 | | 3000 | 3.10# |
| TEKHT101 | 17810 | 10 x 1 | 5/16" | 500 | | 3000 | 3.74# |

FEATURES:

- Self Drilling
- Hex Washer Head
- Zinc Plated Steel
- Invincibox™ Up To 2"
- Tuff Pack

PACKAGING:



STD

SLV

MSTR

TUFF PACK

WAFFER HEAD PHILLIPS

PC 4200

Self drilling phillips wafer head screws drill a hole and tap threads in one operation. The drilling operation removes metal and can be used with heavier gauge metals. Length is determined from the base of the fastener head.



#8

| CAT. NO. | UPC | SIZE | BIT SIZE | STD | SLV | MSTR | WT/STD |
|----------|-------|-----------|----------|-----|-----|------|--------|
| TEKW812 | 17775 | 8 x 1/2 | #2 | 100 | 500 | 4000 | 0.34# |
| TEKW834 | 17780 | 8 x 3/4 | #2 | 100 | 500 | 4000 | 0.45# |
| TEKW81 | 81481 | 8 x 1 | #2 | 100 | 500 | 4000 | 0.56# |
| TEKW8114 | 17785 | 8 x 1-1/4 | #2 | 100 | 500 | 4000 | 0.67# |

#8 TUFF PACK

| | | | | | | | |
|----------|-------|---------|----|-----|--|------|-------|
| TEKWT812 | 17790 | 8 x 1/2 | #2 | 500 | | 3000 | 2.04# |
| TEKWT834 | 17795 | 8 x 3/4 | #2 | 500 | | 3000 | 2.68# |
| TEKWT81 | 81482 | 8 x 1 | #2 | 500 | | 3000 | 2.80# |

#8 BULK PACK

| | | | | | | | |
|------------|-------|-----------|----|-------|--|-------|--------|
| TEKW812BK | 81483 | 8 X 1/2 | #2 | 10000 | | 10000 | 34.00# |
| TEKW834BK | 81484 | 8 X 3/4 | #2 | 10000 | | 10000 | 45.00# |
| TEKW81BK | 81485 | 8 X 1 | #2 | 6500 | | 6500 | 29.25# |
| TEKW8114BK | 81486 | 8 X 1-1/4 | #2 | 6500 | | 6500 | 30.55# |

FEATURES:

- Self Drilling
- Wafer Head
- Phillips
- Zinc Plated Steel
- Invincibox™
- Tuff Pack

SHARPEEZ SLOTTED HEX WASHER HEAD

PC 4190



Sharpeez screws are metal piercing and will tap their own mating threads. Hex washer slotted head. Length is de-termined from the base of the fastener head. Used for framing, electrical, plumbing, and sheet metal applications.

FEATURES:

- Sharpeez
- Hex Washer Head
- Slotted
- Zinc Plated Steel
- Metal Piercing
- Invincibox™
- Tuff Pack
- Bulk Pack

#8

| CAT. NO. | UPC | SIZE | HEX SIZE | STD | SLV | MSTR | WT/STD |
|----------|-------|-----------|----------|-----|-----|------|--------|
| SP812 | 16250 | 8 x 1/2 | 1/4" | 100 | 500 | 4000 | 0.32# |
| SP834 | 16252 | 8 x 3/4 | 1/4" | 100 | 500 | 4000 | 0.42# |
| SP81 | 16254 | 8 x 1 | 1/4" | 100 | 500 | 4000 | 0.52# |
| SP8114 | 16256 | 8 x 1-1/4 | 1/4" | 100 | 500 | 4000 | 0.60# |
| SP8112 | 16258 | 8 x 1-1/2 | 1/4" | 100 | 500 | 3000 | 0.70# |
| SP82 | 16260 | 8 x 2 | 1/4" | 100 | 500 | 3000 | 0.94# |

#8 TUFF PACK

| | | | | | | | |
|---------|-------|-----------|------|-----|--|------|-------|
| SPT812 | 16262 | 8 x 1/2 | 1/4" | 500 | | 3000 | 3.05# |
| SPT834 | 16264 | 8 x 3/4 | 1/4" | 500 | | 3000 | 3.99# |
| SPT81 | 16266 | 8 x 1 | 1/4" | 500 | | 3000 | 5.06# |
| SPT8114 | 16268 | 8 x 1-1/4 | 1/4" | 500 | | 3000 | 2.97# |
| SPT8112 | 16270 | 8 x 1-1/2 | 1/4" | 500 | | 3000 | 3.71# |
| SPT82 | 16272 | 8 x 2 | 1/4" | 300 | | 1800 | 2.80# |

#8 BULK PACK

| | | | | | | | |
|----------|-------|-----------|------|-------|--|-------|--------|
| SPBK812 | 16274 | 8 x 1/2 | 1/4" | 10000 | | 10000 | 31.32# |
| SPBK834 | 16276 | 8 x 3/4 | 1/4" | 10000 | | 10000 | 39.44# |
| SPBK81 | 16278 | 8 x 1 | 1/4" | 7000 | | 7000 | 34.38# |
| SPBK8114 | 16280 | 8 x 1-1/4 | 1/4" | 5000 | | 5000 | 29.20# |
| SPBK8112 | 16282 | 8 x 1-1/2 | 1/4" | 3000 | | 3000 | 23.14# |
| SPBK82 | 16284 | 8 x 2 | 1/4" | 3000 | | 3000 | 36.44# |

PHILLIPS PAN HEAD FRAMER SCREWS

PC 4220



Phillips pan head framer screws are ideal for light duty aluminum and steel metal to metal applications. Will penetrate through 20 gauge steel studs. Length is determined from base of the fastener head. Black oxide finish.

#7

| CAT. NO. | UPC | SIZE | BIT SIZE | STD | SLV | MSTR | WT/STD |
|-----------|-------|----------|----------|-----|-----|------|--------|
| TEKF7716 | 59523 | 7 x 7/16 | #2 | 100 | 500 | 4000 | 0.27# |
| TEKFT7716 | 59524 | 7 x 7/16 | #2 | 500 | | 3000 | 1.35# |

FEATURES:

- Framers Screws
- Pan Head
- Phillips
- Black Oxide
- Self Drilling
- Invincibox™
- Tuff Pack

PACKAGING:



STD

SLV



MSTR



TUFF PACK

TECH TALK

Metal Piercing Screws

Sharpeez (Hex-Slotted) and K-Lath (Modified Truss Phillips & Square Drive). Used for framing, electrical, plumbing and sheet metal applications.



Framer Screws

Heat treated point. Pierces metal. Used for mounting boxes to metal studs or attaching stud to track and stud framing.



Applications:

Electrical Plumbing Framing Sheet Metal

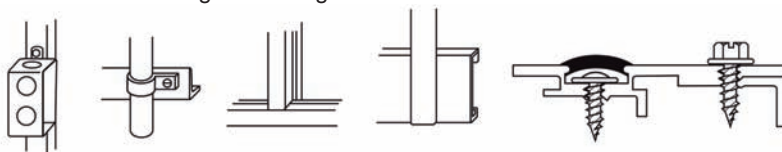

HEX HEAD

Fully threaded hex head tap bolts. Made from grade 2 low carbon steel. Length is determined from the base of the fastener head. Continuous thread allows for take up adjustment. (MACHINE BOLTS)



1/4-20

| CAT. NO. | UPC | SIZE | HEX SIZE | STD | MSTR | WT/STD |
|----------|-------|-------------|----------|-----|------|--------|
| MB1412 | 58700 | 1/4 x 1/2 | 7/16" | 100 | 4000 | 1.18# |
| MB1434 | 58702 | 1/4 x 3/4 | 7/16" | 100 | 3000 | 1.44# |
| MB141 | 58704 | 1/4 x 1 | 7/16" | 100 | 3000 | 1.67# |
| MB14114 | 58706 | 1/4 x 1-1/4 | 7/16" | 100 | 1000 | 2.01# |
| MB14112 | 58708 | 1/4 x 1-1/2 | 7/16" | 100 | 1000 | 2.36# |
| MB142 | 58710 | 1/4 x 2 | 7/16" | 100 | 1000 | 3.07# |
| MB14212 | 58712 | 1/4 x 2-1/2 | 7/16" | 100 | 1000 | 3.75# |
| MB143 | 58714 | 1/4 x 3 | 7/16" | 100 | 1000 | 4.35# |
| MB14312 | 58716 | 1/4 x 3-1/2 | 7/16" | 100 | 1000 | 5.10# |
| MB144 | 58718 | 1/4 x 4 | 7/16" | 100 | 1000 | 5.75# |
| MB14412 | 58720 | 1/4 x 4-1/2 | 7/16" | 100 | 1000 | 6.36# |
| MB145 | 58722 | 1/4 x 5 | 7/16" | 100 | 400 | 6.92# |
| MB14512 | 58724 | 1/4 x 5-1/2 | 7/16" | 100 | 400 | 7.74# |
| MB146 | 58726 | 1/4 x 6 | 7/16" | 100 | 400 | 8.39# |

5/16-18

| | | | | | | |
|----------|-------|--------------|------|-----|------|-------|
| MB51612 | 58750 | 5/16 x 1/2 | 1/2" | 100 | 1000 | 1.95# |
| MB51634 | 58752 | 5/16 x 3/4 | 1/2" | 100 | 1000 | 2.33# |
| MB5161 | 58754 | 5/16 x 1 | 1/2" | 100 | 1000 | 2.74# |
| MB516114 | 58756 | 5/16 x 1-1/4 | 1/2" | 100 | 1000 | 3.23# |
| MB516112 | 58758 | 5/16 x 1-1/2 | 1/2" | 100 | 1000 | 3.82# |
| MB5162 | 58760 | 5/16 x 2 | 1/2" | 100 | 1000 | 4.82# |
| MB516212 | 58762 | 5/16 x 2-1/2 | 1/2" | 100 | 1000 | 5.95# |
| MB5163 | 58764 | 5/16 x 3 | 1/2" | 100 | 1000 | 6.91# |
| MB516312 | 58766 | 5/16 x 3-1/2 | 1/2" | 50 | 500 | 3.60# |
| MB5164 | 58768 | 5/16 x 4 | 1/2" | 50 | 500 | 4.12# |
| MB516412 | 58770 | 5/16 x 4-1/2 | 1/2" | 50 | 500 | 4.41# |
| MB5165 | 58772 | 5/16 x 5 | 1/2" | 50 | 200 | 5.54# |
| MB516512 | 58774 | 5/16 x 5-1/2 | 1/2" | 50 | 200 | 6.15# |
| MB5166 | 58776 | 5/16 x 6 | 1/2" | 50 | 200 | 6.63# |

3/8-16

| | | | | | | |
|---------|-------|-------------|-------|-----|------|-------|
| MB3812 | 58800 | 3/8 x 1/2 | 9/16" | 100 | 1000 | 2.93# |
| MB3834 | 58802 | 3/8 x 3/4 | 9/16" | 100 | 1000 | 3.55# |
| MB381 | 58804 | 3/8 x 1 | 9/16" | 100 | 1000 | 4.03# |
| MB38114 | 58806 | 3/8 x 1-1/4 | 9/16" | 100 | 1000 | 4.48# |
| MB38112 | 58808 | 3/8 x 1-1/2 | 9/16" | 100 | 1000 | 5.54# |
| MB382 | 58810 | 3/8 x 2 | 9/16" | 100 | 1000 | 6.94# |
| MB38212 | 58812 | 3/8 x 2-1/2 | 9/16" | 100 | 500 | 7.80# |
| MB383 | 58814 | 3/8 x 3 | 9/16" | 100 | 500 | 9.03# |
| MB38312 | 58816 | 3/8 x 3-1/2 | 9/16" | 50 | 500 | 5.10# |
| MB384 | 58818 | 3/8 x 4 | 9/16" | 50 | 500 | 6.53# |
| MB38412 | 58820 | 3/8 x 4-1/2 | 9/16" | 50 | 500 | 7.21# |
| MB385 | 58822 | 3/8 x 5 | 9/16" | 50 | 200 | 7.98# |
| MB38512 | 58824 | 3/8 x 5-1/2 | 9/16" | 50 | 200 | 8.30# |
| MB386 | 58826 | 3/8 x 6 | 9/16" | 50 | 200 | 8.74# |

1/2-13

| | | | | | | |
|---------|-------|-------------|------|----|-----|--------|
| MB1234 | 58850 | 1/2 x 3/4 | 3/4" | 50 | 500 | 4.05# |
| MB121 | 58852 | 1/2 x 1 | 3/4" | 50 | 500 | 4.36# |
| MB12114 | 58854 | 1/2 x 1-1/4 | 3/4" | 50 | 500 | 4.69# |
| MB12112 | 58856 | 1/2 x 1-1/2 | 3/4" | 50 | 500 | 6.50# |
| MB122 | 58858 | 1/2 x 2 | 3/4" | 50 | 500 | 6.73# |
| MB12212 | 58860 | 1/2 x 2-1/2 | 3/4" | 50 | 200 | 8.02# |
| MB123 | 58862 | 1/2 x 3 | 3/4" | 50 | 200 | 9.37# |
| MB12312 | 58864 | 1/2 x 3-1/2 | 3/4" | 50 | 200 | 10.75# |
| MB124 | 58866 | 1/2 x 4 | 3/4" | 25 | 250 | 6.02# |
| MB12412 | 58868 | 1/2 x 4-1/2 | 3/4" | 25 | 250 | 6.65# |
| MB125 | 58870 | 1/2 x 5 | 3/4" | 25 | 250 | 7.40# |
| MB12512 | 58872 | 1/2 x 5-1/2 | 3/4" | 25 | 100 | 8.10# |
| MB126 | 58874 | 1/2 x 6 | 3/4" | 25 | 100 | 8.78# |

* 5/8" & 3/4" available upon request.

FEATURES:

- Hex Head Tap Bolts
- Full Thread
- Grade 2
- Zinc Plated Steel



CAP SCREWS

HEX HEAD - GRADE 5

PC 4018

FASTENERS & HARDWARE



Grade 5 hex head cap screws are medium strength (120,000 PSI tensile) and are made from carbon steel. Length is determined from the base of the fastener head.

FEATURES:

- Hex Head Cap Screws
- Partial Thread
- Grade 5
- Zinc Plated Steel

1/4-20

| CAT. NO. | UPC | SIZE | HEX SIZE | STD | MSTR | WT/STD |
|----------|-------|-------------|----------|-----|------|--------|
| 5MB1412 | 18000 | 1/4 x 1/2 | 7/16" | 100 | 4000 | 1.18# |
| 5MB1434 | 18001 | 1/4 x 3/4 | 7/16" | 100 | 1000 | 1.44# |
| 5MB141 | 18002 | 1/4 x 1 | 7/16" | 100 | 1000 | 1.67# |
| 5MB14114 | 18003 | 1/4 x 1-1/4 | 7/16" | 100 | 1000 | 2.01# |
| 5MB14112 | 18004 | 1/4 x 1-1/2 | 7/16" | 100 | 1000 | 2.36# |
| 5MB142 | 18005 | 1/4 x 2 | 7/16" | 100 | 1000 | 3.07# |
| 5MB14212 | 18006 | 1/4 x 2-1/2 | 7/16" | 100 | 1000 | 3.75# |
| 5MB143 | 18007 | 1/4 x 3 | 7/16" | 100 | 1000 | 4.35# |
| 5MB14312 | 18008 | 1/4 x 3-1/2 | 7/16" | 100 | 1000 | 5.10# |
| 5MB144 | 18009 | 1/4 x 4 | 7/16" | 100 | 1000 | 5.75# |

5/16-18

| | | | | | | |
|-----------|-------|--------------|------|-----|------|-------|
| 5MB51612 | 18014 | 5/16 x 1/2 | 1/2" | 100 | 1000 | 1.95# |
| 5MB51634 | 18015 | 5/16 x 3/4 | 1/2" | 100 | 1000 | 2.33# |
| 5MB5161 | 18016 | 5/16 x 1 | 1/2" | 100 | 1000 | 2.74# |
| 5MB516114 | 18017 | 5/16 x 1-1/4 | 1/2" | 100 | 1000 | 3.23# |
| 5MB516112 | 18018 | 5/16 x 1-1/2 | 1/2" | 100 | 1000 | 3.82# |
| 5MB5162 | 18019 | 5/16 x 2 | 1/2" | 100 | 1000 | 4.82# |
| 5MB516212 | 18020 | 5/16 x 2-1/2 | 1/2" | 100 | 1000 | 5.95# |
| 5MB5163 | 18021 | 5/16 x 3 | 1/2" | 100 | 1000 | 6.91# |
| 5MB516312 | 18022 | 5/16 x 3-1/2 | 1/2" | 50 | 500 | 3.62# |
| 5MB5164 | 18023 | 5/16 x 4 | 1/2" | 50 | 500 | 3.82# |

3/8-16

| | | | | | | |
|----------|-------|-------------|-------|-----|------|-------|
| 5MB3812 | 18028 | 3/8 x 1/2 | 9/16" | 100 | 1000 | 2.93# |
| 5MB3834 | 18029 | 3/8 x 3/4 | 9/16" | 100 | 1000 | 3.55# |
| 5MB381 | 18030 | 3/8 x 1 | 9/16" | 100 | 1000 | 4.03# |
| 5MB38114 | 18031 | 3/8 x 1-1/4 | 9/16" | 100 | 1000 | 4.48# |
| 5MB38112 | 18032 | 3/8 x 1-1/2 | 9/16" | 100 | 1000 | 5.54# |
| 5MB382 | 18033 | 3/8 x 2 | 9/16" | 100 | 1000 | 6.94# |
| 5MB38212 | 18034 | 3/8 x 2-1/2 | 9/16" | 100 | 500 | 8.68# |
| 5MB383 | 18035 | 3/8 x 3 | 9/16" | 100 | 500 | 9.49# |
| 5MB38312 | 18036 | 3/8 x 3-1/2 | 9/16" | 50 | 500 | 5.65# |
| 5MB384 | 18037 | 3/8 x 4 | 9/16" | 50 | 500 | 6.94# |

1/2-13

| | | | | | | |
|----------|-------|-------------|------|----|-----|--------|
| 5MB1234 | 18042 | 1/2 x 3/4 | 3/4" | 50 | 500 | 4.05# |
| 5MB121 | 18043 | 1/2 x 1 | 3/4" | 50 | 500 | 4.15# |
| 5MB12114 | 18044 | 1/2 x 1-1/4 | 3/4" | 50 | 500 | 4.69# |
| 5MB12112 | 18045 | 1/2 x 1-1/2 | 3/4" | 50 | 500 | 5.21# |
| 5MB122 | 18046 | 1/2 x 2 | 3/4" | 50 | 500 | 6.73# |
| 5MB12212 | 18047 | 1/2 x 2-1/2 | 3/4" | 50 | 200 | 8.02# |
| 5MB123 | 18048 | 1/2 x 3 | 3/4" | 50 | 200 | 9.37# |
| 5MB12312 | 18049 | 1/2 x 3-1/2 | 3/4" | 50 | 200 | 10.75# |
| 5MB124 | 18050 | 1/2 x 4 | 3/4" | 25 | 100 | 6.02# |

TECH TALK



| Grade | Page Number | Head Marking | Description |
|-------------------------------|-------------------------|--------------|---|
| Grade 2 Bolt (Full Thread) | A21 | | Low Grade Carbon Steel |
| Grade 5 Bolt (Partial Thread) | A22 | | Medium Carbon Steel Quenched & Tempered |
| Grade 8 Bolt (Partial Thread) | Available Special Order | | Medium Carbon Alloy Steel Quenched & Tempered |
| Grade 2 Washer | A28-A29 | | Low Grade Carbon Steel |
| Hard Alloy Washer | A28 | | Use with Grade 5 & 8 Bolts |
| Grade 5 Hex Nuts | A26 | | Medium Carbon Steel Quenched & Tempered |
| Grade 8 Hex Nuts | Available Special Order | | Medium Carbon Alloy Steel Quenched & Tempered |

A22

CELEBRATING 50 YEARS

CAP SCREWS & TAP BOLTS

HEX HEAD CAP SCREWS - STAINLESS

PC 4010

Stainless steel hex head cap screws are used in non-critical applications with nuts and washers. Length is determined from the base of the fastener head. 18-8 Stainless Steel is used where corrosion resistance is required. 18% chromium, 8% nickel.



FEATURES:

- Hex Head Cap Screws
- Partial Thread
- 18-8 Stainless Steel

1/4-20

| CAT. NO. | UPC | SIZE | HEX SIZE | STD | MSTR | WT/STD |
|----------|-------|-------------|----------|-----|------|--------|
| MBS1412 | 69704 | 1/4 x 1/2 | 7/16" | 100 | 1000 | 1.18# |
| MBS1434 | 69706 | 1/4 x 3/4 | 7/16" | 100 | 1000 | 1.44# |
| MBS141 | 69708 | 1/4 x 1 | 7/16" | 100 | 1000 | 1.67# |
| MBS14114 | 69710 | 1/4 x 1-1/4 | 7/16" | 100 | 1000 | 2.01# |
| MBS14112 | 69712 | 1/4 x 1-1/2 | 7/16" | 100 | 1000 | 2.36# |
| MBS142 | 69714 | 1/4 x 2 | 7/16" | 100 | 1000 | 3.07# |

5/16-18

| | | | | | | |
|-----------|-------|--------------|------|-----|------|-------|
| MBS51612 | 69744 | 5/16 x 1/2 | 1/2" | 100 | 1000 | 1.95# |
| MBS51634 | 69746 | 5/16 x 3/4 | 1/2" | 100 | 1000 | 2.33# |
| MBS5161 | 69748 | 5/16 x 1 | 1/2" | 100 | 1000 | 2.74# |
| MBS516114 | 69750 | 5/16 x 1-1/4 | 1/2" | 100 | 1000 | 3.23# |
| MBS516112 | 69752 | 5/16 x 1-1/2 | 1/2" | 100 | 1000 | 3.82# |
| MBS5162 | 69754 | 5/16 x 2 | 1/2" | 100 | 1000 | 4.82# |

3/8-16

| | | | | | | |
|----------|-------|-------------|-------|-----|------|-------|
| MBS3812 | 69804 | 3/8 x 1/2 | 9/16" | 100 | 1000 | 2.93# |
| MBS3834 | 69806 | 3/8 x 3/4 | 9/16" | 100 | 1000 | 3.55# |
| MBS381 | 69808 | 3/8 x 1 | 9/16" | 100 | 1000 | 4.03# |
| MBS38114 | 69810 | 3/8 x 1-1/4 | 9/16" | 100 | 1000 | 4.48# |
| MBS38112 | 69812 | 3/8 x 1-1/2 | 9/16" | 100 | 1000 | 5.54# |
| MBS382 | 69814 | 3/8 x 2 | 9/16" | 100 | 1000 | 6.94# |

1/2-13

| | | | | | | |
|----------|-------|-------------|------|----|-----|-------|
| MBS1234 | 69844 | 1/2 x 3/4 | 3/4" | 50 | 500 | 3.63# |
| MBS121 | 69846 | 1/2 x 1 | 3/4" | 50 | 500 | 4.15# |
| MBS12114 | 69848 | 1/2 x 1-1/4 | 3/4" | 50 | 500 | 4.69# |
| MBS12112 | 69850 | 1/2 x 1-1/2 | 3/4" | 50 | 500 | 5.21# |
| MBS122 | 69852 | 1/2 x 2 | 3/4" | 50 | 500 | 6.73# |

HEX HEAD TAP BOLTS - SILICON BRONZE

PC 4015

Silicon bronze hex head tap bolts are used in non-critical applications with nuts and washers. Length is determined from the base of the fastener head. Silicon bronze is superior for marine applications. It will not corrode, is harder than brass and has a high resistance to extreme temperatures.



FEATURES:

- Hex Head Tap Bolts
- Full Thread
- Silicon Bronze

1/4-20

| CAT. NO. | UPC | SIZE | HEX SIZE | STD | MSTR | WT/STD |
|-----------|-------|-------------|----------|-----|------|--------|
| MBBZ1412 | 58300 | 1/4 x 1/2 | 7/16" | 100 | 4000 | 1.18# |
| MBBZ1434 | 58301 | 1/4 x 3/4 | 7/16" | 100 | 1000 | 1.44# |
| MBBZ141 | 58302 | 1/4 x 1 | 7/16" | 100 | 1000 | 1.67# |
| MBBZ14114 | 58303 | 1/4 x 1-1/4 | 7/16" | 100 | 1000 | 2.01# |
| MBBZ14112 | 58304 | 1/4 x 1-1/2 | 7/16" | 100 | 1000 | 2.36# |
| MBBZ142 | 58305 | 1/4 x 2 | 7/16" | 100 | 1000 | 3.07# |

5/16-18

| | | | | | | |
|------------|-------|--------------|------|-----|------|-------|
| MBBZ51612 | 58308 | 5/16 x 1/2 | 1/2" | 100 | 1000 | 1.95# |
| MBBZ51634 | 58309 | 5/16 x 3/4 | 1/2" | 100 | 1000 | 2.33# |
| MBBZ5161 | 58310 | 5/16 x 1 | 1/2" | 100 | 1000 | 2.74# |
| MBBZ516114 | 58311 | 5/16 x 1-1/4 | 1/2" | 100 | 1000 | 3.23# |
| MBBZ516112 | 58312 | 5/16 x 1-1/2 | 1/2" | 100 | 1000 | 3.82# |
| MBBZ5162 | 58313 | 5/16 x 2 | 1/2" | 100 | 1000 | 4.82# |

3/8-16

| | | | | | | |
|-----------|-------|-------------|-------|-----|------|-------|
| MBBZ3812 | 58316 | 3/8 x 1/2 | 9/16" | 100 | 1000 | 2.93# |
| MBBZ3834 | 58317 | 3/8 x 3/4 | 9/16" | 100 | 1000 | 3.55# |
| MBBZ381 | 58318 | 3/8 x 1 | 9/16" | 100 | 1000 | 4.03# |
| MBBZ38114 | 58319 | 3/8 x 1-1/4 | 9/16" | 100 | 1000 | 4.48# |
| MBBZ38112 | 58320 | 3/8 x 1-1/2 | 9/16" | 100 | 1000 | 5.54# |
| MBBZ382 | 58321 | 3/8 x 2 | 9/16" | 100 | 1000 | 6.94# |

1/2-13

| | | | | | | |
|-----------|-------|-------------|------|----|-----|-------|
| MBBZ1234 | 58326 | 1/2 x 3/4 | 3/4" | 50 | 500 | 3.63# |
| MBBZ121 | 58327 | 1/2 x 1 | 3/4" | 50 | 500 | 4.15# |
| MBBZ12114 | 58328 | 1/2 x 1-1/4 | 3/4" | 50 | 500 | 4.69# |
| MBBZ12112 | 58329 | 1/2 x 1-1/2 | 3/4" | 50 | 500 | 5.21# |
| MBBZ122 | 58330 | 1/2 x 2 | 3/4" | 50 | 500 | 6.73# |

HEX HEAD

PC 4080



Lag screws are used in woodworking when standard wood screws are too short or too small. Also used in concrete, brick or in mortar when used with lag shields. Length is determined from the base of the fastener head.

FEATURES:

- Lag Screws
- Hex Head
- Zinc Plated Steel

1/4

| CAT. NO. | UPC | SIZE | HEX SIZE | STD | MSTR | WT/STD |
|----------|-------|-------------|----------|-----|------|--------|
| LAG141 | 58500 | 1/4 x 1 | 7/16" | 100 | 1000 | 1.48# |
| LAG14114 | 58502 | 1/4 x 1-1/4 | 7/16" | 100 | 1000 | 1.67# |
| LAG14112 | 58503 | 1/4 x 1-1/2 | 7/16" | 100 | 1000 | 1.83# |
| LAG142 | 58504 | 1/4 x 2 | 7/16" | 100 | 1000 | 2.58# |
| LAG14212 | 58506 | 1/4 x 2-1/2 | 7/16" | 100 | 1000 | 3.00# |
| LAG143 | 58508 | 1/4 x 3 | 7/16" | 100 | 1000 | 3.57# |
| LAG14312 | 58510 | 1/4 x 3-1/2 | 7/16" | 100 | 1000 | 4.03# |
| LAG144 | 58512 | 1/4 x 4 | 7/16" | 100 | 1000 | 4.44# |
| LAG14412 | 58514 | 1/4 x 4-1/2 | 7/16" | 100 | 1000 | 4.90# |
| LAG145 | 58516 | 1/4 x 5 | 7/16" | 100 | 400 | 5.46# |
| LAG14512 | 58518 | 1/4 x 5-1/2 | 7/16" | 100 | 400 | 6.21# |
| LAG146 | 58520 | 1/4 x 6 | 7/16" | 100 | 400 | 6.59# |

5/16

| | | | | | | |
|-----------|-------|--------------|------|-----|------|--------|
| LAG5161 | 58550 | 5/16 x 1 | 1/2" | 100 | 1000 | 2.93# |
| LAG516114 | 58552 | 5/16 x 1-1/4 | 1/2" | 100 | 1000 | 3.21# |
| LAG516112 | 58553 | 5/16 x 1-1/2 | 1/2" | 100 | 1000 | 3.49# |
| LAG5162 | 58554 | 5/16 x 2 | 1/2" | 100 | 1000 | 4.05# |
| LAG516212 | 58556 | 5/16 x 2-1/2 | 1/2" | 100 | 1000 | 4.62# |
| LAG5163 | 58558 | 5/16 x 3 | 1/2" | 100 | 500 | 5.38# |
| LAG516312 | 58560 | 5/16 x 3-1/2 | 1/2" | 100 | 400 | 5.94# |
| LAG5164 | 58562 | 5/16 x 4 | 1/2" | 100 | 400 | 6.88# |
| LAG516412 | 58564 | 5/16 x 4-1/2 | 1/2" | 100 | 400 | 7.76# |
| LAG5165 | 58566 | 5/16 x 5 | 1/2" | 100 | 400 | 8.62# |
| LAG516512 | 58568 | 5/16 x 5-1/2 | 1/2" | 100 | 400 | 9.94# |
| LAG5166 | 58670 | 5/16 x 6 | 1/2" | 100 | 400 | 10.15# |

3/8

| | | | | | | |
|----------|-------|-------------|-------|-----|------|-------|
| LAG381 | 58598 | 3/8 x 1 | 9/16" | 100 | 1000 | 3.18# |
| LAG38114 | 58600 | 3/8 x 1-1/4 | 9/16" | 100 | 1000 | 3.66# |
| LAG38112 | 58601 | 3/8 x 1-1/2 | 9/16" | 100 | 1000 | 4.19# |
| LAG382 | 58602 | 3/8 x 2 | 9/16" | 100 | 1000 | 5.40# |
| LAG38212 | 58604 | 3/8 x 2-1/2 | 9/16" | 100 | 1000 | 6.51# |
| LAG383 | 58606 | 3/8 x 3 | 9/16" | 100 | 400 | 8.78# |
| LAG38312 | 58608 | 3/8 x 3-1/2 | 9/16" | 50 | 500 | 4.39# |
| LAG384 | 58610 | 3/8 x 4 | 9/16" | 50 | 500 | 5.04# |
| LAG38412 | 58612 | 3/8 x 4-1/2 | 9/16" | 50 | 500 | 6.07# |
| LAG385 | 58614 | 3/8 x 5 | 9/16" | 50 | 200 | 6.26# |
| LAG38512 | 58616 | 3/8 x 5-1/2 | 9/16" | 50 | 200 | 6.96# |
| LAG386 | 58618 | 3/8 x 6 | 9/16" | 50 | 200 | 7.50# |

1/2

| | | | | | | |
|----------|-------|-------------|------|----|-----|-------|
| LAG12114 | 58650 | 1/2 x 1-1/4 | 3/4" | 50 | 500 | 3.59# |
| LAG12112 | 58651 | 1/2 x 1-1/2 | 3/4" | 50 | 500 | 4.40# |
| LAG122 | 58652 | 1/2 x 2 | 3/4" | 50 | 500 | 6.12# |
| LAG12212 | 58654 | 1/2 x 2-1/2 | 3/4" | 50 | 500 | 7.00# |
| LAG123 | 58656 | 1/2 x 3 | 3/4" | 50 | 500 | 7.38# |
| LAG12312 | 58658 | 1/2 x 3-1/2 | 3/4" | 25 | 250 | 4.38# |
| LAG124 | 58660 | 1/2 x 4 | 3/4" | 25 | 250 | 4.87# |
| LAG12412 | 58662 | 1/2 x 4-1/2 | 3/4" | 25 | 250 | 5.45# |
| LAG125 | 58664 | 1/2 x 5 | 3/4" | 25 | 100 | 6.05# |
| LAG12512 | 58666 | 1/2 x 5-1/2 | 3/4" | 25 | 100 | 6.65# |
| LAG126 | 58668 | 1/2 x 6 | 3/4" | 25 | 100 | 7.20# |

TECH TALK



Lag Shields

Lag shields allow the use of lag bolts in concrete, block and mortar and are available in two styles; long and short. The short lag is used in hard masonry while the long is used in soft masonry. For installation and technical information please refer to page B5.



THREADED ROD

PC 4850, 4855

Threaded rod is used in a variety of applications such as suspending fixtures, strut or conduit. User can cut to length as need requires.



6 FOOT - PC 4855

| CAT. NO. | UPC | SIZE | STD | BUNDLE | WT/STD |
|----------|-------|-------------|--------|--------|--------|
| ROD146 | 17316 | 1/4-20 x 6' | 300 Ft | 300 Ft | 35.00# |
| ROD386 | 17317 | 3/8-16 x 6' | 150 Ft | 150 Ft | 40.00# |
| ROD126 | 17318 | 1/2-13 x 6' | 75 Ft | 75 Ft | 38.00# |

10 FOOT - PC 4850

| CAT. NO. | UPC | SIZE | STD | BUNDLE | WT/STD |
|----------|-------|---------------|--------|--------|--------|
| ROD14 | 17320 | 1/4-20 x 10' | 500 Ft | 500 Ft | 60.00# |
| ROD516 | 17325 | 5/16-18 x 10' | 350 Ft | 350 Ft | 68.00# |
| ROD38 | 17330 | 3/8-16 x 10' | 250 Ft | 250 Ft | 73.00# |
| ROD12 | 17335 | 1/2-13 x 10' | 100 Ft | 100 Ft | 53.00# |
| ROD58 | 17340 | 5/8-11 x 10' | 50 Ft | 50 Ft | 42.00# |
| ROD34 | 17345 | 3/4-10 x 10' | 50 Ft | 50 Ft | 67.00# |

FEATURES:

- Threaded Rod
- 6 Ft. Lengths
- Zinc Plated Steel
- 6 & 10 Ft.

THREADED ROD 6 FOOT LENGTHS - STAINLESS

PC 4010

Threaded rod is used in a variety of applications such as suspending fixtures, strut or conduit. User can cut to length as need requires.



| CAT. NO. | UPC | SIZE | STD | BUNDLE | WT/STD |
|----------|-------|-------------|------|--------|--------|
| RODS146 | 69952 | 1/4-20 x 6' | 6 Ft | 60 Ft | 0.72# |
| RODS386 | 69954 | 3/8-16 x 6' | 6 Ft | 60 Ft | 1.75# |
| RODS126 | 69956 | 1/2-13 x 6' | 6 Ft | 60 Ft | 3.18# |
| RODS586 | 69958 | 5/8-11 x 6' | 6 Ft | 60 Ft | 5.08# |
| RODS346 | 69960 | 3/4-10 x 6' | 6 Ft | 60 Ft | 8.04# |



FEATURES:

- Threaded Rod
- 6 Ft. Lengths
- 18-8 Stainless Steel

ROD COUPLINGS

PC 4860

Rod couplings are used to couple threaded rod for extended lengths. Reducing rod couplings are used when working with two different thread diameters.



| CAT. NO. | UPC | SIZE | LENGTH | STD | MSTR | WT/STD |
|----------|-------|----------|--------|-----|------|--------|
| RC1 | 30405 | 1/4" | 7/8" | 100 | 1000 | 1.90# |
| RC2 | 30410 | 3/8" | 1-1/8" | 50 | 500 | 1.80# |
| RC3 | 30415 | 1/2" | 1-1/4" | 50 | 500 | 2.90# |
| RC4 | 17300 | 5/16" | 7/8" | 50 | 500 | 2.98# |
| RC5 | 17305 | 5/8" | 2-1/8" | 25 | 250 | 4.41# |
| RC6 | 17307 | 3/4" | 2-1/4" | 25 | 250 | 9.10# |
| RRC21 | 17310 | 3/8-1/4" | 1" | 50 | 500 | 2.06# |
| RRC32 | 17315 | 1/2-3/8" | 1-1/4" | 50 | 500 | 6.90# |

*Reducing Coupling

FEATURES:

- Rod Couplings
- Reducing Rod Couplings
- Zinc Plated Steel

ROD COUPLINGS - STAINLESS

PC 4010

Rod couplings are used to couple threaded rod for extended lengths.

| CAT. NO. | UPC | SIZE | LENGTH | STD | MSTR | WT/STD |
|----------|-------|------|--------|-----|------|--------|
| RCS1 | 69944 | 1/4" | 7/8" | 100 | 1000 | 1.90# |
| RCS2 | 69946 | 3/8" | 1-1/8" | 50 | 500 | 1.80# |
| RCS3 | 69948 | 1/2" | 1-1/4" | 50 | 500 | 2.90# |

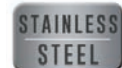

FEATURES:

- Rod Couplings
- 18-8 Stainless Steel

HEX NUTS



FEATURES:

- Zinc Plated - General Use
- Grade 5 - Medium Strength
- Stainless - Corrosion & Chemical Resistant
- Solid Brass Good Near Water & Salt Air
- Silicon Bronze: Harder Than Brass - Used In Direct Burial
- Invincibox™ Up to 1/2"
- Tuff Pack

Hex machine screw nuts are for screws smaller than 1/4" diameter. Finished hex nuts are heavier (thicker) and are furnished in sizes 1/4" and up.

ZINC PLATED STEEL - PC 4100

| CAT. NO. | UPC | | SIZE | STD | SLV | MSTR | WT/STD |
|----------|-------|--------------------------|---------|-----|-----|-------|--------|
| HN632 | 17010 | Machine Screw Nuts | 6-32 | 100 | 500 | 4000 | 0.21# |
| HN832 | 17015 | | 8-32 | 100 | 500 | 4000 | 0.28# |
| HN1024 | 17020 | | 10-24 | 100 | 500 | 4000 | 0.33# |
| HN1032 | 17025 | | 10-32 | 100 | 500 | 4000 | 0.33# |
| HN1224 | 17030 | | 12-24 | 100 | 500 | 4000 | 0.56# |
| HN14 | 17035 | Finished Hex Nuts | 1/4-20 | 100 | 500 | 4000 | 0.68# |
| HN516 | 17040 | | 5/16-18 | 50 | 250 | 2000 | 0.51# |
| HN38 | 17045 | | 3/8-16 | 50 | 250 | 2000 | 0.74# |
| HN12 | 17050 | | 1/2-13 | 25 | 125 | 1000 | 0.90# |
| HN58 | 17055 | | 5/8-11 | 25 | 125 | 750 | 1.77# |
| HN34 | 17060 | 3/4-10 | 25 | 250 | 250 | 2.95# | |
| HNT14 | 17051 | Tuff Pack | 1/4-20 | 500 | | 3000 | 3.70# |
| HNT38 | 17052 | | 3/8-16 | 250 | | 1500 | 3.86# |
| HNT12 | 17053 | | 1/2-13 | 150 | | 900 | 4.62# |

STAINLESS STEEL - PC 4010

| | | | | | | | |
|---------|-------|--------------------------|---------|-----|-----|------|-------|
| HNS632 | 69776 | Machine Screw Nuts | 6-32 | 100 | 500 | 4000 | 0.22# |
| HNS832 | 69878 | | 8-32 | 100 | 500 | 4000 | 0.30# |
| HNS1024 | 69780 | | 10-24 | 100 | 500 | 4000 | 0.33# |
| HNS1032 | 69872 | | 10-32 | 100 | 500 | 4000 | 0.32# |
| HNS1224 | 69784 | | 12-24 | 100 | 500 | 4000 | 0.58# |
| HNS14 | 69786 | Finished Hex Nuts | 1/4-20 | 100 | 500 | 4000 | 0.72# |
| HNS516 | 69788 | | 5/16-18 | 50 | 250 | 2000 | 0.55# |
| HNS38 | 69790 | | 3/8-16 | 50 | 250 | 2000 | 0.79# |
| HNS12 | 69792 | | 1/2-13 | 25 | 125 | 1000 | 1.22# |
| HNS58 | 69794 | | 5/8-11 | 25 | 125 | 750 | 1.84# |
| HNS34 | 69796 | | 3/4-10 | 25 | 250 | 250 | 2.95# |

SOLID BRASS - PC 4300

| | | | | | | | |
|----------|-------|--------------------------|---------|-----|-----|------|-------|
| HNBR632 | 17110 | Machine Screw Nuts | 6-32 | 100 | 500 | 4000 | 0.21# |
| HNBR832 | 17115 | | 8-32 | 100 | 500 | 4000 | 0.28# |
| HNBR1024 | 17120 | | 10-24 | 100 | 500 | 4000 | 0.33# |
| HNBR1032 | 17125 | | 10-32 | 100 | 500 | 4000 | 0.33# |
| HNBR1224 | 17150 | | 12-24 | 100 | 500 | 4000 | 0.56# |
| HNBR14 | 17135 | Finished Hex Nuts | 1/4-20 | 100 | 500 | 4000 | 0.68# |
| HNBR516 | 17105 | | 5/16-18 | 50 | 250 | 2000 | 0.51# |
| HNBR38 | 17140 | | 3/8-16 | 50 | 250 | 2000 | 0.74# |
| HNBR12 | 17145 | | 1/2-13 | 25 | 125 | 1000 | 0.90# |

SILICON BRONZE - PC 4015

| | | | | | | | |
|----------|-------|--------------------------|---------|-----|-----|------|-------|
| HNBZ632 | 17160 | Machine Screw Nuts | 6-32 | 100 | 500 | 4000 | 0.21# |
| HNBZ832 | 17161 | | 8-32 | 100 | 500 | 4000 | 0.28# |
| HNBZ1024 | 17162 | | 10-24 | 100 | 500 | 4000 | 0.33# |
| HNBZ1032 | 17163 | | 10-32 | 100 | 500 | 4000 | 0.33# |
| HNBZ14 | 17164 | Finished Hex Nuts | 1/4-20 | 100 | 500 | 4000 | 0.68# |
| HNBZ516 | 17165 | | 5/16-18 | 50 | 250 | 2000 | 1.02# |
| HNBZ38 | 17166 | | 3/8-16 | 50 | 250 | 2000 | 0.75# |
| HNBZ12 | 17167 | | 1/2-13 | 25 | 125 | 1000 | 1.02# |

GRADE 5 - ZINC PLATED - PC 4018

| | | | | | | | |
|-------|-------|-------------------------|--------|-----|-----|------|-------|
| 5HN14 | 13000 | Finished Hex Nuts | 1/4-20 | 100 | 500 | 4000 | 0.68# |
| 5HN38 | 13001 | | 3/8-16 | 50 | 250 | 2000 | 0.75# |
| 5HN12 | 13002 | | 1/2-13 | 25 | 125 | 1000 | 0.90# |
| 5HN58 | 13003 | | 5/8-11 | 25 | 125 | 750 | 1.85# |
| 5HN34 | 13004 | | 3/4-10 | 25 | 250 | 250 | 2.97# |

PACKAGING:



STD

SLV



MSTR

TUFF
PACK

LOCK WASHERS

Lock washers provide tight locking of screws and bolts. Zinc Plated Steel - general use; Stainless Steel - corrosion and chemical resistant; Silicon Bronze - high resistance to extreme temperatures.

ZINC PLATED STEEL - PC 4110

| CAT. NO. | UPC | SIZE | STD | SLV | MSTR | WT/STD |
|----------|-------|-------------|-----|-----|------|--------|
| LW6 | 31010 | #6 | 100 | 500 | 4000 | 0.03# |
| LW8 | 31015 | #8 | 100 | 500 | 4000 | 0.05# |
| LW10 | 31025 | #10 (3/16") | 100 | 500 | 4000 | 0.07# |
| LW14 | 31030 | 1/4" | 100 | 500 | 4000 | 0.22# |
| LW516 | 31035 | 5/16" | 100 | 500 | 4000 | 0.42# |
| LW38 | 31040 | 3/8" | 100 | 500 | 4000 | 0.60# |
| LW12 | 31045 | 1/2" | 100 | 500 | 3000 | 1.30# |
| LW58 | 31050 | 5/8" | 100 | | 1000 | 2.43# |
| LW34 | 31055 | 3/4" | 100 | | 1000 | 4.00# |

STAINLESS STEEL - PC 4010

| LWS | UPC | SIZE | STD | SLV | MSTR | WT/STD |
|--------|-------|-------------|-----|-----|------|--------|
| LWS6 | 69966 | #6 | 100 | 500 | 4000 | 0.03# |
| LWS8 | 69968 | #8 | 100 | 500 | 4000 | 0.05# |
| LWS10 | 69970 | #10 (3/16") | 100 | 500 | 4000 | 0.10# |
| LWS14 | 69972 | 1/4" | 100 | 500 | 4000 | 0.27# |
| LWS516 | 69974 | 5/16" | 100 | 500 | 4000 | 0.42# |
| LWS38 | 69976 | 3/8" | 100 | 500 | 4000 | 0.64# |
| LWS12 | 69978 | 1/2" | 100 | 500 | 3000 | 1.98# |
| LWS58 | 69980 | 5/8" | 100 | | 1000 | 2.22# |
| LWS34 | 69982 | 3/4" | 100 | | 1000 | 4.23# |

SILICON BRONZE - PC 4015

| LWBZ | UPC | SIZE | STD | SLV | MSTR | WT/STD |
|---------|-------|-------------|-----|-----|------|--------|
| LWBZ6 | 31160 | #6 | 100 | 500 | 4000 | 0.09# |
| LWBZ8 | 31161 | #8 | 100 | 500 | 4000 | 0.10# |
| LWBZ10 | 31162 | #10 (3/16") | 100 | 500 | 4000 | 0.11# |
| LWBZ14 | 31163 | 1/4" | 100 | 500 | 4000 | 0.40# |
| LWBZ516 | 31164 | 5/16" | 100 | 500 | 4000 | 0.44# |
| LWBZ38 | 31165 | 3/8" | 100 | 500 | 4000 | 0.66# |
| LWBZ12 | 31166 | 1/2" | 100 | 500 | 3000 | 1.44# |
| LWBZ58 | 31167 | 5/8" | 100 | | 1000 | 2.50# |
| LWBZ34 | 31168 | 3/4" | 100 | | 1000 | 3.80# |



STAINLESS
STEEL

FEATURES:

- Zinc Plated Steel
- Stainless Steel
- Silicon Bronze
- Invincibox™ Up To 1/2"

PACKAGING:



STD

SLV

MSTR

TECH TALK

ZINC CHROMATE Plating is the most widely used plating. Zinc is popular as a fastener coating because it is the least expensive and can be applied to a broad range of thicknesses. It has good to excellent corrosion resistance and is relatively non toxic.

STAINLESS STEEL Is a family of ferrous alloys, each with a minimum chromium content of 12 percent. Chromium is a non-corrodible element; consequently, all stainless steels have a high degree of corrosion resistance. Generally, the higher the chromium content, the better the corrosion resistance.

BRASS Composed nominally of Copper & Zinc, is the most common Copper-base alloy. Its uses are myriad since it is relatively inexpensive. It is easily worked into any shape or form, and possesses strength, toughness and good corrosion resistance. Cold drawn brass has an even greater tensile strength than mild carbon steel.

SILICON BRONZE Has a high percentage of copper and small amounts of silicon, manganese or aluminum added for strength. Silicon Bronze possesses a high tensile strength superior to mild steel. It has a high resistance to corrosive influences such as extreme temperatures, atmospheric conditions, natural and sea water, gases and sewage. It is nonmagnetic and has excellent machining and working characteristics.

NYLON Precision molded or machined of Nylon 6/6 a highly crystalline, lightweight, high melting, thermoplastic resin. It has outstanding toughness; good thermal properties; abrasion, friction and chemical resistance.



FLAT WASHERS

FLAT WASHERS

PC 4110, 4010, 4300, 4015



STAINLESS
STEEL

FEATURES:

- Zinc Plated Steel
- Stainless Steel
- Solid Brass
- Silicon Bronze
- Hard Alloy
- Invincibox™ Up To 5/8"
- Tuff Pack

PACKAGING:



STD

SLV



MSTR



TUFF
PACK

Flat Washers Steel - general use; Stainless steel - corrosion and chemical resistant; Solid brass - good in water and salt air; Silicon bronze - harder than brass, marine use and high resistance to extreme temperatures; Hard alloy - used with grade 5 and 8 bolts.

ZINC PLATED STEEL - PC 4110

| CAT. NO. | UPC | BOLT SIZE | INSIDE/OUTSIDE DIAMETER | THICKNESS | STD | SLV | MSTR | WT/STD |
|----------|-------|------------|-------------------------|-----------|-----|-----|------|--------|
| FW6 | 31060 | #6 | 5/32" x 3/8" | 3/64" | 100 | 500 | 4000 | 0.12# |
| FW8 | 31065 | #8 | 3/16" x 7/16" | 3/64" | 100 | 500 | 4000 | 0.17# |
| FW10 | 31075 | #10 (3/16) | 7/32" x 1/2" | 3/64" | 100 | 500 | 4000 | 0.23# |
| FW14 | 31080 | 1/4" | 5/16" x 3/4" | 1/16" | 100 | 500 | 4000 | 0.67# |
| FW516 | 31085 | 5/16" | 3/8" x 7/8" | 1/16" | 100 | 500 | 3000 | 0.86# |
| FW38 | 31090 | 3/8" | 7/16" x 1" | 1/16" | 100 | 500 | 2000 | 1.49# |
| FW12 | 31095 | 1/2" | 9/16" x 1-3/8" | 3/32" | 50 | 250 | 1000 | 1.93# |
| FW58 | 31100 | 5/8" | 11/16" x 1-3/4" | 3/32" | 25 | 125 | 750 | 1.93# |
| FW34 | 31105 | 3/4" | 13/16" x 2" | 9/64" | 25 | | 250 | 2.75# |
| FWT14 | 31096 | 1/4" | 5/16" x 3/4" | 1/16" | 500 | | 3000 | 7.53# |
| FWT38 | 31097 | 3/8" | 7/16" x 1" | 1/16" | 250 | | 1500 | 4.23# |
| FWT12 | 31098 | 1/2" | 9/16" x 1-3/8" | 3/32" | 150 | | 900 | 5.15# |

STAINLESS STEEL - PC 4010

| | | | | | | | | |
|-------|-------|------------|-----------------|-------|-----|-----|------|-------|
| FWS6 | 69880 | #6 | 5/32" x 3/8" | 3/64" | 100 | 500 | 4000 | 0.10# |
| FWS8 | 69882 | #8 | 3/16" x 7/16" | 3/64" | 100 | 500 | 4000 | 0.12# |
| FWS10 | 69884 | #10 (3/16) | 7/32" x 1/2" | 3/64" | 100 | 500 | 4000 | 0.17# |
| FWS14 | 69886 | 1/4" | 5/16" x 5/8" | 1/16" | 100 | 500 | 4000 | 0.32# |
| FW516 | 69888 | 5/16" | 3/8" x 3/4" | 1/16" | 100 | 500 | 3000 | 0.43# |
| FW38 | 69890 | 3/8" | 7/16" x 7/8" | 1/16" | 100 | 500 | 2000 | 0.62# |
| FW12 | 69892 | 1/2" | 9/16" x 1-1/4" | 3/32" | 50 | 250 | 1000 | 0.82# |
| FW58 | 69894 | 5/8" | 11/16" x 1-1/2" | 3/32" | 25 | 125 | 750 | 0.77# |
| FW34 | 69896 | 3/4" | 13/16" x 1-7/8" | 9/64" | 25 | | 250 | 1.62# |

SOLID BRASS - PC 4300

| | | | | | | | | |
|---------|-------|------------|-----------------|-------|-----|-----|------|-------|
| FWBR6 | 31110 | #6 | 5/32" x 5/16" | 1/32" | 100 | 500 | 4000 | 0.10# |
| FWBR8 | 31115 | #8 | 3/16" x 3/8" | 1/32" | 100 | 500 | 4000 | 0.12# |
| FWBR10 | 31120 | #10 (3/16) | 7/32" x 7/16" | 1/32" | 100 | 500 | 4000 | 0.15# |
| FWBR14 | 31125 | 1/4" | 5/16" x 9/16" | 3/64" | 100 | 500 | 4000 | 0.58# |
| FWBR516 | 31130 | 5/16" | 3/8" x 3/4" | 1/16" | 100 | 500 | 3000 | 0.91# |
| FWBR38 | 31135 | 3/8" | 7/16" x 7/8" | 1/16" | 100 | 500 | 2000 | 1.52# |
| FWBR12 | 31140 | 1/2" | 9/16" x 1-1/4" | 3/32" | 50 | 250 | 1000 | 1.79# |
| FWBR58 | 31145 | 5/8" | 11/16" x 1-1/2" | 7/64" | 25 | 125 | 750 | 1.88# |
| FWBR34 | 31127 | 3/4" | 13/16" x 1-7/8" | 7/64" | 25 | | 250 | 1.92# |

SILICON BRONZE - PC 4015

| | | | | | | | | |
|---------|-------|------------|-----------------|-------|-----|-----|------|-------|
| FWBZ6 | 30979 | #6 | 5/32" x 5/16" | 1/32" | 100 | 500 | 4000 | 0.10# |
| FWBZ8 | 30980 | #8 | 3/16" x 3/8" | 1/32" | 100 | 500 | 4000 | 0.12# |
| FWBZ10 | 30981 | #10 (3/16) | 7/32" x 7/16" | 1/32" | 100 | 500 | 4000 | 0.14# |
| FWBZ14 | 30982 | 1/4" | 5/16" x 9/16" | 3/64" | 100 | 500 | 4000 | 0.42# |
| FWBZ516 | 30983 | 5/16" | 3/8" x 3/4" | 1/16" | 100 | 500 | 3000 | 0.72# |
| FWBZ38 | 30984 | 3/8" | 7/16" x 7/8" | 1/16" | 100 | 500 | 2000 | 0.99# |
| FWBZ12 | 30985 | 1/2" | 9/16" x 1-1/4" | 3/32" | 50 | 250 | 1000 | 1.18# |
| FWBZ58 | 30986 | 5/8" | 11/16" x 1-1/2" | 7/64" | 25 | 125 | 750 | 1.49# |
| FWBZ34 | 30987 | 3/4" | 13/16" x 7/8" | 7/64" | 25 | | 250 | 2.75# |

HARD ALLOY - ZINC PLATED (FOR GRADE 5 & 8) - PC 4015

| | | | | | | | | |
|---------|-------|-------|-----------------|-------|-----|-----|------|-------|
| FWHA14 | 30989 | 1/4" | 5/16" x 3/4" | 1/16" | 100 | 500 | 4000 | 0.67# |
| FWHA516 | 30990 | 5/16" | 3/8" x 7/8" | 1/16" | 100 | 500 | 4000 | 0.86# |
| FWHA38 | 30991 | 3/8" | 7/16" x 1" | 1/16" | 100 | 500 | 2000 | 1.49# |
| FWHA12 | 30992 | 1/2" | 9/16" x 1-3/8" | 3/32" | 50 | 250 | 1000 | 1.93# |
| FWHA58 | 30993 | 5/8" | 11/16" x 1-3/4" | 3/32" | 25 | | 250 | 1.93# |
| FWHA34 | 30994 | 3/4" | 13/16" x 2" | 9/64" | 25 | | 250 | 2.75# |

FENDER WASHERS

PC 4110

Fender Washers are for general purpose applications. Provides a large load bearing surface.

| CAT. NO. | UPC | SIZE | STD | SLV | MSTR | WT/STD |
|------------|-------|---------------|-----|-----|------|--------|
| FENW316114 | 15505 | 3/16 x 1-1/4" | 100 | 500 | 3000 | 1.65# |
| FENW141 | 15510 | 1/4 x 1" | 100 | 500 | 3000 | 1.00# |
| FENW14114 | 15515 | 1/4 x 1-1/4" | 100 | 500 | 3000 | 1.62# |
| FENW14112 | 15520 | 1/4 x 1-1/2" | 100 | 500 | 3000 | 2.37# |
| FENW142 | 15521 | 1/4 x 2" | 100 | | 3000 | 5.65# |
| FENW516114 | 15525 | 5/16 x 1-1/4" | 100 | 500 | 3000 | 2.05# |
| FENW38114 | 15527 | 3/8 x 1-1/4" | 100 | 500 | 3000 | 2.20# |
| FENW38112 | 15530 | 3/8 x 1-1/2" | 100 | | 1000 | 3.08# |
| FENW382 | 15531 | 3/8 x 2" | 100 | | 1000 | 5.50# |
| FENW12112 | 15535 | 1/2 x 1-1/2" | 100 | | 1000 | 2.75# |
| FENW122 | 15540 | 1/2 x 2" | 100 | | 1000 | 5.25# |
| FENWT14114 | 15536 | 1/4 x 1-1/4" | 250 | | 1500 | 5.23# |
| FENWT38114 | 15537 | 3/8 x 1-1/4" | 250 | | 1500 | 4.58# |
| FENWT12112 | 15538 | 1/2 x 1-1/2" | 150 | | 900 | 4.01# |



FEATURES:

- Fender Washers
- Zinc Plated Steel

FENDER WASHERS - STAINLESS

PC 4010

Fender Washers are for general purpose applications. Provides a large load bearing surface. Stainless steel resists corrosion.

| CAT. NO. | UPC | SIZE | STD | SLV | MSTR | WT/STD |
|-------------|-------|---------------|-----|-----|------|--------|
| FENWS3161 | 69906 | 3/16 x 1" | 100 | 500 | 3000 | 1.19# |
| FENWS141 | 69908 | 1/4 x 1" | 100 | 500 | 3000 | 1.25# |
| FENWS14114 | 69910 | 1/4 x 1-1/4" | 100 | 500 | 3000 | 2.09# |
| FENWS14112 | 69912 | 1/4 x 1-1/2" | 100 | | 1000 | 2.85# |
| FENWS516112 | 69914 | 5/16 x 1-1/2" | 100 | | 1000 | 2.30# |
| FENWS38112 | 69916 | 3/8 x 1-1/2" | 100 | | 1000 | 3.26# |
| FENWS122 | 69918 | 1/2 x 2" | 100 | | 1000 | 5.12# |



FEATURES:

- Fender Washers
- Stainless Steel

"S" HOOKS

PC 4870

"S" Hooks are manufactured from low carbon cold drawn steel wire supplied with blunt ends and zinc plated. Hooks are used to hang fixtures suspended from chain.

| CAT. NO. | UPC | OVERALL DIAMETER | | OPENING (E) | WIRE GAUGE | | MSTR | WT/STD |
|----------|-------|------------------|---------|-------------|------------|-----|------|--------|
| | | LENGTH (L) | EYE (C) | | STD | (D) | | |
| S1 | 30805 | 1" | 1/4" | 3/16" | 11 Ga. | 100 | 3000 | 0.74# |
| S2 | 30810 | 1-1/2" | 7/16" | 1/4" | 7 Ga. | 100 | 1000 | 2.47# |
| S3 | 30815 | 2" | 9/16" | 3/8" | 1/4" | 50 | 500 | 3.01# |
| S4 | 30820 | 2-1/2" | 3/4" | 7/16" | 5/16" | 50 | 200 | 6.04# |
| S5 | 30825 | 3" | 7/8" | 1/2" | 5/16" | 50 | 200 | 7.11# |

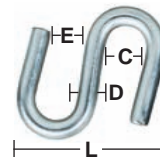

FEATURES:

- "S" Hook
- Zinc Plated Steel

EYE BOLTS

PC 4870

Eye Bolts are manufactured from low carbon cold drawn steel wire and are supplied with NC rolled machine threads and one hex nut.

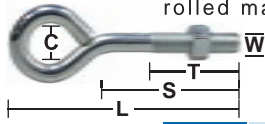

FEATURES:

- Eye Bolts
- Zinc Plated Steel
- Includes Hex Nuts

| CAT. NO. | UPC | SIZE | OVERALL LENGTH (L) | THREAD LENGTH (T) | SHANK LENGTH (S) | THREAD SIZE (W) | INSIDE EYE DIA (C) | STD | MSTR | WT/STD |
|----------|-------|--------------|--------------------|-------------------|------------------|-----------------|--------------------|-----|------|--------|
| EB2 | 28230 | 3/16 x 2" | 2" | 1-1/4" | 1-3/8" | 3/16" | 5/16" | 50 | 500 | 0.96# |
| EB3 | 28235 | 3/16 x 3" | 3-11/16" | 1-1/2" | 3" | 3/16" | 3/8" | 50 | 500 | 1.39# |
| EB4 | 28240 | 1/4 x 2" | 2" | 7/8" | 1" | 1/4" | 1/2" | 50 | 500 | 2.02# |
| EB5 | 28245 | 1/4 x 3" | 3" | 1-1/4" | 2" | 1/4" | 1/2" | 50 | 500 | 2.66# |
| EB6 | 28250 | 1/4 x 4" | 4" | 1-1/2" | 3" | 1/4" | 1/2" | 50 | 500 | 3.25# |
| EB7 | 28255 | 1/4 x 5" | 5" | 2-1/2" | 4" | 1/4" | 1/2" | 50 | 500 | 3.66# |
| EB8 | 28260 | 1/4 x 6" | 6" | 3" | 5" | 1/4" | 1/2" | 50 | 500 | 4.25# |
| EB9 | 28265 | 3/8 x 2-1/2" | 2-1/2" | 7/8" | 1" | 3/8" | 3/4" | 50 | 200 | 6.87# |
| EB10 | 28270 | 3/8 x 4" | 4" | 1-1/2" | 2-1/2" | 3/8" | 3/4" | 50 | 200 | 7.67# |
| EB11 | 28275 | 3/8 x 5" | 5" | 2" | 3-1/2" | 3/8" | 3/4" | 50 | 200 | 9.84# |
| EB12 | 28280 | 3/8 x 6" | 6-1/2" | 3" | 5" | 3/8" | 3/4" | 50 | 200 | 11.30# |

SCREW HOOKS

PC 4870

Screw Hooks can be used for hanging chain when installing light fixtures. Sharp point bites into wood quickly and easily.

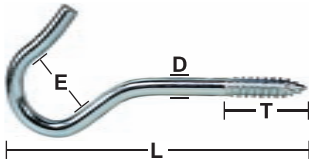

FEATURES:

- Screw Hooks
- Round Bend Type
- Zinc Plated Steel

| CAT. NO. | UPC | OVERALL LENGTH (L) | THREAD LENGTH (T) | HOOK OPENING (E) | WIRE DIA (D) | STD | MSTR | WT/STD |
|----------|-------|--------------------|-------------------|------------------|--------------|-----|------|--------|
| SH20 | 30905 | 4-15/16" | 1-3/4" | 1" | .307 | 50 | 200 | 3.68# |
| SH40 | 30910 | 3-7/8" | 1-1/2" | 13/16" | .275 | 50 | 500 | 1.51# |
| SH60 | 30915 | 3-3/8" | 7/8" | 3/4" | .192 | 100 | 1000 | 3.65# |
| SH80 | 30920 | 2-9/16" | 7/8" | 9/16" | .160 | 100 | 1000 | 2.05# |
| SH100 | 30925 | 2-1/16" | 11/16" | 3/8" | .135 | 100 | 1000 | 1.22# |
| SH120 | 30930 | 1-5/16" | 1/2" | 1/4" | .080 | 100 | 1000 | 1.05# |

SCREW EYES

PC 4870

Screw Eyes are manufactured from low carbon cold drawn steel wire. The lag screw threads are rolled to fit standard anchors and shields. Sharp point bites into wood quickly and easily.

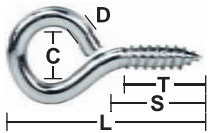

FEATURES:

- Screw Eyes
- Zinc Plated Steel
- Gimlet Point for use in wood

| CAT. NO. | UPC | OVERALL LENGTH (L) | SHANK LENGTH (S) | THREAD LENGTH (T) | INSIDE EYE DIA (C) | WIRE DIA (D) | STD | MSTR | WT/STD |
|----------|-------|--------------------|------------------|-------------------|--------------------|--------------|-----|------|--------|
| SE1 | 30855 | 2-5/8" | 1-1/4" | 1-1/8" | 3/4" | .264 | 50 | 500 | 3.99# |
| SE2 | 30860 | 2-3/16" | 1-1/8" | 1" | 5/8" | .225 | 50 | 500 | 2.47# |
| SE3 | 30865 | 1-13/16" | 15/16" | 3/4" | 7/16" | .192 | 100 | 1000 | 2.59# |
| SE4 | 30870 | 1-5/8" | 3/4" | 5/8" | 1/2" | .160 | 100 | 1000 | 1.54# |
| SE5 | 30875 | 1-3/8" | 11/16" | 5/8" | 7/16" | .135 | 100 | 1000 | 0.90# |
| SE6 | 30880 | 1-3/16" | 9/16" | 1/2" | 3/8" | .105 | 100 | 1000 | 0.46# |

STEEL AND WIRE GAUGE

| | | | | | | | | | | | | | | | | | | | | | | | | | | | | | | |
|-----|------|------|------|------|------|------|------|------|------|------|------|------|------|------|------|------|------|------|------|------|------|------|------|------|------|------|------|------|------|------|
| (A) | 000 | 00 | 0 | 1 | 2 | 3 | 4 | 5 | 6 | 7 | 8 | 9 | 10 | 11 | 12 | 13 | 14 | 15 | 16 | 17 | 18 | 19 | 20 | | | | | | | |
| (B) | | | 9/32 | 1/4 | | 7/32 | | 3/16 | | 5/32 | | 1/8 | | 3/32 | | | | | | 1/16 | | | | | | | | | | |
| (C) | .363 | .328 | .307 | .283 | .281 | .262 | .250 | .244 | .225 | .219 | .207 | .192 | .187 | .177 | .162 | .156 | .148 | .135 | .125 | .120 | .105 | .094 | .091 | .080 | .072 | .062 | .054 | .047 | .041 | .034 |

(A) Steel Wire Gauge No.

(B) Common Fractions

(C) Decimal

FASTENERS & HARDWARE

FLAT HANGAR SCREWS

PC 4920

| CAT. NO. | UPC | DESCRIPTION | STD | MSTR | WT/STD |
|----------|-------|-------------------|-----|------|--------|
| 631 | 18135 | 1/4 x 3" | 100 | 1000 | 2.38# |
| 631TK | 18136 | 1/4 x 2" | 100 | 1000 | 2.38# |
| HBT | 28950 | Installation Tool | 1 | 6 | 0.11# |

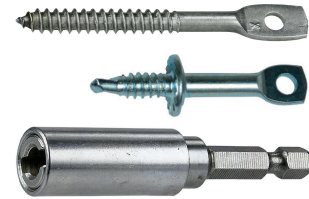

FEATURES:

- Flat Hangar Screws
- Tool Not Included
- TK - With Drill Pt.
- Flat Hangar Tool w/ Safety Sleeve
- Heavy Duty Steel Construction
- Installs Hanger Screws Quickly

HANGER BOLTS

PC 4940

| CAT. NO. | UPC | DESCRIPTION | STD | MSTR | WT/STD |
|----------|-------|---------------------------------|-----|------|--------|
| HB14 | 18100 | 1/4 x 3" | 100 | 1000 | 2.78# |
| HB38 | 18105 | 3/8 x 3" | 100 | 1000 | 6.82# |
| EZ14 | 28953 | Installation Tool 1/4" For HB14 | 1 | 6 | 0.11# |
| EZ38 | 28956 | Installation Tool 3/8" For HB38 | 1 | 6 | 1.17# |



FEATURES:

- Hanger Bolts
- Lag/Machine Screw Threads
- Tool Not Included
- EZ Hanger Bolt Tool
- Heavy Duty Steel Construction
- Threads On For Quick Installation
- Improved: With Ball Bearing Release To Reduce Hanger Bolt Lockup

DRIVE SCREWS

PC 4960

Multi-purpose concrete drive-in fastener.

| CAT. NO. | UPC | DESCRIPTION | STD | MSTR | WT/STD |
|----------|-------|-------------|-----|------|--------|
| 216 | 18120 | 2" x 16 | 100 | 1000 | 2.66# |



FEATURES:

- Steel
- Hammer Drive

U BOLT

PC 4870

U Bolts are generally used to support conduit from strut. Provided with hex nuts and plate. Pipe sizes are inside diameters.

| CAT. NO. | UPC | FOR PIPE | THREAD DIAMET (A) | INSIDE DIAMET (C) | INSIDE LENGTH (B) | THREAD LENGTH (T) | STD | MSTR | WT/STD |
|----------|-------|----------|-------------------|-------------------|-------------------|-------------------|-----|------|--------|
| U50 | 17910 | 1/2" | 1/4" | 1" | 1-3/4" | 1" | 25 | | 2.22# |
| U75 | 17915 | 3/4" | 1/4" | 1-1/8" | 2" | 1" | 25 | | 2.42# |
| U100 | 17920 | 1" | 1/4" | 1-1/2" | 2-3/4" | 1-3/8" | 25 | | 2.91# |
| U125 | 17925 | 1-1/4" | 5/16" | 1-3/4" | 2-11/16" | 1-1/8" | 25 | | 4.59# |
| U150 | 17930 | 1 1/2" | 5/16" | 2" | 2-11/16" | 1-1/8" | 25 | | 4.84# |
| U200 | 17935 | 2" | 5/16" | 2-1/2" | 3-3/16" | 1-1/8" | 25 | | 5.54# |
| U250 | 17940 | 2-1/2" | 3/8" | 3" | 3-5/8" | 1-1/4" | 10 | | 3.71# |
| U300 | 17945 | 3" | 3/8" | 3-1/2" | 4-1/2" | 1-5/8" | 10 | | 4.17# |
| U350 | 17950 | 3-1/2" | 1/2" | 4" | 5-1/2" | 1-1/2" | 10 | | 9.61# |
| U400 | 17955 | 4" | 1/2" | 4-1/2" | 6-1/2" | 2-1/4" | 10 | | 10.16# |

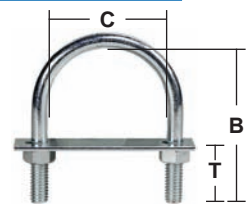

FEATURES:

- U Bolts
- Low Carbon Steel
- NC Rolled Threads
- Zinc Plated
- Sizes Thru 4" Include Hex Nuts & Plate

JACK CHAIN

PC 5000



Jack chain is used for suspending fixtures.



FEATURES:

- Jack Chain
- Used For Suspending Fixtures
- Zinc & Stainless Steel

| CAT. NO. | UPC | GAUGE | DIA | WORK LOAD | BREAK LOAD | SIZE | STD | MSTR | WT/STD |
|--------------|-------|-------|------|-----------|------------|------|------|-------|--------|
| CH1010 | 27475 | #10 | .135 | 43 lbs | 170 lbs | #10 | 100' | 500' | 14.95# |
| CH10P (Pail) | 27405 | #10 | .135 | 43 lbs | 170 lbs | #10 | 300' | 300' | 43.90# |
| CH1212 | 27485 | #12 | .105 | 29 lbs | 115 lbs | #12 | 100' | 1000' | 8.78# |
| CH12P (Pail) | 27415 | #12 | .105 | 29 lbs | 115 lbs | #12 | 300' | 300' | 27.00# |
| CH12R | 83246 | #12 | .105 | 29 lbs | 115 lbs | #12 | 100' | 1000' | 8.90# |
| CH1414 | 27495 | #14 | .080 | 16 lbs | 65 lbs | #14 | 100' | 1000' | 5.18# |
| CH1616 | 27490 | #16 | .080 | 10 lbs | 40 lbs | #16 | 100' | 1000' | 3.00# |

STAINLESS STEEL - PC 4010

| | | | | | | | | | |
|---------|-------|-----|------|--------|---------|-----|------|------|--------|
| CHS1010 | 84223 | #10 | .135 | 43 lbs | 170 lbs | #10 | 100' | 500' | 18.36# |
| CHS1212 | 83246 | #12 | .105 | 29 lbs | 115 lbs | #12 | 100' | 500' | 8.90# |



DOUBLE LOOP JACK CHAIN

PC 5010



Double loop is a locked link chain with higher load ratings than jack chain. Because the links cannot be opened it requires the use of the S hook.

FEATURES:

- Double Loop Jack Chain
- Locked Link
- Steel

| CAT. NO. | UPC | GAUGE | DIA | WORK LOAD | BREAK LOAD | SIZE | STD | MSTR | WT/STD |
|----------|-------|-------|------|-----------|------------|------|------|------|--------|
| DL2/0 | 28055 | #10 | .135 | 255 lbs | 1020 lbs | #2/0 | 100' | 500' | 17.43# |
| DL1/0 | 28050 | #11 | .120 | 200 lbs | 800 lbs | #1/0 | 100' | 500' | 13.32# |
| DL1 | 28060 | #12 | .105 | 155 lbs | 620 lbs | #1 | 100' | 500' | 10.22# |
| DL2 | 28065 | #13 | .091 | 115 lbs | 460 lbs | #2 | 100' | 500' | 8.25# |
| DL3 | 28070 | #14 | .080 | 90 lbs | 360 lbs | #3 | 100' | 500' | 6.40# |

FIXTURE HANGERS

PC 4970



629 (side)

630 (top)

Fixture Hangers are manufactured from 10 gauge Galvanized Steel and are typically used with S hooks and jack chain.

| CAT. NO. | UPC | DESCRIPTION | STD | MSTR | WT/STD |
|----------|-------|------------------|-----|------|--------|
| 629 | 18125 | Side-Mount 10 GA | 100 | 500 | 6.18# |
| 630 | 18130 | Top-Mount 10 GA | 100 | 500 | 6.18# |

FEATURES:

- Top-Mount or Side Mount
- Fixture Hangers
- Galvanized Steel
- For Use With 2, 3 or 4 Light Fixtures

TECH TALK

WORKING LOAD LIMIT designates the maximum stress in pounds which should ever be applied to chain. This refers also to chain in the best condition, when new and when the load is applied uniformly to a straight, untwisted length of chain.

BREAK TEST LOAD is the maximum load in pounds at which new chain has been found by experience to break, under tests in which the load is applied in direct tension to a straight length of chain with a uniform rate of speed on a standard chain testing machine.

STANDARD FINISH: BRIGHT GALV Our chain is made from quality, silver bright, galvanized steel wire. Tests have shown chain made from galvanized wire to be superior in rust resistance to chain which is zinc plated after forming.

ANCHORS & KITS

SECTION **B**



ANCHORS & KITS



ANCHORS & KITS

SECTION B



TAPERED WITH WINGS

Plastic anchors: Tapered with Wings. Drill a hole into drywall, concrete, brick or block and insert anchor. The screw is then installed through the fixture into the anchor. Used for light duty work.

| CAT. NO. | UPC | SCREW SIZE | DRILL SIZE | LENGTH | COLOR | STD | SLV | MSTR | WT/STD |
|----------|-------|------------|------------|--------|--------|-----|-----|------|--------|
| 121 | 31430 | 4-6-8 | 3/16" | 1" | White | 100 | 500 | 4000 | 0.11# |
| 122 | 31432 | 8-10-12 | 1/4" | 1-1/4" | Yellow | 100 | 500 | 3000 | 0.20# |
| 123 | 31434 | 12-14-16 | 5/16" | 1-1/2" | Green | 50 | 250 | 1500 | 0.15# |

PC 4370



FEATURES:

- Tapered With Wings
- Plastic
- Packed in Invincibox™
- Wings Secure Anchor From Spinning

TAPERED WITH COLLAR

Plastic anchors: Tapered w/Collar. Drill a hole into drywall, concrete, brick or block and insert anchor. The screw is then installed through the fixture into the anchor. Used for light duty work.

| CAT. NO. | UPC | SCREW SIZE | DRILL SIZE | LENGTH | COLOR | STD | SLV | MSTR | WT/STD |
|----------|-------|------------|------------|--------|-------|-----|-----|------|--------|
| 20 | 15080 | 4-6-8 | 3/16" | 3/4" | Red | 100 | 500 | 4000 | 0.08# |
| 21 | 15085 | 6-8-10 | 3/16" | 7/8" | Red | 100 | 500 | 4000 | 0.08# |
| 22 | 15090 | 8-10-12 | 1/4" | 1" | Red | 100 | 500 | 3000 | 0.15# |
| 23 | 15095 | 12-14-16 | 5/16" | 1-1/2" | Red | 50 | 250 | 1500 | 0.14# |



FEATURES:

- Tapered With Collar
- Plastic
- Packed in Invincibox™

STRAIGHT

Plastic anchors: Straight. Drill a hole into drywall, concrete, brick or block and insert anchor. The screw is then installed through the fixture into the anchor. Used for light duty work.

| CAT. NO. | UPC | SCREW SIZE | DRILL SIZE | LENGTH | COLOR | STD | SLV | MSTR | WT/STD |
|----------|-------|------------|------------|--------|-------|-----|-----|------|--------|
| 221 | 16085 | 6-8 | 3/16" | 1" | White | 100 | 500 | 4000 | 0.15# |
| 222 | 16090 | 10-12 | 1/4" | 1" | Green | 100 | 500 | 3000 | 0.22# |
| 223 | 16095 | 12-14 | 5/16" | 1-1/2" | Blue | 50 | 250 | 1500 | 0.23# |



FEATURES:

- Straight
- Ribbed Body
- Plastic
- Packed in Invincibox™

NYLON BUTTON HEAD WITH PINS

Nylon button head anchors with pins. Fast and easy to install. Position the fixture, drill a hole into concrete, brick or block and insert anchor through the fixture into the hole. Hammer the nail to spread and secure anchor. Used for light duty work.

| CAT. NO. | UPC | SCREW SIZE | LENGTH | COLOR | STD | MSTR | WT/STD |
|----------|-------|------------|--------|-------|-----|------|--------|
| 1711 | 10070 | 3/16" | 1" | White | 100 | 1000 | 0.55# |
| 1714 | 10075 | 1/4" | 1" | White | 100 | 1000 | 0.57# |



FEATURES:

- Straight
- Ribbed Body
- Nylon
- Steel Pin

MULTI-GRIP

| CAT. NO. | UPC | SCREW SIZE | DRILL SIZE | LENGTH | COLOR | STD | SLV | MSTR | WT/STD |
|----------|-------|------------|------------|--------|-------|-----|-----|------|--------|
| 6 | 81643 | #6 | 1/4" | 1-1/4" | Beige | 100 | 500 | 3000 | 0.91# |
| 8 | 81644 | #8 | 1/4" | 1-1/4" | Gray | 100 | 500 | 3000 | 0.97# |
| 10 | 81645 | #10 | 5/16" | 1-1/2" | Blue | 50 | 250 | 1500 | 0.60# |
| 12 | 81646 | #12 | 3/8" | 1-1/2" | Green | 50 | 250 | 1500 | 1.23# |



FEATURES:

- Claw Grip For Strength
- Wings For Strength and Vibration Resistance
- Core Expands For additional Holding Power



ANCHORS & KITS

WALL BOARD ANCHORS

PC 4465



Wall Board Anchors: Used only in drywall, this anchor has better pullout and shear values than plastic anchors. Installed by inserting Phillips or Square drive bit into the anchor and driving it into the drywall until flush. Use the same bit to insert the proper sheet metal screw to mount the fixture. The anchor is easy to spot and will not break out the backing of the drywall. No drill bit needed.

FEATURES:

- Wall Board Anchors
- Anchors Only
- Boxed
- Zinc or Nylon
- Not Recommended for Ceiling Applications
- Caution! Always Wear Eye Protection

| CAT. NO. | UPC | USE SCREW | ANCHOR | DRYWALL | STD | MSTR | WT/STD |
|----------|-------|-----------|--------|------------------|-----|------|--------|
| WD6 | 29770 | #6 | Zinc | 3/8", 1/2" | 100 | 3000 | 0.83# |
| WD6N | 29771 | #6 | Nylon | 3/8", 1/2" | 100 | 3000 | 0.23# |
| WD8 | 29776 | #8 | Zinc | 3/8", 1/2", 5/8" | 100 | 1000 | 1.72# |
| WD8N | 29777 | #8 | Nylon | 3/8", 1/2", 5/8" | 100 | 1000 | 0.48# |

Screws & Bit not provided. Use 6 x 1 SMS with WD6, Use 8 x 1-1/4 SMS with WD8, Use #2 bit for both. See Page B14 for Wall Driller Kits.

ANCHOR SPECIFICATIONS

| CAT NO. | SCREW | MATERIAL | 3/8" DRYWALL | | 1/2" DRYWALL | | 5/8" DRYWALL | |
|---------|-------|----------|--------------|-------|--------------|-------|--------------|-------|
| | | | TENSILE | SHEAR | TENSILE | SHEAR | TENSILE | SHEAR |
| WD6N | #6 | Nylon | 55 | 110 | 60 | 120 | N/A | N/A |
| WD6 | #6 | Zinc | 55 | 110 | 60 | 120 | N/A | N/A |
| WD8N | #8 | Nylon | 60 | 120 | 68 | 132 | 90 | 200 |
| WD8 | #8 | Zinc | 60 | 120 | 68 | 132 | 90 | 200 |

All values are ultimate loads and should be used as a guide only. Actual results may vary. It is recommended to apply a minimum safety factor of 4 to 1 to these loads. #6 sheet metal screws were used in tests with #6 Wall Driller. #8 sheet metal screws were used in tests with #8 Wall Driller.

THE GO-TO WALLBOARD ANCHOR



See Page B14 for Wall Board Kit.

ZAMAC ANCHORS - REMOVABLE SCREWS

PC 4495

The Zamac Anchor with removable screw is a unique, one-step drive anchor featuring a Phillips head and a screw thread. Designed to provide a removable anchor with 40% higher tension load capacities when installed in concrete.



| CAT. NO. | UPC | ANCHOR SIZE | DRILL SIZE | STD | MSTR | WT/STD |
|----------|-------|--------------|------------|-----|------|--------|
| ZAS75 | 59360 | 1/4 x 3/4" | 1/4" | 100 | 500 | 1.50# |
| ZAS100 | 59361 | 1/4 x 1" | 1/4" | 100 | 500 | 1.75# |
| ZAS125 | 59362 | 1/4 x 1-1/4" | 1/4" | 100 | 500 | 2.25# |
| ZAS150 | 59363 | 1/4 x 1-1/2" | 1/4" | 100 | 500 | 2.50# |
| ZAS200 | 59364 | 1/4 x 2" | 1/4" | 100 | 500 | 3.00# |

FEATURES:

- Zamac Alloy with Carbon Steel Screw Drive
- Use for Concrete, Block, Brick, Stone
- Removable Screw
- Not Recommended for Ceiling Applications
- Caution! Always Wear Eye Protection

ZAMAC ANCHORS

PC 4490

Zamac anchors have better shear resistance than plastic pin anchors. Fast and easy to install. Position the fixture, drill a hole through the fixture or through an existing hole in fixture into concrete, brick or block and insert anchor through the fixture into the hole until flush. Hammer the nail to spread and secure anchor. Used for light duty work.



| CAT. NO. | UPC | ANCHOR SIZE | DRILL SIZE | STD | MSTR | WT/STD |
|----------|-------|--------------|------------|-----|------|--------|
| ZA78 | 59350 | 3/16 x 7/8" | 3/16" | 100 | 500 | 0.75# |
| ZA75 | 59348 | 1/4 x 3/4" | 1/4" | 100 | 500 | 1.50# |
| ZA100 | 59352 | 1/4 x 1" | 1/4" | 100 | 500 | 1.75# |
| ZA125 | 59354 | 1/4 x 1-1/4" | 1/4" | 100 | 500 | 2.25# |
| ZA150 | 59356 | 1/4 x 1-1/2" | 1/4" | 100 | 500 | 2.50# |
| ZA200 | 59358 | 1/4 x 2" | 1/4" | 100 | 500 | 3.00# |

FEATURES:

- Zamac Alloy with Carbon Steel Screw Drive
- Use for Concrete, Block, Brick, Stone
- Not Recommended for Ceiling Applications
- Caution! Always Wear Eye Protection

DRIVE PINS

PC 4480

Drive pins are installed with a stud driver. The pin is inserted into the driver which is placed onto the item to be fastened. Using a sledge or drilling hammer, drive the pin home. Will drive through metal into concrete.

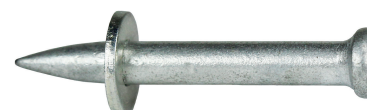

| CAT. NO. | UPC | LENGTH | STD | MSTR | WT/STD |
|----------|-------|--------|-----|------|--------|
| HD220 | 29005 | 3/4" | 100 | 4000 | 0.51# |
| HD230 | 29010 | 1" | 100 | 4000 | 0.66# |
| HD240 | 29015 | 1-1/4" | 100 | 3000 | 0.77# |
| HD255 | 29020 | 1-1/2" | 100 | 3000 | 0.88# |
| HD260 | 29025 | 2" | 100 | 3000 | 0.99# |

FEATURES:

- Drive Pins
- 1/4" Head
- Steel
- Caution! Always Wear Eye Protection

STUD DRIVER

PC 4482

Drive pins are installed with a stud driver. The pin is inserted into the driver which is placed onto the item to be fastened. Using a sledge or drilling hammer, drive the pin home.



| CAT. NO. | UPC | STD | MSTR | WT/STD |
|----------|-------|-----|------|--------|
| HD | 15755 | 1 | 6 | 0.66# |

FEATURES:

- Use With 1/4" Pins
- Cushioned Grip
- Caution! Always Wear Eye Protection

MACHINE SCREW ANCHORS

PC 4520



Machine screw (lead) anchors: Performs well in a variety of concrete strengths, can be used in brick. Any head style screw can be used. The screw can be easily removed or loosened and retightened. Vibration does not affect the lead insert's hold on the concrete. Adapts well to hole size variations. Drill hole in concrete and drop anchor expander side down into hole. Place setting tool over anchor and hammer until set.

FEATURES:

- Medium Duty
- Tool Not Included
- Caution! Always Wear Eye Protection

| CAT. NO. | UPC | ANCHOR SIZE | DRILL SIZE | INSTALL TOOL | STD | MSTR | WT/STD |
|----------|-------|-------------|------------|--------------|-----|------|--------|
| MA2 | 29910 | 8-32 | 5/16" | ST2 | 100 | 1000 | 1.00# |
| MA3 | 29915 | 10-24 | 3/8" | ST3 | 100 | 1000 | 1.75# |
| MA5 | 29925 | 1/4-20 | 1/2" | ST5 | 100 | 600 | 4.50# |
| MA6 | 29930 | 5/16" | 5/8" | ST6 | 50 | 300 | 3.90# |
| MA7 | 29935 | 3/8" | 3/4" | ST7 | 50 | 300 | 7.00# |
| MA8 | 29940 | 1/2" | 7/8" | ST8 | 50 | 300 | 9.50# |

ST Tool must be used for proper installation (sold separately).

"ST" TOOLS FOR MA ANCHORS

PC 4530



"ST" tool must be used for proper installation of MA (Machine Screws) Anchors. Sold separately from MA anchors

| CAT. NO. | UPC | SIZE | USE FOR | STD | MSTR | WT/STD |
|----------|-------|--------|---------|-----|------|--------|
| ST2 | 17600 | 8-32 | MA2 | 1 | 10 | 0.07# |
| ST3 | 17605 | 10-24 | MA3 | 1 | 10 | 0.09# |
| ST5 | 17610 | 1/4-20 | MA5 | 1 | 10 | 0.17# |
| ST6 | 17615 | 5/16" | MA6 | 1 | 10 | 0.27# |
| ST7 | 17620 | 3/8" | MA7 | 1 | 10 | 0.42# |
| ST8 | 17625 | 1/2" | MA8 | 1 | 10 | 0.53# |

TOGGLE ANCHORS - NYLON

PC 4320



Nylon Toggle Anchors: After proper size hole is drilled, fold and insert anchor into hole. In solid concrete it will act as a conventional anchor, in hollow wall installations the anchor opens like a toggle bolt.

FEATURES:

- Toggle Anchors
- Nylon
- Screws Not Provided
- Caution! Always Wear Eye Protection

| CAT. NO. | UPC | SCREW SIZE | DRILL SIZE | WALL THICKNESS | STD | MSTR | WT/STD |
|----------|-------|-------------|------------|----------------|-----|------|--------|
| NT14L | 66790 | 8 x 1-1/2" | 1/4" | 1/2" Drywall | 100 | 1000 | 0.26# |
| NT38L | 66795 | 10 x 1-1/2" | 3/8" | 5/8" Drywall | 100 | 1000 | 0.51# |

See B15 For Kits (NTK14L & NTK38L)

HARNESS TOGGLE

PC 4375



The Harness Toggle is a heavy duty hollow wall anchor designed for use in base materials such as plaster, wallboard, or hollow tile. The Harness Toggle is a pre-assembled anchor consisting of a carbon steel wing and a locking cap/ratchet leg assembly molded from engineered plastic. It is available in both 3/16" and 1/4" size. When compared to traditional toggles, this unique anchor can be installed in a smaller hole and does not require a fixture or screw to set it. The anchor can be easily adjusted to accommodate a wall thickness of up to 2-1/2". The toggle remains captive.

FEATURES:

- Harness Toggle
- Nylon
- Screws Not Provided
- Reusable
- Caution! Always Wear Eye Protection

| CAT. NO. | UPC | SCREW SIZE | DRILL SIZE | WALL THICKNESS | STD | MSTR | WT/STD |
|----------|-------|------------|------------|----------------|-----|------|--------|
| ST36 | 10536 | 3/16 x 4" | 1/2" | 2-1/2" | 50 | 250 | 1.64# |
| ST25 | 10525 | 1/4 x 4" | 1/2" | 2-1/2" | 50 | 250 | 1.66# |

See B15 For Kits

WALL GRIP/WALL DRIVE ANCHORS

Wall Grip Anchors: Also known as "Mollies" or Molly Bolts. Made for hollow wall installations. When tightened, the body pulls up to enable the anchor to secure itself to very thin walls such as paneling.

WALL GRIP

| CAT. NO. | UPC | SIZE | GRIP RANGE | DRILL | STD | MSTR | WT/STD |
|----------|-------|-------|--------------|-------|-----|------|--------|
| WG18S | 31400 | 1/8" | 1/8"-1/2" | 5/16" | 100 | 1000 | 1.20# |
| WG18L | 31402 | 1/8" | 5/8"-7/8" | 5/16" | 100 | 1000 | 1.70# |
| WG316S | 31404 | 3/16" | 1/8"-5/8" | 3/8" | 50 | 500 | 1.70# |
| WG316L | 31406 | 3/16" | 5/8"-1-3/16" | 3/8" | 50 | 500 | 2.04# |
| WG14S | 31408 | 1/4" | 1/8"-5/8" | 1/2" | 50 | 500 | 2.45# |
| WG14L | 31410 | 1/4" | 5/8"-1-3/16" | 1/2" | 50 | 500 | 2.94# |

WALL DRIVE ANCHORS

| | | | | | | | |
|-------|-------|------|-------------|--|-----|------|-------|
| 18SD | 31412 | 1/8" | 1/8"-1/2" | | 100 | 1000 | 1.40# |
| 18SLD | 31414 | 1/8" | 1/8"-13/16" | | 100 | 1000 | 1.75# |

PC 4435

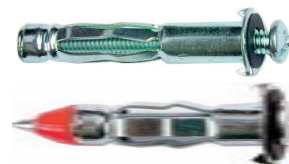

FEATURES:

- Wall Grip/Wall Drive
- Drive Style Anchor Does Not Require a Predrilled Hole
- Steel
- Caution! Always Wear Eye Protection

LAG SHIELDS

Lag shields: Allows for using lag screws in materials such as mortar joints, poured concrete, brick and concrete blocks.

HLS (SHORT) FOR HARD MASONRY

| CAT. NO. | UPC | SIZE | DIA | MIN DEPTH | TENSILE | STD | MSTR | WT/STD |
|----------|-------|-------|------|-----------|---------|-----|------|--------|
| HLS14 | 31200 | 1/4" | 1/2" | 1" | 1450# | 100 | 1000 | 1.98# |
| HLS516 | 31205 | 5/16" | 1/2" | 1-1/4" | 1500# | 100 | 1000 | 2.68# |
| HLS38 | 31210 | 3/8" | 5/8" | 1-3/4" | 1600# | 50 | 500 | 2.30# |
| HLS12 | 31215 | 1/2" | 3/4" | 2" | 2000# | 25 | 250 | 2.07# |

SLS (LONG) FOR SOFT MASONRY

| | | | | | | | | |
|--------|-------|-------|------|----------|-------|----|-----|-------|
| SLS14 | 31230 | 1/4" | 1/2" | 1-1/2" | 1600# | 50 | 500 | 3.90# |
| SLS516 | 31235 | 5/16" | 1/2" | 1-13/16" | 1700# | 50 | 500 | 5.40# |
| SLS38 | 31240 | 3/8" | 5/8" | 2-1/2" | 1800# | 50 | 500 | 2.30# |
| SLS12 | 31245 | 1/2" | 3/4" | 3" | 2750# | 25 | 250 | 2.07# |

PC 4450



FEATURES:

- Lag Shields
- Short & Long Styles
- Zamac Metal
- Caution! Always Wear Eye Protection

THREADED ROD SPIKE

The Threaded Rod Spike is designed primarily for use when hanging threaded rod. Using a special manufacturing process the anchor is formed with a "S" shaped configuration at the working end of the anchor to create an expansion mechanism. As the anchor is driven into the hole, the expansion mechanism is compressed and flexes to the size of the hole.

| CAT. NO. | UPC | SIZE | CONTENTS | STD | MSTR | WT/STD |
|----------|-------|------|--------------------------------|-----|------|--------|
| PS25 | 81492 | 1/4" | Rod Spike for 1/4" Rod Hanging | 100 | 600 | 4.00# |
| PS38 | 81493 | 3/8" | Rod Spike for 3/8" Rod Hanging | 50 | 300 | 4.00# |

PC 4380



FEATURES:

- One Piece Design
- Vibration Resistant
- Approved for Overhead
- Caution! Always Wear Eye Protection

DROP IN ANCHORS

PC 4500, 4310



Drop In Anchors: This steel anchor performs well in a variety of concrete strengths. Can be used in brick. Any head style screw can be used. The screw can easily be removed or loosened and retightened. Drill hole in concrete and drop anchor into hole. Place setting tool over anchor and hammer until set.

STEEL ZINC PLATED - PC 4500

| CAT. NO. | UPC | ANCHOR SIZE | DRILL SIZE | REQUIRED TOOL | STD | MSTR | WT/STD |
|----------|-------|-------------|------------|---------------|-----|------|--------|
| DA25 | 27600 | 1/4-20 | 3/8" | AT25 | 100 | 1000 | 2.00# |
| DA38 | 27605 | 3/8-16 | 1/2" | AT38 | 50 | 500 | 3.00# |
| DA50 | 27610 | 1/2-13 | 5/8" | AT50 | 50 | 250 | 6.00# |
| DA58 | 27615 | 5/8-11 | 7/8" | AT58 | 25 | 125 | 6.00# |
| DA75 | 27620 | 3/4-10 | 1" | AT75 | 10 | 50 | 4.80# |

STAINLESS STEEL - PC 4310

| CAT. NO. | UPC | ANCHOR SIZE | DRILL SIZE | REQUIRED TOOL | STD | MSTR | WT/STD |
|----------|-------|-------------|------------|---------------|-----|------|--------|
| DAS25 | 70260 | 1/4-20 | 3/8" | AT25 | 100 | 1000 | 2.00# |
| DAS38 | 70262 | 3/8-16 | 1/2" | AT38 | 50 | 500 | 3.00# |
| DAS50 | 70264 | 1/2-13 | 5/8" | AT50 | 50 | 250 | 6.00# |
| DAS58 | 70266 | 5/8-11 | 7/8" | AT58 | 25 | 125 | 6.00# |
| DAS75 | 70268 | 3/4-10 | 1" | AT75 | 10 | 50 | 4.80# |

("AT" Tool - SOLD SEPARATELY - Must Be Used For Proper Installation)

FEATURES:

- Drop In
- Zinc Plated Steel
- Stainless Steel
- Caution! Always Wear Eye Protection



"AT" TOOL FOR DA ANCHORS

PC 4510



"AT" tool must be used for proper installation of drop in anchors. Sold separately from DA/DAS anchors.

| CAT. NO. | UPC | SIZE | ANCHOR TYPE | STD | MSTR | WT/STD |
|----------|-------|------|-------------|-----|------|--------|
| AT25 | 27630 | 1/4" | DA25/DAS25 | 1 | 10 | 0.14# |
| AT38 | 27635 | 3/8" | DA38/DAS38 | 1 | 10 | 0.25# |
| AT50 | 27570 | 1/2" | DA50/DAS50 | 1 | 10 | 0.41# |
| AT58 | 27575 | 5/8" | DA58/DAS58 | 1 | 10 | 0.55# |
| AT75 | 27580 | 3/4" | DA75/DAS75 | 1 | 10 | 0.77# |

SLEEVE ANCHORS

PC 4550



Sleeve Anchors: Similar to the wedge anchor. It can be used in the same materials as the wedge anchor, but can also be used in soft concretes because the compression load can be distributed over a longer length. Can be installed through the fixture. Assemble nut and washer on stud and insert into predrilled hole. Anchor is hammered into hole until the nut is seated.

ACORN NUT

| CAT. NO. | UPC | SCREW SIZE | BOLT LENGTH | DRILL DIA | MIN. EMBED | STD | MSTR | WT/STD |
|----------|-------|--------------|-------------|-----------|------------|-----|------|--------|
| SA14138 | 59330 | 1/4 x 1-3/8" | 1-21/32" | 1/4" | 1-1/8" | 100 | 600 | 2.75# |
| SA14214 | 59332 | 1/4 x 2-1/4" | 2-9/16" | 1/4" | 1-1/8" | 100 | 600 | 3.25# |

HEX NUT

| CAT. NO. | UPC | SCREW SIZE | BOLT LENGTH | DRILL DIA | MIN. EMBED | STD | MSTR | WT/STD |
|----------|-------|---------------|-------------|-----------|------------|-----|------|--------|
| SA516112 | 59334 | 5/16 x 1-1/2" | 1-13/16" | 5/16" | 1-3/8" | 100 | 600 | 4.25# |
| SA516212 | 59336 | 5/16 x 2-1/2" | 2-11/16" | 5/16" | 1-1/2" | 100 | 500 | 5.75# |
| SA38178 | 59338 | 3/8 x 1-7/8" | 2-3/16" | 3/8" | 1-5/8" | 50 | 300 | 3.50# |
| SA38300 | 59340 | 3/8 x 3" | 3-5/16" | 3/8" | 1-5/8" | 50 | 250 | 5.00# |
| SA12214 | 59342 | 1/2 x 2-1/4" | 2-7/8" | 1/2" | 2-1/8" | 25 | 150 | 3.50# |
| SA12300 | 59344 | 1/2 x 3" | 3-3/8" | 1/2" | 2-1/4" | 25 | 150 | 4.30# |
| SA12400 | 59346 | 1/2 x 4" | 4-3/8" | 1/2" | 2-1/4" | 25 | 150 | 5.50# |

FEATURES:

- Sleeve
- Hex or Acorn Nut
- Zinc Plated
- Available in Larger Diameters & Lengths
- Caution! Always Wear Eye Protection

WEDGE ANCHORS FULL THREAD

PC 4540

Wedge anchors can be installed through the fixture. Assemble nut and washer until the nut is flush with the top of the anchor, insert into predrilled hole. Hammer anchor into hole until the washer is flush with surface of the fixture. Expand the anchor by tightening nut. Good shear values.



| CAT. NO. | UPC | ANCHOR HOLE DIA | OVERALL LENGTH | THREAD LENGTH | STD | MSTR | WT/STD |
|----------|-------|-----------------|----------------|---------------|-----|------|--------|
| W14134 | 59300 | 1/4-20 | 1-3/4" | 3/4" | 100 | 600 | 3.00# |
| W14214 | 59302 | 1/4-20 | 2-1/4" | 1-1/4" | 100 | 600 | 3.50# |
| W14314 | 59304 | 1/4-20 | 3-1/4" | 2-1/4" | 100 | 600 | 4.75# |
| W38214 | 59306 | 3/8-16 | 2-1/4" | 1-1/4" | 50 | 300 | 4.37# |
| W38234 | 59307 | 3/8-16 | 2-3/4" | 1-5/8" | 50 | 300 | 4.75# |
| W38300 | 59308 | 3/8-16 | 3" | 1-7/8" | 50 | 300 | 5.37# |
| W38334 | 59310 | 3/8-16 | 3-3/4" | 2-5/8" | 50 | 300 | 6.37# |
| W38500 | 59311 | 3/8-16 | 5" | 3-7/8" | 50 | 300 | 7.75# |
| W12234 | 59312 | 1/2-13 | 2-3/4" | 1-3/8" | 50 | 200 | 9.00# |
| W12334 | 59313 | 1/2-13 | 3-3/4" | 2-3/8" | 50 | 200 | 11.50# |
| W12400 | 59314 | 1/2-13 | 4-1/2" | 3-1/8" | 50 | 200 | 14.00# |
| W12512 | 59316 | 1/2-13 | 5-1/2" | 4-1/8" | 50 | 150 | 16.00# |

The published length is the overall length of the anchor.

FEATURES:

- Wedge
- Full Thread
- Zinc Plated
- Available in Larger Diameters & Lengths
- Caution! Always Wear Eye Protection

WEDGE ANCHORS FULL THREAD-STAINLESS STEEL PC 4310

Stainless Steel Wedge Anchors resist corrosion and are ideal for applications where chemical resistance is required. Stainless can be mildly magnetic.



| CAT. NO. | UPC | ANCHOR HOLE DIA | OVERALL LENGTH | THREAD LENGTH | STD | MSTR | WT/STD |
|----------|-------|-----------------|----------------|---------------|-----|------|--------|
| WS14134 | 70310 | 1/4-20 | 1-3/4" | 3/4" | 100 | 600 | 3.00# |
| WS14214 | 70312 | 1/4-20 | 2-1/4" | 1-1/4" | 100 | 600 | 3.50# |
| WS14314 | 70314 | 1/4-20 | 3-1/4" | 2-1/4" | 100 | 600 | 4.75# |
| WS38214 | 70320 | 3/8-16 | 2-1/4" | 1-1/4" | 50 | 300 | 4.37# |
| WS38234 | 70322 | 3/8-16 | 2-3/4" | 1-5/8" | 50 | 300 | 4.75# |
| WS38300 | 70324 | 3/8-16 | 3" | 1-7/8" | 50 | 300 | 5.37# |
| WS38334 | 70326 | 3/8-16 | 3-3/4" | 2-5/8" | 50 | 300 | 6.37# |
| WS38500 | 70328 | 3/8-16 | 5" | 3-7/8" | 50 | 300 | 7.75# |
| WS12234 | 70340 | 1/2-13 | 2-3/4" | 1-3/8" | 50 | 200 | 9.00# |
| WS12334 | 70342 | 1/2-13 | 3-3/4" | 2-3/8" | 50 | 200 | 11.50# |
| WS12400 | 70344 | 1/2-13 | 4-1/2" | 3-1/8" | 50 | 200 | 14.00# |
| WS12512 | 70346 | 1/2-13 | 5-1/2" | 4-1/8" | 50 | 150 | 16.00# |

The published length is the overall length of the anchor.

FEATURES:

- Wedge
- Full Thread
- Stainless Steel
- Available in Larger Diameters & Lengths
- Caution! Always wear eye protection

TECH TALK

Selection

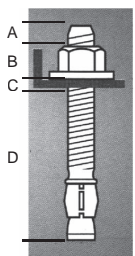

- A 3 turns of nut (approx. 1/2 bolt dia.) +
 B Nut & washer thickness (approx. 1 bolt dia.) +
 C Fixture thickness +
 D Minimum embedment (min. 4112 bolt dia.) =
Minimum Anchor Length

If minimum anchor length falls between 2 sizes, use longer size. The maximum recommended anchor embedment should be 80% of the base material thickness. If a concrete slab is 10" thick, an 8" depth would be the maximum recommended anchor embedment.

Installation



1. Use a carbide bit (ANSI B94 12) the same size as the bolt dia. Drill hole deeper than bolt embed. (min. 4.5 dia.) Do not use core bits. Maintain accurate hole size.
2. Clean hole debris
3. Add washer + thread nut flush with top of bolt. Drive bolt into hole thorough item to be fastened.

4. To set, tighten nut 3-4 full turns or consult chart for guide installation torque.

NOTE: Using in concrete cured less than 28 days will greatly reduce anchor strength.

WARNING: WEAR SAFETY GOGGLES

Terminology

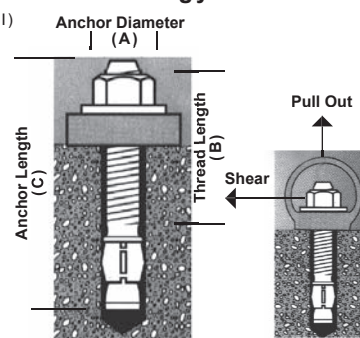



ROD HANGING SYSTEM

STEEL BOTTOM MOUNT

PC 4600

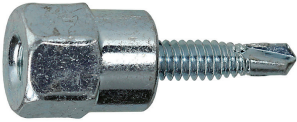

| CAT. NO. | UPC | ROD SIZE | SCREW SHANK SIZE/LENGTH | POINT STYLE | SELF DRILLING RANGE | STD | MSTR | WT/STD |
|------------------------|-------|----------|-------------------------|-------------|---------------------|-----|------|--------|
| #3 FOR PURLINS | | | | | | | | |
| SSM14B ^B | 17591 | 1/4" | 1/4"-20 x 1" | #3 | 0.036" – 0.188" | 100 | 600 | 7.50# |
| SSM38BR ^{B,N} | 17592 | 3/8" | 1/4"-20 x 1-1/2" | #3 | 0.036" – 0.188" | 100 | 500 | 8.01# |
| #5 FOR BEAMS | | | | | | | | |
| SSM12BR ^{B,N} | 17597 | 1/2" | 12-24 x 1-1/2" | #5 | 0.188" – 0.500" | 100 | 500 | 8.01# |

Mount Direction: ^B = Bottom Mount ^{B,N} = Bottom Mount With Nut

STEEL SIDE MOUNT

PC 4600



| CAT. NO. | UPC | ROD SIZE | SCREW SHANK SIZE/LENGTH | POINT STYLE | SELF DRILLING RANGE | STD | MSTR | WT/STD |
|------------------------|-------|----------|-------------------------|-------------|---------------------|-----|------|--------|
| #3 FOR PURLINS | | | | | | | | |
| SSM14S ^S | 17593 | 1/4" | 1/4"-20 x 1" | #3 | 0.036" – 0.188" | 100 | 600 | 7.30# |
| SSM38SR ^{S,N} | 17554 | 3/8" | 1/4"-20 x 1-1/2" | #3 | 0.188" – 0.520" | 100 | 500 | 7.00# |

Mount Direction: ^S = Bottom Mount ^{S,N} = Bottom Mount With Nut

ULTIMATE LOAD CAPACITIES (PURLINS AND BEAMS)

| ROD DIA | SCREW SHANK | STEEL GAUGE (THICKNESS) | | | | | | |
|---------------------|------------------|-------------------------|-------|-------|-------|-------|-------|-------|
| | | 20 | 18 | 16 | 14 | 12 | 3/16" | 1/4" |
| 1/4" ^B | 1/4"-20 x 1" | 1,550 | 1,550 | 1,775 | 1,775 | 2,050 | 3,850 | 5,040 |
| 1/4" ^S | 1/4"-20 x 1" | 1,550 | 1,550 | 1,775 | 1,775 | 2,050 | 3,850 | 2,050 |
| 3/8" ^{B,N} | 1/4"-20 x 1-1/2" | 1,550 | 1,550 | 1,775 | 1,775 | 2,050 | 3,850 | 5,040 |
| 3/8" ^{S,N} | 1/4"-20 x 1-1/2" | 1,550 | 1,550 | 1,775 | 1,775 | 2,050 | 3,850 | 2,050 |
| 1/2" ^{B,N} | 12-24 x 1-1/2" | - | - | 920 | 1,560 | 2,050 | 3,280 | 5,040 |

Mount Direction: ^B = Bottom Mount ^{B,N} = Bottom Mount With Nut ^S = Side Mount ^{S,N} = Side Mount With Nut



Rod Hanger - Steel (self-drilling)



Rod Hanger - Wood (self-drilling)

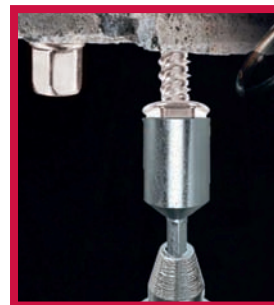

Rod Hanger - Concrete (self-tapping)

ANCHORS & KITS

WOOD BOTTOM MOUNT ROD HANGERS

PC 4600



| CAT. NO. | UPC | ROD SIZE | SCREW SHANK SIZE/LENGTH | POINT STYLE | PRE-DRILL (IF REQUIRED) | STD | MSTR | WT/STD |
|-----------------------|-------|----------|-------------------------|-------------|-------------------------|-----|------|--------|
| SSW14B ^B | 17586 | 1/4" | 1/4" x 2" | Type 17 | 1/8" | 100 | 500 | 8.04# |
| SSW38B ^B | 17587 | 3/8" | 1/4" x 2" | Type 17 | 1/8" | 100 | 500 | 7.10# |
| SSW38BXL ^B | 17582 | 3/8" | 3/8" x 2-1/2" | Type 17 | 1/8" | 100 | 300 | 9.00# |
| SSW12B ^B | 17581 | 1/2" | 3/8" x 2-1/2" | Type 17 | 1/8" | 100 | 300 | 9.00# |

Mount Direction: ^B = Bottom Mount

WOOD SIDE MOUNT ROD HANGERS

PC 4600



| CAT. NO. | UPC | ROD SIZE | SCREW SHANK SIZE/LENGTH | POINT STYLE | PRE-DRILL (IF REQUIRED) | STD | MSTR | WT/STD |
|-----------------------|-------|----------|-------------------------|-------------|-------------------------|-----|------|--------|
| SSW38S ^S | 17589 | 3/8" | 1/4" x 2" | Type 17 | 1/8" | 100 | 500 | 7.40# |
| SSW38SXL ^S | 17590 | 3/8" | 3/8" x 2-1/2" | Type 17 | 1/8" | 100 | 300 | 8.60# |

Mount Direction: ^S = Side Mount

ULTIMATE LOAD CAPACITIES INSTALLED IN WOOD BASE MATERIALS (STRUCTURAL WOOD & TIMBER)

| ROD DIA | SCREW SHANK SIZE/LENGTH | EMBED DEPTH | FIR (LBS) | PINE (LBS) | SPRUCE (LBS) |
|-------------------|-------------------------|-------------|-----------|------------|--------------|
| 1/4" ^B | 1/4" x 2" | 2" | 685 | 650 | 650 |
| 1/4" ^S | 1/4" x 2" | 2" | 1,510 | 1,510 | 1,510 |
| 3/8" ^B | 1/4" x 2" | 2" | 1,510 | 1,510 | 1,510 |
| 3/8" ^S | 1/4" x 2" | 2" | 1,800 | 1,800 | 1,800 |
| 3/8" ^B | 3/8" x 2-1/2" | 2-1/2" | 2,670 | 3,110 | 3,110 |
| 3/8" ^S | 3/8" x 2-1/2" | 2-1/2" | 1,450 | 1,530 | 1,380 |
| 1/2" ^B | 3/8" x 2-1/2" | 2-1/2" | 2,670 | 3,110 | 3,110 |

Mount Direction: ^B = Bottom Mount ^S = Side Mount

TECH TALK

What is the Dottie Rod Hanging System For?

- Pipe hanging
- Conduit
- Eye rod
- Cable trays
- Lighting systems
- Strut channels
- Overhead utilities
- Sprinkler systems
- Drop ceilings
- HVAC duct
- Electrical
- Refrigeration

Who Uses the Dottie Rod Hanging System?

- Plumbers
- Maintenance Contractors
- Electricians
- Sprinkler Contractors
- Mechanical Contractors
- HVAC Contractors

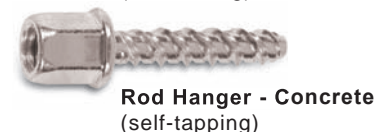
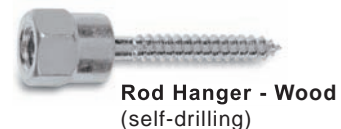



ROD HANGING SYSTEM

CONCRETE BOTTOM MOUNT ROD HANGERS

PC 4600



| CAT. NO. | UPC | ROD SIZE | SCREW SHANK SIZE/LENGTH | THREAD STYLE | PRE-DRILL DIAMETER | STD | MSTR | WT/STD |
|---------------------|-------|----------|-------------------------|------------------------|--------------------|-----|------|--------|
| SSC14B ^B | 81215 | 1/4" | 1/4" x 1-1/4" | ANSI Wedge-Bolt Thread | 1/4" ANSI | 100 | 600 | 2.92# |
| SSC38B ^B | 18550 | 3/8" | 1/4" x 1-1/2" | ANSI Wedge-Bolt Thread | 1/4" ANSI | 100 | 600 | 4.70# |
| SSC12B ^B | 81216 | 1/2" | 3/8" x 2-3/4" | ANSI Wedge-Bolt Thread | 3/8" ANSI | 50 | 250 | 8.00# |

Mount Direction: ^B = Bottom Mount

ANCHORS & KITS

ROD HANGING SYSTEM ACCESSORIES

PC 4605

**SCP Series



NUT DRIVERS

*UNIB



| CAT. NO. | UPC | SOCKET DESCRIPTION | SUGGESTED GUIDELINES | STD | MSTR | WT/STD |
|----------|-------|--|----------------------------|-----|------|--------|
| UNIB | 17595 | Universal Side & Bottom For Installation Tool Steel & Wood | 500 – 1500 RPM drill speed | 1 | 5 | 0.25# |
| SCP14 | 81217 | 1/4" Concrete Installation Tool | | 1 | 5 | 0.25# |
| SCP38 | 81218 | 3/8" Concrete Installation Tool | | 1 | 5 | 0.25# |
| SCP50 | 81248 | 1/2" Concrete Installation Tool | | 1 | 5 | 0.25# |
| SS3009 | 11209 | Installation Tool Kit for Concrete Anchors | | 1 | 10 | 2.92# |

PRE-TIED CEILING WIRE WITH CLIP STRAIGHT CEILING WIRE

PC 4385



Pre-Tied Ceiling Wires are installed with low velocity powder actuated tools in poured concrete deck.

| CAT. NO. | UPC | DESCRIPTION | STD | MSTR | WT/STD |
|----------|-------|--|-----|------|--------|
| CWC6 | 81936 | 6' Pre-Tied Ceiling Wire with 1-1/4" Pin & Clip | 100 | 1000 | 22.00# |
| CWC8 | 82073 | 8' Pre-Tied Ceiling Wire with 1-1/4" Pin & Clip | 100 | 1000 | 29.43# |
| CWC10 | 82076 | 10' Pre-Tied Ceiling Wire with 1-1/4" Pin & Clip | 100 | 1000 | 36.88# |
| CWC12 | 83244 | 12' Pre-Tied Ceiling Wire with 1-1/4" Pin & Clip | 100 | 1000 | 44.29# |
| CWS6 | 82074 | 6' Straight Ceiling Wire | 100 | 1000 | 21.10# |
| CWS8 | 82075 | 8' Straight Ceiling Wire | 100 | 1000 | 28.13# |
| CWS10 | 82072 | 10' Straight Ceiling Wire | 100 | 1000 | 36.16# |
| CWS12 | 82403 | 12' Straight Ceiling Wire | 100 | 1000 | 43.19# |

FEATURES:

- 12 Gauge Wire

- Includes 1-1/4" Pin & Clip
- Galvanized Finish

B10

CELEBRATING 50 YEARS

TELESCOPING POLE TOOLS

Provides a safe way to reach areas that previously were dangerous or inaccessible to ladders, scaffolding, and scissor lifts - including vaulted ceilings, over stairwells, and through ceiling grid. The Dottie Electrical Telescoping Pole Tool is the electrician's pole tool. The interchangeable heads make it the most efficient tool of its kind. Use it to install ceiling wire (Page B10 with Hanger Screws Page A31), jack chain (Page A32), threaded rod (Page A25 with Rod Hangers Pages B8-10), and overhead screw or nut installations. Power the pole with any 3/8" or 1/2" drill. Dottie's Pole tool comes with all three interchangeable head - Wire, Double Sided Socket and 1/4" Hex Drive. The Double Sided Socket will accommodate both Dottie's Rod Hanging System Anchors (Pages B8-10) and competitive rod hanging anchors.

| CAT. NO. | UPC | DESCRIPTION | STD | MSTRWT/STD |
|----------|-------|-----------------------------------|-----|------------|
| DLM12 | 82280 | Triple 4ft. Telescoping Pole Tool | 1 | 5.90# |
| DLM18 | 82281 | Triple 6ft. Telescoping Pole Tool | 1 | 7.80# |

ACCESSORIES

| | | | | |
|--------|-------|------------------------------|---|-------|
| DLMWT | 83166 | Wire & Chain Plug in Head | 1 | 1.25# |
| DLMRHD | 83168 | Double Sided Rod Hanger Head | 1 | 1.25# |
| DLMHD | 83167 | 1/4" Bit & Power Bit Head | 1 | 1.25# |

1 TOOL 3 USES SAFER.FASTER.EASIER.

HANG JACK CHAIN & CEILING WIRE



THREADED ROD HANGING SYSTEM



USE AS A BIT DRIVER & A NUT DRIVER

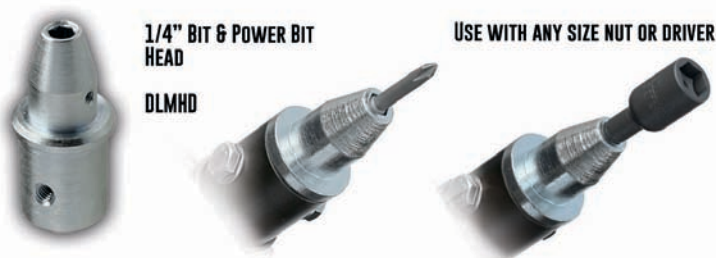

ANCHORS & KITS





CONCRETE ANCHORING SYSTEM

CONCRETE ANCHORING SYSTEM

PC 4560



Faster to install than most steel anchors, yet has significant load capacities. One tool drills the hole and sets the anchor without the need to remove from the drill chuck. Has the added advantage of close to edge fastening without potential breakout. Works in poured concrete, prestressed concrete, cinder block, brick, and mortar, and can be loosened for adjustment or removed.

FEATURES:

- Concrete Anchor System
- Hex Head Slotted or Flat Head Phillips
- Hi-Low Thread
- Ceramic Coated Blue Finish
- Includes Drill
- Caution! Always Wear Eye Protection

HEX HEAD SLOTTED 3/16"

| CAT. NO. | UPC | ANCHOR SIZE | HEX/ PHILLIPS BIT SIZE | DRILL SIZE | STD | MSTR | WT/STD |
|----------|-------|---------------|------------------------------|---------------|-----|------|--------|
| 36H114 | 11208 | 3/16 x 1-1/4" | 1/4" | 5/32 x 3-1/2" | 100 | 500 | 0.89# |
| 36H134 | 11288 | 3/16 x 1-3/4" | 1/4" | 5/32 x 3-1/2" | 100 | 500 | 1.07# |
| 36H214 | 11368 | 3/16 x 2-1/4" | 1/4" | 5/32 x 4-1/2" | 100 | 500 | 1.30# |
| 36H234 | 11448 | 3/16 x 2-3/4" | 1/4" | 5/32 x 4-1/2" | 100 | 500 | 1.51# |
| 36H314 | 11528 | 3/16 x 3-1/4" | 1/4" | 5/32 x 5-1/2" | 100 | 500 | 1.87# |

HEX HEAD SLOTTED 1/4"

| CAT. NO. | UPC | ANCHOR SIZE | HEX/ PHILLIPS BIT SIZE | DRILL SIZE | STD | MSTR | WT/STD |
|----------|-------|--------------|------------------------------|---------------|-----|------|--------|
| 14H114 | 25208 | 1/4 x 1-1/4" | 5/16" | 3/16 x 3-1/2" | 100 | 500 | 1.44# |
| 14H134 | 25288 | 1/4 x 1-3/4" | 5/16" | 3/16 x 3-1/2" | 100 | 500 | 1.83# |
| 14H214 | 25368 | 1/4 x 2-1/4" | 5/16" | 3/16 x 4-1/2" | 100 | 500 | 2.26# |
| 14H234 | 25448 | 1/4 x 2-3/4" | 5/16" | 3/16 x 4-1/2" | 100 | 500 | 2.96# |
| 14H314 | 25528 | 1/4 x 3-1/4" | 5/16" | 3/16 x 5-1/2" | 100 | 500 | 3.02# |
| 14H334 | 25608 | 1/4 x 3-3/4" | 5/16" | 3/16 x 5-1/2" | 100 | 500 | 3.41# |
| 14H400 | 25648 | 1/4 x 4" | 5/16" | 3/16 x 5-1/2" | 100 | 500 | 3.62# |

FLAT HEAD PHILLIPS 3/16"

| CAT. NO. | UPC | ANCHOR SIZE | HEX/ PHILLIPS BIT SIZE | DRILL SIZE | STD | MSTR | WT/STD |
|----------|-------|---------------|------------------------------|---------------|-----|------|--------|
| 36P114 | 11201 | 3/16 x 1-1/4" | #2 | 5/32 x 3-1/2" | 100 | 500 | 0.84# |
| 36P134 | 11281 | 3/16 x 1-3/4" | #2 | 5/32 x 3-1/2" | 100 | 500 | 1.04# |
| 36P214 | 11361 | 3/16 x 2-1/4" | #2 | 5/32 x 4-1/2" | 100 | 500 | 1.28# |
| 36P234 | 11441 | 3/16 x 2-3/4" | #2 | 5/32 x 4-1/2" | 100 | 500 | 1.45# |
| 36P314 | 11521 | 3/16 x 3-1/4" | #2 | 5/32 x 5-1/2" | 100 | 500 | 1.77# |

FLAT HEAD PHILLIPS 1/4"

| CAT. NO. | UPC | ANCHOR SIZE | HEX/ PHILLIPS BIT SIZE | DRILL SIZE | STD | MSTR | WT/STD |
|----------|-------|--------------|------------------------------|---------------|-----|------|--------|
| 14P114 | 25201 | 1/4 x 1-1/4" | #2 | 3/16 x 3-1/2" | 100 | 500 | 1.39# |
| 14P134 | 25281 | 1/4 x 1-3/4" | #2 | 3/16 x 3-1/2" | 100 | 500 | 1.85# |
| 14P214 | 25361 | 1/4 x 2-1/4" | #2 | 3/16 x 4-1/2" | 100 | 500 | 2.05# |
| 14P234 | 25441 | 1/4 x 2-3/4" | #2 | 3/16 x 4-1/2" | 100 | 500 | 2.53# |
| 14P314 | 25521 | 1/4 x 3-1/4" | #2 | 3/16 x 5-1/2" | 100 | 500 | 2.96# |
| 14P334 | 25601 | 1/4 x 3-3/4" | #2 | 3/16 x 5-1/2" | 100 | 500 | 3.38# |
| 14P400 | 25641 | 1/4 x 4" | #2 | 3/16 x 5-1/2" | 100 | 500 | 3.61# |

INSTALLATION TOOL - PHILIPS & HEX HEAD

PC 4590

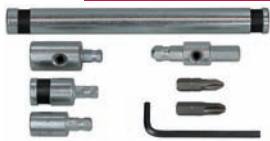

Installation tool installs all lengths of both phillips & hex head concrete screws. Consists of one each: Masonry drill bit holder; Phillips socket driver with one #2 & one #3 Phillips bit; 1/4" Hex socket driver; 5/16" Hex socket driver & allen wrench.

FEATURES:

- Phillips or Hex Head
- Accommodates All Lengths
- Storage Box

| CAT. NO. | UPC | DESCRIPTION | STD | MSTR | WT/STD |
|----------|-------|-------------------|-----|------|--------|
| IT1000 | 14495 | Installation Tool | 1 | 10 | 1.50# |

HAMMER DRILL CARBIDE TIPPED MASONRY DRILL BITS

PC 4570



Hammer Drills (CD Series) made specifically for Concrete Screw Anchoring System and are manufactured with closer tolerances.

5/32"

| CAT. NO. | UPC | ANCHOR SIZE | DRILL SIZE | STD | MSTR | WT/STD |
|----------|-------|-------------|---------------|-----|------|--------|
| CD5323 | 14500 | 3/16" | 5/32 x 3-1/2" | 10 | | 0.22# |
| CD5324 | 14502 | 3/16" | 5/32 x 4-1/2" | 10 | | 0.22# |
| CD5325 | 14504 | 3/16" | 5/32 x 5-1/2" | 10 | | 0.24# |

3/16"

| CAT. NO. | UPC | ANCHOR SIZE | DRILL SIZE | STD | MSTR | WT/STD |
|----------|-------|-------------|---------------|-----|------|--------|
| CD3163 | 14506 | 1/4" | 3/16 x 3-1/2" | 10 | | 0.25# |
| CD3164 | 14508 | 1/4" | 3/16 x 4-1/2" | 10 | | 0.27# |
| CD3165 | 14510 | 1/4" | 3/16 x 5-1/2" | 10 | | 0.29# |

FEATURES:

- Carbide Tipped
- Close Tolerances
- Caution! Always Wear Eye Protection

SDS Rotohammer Bits See Page E4

ANCHORS & KITS

ANCHOR KITS

PC 4610

Dottie is an industry leader in Anchor Kits. We offer a comprehensive variety for almost any imaginable need.

FEATURES:

- 100 Sheet Metal Screws
- 100 Anchors
- Carbide Masonry Drill
- Display or Tuff Pack
- Caution! Always Wear Eye Protection



6 X 1 SHEET METAL SCREWS

| CAT. NO. | UPC | D-DISPLAY PACK T-TUFF PACK | SCREW TYPE | ANCHOR TYPE | DRILL | STD | MSTRWT/STD |
|----------|-------|-------------------------------|------------------|-----------------|-------|-----|------------|
| RD2 | 30460 | D | Phillips/Slotted | #21 Red Collar | 3/16" | 1 | 10 0.59# |
| RD2TP | 30465 | T | Phillips/Slotted | #21 Red Collar | 3/16" | 1 | 6 0.59# |
| RD2HX | 30463 | D | Hex/Slotted | #21 Red Collar | 3/16" | 1 | 10 0.54# |
| RD2HXTP | 30461 | T | Hex/Slotted | #21 Red Collar | 3/16" | 1 | 6 0.54# |
| 1AK | 29630 | D | Phillips/Slotted | #121 White Wing | 3/16" | 1 | 10 0.60# |
| 1AKTP | 29632 | T | Phillips/Slotted | #121 White Wing | 3/16" | 1 | 6 0.60# |

8 X 1 SHEET METAL SCREWS

| | | | | | | | |
|---------|-------|---|------------------|----------------|------|---|----------|
| RD3 | 30467 | D | Phillips/Slotted | #22 Red Collar | 1/4" | 1 | 10 0.83# |
| RD3TP | 30469 | T | Phillips/Slotted | #22 Red Collar | 1/4" | 1 | 6 0.83# |
| RD3HX | 30471 | D | Hex/Slotted | #22 Red Collar | 1/4" | 1 | 10 0.82# |
| RD3HXTP | 30473 | T | Hex/Slotted | #22 Red Collar | 1/4" | 1 | 6 0.82# |
| RD3DD | 30475 | D | Square Drive | #22 Red Collar | 1/4" | 1 | 10 0.84# |
| RD3DDTP | 30477 | T | Square Drive | #22 Red Collar | 1/4" | 1 | 6 0.84# |

10 X 1 SHEET METAL SCREWS

| | | | | | | | |
|---------|-------|---|------------------|------------------|------|---|----------|
| K6CO | 29625 | D | Phillips/Slotted | #22 Red Collar | 1/4" | 1 | 10 1.03# |
| K6COTP | 29627 | T | Phillips/Slotted | #22 Red Collar | 1/4" | 1 | 6 1.03# |
| K6HX | 29621 | D | Hex/Phil/Slotted | #22 Red Collar | 1/4" | 1 | 10 1.05# |
| K6HXTP | 29622 | T | Hex/Phil/Slotted | #22 Red Collar | 1/4" | 1 | 6 1.05# |
| K7DC | 16945 | D | Square Drive | #22 Red Collar | 1/4" | 1 | 10 1.01# |
| K7DCTP | 16947 | T | Square Drive | #22 Red Collar | 1/4" | 1 | 6 1.01# |
| 2AK | 59200 | D | Phillips/Slotted | #122 Yellow Wing | 1/4" | 1 | 10 1.11# |
| 2AKTP | 59202 | T | Phillips/Slotted | #122 Yellow Wing | 1/4" | 1 | 6 1.11# |
| 2AKHX | 59203 | D | Hex/Phil/Slotted | #122 Yellow Wing | 1/4" | 1 | 10 1.04# |
| 2AKHXTP | 59204 | T | Hex/Phil/Slotted | #122 Yellow Wing | 1/4" | 1 | 6 1.04# |
| 2AKDD | 59207 | D | Square Drive | #122 Yellow Wing | 1/4" | 1 | 10 1.06# |
| 2AKDDTP | 59206 | T | Square Drive | #122 Yellow Wing | 1/4" | 1 | 6 1.06# |
| K6D | 29600 | D | Phillips/Slotted | #222 Green Str. | 1/4" | 1 | 10 1.02# |
| K6DTP | 29602 | T | Phillips/Slotted | #222 Green Str. | 1/4" | 1 | 6 1.02# |

12 X 1-1/2 SHEET METAL SCREWS (50 SCREWS, 50 ANCHORS)

| | | | | | | | |
|----------|-------|---|------------------|------------------|-------|---|----------|
| K14C | 29615 | D | Phillips/Slotted | #23 Red Collar | 5/16" | 1 | 10 0.95# |
| K14CTP | 29617 | T | Phillips/Slotted | #23 Red Collar | 5/16" | 1 | 6 0.95# |
| K14CHX | 29550 | D | Hex/Slotted | #23 Red Collar | 5/16" | 1 | 10 0.99# |
| K14CHXTP | 29552 | T | Hex/Slotted | #23 Red Collar | 5/16" | 1 | 6 0.99# |
| K14CDD | 29554 | D | Square Drive | #23 Red Collar | 5/16" | 1 | 10 0.99# |
| K14CDDTP | 29556 | T | Square Drive | #23 Red Collar | 5/16" | 1 | 6 0.99# |
| 3AK | 29635 | D | Phillips/Slotted | #123 Yellow Wing | 5/16" | 1 | 10 0.95# |
| 3AKTP | 29637 | T | Phillips/Slotted | #123 Yellow Wing | 5/16" | 1 | 6 0.95# |

MULTI-GRIP KITS CONTAIN: 100 6 X 1-1/4" SCREWS, 100 #6 ANCHORS

| | | | | | | |
|-----------|-------|---------------------|----------|------|---|---------|
| TG6KTP | 81647 | #6 Phillips/Slotted | #6 Beige | 1/4" | 1 | 6 0.80# |
| TG6KSQTP | 81649 | #6 Square Drive | #6 Beige | 1/4" | 1 | 6 0.80# |
| TG6KHXTTP | 81651 | #6 Hex/Slotted | #6 Beige | 1/4" | 1 | 6 0.80# |

MULTI-GRIP KITS CONTAIN: 100 8 X 1-1/4" SCREWS, 100 #8 ANCHORS

| | | | | | | |
|-----------|-------|---------------------|---------|------|---|---------|
| TG8KTP | 81653 | #8 Phillips/Slotted | #8 Gray | 1/4" | 1 | 6 0.90# |
| TG8KSQTP | 81655 | #8 Square Drive | #8 Gray | 1/4" | 1 | 6 0.90# |
| TG8KHXTTP | 81657 | #8 Hex/Slotted | #8 Gray | 1/4" | 1 | 6 0.90# |

MULTI-GRIP KITS CONTAIN: 100 10 X 1-1/2" SCREWS, 100 #10 ANCHORS

| | | | | | | |
|------------|-------|----------------------|----------|-------|---|---------|
| TG10KTP | 81659 | #10 Phillips/Slotted | #10 Blue | 5/16" | 1 | 6 1.30# |
| TG10KSQTP | 81661 | #10 Square Drive | #10 Blue | 5/16" | 1 | 6 1.30# |
| TG10KHXTTP | 81663 | #10 Hex/Slotted | #10 Blue | 5/16" | 1 | 6 1.30# |

MULTI-GRIP KITS CONTAIN: 50 12 X 1-1/2" SCREWS, 50 #12 ANCHORS

| | | | | | | |
|------------|-------|----------------------|-----------|------|---|---------|
| TG12KTP | 81665 | #12 Phillips/Slotted | #12 Green | 3/8" | 1 | 6 1.30# |
| TG12KSQTP | 81667 | #12 Square Drive | #12 Green | 3/8" | 1 | 6 1.30# |
| TG12KHXTTP | 81669 | #12 Hex/Slotted | #12 Green | 3/8" | 1 | 6 1.30# |

Multi-Grip Kits available packaged in Displayable 2 Compartment Packaging. See your Dottie Price Master.

ANCHORS & KITS



ANCHOR KITS

WALL BOARD KITS - PHILLIPS/SQUARE/WAFER

PC 4730

ANCHORS & KITS



PHILLIPS/SLOTTED

| CAT. NO. | UPC | D-DISP PK. T-TUFF PK. | SCREW SIZE | ANCHOR BIT | STD MSTR WT/STD |
|----------|-------|--------------------------|---------------|------------|-----------------|
| WDK6 | 29780 | D | 6 x 1" | Zinc | IB1P 1 10 0.75# |
| WDK6T | 29855 | T | 6 x 1" | Zinc | IB1P 1 6 0.75# |
| WDK6N | 29781 | D | 6 x 1" | Nylon | IB1P 1 10 0.46# |
| WDK6NT | 29857 | T | 6 x 1" | Nylon | IB1P 1 6 0.46# |
| WDK8 | 29786 | D | 8 x 1-1/4" | Zinc | IB2P 1 10 1.33# |
| WDK8T | 29862 | T | 8 x 1-1/4" | Zinc | IB2P 1 6 1.33# |
| WDK8N | 29787 | D | 8 x 1-1/4" | Nylon | IB2P 1 10 0.70# |
| WDK8NT | 29864 | T | 8 x 1-1/4" | Nylon | IB2P 1 6 0.46# |

SQUARE DRIVE

| CAT. NO. | UPC | D-DISP PK. T-TUFF PK. | SCREW SIZE | ANCHOR BIT | STD MSTR WT/STD |
|----------|-------|--------------------------|---------------|------------|-----------------|
| WDK6SQ | 29790 | D | 6 x 1" | Zinc | IB1 1 10 0.75# |
| WDK6SQT | 29866 | T | 6 x 1" | Zinc | IB1 1 6 0.75# |
| WDK6NSQ | 29791 | D | 6 x 1" | Nylon | IB1 1 10 0.46# |
| WDK6NSQT | 29868 | T | 6 x 1" | Nylon | IB1 1 6 0.46# |
| WDK8SQ | 29796 | D | 8 x 1-1/4" | Zinc | IB2 1 10 1.33# |
| WDK8SQT | 29872 | T | 8 x 1-1/4" | Zinc | IB2 1 6 1.33# |
| WDK8NSQ | 29797 | D | 8 x 1-1/4" | Nylon | IB2 1 10 0.70# |
| WDK8NSQT | 29874 | T | 8 x 1-1/4" | Nylon | IB2 1 6 0.46# |

WAFER HEAD PHILLIPS/SQUARE DRIVE

| CAT. NO. | UPC | D-DISP PK. T-TUFF PK. | SCREW SIZE | ANCHOR BIT | STD MSTR WT/STD |
|-----------|-------|--------------------------|---------------|------------|-----------------|
| WDK8W | 81518 | D | 8 x 1-1/4" | Zinc | IB2P 1 10 1.33# |
| WDK8WT | 81519 | T | 8 x 1-1/4" | Zinc | IB2P 1 6 1.33# |
| WDK8NW | 81520 | D | 8 x 1-1/4" | Nylon | IB2P 1 10 0.70# |
| WDK8NWT | 81521 | T | 8 x 1-1/4" | Nylon | IB2P 1 6 0.70# |
| WDK8WSQ | 81522 | D | 8 x 1-1/4" | Zinc | IB2 1 10 1.33# |
| WDK8WSQT | 81523 | T | 8 x 1-1/4" | Zinc | IB2 1 6 1.33# |
| WDK8NWSQ | 81524 | D | 8 x 1-1/4" | Nylon | IB2 1 10 0.70# |
| WDK8NWSQT | 81525 | T | 8 x 1-1/4" | Nylon | IB2 1 6 0.46# |

FEATURES:

- Easy To Spot
- Reusable
- Deep Threads
- Includes Bit
- 50 Phillips/
Square/Wafer Sheet
Metal Screws
- 50 Zinc or Nylon
Anchors
- Display or Tuff
Pack

WALL DOG-PHILLIPS/SQUARE/HEX

PC 4731



FEATURES:

- Installs in wallboard, plywood, concrete, hollow or grout filled block, brick and plaster
- No second step, installs directly through fixture into wallboard
- Thread design prevents spinning and stripping
- Installs easily with a screwdriver or drill
- When removed it leaves a much smaller hole than toggles or other systems

| CAT. NO. | UPC | DESCRIPTION | STD MSTR WT/STD |
|----------|-------|--|-----------------|
| WDOG | 31395 | 100 Chrome Phillips Wall Dog 1 3/16" Carbide Tip Drill Bit 1 IB2PL Phillips Power Bit | 1 10 1.67# |
| WDOGW | 31396 | 100 White Phillips Wall Dog 1 3/16" Carbide Tip Drill Bit 1 IB2PL Phillips Power Bit | 1 10 1.67# |
| SQDOG | 16290 | 100 Chrome Square Wall Dog 1 3/16" Carbide Tip Drill Bit 1 IB2L Square Drive Power Bit | 1 10 1.67# |
| HXDOG | 81016 | 100 Chrome Hex Drive Wall Dog 1 3/16" Carbide Tip Drill Bit 1 MT10 Magnetic Hex Bit | 1 10 1.67# |

WALL BOARD TOGGLE KITS

PC 4751

| CAT. NO. | UPC | CONTENTS | | STD MSTR WT/STD | | |
|----------|-------|----------|---|-----------------|---|-------|
| WDT83 | 81022 | 35-1/8" | Wall Board Toggle (1/8" x 3" Truss Hd. Mach. Screws) | 1 | 6 | 1.10# |
| WDT363 | 81023 | 25-3/16" | Wall Board Toggle (3/16" x 3" Truss Hd. Mach. Screws) | 1 | 6 | 1.65# |
| WDT43 | 81024 | 20-1/4" | Wall Board Toggle (1/4" x 3" Truss Hd. Mach. Screws) | 1 | 6 | 1.65# |



FEATURES:

- Wall Board Toggle
- Includes Screws & Power Bit
- Reusable
- Metal/Engineered Plastic
- Labor Saver

TEST RESULTS

| DRYWALL THICKNESS | TENSION (LBS) | SHEAR (LBS) |
|-------------------|---------------|-------------|
| 3/8" | 87 | 231 |
| 1/2" | 106 | 253 |
| 5/8" | 160 | 285 |



NOTE: The values listed above are ultimate load capacities which should be reduced by a minimum safety factor of 4 or greater to determine the allowable working load.

NYLON BUTTON HEAD AND TOGGLE ANCHOR KITS

PC 4610

NYLON BUTTON HEAD ANCHORS WITH PINS

| CAT. NO. | UPC | D-DISPLAY PACK T-TUFF PACK | SIZE | ANCHOR TYPE | DRILL | STD | MSTR | WT/STD |
|----------|-------|-------------------------------|-----------|----------------|-------|-----|------|--------|
| 711 | 18535 | D | 3/16 x 1" | 1711 | 3/16" | 1 | 10 | 0.67# |
| 711TP | 18537 | T | 3/16 x 1" | 1711 | 3/16" | 1 | 6 | 0.67# |
| 714 | 18540 | D | 1/4 x 1" | 1714 | 1/4" | 1 | 10 | 0.72# |
| 714TP | 18545 | T | 1/4 x 1" | 1714 | 1/4" | 1 | 6 | 0.72# |

NYLON TOGGLE ANCHORS WITH SCREWS

| | | | | | | | | |
|----------|-------|---|-------------|-------|------|---|----|-------|
| NTK14L | 66797 | D | 8 x 1-1/2" | NT14L | 1/4" | 1 | 10 | 0.39# |
| NTK14LTP | 66800 | T | 8 x 1-1/2" | NT14L | 1/4" | 1 | 6 | 0.39# |
| NTK38L | 66799 | D | 10 x 1-1/2" | NT38L | 3/8" | 1 | 10 | 0.49# |
| NTK38LTP | 66802 | T | 10 x 1-1/2" | NT38L | 3/8" | 1 | 6 | 0.49# |

FEATURES:

- 100 Nylon Button Head Anchors With Pin
- 1 Carbide Masonry Drill
- Display or Tuff Pack
- 25 Nylon Toggle Anchors
- 25 Sheet Metal Screws
- 1 Carbide Masonry Drill
- Display or Tuff Pack



HARNESSTOGGLE KITS

PC 4735

The Harness Toggle is a heavy duty hollow wall anchor for use in base materials such as plaster, wallboard, or hollow tile. The Harness Toggle is a preassembled anchor consisting of a carbon steel wing and a locking cap/ratchet leg assembly molded from engineered plastic. It is available in both 3/16" and 1/4" size. When compared to traditional toggles, this unique anchor can be installed in a smaller hole and does not require a fixture or screw to set it. The anchor can easily be adjusted to accommodate a wall thickness of up to 2-1/2". The toggle remains captive.



FEATURES:

- Harness Toggle
- Nylon
- Includes Screws
- Reusable

| CAT. NO. | UPC | DESCRIPTION | STD MSTR WT/STD | | |
|----------|-------|--|-----------------|----|-------|
| STK36 | 10524 | 25 3/16 x 4" Harness Toggles and 25 3/16 x 4" Mushroom Head Screws | 1 | 10 | 1.67# |
| STK25 | 10526 | 25 1/4 x 4" Harness Toggles and 25 1/4 x 4" Mushroom Head Screws | 1 | 10 | 1.89# |



FASTENER KITS

FASTENER KITS

PC 4760



FEATURES:

- Reusable Six Compartment Box
- Handy Assortment

Dottie introduced assorted screw kits over 50 years ago and has a comprehensive variety for almost any imaginable need.

MACHINE SCREW KITS

| CAT. NO. | UPC | DESCRIPTION | STD | MSTR | WT/STD |
|----------|-------|--|-----|------|--------|
| 632 | 18140 | 370 Assorted 6-32 Slotted Flat Head Machine Screws; 3/4" Thru 3" 100-1/2", 75-3/4", 75-1", 50-1-1/4", 40-1-1/2", 30-2" | 1 | 6 | 1.85# |
| 632DD | 29655 | 370 Assorted 6-32 Square/Phillips Flat Head Machine Screws; 1/2" Thru 2" 100-1/2", 75-3/4", 75-1", 50-1-1/4", 40-1-1/2", 30-2" | 1 | 6 | 1.88# |
| 632PS | 29657 | 370 Assorted 6-32 Phillips/Slotted Round Head Machine Screws; 1/2" Thru 2", 100-1/2", 75-3/4", 75-1", 50-1-1/4", 40-1-1/2", 30-2" | 1 | 6 | 1.59# |
| 832DS | 29665 | 310 Assorted 8-32 Square/Slotted Round Head Machine Screws; 1/2" Thru 2" 100-1/2", 60-3/4", 50-1", 40-1-1/4", 35-1-1/2", 25-2" | 1 | 6 | 2.31# |
| 832PS | 29660 | 370 Assorted 8-32 Phillips/Slotted Round Head Machine Screws; 1/2" Thru 2" 100-1/2", 75-3/4", 75-1", 50-1-1/4", 40-1-1/2", 30-2" | 1 | 6 | 2.30# |
| 1032PS | 10323 | 245 Assorted 10-32 Phillips/Slotted Round Head Machine Screws; 1/2" Thru 2" 75-1/2", 50-3/4", 40-1", 30-1-1/4", 25-1-1/2", 25-2" | 1 | 6 | 3.13# |
| 1420PS | 14205 | 110 Assorted 1/4-20 Phillips/Slotted Round Head Machine Screws; 1/2" Thru 2" 30-1/2", 25-3/4", 20-1", 15-1-1/4", 10-1-1/2", 10-2" | 1 | 6 | 1.87# |

STOVE BOLT KITS WITH NUTS

| | | | | | |
|------|-------|---|---|---|-------|
| 316 | 16560 | 220 Assorted 3/16 (10-24) Slotted Truss Head Stove Bolts with Hex Nuts; 1/2" Thru 2" 50-1/2", 50-3/4", 40-1", 30-1-1/4", 30-1 1/2", 20-2" | 1 | 6 | 2.82# |
| 1420 | 14200 | 110 Assorted 1/4-20 Slotted Truss Head Stove Bolts, with Hex Nuts; 1/2" Thru 2" 30-1/2", 25-3/4", 20-1", 15-1-1/4", 10-1-1/2" | 1 | 6 | 2.77# |

HEX NUT KIT

| | | | | | |
|-----|-------|--|---|---|-------|
| 339 | 17000 | 339 Assorted Zinc Plated Hex Nuts, 10 sizes: 6-32" Thru 5/8"; 50-6-32", 50-8-32", 50-10-24", 25-10-32", 25-12-24", 75-1/4", 25-5/16", 30-3/8", 6-1/2", 3-5/8" | 1 | 6 | 2.60# |
|-----|-------|--|---|---|-------|

MACHINE SCREW KIT - TRUSS HEAD

PC 4760



FEATURES:

- Truss Head
- Phillips/Slotted
- Low Profile
- Zinc Plated

Dottie introduces the Truss Head Combo Assorted Machine Screw Kit. These Truss Head Machine Screws are needed when installing wiring devices behind wall plates. Great when a low profile fastener is needed.

| CAT. NO. | UPC | DESCRIPTION | STD | MSTR | WT/STD |
|----------|-------|---|-----|------|--------|
| 632TCS | 29658 | 370 Assorted 6-32 Slotted / Phillips Truss Head Machine Screws; 1/2" thru 2" 100-1/2", 75-3/4", 75-1", 50-1-1/4", 40-1-1/2", 30-2" | 1 | 6 | 1.59# |

FASTENER KITS

PC 4760

Dottie introduced assorted screw kits over 50 years ago and has a comprehensive variety for almost any imaginable need.

#6

| CAT. NO. | UPC | DESCRIPTION | STD MSTR WT/STD | | |
|----------|-------|---|-----------------|---|-------|
| 6PS | 15015 | 300 Assorted #6 Phillips/Slotted Pan Head Sheet Metal Screws: 1/2" Thru 2": 75-1/2", 75-3/4", 50-1", 40-1-1/4", 35-1-1/2", 25-2" | 1 | 6 | 1.24# |
| 6HX | 15012 | 300 Assorted #6 Slotted Hex Washer Head Sheet Metal Screws: 1/2" Thru 2": 75-1/2", 75-3/4", 50-1", 40-1-1/4", 35-1-1/2", 25-2" | 1 | 6 | 1.26# |
| 6TR | 15017 | 300 Assorted #6 Square-Drive Pan Head Sheet Metal Screws: 1/2" Thru 2": 75-1/2", 75-3/4", 50-1", 40-1-1/4", 35-1-1/2", 25-2" | 1 | 6 | 1.27# |



FEATURES:

- Reusable Six Compartment Box
- Handy Assortment

#8

| | | | | | |
|-----|-------|---|---|---|-------|
| 8PS | 15021 | 300 Assorted #8 Phillips/Slotted Pan Head Sheet Metal Screws: 1/2" Thru 2": 75-1/2", 75-3/4", 50-1", 40-1-1/4", 35-1-1/2", 25-2" | 1 | 6 | 1.75# |
| 8HX | 59254 | 300 Assorted #8 Hex/Phil/Slotted Head Sheet Metal Screws: 1/2" Thru 2": 75-1/2", 75-3/4", 50-1", 40-1-1/4", 35-1-1/2", 25-2" | 1 | 6 | 1.76# |
| 8TR | 59258 | 300 Assorted #8 Square-Drive Pan Head Sheet Metal Screws: 1/2" Thru 2": 75-1/2", 75-3/4", 50-1", 40-1-1/4", 35-1-1/2", 25-2" | 1 | 6 | 1.79# |

#10

| | | | | | |
|------|-------|--|---|---|-------|
| 10PS | 15031 | 210 Assorted #10 Phillips/Slotted Pan Head Sheet Metal Screws: 1/2" Thru 2": 60-1/2", 40-3/4", 35-1", 30-1-1/4", 25-1-1/2", 20-2" | 1 | 6 | 2.35# |
| 10HX | 59256 | 210 Assorted #10 Hex/Phil/Slotted Washer Sheet Metal Screws: 1/2" Thru 2": 60-1/2", 40-3/4", 35-1", 30-1-1/4", 25-1-1/2", 20-2" | 1 | 6 | 2.30# |
| 10TR | 59260 | 210 Assorted #10 Square-Drive Pan Head Sheet Metal Screws: 1/2" Thru 2": 60-1/2", 40-3/4", 35-1", 30-1-1/4", 25-1-1/2", 20-2" | 1 | 6 | 2.22# |

WALL PLATE SCREW KIT (12 COMPARTMENT BOX)

| | | | | | |
|------|-------|--|---|---|-------|
| APS1 | 27640 | 450 Assorted Wall Plate Screws 1/2" Lengths - 100 Ea: White & Ivory, 25 Ea: Almond, Stainless, Brass, Nylon; 3/4" Lengths - 25 Ea: White, Ivory & Almond; 1" Lengths - 25 Ea: White, Ivory & Almond | 1 | 6 | 1.57# |
|------|-------|--|---|---|-------|

WALL PLATE SCREW KIT (6 COMPARTMENT BOX)

| | | | | | |
|------|-------|---|---|---|-------|
| APS2 | 27642 | 450 Assorted Wall Plate Screws Ivory, White, & Almond: 50 - 5/16", 50 - 1/2", 30 - 3/4", 20 - 1" | 1 | 6 | 1.84# |
|------|-------|---|---|---|-------|

WOOD ROCKET KIT

| | | | | | |
|-----|-------|---|---|---|-------|
| WR6 | 15055 | 335 Assorted Wood Rockets 80-6 x 1", 70-6 x 1-1/8", 65-6 x 1-1/4", 45-6 x 1-5/8", 40-6 x 2", 35-6 x 2-1/4" | 1 | 6 | 2.17# |
|-----|-------|---|---|---|-------|

CONCRETE ANCHORING SYSTEM KIT

PC 4761

| CAT. NO. | UPC | DESCRIPTION | STD MSTR WT/STD | | |
|----------|-------|---|-----------------|---|-------|
| CK14 | 81517 | Hex Head Slotted - Blue Finish 20 - 14H114 1/4" x 1-1/4" 20 - 14H134 1/4" x 1-3/4" 20 - 14H214 1/4" x 2-1/4" | 1 | 6 | 1.55# |





SCREW & WASHER KITS

SELF DRILLING SCREW KITS

PC 4810



FEATURES:

- Installation Tool
- Reusable Six Compartment Box

Dottie introduced assorted screw kits over 50 years ago and has a comprehensive variety for almost any imaginable need.

#8

| CAT. NO. | UPC | DESCRIPTION | STD MSTR WT/STD | | |
|----------|-------|--|-----------------|---|-------|
| TK800 | 17705 | 240 Assorted Self Drilling Hex Head Screws: 75-8 x 1/2", 50-8 x 3/4", 40-8 x 1", 30-8 x 1-1/4", 25-8 x 1-1/2", 20-8 x 2", +1-MT8 Magnetic Driver | 1 | 6 | 1.50# |
| TK800DD | 17706 | 240 Assorted Self Drilling Square Drive Screws: 75-8 x 1/2", 50-8 x 3/4", 40-8 x 1", 30-8 x 1-1/4", 25-8 x 1-1/2", 20-8 x 2", +1-IB2 Insert Bit | 1 | 6 | 1.41# |
| TK800PH | 17707 | 240 Assorted Self Drilling Phillips Head Screw: 75-8 x 1/2", 50-8 x 3/4", 40-8 x 1", 30-8 x 1-1/4", 25-8 x 1-1/2", 20-8 x 2", +1-IB2P Insert Bit | 1 | 6 | 1.84# |

#10

| | | | | | |
|---------|-------|---|---|---|-------|
| TK100 | 17770 | 240 Assorted Self Drilling Hex Head Screws: 75-10 x 1/2", 50-10 x 3/4", 40-10 x 1", 30-10 x 1-1/4", 25-10 x 1-1/2", 20-10 x 2", +1-MT10 Magnetic Driver | 1 | 6 | 1.85# |
| TK100DD | 17701 | 240 Assorted Self Drilling Square Drive Screws: 75-10 x 1/2", 50-10 x 3/4", 40-10 x 1", 30-10 x 1-1/4", 25-10 x 1-1/2", 20-10 x 2", +1-IB2 Insert Bit | 1 | 6 | 1.85# |
| TK100PH | 17702 | 240 Assorted Self Drilling Phillips Head Screws: 75-10 x 1/2", 50-10 x 3/4", 40-10 x 1", 30-10 x 1-1/4", 25-10 x 1-1/2", 20-10 x 2", +1-IB2P Insert Bit | 1 | 6 | 1.84# |

#8 AND #10

| | | | | | |
|---------|-------|--|---|---|-------|
| TK810 | 17710 | 295 Assorted Self Drilling Hex Head Screws: 75-8 x 1/2", 50-8 x 3/4", 40-8 x 1", 50-10 x 1/2", 50-10 x 3/4", 30-10 x 1", + 1 Each; MT8 & MT10 Magnetic Drivers | 1 | 6 | 1.92# |
| TK810DD | 17711 | 330 Assorted Self Drilling Square Drive Screws: 75-8 x 1/2", 50-8 x 3/4", 40-8 x 1", 75-10 x 1/2", 50-10 x 3/4", 40-10 x 1", +1-IB2 Insert Bit | 1 | 6 | 1.90# |
| TK810PH | 17712 | 330 Assorted Self Drilling Phillips Head Screws: 75-8 x 1/2", 50-8 x 3/4", 40-8 x 1", 75-10 x 1/2", 50-10 x 3/4", 40-10 x 1", +1-IB2P Insert Bit | 1 | 6 | 1.86# |

WASHER KITS

PC 4760



FLAT WASHER KIT

| CAT. NO. | UPC | DESCRIPTION | STD MSTR WT/STD | | |
|----------|-------|--|-----------------|---|-------|
| FW2 | 15050 | Flat Washer Kit (2 pounds) #8 120 pcs, #10 120 pcs, 1/4" 60 pcs, 5/16" 30 pcs, 3/8" 85 pcs, 1/2" 6 pcs | 1 | 6 | 2.00# |

FENDER WASHER KIT

| | | | | | |
|-------|-------|--|---|---|-------|
| FENWK | 15539 | 120 Assorted Zinc Plated Fender Washers; 3 Sizes; 3/16 x 1-1/4", 1/4 x 1-1/4", 3/8 x 1-1/4" 40 Each Size | 1 | 6 | 2.54# |
|-------|-------|--|---|---|-------|

LOCK WASHER KIT

| | | | | | |
|-----|-------|---|---|---|-------|
| LWK | 31005 | 415 Assorted Zinc Plated Lock Washers; 6 Sizes: #8, #10, 1/4", 5/16", 3/8", 1/2", 100-#8, 100-#10, 100-1/4", 50-5/16", 40-3/8", 25-1/2" | 1 | 6 | 1.38# |
|-----|-------|---|---|---|-------|

ANCHORS & KITS

FITTINGS & STAMPINGS

SECTION

C

FITTINGS & STAMPINGS





FITTINGS & STAMPINGS

SECTION **C**



STAPLES

PC 5020, 5025

Staples are used to attach NMC (non metallic cable) or BX (armored) cable to wooden studs. The RX Series is used for Romex® and the BX Series is used for Romex® and BX. The SEU staple is used for service entrance cable and is available in 100 pack. For electro galvanized specify G (i.e.; RXG50, BXG or SEU63G). Plastic Insulated staples are used for coaxial cable, bell wire, thermostat wire, telephone wire and Romex®.

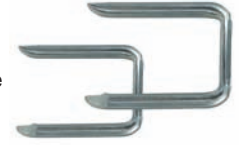

1/2" - 2 CONDUCTOR (#12 & #14) ROMEX® AND OTHER TYPE NM CABLE - PC 5020

| CAT. NO. | UPC | CABLE SIZE | SIZE (W X L) | GAUGE | STD | MSTR WT/STD |
|----------|-------|------------|--------------|-------|-------------|-------------|
| RX501 | 30710 | 14-2, 12-2 | 1/2 x 1" | 12 GA | 100 | 5000 |
| RX505 | 30715 | 14-2, 12-2 | 1/2 x 1" | 12 GA | 500 | 5000 |
| RX50B | 30720 | 14-2, 12-2 | 1/2 x 1" | 12 GA | 5000 | |
| RX503P | 30725 | 14-2, 12-2 | 1/2 x 1" | 12 GA | 10000(Pail) | |

9/16" - 3 CONDUCTOR (#10, #12 & #14) ROMEX®, BX, MC AND OTHER CABLE - PC 5020

| CAT. NO. | UPC | CABLE SIZE | SIZE (W X L) | GAUGE | STD | MSTR WT/STD |
|----------|-------|------------------|----------------|-------|------------|-------------|
| BX1001 | 27010 | 14-3, 12-3, 10-3 | 9/16 x 1-3/16" | 12 GA | 100 | 5000 |
| BX1005 | 27015 | 14-3, 12-3, 10-3 | 9/16 x 1-3/16" | 12 GA | 500 | 5000 |
| BX100B | 27020 | 14-3, 12-3, 10-3 | 9/16 x 1-3/16" | 12 GA | 5000 | |
| BX3P | 27025 | 14-3, 12-3, 10-3 | 9/16 x 1-3/16" | 12 GA | 7500(Pail) | |

SEU - PC 5025

| CAT. NO. | UPC | CABLE SIZE | SIZE (W X L) | GAUGE | STD | MSTR WT/STD |
|----------|-------|---------------------|----------------|-------|-----|-------------|
| SEU63 | 27130 | 6/3 SEU Cable | 13/16 x 1-3/8" | 12 GA | 100 | 1000 |
| SEU43 | 27135 | 4/3 & 2/3 SEU Cable | 1-1/8 x 1-1/2" | 12 GA | 100 | 1000 |

FEATURES:

- 12 Gauge Steel
- Rust Inhibitor
- Finger Friendly
- Boxed or in Pails
- Caution! Always Wear Eye Protection

STAPLES - ELECTRO GALVANIZED

PC 5022, 5024

1/2" - 2 CONDUCTOR (#12 & #14) ROMEX® AND OTHER TYPE NM CABLE - PC 5022

| CAT. NO. | UPC | CABLE SIZE | SIZE (W X L) | GAUGE | STD | MSTR WT/STD |
|----------|-------|------------|--------------|-------|-------------|-------------|
| RXG501 | 10530 | 14-2, 12-2 | 1/2 x 1" | 12 GA | 100 | 5000 |
| RXG505 | 10531 | 14-2, 12-2 | 1/2 x 1" | 12 GA | 500 | 5000 |
| RXG503P | 10532 | 14-2, 12-2 | 1/2 x 1" | 12 GA | 10000(Pail) | |

9/16" - 3 CONDUCTOR (#10, #12 & #14) ROMEX®, BX, MC AND OTHER CABLE - PC 5022

| CAT. NO. | UPC | CABLE SIZE | SIZE (W X L) | GAUGE | STD | MSTR WT/STD |
|----------|-------|------------------|----------------|-------|------------|-------------|
| BXG1001 | 10533 | 14-3, 12-3, 10-3 | 9/16 x 1-3/16" | 12 GA | 100 | 5000 |
| BXG1005 | 10534 | 14-3, 12-3, 10-3 | 9/16 x 1-3/16" | 12 GA | 500 | 5000 |
| BXG3P | 10535 | 14-3, 12-3, 10-3 | 9/16 x 1-3/16" | 12 GA | 7500(Pail) | |

SEU - PC 5024

| CAT. NO. | UPC | CABLE SIZE | SIZE (W X L) | GAUGE | STD | MSTR WT/STD |
|----------|-------|---------------------|----------------|-------|-----|-------------|
| SEU63G | 27131 | 6/3 SEU Cable | 13/16 x 1-3/8" | 12 GA | 100 | 1000 |
| SEU43G | 27136 | 4/3 & 2/3 SEU Cable | 1-1/8 x 1-1/2" | 12 GA | 100 | 1000 |

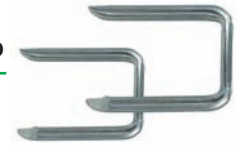

STAPLES & STRAPS - PLASTIC INSULATED

PC 5026



1/2" - 2 CONDUCTOR (#12 & #14) ROMEX® AND OTHER TYPE NM CABLE

| CAT. NO. | UPC | CABLE SIZE | SIZE (W X L) | COLOR | STD | MSTR WT/STD |
|----------|-------|------------|--------------|-------|------------|-------------|
| PLX501 | 27140 | 14-2, 12-2 | 1/2" | White | 100 | 1000 |
| PLX505 | 27142 | 14-2, 12-2 | 1/2" | White | 500 | 5000 |
| PLX50P | 27144 | 14-2, 12-2 | 1/2" | White | 4000(Pail) | |



9/16" - 3 CONDUCTOR (#10, #12 & #14) ROMEX®, BX, MC AND OTHER CABLE

| CAT. NO. | UPC | CABLE SIZE | SIZE (W X L) | COLOR | STD | MSTR WT/STD |
|----------|-------|------------------|--------------|-------|------------|-------------|
| PLX751 | 27146 | 14-3, 12-3, 10-3 | 3/4" | White | 100 | 1000 |
| PLX755 | 27148 | 14-3, 12-3, 10-3 | 3/4" | White | 500 | 5000 |
| PLX75P | 27150 | 14-3, 12-3, 10-3 | 3/4" | White | 3000(Pail) | |

CO-AXIAL STRAPS (USE WITH CO-AXIAL RG-6 & RG-59U)

| CAT. NO. | UPC | DESCRIPTION | SIZE (W X L) | COLOR | STD | MSTR WT/STD |
|----------|-------|---|--------------|-----------|-----|-------------|
| PLX250W | 10523 | Tuff Pack  | 1/4" | White | 500 | 3000 |
| PLX250B | 10539 | Tuff Pack  | 1/4" | Black(UV) | 500 | 3000 |

BELL, TELEPHONE & THERMOSTAT WIRE STRAPS

| CAT. NO. | UPC | DESCRIPTION | SIZE (W X L) | COLOR | STD | MSTR WT/STD |
|----------|-------|---|--------------|-----------|-----|-------------|
| PLX18W | 10540 | Tuff Pack  | 1/4 x 1/8" | White | 500 | 3000 |
| PLX18B | 10541 | Tuff Pack  | 1/4 x 1/8" | Black(UV) | 500 | 3000 |



FITTINGS & STAMPINGS



SAFETY PLATES, PLATE STRAPS & NAIL STRAPS

SAFETY PLATES

PC 5050, 5060



FEATURES:

- 16 Gauge Steel
- 20 Gauge Steel
- Nail Sharp Points
- Easy to Install
- Available in Boxes & Pails
- Caution! Always Wear Eye Protection

Steel safety plates are affixed to the face of 2" x 4" members to protect utility pipes and to prevent nails from penetrating into hidden live wires (NMC cable) which may be running through notches or through drilled holes in the stud.

PC 5050

| CAT. NO. | UPC | SIZE (W X L) | GAUGE | STD | MSTR | WT/STD |
|----------|-------|----------------|-------|------------|------|--------|
| 411 | 14100 | 1-1/2 x 2-3/4" | 16 | 100 | 1000 | 7.00# |
| 415 | 14105 | 1-1/2 x 2-3/4" | 16 | 500 | | 35.00# |
| 41P | 14116 | 1-1/2 x 2-3/4" | 16 | 500 (Pail) | | 35.00# |

PC 5060

| CAT. NO. | UPC | SIZE (W X L) | GAUGE | STD | MSTR | WT/STD |
|----------|-------|--------------|-------|-----|------|--------|
| 2516 | 14110 | 1-3/4 x 5" | 16 | 100 | | 16.00# |
| 2520 | 14115 | 1-3/4 x 5" | 20 | 100 | | 10.00# |
| 3516 | 14120 | 3 x 5" | 16 | 100 | | 26.80# |

Dottie guarantees these plates to be 16 ga (.0538 to .0658) as required by some codes. Dottie makes no warranty that these plates cannot be pierced by powder actuated / gas powered nail guns.

PLATE STRAPS

PC 5150



FEATURES:

- 12 Gauge Steel
- 16 Gauge Steel
- Various Lengths
- Caution! Always Wear Eye Protection

Plate straps are nailed across studs to restrain pipe between studs; installed over utility pipes & electrical wire that pass through framing members to prevent piercing.

12 GAUGE

| CAT. NO. | UPC | SIZE (W X L) | STD | MSTR | WT/STD |
|----------|-------|--------------|-----|------|--------|
| PS129 | 60010 | 1-1/2 x 9" | 50 | | 16.66# |
| PS1212 | 60012 | 1-1/2 x 12" | 50 | | 23.50# |
| PS1218 | 60014 | 1-1/2 x 18" | 50 | | 36.00# |
| PS1224 | 60016 | 1-1/2 x 24" | 50 | | 41.20# |

16 GAUGE

| CAT. NO. | UPC | SIZE (W X L) | STD | MSTR | WT/STD |
|----------|-------|--------------|-----|------|--------|
| PS169 | 60018 | 1-1/2 x 9" | 50 | | 9.14# |
| PS1612 | 60020 | 1-1/2 x 12" | 50 | | 15.40# |
| PS1618 | 60022 | 1-1/2 x 18" | 50 | | 19.58# |
| PS1624 | 60024 | 1-1/2 x 24" | 50 | | 28.50# |

NAIL STRAPS

PC 5070



FEATURES:

- 12 Gauge Steel
- Zinc Plated
- Available in Boxes & Pails
- Caution! Always Wear Eye Protection

Nail Straps are a stamped steel strap (J hook) which is nailed into studs to support tubing, pipe or E.M.T. Available in zinc, and in zinc plated with plastic coating.

ZINC PLATED

| CAT. NO. | UPC | SIZE | DESCRIPTION | STD | MSTR | WT/STD |
|----------|-------|------|-------------|-------------|------|--------|
| D1 | 27655 | 1/2" | Pipe | 100 | 1000 | 1.94# |
| D1P | 27658 | 1/2" | Pipe | 2000 (Pail) | | 39.90# |
| D2 | 27660 | 3/4" | Pipe | 100 | 1000 | 2.32# |
| D3 | 27665 | 1" | Pipe | 100 | 1000 | 2.63# |
| D11 | 27670 | 1/2" | E.M.T. | 100 | 1000 | 1.53# |
| D12 | 27675 | 3/4" | E.M.T. | 100 | 1000 | 1.99# |
| D13 | 27680 | 1" | E.M.T. | 100 | 1000 | 2.30# |

PLASTIC COATED NAIL STRAPS

PC 5090



ZINC PLATED W/ PLASTIC COATING

| CAT. NO. | UPC | SIZE | DESCRIPTION | STD | MSTR | WT/STD |
|----------|-------|--------|---------------|-----|------|--------|
| PL30 | 27110 | 1" | SER/SEU Cable | 50 | 500 | 1.30# |
| PL40 | 27112 | 1-1/4" | SER/SEU Cable | 50 | 500 | 1.55# |

PLUMBER'S TAPE

PC 5130, 5140

Plumber's Tape is 3/4" wide and is perforated with alternating size holes to accommodate nails or bolts. It is used to strap or support pipe, ducts & other fastening applications. Copper strap also used for grounding.

GALVANIZED STEEL - PC 5130

| CAT. NO. | UPC | LENGTH | GAUGE | STD | MSTR | WT/STD |
|----------|-------|-----------|-------|-----|------|--------|
| PT28 | 30945 | 3/4 x 10' | 28 | 100 | | 35.16# |
| PT26 | 30940 | 3/4 x 10' | 26 | 100 | | 46.24# |
| PT22 | 30935 | 3/4 x 10' | 22 | 50 | | 37.64# |

SOLID COPPER - PC 5140

| CAT. NO. | UPC | LENGTH | GAUGE | STD | MSTR | WT/STD |
|----------|-------|-----------|-------|-----|------|--------|
| CU10 | 27550 | 3/4 x 10' | 23 | 1 | 10 | 0.58# |
| CU25 | 27555 | 3/4 x 25' | 23 | 1 | 6 | 1.48# |
| CU50 | 27560 | 3/4 x 50' | 23 | 1 | 6 | 2.97# |



FEATURES:

- Galvanized Steel
- Solid Copper

HOOK ON CLIPS • HOOK ON STRAPS

PC 5110, 5120

Hook on Straps & Clips are used to secure pipe or tubing running parallel with studs. The hook on straps are nailed across two studs. The hook on clips with insulator snap into holes in the strap and tubing or pipe is then secured perpendicular to the strap.

12 GAUGE WIRE CLIP - PC 5110

| CAT. NO. | UPC | SIZE | STD | MSTR | WT/STD |
|----------|-------|-----------|-----|------|--------|
| HC50 | 27220 | 1/2" Pipe | 100 | 1000 | 1.66# |
| HC75 | 27225 | 3/4" Pipe | 100 | 1000 | 1.75# |

14 GAUGE STRAPS - PC 5120

| CAT. NO. | UPC | SIZE | STD | MSTR | WT/STD |
|----------|-------|------------|-----|------|--------|
| 5818 | 27230 | 18" Length | 100 | | 21.08# |
| 5826 | 27235 | 26" Length | 100 | | 30.58# |



FEATURES:

- Hook on Clips & Straps
- Formed Wire
- Supplied With Insulator
- Caution! Always Wear Eye Protection

PLASTIC COATED WIRE HANGER

PC 5100

Plastic Coated Wire Hangers are used to secure pipe or tubing transversing wood beams.

PLASTIC COATED

| CAT. NO. | UPC | SIZE | STD | MSTR | WT/STD |
|----------|-------|----------|-----|------|--------|
| PC346 | 27214 | 3/4 x 6" | 100 | 500 | 6.30# |



FEATURES:

- 10 Gauge Steel
- Plastic Coated
- Caution! Always Wear Eye Protection

ONE HOLE STRAPS

PC 5160



FEATURES:

- Zinc Plated Steel (After Fabrication)
- Inverted Rib For Strength
- For E.M.T./Pipe

One Hole Straps are used to secure cables, tubing, pipe or E.M.T. to a surface.

COAXIAL

| CAT. NO. | UPC | SIZE | GAUGE | STD | MSTR | WT/STD |
|----------|-------|------|-------|-----|------|--------|
| TW14 | 27745 | 1/4" | 18 GA | 100 | 1000 | 0.57# |

BX Accommodates 12-2, 12-3, 10-2, 10-3 BX

| | | | | | | |
|------|-------|------|-------|-----|------|-------|
| TW38 | 27750 | 3/8" | 18 GA | 100 | 1000 | 1.15# |
|------|-------|------|-------|-----|------|-------|

E.M.T.

| | | | | | | |
|-------|-------|--------|-------|-----|------|-------|
| TW50 | 27700 | 1/2" | 18 GA | 100 | 1000 | 2.22# |
| TW75 | 27705 | 3/4" | 18 GA | 100 | 1000 | 3.12# |
| TW100 | 27710 | 1" | 18 GA | 100 | 1000 | 3.45# |
| TW125 | 27715 | 1-1/4" | 15 GA | 100 | 1000 | 5.49# |
| TW150 | 27720 | 1-1/2" | 15 GA | 50 | 500 | 3.86# |
| TW200 | 27725 | 2" | 13 GA | 50 | 500 | 7.10# |

E.M.T. / PIPE

| | | | | | | |
|-------|-------|--------|------|----|-----|--------|
| TW250 | 27726 | 2-1/2" | 9 GA | 25 | 100 | 10.13# |
| TW300 | 27727 | 3" | 9 GA | 25 | 100 | 13.38# |
| TW350 | 27728 | 3-1/2" | 7 GA | 25 | 100 | 16.61# |
| TW400 | 27729 | 4" | 7 GA | 25 | 100 | 19.02# |

E.M.T. MEDIUM WEIGHT

| | | | | | | |
|--------|-------|------|-------|-----|------|-------|
| MTW50 | 27730 | 1/2" | 14 GA | 100 | 1000 | 3.62# |
| MTW75 | 27735 | 3/4" | 14 GA | 100 | 1000 | 4.17# |
| MTW100 | 27740 | 1" | 14 GA | 100 | 500 | 5.45# |

PIPE

| | | | | | | |
|-------|-------|--------|-------|-----|------|--------|
| HW50 | 27800 | 1/2" | 18 GA | 100 | 1000 | 2.53# |
| HW75 | 27805 | 3/4" | 18 GA | 100 | 1000 | 3.19# |
| HW100 | 27810 | 1" | 14 GA | 100 | 1000 | 6.66# |
| HW125 | 27815 | 1-1/4" | 13 GA | 50 | 500 | 5.49# |
| HW150 | 27820 | 1-1/2" | 11 GA | 50 | 500 | 8.36# |
| HW200 | 27825 | 2" | 11 GA | 50 | 500 | 10.66# |

PIPE MEDIUM WEIGHT

| | | | | | | |
|--------|-------|------|-------|-----|------|-------|
| MHW50 | 27830 | 1/2" | 14 GA | 100 | 1000 | 3.82# |
| MHW75 | 27835 | 3/4" | 14 GA | 100 | 1000 | 5.00# |
| MHW100 | 27840 | 1" | 14 GA | 100 | 1000 | 6.71# |

TWO HOLE STRAPS

PC 5200



FEATURES:

- Zinc Plated Steel (After Fabrication)
- Inverted Rib For Strength
- For E.M.T. / Pipe

Two hole straps are used to secure cables, tubing, pipe or E.M.T. to a surface.

E.M.T.

| CAT. NO. | UPC | SIZE | GAUGE | STD | MSTR | WT/STD |
|----------|-------|--------|-------|-----|------|--------|
| TW301 | 27300 | 1/2" | 22 GA | 250 | 1000 | 4.13# |
| TW302 | 27305 | 3/4" | 22 GA | 250 | 1000 | 4.67# |
| TW303 | 27310 | 1" | 22 GA | 250 | 1000 | 8.24# |
| TW304 | 27315 | 1-1/4" | 20 GA | 100 | 500 | 4.45# |
| TW305 | 27320 | 1-1/2" | 20 GA | 100 | 500 | 4.83# |
| TW306 | 27325 | 2" | 20 GA | 50 | 250 | 3.11# |

PIPE

| | | | | | | |
|-------|-------|--------|-------|-----|------|-------|
| HW400 | 27900 | 3/8" | 22 GA | 250 | 1000 | 4.64# |
| HW401 | 27905 | 1/2" | 22 GA | 250 | 1000 | 4.70# |
| HW402 | 27910 | 3/4" | 22 GA | 250 | 1000 | 5.33# |
| HW403 | 27915 | 1" | 20 GA | 100 | 1000 | 3.82# |
| HW404 | 27920 | 1-1/4" | 20 GA | 100 | 500 | 4.74# |
| HW405 | 27925 | 1-1/2" | 20 GA | 100 | 500 | 5.30# |
| HW406 | 27930 | 2" | 18 GA | 50 | 500 | 4.32# |
| HW407 | 27935 | 2-1/2" | 15 GA | 25 | 250 | 4.96# |
| HW408 | 27940 | 3" | 15 GA | 25 | 250 | 5.64# |
| HW409 | 27945 | 3-1/2" | 15 GA | 10 | 50 | 3.44# |
| HW410 | 27950 | 4" | 15 GA | 10 | 50 | 3.72# |

CONDUIT HANGERS WITH BOLTS

PC 5220

Conduit hangers are used for supporting conduit or PVC from overhead applications.

| CAT. NO. | UPC | PIPE | E.M.T. | GAUGE | BOLT SIZE | STD | MSTR | WT/STD |
|----------|-------|-----------|--------|-------|-----------------|-----|------|--------|
| PH50B | 28320 | 3/8 -1/2" | 1/2" | 18 GA | 1/4-20 x 1" | 100 | | 4.33# |
| PH75B | 28322 | 3/4" | 3/4" | 18 GA | 1/4-20 x 1-1/4" | 100 | | 6.12# |
| PH100B | 28324 | 1" | 1" | 18 GA | 1/4-20 x 1-1/4" | 100 | | 6.71# |
| PH110B | 28326 | - | 1-1/4" | 18 GA | 1/4-20 x 1-1/4" | 100 | | 1.91# |
| PH125B | 28328 | 1-1/4" | 1-1/2" | 18 GA | 1/4-20 x 1-1/2" | 100 | | 9.18# |
| PH150B | 28330 | 1-1/2" | - | 16 GA | 1/4-20 x 1-1/2" | 100 | | 13.88# |
| PH200B | 28332 | 2" | 2" | 16 GA | 1/4-20 x 1-1/2" | 50 | | 11.39# |
| PH250B | 28334 | 2-1/2" | 2-1/2" | 16 GA | 1/4-20 x 1-1/2" | 50 | | 12.07# |
| PH300B | 28336 | 3" | 3" | 16 GA | 1/4-20 x 1-1/2" | 25 | | 7.45# |
| PH350B | 28337 | 3-1/2" | - | 16 GA | 1/4-20 x 2" | 25 | | 8.95# |
| PH400B | 28338 | 4" | - | 16 GA | 1/4-20 x 2" | 25 | | 9.80# |



FEATURES:

- Zinc Plated Steel (After Fabrication)
- Assembled With Combo Round Head Screws and Hex Nuts
- For E.M.T. & Pipe

CONDUIT HANGERS-STAINLESS STEEL WITH STAINLESS STEEL BOLT

PC 5221

Conduit hangers are used for supporting conduit or PVC from overhead applications. Stainless Steel dramatically improves corrosion resistance.

| CAT. NO. | UPC | PIPE | E.M.T. | GAUGE | BOLT SIZE | STD | MSTR | WT/STD |
|----------|-------|-----------|--------|-------|-----------------|-----|------|--------|
| PH50BSS | 81497 | 3/8 -1/2" | 1/2" | 18 GA | 1/4-20 x 1" | 10 | 100 | 0.43# |
| PH75BSS | 81498 | 3/4" | 3/4" | 18 GA | 1/4-20 x 1-1/4" | 5 | 50 | 0.36# |
| PH100BSS | 81499 | 1" | 1" | 18 GA | 1/4-20 x 1-1/4" | 5 | 50 | 0.33# |
| PH110BSS | 81500 | - | 1-1/4" | 18 GA | 1/4-20 x 1-1/4" | 2 | 20 | 0.38# |
| PH125BSS | 81501 | 1-1/4" | 1-1/2" | 18 GA | 1/4-20 x 1-1/2" | 2 | 20 | 0.48# |
| PH150BSS | 81502 | 1-1/2" | - | 16 GA | 1/4-20 x 1-1/2" | 2 | 20 | 0.27# |
| PH200BSS | 81503 | 2" | 2" | 16 GA | 1/4-20 x 1-1/2" | 2 | 20 | 0.45# |
| PH250BSS | 81504 | 2-1/2" | 2-1/2" | 16 GA | 1/4-20 x 1-1/2" | 2 | 20 | 0.48# |
| PH300BSS | 81505 | 3" | 3" | 16 GA | 1/4-20 x 1-1/2" | 2 | 20 | 0.59# |
| PH350BSS | 81506 | 3-1/2" | - | 16 GA | 1/4-20 x 2" | 2 | 20 | 0.72# |
| PH400BSS | 81507 | 4" | - | 16 GA | 1/4-20 x 2" | 2 | 20 | 0.78# |



FEATURES:

- 301 Stainless Steel
- Stainless Steel Bolts and Nuts
- For E.M.T. & Pipe

TECH TALK



ZINC CHROMATE Plating is the most widely used plating. Zinc is popular as a fastener coating because it is the least expensive and can be applied to a broad range of thicknesses. It has good to excellent corrosion resistance and is relatively non toxic.

STAINLESS STEEL Is a family of ferrous alloys, each with a minimum chromium content of 12 percent. Chromium is a non-corrodible element; consequently, all stainless steels have a high degree of corrosion resistance. Generally, the higher the chromium content, the better the corrosion resistance.



STRUT CLAMPS, CHANNEL NUTS & U-BOLT BEAM CLAMPS

STRUT CLAMPS

PC 5391



One tool is all you need with our Universal Strut Clamps thanks to the welded stud that allows for a quick and easy installation. Includes keps nut, and the clamps come assembled to make sure you never lose any parts. Electrogalvanized is the standard finish.

| CAT. NO. | UPC | SIZE | DESCRIPTION | STD | MSTR | WT/STD |
|----------|-------|--------|------------------------|-----|------|--------|
| SC50U | 81707 | 1/2" | Universal Strut Clamps | 50 | | 5.5# |
| SC75U | 81708 | 3/4" | Universal Strut Clamps | 50 | | 6.0# |
| SC100U | 81709 | 1" | Universal Strut Clamps | 50 | | 7.5# |
| SC125U | 81710 | 1-1/4" | Universal Strut Clamps | 50 | | 9.0# |
| SC150U | 81711 | 1-1/2" | Universal Strut Clamps | 50 | | 10.0# |
| SC200U | 81712 | 2" | Universal Strut Clamps | 50 | | 11.0# |

E.M.T. Strut Clamps come assembled with a keps nut and slotted hex head bolt to make sure you never lose a part. Electrogalvanized is the standard finish.

| CAT. NO. | UPC | SIZE | DESCRIPTION | STD | MSTR | WT/STD |
|----------|-------|--------|---------------------|-----|------|--------|
| SC50E | 81713 | 1/2" | E.M.T. Strut Clamps | 100 | | 11.0# |
| SC75E | 81714 | 3/4" | E.M.T. Strut Clamps | 100 | | 12.0# |
| SC100E | 81715 | 1" | E.M.T. Strut Clamps | 100 | | 15.0# |
| SC125E | 81716 | 1-1/4" | E.M.T. Strut Clamps | 50 | | 7.5# |
| SC150E | 81717 | 1-1/2" | E.M.T. Strut Clamps | 50 | | 14.5# |
| SC200E | 81718 | 2" | E.M.T. Strut Clamps | 50 | | 16.5# |

Rigid Strut Clamps come assembled with a keps nut and slotted hex head bolt to make sure you never lose a part. Electrogalvanized is the standard finish. Also available are Stainless Steel Ridge Strut Clamps Type 304 or 316, quoted upon request.

| CAT. NO. | UPC | SIZE | DESCRIPTION | STD | MSTR | WT/STD |
|----------|-------|--------|--------------------|-----|------|--------|
| SC50R | 81719 | 1/2" | Rigid Strut Clamps | 100 | | 11.0# |
| SC75R | 81720 | 3/4" | Rigid Strut Clamps | 100 | | 15.0# |
| SC100R | 81721 | 1" | Rigid Strut Clamps | 100 | | 17.0# |
| SC125R | 81722 | 1-1/4" | Rigid Strut Clamps | 50 | | 9.5# |
| SC150R | 81723 | 1-1/2" | Rigid Strut Clamps | 50 | | 14.5# |
| SC200R | 81724 | 2" | Rigid Strut Clamps | 50 | | 17.0# |
| SC250R | 81725 | 2-1/2" | Rigid Strut Clamps | 25 | | 10.0# |
| SC300R | 81726 | 3" | Rigid Strut Clamps | 25 | | 11.8# |
| SC350R | 81727 | 3-1/2" | Rigid Strut Clamps | 50 | | 31.0# |
| SC400R | 81728 | 4" | Rigid Strut Clamps | 50 | | 33.5# |
| SC500R | 81729 | 5" | Rigid Strut Clamps | 25 | | 20.0# |
| SC600R | 81730 | 6" | Rigid Strut Clamps | 25 | | 25.2# |

CHANNEL NUTS & U-BOLT BEAM CLAMPS

PC 5392



Channel Nuts are formed or stamped from steel bar stock and are case hardened after all forming and tapping operations have been completed. The nuts are then coated with zinc for an electrogalvanize finish. Sizes are also available in type 316 stainless steel, quoted upon request.

| CAT. NO. | UPC | SIZE | DESCRIPTION | STD | MSTR | WT/STD |
|----------|-------|------|----------------------------|-----|------|--------|
| SSN25 | 81731 | 1/4" | Standard Spring Nut | 100 | | 7.5# |
| SSN38 | 81732 | 3/8" | Standard Spring Nut | 100 | | 10.0# |
| SSN50 | 81733 | 1/2" | Standard Spring Nut | 100 | | 11.5# |
| SSN25S | 81734 | 1/4" | Short Spring Nut | 100 | | 7.5# |
| SSN38S | 81735 | 3/8" | Short Spring Nut | 100 | | 9.0# |
| SSN50S | 81736 | 1/2" | Short Spring Nut | 100 | | 8.2# |
| SCN25 | 81737 | 1/4" | Channel Nut Without Spring | 100 | | 6.5# |
| SCN38 | 81738 | 3/8" | Channel Nut Without Spring | 100 | | 9.0# |
| SCN50 | 81739 | 1/2" | Channel Nut Without Spring | 100 | | 10.6# |

U-Bolt Beam clamps are made from cold formed steel and conform to all tolerances listed in section 5.3 of the metal framing standards publication.

| CAT. NO. | UPC | SIZE | DESCRIPTION | STD | MSTR | WT/STD |
|----------|-------|-----------------|-----------------------------|-----|------|--------|
| SUB158 | 81767 | 1-5/8" x 1-5/8" | U-Bolt Beam Clamp for Strut | 25 | | 20.5# |
| SUB325 | 81768 | 1-5/8" x 3-1/4" | U-Bolt Beam Clamp for Strut | 25 | | 23.0# |



FITTINGS & STAMPINGS

FLAT PLATE FITTINGS

PC 5393

Flat Plate Strut Fittings are made from cold formed steel and conform to all tolerances listed in section 5.3 of Metal Framing Standards Publication No. MFMA-1. Standard finish is electrogalvanized. Stainless steel types 304 and 316 quoted upon request.

| CAT. NO. | UPC | SIZE/TYPE | DESCRIPTION | STD | MSTR | WT/STD |
|----------|-------|-----------|----------------------|-----|------|--------|
| SQW516 | 81740 | 5/16" | Square Washer | 100 | | 18.0# |
| SQW38 | 81741 | 3/8" | Square Washer | 100 | | 18.0# |
| SQW50 | 81742 | 1/2" | Square Washer | 100 | | 18.0# |
| SQW58 | 81743 | 5/8" | Square Washer | 100 | | 17.0# |
| SFP2 | 81744 | 2 Hole | Flat Plate Fitting | 50 | | 19.0# |
| SFP3 | 81745 | 3 Hole | Flat Plate Fitting | 50 | | 29.0# |
| SFP4 | 81746 | 4 Hole | Flat Plate Fitting | 25 | | 19.5# |
| SFPL3 | 81747 | 3 Hole | Flat L Plate Fitting | 50 | | 31.0# |
| SFPT4 | 81748 | 4 Hole | Flat T Plate Fitting | 25 | | 20.0# |
| SFPC5 | 81749 | 5 Hole | Cross Plate Fitting | 15 | | 14.2# |

FEATURES:

- Flat Plate Fittings
- Cold Formed Steel
- Electrogalvanized
- Available In Stainless



ANGLE FITTINGS

PC 5394

Angle Strut Fittings are made from cold formed steel and conform to all tolerances listed in section 5.3 of Metal Framing Standards Publication No. MFMA-1. Standard finish is electrogalvanized. Stainless steel types 304 and 316 quoted upon request.

| CAT. NO. | UPC | TYPE | DESCRIPTION | STD | MSTR | WT/STD |
|----------|-------|--------|-------------------------------|-----|------|--------|
| SAF290 | 81750 | 2 Hole | Bent 90° Angle Fitting | 50 | | 19.0# |
| SAF390 | 81751 | 3 Hole | Bent 90° Angle Fitting | 50 | | 29.0# |
| SAF490 | 81752 | 4 Hole | Bent 90° Angle Fitting | 25 | | 19.5# |
| SAFU690 | 81753 | 6 Hole | Universal 90° Angle Fitting | 15 | | 21.9# |
| SAF245 | 81754 | 2 Hole | Bent 45° Open Angle Fitting | 50 | | 25.0# |
| SAF245C | 81755 | 2 Hole | Bent 45° Closed Angle Fitting | 25 | | 14.5# |
| SAF445 | 81756 | 4 Hole | Bent 45° Open Angle Fitting | 15 | | 15.0# |
| SAF445C | 81757 | 4 Hole | Bent 45° Closed Angle Fitting | 25 | | 19.5# |



ZEE FITTINGS, U FITTINGS & POST BASES

PC 5395

Zee and U-shaped fittings, Post Bases are made from cold formed steel and conform to all tolerances listed in section 5.3 of Metal Framing Standards Publication No. MFMA-1. Standard finish is electrogalvanized. Stainless steel types 304 and 316 quoted upon request.

ZEE FITTINGS AND U FITTINGS

| CAT. NO. | UPC | SIZE/TYPE | DESCRIPTION | STD | MSTR | WT/STD |
|----------|-------|-----------|---------------------------|-----|------|--------|
| SZFDS | 81758 | - | Zee Fitting Deep Strut | 50 | | 27.5# |
| SZFSS | 81759 | - | Zee Fitting Shallow Strut | 50 | | 23.5# |
| SUFDS | 81760 | - | U Fitting Deep Strut | 15 | | 13.2# |
| SUFSS | 81761 | - | U Fitting Shallow Strut | 25 | | 17.7# |

POST BASES

| | | | | | | |
|---------|-------|---------|-----------------------------------|----|--|-------|
| SPB890 | 81762 | 8 Hole | Single Channel Tall Clevis | 10 | | 28.7# |
| SPB1045 | 81763 | 10 Hole | Single Channel Tall Clevis | 10 | | 37.2# |
| SPB1090 | 81764 | 10 Hole | Single Channel Tall Clevis Square | 10 | | 37.2# |
| SPB1245 | 81765 | 12 Hole | Double Channel Tall Clevis | 10 | | 40.0# |
| SPB1290 | 81766 | 12 Hole | Double Channel Tall Clevis Square | 10 | | 40.0# |





ROOF JACKS & TIE WIRE

STANDARD-ROOF JACKS

PC 5230



Roof Jacks are applied to the roof to form a water-tight seal. They add additional support between the roof line and service entrance conduit or ventilation pipe.

FEATURES:

- 28 Gauge Steel
- Galvanized Steel
- Available in Stainless Copper

| CAT. NO. | UPC | PIPE SIZE | BASE SIZE | STD | MSTR | WT/STD |
|----------|-------|-----------|---------------|-----|------|--------|
| RJ50 | 69600 | 1/2" | 11" x 13" | 12 | | 24.08# |
| RJ75 | 69605 | 3/4" | 11" x 13" | 12 | | 23.92# |
| RJ100 | 69610 | 1" | 11" x 13" | 12 | | 23.06# |
| RJ125 | 69615 | 1-1/4" | 11" x 13" | 12 | | 23.13# |
| RJ150 | 69620 | 1-1/2" | 11" x 13" | 12 | | 22.87# |
| RJ200 | 69625 | 2" | 11" x 13" | 12 | | 21.82# |
| RJ300 | 69630 | 3" | 12-1/2" x 15" | 12 | | 15.22# |
| RJ400 | 69635 | 4" | 12-1/2" x 15" | 12 | | 19.39# |

3 IN 1 ROOF JACKS

PC 5250



Roof Jacks are applied to the roof to form a water-tight seal. They add additional support between the roof line and service entrance conduit or ventilation pipe.

FEATURES:

- 24 Gauge Steel
- Elastomer Collar

| CAT. NO. | UPC | PIPE SIZE | BASE SIZE | STD | MSTR | WT/STD |
|----------|-------|------------------------|-------------------|-----|------|--------|
| RN3 | 10350 | 1/2", 3/4", 1" * | 8-3/4", 12-1/2" | 12 | | 11.95# |
| RN4 | 10352 | 1-1/2", 2", 2-1/2", 3" | 10-3/4" x 12-1/2" | 12 | | 18.82# |

*Can be modified to fit 1-1/4" pipe, Fits any roof pitch - from flat to 45°
Tested for ultraviolet, ozone, and weather resistance.

STEEL/GALVANIZED-TIRE WIRE

PC 5030, 5035



Tie wire is used for many purposes, among them tying down PVC conduit in trenches before pouring concrete, as well as drop ceiling applications.

FEATURES:

- 16 1/2 Gauge
- 400 Ft. (3-1/2#)
- Black Annealed or Galvanized

BLACK ANNEALED - PC 5030

| CAT. NO. | UPC | STD | MSTR | WT/STD |
|----------|-------|-----|------|--------|
| TY164 | 28170 | 20 | | 71.10# |

GALVANIZED - PC 5035

| CAT. NO. | UPC | STD | MSTR | WT/STD |
|----------|-------|-----|------|--------|
| VTYG | 28180 | 20 | | 68.35# |

FITTINGS & STAMPINGS

TECH TALK



**DOTTIE
PIPE
SUPPORT
#DPS**

**DUAL
CHANNEL
TECHNOLOGY**



See page C27 For More info

BEAM CLAMPS - STEEL & MALLEABLE

PC 5260, 5265

Beam Clamps when secured to an I-beam, girder or other structural member, provide a mounting base for the attachment of conduit hangers, either directly or by using threaded rod.

STEEL - PC 5260

| CAT. NO. | UPC | SIZE | TYPE | STD | MSTR | WT/STD |
|----------|-------|--------|-------|-----|------|--------|
| BK14 | 10090 | 1/4-20 | Steel | 50 | 250 | 6.03# |
| BK38 | 10095 | 3/8-16 | Steel | 25 | 100 | 6.62# |

MALLEABLE - PC 5265

| CAT. NO. | UPC | SIZE | TYPE | STD | MSTR | WT/STD |
|----------|-------|--------|-----------|-----|------|--------|
| BK14M | 10092 | 1/4-20 | Malleable | 50 | 250 | 11.44# |
| BK38M | 10097 | 3/8-16 | Malleable | 25 | 100 | 18.22# |
| BK50M | 10099 | 1/2-13 | Malleable | 10 | 50 | 12.96# |



FEATURES:

- Zinc Plated Steel & High Strength Malleable Iron
- Case Hardened Steel Bolt
- Tapped Threads Back & Bottom

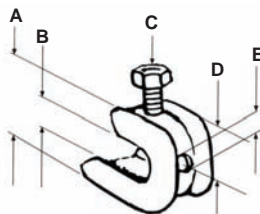

| | A | B | C | D | E* |
|-------|------|-------|---------------|------|--------|
| BK14 | 1.39 | .672 | 1/4 x 1" | .695 | 1/4-20 |
| BK14M | 1.39 | .750 | 5/16 x 1" | .625 | 1/4-20 |
| BK38 | 1.95 | .781 | 5/16 x 1 3/8" | .979 | 3/8-16 |
| BK38M | 1.75 | .875 | 3/8 x 1 1/4" | .625 | 3/8-16 |
| BK50M | 2.47 | 1.109 | 3/8 x 1 1/2" | .812 | 1/2-13 |

* Bottom & Back

FLOOR FLANGES

PC 5270

Floor flanges are secured to floors or walls and threaded conduit is then inserted as a post or divider.

| CAT. NO. | UPC | SIZE | STD | MSTR | WT/STD |
|----------|-------|--------|-----|------|--------|
| FF50 | 60350 | 1/2" | 25 | | 6.79# |
| FF75 | 60351 | 3/4" | 25 | | 7.64# |
| FF100 | 60352 | 1" | 10 | | 4.50# |
| FF125 | 60353 | 1-1/4" | 5 | | 3.15# |
| FF150 | 60354 | 1-1/2" | 5 | | 3.85# |
| FF200 | 60355 | 2" | 5 | | 6.46# |



FEATURES:

- High Strength Malleable Iron
- Zinc Plated

SWITCH BOX SUPPORTS

PC 5290

Switch box supports are used in pairs in old work. The tongues are bent over the lip of the box and the bar is inserted into the opening to prevent the box from falling back out of the opening. The ears of the box keep it from falling into the opening.

| CAT. NO. | UPC | DESCRIPTION | STD | MSTR | WT/STD |
|----------|-------|------------------------|----------|----------|--------|
| SBS165 | 59850 | Galvanized Box Support | 100 Pair | 500 Pair | 5.30# |



FEATURES:

- Quick Installation
- Supports Box, No Stud Needed
- Prevents Box Pull Out
- Galvanized Steel

CEILING COVER PLATE

PC 5280

Ceiling cover plates, 5 1/4" canopy with adjustable strap and screws for 3" or 4" outlet boxes. White color blends with most installations. Temporary or permanent.

| CAT. NO. | UPC | SIZE | DESCRIPTION | STD | MSTR | WT/STD |
|----------|-------|--------|-----------------------------|-----|------|--------|
| CP5 | 27545 | 5-1/4" | White Universal Cover Plate | 1 | 50 | 0.14# |



FEATURES:

- Steel
- White
- Adjustable Strap For 3" & 4" Boxes

REDUCING BUSHINGS

PC 5430



FEATURES:

- Zinc Plated Steel
- High Strength Malleable Iron

Reducing bushings are used with rigid / IMC conduit to reduce the size of a threaded opening to accept a smaller size conduit.

| CAT. NO. | UPC | | SIZE | STD | MSTR | WT/STD |
|----------|-------|------------|----------------|-----|-------|--------|
| R351 | 30500 | Steel | 1/2 x 3/8" | 100 | 1000 | 2.40# |
| R352 | 30505 | | 3/4 x 1/2" | 100 | 1000 | 5.00# |
| R353 | 30510 | | 1 x 1/2" | 50 | 500 | 5.88# |
| R354 | 30515 | | 1 x 3/4" | 50 | 500 | 6.77# |
| R355 | 30520 | | 1-1/4 x 1/2" | 25 | 250 | 3.44# |
| R356 | 30525 | | 1-1/4 x 3/4" | 25 | 250 | 5.33# |
| R357 | 30530 | | 1-1/4 x 1" | 25 | 250 | 3.70# |
| R358 | 30535 | | 1-1/2 x 1/2" | 25 | 250 | 10.06# |
| R359 | 30540 | | 1-1/2 x 3/4" | 25 | 250 | 8.25# |
| R360 | 30545 | | 1-1/2 x 1" | 25 | 250 | 6.45# |
| R361 | 30550 | | 1-1/2 x 1-1/4" | 25 | 250 | 2.78# |
| R362 | 30555 | | 2 x 1/2" | 10 | 100 | 8.18# |
| R363 | 30560 | | 2 x 3/4" | 10 | 100 | 7.34# |
| R364 | 30565 | | 2 x 1" | 10 | 100 | 6.50# |
| R365 | 30570 | 2 x 1-1/4" | 10 | 100 | 4.81# | |
| R366 | 30575 | Iron | 2 x 1-1/2" | 10 | 100 | 3.27# |
| R367 | 30576 | | 2-1/2 x 2" | 1 | 10 | 0.60# |
| R368 | 30577 | | 3 x 2" | 1 | 10 | 1.04# |
| R369 | 30578 | | 3 x 2-1/2" | 1 | 10 | 1.22# |
| R370 | 30579 | | 3-1/2 x 2" | 1 | 10 | 1.39# |
| R371 | 30580 | | 3-1/2 x 2-1/2" | 1 | 10 | 1.48# |
| R372 | 30581 | | 3-1/2 x 3" | 1 | 10 | 1.17# |
| R373 | 30582 | | 4 x 2" | 1 | 10 | 3.62# |
| R374 | 30583 | | 4 x 2-1/2" | 1 | 10 | 1.95# |
| R375 | 30584 | | 4 x 3" | 1 | 10 | 1.64# |
| R376 | 30585 | 4 x 3-1/2" | 1 | 10 | 1.28# | |

PLASTIC BUSHINGS

PC 5670



FEATURES:

- UL Listed
- Thermoplastic
- 105° C
- Fits Rigid Conduit

Plastic bushings are threaded onto the end of conduit and are used to protect wires coming through the conduit.

| CAT. NO. | UPC | | SIZE | STD | MSTR | WT/STD |
|----------|-------|--|--------|-----|------|--------|
| PB50 | 10100 | | 1/2" | 100 | 1000 | 0.49# |
| PB75 | 10105 | | 3/4" | 100 | 1000 | 0.64# |
| PB100 | 10110 | | 1" | 50 | 500 | 0.58# |
| PB125 | 10115 | | 1-1/4" | 25 | 250 | 0.44# |
| PB150 | 10120 | | 1-1/2" | 25 | 250 | 0.50# |
| PB200 | 10125 | | 2" | 25 | 250 | 0.74# |
| PB250 | 10130 | | 2-1/2" | 25 | 250 | 1.32# |
| PB300 | 10135 | | 3" | 25 | 250 | 1.55# |
| PB350 | 10140 | | 3-1/2" | 10 | 100 | 0.85# |
| PB400 | 10145 | | 4" | 10 | 100 | 0.98# |
| PB500 | 10150 | | 5" | 10 | 10 | 2.93# |
| PB600 | 10155 | | 6" | 10 | 10 | 3.85# |

EMT BUSHINGS

PC 5675



FEATURES:

- Stay-In-Place Design
- Engineered Plastic
- Color: White

EMT Insulating Bushings protect cables from abrasion. Use where nonmetallic low voltage cabling is installed in EMT.

| CAT. NO. | UPC | | SIZE | STD | MSTR | WT/STD |
|----------|-------|--|--------|-----|------|--------|
| EMTB50 | 81613 | | 1/2" | 100 | 1000 | 0.40# |
| EMTB75 | 81614 | | 3/4" | 50 | 500 | 0.25# |
| EMTB100 | 81615 | | 1" | 25 | 250 | 0.23# |
| EMTB125 | 81616 | | 1-1/4" | 25 | 250 | 0.27# |
| EMTB150 | 81617 | | 1-1/2" | 25 | 250 | 0.35# |
| EMTB200 | 81618 | | 2" | 25 | 250 | 0.55# |
| EMTB250 | 81619 | | 2-1/2" | 25 | 100 | 1.40# |
| EMTB300 | 81620 | | 3" | 25 | 100 | 1.30# |
| EMTB350 | 81621 | | 3-1/2" | 25 | 100 | 2.10# |
| EMTB400 | 81622 | | 4" | 25 | 100 | 3.20# |

NYLON KO BUSHINGS

PC 6100

Nylon KO bushings are snapped into punched holes in panels to protect wires from the rough edges.

| CAT. NO. | UPC | SIZE | STD | MSTR | WT/STD |
|----------|-------|--------|-----|------|--------|
| 1210D | 12100 | 1/2" | 100 | 1000 | 0.45# |
| 1211D | 12110 | 3/4" | 100 | 1000 | 0.66# |
| 1212D | 12120 | 1" | 100 | 1000 | 0.99# |
| 1213D | 12130 | 1-1/4" | 50 | 500 | 0.70# |
| 1214D | 12140 | 1-1/2" | 25 | 250 | 0.46# |
| 1215D | 12150 | 2" | 25 | 250 | 0.93# |
| 1216D | 12160 | 2-1/2" | 25 | 250 | 1.20# |



FEATURES:

- 105° C
- Snap In
- Reusable

ANTI-SHORT BUSINGS

PC 5680

Anti-Short bushings are used to protect wire insulation from the jagged or sharp cut edges of BX or flex. Priced per 100 pieces.

| CAT. NO. | UPC | FLEX | CABLE SIZE | PKG | STD | MSTR | WT/STD |
|----------|-------|-------|-------------------------|-----|------|------|--------|
| 0 | 11600 | 5/16" | 14/2, 14/3, 12/2 | 100 | 1000 | | 0.75# |
| 1 | 11601 | 3/8" | 14/4, 6/1, 4/1, 12/3 | 100 | 1000 | | 0.30# |
| 2 | 11602 | 7/16" | 12/4, 10/2, 10/3, 2/1 | 50 | 500 | | 0.35# |
| 3 | 11603 | 1/2" | 10/4, 8/2, 8/3, 1/1 | 50 | 500 | | 0.40# |
| 4 | 11604 | 3/4" | 8/4, 6/2, 6/3, 4/2, 4/3 | 50 | 500 | | 0.40# |



FEATURES:

- Plastic
- Fits Armored Cable
- Prevents Shorts

K.O. SEALS

PC 5440

Snap in K.O. seals are used to seal up holes punched in panels or knockouts from outlet boxes. They are held in place by spring tension. Available in sizes from 1/2" thru 2".

| CAT. NO. | UPC | SIZE | STD | MSTR | WT/STD |
|----------|-------|--------|-----|------|--------|
| KO50 | 16000 | 1/2" | 100 | 1000 | 1.44# |
| KO75 | 16010 | 3/4" | 100 | 1000 | 1.62# |
| KO100 | 16020 | 1" | 100 | 1000 | 2.10# |
| KO125 | 16030 | 1-1/4" | 50 | 500 | 1.45# |
| KO150 | 16040 | 1-1/2" | 50 | 500 | 2.14# |
| KO200 | 16050 | 2" | 25 | 250 | 1.44# |



FEATURES:

- Snap In
- Steel
- Zinc Plated

THREE PIECE K.O. SEALS

PC 5450

Three piece K.O. seals are used to seal up holes punched in panels or knockouts from outlet boxes. They are held in place by a screw inserted through the seal into a threaded strap on the opposite side of the opening. Available in sizes from 1/2" thru 6". Three piece K.O. seals are embossed to centralize in knockout. Installs from the inside or outside of any box without rearranging wires. One screw secures unit. Size is stamped onto seal.

| CAT. NO. | UPC | SIZE | STD | MSTR | WT/STD |
|----------|-------|--------|-----|------|--------|
| D10S | 10240 | 1/2" | 100 | 1000 | 2.62# |
| D20S | 10242 | 3/4" | 50 | 500 | 1.73# |
| D30S | 10244 | 1" | 25 | 250 | 1.33# |
| D40S | 10246 | 1-1/4" | 25 | 250 | 1.74# |
| D50S | 10248 | 1-1/2" | 10 | 100 | 1.03# |
| D60S | 10250 | 2" | 10 | 100 | 1.46# |
| D70S | 10252 | 2-1/2" | 10 | 100 | 2.16# |
| D80S | 10254 | 3" | 10 | 100 | 3.11# |
| D90S | 10256 | 3-1/2" | 10 | 100 | 3.97# |
| D100S | 10258 | 4" | 10 | 100 | 5.81# |
| D110S | 10260 | 4-1/2" | 10 | | 10.45# |
| D120S | 10262 | 5" | 10 | | 13.33# |
| D130S | 10264 | 6" | 10 | | 14.10# |



FEATURES:

- Assembled
- Includes Screw and Threaded Strap
- Steel
- Zinc Plated

REDUCING WASHERS

PC 5455



FEATURES:

- Steel
- Zinc Plated
- Stamped With Size

Reducing washers are used to reduce the size of a knockout on a sheet metal box, enclosure or cabinet.

| CAT. NO. | UPC | SIZE | STD | MSTR | WT/STD |
|----------|-------|----------------|-----|------|--------|
| RW21 | 30103 | 3/4 x 1/2" | 100 | 1000 | 0.98# |
| RW31 | 30106 | 1 x 1/2" | 100 | 1000 | 1.90# |
| RW32 | 30109 | 1 x 3/4" | 100 | 1000 | 1.37# |
| RW41 | 30112 | 1-1/4 x 1/2" | 50 | 500 | 1.33# |
| RW42 | 30115 | 1-1/4 x 3/4" | 50 | 500 | 1.24# |
| RW43 | 30118 | 1-1/4 x 1" | 50 | 500 | 0.95# |
| RW51 | 30121 | 1-1/2 x 1/2" | 50 | 500 | 1.93# |
| RW52 | 30124 | 1-1/2 x 3/4" | 50 | 500 | 1.78# |
| RW53 | 30127 | 1-1/2 x 1" | 50 | 500 | 1.54# |
| RW54 | 30130 | 1-1/2 x 1-1/4" | 50 | 500 | 1.15# |
| RW61 | 30133 | 2 x 1/2" | 25 | 250 | 1.56# |
| RW62 | 30136 | 2 x 3/4" | 25 | 250 | 1.49# |
| RW63 | 30139 | 2 x 1" | 25 | 250 | 1.37# |
| RW64 | 30142 | 2 x 1-1/4" | 25 | 250 | 1.17# |
| RW65 | 30145 | 2 x 1-1/2" | 25 | 250 | 0.99# |
| RW71 | 30148 | 2-1/2 x 1/2" | 25 | 250 | 2.49# |
| RW72 | 30151 | 2-1/2 x 3/4" | 25 | 250 | 2.37# |
| RW73 | 30154 | 2-1/2 x 1" | 25 | 250 | 2.26# |
| RW74 | 30157 | 2-1/2 x 1-1/4" | 25 | 250 | 2.04# |
| RW75 | 30160 | 2-1/2 x 1-1/2" | 25 | 250 | 1.82# |
| RW76 | 30163 | 2-1/2 x 2" | 25 | 250 | 1.37# |
| RW81 | 30166 | 3 x 1/2" | 10 | 100 | 1.45# |
| RW82 | 30169 | 3 x 3/4" | 10 | 100 | 1.43# |
| RW83 | 30172 | 3 x 1" | 10 | 100 | 1.32# |
| RW84 | 30175 | 3 x 1-1/4" | 10 | 100 | 1.28# |
| RW85 | 30178 | 3 x 1-1/2" | 10 | 100 | 1.11# |
| RW86 | 30181 | 3 x 2" | 10 | 100 | 1.01# |
| RW87 | 30184 | 3 x 2-1/2" | 10 | 100 | 0.78# |
| RW91 | 30170 | 3-1/2 x 1/2" | 10 | 100 | 2.08# |
| RW92 | 30171 | 3-1/2 x 3/4" | 10 | 100 | 2.74# |
| RW93 | 30173 | 3-1/2 x 1" | 10 | 100 | 2.57# |
| RW94 | 30185 | 3-1/2 x 1-1/4" | 10 | 100 | 2.70# |
| RW95 | 30186 | 3-1/2 x 1-1/2" | 10 | 100 | 2.29# |
| RW96 | 30188 | 3-1/2 x 2" | 10 | 100 | 2.04# |
| RW97 | 30190 | 3-1/2 x 2-1/2" | 10 | 100 | 2.33# |
| RW98 | 30192 | 3-1/2 x 3" | 10 | 100 | 1.19# |
| RW101 | 30189 | 4 x 1/2" | 10 | 100 | 3.47# |
| RW102 | 30191 | 4 x 3/4" | 10 | 100 | 3.40# |
| RW103 | 30193 | 4 x 1" | 10 | 100 | 3.32# |
| RW104 | 30195 | 4 x 1-1/4" | 10 | 100 | 3.42# |
| RW105 | 30197 | 4 x 1-1/2" | 10 | 100 | 3.06# |
| RW106 | 30194 | 4 x 2" | 10 | 100 | 2.70# |
| RW107 | 30196 | 4 x 2-1/2" | 10 | 100 | 2.35# |
| RW108 | 30198 | 4 x 3" | 10 | 100 | 1.84# |
| RW109 | 30200 | 4 x 3-1/2" | 10 | 100 | 1.39# |

UNIVERSAL PLASTIC STUD BUSHING

PC 6084



FEATURES:

- UL Listed
- Allows Cables To Pull Easily, Prevent Hang-Ups
- Snaps Securely Into Metal Studs
- 24 to 12 Gauge

Universal Plastic Stud Bushings are used to protect wires from abrasion in metal studs. Due to their molded high-strength, non-conductive polypropylene construction, the USB allows for the installation of multiple cables through a single opening while providing a smooth wire pulling surface. Dottie's USB's can be used with power cabling, low voltage datacom, video and voice cables. Fits all standard pre-punched and field punched holes.

| CAT. NO. | UPC | SIZE | STD | MSTR | WT/STD |
|----------|-------|------|-----|------|--------|
| USB | 81031 | 3/8" | 25 | 875 | 0.34# |

LOCKNUTS

PC 5660

Locknuts are used to secure conduit by running or threading conduit into a box or panel and attaching the locknut and cinching up until tight.

| CAT. NO. | UPC | SIZE | STD | MSTR | WT/STD |
|----------|-------|--------|-----|------|--------|
| LN38* | 12300 | 3/8" | 100 | 1000 | 3.02# |
| LN50 | 12301 | 1/2" | 100 | 1000 | 1.34# |
| LN75 | 12302 | 3/4" | 100 | 1000 | 2.05# |
| LN100 | 12303 | 1" | 100 | 1000 | 2.78# |
| LN125 | 12304 | 1-1/4" | 50 | 500 | 2.08# |
| LN150 | 12305 | 1-1/2" | 50 | 500 | 2.95# |
| LN200 | 12306 | 2" | 50 | 500 | 3.22# |
| LN250 | 12307 | 2-1/2" | 25 | 250 | 3.30# |
| LN300 | 12308 | 3" | 25 | 250 | 3.94# |
| LN350 | 12309 | 3-1/2" | 25 | 250 | 5.00# |
| LN400 | 12310 | 4" | 25 | 250 | 6.06# |
| LN500 | 12311 | 5" | 10 | | 8.95# |
| LN600 | 12312 | 6" | 10 | | 9.90# |

* LN38 Square Fixture Locknut



FEATURES:

- Steel
- Zinc Plated

SEALING LOCKNUTS

PC 5665

Used wherever a liquid tight application is needed when fastening threaded conduit to an unthreaded opening in a box or enclosure.

| CAT. NO. | UPC | SIZE | STD | MSTR | WT/STD |
|----------|-------|--------|-----|------|--------|
| LNS50 | 12330 | 1/2" | 100 | 1000 | 1.34# |
| LNS75 | 12331 | 3/4" | 100 | 1000 | 2.05# |
| LNS100 | 12332 | 1" | 100 | 500 | 2.78# |
| LNS125 | 12333 | 1-1/4" | 50 | 250 | 2.08# |
| LNS150 | 12334 | 1-1/2" | 50 | 250 | 2.95# |
| LNS200 | 12336 | 2" | 50 | 100 | 3.22# |
| LNS250 | 12338 | 2-1/2" | 25 | 100 | 3.30# |
| LNS300 | 12340 | 3" | 25 | 100 | 3.94# |
| LNS350 | 12342 | 3-1/2" | 25 | 50 | 5.00# |
| LNS400 | 12344 | 4" | 25 | 50 | 6.06# |



FEATURES:

- UL Listed
- Steel Locknut
- PVC Sealing Ring
- Zinc Plated

OFFSET NIPPLES

PC 5540

Offset Nipples are used to offset the axis of raceways.

| CAT. NO. | UPC | SIZE | STD | MSTR | WT/STD |
|----------|-------|--------|-----|------|--------|
| ON50 | 10600 | 1/2" | 25 | 250 | 2.33# |
| ON75 | 10605 | 3/4" | 20 | 200 | 2.48# |
| ON100 | 10610 | 1" | 10 | 100 | 2.11# |
| ON125 | 10615 | 1-1/4" | 10 | 100 | 2.79# |
| ON150 | 10620 | 1-1/2" | 2 | 20 | 0.80# |
| ON200 | 10625 | 2" | 2 | 20 | 1.18# |



FEATURES:

- UL Listed
- Die Cast
- High Strength Zinc Alloy

CONDUIT NIPPLES

PC 5550

Conduit Nipples are used with a locknut to serve as a short raceway between enclosures.

| CAT. NO. | UPC | SIZE | STD | MSTR | WT/STD |
|----------|-------|--------|-----|------|--------|
| CN50 | 10200 | 1/2" | 100 | 500 | 2.97# |
| CN75 | 10205 | 3/4" | 100 | 500 | 5.60# |
| CN100 | 10210 | 1" | 100 | 500 | 7.66# |
| CN125 | 10215 | 1-1/4" | 25 | 125 | 2.77# |
| CN150 | 10220 | 1-1/2" | 25 | 125 | 3.99# |
| CN200 | 10225 | 2" | 25 | 125 | 5.70# |
| CN250 | 67700 | 2-1/2" | 5 | | 2.19# |
| CN300 | 67702 | 3" | 5 | | 2.41# |
| CN350 | 67704 | 3-1/2" | 5 | | 3.71# |
| CN400 | 67706 | 4" | 5 | | 4.02# |



FEATURES:

- UL Listed
- Die Cast
- High Strength Zinc Alloy

NON METALLIC CABLE CONNECTORS

PC 6081



DRC50 & DRC75 are smaller and easily installed in confined and tight areas. No tools required. Snap in and you're done. Easily removed from knockouts and easy removal of Romex from connectors. A labor saving connector with 60 pound test pull! Packed in hangable display bag.

FEATURES:

- UL/CSA Listed
- Thermoplastic
- Easily Installed/No Tools Required
- 60 Pound Test Pull

| CAT. NO. | UPC | CABLE SIZE | SIZE | STD | MSTR | WT/STD |
|----------|-------|---|------|-----|------|--------|
| DRC50 | 50507 | Single Cable 14/2 - 10/3 Two Cables 14/2, 12/2, 14/3 | 1/2" | 100 | 4000 | 1.06# |
| DRC75 | 50508 | Single Cable 8/3 - 6/3 Two Cables 14/2 - 8/2 | 3/4" | 50 | 2400 | 0.72# |

NON METALLIC CABLE CONNECTORS

PC 6070



The NMC50 connector for Romex is a snap to install. Molded in a one piece plastic construction, this push in design has a captive locking wedge. The cable will be securely retained and no locknut is required. They provide excellent strain relief and are designed to accommodate 14/2 minimum to 10/3 maximum cables, and one or more .300 to .600 diameter cords.

FEATURES:

- UL Listed
- One or Two Cables
- Installs Quickly
- Excellent Strain Relief
- All Plastic Design; Resists Corrosion

| CAT. NO. | UPC | SIZE | STD | MSTR | WT/STD |
|----------|-------|------|-----|------|--------|
| NMC50 | 10160 | 1/2" | 50 | 500 | 1.14# |

CAT-A-PILLAR WIRING DEVICE SPACER

PC 6230



Cat-A-Pillar is a non conductive, low density polyethylene spacer strip consisting of 8 foldable segments. Each segment allows for 1/8" of spacing. It's easy to calculate. Determine the depth of the box to the surface and tear or cut the number of 1/8" segments needed. Snap over screw (no need to remove) and rotate a Cat-A-Pillar so that the slot faces away from the device. Installs quickly on single or multi-gang boxes. Reusable and can be used as a shim or a plastic washer to straighten crooked devices.

FEATURES:

- Low Density Polyethylene
- Non Conductive
- Reusable
- Sold Per Ea Pack

| CAT. NO. | UPC | STD | MSTR | WT/STD |
|----------|-------|-------------------------|----------|--------|
| CA25 | 16170 | 1 Pack (containing 25) | 10 Packs | 0.18# |
| CA100 | 16171 | 1 Pack (containing 100) | 10 Packs | 0.65# |

CAT-A-PILLARS are not intended to be used in lieu of standard means of support under normal circumstances or when in conflict with governing electrical codes.

WALL PLATE INSULATION GASKETS

PC 6240



Energy saving gaskets prevent the loss of heat and cold through outlets and switches located on outside walls. Constructed of UL Rated #94HFI listed cross link close cell polyethylene insulating foam. New one piece design fits: regular toggle or duplex receptacle and Decora Type Toggle and duplex receptacles.

FEATURES:

- Polyethylene Insulating Foam
- Flame Retardant
- Energy Saving
- One Size Fits All
- Sold Per Ea Pack

| CAT. NO. | UPC | STD | MSTR | WT/STD |
|----------|-------|-------------------------|----------|--------|
| WPI25 | 16180 | 1 Pack (containing 25) | 10 Packs | 0.05# |
| WPI100 | 16182 | 1 Pack (containing 100) | 10 Packs | 0.40# |

STRAIN RELIEF CONNECTORS-NYLON

PC 5510

Nylon strain relief connectors grip portable cord to relieve strain on cord and prevent wires from being pulled out of connecting screws. Note: Wire ranges vary from the steel strain relief connectors. Locknut not supplied.



| CAT. NO. | UPC | SIZE | CABLE RANGE | STD | MSTR | WT/STD |
|----------|-------|------|--------------|-----|------|--------|
| NSR38L | 36020 | 3/8" | .197 to .394 | 25 | 250 | 0.71# |
| NSR12L | 36024 | 1/2" | .394 to .551 | 25 | 250 | 0.96# |
| NSR34L | 36028 | 3/4" | .551 to .709 | 10 | 100 | 0.62# |
| NSR100L | 36032 | 1" | .709 to .984 | 10 | 100 | 1.02# |

FEATURES:

- UL Listed
- Liquid Tight to 70PSI
- Excellent Pullout Resistance
- Extended Cable Range

STRAIN RELIEF CONNECTORS-STEEL

PC 5520

Steel strain relief connectors grip portable cord to relieve strain on cord and prevent wires from being pulled out of connecting screws. Note: Wire ranges vary from the nylon strain relief connectors.



| CAT. NO. | UPC | SIZE | CABLE RANGE | COLOR | STD | MSTR | WT/STD |
|------------|-------|------|---------------|--------|-----|------|--------|
| SR50A250 | 36050 | 1/2" | .150 to .250 | Red | 25 | 250 | 2.61# |
| SR50A350 | 36052 | 1/2" | .250 to .350 | White | 25 | 250 | 2.58# |
| SR50A450 | 36054 | 1/2" | .350 to .450 | Blue | 25 | 250 | 2.55# |
| SR50A560 | 36056 | 1/2" | .450 to .560 | Green | 25 | 250 | 2.50# |
| SR50A650 | 36058 | 1/2" | .550 to .650 | Brown | 25 | 250 | 2.43# |
| SR75A250 | 36060 | 3/4" | .150 to .250 | Red | 10 | 100 | 1.67# |
| SR75A350 | 36062 | 3/4" | .250 to .350 | White | 10 | 100 | 1.71# |
| SR75A450 | 36064 | 3/4" | .350 to .450 | Blue | 10 | 100 | 1.66# |
| SR75A560 | 36066 | 3/4" | .450 to .560 | Green | 10 | 100 | 1.62# |
| SR75A650 | 36068 | 3/4" | .550 to .650 | Brown | 10 | 100 | 1.57# |
| SR75B750 | 36070 | 3/4" | .650 to .750 | Yellow | 10 | 100 | 1.44# |
| SR75B850 | 36072 | 3/4" | .750 to .850 | Purple | 10 | 100 | 1.45# |
| SR100B750 | 36074 | 1" | .650 to .750 | Yellow | 5 | 50 | 1.44# |
| SR100B850 | 36076 | 1" | .750 to .850 | Purple | 5 | 50 | 1.44# |
| SR100C950 | 36078 | 1" | .850 to .950 | Gray | 5 | 50 | 1.43# |
| SR100C1050 | 36080 | 1" | .950 to 1.050 | Black | 5 | 50 | 1.41# |

FEATURES:

- UL Listed
- Excellent Pullout Resistance
- Extended Cable Range
- Zinc Plated Steel

STEEL COMBO COUPLINGS

PC 5470

Steel combo couplings are used to connect liquid tight conduit to E.M.T.



| CAT. NO. | UPC | SIZE | STD | MSTR | WT/STD |
|----------|-------|---------------------|-----|------|--------|
| CF1 | 40750 | 1/2" Flex to E.M.T. | 25 | 125 | 3.39# |
| CF2 | 40755 | 3/4" Flex to E.M.T. | 10 | 50 | 2.16# |
| CF3 | 40760 | 1" Flex to E.M.T. | 10 | 20 | 3.49# |

FEATURES:

- UL Listed
- Steel
- Zinc Plated

DIE CAST LIQUID TITE CONNECTORS

PC 5460



FEATURES:

- UL Listed
- Zinc Die Cast
- Straight & 90°
- Insulated & Non Insulated

Die cast liquid tite connectors are used to connect metallic & non-metallic liquid tite conduit into an enclosure.

STRAIGHT

| CAT. NO. | UPC | SIZE | STD | MSTR | WT/STD |
|----------|-------|--------|-----|------|--------|
| LT38 | 11000 | 3/8" | 25 | 250 | 3.22# |
| LT50 | 11005 | 1/2" | 25 | 250 | 3.65# |
| LT75 | 11010 | 3/4" | 10 | 100 | 2.19# |
| LT100 | 11015 | 1" | 5 | 50 | 1.74# |
| LT125 | 11020 | 1-1/4" | 5 | 50 | 2.69# |
| LT150 | 11025 | 1-1/2" | 2 | 20 | 1.26# |
| LT200 | 11030 | 2" | 2 | 20 | 1.60# |

90°

| | | | | | |
|---------|-------|--------|----|-----|-------|
| LT9038 | 11200 | 3/8" | 10 | 100 | 2.17# |
| LT9050 | 11205 | 1/2" | 10 | 100 | 2.97# |
| LT9075 | 11210 | 3/4" | 10 | 100 | 2.73# |
| LT90100 | 11215 | 1" | 5 | 50 | 2.26# |
| LT90125 | 11220 | 1-1/4" | 5 | 50 | 3.92# |
| LT90150 | 11225 | 1-1/2" | 2 | 20 | 2.12# |
| LT90200 | 11230 | 2" | 2 | 20 | 2.62# |

STRAIGHT INSULATED

| | | | | | |
|--------|-------|--------|----|-----|-------|
| LT38I | 11100 | 3/8" | 25 | 250 | 3.86# |
| LT50I | 11105 | 1/2" | 25 | 250 | 3.32# |
| LT75I | 11110 | 3/4" | 10 | 100 | 2.37# |
| LT100I | 11115 | 1" | 5 | 50 | 1.84# |
| LT125I | 11120 | 1-1/4" | 5 | 50 | 2.66# |
| LT150I | 11125 | 1-1/2" | 2 | 20 | 1.24# |
| LT200I | 11130 | 2" | 2 | 20 | 1.64# |
| LT250I | 11135 | 2-1/2" | 1 | | 1.74# |
| LT300I | 11140 | 3" | 1 | | 2.68# |
| LT350I | 11145 | 3-1/2" | 1 | | 3.45# |
| LT400I | 11150 | 4" | 1 | | 3.87# |

90° INSULATED

| | | | | | |
|----------|-------|--------|----|-----|-------|
| LT9038I | 11300 | 3/8" | 10 | 100 | 2.28# |
| LT9050I | 11305 | 1/2" | 10 | 100 | 1.98# |
| LT9075I | 11310 | 3/4" | 10 | 100 | 2.77# |
| LT90100I | 11315 | 1" | 5 | 50 | 2.26# |
| LT90125I | 11320 | 1-1/4" | 5 | 50 | 4.09# |
| LT90150I | 11325 | 1-1/2" | 2 | 20 | 2.06# |
| LT90200I | 11330 | 2" | 2 | 20 | 2.81# |
| LT90250I | 11235 | 2-1/2" | 1 | | 3.43# |
| LT90300I | 11240 | 3" | 1 | | 4.72# |
| LT90350I | 11245 | 3-1/2" | 1 | | 7.33# |
| LT90400I | 11250 | 4" | 1 | | 8.03# |

PVC LIQUID TITE CONNECTORS

PC 5490



FEATURES:

- UL Listed
- PVC With Polypropylene Sealing Ring
- Straight & 90°

PVC liquid tite connectors are used to connect non metallic liquid tite conduit & flexible non-metallic tubing to enclosures. UV rated plastic.

STRAIGHT

| CAT. NO. | UPC | SIZE | STD | MSTR | WT/STD |
|----------|-------|--------|-----|------|--------|
| NLT38 | 36000 | 3/8" | 25 | 250 | 1.92# |
| NLT50 | 36002 | 1/2" | 25 | 250 | 1.34# |
| NLT75 | 36004 | 3/4" | 25 | 250 | 2.38# |
| NLT100 | 36006 | 1" | 25 | 250 | 2.68# |
| NLT125 | 36007 | 1-1/4" | 5 | 50 | 1.40# |
| NLT150 | 36009 | 1-1/2" | 5 | 50 | 1.42# |
| NLT200 | 36011 | 2" | 5 | 50 | 2.13# |

90°

| | | | | | |
|----------|-------|--------|----|-----|-------|
| NLT9038 | 36008 | 3/8" | 10 | 100 | 0.89# |
| NLT9050 | 36010 | 1/2" | 10 | 100 | 0.76# |
| NLT9075 | 36012 | 3/4" | 10 | 100 | 1.07# |
| NLT90100 | 36014 | 1" | 5 | 50 | 1.00# |
| NLT90125 | 36013 | 1-1/4" | 5 | 50 | 1.72# |
| NLT90150 | 36015 | 1-1/2" | 5 | 50 | 2.43# |
| NLT90200 | 36016 | 2" | 5 | 50 | 3.41# |

STEEL LIQUID TITE CONNECTORS

Steel liquid tite connectors are used to connect liquid tite conduit into an enclosure.

STRAIGHT

| CAT. NO. | UPC | SIZE | STD | MSTR | WT/STD |
|----------|-------|--------|-----|------|--------|
| SL38 | 66701 | 3/8" | 25 | 125 | 2.88# |
| SL50 | 66700 | 1/2" | 25 | 125 | 3.22# |
| SL75 | 66702 | 3/4" | 10 | 50 | 1.80# |
| SL100 | 66704 | 1" | 5 | 25 | 1.49# |
| SL125 | 66736 | 1-1/4" | 5 | 25 | 2.35# |
| SL150 | 66738 | 1-1/2" | 5 | | 3.01# |
| SL200 | 66740 | 2" | 5 | | 4.25# |

45°

| | | | | | |
|---------|-------|--------|----|----|-------|
| SL4538 | 66705 | 3/8" | 10 | 50 | 1.99# |
| SL4550 | 66706 | 1/2" | 10 | 50 | 2.19# |
| SL4575 | 66708 | 3/4" | 10 | 50 | 3.06# |
| SL45100 | 66710 | 1" | 5 | 25 | 2.61# |
| SL45125 | 66711 | 1-1/4" | 5 | 25 | 3.43# |
| SL45150 | 66713 | 1-1/2" | 2 | 10 | 2.04# |
| SL45200 | 66715 | 2" | 2 | 10 | 2.92# |

90°

| | | | | | |
|---------|-------|--------|----|----|-------|
| SL9038 | 66709 | 3/8" | 10 | 50 | 2.22# |
| SL9050 | 66712 | 1/2" | 10 | 50 | 2.35# |
| SL9075 | 66714 | 3/4" | 10 | 50 | 3.54# |
| SL90100 | 66716 | 1" | 5 | 25 | 2.93# |
| SL90125 | 66742 | 1-1/4" | 5 | 25 | 4.10# |
| SL90150 | 66743 | 1-1/2" | 2 | 10 | 2.36# |
| SL90200 | 66745 | 2" | 2 | 10 | 3.48# |

STRAIGHT INSULATED

| | | | | | |
|--------|-------|--------|----|-----|-------|
| SL38I | 66717 | 3/8" | 25 | 125 | 2.93# |
| SL50I | 66718 | 1/2" | 25 | 125 | 3.09# |
| SL75I | 66720 | 3/4" | 10 | 50 | 2.08# |
| SL100I | 66722 | 1" | 5 | 25 | 1.47# |
| SL125I | 66744 | 1-1/4" | 5 | 25 | 2.33# |
| SL150I | 66746 | 1-1/2" | 5 | 25 | 2.93# |
| SL200I | 66748 | 2" | 5 | 25 | 4.25# |
| SL250I | 81623 | 2-1/2" | 1 | | 2.60# |
| SL300I | 81624 | 3" | 1 | | 3.60# |
| SL350I | 81625 | 3-1/2" | 1 | | 4.45# |
| SL400I | 81626 | 4" | 1 | | 5.20# |

45° INSULATED

| | | | | | |
|----------|-------|--------|----|----|--------|
| SL4538I | 66723 | 3/8" | 10 | 50 | 1.99# |
| SL4550I | 66724 | 1/2" | 10 | 50 | 2.23# |
| SL4575I | 66726 | 3/4" | 10 | 50 | 3.08# |
| SL45100I | 66728 | 1" | 5 | 25 | 2.67# |
| SL45125I | 66729 | 1-1/4" | 5 | 25 | 3.27# |
| SL45150I | 66731 | 1-1/2" | 2 | 10 | 1.79# |
| SL45200I | 66733 | 2" | 2 | 10 | 2.92# |
| SL45250I | 81627 | 2-1/2" | 1 | | 4.78# |
| SL45300I | 81628 | 3" | 1 | | 7.75# |
| SL45350I | 81629 | 3-1/2" | 1 | | 8.80# |
| SL45400I | 81630 | 4" | 1 | | 10.00# |

90° INSULATED

| | | | | | |
|----------|-------|--------|----|----|--------|
| SL9038I | 66735 | 3/8" | 10 | 50 | 2.37# |
| SL9050I | 66730 | 1/2" | 10 | 50 | 2.37# |
| SL9075I | 66732 | 3/4" | 10 | 50 | 3.62# |
| SL90100I | 66734 | 1" | 5 | 25 | 3.37# |
| SL90125I | 66749 | 1-1/4" | 5 | 25 | 4.42# |
| SL90150I | 66747 | 1-1/2" | 2 | 10 | 2.00# |
| SL90200I | 66751 | 2" | 2 | 10 | 3.65# |
| SL90250I | 81631 | 2-1/2" | 1 | | 6.25# |
| SL90300I | 81632 | 3" | 1 | | 9.00# |
| SL90350I | 81633 | 3-1/2" | 1 | | 10.00# |
| SL90400I | 81634 | 4" | 1 | | 15.00# |



FEATURES:

- UL Listed
- Zinc Plated Steel
- Malleable Iron
- Straight, 45° & 90°
- Insulated & Non Insulated

WEATHERTIGHT HUBS

PC 5462



Weathertight hubs are used to terminate rigid conduit or IMC into an enclosure.

FEATURES:

- UL Listed
- Die Cast From High Strength Zinc Alloy
- With or Without Lugs
- Sealing Ring
- 105° Rated Throat Insulator

INSULATED

| CAT. NO. | UPC | SIZE | STD | MSTR | WT/STD |
|----------|-------|--------|-----|------|--------|
| WTH50 | 60255 | 1/2" | 10 | 100 | 1.85# |
| WTH75 | 60256 | 3/4" | 10 | 100 | 2.62# |
| WTH100 | 60257 | 1" | 10 | 100 | 3.96# |
| WTH125 | 60258 | 1-1/4" | 5 | 50 | 2.72# |
| WTH150 | 60259 | 1-1/2" | 5 | 50 | 3.62# |
| WTH200 | 60260 | 2" | 2 | 20 | 1.94# |
| WTH250 | 60261 | 2-1/2" | 1 | 5 | 1.79# |
| WTH300 | 60262 | 3" | 1 | 5 | 2.23# |
| WTH350 | 60263 | 3-1/2" | 1 | 5 | 2.74# |
| WTH400 | 60264 | 4" | 1 | 5 | 2.80# |

INSULATED W/ GROUNDING LUGS

| CAT. NO. | UPC | SIZE | STD | MSTR | WT/STD |
|----------|-------|--------|-----|------|--------|
| WTHGL50 | 60270 | 1/2" | 10 | 100 | 2.02# |
| WTHGL75 | 60271 | 3/4" | 10 | 100 | 2.78# |
| WTHGL100 | 60272 | 1" | 10 | 100 | 4.00# |
| WTHGL125 | 60273 | 1-1/4" | 5 | 50 | 2.68# |
| WTHGL150 | 60274 | 1-1/2" | 5 | 50 | 3.65# |
| WTHGL200 | 60275 | 2" | 2 | 20 | 2.02# |
| WTHGL250 | 60276 | 2-1/2" | 1 | 5 | 1.79# |
| WTHGL300 | 60277 | 3" | 1 | 5 | 2.26# |
| WTHGL350 | 60278 | 3-1/2" | 1 | 5 | 2.74# |
| WTHGL400 | 60279 | 4" | 1 | 5 | 2.80# |

NO THREAD CONNECTORS & COUPLINGS

PC 5530



No thread connectors are used to connect rigid conduit to an enclosure. The connectors and couplings are raintite and approved for direct burial.

FEATURES:

- UL-CSA Listed
- Zinc Plated Steel
- For Rigid Conduit
- Non Insulated & Insulated

CONNECTORS-NON INSULATED

| CAT. NO. | UPC | SIZE | STD | MSTR | WT/STD |
|----------|-------|--------|-----|------|--------|
| NT50 | 66750 | 1/2" | 25 | 125 | 2.95# |
| NT75 | 66752 | 3/4" | 25 | 125 | 4.49# |
| NT100 | 66754 | 1" | 10 | 50 | 3.06# |
| NT125 | 66756 | 1-1/4" | 10 | 50 | 4.22# |
| NT150 | 66758 | 1-1/2" | 5 | 25 | 2.83# |
| NT200 | 66780 | 2" | 5 | 25 | 3.54# |

CONNECTORS-INSULATED

| CAT. NO. | UPC | SIZE | STD | MSTR | WT/STD |
|----------|-------|--------|-----|------|--------|
| NT50I | 66760 | 1/2" | 25 | 125 | 3.09# |
| NT75I | 66762 | 3/4" | 25 | 125 | 4.54# |
| NT100I | 66764 | 1" | 10 | 50 | 3.08# |
| NT125I | 66766 | 1-1/4" | 10 | 50 | 4.36# |
| NT150I | 66768 | 1-1/2" | 5 | 25 | 2.87# |
| NT200I | 66782 | 2" | 5 | 25 | 3.87# |
| NT250I | 81635 | 2-1/2" | 5 | | 12.10# |
| NT300I | 81636 | 3" | 3 | | 9.21# |
| NT350I | 81637 | 3-1/2" | 2 | | 11.70# |
| NT400I | 81638 | 4" | 2 | | 9.84# |

COUPLINGS

| CAT. NO. | UPC | SIZE | STD | MSTR | WT/STD |
|----------|-------|--------|-----|------|--------|
| NTC50 | 66770 | 1/2" | 25 | 125 | 3.82# |
| NTC75 | 66772 | 3/4" | 25 | 125 | 6.00# |
| NTC100 | 66774 | 1" | 15 | 75 | 5.52# |
| NTC125 | 66776 | 1-1/4" | 5 | 25 | 2.72# |
| NTC150 | 66778 | 1-1/2" | 5 | 25 | 3.46# |
| NTC200 | 66784 | 2" | 5 | 25 | 4.43# |
| NTC250 | 81639 | 2-1/2" | 5 | | 18.00# |
| NTC300 | 81640 | 3" | 3 | | 12.15# |
| NTC350 | 81641 | 3-1/2" | 2 | | 10.90# |
| NTC400 | 81642 | 4" | 2 | | 12.70# |

INSULATED GROUND BUSHINGS - LAY IN LUGS

PC 5600

Ground bushings with lay-in lugs are used to terminate threaded rigid conduit or IMC to an enclosure. A 90° C Cu/Al dual rated lay in lug is provided for grounding jumper to neutral bus bar.

| CAT. NO. | UPC | SIZE | RANGE | STD | MSTR | WT/STD |
|----------|-------|--------|-------------------|-----|------|--------|
| GBL50 | 10400 | 1/2" | 14 Sol to 4 Str | 25 | 250 | 1.87# |
| GBL75 | 10405 | 3/4" | 14 Sol to 4 Str | 25 | 250 | 2.11# |
| GBL100 | 10410 | 1" | 14 Sol to 4 Str | 25 | 250 | 2.48# |
| GBL125 | 10415 | 1-1/4" | 14 Sol to 4 Str | 25 | 250 | 3.09# |
| GBL150 | 10420 | 1-1/2" | 14 Sol to 2 Str | 25 | 250 | 4.12# |
| GBL200 | 10425 | 2" | 14 Sol to 2 Str | 10 | 100 | 1.94# |
| GBL250 | 10430 | 2-1/2" | 14 Sol to 1/0 Str | 5 | 50 | 1.86# |
| GBL300 | 10435 | 3" | 14 Sol to 1/0 Str | 5 | 50 | 2.19# |
| GBL350 | 10440 | 3-1/2" | 14 Sol to 1/0 Str | 2 | 20 | 1.09# |
| GBL400 | 10445 | 4" | 14 Sol to 1/0 Str | 2 | 20 | 1.17# |



FEATURES:

- Insulated Ground Bushings
- UL Listed
- Die Cast
- Lay in Lug
- Cu/Al (Copper/Aluminum)

GROUND RODS (COPPER BONDED)

PC 5610

Ground rods are available in 1/2", 5/8" and 3/4" diameters and in 8' and 10' lengths. The copper exterior is molecularly bonded to nickel sealed, high strength steel cores. Copper jacket plating thickness exceeds UL & ANSI specs of .010".

| CAT. NO. | UPC | SIZE | STD | MSTR | WT/STD |
|----------|-------|-----------|-----|------|--------|
| GR1208 | 35005 | 1/2 x 8' | 5 | 100 | 50.00# |
| GR1210 | 35010 | 1/2 x 10' | 5 | 100 | 63.00# |
| GR5808 | 35015 | 5/8 x 8' | 5 | 100 | 69.50# |
| GR5810 | 35020 | 5/8 x 10' | 5 | 100 | 86.00# |
| GR3408 | 35025 | 3/4 x 8' | 5 | 50 | 49.75# |
| GR3410 | 35030 | 3/4 x 10' | 5 | 50 | 63.75# |



FEATURES:

- UL Listed
- Copper Bonded
- Caution! Always Wear Eye Protection

* Ground Rod Driver, page E29

GROUND ROD CLAMPS

PC 5570

Ground rod clamps are used to connect conductor to a driven ground rod. Cast from high strength, highly conductive copper alloy, they are approved for direct burial in ground and concrete and are assembled with a bronze hex head bolt.

| CAT. NO. | UPC | SIZE | RANGE | STD | MSTR | WT/STD |
|----------|-------|------|-----------------|-----|------|--------|
| GR12 | 10500 | 1/2" | 10 Sol to 2 Str | 50 | 250 | 8.83# |
| GR58 | 10505 | 5/8" | 10 Sol to 2 Str | 50 | 250 | 4.65# |
| GR34 | 10510 | 3/4" | 10 Sol to 2 Str | 25 | 250 | 2.96# |



FEATURES:

- UL Listed
- Direct Burial
- Bronze
- With Bronze Hex Head Bolt

GROUND ROD CLAMPS - UNIVERSAL

PC 5571

Universal Ground Rod Clamps is UL Listed for all sizes of Ground Rods and Rebar. Constructed of Stainless Steel Alloy and a High Performance Stainless Steel Bolt.

3/8" Rod - Wire Range 10 Solid to 1/0 Stranded
 1/2" Rod - Wire Range 10 Solid to 1/0 Stranded
 5/8" Rod - Wire Range 10 Solid to 1/0 Stranded
 3/4" Rod - Wire Range 10 Solid to 1/0 Stranded

| CAT. NO. | UPC | STD | MSTR | WT/STD |
|----------|-------|-----|------|--------|
| UGRCS | 83180 | 50 | 500 | 4.65# |



FEATURES:

- UL Listed
- Direct Burial
- Stainless Steel
- One Size Fits All

BARE GROUND CLAMPS

PC 5560



Bare ground clamps are used to connect bare copper wire to water pipe, rebar, ground rod or copper water tubing for grounding. Fittings are UL listed and cast from high strength, highly conductive copper alloy with steel, brass or bronze screws.

FEATURES:

- UL Listed
- Pressure Cast or Bronze
- Bonding or Grounding
- With Steel, Stainless Steel, Brass or Bronze Screws

| CAT. NO. | UPC | WIRE RANGE | | DESCRIPTION | PIPE SIZE | STD | MSTR | WT/STD |
|---------------|-------|------------|-----|---|-------------|-----|------|--------|
| | | SOL | STR | | | | | |
| 20B* | 10005 | 8 | 2 | Prsr Cast Brs Plated | 1/2 to 1" | 25 | 250 | 3.83# |
| 20M 25 | 10010 | 8 | 2 | Prsr Cast Mlbl Finish Bronze | 1/2 to 1" | 25 | 250 | 4.40# |
| | 10015 | 10 | 2 | | 1/2 to 1" | 25 | 250 | 4.48# |
| DB25 DLI25 | 67500 | 10 | 2 | Bronze Direct Burial Bronze Direct Burial Lay in Feature | 1/2 to 1" | 25 | 250 | 4.79# |
| | 28090 | 10 | 2 | | 1/2 to 1" | 25 | 250 | 4.79# |
| DB2538 | 67503 | 10 | 2 | Bronze Direct Burial | 1/2 to 1" | 25 | 250 | 4.45# |
| PL25 27 | 56470 | 10 | 2 | Bronze Bronze | 1/2 to 1" | 25 | 250 | 4.85# |
| | 10025 | 10 | 2 | | 1-1/4 to 2" | 5 | 50 | 2.18# |
| DB27 DLI27 | 67502 | 10 | 2 | Bronze Direct Burial Bronze Direct Burial Lay in Feature | 1-1/4 to 2" | 5 | 50 | 2.13# |
| | 28092 | 10 | 2 | | 1-1/4 to 2" | 5 | 50 | 2.13# |
| 1001* | 10027 | 10 | 2 | Bronze | 2-1/2 to 4" | 5 | | 5.07# |
| 1002* | 10028 | 10 | 2 | Bronze | 4-1/2 to-6" | 5 | | 9.12# |

DB25 and DLI25 Approved For Steel 4/6/8 Rebar
DB2538 Dual Rated Suitable For Pipe or Steel Rebar 3/8 to 1" (#3 - #8). Accommodates Steel Rebar Without Disassembly
* 20B, 1001 & 1002 Non UL Approved

GROUND CLAMPS WITH HUBS

PC 5560

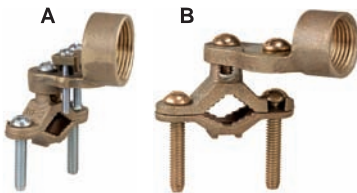

FEATURES:

- UL Listed
- Bronze
- With 1/2", 3/4" or 1" Hubs

Ground clamps with hubs are used to connect grounding conductor in conduit to water pipe for grounding. Cast from high strength, highly conductive copper alloy with steel or bronze screws.

| CAT. NO. | UPC | PHOTO | WIRE RANGE | HUB SIZE | PIPE SIZE | STD | MSTR | WT/STD |
|----------|-------|-------|------------|----------|-------------|-----|------|--------|
| 29H | 10051 | B | 10-6 | 1/2" | 1/2 to 1" | 25 | 125 | 9.80# |
| 29BRZ | 10054 | B | 10-6 | 1/2" | 1/2 to 1" | 25 | 125 | 10.06# |
| 30H | 10053 | A | 10-2/0 | 3/4" | 1/2 to 1" | 25 | 125 | 11.35# |
| 31H | 10056 | A | 10-3/0 | 1" | 1/2 to 1" | 25 | 125 | 12.33# |
| 270H | 10057 | B | 10-6 | 1/2" | 1-1/4 to 2" | 25 | 25 | 14.87# |
| 271H | 10059 | A | 10-2/0 | 3/4" | 1-1/4 to 2" | 25 | 25 | 16.63# |
| 272H | 10061 | A | 10-3/0 | 1" | 1-1/4 to 2" | 25 | 25 | 17.44# |
| 280H | 10063 | B | 10-6 | 1/2" | 2-1/2 to 4" | 5 | 5 | 6.23# |
| 281H | 10064 | A | 10-2/0 | 3/4" | 2-1/2 to 4" | 5 | 5 | 6.63# |
| 282H | 10066 | A | 10-3/0 | 1" | 2-1/2 to 4" | 5 | 5 | 6.64# |

All clamps provided with steel screws except 29BRZ (bronze screws)

FITTINGS & STAMPINGS

ARMORED GROUND CLAMPS

PC 5560

Used to connect armored cable to water pipe for grounding. Special pressure bar grips armored cable insulation to decrease chances of grounding conductor being pulled out. Cast from high strength, highly conductive copper alloy.



FEATURES:

- UL Listed
- Pressure Cast or Bronze

- Bonding or Grounding
- With Steel or Stainless Steel Screws

| CAT. NO. | UPC | WIRE RANGE | DESCRIPTION | SCREW TYPE | PIPE SIZE | STD | MSTR | WT/STD |
|----------|-------|-----------------|-----------------------|-----------------|-------------|-----|------|--------|
| 21B* | 10030 | 8 Sol to 4 Str | Prsr Cast Brs Plated | Steel | 1/2 to 1" | 25 | 250 | 5.09# |
| 21M | 10035 | 8 Sol to 4 Str | Prsr Cast Mbl Finish | Steel | 1/2 to 1" | 25 | 250 | 5.09# |
| 26 | 10040 | 8 Sol to 4 Str | Bronze | Steel | 1/2 to 1" | 25 | 250 | 5.83# |
| DLI26 | 28091 | 8 Sol to 4 Str | Bronze Lay in Feature | Stainless Steel | 1/2 to 1" | 25 | 250 | 5.63# |
| 26SWV | 10042 | 10 Sol to 6 Str | Bronze Swivel Type | Steel | 1/2 to 1" | 25 | 125 | 9.33# |
| 28 | 10045 | 8 Sol to 4 Str | Bronze | Steel | 1-1/4 to 2" | 25 | 250 | 11.63# |
| 28SWV | 10046 | 10 Sol to 6 Str | Bronze swivel Type | Steel | 1-1/4 to 2" | 5 | | 3.05# |
| 1102* | 10047 | 8 Sol to 4 Str | Bronze | Steel | 2-1/2 to 4" | 5 | | 6.60# |
| 1103* | 11048 | 8 Sol to 4 Str | Bronze | Steel | 4-5-6" | 5 | | 9.92# |

26SWV Includes a pressure bar that swings 360° for easy adjustment
 28SWV Includes a pressure bar that swings 360° for easy adjustment
 * Non UL Approved

HUBS

PC 5580

Hubs are used with ground clamps to connect rigid conduit to water pipe for grounding. 360° swing type hub provides flexibility. They are cast from high strength, highly conductive copper alloy with zinc plated screws.



| CAT. NO. | UPC | SIZE | PHOTO | GROUND WIRE | STD | MSTR | WT/STD |
|----------|-------|------|-------|-------------------|-----|------|--------|
| HUB50L | 10171 | 1/2" | C | 10 Sol to 6 Str | 25 | 250 | 5.04# |
| HUB75L | 10176 | 3/4" | D | 10 Sol to 2/0 Str | 25 | 250 | 7.23# |
| HUB100L | 10181 | 1" | D | 10 Sol to 3/0 Str | 10 | 100 | 3.00# |

FEATURES:

- UL Listed
- Bronze

GROUND ROD DRIVERS

PC 6550

Install ground rod from ground level. Sliding action drives rod without need of hammer. Driver will not deform end of rod. Heavy duty construction provides maximum driving forces, while soft rubber ergonomic grip provides user comfort.



| CAT. NO. | UPC | DESCRIPTION | STD | MSTR | WT/STD |
|--------------------|-------|---|-----|------|--------|
| GRD58 | 24101 | 5' Driver with insert for 5/8" Ground Rod | 1 | 1 | 22.34# |
| GRD34 | 24102 | 5' Driver with insert for 3/4" Ground Rod | 1 | 1 | 22.13# |
| INSERT ONLY | | | | | |
| GRDI58 | 24103 | Insert only for 5/8" Ground Rod | 1 | 1 | 5.73# |
| GRDI34 | 24104 | Insert only for 3/4" Ground Rod | 1 | 1 | 5.63# |

FEATURES:

- No Need For Ladders Or Sledge Hammers!
- Caution! Always Wear Eye Protection

GROUND SCREWS



PC 5620



Ground screws are plated green for identification purposes and are used for grounding pigtails or wire. They have either a 1/4" or 5/16" head with Hex/Slotted/Phillips/Square drive. The 1/4" (1032G & 1032GTP) has a leader point; the 5/16" (1032TC & 1032TCTP) has a thread cutting point.

FEATURES:

- Steel
- Green Zinc Plated
- Packed in Invincibox
- 1/4" or 5/16" Head
- Leader or Thread Cutting Point
- Hex/Slotted/Phillips/Square

| CAT. NO. | UPC | DESCRIPTION | HEX SIZE | SCREW SIZE | STD | MSTR | WT/STD |
|----------|-------|---|----------|--------------|-----|------|--------|
| 1032G | 14107 | Leader Point Hex/Slotted/Phillips/Square | 1/4" | 10-32 x 3/8" | 100 | 4000 | 0.44# |
| 1032GTP | 14108 | Tuff Pack  | 1/4" | 10-32 x 3/8" | 500 | 3000 | 4.20# |
| 1032TC | 14109 | Thread Cutting Pt. Hex/Slotted/Phillips/Square | 5/16" | 10-32 x 3/8" | 100 | 4000 | 0.50# |
| 1032TCTP | 14111 | Tuff Pack  | 5/16" | 10-32 x 3/8" | 500 | 3000 | 4.86# |

GROUND PIGTAILS

PC 5630



Ground pigtails are used for grounding receptacles to steel boxes.

FEATURES:

- Green Zinc Plated Ground Screw
- UL Listed Wire
- Green #12 Ga. Solid Copper and #12 Ga. Stranded Copper Wire
- 7-1/2", 10-1/2" or 12-1/2" Lengths
- 1/4" Hex/Slotted/Phillips/Square with (Leader Point)
- 8" Stranded w/ Round Washer Head Phillips/Slot Screw

| CAT. NO. | UPC | SIZE | GAUGE | STD | MSTR | WT/STD |
|----------|-------|---------|----------------|-----|------|--------|
| GP650 | 16100 | 7-1/2" | 12 Ga Solid | 250 | 2500 | 4.90# |
| GP1050 | 16102 | 10-1/2" | 12 Ga Solid | 250 | 2000 | 6.56# |
| GP1250 | 16103 | 12-1/2" | 12 Ga Solid | 250 | 1000 | 7.44# |
| GPS775 | 82596 | 12-1/2" | 12 Ga Stranded | 250 | 2500 | 4.90# |

GROUND CLIPS

PC 5640



Ground Clips are intended to be pressed on the top edge of a box to hold a No. 10, 12, or 14AWG copper or No. 10, or 12AWG aluminum grounding conductor against the side wall. This clip may be used for connecting the grounding conductor of nonmetallic sheathed cable to outlet boxes or for connecting the grounding jumper from a receptacle to an outlet.

FEATURES:

- Zinc Plated
- Holds 10, 12, or 14 Ga. Copper Wire
- Holds 10, 12, or 14 Ga. Aluminum Wire

| CAT. NO. | UPC | STD | MSTR | WT/STD |
|----------|-------|-----|------|--------|
| GC | 27050 | 100 | 4000 | 0.38# |
| GCTP | 27051 | 500 | 3000 | 1.90# |

Tuff Pack 

COPPER CRIMP SLEEVES

PC 5650



Copper Crimp Sleeves are used to group and terminate copper wires and provide a vibration resistant connection. Copper requires crimping pressure and resists corrosion.

FEATURES:

- UL Listed
- Solid Copper
- 18 to 10 Ga. Wire
- 18 to 8 Ga. Wire

| CAT. NO. | UPC | WIRE GAUGE | STD | MSTR | WT/STD |
|----------|-------|------------|-----|------|--------|
| CS410 | 27755 | 18-10 AWG | 100 | 4000 | 0.24# |
| CS410TP | 27756 | 18-10 AWG | 500 | 3000 | 1.15# |
| CS411 | 27760 | 18-8 AWG | 50 | 2000 | 0.24# |

Tuff Pack 

ENTRANCE CAPS

PC 5690

Clamp on service entrance caps permit a weather resistant entrance for type SE cable on rigid, IMC or EMT for pulling service drop conductors. They are assembled with an electrical grade Phenolic insulator with multiple holes.



| CAT. NO. | UPC | SIZE | STD | MSTR | WT/STD |
|----------|-------|--------|-----|------|--------|
| EC50 | 40005 | 1/2" | 25 | | 6.21# |
| EC75 | 40010 | 3/4" | 25 | | 7.18# |
| EC100 | 40015 | 1" | 25 | | 8.97# |
| EC125 | 40020 | 1-1/4" | 10 | | 4.89# |
| EC150 | 40025 | 1-1/2" | 10 | | 7.56# |
| EC200 | 40030 | 2" | 5 | | 6.09# |
| EC250 | 40035 | 2-1/2" | 1 | | 3.83# |
| EC300 | 40040 | 3" | 1 | | 5.43# |
| EC350 | 40045 | 3-1/2" | 1 | | 6.47# |
| EC400 | 40050 | 4" | 1 | | 6.78# |

FEATURES:

- UL Listed
- Die Cast Copper Free Aluminum
- Phenolic Insulator
- Clamp On Style
- Weather Resistant

ENTRANCE ELLS (SLB)

PC 5700

Service Entrance Ells are used with threaded rigid conduit or IMC for providing access to the interior of a conduit system for pulling, splicing, inspection and maintenance.



| CAT. NO. | UPC | SIZE | STD | MSTR | WT/STD |
|----------|-------|--------|-----|------|--------|
| SLB50 | 40100 | 1/2" | 10 | 100 | 2.01# |
| SLB75 | 40105 | 3/4" | 10 | 100 | 2.60# |
| SLB100 | 40110 | 1" | 5 | 50 | 2.15# |
| SLB125 | 40115 | 1-1/4" | 5 | 50 | 3.76# |
| SLB150 | 40120 | 1-1/2" | 2 | 20 | 1.83# |
| SLB200 | 40125 | 2" | 2 | 10 | 2.69# |

FEATURES:

- UL Listed
- Die Cast Copper Free Aluminum
- Assembled with Fiber Gasket & Aluminum Cover
- Weather Resistant

PULLING ELLS

PC 5710

Pulling Ells are used to connect two lengths of threaded rigid conduit or IMC to form a 90° bend and provide access for wire pulling.



| CAT. NO. | UPC | SIZE | STD | MSTR | WT/STD |
|----------|-------|------|-----|------|--------|
| PE1 | 40130 | 1/2" | 10 | 100 | 1.89# |
| PE2 | 40135 | 3/4" | 10 | 100 | 2.69# |
| PE3 | 40140 | 1" | 5 | 25 | 2.50# |

FEATURES:

- UL Listed
- Die Cast
- High Strength Zinc Alloy
- Removable Aluminum Cover & Neoprene Gasket



CONDUIT BODIES

CONDUIT BODIES

PC 5730



Threaded Conduit Bodies are used with rigid conduit to provide access to the interior of a conduit system. They are available as bodies only, or as bodies assembled with covers and gaskets. The flat back design allows the unit to be mounted close to the wall. They are die cast from high strength, copper free aluminum.

FEATURES:

- UL Listed
- Die Cast Copper Free Aluminum
- Without Covers
- Without Gaskets

LB

| CAT. NO. | UPC | SIZE | STD | MSTR | WT/STD |
|----------|-------|--------|-----|------|--------|
| LB50 | 40400 | 1/2" | 10 | 100 | 2.98# |
| LB75 | 40405 | 3/4" | 10 | 50 | 4.41# |
| LB100 | 40410 | 1" | 5 | 25 | 3.15# |
| LB125 | 40415 | 1-1/4" | 2 | 10 | 2.63# |
| LB150 | 40420 | 1-1/2" | 2 | 10 | 2.94# |
| LB200 | 40425 | 2" | 1 | 5 | 2.46# |
| LB250 | 40430 | 2-1/2" | 1 | | 4.71# |
| LB300 | 40435 | 3" | 1 | | 5.40# |
| LB350 | 40440 | 3-1/2" | 1 | | 8.32# |
| LB400 | 40445 | 4" | 1 | | 8.50# |

LR

| | | | | | |
|-------|-------|--------|----|-----|--------|
| LR50 | 40600 | 1/2" | 10 | 100 | 2.52# |
| LR75 | 40605 | 3/4" | 10 | 50 | 4.58# |
| LR100 | 40610 | 1" | 5 | 25 | 3.12# |
| LR125 | 40615 | 1-1/4" | 2 | 10 | 2.89# |
| LR150 | 40620 | 1-1/2" | 2 | 10 | 3.15# |
| LR200 | 40625 | 2" | 1 | 5 | 2.59# |
| LR250 | 40630 | 2-1/2" | 1 | | 6.13# |
| LR300 | 40635 | 3" | 1 | | 9.02# |
| LR350 | 40640 | 3-1/2" | 1 | | 10.24# |
| LR400 | 40645 | 4" | 1 | | 9.60# |

LL

| | | | | | |
|-------|-------|--------|----|-----|-------|
| LL50 | 40550 | 1/2" | 10 | 100 | 2.48# |
| LL75 | 40555 | 3/4" | 10 | 50 | 4.50# |
| LL100 | 40560 | 1" | 5 | 25 | 3.13# |
| LL125 | 40565 | 1-1/4" | 2 | 10 | 2.47# |
| LL150 | 40570 | 1-1/2" | 2 | 10 | 2.98# |
| LL200 | 40575 | 2" | 1 | 5 | 2.61# |
| LL250 | 40580 | 2-1/2" | 1 | | 4.69# |
| LL300 | 40585 | 3" | 1 | | 6.44# |
| LL350 | 40590 | 3-1/2" | 1 | | 9.13# |
| LL400 | 40595 | 4" | 1 | | 9.22# |

C

| | | | | | |
|------|-------|--------|----|-----|-------|
| C50 | 40700 | 1/2" | 10 | 100 | 2.44# |
| C75 | 40705 | 3/4" | 10 | 50 | 4.17# |
| C100 | 40710 | 1" | 5 | 25 | 2.42# |
| C125 | 40715 | 1-1/4" | 2 | 10 | 3.16# |
| C150 | 40720 | 1-1/2" | 2 | 10 | 2.84# |
| C200 | 40725 | 2" | 1 | 5 | 2.55# |
| C250 | 40730 | 2-1/2" | 1 | | 5.25# |
| C300 | 40735 | 3" | 1 | | 5.72# |
| C350 | 40740 | 3-1/2" | 1 | | 9.51# |
| C400 | 40745 | 4" | 1 | | 9.00# |

T

| | | | | | |
|------|-------|--------|----|-----|--------|
| T50 | 40800 | 1/2" | 10 | 100 | 2.99# |
| T75 | 40805 | 3/4" | 10 | 50 | 4.43# |
| T100 | 40810 | 1" | 5 | 25 | 3.27# |
| T125 | 40815 | 1-1/4" | 2 | 10 | 3.76# |
| T150 | 40820 | 1-1/2" | 2 | 10 | 3.29# |
| T200 | 40825 | 2" | 1 | 5 | 5.38# |
| T250 | 40830 | 2-1/2" | 1 | | 5.77# |
| T300 | 40835 | 3" | 1 | | 6.35# |
| T350 | 40840 | 3-1/2" | 1 | | 11.30# |
| T400 | 40845 | 4" | 1 | | 9.70# |

CONDUIT BODIES WITH COVER & GASKET

PC 5720

Threaded Conduit Bodies with cover and gasket are used with rigid conduit to provide access to the interior of a conduit system. They are available as bodies only, or as bodies assembled with covers and gaskets. The flat back design allows the unit to be mounted close to the wall. They are die cast from high strength, copper free aluminum.



FEATURES:

- UL Listed
- Die Cast Copper Free Aluminum
- With Covers
- With Neoprene Gaskets

LB

| CAT. NO. | UPC | SIZE | STD | MSTR | WT/STD |
|----------|-------|--------|-----|------|--------|
| LB50CG | 10722 | 1/2" | 10 | 100 | 2.93# |
| LB75CG | 10724 | 3/4" | 10 | 50 | 4.10# |
| LB100CG | 10726 | 1" | 5 | 25 | 3.58# |
| LB125CG | 10728 | 1-1/4" | 2 | 10 | 2.96# |
| LB150CG | 10730 | 1-1/2" | 2 | 10 | 3.25# |
| LB200CG | 10732 | 2" | 1 | 5 | 2.80# |
| LB250CG | 10734 | 2-1/2" | 1 | | 5.10# |
| LB300CG | 10736 | 3" | 1 | | 6.20# |
| LB350CG | 10738 | 3-1/2" | 1 | | 9.54# |
| LB400CG | 10740 | 4" | 1 | | 10.09# |

LR

| | | | | | |
|---------|-------|--------|----|-----|--------|
| LR50CG | 10762 | 1/2" | 10 | 100 | 2.98# |
| LR75CG | 10764 | 3/4" | 10 | 50 | 5.21# |
| LR100CG | 10766 | 1" | 5 | 25 | 3.62# |
| LR125CG | 10768 | 1-1/4" | 2 | 10 | 3.06# |
| LR150CG | 10770 | 1-1/2" | 2 | 10 | 3.33# |
| LR200CG | 10772 | 2" | 1 | 5 | 2.80# |
| LR250CG | 10774 | 2-1/2" | 1 | | 6.43# |
| LR300CG | 10776 | 3" | 1 | | 9.60# |
| LR350CG | 10778 | 3-1/2" | 1 | | 11.39# |
| LR400CG | 10780 | 4" | 1 | | 12.00# |

LL

| | | | | | |
|---------|-------|--------|----|-----|--------|
| LL50CG | 10742 | 1/2" | 10 | 100 | 3.00# |
| LL75CG | 10744 | 3/4" | 10 | 50 | 5.17# |
| LL100CG | 10746 | 1" | 5 | 25 | 3.52# |
| LL125CG | 10748 | 1-1/4" | 2 | 10 | 2.93# |
| LL150CG | 10750 | 1-1/2" | 2 | 10 | 3.22# |
| LL200CG | 10752 | 2" | 1 | 5 | 2.84# |
| LL250CG | 10754 | 2-1/2" | 1 | | 5.26# |
| LL300CG | 10756 | 3" | 1 | | 7.02# |
| LL350CG | 10758 | 3-1/2" | 1 | | 10.35# |
| LL400CG | 10760 | 4" | 1 | | 10.80# |

C

| | | | | | |
|--------|-------|--------|----|-----|--------|
| C50CG | 10702 | 1/2" | 10 | 100 | 2.82# |
| C75CG | 10704 | 3/4" | 10 | 50 | 4.79# |
| C100CG | 10706 | 1" | 5 | 25 | 2.87# |
| C125CG | 10708 | 1-1/4" | 2 | 10 | 2.88# |
| C150CG | 10710 | 1-1/2" | 2 | 10 | 2.90# |
| C200CG | 10712 | 2" | 1 | 5 | 2.65# |
| C250CG | 10714 | 2-1/2" | 1 | | 5.67# |
| C300CG | 10716 | 3" | 1 | | 6.28# |
| C350CG | 10718 | 3-1/2" | 1 | | 9.90# |
| C400CG | 10720 | 4" | 1 | | 10.35# |

T

| | | | | | |
|--------|-------|--------|----|-----|--------|
| T50CG | 10782 | 1/2" | 10 | 100 | 3.80# |
| T75CG | 10784 | 3/4" | 10 | 50 | 4.25# |
| T100CG | 10786 | 1" | 5 | 25 | 3.63# |
| T125CG | 10788 | 1-1/4" | 2 | 10 | 4.03# |
| T150CG | 10790 | 1-1/2" | 2 | 10 | 3.55# |
| T200CG | 10792 | 2" | 1 | 5 | 5.85# |
| T250CG | 10794 | 2-1/2" | 1 | | 7.06# |
| T300CG | 10796 | 3" | 1 | | 7.63# |
| T350CG | 10798 | 3-1/2" | 1 | | 12.52# |
| T400CG | 10802 | 4" | 1 | | 10.95# |

TB

| | | | | | |
|---------|-------|--------|----|-----|-------|
| TB50CG | 81526 | 1/2" | 10 | 100 | 3.80# |
| TB75CG | 81527 | 3/4" | 10 | 50 | 4.25# |
| TB100CG | 81528 | 1" | 5 | 25 | 3.63# |
| TB125CG | 81529 | 1-1/4" | 2 | 10 | 4.03# |
| TB150CG | 81530 | 1-1/2" | 2 | 10 | 3.55# |
| TB200CG | 81531 | 2" | 1 | | 5.85# |

X

| | | | | | |
|--------|-------|--------|----|-----|-------|
| X50CG | 81532 | 1/2" | 10 | 100 | 3.80# |
| X75CG | 81533 | 3/4" | 10 | 50 | 4.25# |
| X100CG | 81534 | 1" | 5 | 25 | 3.63# |
| X125CG | 81535 | 1-1/4" | 2 | 10 | 4.03# |
| X150CG | 81536 | 1-1/2" | 2 | 10 | 3.55# |
| X200CG | 81537 | 2" | 2 | | 5.85# |

FIBER & NEOPRENE GASKETS

PC 5790, 5800



FEATURES:

- Fiber
- Neoprene

Gaskets are available in fiber or neoprene and are used to make a conduit body weather resistant.

FIBER GASKETS - PC 5790

| CAT. NO. | UPC | SIZE | STD | MSTR | WT/STD |
|----------|-------|----------------|-----|------|--------|
| G50 | 40200 | 1/2" | 50 | 500 | 0.36# |
| G75 | 40205 | 3/4" | 50 | 500 | 0.48# |
| G100 | 40210 | 1" | 50 | 250 | 0.64# |
| G125/150 | 40215 | 1-1/4 & 1-1/2" | 50 | 250 | 1.31# |
| G200 | 40220 | 2" | 25 | 50 | 0.98# |
| G250/300 | 40225 | 2-1/2 & 3" | 25 | | 2.30# |
| G350/400 | 40230 | 3-1/2 & 4" | 25 | | 3.10# |

NEOPRENE GASKETS - PC 5800

| CAT. NO. | UPC | SIZE | STD | MSTR | WT/STD |
|-----------|-------|----------------|-----|------|--------|
| GN50 | 40250 | 1/2" | 50 | 500 | 0.58# |
| GN75 | 40255 | 3/4" | 50 | 500 | 0.78# |
| GN100 | 40260 | 1" | 50 | 250 | 1.00# |
| GN125/150 | 40265 | 1-1/4 & 1-1/2" | 50 | 100 | 2.21# |
| GN200 | 40270 | 2" | 25 | 50 | 1.84# |
| GN250/300 | 40275 | 2-1/2 & 3" | 25 | | 4.60# |
| GN350/400 | 40280 | 3-1/2 & 4" | 25 | | 6.25# |

ALUMINUM COVERS

PC 5760



FEATURES:

- UL Listed
- Captive Plated Screws

Aluminum covers are stamped from high strength aluminum and are used with all styles of aluminum conduit bodies.

| CAT. NO. | UPC | SIZE | STD | MSTR | WT/STD |
|-----------|-------|----------------|-----|------|--------|
| BC50 | 40300 | 1/2" | 50 | 500 | 2.40# |
| BC75 | 40305 | 3/4" | 50 | 500 | 3.13# |
| BC100 | 40310 | 1" | 25 | 250 | 2.22# |
| BC125/150 | 40315 | 1-1/4 & 1-1/2" | 10 | 100 | 1.67# |
| BC200 | 40320 | 2" | 5 | 50 | 1.42# |
| BC250/300 | 40325 | 2-1/2 & 3" | 5 | 50 | 4.03# |
| BC350/400 | 40330 | 3-1/2 & 4" | 5 | 50 | 4.12# |

SPIDER PLATE

PC 5910



FEATURES:

- Steel
- Universal

Spider plates are a universal mounting plate which allows mounting fixtures to a 3" or 4" round box regardless of screw hole location.

| CAT. NO. | UPC | DESCRIPTION | STD | MSTR | WT/STD |
|----------|-------|---------------------------|-----|------|--------|
| SP34 | 42090 | Adapts 3-1/4" to 4" boxes | 20 | 200 | 3.00# |

PC 5390

DOTTIE PIPE SUPPORT

The Dottie Pipe Support is the first and only **UL Listed** pipe support in the industry. This new and innovative product features Dual Channel technology, and is constructed of high strength polymers ABS and AES for increased structural support and UV resistance. Dual channel technology creates the **MOST VERSATILE PIPE SUPPORT IN THE INDUSTRY**. Strut clamps can be fastened to the large channel while conduit hangers and leveling systems can be fastened to the smaller channel. The Dottie Pipe support comes at a standard length of 4 feet, and is easily cut to required specifications. Lightweight and highly resistant material guarantee an extremely durable product. A single 4" support has a load resistance of 522 Lbs. Dottie's cut to length pipe supports **CUT COSTS, AND INCREASE INSTALLATION FLEXIBILITY**.

FEATURES:

- UL Listed
- Built-in Channel Technology
- High Strength ABS/AES Materials
- Dual Channel Configuration

| CAT. NO. | UPC | DESCRIPTION | STD | MSTR | WT/STD |
|----------|-------|-------------------------|-----|------|--------|
| DPS | 84932 | Dottie 4ft Pipe Support | 1 | | 3.90# |



DUAL CHANNEL TECHNOLOGY

SUPERIOR LOAD RESISTANCE

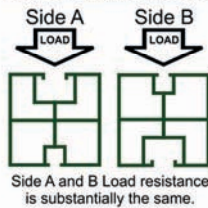

| Cut to Length | Load Resistance [lbs] |
|---------------|-----------------------|
| 4" | 522 |
| 5" | 650 |
| 6" | 778 |
| 8" | 1038 |
| 12" | 1560 |
| 18" | 2336 |
| 24" | 3119 |



SMALL CHANNEL FOR BOLTS & T-ROD



LARGE CHANNEL FOR STRUT CLAMPS

CUT TO DESIRED LENGTH



USE WITH THESE DOTTIE STRUT COMPONENTS



FITTINGS & STAMPINGS

MULTI-GUARD COVERS

PC 5912

FEATURES:

- UL Listed
- Single & Double Gang
- Weatherproof
- Mounts Vertically or Horizontally

“While In-use” weatherproof receptacle cover meets NEC 410-57(b) code. Protection from rain, sleet and snow with cord set plugged in for unattended receptacles. Designed to meet NEC 210-60(b) code.

SINGLE GANG

| CAT. NO. | UPC | DESCRIPTION | DEPTH | STD | MSTR | WT/STD |
|----------|-------|----------------------|--------|-----|------|--------|
| FG1100C | 10901 | Standard Depth Cover | 2-1/4" | 1 | 10 | 0.45# |
| FG1110C | 10902 | Deep Cover | 3-1/8" | 1 | 10 | 0.49# |

14 Configurations, One Cover
 Single Gang Vertical or Horizontal.
 Includes 3 Patented Inserts
 4 Rounds; Toggle; Duplex;
 GFCI 1-3/8"; 1-5/8"; 1-3/4"; 2-1/8"



Mounts Vertically or Horizontally

Plug and Outlet Protection for any Single Gang Application.
 The standard Depth Cover recommended for 16 gauge or lighter cord sets for vending machines, holiday lighting, landscape lighting and portable signs.



DOUBLE GANG

| CAT. NO. | UPC | DESCRIPTION | DEPTH | STD | MSTR | WT/STD |
|----------|-------|----------------------|--------|-----|------|--------|
| FG1220C | 10911 | Standard Depth Cover | 2-1/4" | 1 | 10 | 0.55# |

70 Configurations, One Cover
 Any Two Gang Application.
 Includes 6 Snap Together
 Patented Inserts.

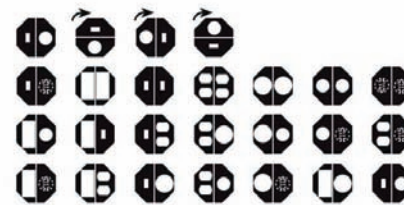

Mounts Vertically or Horizontally

Plug and Outlet Protection for any Two Gang Application.
 The standard Depth Cover recommended for 16 gauge or lighter cord sets for vending machines, holiday lighting, landscape lighting and portable signs.



FITTINGS & STAMPINGS

TECH TALK



Plastic In-Use Covers

Flexible and easy to install, “While in Use” Covers are ideal for single-gang, double-gang, horizontal and vertical outdoor applications in a wet location.

- Ensure compliance with Article 406.8(B)(1) of the National Electronic Code which states that 15 to 20 Ampere, 125 and 250 volt receptacles installed in a wet location shall have an enclosure that is weatherproof whether or not the attachment plug cap is inserted.
- Meets UL and CSA Cold Impact Testing at -60°F (-51°C)
- Clear UV Stabilized Polycarbonate Covers for long life in high abuse outdoor installations
- All Covers are shipped with gasket, mounting screws, base and cover assembly and two inserts
- Patented inserts for all wiring devices



CHEMICALS & TAPE



CHEMICALS & TAPE

SECTION D



PVC COLOR CODING TAPE

PC 5350, 5330

PVC Tape is used for insulation and protection over wires and connectors or over splicing and filler compounds; the holding of high voltage electrical appliances; wire harnessing and home maintenance.



| CAT. NO. | UPC | DIMENSIONS | COLOR | STD | MSTR | WT/STD |
|----------|-------|-------------------|--------|-----|------|--------|
| 360 | 15890 | 3/4" x 60' x 7Mil | Black | 10 | 200 | 1.81# |
| 360BLU | 84755 | 3/4" x 60' x 7Mil | Blue | 10 | 200 | 1.81# |
| 360BRN | 84756 | 3/4" x 60' x 7Mil | Brown | 10 | 200 | 1.81# |
| 360GRN | 84757 | 3/4" x 60' x 7Mil | Green | 10 | 200 | 1.81# |
| 360GRY | 84758 | 3/4" x 60' x 7Mil | Gray | 10 | 200 | 1.81# |
| 360ORG | 84759 | 3/4" x 60' x 7Mil | Orange | 10 | 200 | 1.81# |
| 360RED | 84760 | 3/4" x 60' x 7Mil | Red | 10 | 200 | 1.81# |
| 360VLT | 84765 | 3/4" x 60' x 7Mil | Violet | 10 | 200 | 1.81# |
| 360WHT | 84761 | 3/4" x 60' x 7Mil | White | 10 | 200 | 1.81# |
| 360YEL | 84762 | 3/4" x 60' x 7Mil | Yellow | 10 | 200 | 1.81# |

FEATURES:

- UL Listed
- 600 Volt Rated, 80° C, 176° F
- 7 Mil 3/4" x 60 Ft.
- Individual Cello Wrap - 10 Per STD Sleeve
- A Low Lead Product

SPECIFICATIONS

| PROPERTY | VALUE | UNIT | TEST METHOD |
|------------------------|-------|------|--------------|
| PHYSICAL | | | |
| Thickness | 0.007 | inch | ASTHM-D-1000 |
| | 0.18 | mm | |
| | 7 | mil | |
| Tensile Strength | 30 | N/cm | ASTHM-D-1000 |
| Elongation | 250 | % | ASTHM-D-1000 |
| Adhesion to Steel | 1.5 | N/cm | ASTHM-D-1000 |
| Adhesion to Backing | .15 | N/cm | ASTHM-D-1000 |
| Flame Resistance | <2 | sec | ASTHM-D-1000 |
| Temperature Resistance | 80° | C | ASTHM-D-1000 |
| | 176° | F | |
| ELECTRICAL | | | |
| Dielectric Strength | 600 | V | UL510 |



RUBBER TAPE

PC 5370

Rubber Tape is used in combination with friction and vinyl tape for primary insulation up to 600 volts and for use around split bolt connections, terminal lugs and compression connectors. It is used in insulating and waterproof applications, and easily conforms to irregular shapes and surfaces yielding a void free, electrically stable buildup. It is compatible with all extruded dielectric cable insulations.



FEATURES:

- UL Listed
- 3/4" x 22 Ft.
- 30 Mil

| CAT. NO. | UPC | DIMENSIONS | STD | MSTR | WT/STD |
|----------|-------|------------|-----|------|--------|
| 822 | 28120 | 3/4" x 22' | 10 | 100 | 3.60# |

FRICITION TAPE

PC 5360

Friction Tape is used for providing mechanical protection against abrasion and penetration of cable, splices and wire. Also used as a temporary binding and harnessing tape and a multitude of miscellaneous general purpose uses. When applied over tool handles, it creates a non-slip surface.



FEATURES:

- UL Listed
- 3/4" x 60 Ft.
- 600 Volt Rated
- Adhesive Compound on Both Sides

| CAT. NO. | UPC | DIMENSIONS | STD | MSTR | WT/STD |
|----------|-------|------------|-----|------|--------|
| 860 | 28130 | 3/4" x 60' | 10 | 100 | 3.20# |



TAPE & BARRICADE TAPE

DUCT TAPE

PC 5380



Duct Tape will adhere to all types of surfaces. The polyethylene coated cloth construction provides superior mechanical strength and conforms well to irregular surfaces. It is excellent for bundling, patching and sealing. It tears straight and is curl resistant.

FEATURES:

- 2" x 60 Yards
- Temperature Rating 200° F
- 9 Mil - Cloth Backing
- Individual Cello Wrap
- Colors Available Upon Request

| CAT. NO. | UPC | DIMENSIONS | COLOR | STD | MSTR | WT/STD |
|----------|-------|-------------|--------|-----|------|--------|
| DT260 | 28100 | 2" x 60 yds | Silver | 12 | 24 | 19.50# |
| DT260Red | 81064 | 2" x 60 yds | Red | 12 | 24 | 19.50# |

PIPE WRAP-PVC

PC 5420



Pipe Wrap is a polyvinyl chloride film coated with a rubber resin adhesive which protects pipe, joints, conduit and couplings for overhead or direct burial applications. It is corrosion and puncture resistant.

FEATURES:

- 1", 2" & 4" Widths
- UPC Approved
- 10 Mil and 20 Mil
- Abrasion Resistant
- Provides Electrical Protection
- A Low Lead Product
- Surface Marked



| CAT. NO. | UPC | DIMENSIONS | MIL | STD | MSTR | WT/STD |
|----------|-------|------------|--------|-----|------|--------|
| 110 | 28110 | 1" x 100' | 10 Mil | 48 | | 29.28# |
| 210 | 28140 | 2" x 100' | 10 Mil | 24 | | 28.80# |
| 410 | 28142 | 4" x 100' | 10 Mil | 12 | | 27.60# |
| 220 | 28145 | 2" x 100' | 20 Mil | 24 | | 53.52# |

MASKING TAPE

PC 5410

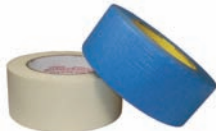

Masking Tape is a general purpose tape which is tan in color and is supplied for indoor applications. The outdoor version, 200MTBlue, is blue in color and UV resistant. It has a low tack and is easily removed where application and cleanup are several days apart.

FEATURES:

- 2"
- 60 Yard Rolls
- Tan & Blue
- Blue is UV Resistant

MASKING TAPE

| CAT. NO. | UPC | DIMENSIONS | STD | MSTR | WT/STD |
|----------|-------|-------------|-----|------|--------|
| 200MT | 30020 | 2" x 60 yds | 24 | | 15.12# |

OUTDOOR MASKING TAPE (BLUE)

| | | | | | |
|-----------|-------|-------------|----|--|--------|
| 200MTBlue | 28143 | 2" x 60 yds | 24 | | 16.68# |
|-----------|-------|-------------|----|--|--------|

BARRICADE TAPE

PC 5320



Barricade Tape is used for marking physical hazards or off limit areas. Other legends & colors on request. Meets OSHA 1910.144 for marking physical hazards.

3" x 1,000 FT.

| CAT. NO. | UPC | LEGEND | COLOR | STD | MSTR | WT/STD |
|----------|-------|-------------------------|--------------|-----|------|--------|
| BT5 | 16330 | Caution Caution Caution | Yellow | 1 | 12 | 4.86# |
| BT8 | 16332 | Caution Do Not Enter | Yellow | 1 | 12 | 4.86# |
| BT12 | 16335 | Caution High Voltage | Yellow | 1 | 12 | 4.86# |
| BT13 | 16334 | Caution Keep Out | Yellow | 1 | 12 | 4.86# |
| BT19 | 16336 | Caution Open Trench | Yellow | 1 | 12 | 4.86# |
| BT31 | 16338 | Alternating Stripes | Black/Yellow | 1 | 12 | 4.86# |
| BT32 | 16339 | Alternating Stripes | Red/White | 1 | 12 | 4.86# |
| BT49 | 16387 | Danger Keep Out | Red | 1 | 12 | 4.86# |

3" x 300 Ft.

| | | | | | | |
|--------|-------|-------------------------|--------|---|----|-------|
| BT5X3 | 16331 | Caution Caution Caution | Yellow | 1 | 12 | 1.36# |
| BT8X3 | 16333 | Caution Do Not Enter | Yellow | 1 | 12 | 1.36# |
| BT13X3 | 16337 | Caution Keep Out | Yellow | 1 | 12 | 1.36# |

FEATURES:

- Reusable Polyethylene
- Continuous Warning
- 3" Wide x 1,000 or 300 Ft.
- Custom Legends Available

UNDERGROUND TAPE

Underground Tape protects buried utility lines and is placed 12" above buried pipes, cables and conduits before final backfilling. Other legends & colors available on request.

3" X 1,000 FT. 4 MIL

| CAT. NO. | UPC | LEGEND | | | COLOR | STD | MSTR | WT/STD |
|----------|-------|---------|--------|-------------------------|--------|-----|------|--------|
| UT4D | 16704 | Caution | Buried | Cable TV Line Below | Orange | 1 | 6 | 4.49# |
| UT7D | 16340 | Caution | Buried | Electric Line Below | Yellow | 1 | 6 | 4.49# |
| UT8D | 16342 | Caution | Buried | Electric Line Below | Red | 1 | 6 | 4.49# |
| UT11D | 16711 | Caution | Buried | High Voltage Line Below | Yellow | 1 | 6 | 4.49# |
| UT12D | 16712 | Caution | Buried | High Voltage Line Below | Red | 1 | 6 | 4.49# |
| UT17D | 16717 | Caution | Buried | Telephone Line Below | Orange | 1 | 6 | 4.49# |
| UT19D | 16719 | Caution | Buried | Utilities Underground | Yellow | 1 | 6 | 4.49# |
| UT20D | 16720 | Caution | Buried | Utility Line Below | Yellow | 1 | 6 | 4.49# |
| UT43D | 16743 | Caution | Buried | Cable Line Below | Orange | 1 | 6 | 4.49# |
| UT44D | 16744 | Caution | Buried | Fiber Optic Line Below | Orange | 1 | 6 | 4.49# |

6" X 1,000 FT. 4 MIL

| | | | | | | | | |
|-------|-------|---------|--------|-------------------------|--------|---|---|-------|
| UT25D | 16725 | Caution | Buried | Cable TV Line Below | Orange | 1 | 2 | 9.02# |
| UT28D | 16344 | Caution | Buried | Electric Line Below | Yellow | 1 | 2 | 9.02# |
| UT29D | 16346 | Caution | Buried | Electric Line Below | Red | 1 | 2 | 9.02# |
| UT32D | 16732 | Caution | Buried | High Voltage Line Below | Yellow | 1 | 2 | 9.02# |
| UT33D | 16733 | Caution | Buried | High Voltage Line Below | Red | 1 | 2 | 9.02# |
| UT38D | 16738 | Caution | Buried | Telephone Line Below | Orange | 1 | 2 | 9.02# |
| UT40D | 16740 | Caution | Buried | Utilities Underground | Yellow | 1 | 2 | 9.02# |
| UT41D | 16741 | Caution | Buried | Utility Line Below | Yellow | 1 | 2 | 9.02# |
| UT46D | 16746 | Caution | Buried | Cable Line Below | Orange | 1 | 2 | 9.02# |
| UT47D | 16747 | Caution | Buried | Fiber Optic Line Below | Orange | 1 | 2 | 9.02# |

DETECTABLE TAPE

Detectable Tape protects buried utility lines and is placed above buried pipes, cables and conduits. It is easily located with an industrial grade non-ferrous metal detector, for use before you dig; its highly visible colors make it easy to locate after the dig has begun. Other legends, colors available on request.

3" X 1,000 FT.

| CAT. NO. | UPC | LEGEND | | | COLOR | STD | MSTR | WT/STD |
|----------|-------|---------|--------|-------------------------|--------|-----|------|--------|
| DU01 | 16350 | Caution | Buried | Electric Line Below | Red | 1 | 4 | 6.07# |
| DU05 | 16360 | Caution | Buried | Telephone Line Below | Orange | 1 | 4 | 6.07# |
| DU08 | 16364 | Caution | Buried | CATV Line Below | Orange | 1 | 4 | 6.07# |
| DU09 | 16366 | Caution | Buried | High Voltage Line Below | Red | 1 | 4 | 6.07# |
| DU10 | 16368 | Caution | Buried | Fiber Optic Line Below | Orange | 1 | 4 | 6.07# |

6" X 1,000 FT.

| | | | | | | | | |
|-------|-------|---------|--------|-------------------------|--------|---|---|--------|
| DU601 | 16352 | Caution | Buried | Electric Line Below | Red | 1 | 2 | 13.72# |
| DU605 | 16370 | Caution | Buried | Telephone Line Below | Orange | 1 | 2 | 13.72# |
| DU608 | 16372 | Caution | Buried | CATV Line Below | Orange | 1 | 2 | 13.72# |
| DU609 | 16374 | Caution | Buried | High Voltage Line Below | Red | 1 | 2 | 13.72# |
| DU610 | 16376 | Caution | Buried | Fiber Optic Line Below | Orange | 1 | 2 | 13.72# |

PC 5320



FEATURES:

- Non Adhesive Polyethylene
- Continuous Warning
- 4 Mil
- 3" & 6" Widths x 1,000 Ft.
- Custom Legends Available

PC 5325



FEATURES:

- Foil Bonded Polyethylene
- Continuous Warning
- 4.5 Mil
- 3" & 6" Widths x 1,000 Ft.
- Custom Legends Available

TECH TALK



Barricade Tape: Barricade tapes will consist of high visibility safety yellow or red polyethylene with bold black letters. Standard Letter height is two inches (2"). Tape helps prevent accidents by increasing visibility of hazards and can be tied, stapled or nailed in place.

Underground Tape: Non-Detectable warning tape for the protection, location and identification of underground utility installations. Consists of a nominal 4.0 mil overall thickness inert plastic film formulated to resist degradation due to acid and alkalies found in soils. Product is lead free.

Detectable Tape: Detectable warning tape consists of nominal 4.5 mil (.0045") overall thickness, with a solid aluminum foil core. The imprinted warning message is "Buried, or Encased" to prevent ink rub-off, and is impervious to acid, alkalis and other destructive elements found in soil. The imprint is as such that it allows for total reflectivity. Use of an industrial grade non-ferrous metal detector is used when location is needed.



CABLE TIES & MOUNTING BASES

CABLE TIES - NYLON

PC 5970



Cable ties from L.H. Dottie – the perfect way to bundle, secure and identify. Consistent quality from statistically controlled molding processes insure the highest tensile strength with the lowest insertion force. Meets military specifications, AS-33671, for dimensions, moisture content, tensile strength, life cycles, fluid immersion, melting point, and corrosion.

FEATURES:

- Made In U.S.A.
- UL Listed
- Manufactured with Filtered Nylon 6/6
- Angled Tail
- One Piece Design, Transition Rails, And 3 Tooth Pawl
- Rounded Edges
- Finger Grips
- Bulk Available*

STANDARD DUTY CABLE TIES - NYLON

PC 5970



| CAT. NO. | UPC | COLOR | LENGTH | WIDTH | THICKNESS | TENSILE | BUNDLE DIA | STD BAG | MSTR | WT/STD |
|----------|-------|----------|--------|-------|-----------|---------|------------|---------|-------|--------|
| DT4 | 50004 | Natural | 4.12" | .095" | .042" | 18 lb. | .874" | 100 | 1,000 | 0.07# |
| DT4B | 50504 | UV Black | 4.12" | .095" | .042" | 18 lb. | .874" | 100 | 1,000 | 0.07# |
| DT5 | 50005 | Natural | 5.84" | .140" | .049" | 40 lb. | 1.437" | 100 | 1,000 | 0.14# |
| DT5B | 50505 | UV Black | 5.84" | .140" | .049" | 40 lb. | 1.437" | 100 | 1,000 | 0.14# |
| DT6 | 50006 | Natural | 7.56" | .180" | .052" | 50 lb. | 1.875" | 100 | 1,000 | 0.29# |
| DT6B | 50506 | UV Black | 7.56" | .180" | .052" | 50 lb. | 1.875" | 100 | 1,000 | 0.29# |
| DT11 | 50011 | Natural | 11.25" | .180" | .052" | 50 lb. | 3.062" | 100 | 500 | 0.38# |
| DT11B | 50511 | UV Black | 11.25" | .180" | .052" | 50 lb. | 3.062" | 100 | 500 | 0.38# |
| DT14 | 50014 | Natural | 14.25" | .180" | .052" | 50 lb. | 4.000" | 100 | 500 | 0.48# |
| DT14B | 50514 | UV Black | 14.25" | .180" | .052" | 50 lb. | 4.000" | 100 | 500 | 0.48# |

*Add "Bulk" to the end of part number for Bulk bag, See Item Master

Mil-Spec available upon request

HEAVY DUTY CABLE TIES - NYLON

PC 5970



| CAT. NO. | UPC | COLOR | LENGTH | WIDTH | THICKNESS | TENSILE | BUNDLE DIA | STD BAG | MSTR | WT/STD |
|----------|-------|----------|--------|-------|-----------|---------|------------|---------|------|--------|
| DT14H | 51014 | Natural | 15.09" | .300" | .076" | 120 lb. | 4.06" | 50 | 500 | 0.52# |
| DT14HB | 51514 | UV Black | 15.09" | .300" | .076" | 120 lb. | 4.06" | 50 | 500 | 0.52# |
| DT21H | 51021 | Natural | 25.25" | .340" | .090" | 175 lb. | 7.18" | 50 | 500 | 0.87# |
| DT21HB | 51521 | UV Black | 25.25" | .340" | .090" | 175 lb. | 7.18" | 50 | 500 | 0.87# |
| DT36H | 51034 | Natural | 37.25" | .340" | .090" | 175 lb. | 11.00" | 50 | 500 | 1.54# |
| DT36HB | 51534 | UV Black | 37.25" | .340" | .090" | 175 lb. | 11.00" | 50 | 500 | 1.54# |
| DT48G | 81705 | Gray | 48.56" | .340" | .090" | 175 lb. | 14.50" | 50 | 500 | 1.65# |

MOUNTING HOLE CABLE TIES - NYLON

PC 5970



| CAT. NO. | UPC | COLOR | LENGTH | SCREW HOLE | WIDTH | THK. | TENSILE | BUNDLE DIA | STD BAG | MSTR | WT/STD |
|----------|-------|----------|--------|------------|-------|-------|---------|------------|---------|-------|--------|
| DTM6 | 52006 | Natural | 8.0" | No.10 | .177" | .052" | 50 lb. | 1.75" | 100 | 1,000 | 0.34# |
| DTM6B | 52506 | UV Black | 8.0" | No.10 | .177" | .052" | 50 lb. | 1.75" | 100 | 1,000 | 0.34# |
| DTM14 | 52014 | Natural | 14.5" | No.10 | .177" | .053" | 50 lb. | 4.00" | 100 | 500 | 0.52# |
| DTM14B | 52514 | UV Black | 14.5" | No.10 | .177" | .053" | 50 lb. | 4.00" | 100 | 500 | 0.52# |

MOUNTING BASES - NYLON

PC 5970



| CAT. NO. | UPC | COLOR | SCREW HOLE | WTH. | HEIGHT | ADHESIVE | SLOT HEIGHT | SLOT WIDTH | STD BAG | MSTR | WT/STD |
|----------|-------|---------|------------|------|--------|----------|-------------|------------|---------|-------|--------|
| DT75S | 51075 | Natural | No.4 | .74" | .19" | Rubber | .05" | .20" | 100 | 1,000 | 0.20# |
| DT75SB | 51076 | Black | No.4 | .74" | .19" | Rubber | .05" | .20" | 100 | 1,000 | 0.20# |
| DT100S | 51100 | Natural | No.6 | .99" | .20" | Rubber | .06" | .20" | 100 | 1,000 | 0.50# |
| DT100SB | 51102 | Black | No.6 | .99" | .20" | Rubber | .06" | .20" | 100 | 1,000 | 0.50# |

CHEMICALS & TAPE



CABLE TIE PACKS & AIR HANDLING CABLE TIES

STANDARD DOTTIE PACK - NYLON

PC 5970

Our standard Dottie Pack is an assortment of 400 ties in a 3 compartment storage box and includes 200 - 4.12", 100 - 7.56" and 100 - 11.25" sizes. Available in both Natural and UV Rated Black.

FEATURES:

- Saves Time With The 3 Easy Access Doors
- No More Sorting - Individual Compartments Eliminate Hassle And Time Spent Searching Through Various Sizes
- Easy Storage Designed To Fit Into Tool Boxes Or Hang On Peg Boards
- Exceptional Value Compared To Purchasing Items Separately
- Filtered Nylon 6/6



| CAT. NO. | UPC | COLOR | CONTENTS | PART QTY | LGN. | WTH. | THK. | TENSILE | DIA | STDMSTR | WT/STD | |
|----------|-------|----------|----------|----------|--------|-------|-------|---------|--------|---------|--------|-------|
| 450 | 15970 | Natural | DT4 | 200 | 4.12" | .095" | .042" | 18 lb. | .874" | 1 | 20 | 1.05# |
| | | | DT6 | 100 | 7.56" | .180" | .052" | 50 lb. | 1.875" | 1 | 20 | |
| | | | DT11 | 100 | 11.25" | .180" | .052" | 50 lb. | 3.062" | | | |
| 450B | 15972 | UV Black | DT4B | 200 | 4.12" | .095" | .042" | 18 lb. | .874" | 1 | 20 | 1.05# |
| | | | DT6B | 100 | 7.56" | .180" | .052" | 50 lb. | 1.875" | 1 | 20 | |
| | | | DT11B | 100 | 11.25" | .180" | .052" | 50 lb. | 3.062" | | | |

AIR HANDLING CABLE TIES - NYLON

PC 5965

Air handling cable ties are UL Listed suitable for use in air handling spaces (Plenums) in accordance with the Section 300.22 (C) and (D) of the National Electrical Code and Rules 12-010 (3), (4), and (5) and 12-020 of the Canadian Electrical Code, Part 1.

FEATURES:

- Meets UL 1565 & 62275 Low Smoke Generation, Low Heat Release, And Mechanical Strength Test
- UL Listed
- Ideal For Air Handling Spaces
- Mounting Hole Style Secures To Surfaces With One Mechanical Fastener



| CAT. NO. | UPC | COLOR | LGN. | WTH. | THK. | TENSILE | BUNDLE DIA | STD BAG | MSTR | WT/STD |
|----------|-------|----------|--------|-------|-------|---------|------------|---------|------|--------|
| DTP6 | 81206 | Burgundy | 7.56" | .180" | .052" | 50 lb. | 1.875" | 100 | 1000 | 0.29# |
| DTP11 | 81207 | Burgundy | 11.25" | .180" | .052" | 50 lb. | 3.062" | 100 | 500 | 0.38# |
| DTP14 | 81208 | Burgundy | 14.25" | .180" | .052" | 50 lb. | 4.125" | 100 | 500 | 0.48# |

MOUNTING HOLE

| CAT. NO. | UPC | COLOR | LGN. | WTH. | THK. | TENSILE | BUNDLE DIA | STD BAG | MSTR | WT/STD |
|----------|-------|----------|-------|-------|-------|---------|------------|---------|------|--------|
| DTMP6 | 81209 | Burgundy | 8.00" | .177" | .052" | 50 lb. | 1.750" | 100 | 1000 | 0.34# |

CABLE TIE INSTALLATION TOOL

PC 5966

FEATURES:

- Save time with this automatic cut off tool
- Quickly tensions and automatically cuts off excess strap
- No sharp protrusions to cause snags, cuts or abrasions to cables, hoses or user
- Produces consistent tension from tie to tie



| CAT. NO. | UPC | DESCRIPTION | STD | MSTR | WT/STD |
|----------|-------|--|-----|------|--------|
| AL200 | 82070 | Cable Tie Tension Tool - Automatic Cut Off | 1 | 12 | 1.12# |

TECH TALK

What is the difference between a "plenum" and other "air handling spaces"?

According to the NEC, the area above a drop ceiling or below a raised floor is an example of an "other (air handling) space", whereas a plenum is the air carrying duct itself which may be located above a drop ceiling or below a raised floor. Wiring is permitted in both air-handling spaces, but only metallic wiring systems (and metallic cable ties) are permitted in "plenums" (ducts). AIR HANDLING TIES are "Suitable for use in air handling spaces in accordance with Section 300-22 (C) & (D) of the National Electrical Code". The bag label should contain the UL Listed symbol.



CHEMICALS & TAPE



PULL ROPE, PULL LINE & NYLON LINE

PULL ROPE

PC 6000



Polypropylene Pull Rope is a lightweight, strong rope that is rot proof and unaffected by water, oil, gasoline and most chemicals.

FEATURES:

- Polypropylene
- Safety Yellow

| CAT. NO. | UPC | SIZE | WORK LOAD | TENSILE | STD | MSTR | WT/STD |
|----------|-------|---------------|-----------|---------|-----|------|---------|
| 18100 | 61300 | 1/8" x 1000' | 48# | 480# | 1 | | 4.05# |
| 18250 | 61305 | 1/8" x 2500' | 48# | 480# | 1 | | 10.58# |
| 3625 | 61302 | 3/16" x 250' | 72# | 720# | 1 | | 2.69# |
| 3660 | 61304 | 3/16" x 600' | 72# | 720# | 1 | | 6.52# |
| 36100 | 61306 | 3/16" x 1000' | 72# | 720# | 1 | | 9.39# |
| 36120 | 61308 | 3/16" x 1200' | 72# | 720# | 1 | | 10.62# |
| 36300 | 60314 | 3/16" x 3000' | 72# | 720# | 1 | | 23.47# |
| 36360 | 60316 | 3/16" x 3600' | 72# | 720# | 1 | | 30.78# |
| 1425 | 61310 | 1/4" x 250' | 113# | 1130# | 1 | | 4.99# |
| 1460 | 61312 | 1/4" x 600' | 113# | 1130# | 1 | | 8.96# |
| 14100 | 61314 | 1/4" x 1000' | 113# | 1130# | 1 | | 15.72# |
| 14120 | 61316 | 1/4" x 1200' | 113# | 1130# | 1 | | 17.84# |
| 14240 | 61313 | 1/4" x 2400' | 113# | 1130# | 1 | | 34.02# |
| 14400 | 61315 | 1/4" x 4000' | 113# | 1130# | 1 | | 51.54# |
| 3830 | 61318 | 3/8" x 300' | 243# | 2430# | 1 | | 8.93# |
| 3860 | 61320 | 3/8" x 600' | 243# | 2430# | 1 | | 18.55# |
| 38120 | 61322 | 3/8" x 1200' | 243# | 2430# | 1 | | 36.92# |
| 38250 | 60312 | 3/8" x 2500' | 243# | 2430# | 1 | | 70.00# |
| 38360 | 60318 | 3/8" x 3600' | 243# | 2430# | 1 | | 111.00# |
| 1230 | 61324 | 1/2" x 300' | 378# | 3780# | 1 | | 16.98# |
| 1260 | 61326 | 1/2" x 600' | 378# | 3780# | 1 | | 33.10# |
| 12120 | 61328 | 1/2" x 1200' | 378# | 3780# | 1 | | 62.22# |

PULL LINE

PC 6000



Pull Line is used to pull rope through conduit and can be used with power fishing systems.

FEATURES:

- Two Ply Pull Line
- Dispensing Box
- Dispensing Pail

| CAT. NO. | UPC | COLOR | LENGTH | WORK LOAD | TENSILE | STD | MSTR | WT/STD |
|-------------------|-------|--------------|------------|-----------|---------|-----|------|--------|
| 6502 | 15745 | Blue / White | 6500' | 20# | 200# | 1 | | 10.00# |
| 6502P | 15747 | Blue / White | 6500' Pail | 20# | 200# | 1 | | 11.65# |
| HEAVY DUTY | | | | | | | | |
| 2203P | 27506 | Red / White | 2200' Pail | 50# | 500# | 1 | | 12.66# |

- Rot & Mildew Resistant

NYLON LINE

PC 6060



Nylon fishing line with a center feed and fast payout can be pulled into the run and left to add future wires. Excellent resistance to rot, abrasion, mildew, marine growth, petroleum products and most chemicals.

FEATURES:

- Center Feed
- Fits Most Canister Systems
- Mildew Resistant

- 2150 Ft. Length
- 85 lb Tensile Strength

| CAT. NO. | UPC | LENGTH | TENSILE | STD | MSTR | WT/STD |
|----------|-------|--------|---------|-----|------|--------|
| N85 | 17880 | 2150' | 85# | 1 | 12 | 1.23# |

HEAVY DUTY NYLON LINE

PC 6060



Heavy Nylon fish line is used where a higher tensile strength is required. It can be pulled into the run and left to add future wires.

FEATURES:

- 100% Filament #36 Nylon
- Rot Resistant

- 580 Ft Length
- 310 lb Tensile Strength

| CAT. NO. | UPC | LENGTH | TENSILE | STD | MSTR | WT/STD |
|----------|-------|--------|---------|-----|------|--------|
| N36 | 17881 | 580' | 310# | 1 | 6 | 1.04# |

CONDUIT MEASURING TAPE

PC 6031

Conduit measuring tape allows you to fish and measure conduit runs in one operation. It is sequentially marked in one foot increments and made of strong waterproof polyester. It may be fished into conduit and allowed to remain over an extended period of time for further use.



| CAT. NO. | UPC | LENGTH | WORK LOAD | TENSILE | STD | MSTR | WT/STD |
|----------|-------|--------|-----------|---------|-----|------|--------|
| 3000 | 30000 | 3000' | 14# | 140# | 1 | 4 | 4.18# |

FEATURES:

- Polyester
- Suquentially Marked
- Abrasion Resistant

POLYESTER PULL LINE-MEASURING TAPE

PC 6010

Polyester pull line/measuring tape is a very strong synthetic with excellent abrasion resistance. Polyester does not have the stretch and elasticity of nylon, but is superior to nylon with respect to cycle loading and abrasion. Pre-lubed and low friction, it provides a softer feel for easier handling by linemen.



| CAT. NO. | UPC | SIZE | TENSILE | STD | MSTR | WT/STD |
|----------|-------|--------------|---------|-----|------|--------|
| DWP500 | 27557 | 1/2" x 500' | 1250# | 1 | | 6.28# |
| DWP1500 | 27558 | 1/2" x 1500' | 1250# | 1 | | 16.78# |
| DWP3000 | 27559 | 1/2" x 3000' | 1250# | 1 | | 28.25# |
| DWP501 | 27500 | 5/8" x 500' | 1800# | 1 | | 8.78# |
| DWP1501 | 27501 | 5/8" x 1500' | 1800# | 1 | | 22.20# |
| DWP3001 | 27502 | 5/8" x 3000' | 1800# | 1 | | 36.45# |
| DWP502 | 27503 | 3/4" x 500' | 2500# | 1 | | 13.50# |
| DWP1502 | 27504 | 3/4" x 1500' | 2500# | 1 | | 27.50# |
| DWP3002 | 27505 | 3/4" x 3000' | 2500# | 1 | | 48.42# |
| PGE3000 | 61331 | 1/4" x 3000' | 400# | 1 | | 14.00# |

FEATURES:

- Polyester
- Suquentially Marked
- Pre-Lubed
- Abrasion Resistant

3-IN-1-PREMISE MULETAPE

PC 6012

This high quality pulling tape substantially reduces cable installation labor, material, and inventory costs by providing threading line, measuring tape, and winch line all in one product.

FEATURES:

- The pre-lubricated tape will reduce friction levels and eliminate duct cutting; a common issue with conventional polyester ropes rubbing against conduit walls.
- Lower elongation reduces pulling time, improves safety for workers, and prevents crushed capstans.
- The material is lightweight and easily blown through conduit or inner duct.
- Accurate sequential footage markings enable monitoring of cable location during a pull, eliminating the need for measuring tapes and indicating exactly how much tape remains on the roll.



| CAT. NO. | UPC | SIZE | TENSILE | STD | MSTR | WT/STD |
|----------|-------|---|----------|-----|------|--------|
| PMT4500 | 82337 | 1/4" x 4500' 3-in-1 Premise Muletape-Pail | 400 lb. | 1 | | 14.00# |
| PMT1300 | 82338 | 5/8" x 1300' 3-in-1 Premise Muletape-Pail | 1800 lb. | 1 | | 13.30# |



LINE PACKAGES & POWER FISHING PISTONS

LINE PACKAGES

PC 6050



Line packages combine piston and string in a single package. With a portable blower you can blow or vacuum the nylon line and pull a rope through.

FEATURES:

- Nylon Line
- Color Coded
- 17 lb Tensile Strength

| CAT. NO. | UPC | DIAMETER/LENGTH | COLOR | STD | MSTR | WT/STD |
|----------|-------|-----------------|--------|-----|------|--------|
| LP5075 | 32220 | 1/2" x 75' | Red | 10 | 100 | 0.09# |
| LP50150 | 32202 | 1/2" x 150' | Red | 10 | 100 | 0.12# |
| LP7575 | 32204 | 3/4" x 75' | Yellow | 10 | 100 | 0.09# |
| LP75200 | 32206 | 3/4" x 200' | Yellow | 5 | 50 | 0.08# |
| LP75300 | 32208 | 3/4" x 300' | Yellow | 5 | 25 | 0.13# |
| LP75450 | 32210 | 3/4" x 450' | Yellow | 5 | 25 | 0.18# |
| LP10075 | 32212 | 1" x 75' | White | 10 | 50 | 0.09# |
| LP100200 | 32214 | 1" x 200' | White | 5 | 50 | 0.10# |
| LP100300 | 32216 | 1" x 300' | White | 5 | 25 | 0.14# |
| LP100450 | 32218 | 1" x 450' | White | 5 | 25 | 0.17# |

POWER FISHING PISTONS

PC 6040



Power fishing pistons are used with a power vacuum or blower to pull line through a conduit run. It fits most conduits 1/2" through 6". The 1/2", 3/4" & 1" sizes have metal pulling eyes at both ends. Other sizes have a hook on one end and an eye on the opposite end. Tough foam piston cleans its own path and provides an air-tight seal.

FEATURES:

- Reusable
- Durable Foam
- Steel Eye
- Display Pack 1/2" - 2"

| CAT. NO. | UPC | DIAMETER/LENGTH | STD | MSTR | WT/STD |
|----------|-------|-----------------|-----|------|--------|
| PFP50 | 32030 | 1/2" Conduit | 5 | 25 | 0.19# |
| PFP75 | 32032 | 3/4" Conduit | 5 | 25 | 0.20# |
| PFP100 | 32034 | 1" Conduit | 5 | 10 | 0.21# |
| PFP125 | 32036 | 1-1/4" Conduit | 2 | 10 | 0.32# |
| PFP150 | 32038 | 1-1/2" Conduit | 1 | 5 | 0.27# |
| PFP200 | 32040 | 2" Conduit | 1 | 5 | 0.43# |
| PFP250 | 32042 | 2-1/2" Conduit | 5 | | 0.43# |
| PFP300 | 32044 | 3" Conduit | 5 | | 0.57# |
| PFP350 | 32046 | 3-1/2" Conduit | 2 | | 0.50# |
| PFP400 | 32048 | 4" Conduit | 2 | | 0.55# |
| PFP500 | 32050 | 5" Conduit | 2 | | 0.63# |
| PFP600 | 32052 | 6" Conduit | 2 | | 0.68# |

CHEMICALS & TAPE

TECH TALK



Dottie Quick Sticks

Quick Sticks screw together to reach full or desired length. Use to fish wires through walls, under floors, over suspended ceilings and into many other confined spaces. Quick Sticks will flex up to 90° without breaking. Made from high strength, low weight fiber glass material. Quick Sticks are ideal for pulling and stringing communication wires, alarm system wires, romex, telephone and thermostat wire. Available attachments are; Pulling Hooks, Pulling Eyes and Whisk Heads. Our glow in the dark version is available in 3/16" & 1/4" diameter. For use in plenums. See page E15.

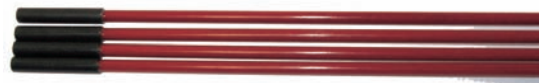

ABS & PVC CEMENT

PC 6170

Low VOC (Volatile Organic Compound) ABS & PVC Cement conform to South Coast Air Quality Management District regulations (Rule 1168), and are used for electrical conduits and non pressure applications. All conduit schedules & classes through 6". Joins ABS to PVC, ABS to ABS, PVC to PVC.



| CAT. NO. | UPC | CONTENTS | COLOR | STD | MSTR | WT/STD |
|----------|-------|----------|-------|-----|------|--------|
| PV16CL | 30950 | Pint | Clear | 12 | | 14.64# |
| PV16GR | 30955 | Pint | Gray | 12 | | 14.64# |
| PV32CL | 30960 | Quart | Clear | 12 | | 26.88# |
| PV32GR | 30965 | Quart | Gray | 12 | | 26.88# |

FEATURES:

- Virgin PVC Resin
- Clear or Gray
- Reduced Emission VOC
- Pint or Quart

ABS & PVC PRIMER

PC 6170

ABS & PVC Primer is a water thin solvent to be used in conjunction with PVC cement to produce the best PVC joint possible. It also acts as a cleaner as well as a pre-softener, and is suitable for use on all types, classes, and schedules of PVC pipes and fittings.



| CAT. NO. | UPC | CONTENTS | COLOR | STD | MSTR | WT/STD |
|----------|-------|----------|--------|-----|------|--------|
| PR16 | 30975 | Pint | Purple | 12 | | 13.56# |

FEATURES:

- Thin Solvent
- Purple
- Fast Acting
- Pint

ROOF MASTIC

PC 6210

Premium grade roof mastic can be used in wet or dry locations to patch cracks & breaks, repair seams & joints and for sealing flashings. It adheres to all surfaces, wet or dry and forms a tight, strong weathertight seal which stays soft and pliable. Applied with a trowel or putty knife, it will cure to be a durable, resilient coating of excellent adhesion and unsurpassed weathering.



| CAT. NO. | UPC | CONTENTS | STD | MSTR | WT/STD |
|----------|-------|------------------|-----|------|--------|
| RKM1 | 30605 | 1 Quart | 12 | | 30.60# |
| RKM4 | 30610 | 1 Gallon | 4 | | 38.52# |
| RKM10 | 10920 | 10 oz. Cartridge | 12 | | 9.48# |

FEATURES:

- UL Classified
- Asbestos Free
- ASTM 4586, ASTM D2822
- Meets Federal Specs SS-C-153

DARK CUTTING OIL

PC 6220

Dark Cutting Oil is specifically designed for threading steel and cast iron, and is recommended for cutting ferrous materials and ferrous alloys. It has been fortified with a chlorinated additive which works as an extreme pressure agent to allow an increased tolerance of alloyed or hard-grained pipe. Caution: Dark cutting oil contains active sulphur which will stain non-ferrous materials including copper, brass, stainless.



| CAT. NO. | UPC | CONTENTS | STD | MSTR | WT/STD |
|----------|-------|----------|-----|------|--------|
| CO1 | 27525 | 1 Quart | 12 | | 24.96# |
| CO4 | 27530 | 1 Gallon | 4 | | 32.04# |

FEATURES:

- Petroleum Mineral Oil
- Chlorinated Additive



FIRE STOP/CAULK, PUTTY PADS & FIRESTICKS

FIRE STOP CAULKING COMPOUND

PC 6160



| CAT. NO. | UPC | CONTENTS | COLOR | STD | MSTR | WT/STD |
|----------|-------|----------|-------|-----|------|--------|
| MC150 | 16356 | 10.3 oz. | Red | 24 | | 30.24# |
| 1000D | 16386 | 10.3 oz. | Red | 24 | | 25.20# |

FEATURES:

- UL Classified
- Asbestos Free
- Red
- 1 to 4 Hour Rating
- Remains Flexible
- Non Sagging
- Non Toxic-No VOC's
- Interior Use

FIRE RATED PUTTY PADS

PC 6140



| CAT. NO. | UPC | SIZE | STD | MSTR | WT/STD |
|----------|-------|----------------|-----|------|--------|
| FRP67 | 16378 | 6" x 7" x 1/8" | 20 | | 7.20# |

FEATURES:

- UL Listed
- Asbestos Free
- Red
- 1 to 2 Hour Rating
- Water Resistant
- Intumescent
- Activated at 220 ° F
- Adheres to all Common Building Surfaces
- Sound Barrier

* Sound rating available upon request

FIRESTICKS

PC 6140



| CAT. NO. | UPC | SIZE | STD | MSTR | WT/STD |
|----------|-------|------------|-----|------|--------|
| FRS18 | 16380 | 18 cu. in. | 12 | | 0.77# |

FEATURES:

- UL Listed
- Asbestos Free
- Red
- 1 to 2 Hour Rating
- Water Resistant
- Intumescent
- Activated at 220 ° F
- Adheres to all Common Building Surfaces
- Sound Barrier

CHEMICALS & TAPE

TECH TALK



Fire Stop Caulking Compounds are water based, flexible, highly intumescent, fire rated sealants. They prevent the spread of fire and smoke through joints in fire rated gypsum wall board partitions, concrete block or concrete walls and/or concrete or corrugated steel deck floor/ceiling assemblies. MC150 is a general dry caulk rated to a maximum 3 hour fire rating. The 1000D is a premium caulk rated to a maximum 4 hour fire rating.

Fire Rated Putty pads are used on electrical outlet boxes and cabinets to maintain the hourly rating of fire rated walls and to prevent passage of smoke, flame and toxic gases. The pads are intumescent (swells when heated forming an insulating char) and can be pressed into any shape to form a water and airtight seal. Only one 1/8" pad is required for a one to two hour fire rating

Firesticks are used to seal around items that penetrate through fire rated walls and floors, including construction joints and blank openings. It is used with electrical cables, conduit and metal pipe. Firesticks are hand moldable with no curing time required, and will not dry out. They can be reused as additional penetrating items are removed or installed.

D10

CELEBRATING 50 YEARS

INSULPADS, DUCT SEAL, HANDI-FOAM & SILICONE SEALANT

INSULPADS

PC 6120

| CAT. NO. | UPC | SIZE | STD | MSTR | WT/STD |
|----------|-------|----------------|-----|------|--------|
| 68 | 15250 | 1/8" x 6" x 8" | 100 | | 33.80# |



FEATURES:

- Polymers and Butyl Rubber
- Gray
- 100% Solid
- Low Odor
- Temperature Range: -20° F. to 180° F.
- Sound Barrier
- Non Hardening
- Flexible
- Forms Watertight Seal

DUCT SEAL

PC 6130

Duct Seal (Prest "O" Seal) is used to seal around junction box flashings, service masts, etc. It is heavy mastic, which is flexible and can be pressed into any shape to form a water and airtight seal.



| CAT. NO. | UPC | SIZE | STD | MSTR | WT/STD |
|----------|-------|------|-----|------|--------|
| LHD1 | 17230 | 1 lb | 50 | | 50.00# |
| LHD5 | 17235 | 5 lb | 10 | | 50.00# |

FEATURES:

- UL Listed
- Adheres to Most Clean Surfaces
- Non Toxic/Asbestos Free

HANDI-FOAM EXPANDING SEALANT

PC 6190, 6191

Handi-Foam is an expanding sealant which is a moisture-cure polyurethane foam. It is used to seal, bond, retrofit, insulate and deaden sound in electrical, plumbing, air-conditioning and refrigeration applications. It expands 2 to 3 times its extruded bead, and is rated R-5 for each inch of foam. Specifically designed to be dispensed as a bead for filling cracks. Substrate must be clean, firm, free of loose particles and dust.



FEATURES:

- Seals To Prevent Air And Moisture Infiltration
- Seals The Building Envelope
- Improves Building Efficiencies By Sealing Penetrations
- Improves Indoor Air Quality

HANDI-FOAM - 6190

| CAT. NO. | UPC | DESCRIPTION | STD | MSTR | WT/STD |
|----------|-------|------------------------------------|-----|------|--------|
| HF340 | 90980 | Handi-Foam Expanding Sealant 12oz. | 12 | | 12.12# |

Fireblock low pressure one-component polyurethane foam sealant is a moisture cured sealant designed to seal, fill, bond and stop air infiltration in areas where a fireblock product is required. Fireblock has a recognizable orange color allowing inspectors to easily identify the use of an approved fireblock product for Type V residential construction.



FEATURES:

- Sealing insulation board joints
- Type V residential fire blocking
- Sealing electrical outlets
- Sealing electrical openings
- Sealing through stud penetrations
- Sealing baseplates
- Sealing plumbing penetrations

FIREBLOCK - 6191

| CAT. NO. | UPC | DESCRIPTION | STD | MSTR | WT/STD |
|----------|-------|---------------------------------------|-----|------|--------|
| HFB12 | 10353 | Handi-Foam Expanding Fireblock 12 oz. | 12 | | 13.25# |

RTV SILICONE SEALANT

PC 6200

| CAT. NO. | UPC | COLOR | CONTENTS | DESCRIPTION | STD | MSTR | WT/STD |
|----------|-------|-------|----------|-----------------|-----|------|--------|
| RTV3 | 17360 | Clear | 3 oz. | Tube | 12 | | 3.60# |
| RTV8 | 17366 | Clear | 8 oz. | Pressurized Can | 12 | | 4.53# |
| RTV10 | 17365 | Clear | 10.1 oz. | Cartridges | 12 | | 9.48# |
| RTV8W | 10921 | White | 8 oz. | Pressurized Can | 12 | | 4.53# |
| RTV10W | 17367 | White | 10.1 oz. | Cartridges | 12 | | 9.48# |



FEATURES:

- UL Classified
- Clear/White
- Neutral Cure Silicone
- Carded Tube
- Non Acetic & Non Corrosive
- Low Odor
- Flexible, Non Sagging, Watertight
- Withstands Temperatures to 450° F

CHEMICALS & TAPE



TUF TOWELS, WIPING RAGS & WAREHOUSE SUPPLIES

TUF TOWELS

PC 6250



Dottie Tuf Towels are perfect on the job site or anywhere water is not readily available. Powerful cleaning formula combined with unique dispensing canister allows for storage and re-use of towels, making your dollars last longer! Tough on grime, but not your hands!

| CAT. NO. | UPC | DESCRIPTION | STD | MSTR | WT/STD |
|----------|-------|--|-----|------|--------|
| TT75 | 40775 | 75 Pre-moistened Multi-Purpose Hand Towels | 6 | | 14.75# |

FEATURES:

- Heavy-duty Cleaning Formula For The Toughest Of Jobs Even Without Water.
- Unmatched Performance On Paint, Ink, Tar, Adhesives, Sealant, Grease And Oil.
- Fortified With Aloe & Vitamin E For Gentle But Effective Performance.
- Unique Fabric Has Tough Scrubbing Side & Smooth Side For Delicate Work.
- Great For Hands, Tools & Many Other Surfaces.

WIPING RAGS

PC 6252



Rags are all new material bleached knits. They are medium weight, random size, soft, absorbent, and are a low linting Premium all purpose wiper.

| CAT. NO. | UPC | DESCRIPTION | STD | MSTR | WT/STD |
|----------|-------|------------------------------------|-----|------|--------|
| RGZ2 | 11922 | 2 Pound Bag New Bleached Knit Rags | 1 | 10 | 2.10# |
| RGZ5 | 81063 | 5 Pound Box New Bleached Knit Rags | 1 | 10 | 5.10# |

FEATURES:

- New Bleached Knit Rags
- Medium Weight
- Soft, Absorbent, Low Lint

ECONOMY WIPING RAGS

PC 6252



Economy Wiping Rags are medium weight random sized all-purpose wipers.

| CAT. NO. | UPC | DESCRIPTION | STD | MSTR | WT/STD |
|----------|-------|---|-----|------|--------|
| RGZ25 | 81913 | 25 Pound Box of Recycled Colored T-Shirts | 1 | | 26.65# |

FEATURES:

- Recycled Color T-Shirt Material
- Medium Weight
- Absorbent

WAREHOUSE SUPPLIES

PC 5400

STRETCH FILM

| CAT. NO. | UPC | WIDTH/LENGTH/DESCRIPTION | STD | MSTR | WT/STD |
|----------|-------|--|-----|------|--------|
| SF18 | 24030 | 18" x 1500' 80 Gauge Stretch Film For Wrapping Palletized Products | 4 | | 38.68# |



CARTON SEALING TAPE

| | | | | | |
|--------|-------|--|----|--|--------|
| 2110CL | 59802 | 2" x 110 yds Clear Polypro Use in dispenser to easily seal cartons | 36 | | 16.20# |
|--------|-------|--|----|--|--------|



TAPE DISPENSER

| | | | | | |
|----|-------|--|---|--|-------|
| TD | 59800 | Dispenser Only Handles 2" wide Carton Sealing Tape | 1 | | 1.10# |
|----|-------|--|---|--|-------|



CHEMICALS & TAPE

D12

"BUILDING A BETTER BRAND"

WIRE MARKER BOOKS

PC 5300

Wire Marker Books are available in a combination of industry recognized numbers, letters, Nema colors and legends. They eliminate costly trial and error searches.



| CAT. NO. | UPC | LEGEND | QTY. OR MARKERS | STD | MSTR | WT/STD |
|----------|-------|------------------------|-------------------------|-----|------|--------|
| DM09 | 16300 | 0-9 | 60 Ea, 0-4 / 30 Ea, 5-9 | 1 | 10 | 0.09# |
| DM145 | 16302 | 1-45 | 10 Each | 1 | 10 | 0.09# |
| DM4690 | 16304 | 46-90 | 10 Each | 1 | 10 | 0.09# |
| DMAZ | 16306 | A-Z, 0-15, +, -, / | 10 Each | 1 | 10 | 0.09# |
| DMNC | 16329 | 10 NEMA Colors | 10 Each | 1 | 10 | 0.09# |
| DMBA | 16327 | Burglar/Security Alarm | 3 Sets of 90 | 1 | 10 | 0.09# |
| DMFA | 16328 | Fire/Security Alarm | 3 Sets of 90 | 1 | 10 | 0.09# |

FEATURES:

- Vinyl Cloth Resists Dirt, Etc.
- Non Smearing Quality Print
- High Tack Acrylic Adhesive
- Temperature Range -40° F. to 250° F
- Pocket Sized 1-1/4" Perforated

WIRE TERMINAL KIT

PC 5730

| CAT. NO. | UPC | DESCRIPTION | STD | MSTR | WT/STD |
|----------|-------|------------------------|-----|------|--------|
| TK250 | 11554 | 250 pc. Assortment Kit | 1 | 10 | 0.88# |



FEATURES:

- UL Listed
- Pure Copper
- One Piece Burr Free Construction
- Crimped Serrations Grip Wire
- Visual Open Barrel
- Wire Range Imprinted
- Color Coded Insulation
- Made in USA

LUMBER CRAYONS

PC 6630

Lumber crayons are used to write on cardboard, concrete, lumber (rough or smooth), metal, paper, plastic, etc. Now in a 3 pack Hang up Bag by color.



| CAT. NO. | UPC | DESCRIPTION | COLOR | STD | MSTR | WT/STD |
|----------|-------|-------------------------|--------|-----|------|--------|
| DCR3P | 67561 | 3 Red Lumber Crayons | Red | 1 | 10 | 0.23# |
| DCY3P | 67571 | 3 Yellow Lumber Crayons | Yellow | 1 | 10 | 0.23# |
| DCB3P | 67576 | 3 Blue Lumber Crayons | Blue | 1 | 10 | 0.23# |
| DCBLK3P | 67566 | 3 Black Lumber Crayons | Black | 1 | 10 | 0.23# |
| DCB* | 14650 | 54 Blue Lumber Crayons | Blue | 54 | 540 | 3.25# |

* Price per each crayon

LUMBER CRAYON HOLDER

| CAT. NO. | UPC | DESCRIPTION | COLOR | STD | MSTR | WT/STD |
|----------|-------|----------------------|--------|-----|------|--------|
| DCH | 67585 | Lumber Crayon Holder | Walnut | 1 | 6 | 0.05# |

FEATURES:

- Lead Free
- Weather Resistant
- Fade Resistant
- 3 Pack Hang up Bag
- Sold per bag of 3



MARKING, INVERT-A-CAP & ALL PURPOSE PAINTS

CONSTRUCTION MARKING PAINT

PC 6180



Construction Marking Paint is the flagship of the line, offering high quality paint that is priced competitively to meet a variety of marking applications while providing good color visibility and durability.

FEATURES:

- High Quality
- Competitive Price
- Good Visibility
- Durable
- Reference Tech Talk pg. D15

| CAT. NO. | UPC | CAN SIZE | (NET) | COLOR | STD MSTR WT/STD | |
|----------|-------|----------------|----------|----------------------|-----------------|--------|
| 246 | 00246 | 20-oz. Aerosol | (17-oz.) | Fluorescent Red | 12 | 18.00# |
| 247 | 00247 | 20-oz. Aerosol | (17-oz.) | Fluorescent Orange | 12 | 18.00# |
| 249 | 00249 | 20-oz. Aerosol | (17-oz.) | Fluorescent Pink | 12 | 18.00# |
| 254 | 00254 | 20-oz. Aerosol | (17-oz.) | Blue | 12 | 18.00# |
| 255 | 00255 | 20-oz. Aerosol | (17-oz.) | White | 12 | 18.00# |
| 256 | 00256 | 20-oz. Aerosol | (17-oz.) | Red | 12 | 18.00# |
| 258 | 00258 | 20-oz. Aerosol | (17-oz.) | Hi-Vis Yellow | 12 | 18.00# |
| 259 | 00259 | 20-oz. Aerosol | (17-oz.) | Green | 12 | 18.00# |
| 283 | 00283 | 20-oz. Aerosol | (17-oz.) | Fluorescent Red-Org. | 12 | 18.00# |

CLEAR COAT

| | | | | | | |
|-----|-------|----------------|----------|------------|----|--------|
| 200 | 00200 | 20-oz. Aerosol | (15-oz.) | Clear Coat | 12 | 15.00# |
|-----|-------|----------------|----------|------------|----|--------|

INVERT-A-CAP MARKING PAINT

PC 6180



The ultimate writing tool is inverted marking paint. Use where controlled applications (letters and numbers) are needed, in addition to lines. Best positive delivery cut off and non-clogging performance with the least possible tip paint build-up.

FEATURES:

- For Controlled Applications
- Crisp Delivery
- Non-Clogging
- Reference Tech Talk pg. D15

| CAT. NO. | UPC | CAN SIZE | (NET) | COLOR | STD MSTR WT/STD | |
|----------|-------|----------------|----------|--------------------|-----------------|--------|
| 261 | 00261 | 16-oz. Aerosol | (12-oz.) | Red | 12 | 14.00# |
| 262 | 00262 | 16-oz. Aerosol | (12-oz.) | Yellow | 12 | 14.00# |
| 263 | 00263 | 16-oz. Aerosol | (12-oz.) | Blue | 12 | 14.00# |
| 272 | 00272 | 16-oz. Aerosol | (12-oz.) | Fluorescent Orange | 12 | 14.00# |
| 274 | 00274 | 16-oz. Aerosol | (12-oz.) | Fluorescent Green | 12 | 14.00# |
| 279 | 00279 | 16-oz. Aerosol | (12-oz.) | Fluorescent Pink | 12 | 14.00# |

ALL PURPOSE MARKING PAINT

PC 6180



This good, all purpose paint is an economically priced marking paint that is designed to provide a very cost-effective approach to marking and still provides good visibility in the two-month range.

FEATURES:

- Cost Effective
- 2 Month Visibility
- Reference Tech Talk pg. D15

| CAT. NO. | UPC | CAN SIZE | (NET) | COLOR | STD MSTR WT/STD | |
|----------|-------|----------------|----------|--------------------|-----------------|--------|
| 1381 | 01381 | 20-oz. Aerosol | (15-oz.) | Red | 12 | 15.00# |
| 1382 | 01382 | 20-oz. Aerosol | (15-oz.) | Yellow | 12 | 15.00# |
| 1387 | 01387 | 20-oz. Aerosol | (15-oz.) | White | 12 | 15.00# |
| 1390 | 01390 | 20-oz. Aerosol | (15-oz.) | Fluorescent Red | 12 | 15.00# |
| 1391 | 01391 | 20-oz. Aerosol | (15-oz.) | Fluorescent Green | 12 | 15.00# |
| 1392 | 01392 | 20-oz. Aerosol | (15-oz.) | Fluorescent Orange | 12 | 15.00# |
| 1394 | 01394 | 20-oz. Aerosol | (15-oz.) | Blue | 12 | 15.00# |
| 1395 | 01395 | 20-oz. Aerosol | (15-oz.) | Red-Orange | 12 | 15.00# |

APWA / One Call Color Descriptions

The American Public Works Association (APWA) requires public agencies, utilities, and contractors that excavate underground to use this color standard to identify the location and type of sub-surface utilities. Aervoe Industries was the first marking paint manufacturer to provide the uniform standard for these colors, and their products still proudly carry the original One-Call Systems International trademark.

| APPLICATION | AERVOE PRODUCT | CONSTRUCTION | INVERT-A-CAP | ALL PURPOSE |
|--------------------------|----------------|--------------|--------------|-------------|
| Electric | Red | 256 | 261 | 1381 |
| Gas-Oil | Yellow | 252* | 262 | 1382 |
| Water | Blue | 254 | 263 | 1383* |
| Sewer | Green | 259 | - | 1384* |
| Communications / CATV | Orange | 257* | 265* | 1385* |
| Proposed Excavation | White | 255 | 267* | 1387 |
| Reclaimed Water | Purple | 260* | - | - |
| Temporary Survey Marking | Pink | 249 | 279 | 1399* |

* Special Order

CHEMICALS & TAPE

RUST PROOF PAINT & COLOR SELECTOR

RUST PROOF PAINT SOLVENT BASED

PC 6180

High-performance Rust Proof solvent-based formulation withstands corrosion and exposure from mild to moderate conditions while maintaining high gloss levels. Wide color selection includes OSHA safety, HVAC, commercial and selected factory equipment touch-up colors. Ideal for equipment touch-up / OEM production applications indoors & out, Rust Proof Paint is resistant to mild and moderate environments including intermittent exposure to water, salt spray, moisture and temperatures up to 300°F (149°C). It can be applied directly over rust with minor surface preparation and provides excellent hiding characteristics with smooth, even coverage.



FEATURES:

- High Gloss
- Dries To Touch in 15 Minutes
- Will Not Chip Or Peel

| CAT. NO. | UPC | CAN SIZE | (NET) | COLOR | STD MSTR | WT/STD |
|----------|-------|----------------|----------|--------------------|----------|--------|
| 300* | 81778 | 16-oz. Aerosol | (12-oz.) | Safety Purple | 6 | 7.02# |
| 301 | 00301 | 16-oz. Aerosol | (12-oz.) | Safety Red | 6 | 7.02# |
| 302 | 00302 | 16-oz. Aerosol | (12-oz.) | Safety Yellow | 6 | 7.02# |
| 303 | 00303 | 16-oz. Aerosol | (12-oz.) | Safety Blue | 6 | 7.02# |
| 304 | 00304 | 16-oz. Aerosol | (12-oz.) | Safety Green | 6 | 7.02# |
| 305 | 00305 | 16-oz. Aerosol | (12-oz.) | Safety Orange | 6 | 7.02# |
| 306 | 00306 | 16-oz. Aerosol | (12-oz.) | Safety Black | 6 | 7.02# |
| 307* | 00307 | 16-oz. Aerosol | (12-oz.) | Safety White | 6 | 7.02# |
| 312 | 00312 | 16-oz. Aerosol | (12-oz.) | Flat Black | 6 | 7.02# |
| 317* | 81779 | 16-oz. Aerosol | (12-oz.) | Tan | 6 | 7.02# |
| 318* | 81780 | 16-oz. Aerosol | (12-oz.) | Light Blue | 6 | 7.02# |
| 333 | 00333 | 16-oz. Aerosol | (12-oz.) | Dark Gray/ANSI-33 | 6 | 7.02# |
| 349 | 00349 | 16-oz. Aerosol | (12-oz.) | Meter Gray/ANSI-49 | 6 | 7.02# |
| 361 | 00361 | 16-oz. Aerosol | (12-oz.) | Light Gray/ANSI-61 | 6 | 7.02# |

* Special Order

COLOR SELECTION

| Regular Colors | Fluorescent Colors | OSHA Colors Application | HVAC Colors Application |
|--------------------------|---|---|--|
| Yellow 252*, 262, 1382 | Yellow 252*, 262, 1382 | OSHA Purple 300* Radiation Hazard | Purple 300* Refrigerant R502 |
| White 255, 267*, 1387 | White 255, 267*, 1387 | OSHA Red 301 Danger, stop, or location of fire protection equipment | Light Green 304 Refrigerant R22 |
| Orange 257*, 265*, 1385* | Orange 257*, 265*, 1385* | OSHA Yellow 302 Caution and physical hazards | Orange 305 Refrigerant R404A |
| Green 259, 1384* | Green 259, 1384* | OSHA Blue 303 Equipment being repaired. Caution against moving or starting | Tan 317* Refrigerant R409A |
| Blue 254, 263, 1383* | Blue 254, 263, 1383* | OSHA Green 304 Location of safety equipment other than fire | Light Blue 318* Refrigerant R134A |
| Red 256, 261, 1381 | Red 256, 261, 1381 | OSHA Orange 305 Dangerous parts of machinery or energized equipment | <small>*Special Order</small> |
| Hi-Vis Yellow 258 | Purple 260* | OSHA Black 306 Traffic and housekeeping | <small>OSHA Colors</small> The Occupational Safety and Health Act (OSHA) stipulates that industrial plants provide color coded safety equipment and hazard areas. |
| Purple 260* | <small>The printed colors on these pages approximate the appearance of the actual paint colors</small> * Special Order | OSHA White 307* Traffic and housekeeping | <small>HVAC Colors</small> Color designations are currently used by DuPont® for its refrigerants. Although refrigerant manufacturers make a concerted effort to select colors to differentiate refrigerant types, color guidelines are not a substitute for reading cylinder labels and markings. |

CHEMICALS & TAPE

TECH TALK

Marking Paint Performance Specifications

| MARKING PRODUCT | QUALITY | INITIAL VISIBILITY | MARK PERFORMANCE | DURABILITY | DELIVERY RATE | LINEAR COVERAGE* | APPLICATION |
|----------------------------|---------|--------------------|------------------|------------|---------------|------------------|---|
| Invert-A-Cap® | Better | Excellent | 3-4 Months | Excellent | 2.6 g/sec | 350' | Inverted marking paint best for writing tool & controlled spray. Non-freezing formula; operational to 14°F (-10° C) |
| Construction Marking Paint | Better | Excellent | 3 Months | Excellent | 3.2 g/sec. | 420' | Utility / locator, construction & proposed excavation |
| All Purpose Marking Paint | Good | Good | 2 Months | Good | 3.2 g/sec. | 380' | Proposed excavation, construction landscape, utility/locator & survey marking. |

* Coverage varies depending on width of mark and hide desired.



TEF-LUBE, ALL-4, COMPONENT & CONTACT CLEANERS & SAFETY SOLVENT

TEF-LUBE

PC 6180



Tef-Lube™ is a superior lubricant that combines the advantages of high-grade petroleum oils and solvents with micron-sized PTFE to provide the finest multi-component penetrating lubricant system available.

| CAT. NO. | UPC | CAN SIZE | (NET) | STD MSTR | WT/STD |
|----------|------|---------------|---------|----------|--------|
| 937 | 0093 | 8-oz. Aerosol | (7-oz.) | 12 | 8.00# |

FEATURES:

- Protects Against Corrosion; Displaces Moisture
- Keeps Equipment Running Longer; Reduces Friction and Costly Breakdowns
- Penetrate Inaccessible Areas With Extension Tube
- Spray-Any Way Valve - Apply Upright or Upside Down
- Performs at Temperatures From -60° to 475° F
- Meets MIL-C-372B, MIL-C-23411/A, VV-P-2161B and VV-L-751C

ALL-4

PC 6180



This is a moisture-displacing, multipurpose lubricant that Penetrates, Cleans, Lubricates, and Protects (meets MIL-C-16173E grade III for corrosion protection).

| CAT. NO. | UPC | CAN SIZE | (NET) | STD MSTR | WT/STD |
|----------|-------|----------------|----------|----------|--------|
| 7340 | 07340 | 16-oz. Aerosol | (10-oz.) | 12 | 12.00# |

FEATURES:

- Silicone Free
- Displace Moisture
- Cleans Away Dirt & Grease
- No Gummy Residue
- Fills Microscopic Irregularities
- Meets Military Spec. #MIL-C-16173D Group III

ELECTRONIC COMPONENT CLEANER

PC 6180



This chlorinated cleaner is HCFC-141b free while being non-flammable and non-ozone depleting. With a dielectric strength of 26 kV/mm and KB value of 66, this one product makes the best choice for your cleaning needs of sensitive electronics and most plastic parts.

| CAT. NO. | UPC | CAN SIZE | (NET) | STD MSTR | WT/STD |
|----------|-------|----------------|----------|----------|--------|
| 8377 | 08377 | 16-oz. Aerosol | (14-oz.) | 12 | 16.00# |

FEATURES:

- Effectively Removes Grease, Oil, Dirt & Other Contaminants
- No Flash Cleaner
- USDA K-2
- Evaporates Quickly With No Residue
- Safe On Most Plastics Or Coatings
- Includes Extension Tube
- Low Surface Tension For Easy Penetration Restores/ Maintains Electronic Values and Constants

OFF-LINE CONTACT CLEANER

PC 6180



With a KB value of 29 and less than 10% IPA, this is an excellent product to clean non-energized equipment.

| CAT. NO. | UPC | CAN SIZE | (NET) | STD MSTR | WT/STD |
|----------|-------|------------------|----------|----------|--------|
| 8276 | 08276 | 10.9-oz. Aerosol | (16-oz.) | 12 | 12.00# |

FEATURES:

- USDA K-2
- Safe On Most Plastics and Metals
- No Film Or Residue
- No CFCs, HCFCs, Or Chlorinated Solvents

NFP SAFETY SOLVENT

PC 6180



This quick drying, no flash point (Nfp) product removes grease deposits, oil, metallic particles, carbon dust, and other dangerous materials, and prevents costly flash-overs.

| CAT. NO. | UPC | CAN SIZE | (NET) | STD MSTR | WT/STD |
|----------|-------|----------------|----------|----------|--------|
| 8060 | 08060 | 20-oz. Aerosol | (20-oz.) | 12 | 21.00# |

FEATURES:

- USDA K-2
- Non-Flammable, Non-Corrosive
- Fast Evaporation; No Residue
- Can Be Used On Energized Equipment
- High Dielectric 36kV/mm
- Cleans Warm Motors In Place
- Not For Sale in CA

CHEMICALS & TAPE

D16

“BUILDING A BETTER BRAND”

DEGREASER, SAFETY SOLVENT, DUST AIR, RUST-SOLV & LUBRICANT

LFP CLEANER/DEGREASER H.D.

PC 6180

This fast-drying, industrial strength solvent is inexpensive and ideal for cleaning and degreasing. Removes grease, oil, wax and other contaminants without leaving a residue. Has low flash point (Lfp),



| CAT. NO. | UPC | CAN SIZE | (NET) | STD MSTR | WT/STD |
|----------|-------|----------------|----------|----------|--------|
| 399 | 00399 | 20-oz. Aerosol | (15-oz.) | 12 | 17.00# |

FEATURES:

- USDA K-1
- Fast Evaporation

- High-Pressure Spray With Unique Wetting Action
- Extension Tube Applicator
- Non-Corrosive, Non-Conductive, Solvents
- Displaces Moisture
- High Dielectric 33kV/mm
- No CFCs, HFCs Or Chlorinated

DUST AIR

PC 6180

A pure, non-CFC controlled air source that removes dust and airborne contaminants from delicate instruments without scratching the surface.



| CAT. NO. | UPC | CAN SIZE | (NET) | STD MSTR | WT/STD |
|----------|-------|----------------|----------|----------|--------|
| 420 | 00420 | 12-oz. Aerosol | (10-oz.) | 6 | 6.00# |

FEATURES:

- High-Delivery Trigger Spray Action
- Extension Tube Applicator

- Non-Abrasive, Safe For Use On Plastics and Energized Equipment
- Removes Microscopic Particles
- Ideal For Delicate Components Where Residual Entrapment Could Be A Problem
- Debris Forcefully Dislodged From Delicate Instruments

PERFORMANCE BLEND RUST-SOLV

PC 6180

Quickly loosens rust while penetrating grease and dirt. This product is not a lubricant, but a deep penetrant made for freeing seized and/or frozen parts and assemblies.



| CAT. NO. | UPC | CAN SIZE | (NET) | STD MSTR | WT/STD |
|----------|-------|----------------|----------|----------|--------|
| 950 | 00950 | 16-oz. Aerosol | (12-oz.) | 12 | 14.00# |

FEATURES:

- High Speed, High Flash, Non-Acid Penetrating Fluid
- High-Solvency - Ideal Degreaser

- Safe For Non-Heat, Electrical Exposure
- Works On All Forms Of Oxides, Including Copper, Iron, Lead, And Zinc
- Dielectric Strength 25kV/mm
- Will Not Harm Painted Surfaces

SILICONE LUBRICANT

PC 6180

Provides non-staining, long lasting lubrication.

| CAT. NO. | UPC | CAN SIZE | (NET) | STD MSTR | WT/STD |
|----------|-------|----------------|------------|----------|--------|
| 8034 | 08034 | 16-oz. Aerosol | (10.5-oz.) | 12 | 12.00# |



FEATURES:

- Waterproof And Prevents Corrosion
- USDA H-2
- Does Not Contain Petroleum Oil
- Contains 5% Silicone

MARKING STICK

PC 6180

| CAT. NO. | UPC | DESCRIPTION | STD MSTR | WT/STD |
|----------|-------|---------------|----------|--------|
| 245 | 00245 | Marking Stick | 1 | 2.00# |

FEATURES:

- Approximately 32" Length
- Trigger Actuator
- Single Hand Operation
- Excellent Can Balance



CHEMICALS & TAPE



CUTTING OIL, GALVANIZE, EPOXY COATING & WASP SPRAY

CUTTING OIL

PC 6180



This non-flammable, water-based cutting oil improves metal cutting operations and increases efficiencies in machining operations.

| CAT. NO. | UPC | CAN SIZE | (NET) | STD MSTR | WT/STD |
|----------|-------|----------------|----------|----------|--------|
| 890 | 00890 | 16-oz. Aerosol | (13-oz.) | 12 | 14.00# |

FEATURES:

- USDA H-2
- Reinforced With High-Viscosity Oils And Sulfur-Free Extreme Pressure Additives
- Prolongs Tool life, Reduces Tool Sharpening And Down Time
- Lubricates And Cools At The Cutting Point

ZINC RICH GALVANIZE

PC 6180



Ideal for use on surfaces that are exposed to severe corrosive conditions including structural steel, fencing, automobiles, guard rails, and bridges.

| CAT. NO. | UPC | CAN SIZE | (NET) | STD MSTR | WT/STD |
|----------|-------|----------------|----------|----------|--------|
| 7007 | 07007 | 16-oz. Aerosol | (13-oz.) | 12 | 14.00# |

FEATURES:

- Contains 97% Pure Zinc Metallic Powder, Which Yields 94% Zinc And 6% Resin Dry Film
- Meets ASTM B-117-64 Salt Spray
- Meets MIL-P-46105 & DOD-P-21035A
- For Temperatures Up To 200°F
- Passed Preece Test For Hot-Dip Galvanizing
- Stops Rust On Steel & Iron
- Sacrificial Anodization

RED INSULATING EPOXY

PC 6180



A tough flexible coating that protects and insulates exposed wires and electrical windings.

| CAT. NO. | UPC | CAN SIZE | (NET) | STD MSTR | WT/STD |
|----------|-------|----------------|------------|----------|--------|
| 401 | 00401 | 16-oz. Aerosol | (12.5-oz.) | 12 | 14.00# |

FEATURES:

- Dries In 15 Minutes; Hard in 1 Hour
- Dielectric Strength Up to 2,270 V/mil
- Excellent Adhesion, High Arc Resistance
- Class F Thermal Resistance
- Resists Oil, Water, Acids, Alkalis
- Penetrates, Coats/Seals In One Step

HORNET & WASP SPRAY

PC 6180



Fast-acting powerful aerosol saturates instantly to eliminate hornets, wasps, and yellow jackets.

| CAT. NO. | UPC | CAN SIZE | (NET) | STD MSTR | WT/STD |
|----------|-------|----------------|----------|----------|--------|
| 863 | 00863 | 20-oz. Aerosol | (15-oz.) | 12 | 17.00# |

FEATURES:

- USDA F-2
- Sprays Up To 20 Ft.
- High-Delivery Valve
- High % Active Ingredient
- High Dielectric Strength of 41kV/mm
- EPA Reg. No. 1021-1649
- Lasting Residual Deposit Prevents Reinfestation For Weeks

TOOLS & SPECIALTY ITEMS

SECTION **E**



TOOLS & SPECIALTY ITEMS

PCS
MID
AL | MRO
aid kit
of contents
ents that helps
& exceeds
ANSI
GUIDELINES

CLC
TECH GEAR

TOOLS & SPECIALTY ITEMS

SECTION **E**



TIP-BITS™

PC 6375

Dottie Tip-Bits are step drill bits with a replaceable tip. Rather than throwing away a good bit that just won't start a hole, the first few steps can be replaced making the drill bit start like new again.

The **TIP-BITS™**

| CAT. NO. | UPC | SIZE RANGE | SHANK STD MSTR WT/STD | | | |
|----------|-------|---|-----------------------|---|----|-------|
| RTTP6000 | 81210 | Replaceable Tip - 2 Pack Fits all Tip Bits. Can also be used as a 1/4" - 1/2" Step Drill Steps: 5/32", 1/4", 5/16", 3/8", 7/16", 1/2" | 1/4" | 1 | 15 | 0.10# |
| RTTP6010 | 81211 | 1/4" - 7/8" Base & Tip Steps: 9/16", 11/16", 3/4", 13/16", 7/8" | 1/4" | 1 | 5 | 0.20# |
| RTTP6020 | 81212 | 1/4" - 1-1/8" Base & Tip Steps: 19/32", 21/32", 3/4", 13/16", 7/8", 15/16", 1-1/32", 1-1/18" | 1/4" | 1 | 5 | 0.30# |
| RTTP6030 | 81213 | 1/4" - 1-3/8" Base & Tip Steps: 5/8", 3/4", 7/8", 1", 1-1/16", 1-3/16", 1-1/4", 1-5/16", 1-3/8" | 1/4" | 1 | 5 | 0.50# |
| RTTP6040 | 81214 | Kit contains: 1/4" - 1/2" Extra Tip 1/4" - 7/8" Base & Tip 1/4" - 1-1/8" Base & Tip | 1/4" | 1 | 4 | 0.55# |



FEATURES:

- No Need To Buy A New Bit When Just The Tip Is Worn
- A Real Money Saver. Base Bits Last 3 to 4 Times Longer At A Fraction Of The Cost
- Economical Replaceable Tips Lock In Place.
- Step Bit Performance Remains Identical To That Of Non-Replaceable Tip Bits.
- "Plier Tite" Tip Fit
- Constructed Of M2 High Speed Steel, Coated With Titanium And Cobalt.
- Tri-Cut Tip Cuts Smoother, Faster And Cooler.
- Caution! Always wear eye protection.

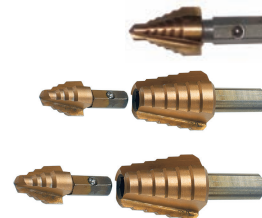



DRILL/TAP, SCREW REMOVAL KITS & NUT DRIVER

DRILL/TAP/COUNTERSINK HEX BIT KIT

PC 6348



| CAT. NO. | UPC | DESCRIPTION | STD | MSTR | WT/STD |
|-------------------------|-------|-----------------------------------|-----|------|--------|
| DRT6C | 12870 | Drill/Tap/Countersink Hex Bit Kit | 1 | 10 | 0.30# |
| REPLACEMENT BITS | | | | | |
| DT632NC | 12880 | 6-32 Drill & Tap Bit | 1 | 10 | 0.020# |
| DT832NC | 12881 | 8-32 Drill & Tap Bit | 1 | 10 | 0.020# |
| DT1024NC | 12882 | 10-24 Drill & Tap Bit | 1 | 10 | 0.020# |
| DT1032NF | 12900 | 10-32 Drill & Tap Bit | 1 | 10 | 0.020# |
| DT1224NC | 12884 | 12-24 Drill & Tap Bit | 1 | 10 | 0.020# |
| DT1420NC | 12885 | 1/4-20 Drill & Tap Bit | 1 | 10 | 0.020# |

FEATURES:

- Drill, Tap And Deburr In One Operation
- One-Piece Construction Guarantees Drill For Tap Size
- Made From High Speed M2 Steel
- Tapered Tap Prevents Thread Damage From Over-drilling
- Countersink Also Provided On Bit Beyond Back Taper
- 135° Self-Centering Split Point Tip
- Designed To Tap Up To 10 Gauge Metal
- 6 Piece Bit Set Includes: 6-32", 8-32", 10-24", 10-32", 12-24", 1/4"
- Caution! Always Wear Eye Protection

PROGRABIT - SCREW REMOVAL KIT

PC 6352



ProGrabit works on damaged screws and broken bolts from as small as a No. 4 screw to as large as a 3/8" bolt.

| CAT. NO. | UPC | DESCRIPTION | STD | MSTR | WT/STD |
|-------------------------|-------|-------------------------------------|-----|------|--------|
| GBKP | 81967 | 3-Piece ProGrabit Screw Removal Kit | 1 | 10 | 0.20# |
| REPLACEMENT BITS | | | | | |
| GB47R | 81968 | #4-#7 ProGrabit Replacement Bit | 1 | 10 | 0.05# |
| GB610R | 81969 | #6-#10 ProGrabit Replacement Bit | 1 | 10 | 0.05# |
| GB1214R | 81970 | #12-#14 ProGrabit Replacement Bit | 1 | 10 | 0.05# |

FEATURES:

- Quickly And Easily Removes Most Damaged Screws Such As Hex, Phillips, Torx, Square Drive; Sizes No. 4 - No.14 From Wood, Plastic Or Metal
- Two-Step, Drill Bit And Extractor In One Tool Extracts Broken Bolts And Damaged Screws Fast
- Use In Reverse Only With 3/8 In. Variable Speed Reversible Power Drill
- Drills Up To Grade 8 And 10.0 Class Fasteners; Extracts Bolt Sizes No. 10-3/8 In. (5mm-10mm)
- Caution! Always Wear Eye Protection

POWER WIRE NUT DRIVER

PC 6700



This multipurpose tool will handle most brands of wire connectors. Used in a power drill or screwdriver it saves wear and tear on wrists and fingers. Made of high impact plastic with a 1/4" metal shank.

FEATURES:

- Disassembles For Easy Transportation

| CAT. NO. | UPC | DESCRIPTION | STD | MSTR | WT/STD |
|----------|-------|------------------------------|-----|------|--------|
| CX1 | 24100 | Power Driver with 1/4" Shank | 1 | 10 | 0.07# |

HIGH SPEED STEEL DRILLS

PC 6375

High speed drills are rolled forged and have a 135° split point. They are suitable for steel, steel forging, cast iron and other work materials.

MULTIPLE DRILLS PER CARD

| CAT. NO. | UPC | SIZE & QUANTITY PER CARD | STD | MSTR | WT/STD |
|----------|-------|--|-----|------|--------|
| HS4C | 82124 | Carded 5 pack - 1/16" High Speed Steel Drills | 1 | 6 | .03# |
| HS5C | 82125 | Carded 5 pack - 5/64" High Speed Steel Drills | 1 | 6 | .04# |
| HS6C | 82126 | Carded 4 pack - 3/32" High Speed Steel Drills | 1 | 6 | .05# |
| HS7C | 82127 | Carded 4 pack - 7/64" High Speed Steel Drills | 1 | 6 | .07# |
| HS8C | 82128 | Carded 4 pack - 1/8" High Speed Steel Drills | 1 | 6 | .09# |
| HS9C | 82129 | Carded 4 pack - 9/64" High Speed Steel Drills | 1 | 6 | .11# |
| HS10C | 82130 | Carded 3 pack - 5/32" High Speed Steel Drills | 1 | 6 | .14# |
| HS11C | 82131 | Carded 3 pack - 11/64" High Speed Steel Drills | 1 | 6 | .19# |
| HS12C | 82132 | Carded 3 pack - 3/16" High Speed Steel Drills | 1 | 6 | .24# |
| HS13C | 82133 | Carded 2 pack - 13/64" High Speed Steel Drills | 1 | 6 | .27# |
| HS14C | 82134 | Carded 2 pack - 7/32" High Speed Steel Drills | 1 | 6 | .32# |
| HS15C | 82135 | Carded 2 pack - 15/64" High Speed Steel Drills | 1 | 6 | .37# |
| HS16C | 82136 | Carded 2 pack - 1/4" High Speed Steel Drills | 1 | 6 | .44# |

SINGLE DRILLS PER CARD

| | | | | | |
|-------|-------|--|---|---|-------|
| HS17C | 82137 | Carded 1 pack - 17/64" High Speed Steel Drills | 1 | 6 | .74# |
| HS18C | 82138 | Carded 1 pack - 9/32" High Speed Steel Drills | 1 | 6 | .57# |
| HS19C | 82139 | Carded 1 pack - 19/64" High Speed Steel Drills | 1 | 6 | .63# |
| HS20C | 82140 | Carded 1 pack - 5/16" High Speed Steel Drills | 1 | 6 | .74# |
| HS21C | 82141 | Carded 1 pack - 21/64" High Speed Steel Drills | 1 | 6 | .44# |
| HS22C | 82142 | Carded 1 pack - 11/32" High Speed Steel Drills | 1 | 6 | .51# |
| HS23C | 82143 | Carded 1 pack - 23/64" High Speed Steel Drills | 1 | 6 | .53# |
| HS24C | 82144 | Carded 1 pack - 3/8" High Speed Steel Drills | 1 | 6 | .64# |
| HS25C | 82145 | Carded 1 pack - 25/64" High Speed Steel Drills | 1 | 6 | .66# |
| HS26C | 82146 | Carded 1 pack - 13/32" High Speed Steel Drills | 1 | 6 | .69# |
| HS27C | 82147 | Carded 1 pack - 27/64" High Speed Steel Drills | 1 | 6 | .82# |
| HS28C | 82148 | Carded 1 pack - 7/16" High Speed Steel Drills | 1 | 6 | .89# |
| HS29C | 82149 | Carded 1 pack - 29/64" High Speed Steel Drills | 1 | 6 | .93# |
| HS30C | 82150 | Carded 1 pack - 15/32" High Speed Steel Drills | 1 | 6 | 1.00# |
| HS31C | 82151 | Carded 1 pack - 31/64" High Speed Steel Drills | 1 | 6 | 1.09# |
| HS32C | 82152 | Carded 1 pack - 1/2" High Speed Steel Drills | 1 | 6 | 1.15# |

* Drill Bits available in bulk - Drop the 'C' - check your Price Master



FEATURES:

- Industrial Quality
- M2 High Speed Steel
- Heavy Duty Jobber Length
- Fractional Sizes
- 3 Flats on Sizes 3/16" and Larger
- Black and Gold Finish
- Caution! Always Wear Eye Protection

HIGH SPEED STEEL DRILL KITS

PC 6330

High speed drills are rolled forged and have a 135° split point. They are suitable for steel, steel forging, cast iron and other work materials.

| CAT. NO. | UPC | DESCRIPTION | SIZES | STD | MSTR | WT/STD |
|----------|-------|-------------|-------------------|-----|------|--------|
| M213 | 66500 | 13 pc. set | 1/16"-1/4" x 64th | 1 | 10 | 0.710# |
| M221 | 66550 | 21 pc. set | 1/16"-3/8" x 64th | 1 | 10 | 1.580# |
| M229 | 29850 | 29 pc. set | 1/16"-1/2" x 64th | 1 | 10 | 3.100# |



FEATURES:

- Industrial Quality
- M2 High Speed Steel
- Heavy Duty Jobber Length
- Fractional Sizes
- 3 Flats on Sizes 3/16" and Larger
- Black and Gold Finish
- Caution! Always Wear Eye Protection

HIGH SPEED STEEL DIAL-A-DRILL KIT

PC 6340

| CAT. NO. | UPC | DESCRIPTION | SIZES | STD | MSTR | WT/STD |
|----------|-------|-------------|-------------------|-----|------|--------|
| DB13K | 67510 | 13 pc. set | 1/16"-1/4" x 64th | 1 | 10 | 0.320# |

FEATURES:

- Industrial Quality
- M2 High Speed Steel
- Heavy Duty Jobber Length
- Fractional Sizes
- 3 Flats on Sizes 3/16" and Larger
- Black and Gold Finish
- Caution! Always Wear Eye Protection





MASONRY & SDS 4 PLUS ROTARY HAMMER DRILL BITS

CARBIDE TIP MASONRY DRILL BITS

PC 6320



Masonry drills have tungsten carbide tips and are suitable for brick, concrete, tile, slate and cinder block.

FEATURES:

- Tungsten Carbide
- Tempered Body For Long Life
- Slow Spiral
- Suitable For Rotary Or Percussion
- Black Oxide Coated
- Packed In Display Pouch
- Caution! Always Wear Eye Protection

| CAT. NO. | UPC | SIZE | SHANK | STD | MSTR | WT/STD |
|----------|-------|-----------|-------|-----|------|--------|
| MD1 | 30205 | 3/16 x 4 | 3/16" | 1 | 10 | 0.03# |
| MD2 | 30210 | 1/4 x 4" | 1/4" | 1 | 10 | 0.04# |
| MD2L | 30300 | 1/4 x 6" | 1/4" | 1 | 5 | 0.07# |
| MD2XL | 30302 | 1/4 x 12" | 1/4" | 1 | 5 | 0.15# |
| MD3 | 30215 | 5/16 x 4" | 1/4" | 1 | 10 | 0.06# |
| MD4 | 30220 | 3/8 x 4" | 1/4" | 1 | 10 | 0.07# |
| MD4L | 30304 | 3/8 x 6" | 1/4" | 1 | 5 | 0.13# |
| MD4XL | 30306 | 3/8 x 12" | 3/8" | 1 | 5 | 0.29# |
| MD5 | 30225 | 7/16 x 4" | 1/4" | 1 | 5 | 0.10# |
| MD6 | 30230 | 1/2 x 4" | 1/4" | 1 | 5 | 0.11# |
| MD6L | 30308 | 1/2 x 6" | 1/4" | 1 | 5 | 0.21# |
| MD6XL | 30310 | 1/2 x 12" | 3/8" | 1 | 5 | 0.45# |
| MD7L | 30312 | 5/8 x 6" | 3/8" | 1 | 5 | 0.29# |
| MD7XL | 30314 | 5/8 x 12" | 3/8" | 1 | | 0.58# |
| MD8L | 30316 | 3/4 x 6" | 1/2" | 1 | | 0.44# |
| MD8XL | 30318 | 3/4 x 12" | 1/2" | 1 | | 0.92# |
| MD9L | 30320 | 7/8 x 6" | 1/2" | 1 | | 0.56# |
| MD10L | 30322 | 1 x 6" | 1/2" | 1 | | 0.71# |

SDS 4 PLUS ROTARY HAMMER DRILL BITS

PC 4580



This fast, tough carbide tip provides long life, easy centering, and fast drilling through all aggregates, concrete, masonry, brick, stone and even rebar! A dynamic chisel-shaped drill head ensures swift penetration and feeds the debris simultaneously to the flute section. The 3 fluted, spacious KVS-spiral removes the debris rapidly from the bore hole, saving the operator both time and money.

FEATURES:

- Cuts Through Rebar
- Easy Centering
- Special Flute Design
- Conforms To ANSI Standards
- Special Tungsten Carbide Tip
- Packed In Display Pouch
- Caution! Always Wear Eye Protection

| CAT. NO. | UPC | SIZE | DRILLING DEPTH | STD | MSTR | WT/STD |
|-----------|-------|---------------|----------------|-----|------|--------|
| SDS36412 | 12200 | 3/16 x 4-1/2" | 2" | 1 | 6 | 0.08# |
| SDS36614 | 12201 | 3/16 x 6-1/4" | 4" | 1 | 6 | 0.09# |
| SDS36814 | 12202 | 3/16 x 8-1/4" | 6" | 1 | 6 | 0.10# |
| SDS3610 | 12203 | 3/16 x 10" | 8" | 1 | 6 | 0.13# |
| SDS3612 | 12204 | 3/16 x 12" | 10" | 1 | 6 | 0.15# |
| SDS732412 | 12205 | 7/32 x 4-1/2" | 2" | 1 | 6 | 0.10# |
| SDS732614 | 12206 | 7/32 x 6-1/4" | 4" | 1 | 6 | 0.12# |
| SDS732814 | 12207 | 7/32 x 8-1/4" | 6" | 1 | 6 | 0.13# |
| SDS14412 | 12208 | 1/4 x 4-1/2" | 2" | 1 | 6 | 0.10# |
| SDS14614 | 12209 | 1/4 x 6-1/4" | 4" | 1 | 6 | 0.11# |
| SDS14814 | 12210 | 1/4 x 8-1/4" | 6" | 1 | 6 | 0.14# |
| SDS1411 | 12211 | 1/4 x 11" | 9" | 1 | 6 | 0.16# |
| SDS1414 | 12212 | 1/4 x 14" | 12" | 1 | 6 | 0.19# |
| SDS516614 | 12213 | 5/16 x 6-1/4" | 4" | 1 | 6 | 0.13# |
| SDS516814 | 12214 | 5/16 x 8-1/4" | 6" | 1 | 6 | 0.15# |
| SDS38614 | 12215 | 3/8 x 6-1/4" | 4" | 1 | 6 | 0.16# |
| SDS38814 | 12216 | 3/8 x 8-1/4" | 6" | 1 | 6 | 0.19# |
| SDS381014 | 12217 | 3/8 x 10-1/4" | 8" | 1 | 6 | 0.23# |
| SDS381214 | 12218 | 3/8 x 12-1/4" | 10" | 1 | 6 | 0.29# |
| SDS3818 | 12219 | 3/8 x 18" | 16" | 1 | 6 | 0.50# |
| SDS12614 | 12220 | 1/2 x 6-1/4" | 4" | 1 | 6 | 0.19# |
| SDS121014 | 12221 | 1/2 x 10-1/4" | 8" | 1 | 6 | 0.28# |
| SDS121214 | 12222 | 1/2 x 12-1/4" | 10" | 1 | 6 | 0.41# |
| SDS1218 | 12223 | 1/2 x 18" | 16" | 1 | 6 | 0.70# |
| SDS58614 | 12224 | 5/8 x 6-1/4" | 4" | 1 | 6 | 0.22# |
| SDS588 | 12225 | 5/8 x 8" | 6" | 1 | 6 | 0.28# |
| SDS5812 | 12226 | 5/8 x 12" | 10" | 1 | 6 | 0.50# |
| SDS5818 | 12227 | 5/8 x 18" | 16" | 1 | 6 | 0.80# |
| SDS349 | 12228 | 3/4 x 9" | 6" | 1 | 6 | 0.47# |
| SDS789 | 12229 | 7/8 x 9" | 6" | 1 | 6 | 0.54# |

TOOLS & SPECIALTY ITEMS

SHIP AUGERS

PC 6290

Ship augers are versatile, high quality drills with a self feed screw point for fast, effortless boring and quick chip removal. Designed for drilling through clean lumber or wood where small nails may be encountered.

SHORT

| CAT. NO. | UPC | SIZE RANGE | STD | MSTR | WT/STD |
|----------|-------|------------|-----|------|--------|
| 609 | 14609 | 9/16" | 1 | 6 | 0.29# |
| 610 | 14610 | 5/8" | 1 | 6 | 0.34# |
| 612 | 14612 | 3/4" | 1 | 6 | 0.39# |
| 613 | 14613 | 13/16" | 1 | 6 | 0.49# |
| 614 | 14614 | 7/8" | 1 | 6 | 0.49# |
| 615 | 14615 | 15/16" | 1 | 6 | 0.51# |
| 616 | 14616 | 1" | 1 | 6 | 0.57# |
| 618 | 14618 | 1-1/8" | 1 | 6 | 0.69# |
| 620 | 14620 | 1-1/4" | 1 | 6 | 0.80# |
| 622 | 14622 | 1-3/8" | 1 | 6 | 0.90# |
| 624 | 14624 | 1-1/2" | 1 | 6 | 1.01# |



FEATURES:

- Heat Treated For Long Life
- Self Feeding Screw Point
- 7/16" Hex Shank
- Packed In Display Pouch
- 2 Recesses Provided for Extensions
- Caution! Always Wear Eye Protection

LONG

| CAT. NO. | UPC | SIZE RANGE | STD | MSTR | WT/STD |
|----------|-------|------------|-----|------|--------|
| 1809 | 21809 | 9/16" | 1 | 6 | 0.75# |
| 1810 | 21810 | 5/8" | 1 | 6 | 0.81# |
| 1812 | 21812 | 3/4" | 1 | 6 | 0.99# |
| 1813 | 21813 | 13/16" | 1 | 6 | 1.17# |
| 1814 | 21814 | 7/8" | 1 | 6 | 1.17# |
| 1815 | 21815 | 15/16" | 1 | 6 | 1.21# |
| 1816 | 21816 | 1" | 1 | 6 | 1.40# |
| 1818 | 21818 | 1-1/8" | 1 | 6 | 1.66# |
| 1820 | 21820 | 1-1/4" | 1 | 6 | 2.05# |
| 1822 | 21822 | 1-3/8" | 1 | 6 | 2.28# |
| 1824 | 21824 | 1-1/2" | 1 | 6 | 2.61# |

SHIP AUGER & SPEED D FEED EXTENSIONS

PC 6310

Extensions are used where additional reach is required.

| CAT. NO. | UPC | LENGTH | SHANK DIA | STD | MSTR | WT/STD |
|----------|-------|--------|-----------|-----|------|--------|
| X5 | 21955 | 5-1/2" | 7/16" | 1 | 6 | 0.50# |
| X9 | 22009 | 9" | 7/16" | 1 | 6 | 0.69# |
| X12 | 21956 | 12" | 7/16" | 1 | 6 | 0.95# |
| X18 | 22018 | 18" | 7/16" | 1 | 6 | 1.20# |
| X24 | 22024 | 24" | 7/16" | 1 | 6 | 1.46# |



FEATURES:

- Forged From High Grade Steel
- Accommodates 7/16" Diameter Shanks
- Add 5-1/2" to 24" In Length
- Heavy Duty Double Set Screw Lock

AUGER BIT FILE

PC 6291

Specially designed to sharpen auger bits for longer cutting life.

| CAT. NO. | UPC | SIZE RANGE | STD | MSTR | WT/STD |
|----------|-------|-------------------|-----|------|--------|
| AF7 | 11630 | 7" Auger Bit File | 1 | 6 | 0.04# |



FEATURES:

- Professional Grade
- Caution! Always Wear Eye Protection



SPADE DRILLS, BELL HANGER DRILLS & PILOT DRILLS

SPADE DRILL BITS

PC 6270



Spade drills are used for boring hardwoods, softwood, plywood and drywall. Fully heat treated to extend bit life and individually stamped with size.

FEATURES:

- Cold Forged
- Machine Finish
- Cutting Groove
- Rust Protection
- Wing Tip Design
- Precision Ground
- Hex Shank
- Packed In Display Pouch
- Caution! Always Wear Eye Protection

| CAT. NO. | UPC | SIZE | DRILLING DEPTH | STD | MSTR | WT/STD |
|----------|-------|--------|----------------|-----|------|--------|
| SPD14 | 21700 | 1/4" | 6" | 1 | 6 | 0.06# |
| SPD516 | 21702 | 5/16" | 6" | 1 | 6 | 0.10# |
| SPD38 | 21704 | 3/8" | 6" | 1 | 6 | 0.10# |
| SPD716 | 21706 | 7/16" | 6" | 1 | 6 | 0.10# |
| SPD12 | 21708 | 1/2" | 6" | 1 | 6 | 0.10# |
| SPD916 | 21710 | 9/16" | 6" | 1 | 6 | 0.10# |
| SPD58 | 21712 | 5/8" | 6" | 1 | 6 | 0.10# |
| SPD1116 | 21714 | 11/16" | 6" | 1 | 6 | 0.11# |
| SPD34 | 21716 | 3/4" | 6" | 1 | 6 | 0.11# |
| SPD1316 | 21718 | 13/16" | 6" | 1 | 6 | 0.10# |
| SPD78 | 21720 | 7/8" | 6" | 1 | 6 | 0.11# |
| SPD1516 | 21722 | 15/16" | 6" | 1 | 6 | 0.12# |
| SPD1 | 21724 | 1" | 6" | 1 | 6 | 0.11# |
| SPD118 | 21726 | 1-1/8" | 6" | 1 | 6 | 0.13# |
| SPD114 | 21728 | 1-1/4" | 6" | 1 | 6 | 0.13# |
| SPD138 | 21730 | 1-3/8" | 6" | 1 | 6 | 0.14# |
| SPD112 | 21732 | 1-1/2" | 6" | 1 | 6 | 0.15# |

BELL HANGER DRILLS

PC 6280



Bell hanger drills are used to drill and fish small gauge wires. After drilling through the stud or header, a wire is attached to the fish hole in the flute and the drill is retracted, pulling the wire through. Bell hangers are available in a variety of diameters and lengths and are suitable for telephone installations, security and cable applications.

FEATURES:

- Fish Hole In Flute For Pulling Wire
- Tapered For Quick Chip Clearance
- One Per Display Pouch
- Aggressive Point For Fast Drilling In Wood & Metal
- Caution! Always Wear Eye Protection

| CAT. NO. | UPC | SIZE | LENGTH | STD | MSTR | WT/STD |
|----------|-------|-------|--------|-----|------|--------|
| BLH3612 | 21750 | 3/16" | 12" | 1 | 6 | 0.11# |
| BLH1412 | 21752 | 1/4" | 12" | 1 | 6 | 0.17# |
| BLH5612 | 21754 | 5/16" | 12" | 1 | 6 | 0.25# |
| BLH3812 | 21756 | 3/8" | 12" | 1 | 6 | 0.34# |
| BLH1212 | 21758 | 1/2" | 12" | 1 | 6 | 0.54# |
| BLH1418 | 21760 | 1/4" | 18" | 1 | 6 | 0.26# |
| BLH5618 | 21762 | 5/16" | 18" | 1 | 6 | 0.39# |
| BLH3818 | 21764 | 3/8" | 18" | 1 | 6 | 0.55# |
| BLH1218 | 21766 | 1/2" | 18" | 1 | 6 | 0.87# |
| BLH1424 | 21770 | 1/4" | 24" | 1 | 6 | 0.35# |
| BLH5624 | 21772 | 5/16" | 24" | 1 | 6 | 0.53# |
| BLH3824 | 21774 | 3/8" | 24" | 1 | 6 | 0.75# |
| BLH1224 | 21776 | 1/2" | 24" | 1 | 6 | 1.22# |
| BLH1430 | 21778 | 1/4" | 30" | 1 | 6 | 0.38# |
| BLH3830 | 21780 | 3/8" | 30" | 1 | 6 | 0.88# |
| BLH1442 | 21782 | 1/4" | 42" | 1 | 6 | 0.61# |
| BLH3842 | 21784 | 3/8" | 42" | 1 | 6 | 1.31# |

PILOT DRILLS & ACCESSORIES

PC 6390



Pilot drills are available with three flats or three notches. Set screws secure drill in arbor.



FEATURES:

- 1/4" High Speed Drill Pilot
- Split Point Design
- Caution! Always Wear Eye Protection

| CAT. NO. | UPC | DESCRIPTION | STD | MSTR | WT/STD |
|----------|-------|---|-----|------|--------|
| VPD4 | 28540 | 4-1/2 x 1/4" Pilot Drill, Shank Ground 3 Sides | 1 | 10 | 0.05# |
| VPD4N | 28545 | 4-1/2 x 1/4" Pilot Drill, 3 Notches for Set Screw | 1 | 10 | 0.05# |
| VPD4S | 28550 | 3-1/16" Pilot Drill for V24K, V34, & V35P Arbors | 1 | 10 | 0.05# |
| VE121 | 28555 | 12" Extension for 7/16" Arbors | 1 | 1 | 0.80# |
| V44N | 28560 | Adapter Nut- Adapts Arbor with 1/2-20 threads to fit Hole Saw with 5/8-18 Threads | 1 | 1 | 0.65# |

TOOLS & SPECIALTY ITEMS

SPEED D FEED BITS

PC 6355

Speed D Feed multi-spur wood boring bits are ideal for boring large holes quickly - from 1" through 4-5/8". This bit is especially suited to electricians and plumbers.

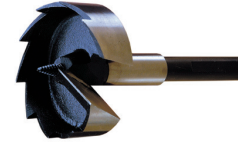

| CAT. NO. | UPC | SIZE | STD | MSTR | WT/STD |
|----------|-------|---------|-----|------|--------|
| SDF100 | 21900 | 1" | 1 | 6 | 0.44# |
| SDF118 | 21901 | 1-1/8" | 1 | 6 | 0.47# |
| SDF114 | 21902 | 1-1/4" | 1 | 6 | 0.50# |
| SDF138 | 21903 | 1-3/8" | 1 | 6 | 0.50# |
| SDF112 | 21904 | 1-1/2" | 1 | 6 | 0.56# |
| SDF134 | 21905 | 1-3/4" | 1 | 6 | 0.63# |
| SDF200 | 21906 | 2" | 1 | 6 | 0.73# |
| SDF218 | 21907 | 2-1/8" | 1 | 6 | 0.81# |
| SDF214 | 21908 | 2-1/4" | 1 | 6 | 0.94# |
| SDF2916 | 21909 | 2-9/16" | 1 | 6 | 1.06# |
| SDF300 | 21910 | 3" | 1 | 6 | 1.50# |
| SDF358 | 21911 | 3-5/8" | 1 | 6 | 2.00# |
| SDF458 | 21912 | 4-5/8" | 1 | 6 | 3.50# |

REPLACEMENT SCREW POINTS

| | | | | | |
|--------|-------|---------------------------------------|---|---|-------|
| SDF14S | 21913 | 1/4 x 2-1/2" (For 1" thru 2-9/16") | 1 | 6 | 0.01# |
| SDF14L | 21914 | 1/4 x 2-3/4" (For 3" thru 4-5/8") | 1 | 6 | 0.01# |

FEATURES:

- Fast Heavy Duty Power Boring
- Tapered Back For Easy Back Out
- Universal 7/16" Shank, 5" OA Length
- Replaceable Double Ended Self Feeding Point
- Open Design For No Clog Fast Chip Removal
- Precision Angled Surface For Smoother Cuts
- Packed In Display Pouch
- Caution! Always Wear Eye Protection

FLEX-A-BIT

PC 6360

Flex A Bits are used to drill within walls and are able to reach normally inaccessible areas through a small opening. After (drilling) through a stud or header, a wire is attached to the fish hole in the flute and the drill is retracted pulling the wire through. The FG357 Flex A Guide tool aids in positioning the bit.



| CAT. NO. | UPC | SIZE | STD | MSTR | WT/STD |
|----------|-------|------------|-----|------|--------|
| FB3854 | 37000 | 3/8 x 54" | 1 | 6 | 0.50# |
| FB3872 | 37005 | 3/8 x 72" | 1 | 6 | 0.64# |
| FB5054 | 37010 | 1/2 x 54" | 1 | 6 | 0.53# |
| FB5072 | 37015 | 1/2 x 72" | 1 | 6 | 0.68# |
| FB9654 | 37030 | 9/16 x 54" | 1 | 6 | 0.54# |
| FB9672 | 37035 | 9/16 x 72" | 1 | 6 | 0.68# |
| FB7554 | 37020 | 3/4 x 54" | 1 | 6 | 0.95# |
| FB7572 | 37025 | 3/4 x 72" | 1 | 6 | 1.22# |

FLEX-A-BIT TOOL

| | | | | | |
|-------|-------|-----|---|---|-------|
| FG357 | 37040 | All | 1 | 6 | 0.45# |
|-------|-------|-----|---|---|-------|



FEATURES:

- Self Feeding Point
- Flexible Spring Steel Shaft
- Packed In Display Pouch
- Caution! Always Wear Eye Protection

TECH TALK

Electrician's Flex-A-Bits are specifically designed to facilitate fishing wires and cables through walls and ceilings. A self feeding screw point is permanently brazed to flexible shafts.

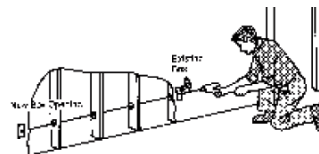

HOLE SAWS

PC 6380



Variable pitch hole saws are bi-metal construction with an M3 HSS cutting edge which is laser welded to a spring steel back. They will cut to depths of 1-3/8" and will outlast carbon steel hole saws, while the tooth design resists shock and strippage. The saws accept standard arbors and will cut stainless steel, iron, pipe, wood and plastic.

FEATURES:

- Bi Metal
- M3 Steel RC65-66
- Shatterproof
- 4/6 Variable Pitch
- Powder Coated
- Accepts Standard Arbors
- Packed On Display Card
- Caution! Always Wear Eye Protection

| CAT. NO. | UPC | DIA | USE ARBOR | PIPE SIZE | | STD | MSTR | WT/STD |
|----------|-------|---------|----------------|-----------|--------|-----|------|--------|
| | | | | TAP | ENTR. | | | |
| VP09 | 28400 | 9/16" | V24K, V34, V44 | | | 1 | 10 | 0.08# |
| VP10 | 28402 | 5/8" | V24K, V34, V44 | | | 1 | 10 | 0.09# |
| VP11 | 28404 | 11/16" | V24K, V34, V44 | | | 1 | 10 | 0.09# |
| VP12 | 28406 | 3/4" | V24K, V34, V44 | | 3/8" | 1 | 10 | 0.09# |
| VP13 | 28408 | 13/16" | V24K, V34, V44 | | | 1 | 10 | 0.11# |
| VP14 | 28410 | 7/8" | V24K, V34, V44 | 3/4" | 1/2" | 1 | 10 | 0.11# |
| VP15 | 28412 | 15/16" | V24K, V34, V44 | | | 1 | 10 | 0.13# |
| VP16 | 28414 | 1" | V24K, V34, V44 | | | 1 | 10 | 0.14# |
| VP18 | 28416 | 1-1/8" | V24K, V34, V44 | 1" | 3/4" | 1 | 10 | 0.19# |
| VP19 | 28418 | 1-3/16" | V24K, V34, V44 | | | 1 | 10 | 0.20# |
| VP20 | 28420 | 1-1/4" | V35P, V45P | | | 1 | 10 | 0.20# |
| VP21 | 28422 | 1-5/16" | V35P, V45P | | | 1 | 10 | 0.21# |
| VP22 | 28424 | 1-3/8" | V35P, V45P | | 1" | 1 | 10 | 0.24# |
| VP24 | 28426 | 1-1/2" | V35P, V45P | | | 1 | 10 | 0.28# |
| VP26 | 28428 | 1-5/8" | V35P, V45P | | | 1 | 10 | 0.34# |
| VP28 | 28430 | 1-3/4" | V35P, V45P | 1-1/2" | 1-1/4" | 1 | 10 | 0.23# |
| VP30 | 28432 | 1-7/8" | V35P, V45P | | | 1 | 10 | 0.27# |
| VP32 | 28434 | 2" | V35P, V45P | | 1-1/2" | 1 | 10 | 0.29# |
| VP34 | 28436 | 2-1/8" | V35P, V45P | | | 1 | 10 | 0.33# |
| VP36 | 28438 | 2-1/4" | V35P, V45P | 2" | | 1 | 10 | 0.36# |
| VP37 | 28440 | 2-5/16" | V35P, V45P | | | 1 | 10 | 0.33# |
| VP38 | 28442 | 2-3/8" | V35P, V45P | | | 1 | 10 | 0.33# |
| VP40 | 28444 | 2-1/2" | V45P | | 2" | 1 | 10 | 0.45# |
| VP41 | 28446 | 2-9/16" | V45P | | | 1 | 10 | 0.45# |
| VP48 | 28448 | 3" | V45P | | 2-1/2" | 1 | 10 | 0.60# |
| VP56 | 28450 | 3-1/2" | V45P | | | 1 | 10 | 0.62# |
| VP58 | 28452 | 3-5/8" | V45P | | 3" | 1 | 10 | 0.66# |
| VP64 | 28454 | 4" | V45P | | | 1 | 10 | 0.81# |
| VP66 | 28456 | 4-1/8" | V45P | | 3-1/2" | 1 | 10 | 0.85# |
| VP70 | 28458 | 4-3/8" | V45P | | | 1 | 10 | 0.91# |
| VP72 | 28460 | 4-1/2" | V45P | | | 1 | 10 | 0.96# |
| VP76 | 28462 | 4-3/4" | V45P | | 4" | 1 | 10 | 1.03# |
| VP80 | 28464 | 5" | V45P | | | 1 | 10 | 1.14# |
| VP88 | 28466 | 5-1/2" | V45P | | | 1 | 10 | 1.30# |
| VP96 | 28468 | 6" | V45P | | | 1 | 10 | 1.53# |

RECESSED LIGHTING HOLE SAWS

PC 6440



Kan Cut saws effectively cut through stucco, lath and plaster or two sheets of 5/8" drywall in one pass to a depth of two inches. Fits most major brands. Arbor not included use V45P.

FEATURES:

- Solid One Piece Construction
- Continuous Carbide Grit Edge
- Safer To Use
- Packed on Display Card
- Caution! Always Wear Eye Protection

KAN-CUT FIXTURE SAWS

| CAT. NO. | UPC | SIZE | STD | MSTR | WT/STD |
|----------|-------|--------|-----|------|--------|
| 358C | 15960 | 3-5/8" | 1 | 10 | 0.88# |
| 425C | 15962 | 4-1/4" | 1 | 10 | 1.06# |
| 438C | 15975 | 4-3/8" | 1 | 10 | 1.08# |
| 550C | 81781 | 5-1/2" | 1 | 10 | 1.50# |
| 638C | 15980 | 6-3/8" | 1 | 10 | 1.99# |
| 658C | 15985 | 6-5/8" | 1 | 10 | 2.05# |
| 678C | 15990 | 6-7/8" | 1 | 10 | 2.07# |
| V45P | 28525 | Arbor | 1 | 10 | 0.50# |

TOOLS & SPECIALTY ITEMS

HOLE SAW KITS

PC 6400

Hole saw kits are supplied with the most popular sizes for the electrician and plumber. The VP100 contains 9 popular electrical and plumbing saws, while the VP02E & VP08 are for the electrical conduit sizes. These kits contain the necessary arbors for all the hole saws.



ELECTRICIAN'S HOLE SAW KIT (CONTAINS 6 ELECTRICAL CONDUIT SIZES 1/2" - 2")

| CAT. NO. | UPC | SIZE | ARBORS | STD | MSTR | WT/STD | FEATURES: |
|----------|-------|-------------|-------------|-----|------|--------|--|
| VP02E | 28470 | VP14 7/8" | V44 V45P | 1 | 1 | 2.70# | <ul style="list-style-type: none"> • Packed In Molded Cases • Variable Pitch • Bi-Metal Blades • Caution! Always Wear Eye Protection |
| | | VP18 1-1/8" | | | | | |
| | | VP22 1-3/8" | | | | | |
| | | VP28 1-3/4" | | | | | |
| | | VP32 2" | | | | | |



MAINTENANCE HOLE SAW KIT (CONTAINS 9 PLUMBING AND ELECTRICAL CONDUIT SIZES 3/8" - 2")

| CAT. NO. | UPC | SIZE | ARBORS | STD | MSTR | WT/STD | FEATURES: |
|----------|-------|-------------|-------------------------------------|-----|------|--------|--|
| VP100 | 28472 | VP12 3/4" | V24K V44 V45P VE121 Extension | 1 | 1 | 4.82# | <ul style="list-style-type: none"> • Packed In Molded Cases • Variable Pitch • Bi-Metal Blades • Caution! Always Wear Eye Protection |
| | | VP14 7/8" | | | | | |
| | | VP18 1-1/8" | | | | | |
| | | VP22 1-3/8" | | | | | |
| | | VP24 1-1/2" | | | | | |



MASTER ELECTRICIAN'S HOLE SAW KIT (CONTAINS 10 ELECTRICAL CONDUIT SIZES 1/2" - 4")

| CAT. NO. | UPC | SIZE | ARBORS | STD | MSTR | WT/STD | FEATURES: |
|----------|-------|-------------|-------------------------------------|-----|------|--------|--|
| VP08 | 28474 | VP14 7/8" | V24K V44 V45P VE121 Extension | 1 | 1 | 7.80# | <ul style="list-style-type: none"> • Packed In Molded Cases • Variable Pitch • Bi-Metal Blades • Caution! Always Wear Eye Protection |
| | | VP18 1-1/8" | | | | | |
| | | VP22 1-3/8" | | | | | |
| | | VP28 1-3/4" | | | | | |
| | | VP32 2" | | | | | |



ARBORS

PC 6390

Arbors are supplied with pilot drills. Check Hole Saw to determine proper arbor.

| CAT. NO. | UPC | SHANK | THREAD SIZE | DRILL SIZE | DRILL NUMBER | SIZE | CHUCK FITS | STD | MSTR | WT/STD |
|----------|-------|------------|-------------|------------|--------------|------|----------------|-----|------|--------|
| V24K | 28500 | 1/4" Round | 1/2-20 | 1/4" | VPD4 | 1/4" | 9/16" - 1-1/8" | 1 | 6 | 0.13# |
| V34 | 28505 | 3/8" Hex | 1/2-20 | 1/4" | VDP4S | 3/8" | 9/16" - 1-1/8" | 1 | 6 | 0.15# |
| V35P | 28510 | 3/8" Hex | 5/8-18 | 1/4" | VDP4S | 3/8" | 1-1/4" - 6" | 1 | 6 | 0.36# |
| V44 | 28515 | 7/16" Hex | 1/2-20 | 1/4" | VPD4 | 1/2" | 9/16" - 1-1/8" | 1 | 6 | 0.16# |
| V45P | 28525 | 7/16" Hex | 5/8-18 | 1/4" | VPD4 | 1/2" | 1-1/4" - 6" | 1 | 6 | 0.50# |

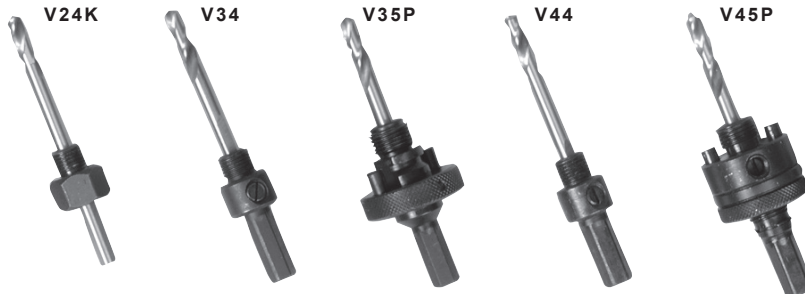

FEATURES:

- Interchangeable With Other Brands
- Includes Replaceable High Speed Pilot Drill
- Packed On Display Card
- Caution! Always Wear Eye Protection

* See page E6 for Pilot Drills & Accessories



12 TON HYDRAULIC PUNCH KITS

PC 6410

Our flagship and state of the art 12-Ton Hydraulic Hole Punch kits feature a compact yet extremely powerful punch pump with a 360 degree fully articulating 12-Ton Head. The 12-Ton articulating head allows users to punch holes in any position. Innovative three point dies ensure a clean cut every time, even on 10 gauge stainless steel! Each kit is packed in an ultra heavy duty carrying case with industrial strength latches.

FEATURES:

- Aluminum Tool Features 12 Ton Fully Articulating Head - 360° Capability
- Only ONE Tool Required for All Dies to 6"
- Laser Etched Markings on Die Cups for Precise Location
- Dies Require 50% Less Torque than Competitive Dies
- 3 Point Die Design - Slugs Cannot Bind They Just Fall Out!
- Cushioned Handle on Pump
- Ultra Heavy Duty Carrying Case
- Full Color Instructions



HPTK1 - 13 PIECE KIT FOR 1/2" TO 2 1/2" CONDUIT

Kit Includes:

- 1pc. 12 Ton Hydraulic Punch with Fully Articulating Head
- 7pc. Die Sets: Sizes - 7/8", 1-1/8", 1-3/8", 1-3/4", 2", 2-1/2", 3"
- 2pc. Draw Studs/Collar: Sizes - 3/8", 3/4"
- 2pc. Tip-Bits™ Steps Drills
- 1pc. 1/2" Die Spacer
- Ultra Heavy Duty Carrying Case



| CAT. NO. | UPC | DESCRIPTION | STD | MSTR | WT/STD |
|----------|-------|---------------------------|-----|------|--------|
| HPTK1 | 82044 | 1/2" to 2 1/2" (13pc kit) | 1 | | 21.65# |

HPTK2 - 16 PIECE KIT FOR 1/2" TO 4" CONDUIT

Kit Includes:

- 1pc. 12 Ton Hydraulic Punch with Fully Articulating Head
- 10pc. Die Sets: Sizes - 7/8", 1-1/8", 1-3/8", 1-3/4", 2", 2-1/2", 3", 3-1/2", 4", 4-1/2"
- 2pc. Draw Studs/Collar: Sizes - 3/8", 3/4"
- 2pc. Tip-Bits™ Steps Drills
- 1pc. 1/2" Die Spacer
- Ultra Heavy Duty Carrying Case



| CAT. NO. | UPC | DESCRIPTION | STD | MSTR | WT/STD |
|----------|-------|-----------------------|-----|------|--------|
| HPTK2 | 82045 | 1/2" to 4" (16pc kit) | 1 | | 40.00# |

HPTK3 - 3 PIECE DIE KIT FOR 3", 3-1/2" AND 4" CONDUIT

Kit Includes:

- 3pc. Die Sets: Sizes - 3-1/2", 4", and 4-1/2"
- Ultra Heavy Duty Carrying Case



| CAT. NO. | UPC | DESCRIPTION | STD | MSTR | WT/STD |
|----------|-------|--------------------|-----|------|--------|
| HPTK3 | 82043 | 3" to 4" (3pc Kit) | 1 | | 18.85# |

TOOLS & SPECIALTY ITEMS

CUPS & DIES

PC 6410

Our unique die sets feature 3 cutting points. With this feature, no slug will ever hang up and no effort is required to split a slug. The slug will simply fall out of the cup! Each Die cup is laser etched for precise hole location. Each cup and die is machined with the finest HSS for long lasting life.

CUPS

| CAT. NO. | UPC | DESCRIPTION | STD | MSTR | WT/STD |
|----------|-------|-----------------------------|-----|------|--------|
| HPC78 | 82010 | 7/8" Cup (1/2" Conduit) | 1 | | 0.25# |
| HPC118 | 82013 | 1 1/8" Cup (3/4" Conduit) | 1 | | 0.35# |
| HPC134 | 82019 | 1 3/4" Cup (1 1/4" Conduit) | 1 | | 0.45# |
| HPC138 | 82016 | 1 3/8" Cup (1" Conduit) | 1 | | 0.65# |
| HPC1732 | 82178 | 1-7/32" Cup (Hole Lock) | 1 | | 0.40# |
| HPC200 | 82022 | 2" Cup (1 1/2" Conduit) | 1 | | 0.80# |
| HPC212 | 82025 | 2 1/2" Cup (2" Conduit) | 1 | | 1.30# |
| HPC300 | 82028 | 3" Cup (2 1/2" Conduit) | 1 | | 1.55# |
| HPC312 | 82031 | 3 1/2" Cup (3" Conduit) | 1 | | 2.10# |
| HPC400 | 82034 | 4" Cup (3 1/2" Conduit) | 1 | | 2.65# |
| HPC412 | 82037 | 4 1/2" Cup (4" Conduit) | 1 | | 3.45# |

DIES

| | | | | | |
|---------|-------|-----------------------------|---|--|-------|
| HPD78 | 82009 | 7/8" Die (1/2" Conduit) | 1 | | 0.10# |
| HPD118 | 82012 | 1 1/8" Die (3/4" Conduit) | 1 | | 0.10# |
| HPD134 | 82018 | 1 3/4" Die (1 1/4" Conduit) | 1 | | 0.40# |
| HPD138 | 82015 | 1 3/8" Die (1" Conduit) | 1 | | 0.25# |
| HPD1732 | 82179 | 1-7/32" Die (Hole Lock) | 1 | | 0.20# |
| HPD200 | 82021 | 2" Die (1 1/2" Conduit) | 1 | | 0.65# |
| HPD212 | 82024 | 2 1/2" Die (2" Conduit) | 1 | | 1.20# |
| HPD300 | 82027 | 3" Die (2 1/2" Conduit) | 1 | | 1.60# |
| HPD312 | 82030 | 3 1/2" Die (3" Conduit) | 1 | | 2.35# |
| HPD400 | 82033 | 4" Die (3 1/2" Conduit) | 1 | | 2.85# |
| HPD412 | 82036 | 4 1/2" Die (4" Conduit) | 1 | | 3.30# |

CUP & DIE SETS

| | | | | | |
|---------|-------|--|---|--|-------|
| HPS78 | 82008 | 7/8" Set (1/2" Conduit) | 1 | | 0.10# |
| HPS118 | 82011 | 1 1/8" Set (3/4" Conduit) | 1 | | 0.10# |
| HPS134 | 82017 | 1 3/4" Set (1 1/4" Conduit) | 1 | | 0.40# |
| HPS138 | 82015 | 1 3/8" Set (1" Conduit) | 1 | | 0.25# |
| HPS1732 | 82177 | 1-7/32" Set (Hole Lock) | 1 | | 0.20# |
| HPS200 | 82020 | 2" Set (1 1/2" Conduit) | 1 | | 0.65# |
| HPS212 | 82023 | 2 1/2" Set (2" Conduit) | 1 | | 1.20# |
| HPS300 | 82026 | 3" Set (2 1/2" Conduit) | 1 | | 1.60# |
| HPS312 | 82029 | 3 1/2" Set (3" Conduit) | 1 | | 2.35# |
| HPS400 | 82033 | 4" Set (3 1/2" Conduit) | 1 | | 2.85# |
| HPS412 | 82035 | 4 1/2" Set (4" Conduit) | 1 | | 3.30# |
| HPS512 | 82170 | 5-1/2" Set (5" Conduit) | 1 | | 3.30# |
| HPS612 | 82171 | 4 1/2" Set (4" Conduit) Includes 1" Draw Stud | 1 | | 3.30# |



FEATURES:

- The Finest High Speed Steel (HSS) is Used in Dottie Dies
- Unique Design and Careful Machining Produces Long Lasting Dies Sets.
- Laser Etched Identification & Location Alignment Markings Make Dottie Cups and Dies Easy to Use on Any Job

ACCESSORIES

PC 6410

| CAT. NO. | UPC | DESCRIPTION | STD | MSTR | WT/STD |
|----------|-------|-------------------------------------|-----|------|--------|
| HPSDS38 | 82038 | Small Draw Stud (3/8") | 1 | | 0.25# |
| HPLDS75 | 82039 | Large Draw Stud (3/4") | 1 | | 0.35# |
| HPLDS100 | 82049 | Large Draw Stud (1") | 1 | | 0.45# |
| HPS | 82069 | Hydraulic Punch Spacer | 1 | | 0.65# |
| HPTMKIT | 82180 | HPT Maintenance Repair Kit - 12 Ton | 1 | | 0.40# |





RECIPROBLADES

PC 6450

RECIPROBLADES

Bi-metal blades have a flexible spring steel back and are laser welded to a hardened edge. Each blade is designed for a specific use and condition. "Tuff-Grit" carbide blades will cut cast iron.

| CAT. NO. | UPC | LENGTH | WIDTH | THICKNESS | TPI | APPLICATION | STD | MSTR | WT/STD |
|--|-------|--------|-------|-----------|-----|--|-----|------|--------|
| R414B | 31300 | 4" | 5/8" | 0.035 | 14 | Heavy gauge metal, 1/8" thick and above. | 5 | 25 | 0.13# |
| R418B | 31305 | 4" | 5/8" | 0.035 | 18 | Heavy gauge metal, 18 gauge to 1/8" thick. | 5 | 25 | 0.11# |
| R424B | 31310 | 4" | 5/8" | 0.035 | 24 | Metal cutting, 18 gauge and under. | 5 | 25 | 0.13# |
| R610B7 | 31315 | 6" | 3/4" | 0.035 | 10 | Nail-embedded wood, non-ferrous metal. | 5 | 25 | 0.20# |
| R614B7 | 31320 | 6" | 3/4" | 0.035 | 14 | Heavy gauge metal, 1/8" thick and above. | 5 | 25 | 0.21# |
| R618B7 | 31325 | 6" | 3/4" | 0.035 | 18 | Heavy gauge metal, 18 gauge to 1/8" thick. | 5 | 25 | 0.21# |
| R624B7 | 31330 | 6" | 3/4" | 0.035 | 24 | Metal cutting, 18 gauge and under. | 5 | 25 | 0.21# |
| R810B7 | 31335 | 8" | 3/4" | 0.035 | 10 | Nail-embedded wood, plastic, non-ferrous metal. | 5 | 25 | 0.28# |
| R814B7 | 31340 | 8" | 3/4" | 0.035 | 14 | General rough-in, metal cutting, nail-embedded wood. | 5 | 25 | 0.28# |
| R656BR | 31345 | 6" | 3/4" | 0.050 | 6 | Wood contours, nail-embedded wood. | 5 | 25 | 0.21# |
| R656BS | 31350 | 6" | 3/4" | 0.050 | 6 | General rough-in, all woods nail-embedded wood. | 5 | 25 | 0.22# |
| R956BR | 31355 | 9" | 3/4" | 0.050 | 6 | General rough-in, all woods nail-embedded wood. | 5 | 25 | 0.37# |
| R156BR | 31360 | 12" | 3/4" | 0.050 | 6 | General rough-in, all woods nail-embedded wood. | 5 | 25 | 0.53# |
| CARBIDE "TUF-GRIT" EDGE (ONE PER POUCH) | | | | | | | | | |
| R800TG | 31365 | 8" | 3/4" | 0.040 | n/a | Cast iron pipe. | 1 | 5 | 0.09# |



FEATURES:

- Bi Metal 8% Cobalt
- Vacuum Heat Treated
- Tooth Hardness RC66-68
- Powder Coated
- 5 Per Pouch, Priced Per Blade
- Caution! Wear Eye Protection

TOOLS & SPECIALTY ITEMS

SNAGGLETOOTH PRO SAW

PC 6559

The Snaggletooth Pro Saw is the right tool for cutting openings for electrical outlets, and the hardened tip penetrates drywall easily eliminating the need to drill.



| CAT. NO. | UPC | DESCRIPTION | LENGTH | STD MSTR WT/STD | | |
|----------|-------|----------------------|----------------------|-----------------|----|-------|
| SNG6 | 42092 | Snaggletooth Pro Saw | 6" Blade/12" Overall | 1 | 12 | 0.35# |

FEATURES:

- Easily Cuts Wallboard, Drywall, Plywood, & Plastic
- Blade Cuts In Both Directions
- Laser Cut Triple Ground Teeth
- Triangular Handle
- Sheath Included
- Caution! Always Wear Eye Protection

UTILITY SAW

PC 6560

The utility saw with its straight wooden handle is easier to manipulate than a pistol grip saw when cutting openings in drywall.



| CAT. NO. | UPC | DESCRIPTION | LENGTH | STD | MSTR | WT/STD |
|----------|-------|-------------|--------|-----|------|--------|
| UT6 | 28960 | Utility Saw | 6" | 1 | 12 | 0.18# |

FEATURES:

- 6" Blade
- Individual Display Pack
- Caution! Always Wear Eye Protection

PVC SAW & REPLACEMENT BLADES

PC 6500

The PVC Bi-Saw is designed for PVC and cuts on both the front and back stroke. The offset handle allows cutting at ground level while permitting hand clearance. The die cast, offset handle is interchangeable with most popular brands of replacement blades.



| CAT. NO. | UPC | DESCRIPTION | STD MSTR WT/STD | | |
|----------|-------|----------------------------|-----------------|---|-------|
| PVC12BH | 29380 | 12" Handle & Blade | 1 | 5 | 0.66# |
| PVC18BH | 29382 | 18" Handle & Blade | 1 | 5 | 0.77# |
| 12BLD | 29384 | 12" Replacement Blade Only | 1 | 5 | 0.33# |
| 18BLD | 29386 | 18" Replacement Blade Only | 1 | 5 | 0.46# |

FEATURES:

- Bi Metal
- Boxed Or Pouch
- Industrial Quality
- Caution! Always Wear Eye Protection

CABLE SAW

PC 6535

The Cable Saw easily cuts through PVC conduit. The quick release handle allows the cable saw blade to easily cut around PVC in hard to reach areas.

| CAT. NO. | UPC | DESCRIPTION | STD | MSTR | WT/STD |
|----------|-------|-------------|-----|------|--------|
| CS100 | 28967 | Cable Saw | 1 | 10 | 0.22# |



FEATURES:

- Quick Release Contour Handles
- Constructed with Stainless Cable
- Caution! Always Wear Eye Protection



LBK KNIFE, TOOL SHARPENER, PVC CUTTER & WIRE STRIPPER

LOCK BACK KNIFE

PC 6510



| CAT. NO. | UPC | DESCRIPTION | STD | MSTR | WT/STD |
|----------|-------|--|-----|------|--------|
| LBK | 10880 | Folding Lock-Back Utility Knife Replacement Blades | 1 | 12 | 0.55# |
| UBK | 16502 | Double Pointed Replacement Blades One Card Contains 5 Blades | 1 | 12 | 0.05# |

FEATURES:

- Lightweight ABS Handle w/ Clip
- Quick Change Blade Mechanism
- One Hand Opening Mechanism
- Spring Blade Release
- Includes Blade Storage & 6 Blades
- Caution! Always Wear Eye Protection

PROFESSIONAL KNIFE & TOOL SHARPENER

PC 6524



The knife sharpener anyone can use! No messy oils or stones. Sharpens knives in less that 10 seconds! It even works on serrated knives. Perfect tool for Electricians, Plumbers and Heating and Air Installers.

| CAT. NO. | UPC | DESCRIPTION | STD | MSTR | WT/STD |
|----------|-------|-------------------------------------|-----|------|--------|
| KS1 | 14660 | Professional Knife & Tool Sharpener | 1 | 12 | 0.30# |

FEATURES:

- Large Ergonomic Handle
- Full Length Finger Guard
- Diamond Honed Tungsten Carbide Sharpening Blades
- Sharpener Will Not Rust
- Easily Cleaned With Soap And Water
- Caution! Always Wear Eye Protection

K-PVC CUTTER

PC 6540



The KPVC cutter is an economical cutter for schedule 40 PVC, and its heavy blade makes easy work of it. Affordability and quality in one package.

| CAT. NO. | UPC | DESCRIPTION | STD | MSTR | WT/STD |
|--------------------------------------|-------|--------------------|-----|------|--------|
| KPVC | 28980 | K-PVC Cutter | 1 | 6 | 0.83# |
| PVC CUTTER REPLACEMENT BLADES | | | | | |
| KB | 28985 | Replacement Blades | 1 | 6 | 0.16# |

FEATURES:

- Heavy Duty Blade
- Cuts 1/2", 3/4" & 1" Schedule 40 PVC
- Blades Are Replaceable
- Caution! Always Wear Eye Protection

WIRE STRIPPER/CUTTER

PC 6590



This handy Wire Stripper/Cutter has been one of the most popular wire strippers contractors use. It is effective and fits easily in a pouch or pocket.

| CAT. NO. | UPC | DESCRIPTION | STD | MSTR | WT/STD |
|----------|-------|----------------------------------|-----|------|--------|
| DS1 | 28995 | Adjustable Stripper Cushion Grip | 1 | 6 | 0.83# |

FEATURES:

- Adjustable
- Cushion Grip
- Caution! Always Wear Eye Protection

QUICK STICKS

PC 6055

Dottie Quick Sticks offer unmatched durability to reach over drop ceilings, through insulated walls, as well as under floors and in any confined space. They are flexible enough to bend to the angle you need, yet rigid enough to push through insulation.



FEATURES:

- Quick Sticks Will Flex Up To 90° Without Breaking
- Made From High Strength, Low Weight Fiberglass Material
- Lite Sticks "Glow" In The Dark For Better Visibility During Use
- Caution! Always Wear Eye Protection

| CAT. NO. | UPC | SIZE | DESCRIPTION | STD | MSTR | WT/STD |
|------------|-------|-------------|---|-----|------|--------|
| QS3630 | 23132 | 3/16" x 30' | Tube Contains: Five - 3/16" x 6' Red Rods & Two Pulling Eyes | 1 | | 2.00# |
| QS3630LS | 23134 | 3/16" x 30' | Tube Contains: Five - 3/16" x 6' Lite Stick Rods & Two Pulling Eyes | 1 | | 2.00# |
| QS3612 | 23136 | 3/16" x 12' | Kit Contains: Four - 3/16" x 3' Red Rods w/ Pulling Eye & Hook | 1 | | 1.00# |
| QS3612LS | 23140 | 3/16" x 12' | Kit Contains: Four - 3/16" x 3' Lite Stick Rods w/ Pulling Eye & Hook | 1 | | 1.00# |
| QS3612X4 | 23166 | 3/16" x 12' | Tube Contains: Three - 3/16" x 4' Red Rods w/ Pulling Eye & Hook | 1 | | 1.00# |
| QS3612X4LS | 23165 | 3/16" x 12' | Tube Contains: Three - 3/16" x 4' Lite Stick Rods w/ Pulling Eye & Hook | 1 | | 1.00# |
| QS2524 | 23130 | 1/4" x 24' | Tube Contains: Four - 1/4" x 6' White Rods & Two Pulling Eyes | 1 | | 2.00# |
| QS2524LS | 23158 | 1/4" x 24' | Tube Contains: Four - 1/4" x 6' Lite Stick Rods & Two Pulling Eyes | 1 | | 2.00# |
| QS2512 | 23138 | 1/4" x 12' | Kit Contains: Four - 1/4" x 3' White Rods w/ Pulling Eye & Hook | 1 | | 1.00# |
| QS2512X4 | 23156 | 1/4" x 12' | Kit Contains: Three - 1/4" x 4' White Rods w/ Pulling Eye & Hook | 1 | | 1.00# |
| QS2512LS | 23155 | 1/4" x 12' | Kit Contains: Three - 1/4" x 4' Lite Stick Rods w/ Pulling Eye & Hook | 1 | | 1.00# |



Whisk
QSW36
QSW25



Hooks
QSPH36
QSPH25

QUICK STICK ACCESSORIES

| | | | | | | |
|--------|-------|-------|-------------------------------|---|--|-------|
| QSPE36 | 23146 | 3/16" | 3/16" Replacement Pulling Eye | 1 | | 0.01# |
| QSPH36 | 23148 | 3/16" | 3/16" Pulling Hook | 1 | | 0.01# |
| QSW36 | 23152 | 3/16" | 3/16" Whisk (egg beater) Head | 1 | | 0.01# |
| QSPE25 | 23142 | 1/4" | 1/4" Replacement Pulling Eye | 1 | | 0.01# |
| QSPH25 | 23144 | 1/4" | 1/4" Pulling Hook | 1 | | 0.01# |
| QSW25 | 23150 | 1/4" | 1/4" Whisk (egg beater) Head | 1 | | 0.01# |

QUICK LEADER

PC 6595

The Dottie Quick Leader is designed for maximum flexibility, curving around bends in conduit with ease. It is for a 1/8 inch wide steel fish tape and will pull up to 500lbs.



| CAT. NO. | UPC | SIZE | DESCRIPTION | STD | MSTR | WT/STD |
|----------|-------|------|--------------|-----|------|--------|
| QL12 | 11967 | 12" | Quick Leader | 1 | 10 | 0.12# |

FEATURES:

- For 1/8 Inch Wide Steel Fish Tapes
- Flexible Leader Makes Quick Work of Tight Bends
- Pulls Up To 500 Lbs.
- Guides Steel Fish Tape Around Bends In Conduit
- Caution! Always Wear Eye Protection



FIRST AID KITS

FA10 - 10 PERSON KIT

Dottie First Aid Kits are Compliant with OSHA/ANSI Standards, and stocked with comprehensive components that meet or exceed your requirements. Supplied in High Quality and Durable Translucent Cases that both Organize and Dispense the materials you will need to Treat Common First Aid Injuries and Conditions.

No office, vehicle, or worksite should be without this compact emergency First Aid Kit. The FK10 comes in a polypropylene case and includes all the supplies you need for up to 10 people.

| | | |
|-------------------------------|--------------------------------|--------------------------------|
| FA10 First Aid Kit | TREAT: | 2 Non Adherent Pads 1/2" x 2" |
| CLEAN: | 6 Antibiotic Ointment | 1 Paper Tape Roll 1/2" x 5 yd |
| 12 Alcohol Prep Pads | 6 Burn Cream | 1 Triangular Bandage 40" x 40" |
| 12 Antiseptic Towelettes | 1 Instant Cold Pack 5" x 6 | x 56" |
| | | 4 Sterile Gauze Pads 2" x 2" |
| TOOLS/INSTRUMENTS: | PROTECT: | 4 Sterile Gauze Pads 3" x 3" |
| 1 First Aid Instruction Guide | 16 Adhesive Bandages 1" x 3" | 4 Sterile Gauze Pads 4" x 4" |
| 4 Examination Gloves | 25 Adhesive Bandages 3/4" x 3" | 1 Sterile Trauma Pad 5" x 9" |



| CAT. NO. | UPC | DESCRIPTION | STD | MSTR | WT/STD |
|----------|-------|------------------------------------|-----|------|--------|
| FA10 | 84896 | First Aid Kit-10 Person-100 Pieces | 1 | 4 | 1.00# |

FEATURES:

- Kit Exceeds Federal OSHA Requirements
- Serves up to 10 People/100 pieces
- Molded Handle and Sliding Latches
- Mount On Work Site

FA25 - 25 PERSON KIT

An emergency can happen at any time - anywhere your work force goes to do their job. This well stocked emergency first aid kit supplies all your office, factory or worksite needs for up to 25 people. Packed in a polypropylene case.

| | | |
|-------------------------------|--------------------------------|------------------------------------|
| FA25 First Aid Kit | 1 Scissors | 20 Adhesive Bandages 3/8" x 1-1/2" |
| CLEAN: | TREAT: | 5 Butterfly Closures |
| 15 Alcohol Prep Pads | 6 Antibiotic Ointment | 1 Paper Tape Roll 1/2" x 5 yd |
| 12 Antiseptic Towelettes | 6 Burn Cream | 1 Triangular Bandage 40" x 40" |
| 1 Eye Wash | 3 Sting Relief Prep Pads | x 56" |
| | 8 Aspirin Tablets | 8 Sterile Gauze Pads 2" x 2" |
| TOOLS/INSTRUMENTS: | 8 Non-Aspirin Tablets | 2 Oval Eye Pads 2" |
| 10 Cotton Tip Applicators | 1 Instant Cold Pack 5" x 6 | 6 Sterile Gauze Pads 4" x 4" |
| 3 Finger Splints | | 1 Sterile Trauma Pad 5" x 9" |
| 1 First Aid Instruction Guide | PROTECT: | 1 Gauze Roll 2' |
| 4 Examination Gloves | 20 Adhesive Bandages 1" x 3" | |
| 5 Safety Pins | 20 Adhesive Bandages 3/4" x 3" | |
| 1 Tweezers | | |



| CAT. NO. | UPC | DESCRIPTION | STD | MSTR | WT/STD |
|----------|-------|------------------------------------|-----|------|--------|
| FA25 | 84895 | First Aid Kit-25 Person-170 Pieces | 1 | 4 | 1.50# |

FEATURES:

- Kit Exceeds Federal OSHA Requirements ANSI Z308.1
- Serves up to 25 People/170 pieces
- Molded Handle and Sliding Latches
- Mount On Work Site

TOOLS & SPECIALTY ITEMS

FIRST AID KITS



PC 6615

FA50 - 50 PERSON KIT

Stock your large facility or work site with this complete emergency first aid kit. This durable kit is packed with a large assortment of first aid supplies to meet your needs for up to 50 people. Packed in a polypropylene case.

FA50 First Aid Kit

CLEAN:

- 24 Alcohol Prep Pads
- 21 Antiseptic Towelettes
- 1 Eye Wash

TOOLS/INSTRUMENTS:

- 10 Cotton Tip Applicators
- 5 Finger Splints
- 1 First Aid Instruction Guide
- 4 Examination Gloves
- 10 Safety Pins
- 1 Tweezers

- 1 Scissors

TREAT:

- 6 Antibiotic Ointment
- 6 Burn Cream
- 3 Sting Relief Prep Pads
- 10 Aspirin Tablets
- 10 Non-Aspirin Tablets
- 2 Instant Cold Pack 5" x 6"

PROTECT:

- 20 Adhesive Bandages 1" x 3"
- 40 Adhesive Bandages 3/4" x 3"

- 30 Adhesive Bandages 3/8" x 1-1/2"
- 5 Butterfly Closures
- 5 Knuckle Bandages
- 5 Non-Adherent Pads 1/2" x 2"
- 1 Paper Tape Roll 1/2" x 5 yd
- 1 Triangular Bandage 40" x 40" x 56"
- 10 Sterile Gauze Pads 2" x 2"
- 2 Oval Eye Pads 2"
- 6 Sterile Gauze Pads 4" x 4"
- 1 Sterile Trauma Pad 5" x 9"
- 1 Gauze Roll 2"

| CAT. NO. | UPC | DESCRIPTION | STD | MSTR | WT/STD |
|----------|-------|------------------------------------|-----|------|--------|
| FA50 | 84898 | First Aid Kit-50 Person-250 Pieces | 1 | 4 | 2.20# |

FEATURES:

- Kit Exceeds Federal OSHA Requirement ANSI Z308.1
- Serves up to 50 People/250 pieces
- Molded Handle and Sliding Latches
- Mount On Work Site



FA100 - 100 PERSON KIT

Dottie's Best Kit - Stock your large facility or work site with this complete emergency first aid kit. This durable kit is packed with a large assortment of first aid supplies to meet your needs for up to 100 people. Packed in a polypropylene case.

FA100 First Aid Kit

CLEAN:

- 36 Alcohol Prep Pads
- 21 Antiseptic Towelettes

TREAT:

- 6 Antibiotic Ointment
- 6 Burn Cream
- 6 Sting Relief Prep Pads
- 10 Antacid Tablets
- 10 Aspirin Tablets
- 10 Non-Aspirin Tablets
- 1 Instant Cold Pack 5" x 6"

PROTECT:

- 40 Adhesive Bandages 1" x 3"
- 60 Adhesive Bandages 3/4" x 3"
- 50 Adhesive Bandages 3/8" x 1-1/2"
- 14 Butterfly Closures
- 18 Wound Closure Strips
- 1 Paper Tape Roll 1/2" x 5 yd
- 1 Triangular Bandage 40" x 40" x 56"
- 8 Sterile Gauze Pads 2" x 2"
- 2 Sterile Eye Pads 2"
- 4 Sterile Gauze Pads 4" x 4"
- 1 Sterile Trauma Pad 5" x 9"

- 1 Gauze Roll 2"

TOOLS/INSTRUMENTS:

- 30 Cotton Tip Applicators
- 5 Finger Splints
- 1 First Aid Instruction Guide English
- 1 First Aid Instruction Guide Spanish
- 4 Examination Gloves
- 5 Safety Pins
- 1 Tweezers
- 1 Scissors

| CAT. NO. | UPC | DESCRIPTION | STD | MSTR | WT/STD |
|----------|-------|-------------------------------------|-----|------|--------|
| FA100 | 84897 | First Aid Kit-100 Person-350 Pieces | 1 | 4 | 4.20# |

FEATURES:

- Kit Exceeds Federal OSHA Requirements ANSI Z308.1
- Serves up to 100 People/350 pieces
- Molded Handle and Sliding Latches
- Mount On Work Site



TOOLS & SPECIALTY ITEMS

SAFETY HELMETS & RATCHET SAFETY HELMETS

PC 6616



FEATURES:

- Lightweight High Density Polyethylene
- Short Peak and Trim Profile
- Rain Trough Side & Back
- Universal Accessory Slot
- Removable Cushioned Brow Pad
- 4-Point Impact Absorbing Suspension

Safety helmets are required on most job sites. The woven nylon suspension is comfortable and absorbs impact. On the ratchet model the head size can be adjusted without removing the helmet, providing a no slip hold – even in the most physically active job.

SAFETY HELMET

| CAT. NO. | UPC | COLOR | STD | MSTR | WT/STD |
|----------|-------|--------|-----|------|--------|
| SFTY | 11635 | Yellow | 1 | 6 | 0.75# |
| SFTW | 11636 | White | 1 | 6 | 0.75# |
| SFTO | 11637 | Orange | 1 | 6 | 0.75# |

RATCHET SAFETY HELMETS

| SFTYR | SFTWR | UPC | COLOR | STD | MSTR | WT/STD |
|-------|-------|-------|--------|-----|------|--------|
| | | 11638 | Yellow | 1 | 6 | 0.89# |
| | | 11639 | White | 1 | 6 | 0.89# |

- Quick Slide Sizing From 6-1/2 to 7-3/4"
- USA Made Meets ANSI Z89 1-1997 Type I class C, E & G Requirements

Ratchet Safety Helmet:

- 6-Point Impact Absorbing Suspension
- Ratchet EZ Turn Knob
- Sizes 6-1/2" to 8", 40 Increments

CLIMATE GEAR™

PC 6618



FEATURES:

- 100% Waterproof & Non-Conductive
- High Visibility Safety Yellow
- Heavy Duty 35mm PVC Bonded To Polyester
- Packed In Hang-Up Bag

The heavy duty yellow rain suit consists of three pieces; extra large cut jacket, detachable hood, and bib overalls.

- Constructed with heavyweight 0.35mm PVC with polyester backing.
- Jacket, bib pants, detachable hood.
- Full cut sizes to fit over clothing.
- Rear mesh vents for breathability.
- Bib style pants with snap fly front and adjustable straps.
- Detachable drawstring hood.

| CAT. NO. | UPC | DESCRIPTION | SIZE | STD | MSTR | WT/STD |
|----------|--------------|--------------------------------|----------|-----|------|--------|
| R101M | 084298010132 | 3 Pc Heavyweight PVC Rain Suit | Medium | 1 | 6 | 3.43# |
| R101L | 084298010149 | 3 Pc Heavyweight PVC Rain Suit | Large | 1 | 6 | 3.43# |
| R101X | 084298010156 | 3-PC Heavyweight PVC Rain Suit | X-Large | 1 | 6 | 3.43# |
| R1012X | 084298010163 | 3-PC Heavyweight PVC Rain Suit | 2X-Large | 1 | 6 | 4.30# |

HI-VIZ

PC 6617



FEATURES:

- 100% Polyester mesh
- Front zipper closure
- 11 Storage pockets
- Mic. Hook-up loop
- 2" 3M Scotchlite™ silver stripes

This superior quality, ANSI Class 2 rated, surveyor's safety vest has 2" wide retro-reflective stripes and comes with 11 pockets, a mic loop, and a zipper front closure. We've taken the bright lime-yellow used on fire engines and incorporated light reflective striping to create a whole new concept in work gear.

| CAT. NO. | UPC | DESCRIPTION | SIZE | STD | MSTR | WT/STD |
|----------|--------------|-------------------------------|----------|-----|------|--------|
| SV22L | 084298142246 | Surveyor's Vest Class 2, Lime | Large | 1 | 3 | 0.49# |
| SV22XL | 084298142253 | Surveyor's Vest Class 2, Lime | X-Large | 1 | 3 | 0.51# |
| SV222X | 084298142260 | Surveyor's Vest Class 2, Lime | 2X-Large | 1 | 3 | 0.61# |
| SV223X | 084298142277 | Surveyor's Vest Class 2, Lime | 3X-Large | 1 | 3 | 0.64# |

SOFTFRAME GOGGLES

PC 6610

Soft, clear vinyl Goggle with universal bridge provides all day comfort and exceptional protection against dust and flying debris. Around-the-lens ventilation minimizes lens fogging. Comfortable over prescription glasses or when worn alone.

| CAT. NO. | UPC | DESCRIPTION | STD | MSTR | WT/STD |
|----------|-------|------------------|-----|------|--------|
| 206F | 40150 | Softframe Goggle | 1 | 10 | 0.26# |

FEATURES:

- Clear Anti-Fog Lens
- Cap Vented Clear Softframe



EAR PROTECTION

PC 6615

One pair per polybag. Packed 200 pair per dispenser box.

| CAT. NO. | UPC | DESCRIPTION | STD | MSTR | WT/STD |
|----------|-------|-------------------|--------|--------|--------|
| MLE200 | 11645 | MaxLite Ear Plugs | 200 Pr | 200 Pr | 0.94# |

FEATURES:

- ANSI S3.19-1974
- Noise Reduction Rate
- NRR 30db
- Low Pressure Foam Plugs



- Self Adjusting
- Non Allergenic
- Non Irritating

LATEX GLOVES AND SHOE COVERS

PC 6771

| CAT. NO. | UPC | DESCRIPTION | STD | MSTR | WT/STD |
|----------|-------|-------------------------|-----|------|--------|
| LG100 | 59860 | 100 Latex Gloves in Jar | 1 | 12 | 2.35# |
| SC | 59880 | 50 Shoe Covers in Jar | 1 | 9 | 0.90# |

LATEX GLOVES

- Superior Quality
- Resistant To Most Residual Solvents And Chemicals
- Universal Fit
- Perfect For Finish Work

SHOE COVERS

- Anti-Static
- Impervious Material
- Non-linting
- EZ On / EZ Off



DUST MASKS

PC 5310

| CAT. NO. | UPC | DESCRIPTION | STD | MSTR | WT/STD |
|----------|-------|------------------------------------|----------|----------|--------|
| MSK50 | 30450 | General Purpose Dust Mask | 50 | 500 | 1.14# |
| MSK55 | 30455 | General Purpose Dust Mask (5 pack) | 12 packs | 12 packs | 0.58# |

CAUTION: **General Purpose** Do Not Use As Protection From; Asbestons, Silica or Cotton Dust, Toxic Dust, Fumes, Mists, Gas or Vapor. NOT TO BE USED IN SPRAY PAINT OPERATIONS

FEATURES:

- General Purpose





MEGAPRO SCREWDRIVERS

15 IN 1 SCREWDRIVER

PC 6762



The Original Standard 15 in 1 driver contains seven double ended bits for a total of fourteen different standard drivers. The 1/4" shank fits any 1/4" hex power grooved bits and is also great for driving 1/4" hex head screws.

FEATURES:

- Palm Saving Rotation Cap
- Rotating Balance Point Collar
- Retracting Bit Storage
- High Impact Triax Housing

| CAT. NO. | UPC | CAP/BODY | DESCRIPTION | STD | MSTR | WT/STD |
|----------|-------|-------------|---|-----|------|--------|
| D151 | 10282 | Yellow/Blue | Original 15 in 1 Screwdriver - Carded | 1 | 10 | 0.49# |
| D151X | 84148 | Yellow/Blue | Original 15 in 1 Screwdriver - Bulk Labeled | 1 | 10 | 0.49# |

- Spring Loaded Ball Bearing Bit
- Full Length Solid Steel Shaft
- 59+ Rockwell Hardness
- Made In USA



TAMPER PROOF 15 IN 1 SCREWDRIVER

PC 6763



This 15 in 1 Tamper Proof driver is a must for all commercial/industrial tradesmen (Electricians, Security, etc.). The 15 in 1 Tamper Proof comes loaded with the most common security bits, including: Spanner, Hex pin and Star pin.

FEATURES:

- Contains Common Security Bit Load
- Specially Loaded For the Security Professional

| CAT. NO. | UPC | CAP/BODY | DESCRIPTION | STD | MSTR | WT/STD |
|----------|-------|-----------|---|-----|------|--------|
| D151TP | 10266 | Black/Red | 15 in 1 Tamper Proof Screwdriver - Carded | 1 | 10 | 0.55# |
| D151TPX | 84149 | Black/Red | 15 in 1 Tamper Proof Screwdriver - Bulk Labeled | 1 | 10 | 0.55# |

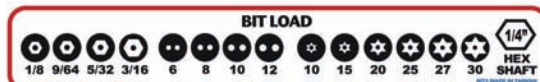

STAINLESS STEEL 15 IN 1 SCREWDRIVER

PC 6762



15 in 1 Stainless screwdriver is loaded with electroless nickel plated bits for use in areas where high corrosion or humidity are an issue. The driver is equipped with a stainless steel shaft.

FEATURES:

- Expressly Made For Outdoors And Marine Environments
- 14 Different Bit Sizes
- Standard Bitload

| CAT. NO. | UPC | CAP/BODY | DESCRIPTION | STD | MSTR | WT/STD |
|----------|-------|-------------|--|-----|------|--------|
| D151SS | 10265 | Blue/Yellow | 15 in 1 Stainless Steel Screwdriver - Carded | 1 | 10 | 0.55# |
| D151SSX | 84156 | Blue/Yellow | 15 in 1 Stainless Steel Screwdriver - Bulk Labeled | 1 | 10 | 0.55# |



HVAC 14 IN 1 SCREWDRIVER

PC 6762



14 in 1 HVAC multi bit screwdriver is loaded with the most common HVAC bits, including a valve stem bit.

FEATURES:

- Specially Loaded For The Heating, Ventilation And Air Conditioning Industry

| CAT. NO. | UPC | CAP/BODY | DESCRIPTION | STD | MSTR | WT/STD |
|-----------|-------|-----------|---|-----|------|--------|
| D151HVAC | 10267 | Blue/Blue | 14 in 1 HVAC Screwdriver - Carded | 1 | 10 | 0.55# |
| D151HVACX | 84151 | Blue/Blue | 14 in 1 HVAC Screwdriver - Bulk Labeled | 1 | 10 | 0.55# |



TOOLS & SPECIALTY ITEMS

13 IN 1 RATCHETING SCREWDRIVER

PC 6762

The new 13 in 1 cushion gripped ratcheting screwdriver is the latest edition to our popular line up of multi bit drivers. With its smooth patent pending ZAD 8 zinc alloy precision 28 tooth ratcheting mechanism, it delivers over 225 lbs of torque strength, which makes driving fasteners faster and easier than ever before. The convenient storage handle is loaded with six double-ended bits for a total of twelve different standard sized drivers. The 1/4" Hex drive shaft is great for driving 1/4" hex head screws. This is definitely a top of the line tool every professional contractor should have in his or her tool bag.



| CAT. NO. | UPC | CAP/BODY | DESCRIPTION | STD MSTR WT/STD | | |
|----------|-------|-----------|---|-----------------|----|-------|
| D131R | 81251 | Red/Black | 13 in 1 Ratcheting Screwdriver - Carded | 1 | 10 | 0.55# |
| D131RX | 81251 | Red/Black | 13 in 1 Ratcheting Screwdriver - Bulk Labeled | 1 | 10 | 0.55# |



Patented Pullout Bit Cartridge

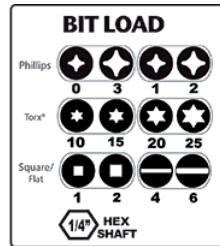

FEATURES:

- Convenient Storage For A Wide Range Of Bits
- 1/4" Hex Driver Shaft - Great For 1/4" Hex Head Screws
- Precision 28 Tooth Ratchet Makes Driving Fasteners Faster And Easier. Limited Lifetime Warranty.
- Heavy Duty Nylon Reinforced Handle & Chamfered Solid Steel Shaft For Long Life & Durability
- Cushion Grip, Tapered Designed Handle - Extra Comfort And Less Fatigue

TAMPERPROOF 2 SCREW DRIVERS

PC 6763

Our new Tamperproof 2 Driver features an additional selection of 14 different security fastener driver bits. Included are TRI-Wing, TORQ-SET, and TORX PLUS TAMPER RESISTANT. The shaft opening serves as a 1/4" hex driver.



| CAT. NO. | UPC | CAP/BODY | DESCRIPTION | STD MSTR WT/STD | | |
|----------|-------|----------|--|-----------------|----|-------|
| D151TP2 | 84145 | Red/Red | 15 in 1 Tamperproof 2 Screwdriver - Carded | 1 | 10 | 0.51# |
| D151TP2X | 84150 | Red/Red | 15 in 1 Tamperproof 2 Screwdriver - Bulk Labeled | 1 | 10 | 0.51# |

FEATURES:

- Specially Loaded for the Security Professional
- Contains the latest Bit Designs
- Handle is made from engineered Nylon/ABS resin, Triax 1120



SHAFTLOC SCREWDRIVER + EXTENSIONS

PC 6768, 6762

Locking shaft eliminates the danger of bits falling out of the shaft when getting partially "stuck" in the fastener. 6" & 10" Locking Extensions Los into ShaftLoc Driver shaft providing a slim profile into those hard to reach places. Link multiple extensions together for extra long reach.



| CAT. NO. | UPC | CAP/BODY | DESCRIPTION | STD MSTR WT/STD | | |
|------------|-------|----------------|---|-----------------|----|-------|
| D151SL44 | 84154 | Yellow/ Yellow | 15 in 1 ShaftLoc Screwdriver - Carded | 1 | 10 | 0.51# |
| D151SL44X | 84155 | Yellow/ Yellow | 15 in 1 ShaftLoc Screwdriver - Bulk Labeled | 1 | 10 | 0.51# |
| D6EXTSL6C | 84203 | Yellow | ShaftLok 6" Extension - Black Oxide - Carded | 1 | 5 | 0.05# |
| D6EXTSL10C | 84204 | Yellow | ShaftLok 10" Extension - Black Oxide - Carded | 1 | 5 | 0.06# |

FEATURES:

- ShaftLoc will pass through a 3/8" Diameter Opening
- Patented Retractable Bit Cartridge makes it EZ to find, change & store bits.
- Seven Double-ended Bits give you the 14 most popular screwdriver bits.
- Locking shaft eliminates the danger of bits falling out of the shaft when getting partially "stuck" in the fastener



TOOLS & SPECIALTY ITEMS

NICKEL PLATED REPLACEMENT BITS FOR MEGAPRO DRIVERS

PC 6768



| CAT. NO. | UPC | DESCRIPTION | STD | MSTR | WT/STD |
|----------|-------|---|-----|------|--------|
| NBT1015C | 81951 | T10 & T15 Star T20 & T25 Star | 1 | 5 | 0.02# |
| NBT2025C | 81952 | | 1 | 5 | 0.02# |
| NBP03C | 81953 | 0 & 3 Phillips 1 & 2 Phillips | 1 | 5 | 0.02# |
| NBP12C | 81954 | | 1 | 5 | 0.02# |
| NBS03C | 81955 | 0 & 3 Square Recess 1 & 2 Square Recess | 1 | 5 | 0.02# |
| NBS12C | 81956 | | 1 | 5 | 0.02# |
| NBSL46C | 81957 | 4 & 6 Slotted | 1 | 5 | 0.02# |
| RBVC | 81958 | Valve Stem Bit + 5.5 Slotted 1/4" Socket Adaptor | 1 | 5 | 0.02# |
| SA14C* | 81959 | | 1 | 5 | 0.02# |



FEATURES:

- Packed Two Per Card
- For Multi Bit Drivers
- Resists Corrosion

* Unplated

TAMPER PROOF REPLACEMENT BITS FOR MEGAPRO DRIVERS

PC 6779



| CAT. NO. | UPC | DESCRIPTION | STD | MSTR | WT/STD |
|----------|-------|--|-----|------|--------|
| RTP15C | 81960 | T10 & T15 Star Pin T20 & T25 Star Pin T27 & T30 Star Pin | 1 | 5 | 0.02# |
| RTP20C | 81961 | | 1 | 5 | 0.02# |
| RTP27C | 81962 | | 1 | 5 | 0.02# |
| RHP18C | 81963 | 1/8 & 9/64 Hex Pin 5/32 & 3/16 Hex Pin | 1 | 5 | 0.02# |
| RHP532C | 81964 | | 1 | 5 | 0.02# |
| RSP68C | 81965 | 6 & 8 Spanner 10 & 12 Spanner | 1 | 5 | 0.02# |
| RSP12C | 81966 | | 1 | 5 | 0.02# |



FEATURES:

- Packed Two Per Card
- For Multi Bit Drivers
- Resists Corrosion

SOCKET ADAPTER EXTENSIONS

PC 6720



| CAT. NO. | UPC | TYPE | SCREW SIZE | DRIVE LENGTH | STD | MSTR | WT/STD |
|----------|-------|------|----------------|--------------|-----|------|--------|
| SHA14114 | 23105 | 1/4" | 1/4" Hex Shank | 1/4 x 1-1/4" | 1 | 10 | 0.03# |
| SHA142 | 23108 | | 1/4" Hex Shank | 1/4 x 2" | 1 | 10 | 0.03# |
| SHA143 | 23111 | | 1/4" Hex Shank | 1/4 x 3" | 1 | 10 | 0.05# |
| SHA382 | 23114 | 3/8" | 1/4" Hex Shank | 3/8 x 2" | 1 | 10 | 0.04# |
| SHA383 | 23117 | | 1/4" Hex Shank | 3/8 x 3" | 1 | 10 | 0.08# |
| SHA384 | 23120 | | 1/4" Hex Shank | 3/8 x 4" | 1 | 10 | 0.11# |

FEATURES:

- Heat Treated To Resist Wear

COMPACT COMBO BIT KIT

PC 6340

This 31 piece bit kit contains the most often used Standard and Tamper Proof bits in a compact storage case, which is sized to fit in a contractor's pouch or can be easily attached to a belt. Includes a quick change bit holder.

31 Piece Assortment Kit contains the following:

- Square Drive 1 Ea IB0, IB1, IB2, IB3
- Phillips 1 Ea IB0P, IB1P, (IB2P 2 Ea), IB3P
- Slotted 1 Ea IB0S, IB1S, (IB2S 2 Ea), IB3S
- Star Pin 1 Ea 60TR10, 15, 20, 25, 27, 30,
- Spanner 1 Ea 115-6, 115-8, 115-10, 115-12, 115-14
- Hex Pin 1 Ea 73TR3, 5, 7, 8, 9
- Bit Holder 1 Ea QCA14



FEATURES:

- 31 Piece Assorted Standard and Tamper Proof
- Packed In A Belt Mount Case
- Contains Most Popular Sizes of Standard and Tamper Proof Bits

| CAT. NO. | UPC | DESCRIPTION | STD | MSTR | WT/STD |
|----------|-------|--|-----|------|--------|
| IB31PK | 23190 | 31 Assorted Bits w/ Quick Release Bit Holder | 1 | 6 | 0.50# |

TAMPER PROOF BIT KIT

PC 6760

The Tamper Proof Bit Driver Kit contains the full compliment of the most popular bits. The kit is provided with a magnetic hand driver, a socket adapter, and a magnetic bit holder for use in power tools.

31 Piece Assortment Kit contains the following:

- Slotted 1 Ea IB1S, IB2S, IB3S
- Phillips 1 Ea IB1P, IB2P, IB3P
- Square 1 Ea IB1, IB2, IB3
- Spanner 1 Ea 115-6, 115-8, 115-10
- Star Pin 1 Ea 60TR7, 8, 9, 10, 15, 20, 25, 27, 30, 40
- Hex Socket 1 Ea 73TR3, 4, 5, 6, 7, 8
- Magnetic Bit Holder 1 Ea MBH
- Magnetic Hand Driver 1 Ea MHD
- Socket Adapter 1 Ea SHA14114
- Storage Case 1 Ea SCR



FEATURES:

- 31 Piece Assortment
- Packed In Sturdy Polypro Case

| CAT. NO. | UPC | DESCRIPTION | STD | MSTR | WT/STD |
|----------|-------|-----------------------------|-----|------|--------|
| LS1TP | 60253 | 31 pc. Tamper Proof Bit Kit | 1 | | 1.13# |

TAMPER PROOF HAND DRIVERS

PC 6670

ONE WAY

| CAT. NO. | UPC | SCREW SIZE | DESCRIPTION | STD | MSTR | WT/STD |
|----------|-------|------------|--------------|-----|------|--------|
| OW68 | 23000 | #6-#8 | Removal Tool | 1 | 10 | 0.25# |
| OW810 | 23005 | #8-#10 | Removal Tool | 1 | 10 | 0.31# |
| OW1214 | 23010 | #12-#14 | Removal Tool | 1 | 10 | 0.35# |

SPANNER

| SPN | UPC | SIZE | DESCRIPTION | STD | MSTR | WT/STD |
|-------|-------|------|-------------|-----|------|--------|
| SPN6 | 23015 | #6 | Spanner | 1 | 10 | 0.22# |
| SPN8 | 23020 | #8 | Spanner | 1 | 10 | 0.22# |
| SPN10 | 23025 | #10 | Spanner | 1 | 10 | 0.22# |

STAR PIN

| STR | UPC | SIZE | DESCRIPTION | STD | MSTR | WT/STD |
|-------|-------|--------------|-------------|-----|------|--------|
| STR10 | 23030 | #6BH | Star Pin | 1 | 10 | 0.18# |
| STR15 | 23035 | #6FH-#8BH | Star Pin | 1 | 10 | 0.18# |
| STR20 | 23040 | #8FH | Star Pin | 1 | 10 | 0.18# |
| STR25 | 23045 | #10FH, #10BH | Star Pin | 1 | 10 | 0.19# |
| STR27 | 23050 | 1/4FH-1/4BH | Star Pin | 1 | 10 | 0.21# |
| STR30 | 23052 | 1/4FH | Star Pin | 1 | 10 | 0.22# |



FEATURES:

- Full Size Driver
- Steel Blade Oversized
- Acetate Handle



CARDED INSERT & POWER BITS

PC 6751



Insert and power bits are available in a variety of configurations. Bits of 1" length are insert bits; bits 2" and longer are power bits. Note: MBH Tool is used with insert bits only. Not to be used with power bits.

FEATURES:

- Packed 2 Per Display Card
- Maximum Durability
- Precision Fit Prevents Wear
- Sold Per Card

PHILLIPS PT. SIZE 0 & 1

| CAT. NO. | UPC | | TYPE | SCREW SIZE | POINT SIZE/LENGTH | STD | MSTR | WT/STD |
|----------|-------|--|------------|------------|-------------------|-----|------|--------|
| IB0PC | 81836 | | Insert Bit | #4 | #0 x 1" | 1 | 10 | 0.02# |
| IB1PC | 81837 | | Insert Bit | #6 | #1 x 1" | 1 | 10 | 0.02# |
| IB1PLC | 81838 | | Power Bit | #6 | #1 x 2" | 1 | 10 | 0.05# |
| IB1PXC | 81839 | | Power Bit | #6 | #1 x 3" | 1 | 10 | 0.07# |
| IB1P4C | 81840 | | Power Bit | #6 | #1 x 4" | 1 | 10 | 0.09# |
| IB1P6C | 81841 | | Power Bit | #6 | #1 x 6" | 1 | 10 | 0.14# |

PHILLIPS PT. SIZE 2

| CAT. NO. | UPC | | TYPE | SCREW SIZE | POINT SIZE/LENGTH | STD | MSTR | WT/STD |
|----------|-------|--|------------|------------|-------------------|-----|------|--------|
| IB2PC | 81842 | | Insert Bit | #8-10 | #2 x 1" | 1 | 10 | 0.02# |
| IB2PLC | 81843 | | Power Bit | #8-10 | #2 x 2" | 1 | 10 | 0.02# |
| IB2PXC | 81844 | | Power Bit | #8-10 | #2 x 3" | 1 | 10 | 0.07# |
| IB2P4C | 81845 | | Power Bit | #8-10 | #2 x 4" | 1 | 10 | 0.09# |
| IB2P6C | 81846 | | Power Bit | #8-10 | #2 x 6" | 1 | 10 | 0.14# |

PHILLIPS PT. SIZE 3

| CAT. NO. | UPC | | TYPE | SCREW SIZE | POINT SIZE/LENGTH | STD | MSTR | WT/STD |
|----------|-------|--|------------|------------|-------------------|-----|------|--------|
| IB3PC | 81847 | | Insert Bit | #12-14 | #3 x 1" | 1 | 10 | 0.02# |
| IB3PLC | 81848 | | Power Bit | #12-14 | #3 x 2" | 1 | 10 | 0.09# |
| IB3PXC | 81849 | | Power Bit | #12-14 | #3 x 3" | 1 | 10 | 0.07# |
| IB3P4C | 81850 | | Power Bit | #12-14 | #3 x 4" | 1 | 10 | 0.09# |
| IB3P6C | 81851 | | Power Bit | #12-14 | #3 x 6" | 1 | 10 | 0.14# |

SLOTTED PT. SIZE 0 & 1

| CAT. NO. | UPC | | TYPE | SCREW SIZE | POINT SIZE/LENGTH | STD | MSTR | WT/STD |
|----------|-------|--|------------|------------|-------------------|-----|------|--------|
| IB0SC | 81852 | | Insert Bit | #4 | #0 x 1" | 1 | 10 | 0.02# |
| IB1SC | 81853 | | Insert Bit | #6 | #1 x 1" | 1 | 10 | 0.02# |
| IB1SLC | 81854 | | Power Bit | #6 | #1 x 2" | 1 | 10 | 0.05# |
| IB1SXC | 81855 | | Power Bit | #6 | #1 x 3" | 1 | 10 | 0.07# |
| IB1S4C | 81856 | | Power Bit | #6 | #1 x 4" | 1 | 10 | 0.09# |
| IB1S6C | 81857 | | Power Bit | #6 | #1 x 6" | 1 | 10 | 0.14# |

SLOTTED PT. SIZE 2

| CAT. NO. | UPC | | TYPE | SCREW SIZE | POINT SIZE/LENGTH | STD | MSTR | WT/STD |
|----------|-------|--|------------|------------|-------------------|-----|------|--------|
| IB2SC | 81858 | | Insert Bit | #8-10 | #2 x 1" | 1 | 10 | 0.02# |
| IB2SLC | 81859 | | Power Bit | #8-10 | #2 x 2" | 1 | 10 | 0.05# |
| IB2SXC | 81860 | | Power Bit | #8-10 | #2 x 3" | 1 | 10 | 0.07# |
| IB2S4C | 81861 | | Power Bit | #8-10 | #2 x 4" | 1 | 10 | 0.09# |
| IB2S6C | 81862 | | Power Bit | #8-10 | #2 x 6" | 1 | 10 | 0.14# |

SLOTTED PT. SIZE 3

| CAT. NO. | UPC | | TYPE | SCREW SIZE | POINT SIZE/LENGTH | STD | MSTR | WT/STD |
|----------|-------|--|------------|------------|-------------------|-----|------|--------|
| IB3SC | 81863 | | Insert Bit | #12-14 | #3 x 1" | 1 | 10 | 0.02# |
| IB3SLC | 81864 | | Power Bit | #12-14 | #3 x 2" | 1 | 10 | 0.05# |
| IB3SXC | 81865 | | Power Bit | #12-14 | #3 x 3" | 1 | 10 | 0.07# |
| IB3S4C | 81866 | | Power Bit | #12-14 | #3 x 4" | 1 | 10 | 0.09# |
| IB3S6C | 81867 | | Power Bit | #12-14 | #3 x 6" | 1 | 10 | 0.14# |

SQUARE PT. 0 & 1

| CAT. NO. | UPC | | TYPE | SCREW SIZE | POINT SIZE/LENGTH | STD | MSTR | WT/STD |
|----------|-------|--|------------|------------|-------------------|-----|------|--------|
| IB0C | 81868 | | Insert Bit | #4 | #0 x 1" | 1 | 10 | 0.02# |
| IB1C | 81869 | | Insert Bit | #6 | #1 x 1" | 1 | 10 | 0.02# |
| IB1LC | 81870 | | Power Bit | #6 | #1 x 2" | 1 | 10 | 0.05# |
| IB1XC | 81871 | | Power Bit | #6 | #1 x 3" | 1 | 10 | 0.07# |
| IB14C | 81872 | | Power Bit | #6 | #1 x 4" | 1 | 10 | 0.09# |
| IB16C | 81873 | | Power Bit | #6 | #1 x 6" | 1 | 10 | 0.14# |

SQUARE PT. SIZE 2

| CAT. NO. | UPC | | TYPE | SCREW SIZE | POINT SIZE/LENGTH | STD | MSTR | WT/STD |
|----------|-------|--|------------|------------|-------------------|-----|------|--------|
| IB2C | 81874 | | Insert Bit | #8-10 | #2 x 1" | 1 | 10 | 0.02# |
| IB2LC | 81875 | | Power Bit | #8-10 | #2 x 2" | 1 | 10 | 0.05# |
| IB2XC | 81876 | | Power Bit | #8-10 | #2 x 3" | 1 | 10 | 0.07# |
| IB24C | 81877 | | Power Bit | #8-10 | #2 x 4" | 1 | 10 | 0.09# |
| IB26C | 81878 | | Power Bit | #8-10 | #2 x 6" | 1 | 10 | 0.14# |

SQUARE PT. SIZE 3

| CAT. NO. | UPC | | TYPE | SCREW SIZE | POINT SIZE/LENGTH | STD | MSTR | WT/STD |
|----------|-------|--|------------|------------|-------------------|-----|------|--------|
| IB3C | 81879 | | Insert Bit | #12-14 | #3 x 1" | 1 | 10 | 0.02# |
| IB3LC | 81880 | | Power Bit | #12-14 | #3 x 2" | 1 | 10 | 0.05# |
| IB3XC | 81881 | | Power Bit | #12-14 | #3 x 3" | 1 | 10 | 0.07# |
| IB34C | 81882 | | Power Bit | #12-14 | #3 x 4" | 1 | 10 | 0.09# |
| IB36C | 81883 | | Power Bit | #12-14 | #3 x 6" | 1 | 10 | 0.14# |

COMBO PT. SIZE #2 SQUARE / #2 PHILLIPS

| CAT. NO. | UPC | | TYPE | SCREW SIZE | POINT SIZE/LENGTH | STD | MSTR | WT/STD |
|----------|-------|--|-----------|------------|-------------------|-----|------|--------|
| IB2CLC | 81891 | | Power Bit | #8-10 | #2 x 2" | 1 | 10 | 0.02# |

CARDED BITS & TOOLS

PC 6701, 6700

MAGNETIC HEX TOOLS - CARDED PC 6701

| CAT. NO. | UPC | TYPE | SCREW SIZE | DRIVE LENGTH | STD | MSTRWT/STD |
|----------|-------|-------|------------|----------------|-----|------------|
| MT8C | 81884 | 1/4" | #6-8 | 1/4 x 1-3/4" | 1 | 10 0.07# |
| MT8LC | 81885 | | #6-8 | 1/4 x 2-9/16" | 1 | 10 0.08# |
| MT10C | 81886 | 5/16" | #10-12 | 5/16 x 1-3/4" | 1 | 10 0.07# |
| MT10LC | 81887 | | #10-12 | 5/16 x 2-9/16" | 1 | 10 0.09# |
| MT38C | 81888 | 3/8" | 1/4" | 3/8 x 1-3/4" | 1 | 10 0.08# |
| MT38LC | 81889 | | 1/4" | 3/8 x 2-9/16" | 1 | 10 0.09# |



FEATURES:

- Packed Bulk
- Packed 1 Per Card
- Hardened Core For Extra Strength And Reduced Breakage
- Heat Treated To Resist Breakage And Wear
- Specially Designed To Reduce Stripping

MAGNETIC HEX TOOLS - BULK PC 6700

| CAT. NO. | UPC | TYPE | SCREW SIZE | DRIVE LENGTH | STD | MSTRWT/STD |
|----------|-------|-------|------------|----------------|-----|------------|
| MT8 | 17730 | 1/4" | #6-8 | 1/4 x 1-3/4" | 10 | 100 0.07# |
| MT8L | 17735 | | #6-8 | 1/4 x 2-9/16" | 10 | 100 0.08# |
| MT10 | 17740 | 5/16" | #10-12 | 5/16 x 1-3/4" | 10 | 100 0.07# |
| MT10L | 17745 | | #10-12 | 5/16 x 2-9/16" | 10 | 100 0.09# |
| MT38 | 17760 | 3/8" | 1/4" | 3/8 x 1-3/4" | 10 | 100 0.08# |
| MT38L | 17752 | | 1/4" | 3/8 x 2-9/16" | 10 | 100 0.09# |

MAGNETIC BIT HOLDER

PC 6710, 6711

| CAT. NO. | UPC | TYPE | SCREW SIZE | DRIVE LENGTH | STD | MSTRWT/STD |
|----------|-------|----------------------------|------------|--------------|-----|------------|
| MBHC* | 81890 | Magnetic Bit Holder-Carded | | 1/4 x 3" | 1 | 10 0.11# |
| MBH* | 16948 | Magnetic Bit Holder-Bulk | | 1/4 x 3" | 10 | 100 0.11# |

Note: To be used with insert bits only. Not power bits.



MULTI DRIVE SCREW GUIDE KIT

PC 6712

The Multi Drive Screw Guide Kit contains the most popular screw driving bits for all your fastening jobs. Drive the most difficult lengths of screws with ease using this professionally designed tool.

| CAT. NO. | UPC | CONTENTS | STD | MSTRWT/STD |
|----------|-------|---|-----|------------|
| MDSG | 81912 | 1-Ea Multi Drive Screw Guide 1-Ea Phillips #1, #2, #3 1-Ea Square #1, #2 1-Ea Slotted #6F-#8R, #8R-10F, #10R-12R | 1 | 10 0.50# |



TAMPER PROOF INSERT BITS

PC 6720

HEX PIN

| CAT. NO. | UPC | SCREW SIZE | DESCRIPTION | LENGTH | STD | MSTRWT/STD |
|----------|-------|-------------|---------------|--------|-----|------------|
| 73TR3 | 22733 | #4-5 | 3/32" Hex Pin | 1" | 1 | 5 0.01# |
| 73TR5 | 22735 | #6 | 1/8" Hex Pin | 1" | 1 | 5 0.01# |
| 73TR7 | 22737 | #8,10,12,14 | 5/32" Hex Pin | 1" | 1 | 5 0.01# |
| 73TR8 | 22738 | 5/16 | 3/16" Hex Pin | 1" | 1 | 5 0.01# |
| 73TR9 | 22739 | 3/8 | 7/32" Hex Pin | 1" | 1 | 5 0.01# |

STAR PIN

| CAT. NO. | UPC | SCREW SIZE | DESCRIPTION | LENGTH | STD | MSTRWT/STD |
|----------|-------|------------|--------------|--------|-----|------------|
| 60TR10 | 22610 | #6R | T10 Star Pin | 1" | 1 | 5 0.01# |
| 60TR15 | 22615 | #6F-8R | T15 Star Pin | 1" | 1 | 5 0.01# |
| 60TR20 | 22620 | #8F | T20 Star Pin | 1" | 1 | 5 0.01# |
| 60TR25 | 22625 | 10F-10R | T25 Star Pin | 1" | 1 | 5 0.01# |
| 60TR27 | 22627 | 1/4F 1/4R | T27 Star Pin | 1" | 1 | 5 0.01# |
| 60TR30 | 22630 | 1/4F | T30 Star Pin | 1" | 1 | 5 0.01# |

SPANNER

| CAT. NO. | UPC | SCREW SIZE | DESCRIPTION | LENGTH | STD | MSTRWT/STD |
|----------|-------|------------|-------------|--------|-----|------------|
| 1156 | 31156 | #6 | #6 Spanner | 1" | 1 | 5 0.01# |
| 1158 | 31158 | #8 | #8 Spanner | 1" | 1 | 5 0.01# |
| 11510 | 31150 | #10 | #10 Spanner | 1" | 1 | 5 0.01# |
| 11512 | 31152 | #12 | #12 Spanner | 1" | 1 | 5 0.01# |
| 11514 | 31154 | #14 | #14 Spanner | 1" | 1 | 5 0.01# |

INSERT & POWER BITS

PC 6650



FEATURES:

- Maximum Durability
- Precision Fit
- Prevents Wear
- Packed Bulk

Insert and power bits are available in a variety of configurations. Bits of 1" length are insert bits; bits 2" and longer are power bits. Note: MBH Tool is used with insert bits only. Not to be used with power bits.

PHILLIPS PT. SIZE 0 & 1

| CAT. NO. | UPC | TYPE | SCREW POINT SIZE/ SIZE | LENGTH | STD | MSTRWT/STD | | |
|----------|-------|---|------------------------|--------|---------|------------|-----|--------|
| IB0P | 60205 |  | Insert Bit | #4 | #0 x 1" | 10 | 100 | 0.100# |
| IB1P | 60222 | | Insert Bit | #6 | #1 x 1" | 10 | 100 | 0.100# |
| IB1PL | 60224 | | Power Bit | #6 | #1 x 2" | 10 | 100 | 0.230# |
| IB1PX | 60346 | | Power Bit | #6 | #1 x 3" | 5 | 50 | 0.170# |
| IB1P4 | 60348 | | Power Bit | #6 | #1 x 4" | 5 | 50 | 0.236# |
| IB1P6 | 60360 | | Power Bit | #6 | #1 x 6" | 5 | 50 | 0.360# |

PHILLIPS PT. SIZE 2

| | | | | | | | | |
|-------|-------|---|------------|-------|---------|----|-----|--------|
| IB2P | 60226 |  | Insert Bit | #8-10 | #2 x 1" | 10 | 100 | 0.100# |
| IB2PL | 60228 | | Power Bit | #8-10 | #2 x 2" | 10 | 100 | 0.230# |
| IB2PX | 60230 | | Power Bit | #8-10 | #2 x 3" | 5 | 50 | 0.170# |
| IB2P4 | 60362 | | Power Bit | #8-10 | #2 x 4" | 5 | 50 | 0.236# |
| IB2P6 | 60364 | | Power Bit | #8-10 | #2 x 6" | 5 | 50 | 0.360# |

PHILLIPS PT. SIZE 3

| | | | | | | | | |
|-------|-------|---|------------|--------|---------|----|-----|--------|
| IB3P | 60232 |  | Insert Bit | #12-14 | #3 x 1" | 10 | 100 | 0.100# |
| IB3PL | 60234 | | Power Bit | #12-14 | #3 x 2" | 5 | 50 | 0.230# |
| IB3PX | 60366 | | Power Bit | #12-14 | #3 x 3" | 5 | 50 | 0.170# |
| IB3P4 | 60368 | | Power Bit | #12-14 | #3 x 4" | 5 | 50 | 0.236# |
| IB3P6 | 60370 | | Power Bit | #12-14 | #3 x 6" | 5 | 50 | 0.360# |

SLOTTED PT. SIZE 0 & 1

| | | | | | | | | |
|-------|-------|--|------------|----|---------|----|-----|--------|
| IB0S | 60212 |  | Insert Bit | #4 | #0 x 1" | 10 | 100 | 0.100# |
| IB1S | 60214 | | Power Bit | #6 | #1 x 1" | 10 | 100 | 0.230# |
| IB1SL | 60216 | | Power Bit | #6 | #1 x 2" | 10 | 100 | 0.170# |
| IB1SX | 60380 | | Power Bit | #6 | #1 x 3" | 5 | 50 | 0.236# |
| IB1S4 | 60382 | | Power Bit | #6 | #1 x 4" | 5 | 50 | 0.360# |
| IB1S6 | 60382 | | Power Bit | #6 | #1 x 6" | 5 | 50 | 0.360# |

SLOTTED PT. SIZE 2

| | | | | | | | | |
|-------|-------|---|------------|-------|---------|----|-----|--------|
| IB2S | 60218 |  | Insert Bit | #8-10 | #2 x 1" | 10 | 100 | 0.100# |
| IB2SL | 60384 | | Power Bit | #8-10 | #2 x 2" | 10 | 100 | 0.230# |
| IB2SX | 60386 | | Power Bit | #8-10 | #2 x 3" | 5 | 50 | 0.170# |
| IB2S4 | 60388 | | Power Bit | #8-10 | #2 x 4" | 5 | 50 | 0.236# |
| IB2S6 | 60390 | | Power Bit | #8-10 | #2 x 6" | 5 | 50 | 0.360# |

SLOTTED PT. SIZE 3

| | | | | | | | | |
|-------|-------|---|------------|--------|---------|----|-----|--------|
| IB3S | 60320 |  | Insert Bit | #12-14 | #3 x 1" | 10 | 100 | 0.100# |
| IB3SL | 60200 | | Insert Bit | #12-14 | #3 x 1" | 10 | 100 | 0.100# |
| IB3SX | 60322 | | Power Bit | #12-14 | #3 x 2" | 5 | 50 | 0.230# |
| IB3S4 | 60324 | | Power Bit | #12-14 | #3 x 3" | 5 | 50 | 0.170# |
| IB3S6 | 60326 | | Power Bit | #12-14 | #3 x 4" | 5 | 50 | 0.236# |

SQUARE PT. 0 & 1

| | | | | | | | | |
|------|-------|---|------------|----|---------|----|-----|--------|
| IB0 | 60320 |  | Insert Bit | #4 | #0 x 1" | 10 | 100 | 0.100# |
| IB1 | 60200 | | Insert Bit | #6 | #1 x 1" | 10 | 100 | 0.100# |
| IB1L | 60322 | | Power Bit | #6 | #1 x 2" | 10 | 100 | 0.230# |
| IB1X | 60324 | | Power Bit | #6 | #1 x 3" | 5 | 50 | 0.170# |
| IB14 | 60326 | | Power Bit | #6 | #1 x 4" | 5 | 50 | 0.236# |
| IB16 | 60328 | | Power Bit | #6 | #1 x 6" | 5 | 50 | 0.360# |

SQUARE PT. SIZE 2

| | | | | | | | | |
|------|-------|---|------------|-------|---------|----|-----|--------|
| IB2 | 16940 |  | Insert Bit | #8-10 | #2 x 1" | 10 | 100 | 0.100# |
| IB2L | 60204 | | Power Bit | #8-10 | #2 x 2" | 10 | 100 | 0.230# |
| IB2X | 60330 | | Power Bit | #8-10 | #2 x 3" | 5 | 50 | 0.170# |
| IB24 | 60332 | | Power Bit | #8-10 | #2 x 4" | 5 | 50 | 0.236# |
| IB26 | 60334 | | Power Bit | #8-10 | #2 x 6" | 5 | 50 | 0.360# |

SQUARE PT. SIZE 3

| | | | | | | | | |
|------|-------|---|------------|--------|---------|----|-----|--------|
| IB3 | 16943 |  | Insert Bit | #12-14 | #3 x 1" | 10 | 100 | 0.100# |
| IB3L | 60336 | | Power Bit | #12-14 | #3 x 2" | 10 | 100 | 0.230# |
| IB3X | 60338 | | Power Bit | #12-14 | #3 x 3" | 5 | 50 | 0.170# |
| IB34 | 60340 | | Power Bit | #12-14 | #3 x 4" | 5 | 50 | 0.236# |
| IB36 | 60342 | | Power Bit | #12-14 | #3 x 6" | 5 | 50 | 0.360# |

TELESCOPING POLE TOOLS

PC 4607

Provides a safe way to reach areas that previously were dangerous or inaccessible to ladders, scaffolding, and scissor lifts - including vaulted ceilings, over stairwells, and through ceiling grid. The Dottie Electrical Telescoping Pole Tool is the electrician's pole tool. The interchangeable heads make it the most efficient tool of its kind. Use it to install ceiling wire (Page B10 with Hanger Screws Page A31), jack chain (Page A32), threaded rod (Page A25 with Rod Hangers Pages B8-10), and overhead screw or nut installations. Power the pole with any 3/8" or 1/2" drill. Dottie's Pole tool comes with all three interchangeable head - Wire, Double Sided Socket and 1/4" Hex Drive. The Double Sided Socket will accommodate both Dottie's Rod Hanging System Anchors (Pages B8-10) and competitive rod hanging anchors.

| CAT. NO. | UPC | DESCRIPTION | STD | MSTRWT/STD |
|----------|-------|-----------------------------------|-----|------------|
| DLM12 | 82280 | Triple 4ft. Telescoping Pole Tool | 1 | 5.90# |
| DLM18 | 82281 | Triple 6ft. Telescoping Pole Tool | 1 | 7.80# |

ACCESSORIES

| | | | | |
|--------|-------|------------------------------|---|-------|
| DLMWT | 83166 | Wire & Chain Plug in Head | 1 | 1.25# |
| DLMRHD | 83168 | Double Sided Rod Hanger Head | 1 | 1.25# |
| DLMHD | 83167 | 1/4" Bit & Power Bit Head | 1 | 1.25# |

1 TOOL 3 USES SAFER.FASTER.EASIER.

HANG JACK CHAIN & CEILING WIRE



WIRE & CHAIN
PLUG IN HEAD

DLMWT

(#631 FLAT HANGER SCREW)



(#631TK FLAT
HANGER SCREW)



THREADED ROD HANGING SYSTEM



UNIQUE DOUBLE SIDED
ROD HANGER HEAD

DLMRHD



USE TO INSTALL DOTTIE ROD HANGERS &
COMPETITIVE ROD HANGERS FOR 1/4" AND
3/8" THREADED ROD

USE AS A BIT DRIVER & A NUT DRIVER



1/4" BIT & POWER BIT
HEAD

DLMHD



USE WITH ANY SIZE NUT OR DRIVER



ATTACHES TO VIRTUALLY
ANY 3/8" OR 1/2"
POWER DRILL

TOOLS & SPECIALTY ITEMS



SHOVELS, SLEDGES, PICK & CAULKING GUNS

PROFESSIONAL GRADE SHOVELS - FIBERGLASS

PC 6780



The shovel and grip ends are larger to provide leverage and control while the center tapers to help your hand slide when "slinging" the material away from the hole.

| CAT. NO. | UPC | DESCRIPTION | HANDLE LENGTH | STD | MSTR | WT/STD |
|----------|-------|------------------|----------------|-----|------|--------|
| SHR | 24000 | #2 Round Point | 48" Handle | 1 | 5 | 5.05# |
| SHS | 24005 | #2 Square Point | 48" Handle | 1 | 5 | 5.44# |
| SHD | 24010 | 14" Drain Spade | 48" Handle | 1 | 5 | 4.84# |
| SHDSS | 24025 | 14" Sharpshooter | 27" 'D' Handle | 1 | 5 | 3.77# |
| SHTR4 | 24015 | 4" Trenching | 48" Handle | 1 | 5 | 4.31# |
| SHTR5 | 24020 | 5" Trenching | 48" Handle | 1 | 5 | 5.20# |
| SPH | 24040 | Post Hole Digger | 48" Handle | 1 | 5 | 11.94# |

FEATURES:

- 48" Handle Tensioned Fiberglass
- Minimum Breaking Strength of 261 lbs Per DTH6950-1
- Safe From Electrical Shock
- Does Not Absorb Moisture
- Resists Industrial Chemicals
- Ergonomically Designed Grip
- Standard Or D Handle
- Caution! Always Wear Eye Protection

SLEDGES & PICKS - FIBERGLASS

PC 6780



Composite construction consists of millions of continuous parallel fiberglass strands cured under tension in a thermosetting resin covered by an engineering plastic cladding for strength, safety, durability and comfort. Ergonomically designed grip fits palm of hand for better control, lower effort and strain.

| CAT. NO. | UPC | DESCRIPTION | HANDLE LENGTH | STD | MSTR | WT/STD |
|----------|-------|--------------------|---------------|-----|------|--------|
| SGH2 | 24050 | 2 lb Hand Drilling | 10" Handle | 1 | | 2.44# |
| SGH4 | 24055 | 4 lb Hand Sledge | 10" Handle | 1 | | 5.42# |
| SGH8 | 24060 | 8 lb Sledge | 32" Handle | 1 | | 8.82# |
| SGH10 | 24065 | 10 lb Sledge | 32" Handle | 1 | | 11.00# |
| SGH12 | 24080 | 12 lb Sledge | 32" Handle | 1 | | 13.55# |
| SGP5 | 24090 | 5 lb Pick | 32" Handle | 1 | | 8.32# |

FEATURES:

- Super Grip Fiberglass Handle
- Safe From Electrical Shock
- Does Not Absorb Moisture
- Resists Industrial Chemicals
- Caution! Always Wear Eye Protection

CAULKING GUNS

PC 6600



For use with all types of caulks, sealants and adhesives.

FEATURES:

- Double Friction Rod
- Long Trigger Leverage
- Thumb Pressure Release
- Standard Cartridge Size

| CAT. NO. | UPC | DESCRIPTION | STD | MSTR | WT/STD |
|----------|-------|-----------------------|-----|------|--------|
| CGS10P | 84443 | Caulking Gun-Skeleton | 1 | 24 | 1.100# |
| CG10 | 40770 | Caulking Gun | 1 | 24 | 1.100# |

TOOLS & SPECIALTY ITEMS

WIRE DISPENSERS, DOLLIES & HAND TOTES

PC 6725

Our selection of wire rope dispensers, dollies, and hand totes cover most contractor needs, whether feeding wire from eight or twelve small spools on a hand tote, or cable from two 2,500 foot reels on a dolly. Our portable cable dispenser for Romex and BX is a time saver - it opens and mounts conveniently on a nearby 2 x 4 and folds for easy storage. General duty dollies are available for the economy minded. Fused powder coated yellow for durability & high visibility.

| CAT. NO. | UPC | DESCRIPTION | STD | MSTR | WT/STD |
|----------|-------|--|-----|------|--------|
| DD104E | 24179 | General Duty Dolly Supplied w/ five 15-1/2" adjustable/removable bars to accommodate Various sizes of wire spools. Large 10" semi-hard rubber tires for smooth handling. Will accommodate 650 lbs. | 1 | | 56.00# |
| DD105E | 24178 | General Duty Dolly Supplied w/ five 15-1/2" adjustable/removable bars to accommodate various sizes of wire spools. supplied with ONE DD205HT. Large 10" semi-hard rubber tires for smooth handling. Will accommodate 650 lbs. | 1 | | 61.00# |
| DD106A | 24177 | General Duty Dolly Supplied w/ eight 18-1/2" removable bars to accommodate various sizes of wire spools. Hinge allows unit to fold flat when transporting wire. Large 10" semi-hard rubber tires for smooth handling. Will accommodate 650 lbs. | 1 | | 54.00# |

HAND TOTES & CABLE DISPENSER

| | | | | | |
|---------|-------|---|---|--|--------|
| DD205HT | 24174 | Hand Tote (holds 8 spools) Constructed of 5/8" & 1" high strength round steel | 1 | | 4.40# |
| DD206HT | 24181 | Hand Tote (holds 12 spools) Constructed of 5/8" & 1" high strength round steel | 1 | | 12.00# |
| DD210R | 24180 | Portable Cable Dispenser Mounts on a 2 x 4" stud and supports 45 pounds. | 1 | | 13.75# |



DD104E



DD105E



DD106A



DD205HT



DD206HT



DD210R

GROUND ROD DRIVER

PC 6550

Install ground rod from ground level. Sliding action drives rod without need of hammer. Driver will not deform end of rod. Heavy duty construction provides maximum driving forces, while soft rubber ergonomic grip provides user comfort. Integral insert prevents driver from slipping off ground rod near ground level. Convenient retaining collar holds insert in tool when not in use. Can be used on all types of ground rods: copper bonded, galvanized, stainless steel, etc.

| CAT. NO. | UPC | DESCRIPTION | STD | MSTR | WT/STD |
|----------|-------|---|-----|------|--------|
| GRD58 | 24101 | 5' Driver with insert for 5/8" Ground Rod | 1 | | 22.34# |
| GRD34 | 24102 | 5' Driver with insert for 3/4" Ground Rod | 1 | | 22.13# |

INSERT ONLY

| | | | | | |
|--------|-------|---------------------------------|---|--|-------|
| GRDI58 | 24103 | Insert only for 5/8" Ground Rod | 1 | | 5.73# |
| GRDI34 | 24104 | Insert only for 3/4" Ground Rod | 1 | | 5.63# |

FEATURES:

- No Need For Ladders Or Sledge Hammers!
- Heavy Duty Construction
- Completely Self Contained & Easy To Store
- Caution! Always Wear Eye Protection





WORK GLOVES & LATEX GLOVES

WORK GLOVES

PC 6773

Take a quick look at our line of traditional work gloves and you'll see why we've got you covered. We have all the top selling styles and materials representing both the "industry standards" and the "up-and-comers." Whether you're looking for Safety Cuffs, Drivers, Cotton Chore, String Knits, or Latex Dips, we've got 'em. We've built a lot of value into our line so you can be assured of competitive pricing and great quality throughout.

| CAT. NO. | UPC | SIZE | DESCRIPTION | STD | MSTR | WT/STD |
|----------|--------------|-------------------|--|-----|------|--------|
| 2054M | 084298205439 | Medium | Economy Split Cowhide Driver | 1 | 12 | 0.32# |
| 2054L | 084298205446 | Large | Economy Split Cowhide Driver | 1 | 12 | 0.34# |
| 2054X | 084298205453 | Extra Large | Economy Split Cowhide Driver | 1 | 12 | 0.35# |
| 2058M | 084298205866 | Medium | Top Grain Cowhide Driver | 1 | 12 | 0.24# |
| 2058L | 084298205842 | Large | Top Grain Cowhide Driver | 1 | 12 | 0.25# |
| 2058X | 084298205859 | Extra Large | Top Grain Cowhide Driver | 1 | 12 | 0.26# |
| 2063M | 084298206337 | Medium | Top Grain Deerskin Driver | 1 | 12 | 0.25# |
| 2063L | 084298206344 | Large | Top Grain Deerskin Driver | 1 | 12 | 0.26# |
| 2063X | 084298206351 | Extra Large | Top Grain Deerskin Driver | 1 | 12 | 0.33# |
| 2065M | 084298206535 | Medium | Top Grain Cowhide Driver | 1 | 12 | 0.26# |
| 2065L | 084298206542 | Large | Top Grain Cowhide Driver | 1 | 12 | 0.27# |
| 2065X | 084298206559 | Extra Large | Top Grain Cowhide Driver | 1 | 12 | 0.28# |
| 2069M | 084298206931 | Medium | Top Grain Pigskin Driver | 1 | 12 | 0.20# |
| 2069L | 084298206948 | Large | Top Grain Pigskin Driver | 1 | 12 | 0.22# |
| 2069X | 084298206955 | Extra Large | Top Grain Pigskin Driver | 1 | 12 | 0.23# |
| 2040M | 084298204036 | Medium | Split Cowhide Safety Cuff | 1 | 12 | 0.48# |
| 2040L | 084298204005 | Large | Split Cowhide Safety Cuff | 1 | 12 | 0.48# |
| 2040X | 084298204043 | Extra Large | Split Cowhide Safety Cuff | 1 | 12 | 0.48# |
| 2056M | 084298205637 | Medium | Split Cowhide Winter Gloves | 1 | 12 | 0.55# |
| 2056L | 084298205606 | Large | Split Cowhide Winter Gloves | 1 | 12 | 0.58# |
| 2056X | 084298205651 | Extra Large | Split Cowhide Winter Gloves | 1 | 12 | 0.61# |
| 2029M | 084298202933 | Medium | String Knit Gloves with Blue Dip | 1 | 12 | 0.12# |
| 2029L | 084298202940 | Large | String Knit Gloves with Blue Dip | 1 | 12 | 0.12# |
| 2029X | 084298202957 | Extra Large | String Knit Gloves with Blue Dip | 1 | 12 | 0.13# |
| 2030M | 084298203093 | Medium | Latex Gripper Gloves | 1 | 12 | 0.17# |
| 2030L | 084298203077 | Large | Latex Gripper Gloves | 1 | 12 | 0.18# |
| 2030X | 084298203053 | Extra Large | Latex Gripper Gloves | 1 | 12 | 0.20# |
| P2030M | 084298203038 | Medium | Latex Gripper Gloves - (3 pair/pack) | 1 | 12 | 0.65# |
| P2030L | 084298203084 | Large | Latex Gripper Gloves - (3 pair/pack) | 1 | 12 | 0.68# |
| P2030X | 084298203052 | Extra Large | Latex Gripper Gloves - (3 pair/pack) | 1 | 12 | 0.70# |
| 2038M | 084298203831 | Medium | T-Touch™ Technical Safety Glove | 1 | 12 | 0.11# |
| 2038L | 084298203848 | Large | T-Touch™ Technical Safety Glove | 1 | 12 | 0.12# |
| 2038X | 084298203855 | Extra Large | T-Touch™ Technical Safety Glove | 1 | 12 | 0.13# |
| 2004 | 084298200403 | One Size Fits All | Cotton Canvas Gloves with Knit Wrist | 1 | 12 | 0.15# |
| 2006 | 084298200601 | One Size Fits All | Cotton Canvas Gloves with Gripper Dots | 1 | 12 | 0.17# |
| 2008 | 084298200809 | One Size Fits All | Brown Jersey Gloves | 1 | 12 | 0.13# |
| 2010 | 084298201004 | One Size Fits All | Economy Cotton/Poly String Knit | 1 | 12 | 0.11# |
| 2013 | 084298201301 | One Size Fits All | Fleece Lined Cotton Jersey Gloves | 1 | 12 | 1.24# |
| 2322L | 084298232244 | Large | Nitrile Disposable Non-Powdered - (100 ea./box) | 1 | 12 | 1.75# |
| 2322X | 084298232251 | Extra Large | Nitrile Disposable Non-Powdered - (100 ea./box) | 1 | 12 | 1.75# |
| 2323L | 084298232343 | Large | 5 Mil. Nitrile Dispos. Non-Powdered - (50 ea./box) | 1 | 12 | 1.10# |
| 2325L | 084298232541 | One Size Fits All | Tuffster™ Nitrile Disposable Gloves (50 ea./box) | 1 | 12 | 1.35# |
| LG100 | 781002598602 | One Size Fits All | 100 Latex Gloves in Jar | 1 | 12 | 2.35# |



TOOLS & SPECIALTY ITEMS

E30

CELEBRATING 50 YEARS

FLEXGRIP HIGH DEXTERITY GLOVES

PC 6774

CLC Flex Grip gloves deliver an unmatched blend of style, function and quality. They're form-fitted for added dexterity and reduced fatigue. We use quality materials and time-tested construction methods to make this dynamically stiled line the best-of-the-best in high dexterity gloves. Our Syntrex™ synthetic palm material provides increased abrasion resistance for better wear. And our Stretch-Fit™ thumb feature and spandex back combine for a better fitting glove with greater flexibility.

FEATURES:

- Ergo Cut Technology
- Neoprene-Spandex Laminated Back
- 100% Washable
- Charmude™ Synthetic Leather Palm For Ventilation
- Double-Stitched Scholler Keprotect™ Secondary Palm Layer For Positive Grip And Shock Absorption
- Cut Level 5 Gloves, See Page E32

| CAT. NO. | UPC | SIZE | DESCRIPTION | STD | MSTR | WT/STD |
|----------|--------------|----------|-------------------|-----|------|--------|
| 123M | 084298812330 | Medium | WorkRight™ OC | 1 | 12 | 0.17# |
| 123L | 084298812361 | Large | WorkRight™ OC | 1 | 12 | 0.17# |
| 123X | 084298812378 | X-Large | WorkRight™ OC | 1 | 12 | 0.18# |
| L123L | 084298812346 | Large | WorkRight Winter™ | 1 | 12 | 0.21# |
| L123X | 084298812353 | X-Large | WorkRight Winter™ | 1 | 12 | 0.22# |
| 124M | 084298812439 | Medium | WorkRight™ | 1 | 12 | 0.19# |
| 124L | 084298812446 | Large | WorkRight™ | 1 | 12 | 0.19# |
| 124X | 084298812453 | X-Large | WorkRight™ | 1 | 12 | 0.19# |
| 130M | 084298813030 | Medium | Subcontractor™ | 1 | 12 | 0.22# |
| 130L | 084298813047 | Large | Subcontractor™ | 1 | 12 | 0.23# |
| 130X | 084298813054 | X-Large | Subcontractor™ | 1 | 12 | 0.24# |
| 130XX | 084298813061 | XX-Large | Subcontractor™ | 1 | 12 | 0.25# |
| 135M | 084298813335 | Medium | Boxer™ | 1 | 12 | 0.22# |
| 135L | 084298813342 | Large | Boxer™ | 1 | 12 | 0.23# |
| 135X | 084298813359 | X-Large | Boxer™ | 1 | 12 | 0.24# |
| 140M | 084298814532 | Medium | Pro Framer XC™ | 1 | 12 | 0.25# |
| 140L | 084298814549 | Large | Pro Framer XC™ | 1 | 12 | 0.26# |
| 140X | 084298814556 | X-Large | Pro Framer XC™ | 1 | 12 | 0.27# |



HYBRID GLOVES

PC 6774

The durability of traditional leather work gloves combined with the advanced materials of high performance dexterity gloves.

| CAT. NO. | UPC | SIZE | DESCRIPTION | STD | MSTR | WT/STD |
|----------|--------------|---------|-------------------------------------|-----|------|--------|
| 260M | 084298826030 | Medium | Suede Palm w/ Knit Wrist | 1 | 12 | 0.36# |
| 260L | 084298826047 | Large | Suede Palm w/ Knit Wrist | 1 | 12 | 0.36# |
| 260X | 084298826054 | X-Large | Suede Palm w/ Knit Wrist | 1 | 12 | 0.36# |
| 270M | 084298827037 | Medium | Top Grain Goatskin w/ Safety Cuff | 1 | 12 | 0.49# |
| 270L | 084298827044 | Large | Top Grain Goatskin w/ Safety Cuff | 1 | 12 | 0.49# |
| 270X | 084298827051 | X-Large | Top Grain Goatskin w/ Safety Cuff | 1 | 12 | 0.49# |
| 285M | 084298828539 | Medium | Top Grain Deerskin w/ Wrist Closure | 1 | 12 | 0.38# |
| 285L | 084298828546 | Large | Top Grain Deerskin w/ Wrist Closure | 1 | 12 | 0.38# |
| 285X | 084298828553 | X-Large | Top Grain Deerskin w/ Wrist Closure | 1 | 12 | 0.38# |

FEATURES:

Goatskin With Safety Cuff:

- Safety Cotton Cuff
- Premium Suede Palm
- Keystone Thumb With Gusset Stitching
- Neoprene-padded Knuckle
- Breathable Spandex Back
- Stretchable Lycra Side Panels In Glove Fingers

Deerskin With Neoprene Cuff:

- Neoprene Cuff
- Top Grain Deerskin Leather
- Keystone Thumb With Gusset Stitching
- Breathable Spandex Back
- Reinforced Leather Patches
- Stretchable Lycra Side Panels In Glove Fingers

Suede Palm with Knit Wrist Work Gloves:

- Premium quality suede leather palm work gloves.
- Breathable spandex back.
- Keystone thumb with gusset stitching
- Stretchable lycra side panels
- Knit wrist for a snug fit



TOOL BELT

PC 6770



| CAT. NO. | UPC | DESCRIPTION | STD | MSTR | WT/STD |
|----------|--------------|---|-----|------|--------|
| 5609 | 084298560903 | 20 Pocket - 3 Piece Ballistic Poly Electrical Combo Fits waist sizes 29" - 46" (For larger belt, #5625XL, page E35) | 1 | 3 | 3.00# |

FEATURES:

- Easy carry handle design provides simple adjustments, easy carrying and storage of apron without spilling contents
- Double layer of rugged, light-weight ballistic fabric.
- Metal clip holds all measuring tape sizes
- Metal tape chain and tool snap.
- Pocket to hold cordless drill.
- 3" Wide padded belt for comfort with double tongue steel roller buckle.
- Snap-in hammer holder.
- Fits waist sizes 29" - 46".

TOOL POUCHES

PC 6770

We've got you covered with our offering of heavy-duty fabric, tool pouches in multiple configurations to satisfy the needs of just about any electrician, maintenance technician, drywaller, or all-around handyman. Pockets and sleeves are right-size designed to fit the tools you use most. So keep the tools of your trade right at hand, organized, and ready to go. Our power distributor features a surge protector that distributes power to 4 plug outlets for convenient charging and connecting.

| CAT. NO. | UPC | DESCRIPTION | STD | MSTR | WT/STD |
|----------|--------------|--|-----|------|--------|
| 1504 | 084298015045 | 9 Pocket Poly Multi-Purpose "Cary-All" Tool Pouch | 1 | 3 | 0.58# |
| 1509 | 084298015090 | 21 Pocket Zippered Professional Electrician's Tool Pouch | 1 | 3 | 2.67# |
| 1523 | 084298015236 | Small Poly Ziptop™ Utility Pouch | 1 | 3 | 0.57# |
| 1524 | 084298015243 | Medium Poly Ziptop™ Utility Pouch | 1 | 3 | 0.92# |
| 5505 | 084298550508 | 12 Pocket Ballistic Poly Professional Electrician's Tool Pouch | 1 | 3 | 0.92# |
| 5508 | 084298550805 | 20 Pocket Ballistic Poly Professional Electrician's Tool Pouch | 1 | 3 | 1.92# |



1504



1509



1523



1524



5505



5508

CUT LEVEL 5 GLOVES

PC 6773

The Cut Level 5 Glove is an engineered knit glove for exceptional cut and impact protection. The combination of HDPE, Fiberglass, Nylon, Sandy Nitrile coating, and TPR pads offers the next level of ultimate hand safety and durability.

| CAT. NO. | UPC | SIZE | DESCRIPTION | STD | MSTR | WT/STD |
|----------|--------------|---------|---|-----|------|--------|
| 2105M | 084298210532 | Medium | Cut Resistant Polyurethane Dip Gloves | 1 | 12 | 0.20# |
| 2105L | 084298210549 | Large | Cut Resistant Polyurethane Dip Gloves | 1 | 12 | 0.20# |
| 2105X | 084298210556 | X-Large | Cut Resistant Polyurethane Dip Gloves | 1 | 12 | 0.20# |
| 2115M | 084298211539 | Medium | Cut and Impact Resistant Nitrile Dip Gloves | 1 | 12 | 0.45# |
| 2115L | 084298211546 | Large | Cut and Impact Resistant Nitrile Dip Gloves | 1 | 12 | 0.45# |
| 2115X | 084298211553 | X-Large | Cut and Impact Resistant Nitrile Dip Gloves | 1 | 12 | 0.45# |



2105



2115

FEATURES:

- Polyurethane coating on palm provides excellent abrasion and puncture resistance.
- HDPE engineered knit fiber glove shell provides CUT LEVEL 5 protection with high dexterity.
- EN388 4544, highest CE rating in Abrasion, Cut, Tear and Puncture resistance.

TOOL HOLDERS, ORGANIZERS & ACCESSORIES

PC 6770

| CAT. NO. | UPC | DESCRIPTION | STD | MSTR | WT/STD |
|----------|--------------|--|-----|------|--------|
| 1100 | 084298011009 | 3 Poly Multi-Purpose, Clip-On, Zippered Bags | 1 | 3 | 0.29# |
| 1104 | 084298011047 | 4 Pocket Poly Multi-Purpose Tool Holder | 1 | 3 | 0.19# |
| 5021 | 084298050213 | Poly Impact Driver Holster | 1 | 3 | 0.16# |
| 5023 | 084298050237 | Deluxe Cordless Poly Drill Holster | 1 | 3 | 0.58# |
| 5124 | 084298051241 | Cell Phone Holder | 1 | 3 | 0.17# |
| 5127 | 084298051272 | Large Cell Phone Holster | 1 | 3 | 0.21# |

FEATURES:

- Ballistic Nylon Bindings And Grip Strip™ Hook And Loop Fastener System Keeps Pouches In Place
- Double Layer Lightweight Nylon Will Not Crack, Harden Or Mildew
- Nylon Stitching & Double Steel Rivets Reinforce Major Stress Points
- All Parts Are Removable & Interchangeable



1100



1104



5021



5023



5124



5127

TECH GEAR™ BAGS *Innovative!* *Built-In Stereo Speaker System*



PC 6770

Introducing our Tech Gear™ line. We've added another level of innovation to softside tool carriers by integrating **LED Lighting**, and **Stereo Speaker** sound for your digital music player. Our LED light system helps you see into your bag or finish a project when natural light is scarce. And our audio bag lets you enjoy your music without the isolation of headphones, or the added hassle of hauling around a separate speaker device.

| CAT. NO. | UPC | DESCRIPTION | STD | MSTR | WT/STD |
|----------|--------------|---|-----|------|--------|
| A233 | 084298132339 | 39 Pocket - Tech Gear™ w/Stereo Speaker 18" MegaMouth™ Tool Bag | 1 | 3 | 5.50# |
| L230 | 084298122309 | 29 Pocket - Tech Gear™ w/Built in Light 14" BigMouth™ Tool Bag | 1 | 3 | 3.60# |
| L232 | 084298122323 | 45 Pocket - Tech Gear™ w/Built in Light 18" BigMouth™ Tool Bag | 1 | 3 | 3.14# |
| L234 | 084298122347 | 22 Pocket - Tech Gear™ w/LED Light Handle 15" Open Top Tool Carrier | 1 | 3 | 4.40# |
| L238 | 084298122385 | 47 Pocket - Tech Gear™ w/LED Light Handle 14" Open Top Tool Carrier | 1 | 3 | 5.30# |
| L245 | 084298122453 | 56 Pocket - Tech Gear™ w/LED Light Handle 18" Dual Compartment Tool Carrier | 1 | 3 | 8.15# |
| L258 | 084298122583 | 17 Pocket - Light Handle 17" Roller Bag | 1 | 3 | 9.35# |
| P235 | 084298122353 | 18" Power Distribution Tool Bag | 1 | 3 | 4.65# |



A233



L230



L232



L234



L238



L238



L245



L258



SOFTSIDE TOOL CARRIERS

PC 6770

| CAT. NO. | UPC | DESCRIPTION | STD | MSTR | WT/STD |
|----------|--------------|--|-----|------|--------|
| 1132 | 084298011320 | 75 Pocket - Tool Backpack 7" x 5" Multi-compartment plastic tray included. 13"W x 17-1/2"H x 9"D | 1 | 3 | 4.83# |
| 1134 | 084298011344 | 48 Pocket - Tool Backpack 13-1/4"W x 16"H x 6"D | 1 | 3 | 5.00# |
| 1137 | 084298011375 | 14 Pocket - Traytote™ Bag 12"L x 8"W x 12"H | 1 | 3 | 3.83# |
| 1139 | 084298011399 | 12 Pocket - Large Traytote™ Bag 15"L x 19"W x 12"H | 1 | 3 | 3.50# |
| 1148 | 084298011481 | 22 Pocket - Drawstring Bucket Bag 10" Diameter x 7" High | 1 | 3 | 1.00# |
| 1165 | 084298011658 | 22 Pocket - 16" BigMouth™ Bag 16"L x 8-1/2"W x 10"H | 1 | 3 | 3.08# |
| 1526 | 084298015267 | 23 Pocket - Electrical & Maintenance Tool Carrier; 8"L x 8"W x 17"H | 1 | 3 | 2.75# |
| 1528 | 084298015281 | 23 Pocket - Large Electrical & Maintenance Tool Carrier; 11"L x 10"W x 19"H | 1 | 3 | 5.50# |
| 1529 | 084298015304 | 16 Pocket - 16" Center Tray Tool Bag 16"L x 9"W x 9"H | 1 | 3 | 2.50# |
| 1530 | 084298015304 | 43 Pocket - Electrical & Maintenance Tool Carrier; 23"L x 12"W x 15"H | 1 | 3 | 3.20# |
| 1534 | 084298015342 | 23 Pocket - 16" Tote Bag with Top-Side Plastic Tray; 16"L x 12"W x 11"H | 1 | 3 | 4.00# |
| 1535 | 084298015359 | 37 Pocket - 18" Tote Bag with Top-Side Plastic tray; 18"L x 11"W x 11"H | 1 | 3 | 5.17# |
| 1537 | 084298015371 | 33 Pocket - 13" Multi-Compartment Tool Carrier; 13"L x 7"W x 13"H | 1 | 3 | 4.00# |
| 1570 | 084298015700 | 20 Pocket - 12" Soft-sided Tool Box 12"L x 8-1/2"W x 14"H | 1 | 3 | 4.67# |
| 1578 | 084298015786 | 21 Pocket - 14" Open Top Soft-sided Tool Box 14"L x 11"W x 11"H | 1 | 3 | 5.50# |
| 1579 | 084298015793 | 27 Pocket - 20" Open Top Soft-sided Tool Box 20"L x 11"W x 11"H | 1 | 3 | 7.00# |



1132



1134



1137



1139



1148



1165



1526



1528



1529



1530



1534



1535



1537



1570



1578



1579

TOOLS & SPECIALTY ITEMS

KNEEPADS, BELTS & SUSPENDERS

PC 6770

KNEEPADS & ACCESSORIES

| CAT. NO. | UPC | DESCRIPTION | STD | MSTR | WT/STD |
|----------|--------------|--|-----|------|--------|
| 302CLC | 084298003028 | Medium Industrial Kneeling Mat (14" x 21") | 1 | 3 | 2.08# |
| 303CLC | 084298003035 | Large Industrial Kneeling Mat (28" x 16") | 1 | 3 | 2.83# |
| 345CLC | 084298003455 | Professional Kneepads | 1 | 3 | 1.93# |
| 361CLC | 084298003615 | Ultraflex Non-Skid Kneepads | 1 | 3 | 1.60# |

BELTS & SUSPENDERS

| | | | | | |
|-------|--------------|--|---|---|-------|
| 5121 | 084298512100 | Padded Work Suspenders | 1 | 3 | 0.65# |
| 5122 | 084298512209 | Padded Construction Suspender | 1 | 3 | 0.65# |
| 5625 | 084298562518 | 5" Wide Padded Comfort Belt (29"-46") | 1 | 3 | 0.95# |
| 5625X | 084298562532 | 5" Wide Padded Comfort Belt - XL (47"-56") | 1 | 3 | 0.95# |



302CLC



361CLC



345CLC



5625



5121

WEB STRAPS (TIE DOWN)

PC 6775

| CAT. NO. | UPC | DESCRIPTION | COLOR | STD | MSTR | WT/STD |
|----------|-------|-------------------------------|----------|-----|------|--------|
| WS00 | - | Counter Merchandiser w/Straps | Assorted | 1 | | 6.80# |
| WS02 | 24160 | 2' Nylon Tie Down w/Buckle | Red | 12 | 144 | 2.05# |
| WS04 | 24161 | 4' Nylon Tie Down w/Buckle | Yellow | 12 | 144 | 2.45# |
| WS06 | 24162 | 6' Nylon Tie Down w/Buckle | Green | 12 | 144 | 2.90# |
| WS08 | 24163 | 8' Nylon Tie Down w/Buckle | Purple | 12 | 144 | 3.35# |
| WS10 | 24164 | 10' Nylon Tie Down w/Buckle | Blue | 12 | 144 | 3.75# |
| WS12 | 24165 | 12' Nylon Tie Down w/Buckle | Black | 12 | 144 | 4.05# |

STRAP-IT 2 PC HANG-UP DISPLAY PACK

| | | | | | | |
|-------|-------|-----------------------------|--------|---|----|-------|
| 2WS02 | 58211 | 2' Nylon Tie Down w/Buckle | Red | 1 | 12 | 2.05# |
| 2WS04 | 58212 | 4' Nylon Tie Down w/Buckle | Yellow | 1 | 12 | 2.45# |
| 2WS06 | 58213 | 6' Nylon Tie Down w/Buckle | Green | 1 | 12 | 2.90# |
| 2WS08 | 58214 | 8' Nylon Tie Down w/Buckle | Purple | 1 | 12 | 3.35# |
| 2WS10 | 58215 | 10' Nylon Tie Down w/Buckle | Blue | 1 | 12 | 3.75# |
| 2WS12 | 58216 | 12' Nylon Tie Down w/Buckle | Black | 1 | 12 | 4.05# |

WS00 Contains: 36 Web Straps (6 of Ea. Length)

FEATURES:

- Weatherproof
- 750 lb. Test Webbing
- Strong 1" Heavy Duty Web Construction
- Rustproof, Cam-Action Buckle
- For Securing Contractor, DIY, Landscape Maintenance, Recreational Loads
- Available In 2 Piece Bag Or Counter Merchandiser
- 6 Color Coded Lengths: 2 Ft. To 12 Ft.
- Individual Lengths May Be Re-ordered In 1 Dozen Quantities
- Display Box Comes With Header Card
- Caution! Always Wear Eye Protection

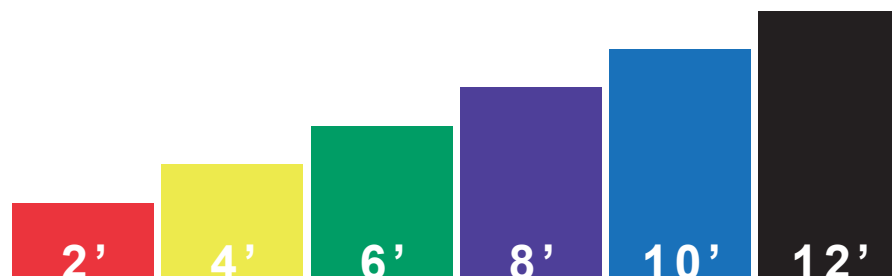

Heavy-use Strap-it tie-down straps are now available in 6 popular color-coded lengths.



TOOLS & SPECIALTY ITEMS



— DOTTIE PIPE SUPPORT —

DOTTIE PIPE SUPPORT

PC 5390

FEATURES:

- **UL Listed**
- **Built-in Channel Technology**
- **High Strength ABS/AES Materials**
- **Dual Channel Configuration**

The Dottie Pipe Support is the first and only **UL Listed** pipe support in the industry. This new and innovative product features Dual Channel technology, and is constructed of high strength polymers ABS and AES for increased structural support and UV resistance. Dual channel technology creates the **MOST VERSATILE PIPE SUPPORT IN THE INDUSTRY**. Strut clamps can be fastened to the large channel while conduit hangers and leveling systems can be fastened to the smaller channel. The Dottie Pipe support comes at a standard length of 4 feet, and is easily cut to required specifications. Lightweight and highly resistant material guarantee an extremely durable product. A single 4" support has a load resistance of 522 Lbs. Dottie's cut to length pipe supports **CUT COSTS, AND INCREASE INSTALLATION FLEXIBILITY.**



| CAT. NO. | UPC | DESCRIPTION | STD | MSTR | WT/STD |
|----------|-------|-------------------------|-----|------|--------|
| DPS | 84932 | Dottie 4ft Pipe Support | 1 | | 3.90# |

| Cut to Length | Load Resistance [lbs] |
|---------------|-----------------------|
| 4" | 522 |
| 5" | 650 |
| 6" | 778 |
| 8" | 1038 |
| 12" | 1560 |
| 18" | 2336 |
| 24" | 3119 |

SUPERIOR LOAD RESISTANCE

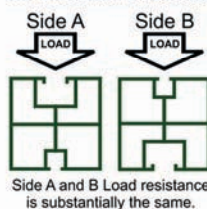

DUAL CHANNEL TECHNOLOGY

CUT TO DESIRED LENGTH



SMALL CHANNEL FOR BOLTS & T-ROD



LARGE CHANNEL FOR STRUT CLAMPS



USE WITH THESE DOTTIE STRUT COMPONENTS



TOOLS & SPECIALTY ITEMS

MODULAR DISPLAY GRAVITY FEED



step-staggered shelves enable easy viewing of products while the grid above the shelves offers additional convenience to hang screw and anchor kits. The entire two foot display rests on heavy duty locking casters for easy mobility.

Since each Invincibox® and Tuff Pack™ features two labels, one on the front and one on the top of the box, locating and restocking product has never been easier. Each product has a matching color-coded shelf label for identification. A clear plastic strip fits in the shelf channel to protect the labels from dirt and grime. Reorder tags are supplied for screw and anchor kits on the grid.

- Available with Five Shelves
- Set without the top one or two Shelves to create more PegHook Space
- Shelves can be set Flat or Angled for Gravity Feed Action
 - Durable Construction
 - Heavy Duty Casters for Mobility
 - Footprint: 25" wide x 28" deep
 - Height is 73" including a 9" Sign



L.H. Dottie's Modular Display is a true chameleon. The versatility built into Dottie's Modular Display allows Distributors to display Dottie Products on peg hooks or on Shelves or a combination of both. The Modular Display can be configured to

LEAN MEAN SELLING MACHINE

merchandise diverse products from Shovels and Spades to Tool Holders and Organizers and virtually any combination of peg hooked or shelved products.

Each Dottie Modular Display System includes Product Dividers for each shelf to insure that every one of Dottie's Patented Invincibox® and Tuff Pack™ Packages is presented properly and the product is easy to locate.

Dottie's Color Coded labeling system also makes locating product easy and ensures easy restocking. Invincibox® and Tuff Pack™ Packages are Tamper Evident and Dual Label, top and front, so it's easy to get it right!

Experience has proven that when it comes to Fasteners, Sales significantly increase when using the Gravity Feed Configuration of Dottie's Modular Systems. The Invincibox® and Tuff Pack™ Displays accommodate over 83 of our popular fasteners and kits, making it a true selling force! The five

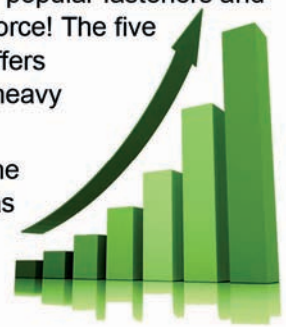

MODULAR DISPLAY

GONDOLA



WALL DISPLAYS



The Dottie Invincibox® system presents itself as a character of versatility. Our patented convertible hang tag gives you a choice of two options when displaying the boxes on your show room floor.



GLOVES & TOOL BAG DISPLAYS

- Sturdy Welded Tube Steel
- Design to Thrive in high traffic areas
- Full color graphic side panels
- Easily configured for multiple display options
- Available in single or double sided configurations



NUMERIC

#

68.....D11
 110.....D2
 123.....E31
 124.....E31
 130.....E31
 135.....E31
 140.....E31
 200.....D14
 216.....A31
 245.....D17
 260.....E31
 270.....E31
 285.....E31
 316.....B16
 339.....B16
 360.....D1
 399.....D17
 400.....D17
 401.....D18
 410.....D2
 420.....D17
 632.....B16
 822.....D1
 832.....B16
 860.....D1
 863.....D18
 890.....D18
 937.....D16
 950.....D17
 1100.....E33
 1104.....E33
 1132.....E34
 1134.....E34
 1137.....E34
 1139.....E34
 1148.....E34
 1165.....E34
 1504.....E32
 1509.....E32
 1523.....E32
 1524.....E32
 1526.....E34
 1528.....E34
 1529.....E34
 1530.....E34
 1534.....E34
 1535.....E34
 1537.....E34
 1570.....E34
 1574.....E34
 1578.....E34
 1579.....E34
 2004.....E30
 2006.....E30
 2008.....E30
 2010.....E30
 2013.....E30
 2029.....E30
 2030.....E30
 2038.....E30
 2040.....E30
 2054.....E30
 2056.....E30
 2058.....E30
 2063.....E30
 2065.....E30
 2069.....E30
 2322.....E30
 2323.....E30
 2325.....E30
 3000.....D7
 5021.....E33
 5023.....E33
 5124.....E33
 5127.....E33
 5505.....E32
 5508.....E32
 5609.....E32
 5625.....E35
 7340.....D16
 8034.....D17
 8060.....D16

8276.....D16
 8377.....D16
 210,220.....D2
 629,630.....A32
 711,714.....B15
 1102,1103.....C20
 5818,5826.....C3
 121,122,123.....B1
 221,222,223.....B1
 0-4.....C11
 1000D.....D10
 1032G,1032GTP.....A5
 1032PS.....B16
 10HX,10PS,10TR.....B17
 115-6-115-14.....A8,E25
 1210D-1216D.....C11
 1230-12120.....D6
 12BLD.....E13
 1381-1395.....D14
 1420,1420PS.....B16
 1425-144000.....D6
 14H,14P.....B12
 1711,1714.....B1
 1809-1824.....E5
 18100-18250.....D6
 18BLD.....E13
 18SD,18SLD.....B5
 1AK,1AKTP,1AK.....B13
 20,21,22,23.....B1
 206F.....E19
 20B,21B,20M,21M.....C20,C21
 2110CL.....D12
 2203P.....D6
 246-283.....D14
 25,26,27,28.....C20,C21
 2516-3516.....C2
 261-279.....D14
 270H-282H.....C20
 29BRZ.....C20
 2AK.....B13
 2WS,2WST.....A14
 2WS02-2WS12.....E35
 300-361.....D15
 302CLC.....E35
 303CLC.....E35
 30H,31H.....C20
 345CLC.....E35
 358C.....E8
 361CLC.....E35
 3625-36360.....D6
 36H,36P.....B12
 3830-38360.....D6
 3AK.....B13
 411,415,41P.....C2
 413-416.....A5
 425C,438C.....E8
 450,450B.....D5
 550C.....E8
 5HN.....A26
 5MB.....A22
 6,8,10,12.....B1
 609-624.....E5
 60TR10-60TR30.....A10,E25
 631,631TK.....A31
 638C,658C,678C.....E8
 6502,6502P.....D6
 6HX,6PS.....B17
 73TR3-73TR9.....A9,E25
 75MT-200MTBLUE.....D2
 8PS,8HX,8TR.....B17

A:

A233.....E33
 AF7.....E5
 APS1,2.....B17
 AT.....B6

B:

BC.....C26
 BK14-BK38.....C9
 BK14M-BK50M.....C9

BLH.....E6
 BT.....D2
 BX,BXG.....C1

C:

C01,CO4.....D9
 C50-C400.....C24
 C50CG-C400CG.....C25
 CA25,100.....C14
 CD.....B12
 CF1,CF2,CF3.....C15
 CG10.....E28
 CH.....A32
 CK.....B17
 CN.....C13
 CP5.....C9
 CS.....C22
 CS100.....E13
 CU.....C3
 CWC.....B10
 CX1.....E2

D:

D10S-130S.....C11
 D131R.....E21
 D151.....E20
 D1-D13.....C2
 DA,DAS.....B6
 DB.....C20
 DB13K.....E3
 DC.....D13
 DD.....E29
 DDFW.....A12
 DDSMS,DDSMST.....A15
 DL.....A32
 DLI25,DLI27.....C20
 DM.....D13
 DPS.....C27,E36
 DRC50,DRC75.....C14
 DRT6C.....E2
 DS1.....E14
 DT100SB.....D4
 DT1032NF.....E2
 DT260,DT260RED.....D2
 DT632NC-DT1420NC.....E2
 DT75S,DT75SB.....D4
 DT100S,DT100SB.....D4
 DT-DTP.....D4,D5
 DTM.....D4
 DU.....D3
 DWP.....D7
 DWSBK,DWSBX.....A13
 DWT.....A13

E:

EB.....A30
 EC.....C23
 EMTB.....C10
 EZ14,EZ38.....A31

F:

F6716,FT6716.....A16
 FA.....E16,E17
 FB,FG357.....E7
 FENW,FENWS.....A29
 FENWT.....A29
 FENWK.....B18
 FF.....C9
 FG.....C28
 FM,FMT.....A1
 FMDD.....A4
 FRP67.....D10
 FRS18.....D10
 FT6716.....A16
 FW,FWBR,FWBZ.....A28
 FWS,FWHA.....A28
 FW2.....B18
 FWS,FWT.....A28

G:

G.....C26
 GB.....E2
 GBKP.....E2
 GBL50-GBL400.....C19
 GC.....C22
 GCTP.....C22
 GN.....C26
 GP.....C22
 GR1208-GR5810.....C19
 GR12-GR58.....C19
 GRD.....C21,E29

H:

HB,HBT.....A31
 HC.....C3
 HD.....B3
 HF340.....D11
 HFB12.....D11
 HLS.....B5
 HN,BR,BZ,S,T.....A26
 HPC.....E11
 HPD18,532.....A9
 HPD78-412.....E11
 HPS.....E11
 HS.....E3
 HUB50L-HUB100L.....C21
 HW.....A7,E22
 HW50-200.....C4
 HW,HW400-410.....C4
 HWSMS,HWSMST.....A16
 HXDOG.....B14
 HPTK1,2,3.....E10

I:

IB.....E24,E26
 IB31PK.....E23
 IT1000.....B12

K:

K6,K7,K14.....B13
 KB.....E16
 KO.....C11
 KPVC.....E14
 KS1.....E14
 KW,KWT.....A17
 KWDD,KWDDT.....A17

L:

L230.....E33
 L232.....E33
 L234.....E33
 L238.....E33
 L245.....E33
 L258.....E33
 LAG.....A24
 LB50CG-LB400CG.....C25
 LB50-LB400.....C24
 LBK.....E14
 LG100.....E19,E30
 LHD.....D11
 LL50CG-LL400CG.....C25
 LL50-LL400.....C24
 LN,LNS.....C13
 LP.....D8
 LR50CG-LR400CG.....C25
 LR50-LR400.....C24
 LS1TP.....E23
 LT.....C16
 LW,BZ,LWS.....A27
 LWK.....B18

M:

M2.....E3
 MA.....B4



INDEX - NUMERIC/ALPHABETIC

| | |
|---------------|-----|
| MB..... | A21 |
| MBBZ,MBS..... | A23 |
| MBH..... | E25 |
| MC150..... | D10 |
| MD..... | E4 |
| MDSG..... | E25 |
| MHD..... | E23 |
| MHW..... | C4 |
| MLE200..... | E19 |
| MSK..... | E19 |
| MT..... | E25 |
| MTW..... | C4 |

N:

| | |
|------------------|-----|
| N36, N85..... | D6 |
| NBP,NBS,NBT..... | E22 |
| NBSL46..... | E22 |
| NLT..... | C16 |
| NMC50..... | C14 |
| NSR..... | C15 |
| NT,NTC..... | C18 |
| NT14L,NT38L..... | B4 |
| NTK..... | B15 |

O:

| | |
|-----------------|---------|
| ON..... | C13 |
| OS,PE,PH,W..... | E15 |
| OW..... | A7, E22 |

P:

| | |
|----------------|-----|
| P235..... | E33 |
| PB..... | C10 |
| PC..... | C3 |
| PE..... | C23 |
| PPF..... | D8 |
| PGE3000..... | D7 |
| PH..... | C5 |
| PHSMSS..... | A14 |
| PL..... | C1 |
| PL25..... | C20 |
| PLX..... | C1 |
| PMS..... | A11 |
| PR16..... | D9 |
| PS..... | C2 |
| PS25,PS38..... | B5 |
| PT..... | C3 |
| PV..... | D9 |
| PVC..... | E13 |

Q:

| | |
|-----------|-----|
| QL12..... | E15 |
| QSPH..... | E15 |

R:

| | |
|------------------------|-----|
| R101..... | E18 |
| R156BR-R956BR..... | E12 |
| R351-R376..... | C10 |
| R414B,R418B,R424B..... | E12 |
| R610B7-R814B7..... | E12 |
| R656BS..... | E12 |
| R800TG..... | E12 |
| RC,RCS..... | A25 |
| RD2,RD3..... | B13 |
| RGZ..... | D12 |
| RJ..... | C8 |
| RKM..... | D9 |
| RMB..... | A11 |
| RMC,RMCT..... | A2 |
| RMDS..... | A3 |
| RN..... | C8 |
| RTP,RHP,RSP..... | E22 |
| RTTP..... | E1 |
| RTV..... | D11 |
| RW..... | C12 |
| RX,RXG..... | C1 |

S:

| | |
|----------------------|----------|
| S..... | A29 |
| SA..... | B6 |
| SB..... | A4 |
| SBS165..... | C9 |
| SC..... | E19 |
| SC-E..... | C6 |
| SCP..... | B10 |
| SC-R..... | C6 |
| SC-U..... | C6 |
| SDF..... | E7 |
| SDS..... | E4 |
| SE..... | A30 |
| SEU..... | C1 |
| SF18..... | D12 |
| SFTO,TW,TY..... | E18 |
| SFTWR..... | E18 |
| SFTYR..... | E18 |
| SGH2-SGH12..... | E28 |
| SGP5..... | E28 |
| SH..... | A30 |
| SHD,SS..... | E28 |
| SHR..... | E28 |
| SHS..... | E28 |
| SHTR4,5..... | E28 |
| SL..... | C17 |
| SLB..... | C23 |
| SLS..... | B5 |
| SNG6..... | E13 |
| SP,SPBK..... | A20 |
| SP34..... | C26 |
| SPD..... | E6 |
| SPN6-SPN10..... | A8, E22 |
| SPT..... | A20 |
| SQDOG..... | B14 |
| SQW,SFP,SAF,SZF..... | C7 |
| SUB..... | C6 |
| SUF,SPB..... | C7 |
| SR..... | C15 |
| SSC..... | B10 |
| SSN,SCN..... | C6 |
| SSW..... | B9 |
| ST..... | B4 |
| ST25,36..... | B4 |
| STK25,36..... | B15 |
| STR10-STR30..... | A10, E23 |
| SV22..... | E18 |

T:

| | |
|------------------------|-----|
| T50CG-T400CG..... | C25 |
| T50-T400..... | C24 |
| T63212OR-T14112OR..... | A7 |
| T63212HB-T142HB..... | A9 |
| T63212SP-T142SP..... | A8 |
| T63212TB-T14112TB..... | A10 |
| TB,TBC,TBDS..... | A6 |
| TB50CG-TB200CG..... | C25 |
| TD..... | D12 |
| TEKDD,TEKDDT..... | A18 |
| TEKF,TEKFT..... | A20 |
| TEKHT,TEKHW..... | A19 |
| TEKW,TEKWT..... | A19 |
| TEKPH..... | A18 |
| TG..... | B13 |
| TK..... | B18 |
| TK250..... | D13 |
| TT75..... | D12 |
| TW..... | C4 |
| TY164..... | C8 |

U:

| | |
|---------------|-----|
| U50-U400..... | A31 |
| UBK..... | E14 |
| UGRCS..... | C19 |
| UNI..... | B10 |
| USB..... | C12 |
| UT..... | D3 |
| UT6..... | E13 |

V:

| | |
|-----------------------|--------|
| V..... | E9 |
| V44..... | E9 |
| VE121..... | E9 |
| VP..... | E8, E9 |
| VP02E,VP08,VP100..... | E9 |
| VPD..... | E6 |
| VTYG..... | C8 |

WXYZ:

| | |
|----------------------|-----|
| W14134-W12512..... | B7 |
| WD6-WD8..... | B2 |
| WDK..... | B14 |
| WDOG..... | B14 |
| WDT..... | B15 |
| WG..... | B5 |
| WPI..... | C14 |
| WR,WRBK,WRT..... | A13 |
| WR6..... | B17 |
| WS00-WS12..... | E35 |
| WS14134-WS12512..... | B7 |
| WTH,WTHGL..... | C18 |
| X50CG-X200CG..... | C25 |
| X5-X24..... | E5 |
| ZA..... | B3 |
| ZAS..... | B3 |

ALPHABETIC

A:

| | |
|--------------------------|----------|
| ADAPTERS..... | E18 |
| ANCHORS..... | |
| Ceiling Wire..... | B10 |
| Concrete..... | B12, B17 |
| Wall Board Toggle..... | B4, B15 |
| Drop In (Steel)..... | B6 |
| Drywall..... | B1-B2 |
| Kits..... | B13-B15 |
| Lag Shields..... | B5 |
| Machine Screw..... | B4 |
| Nylon..... | B1, B4 |
| Rod Spike..... | B5 |
| Plastic..... | B1 |
| Sleeve..... | B6 |
| Harness Toggle..... | B4, B15 |
| Toggle Bolt..... | A6 |
| Multi-Grip..... | B1, B13 |
| Wall Grip..... | B5 |
| Wall Dogs..... | B14 |
| Wall Board..... | B2, B14 |
| Wedge..... | B7 |
| Zamac..... | B3 |
| ANTI-SHORT BUSHINGS..... | C11 |
| AUGERS (Ship)..... | E5 |

B:

| | |
|-----------------------------------|---------|
| BARRICADE TAPE..... | D2 |
| BEAM CLAMPS..... | C6, C9 |
| BELL HANGERS..... | E6 |
| BELTS (Tool)..... | E32-E35 |
| BIT KIT..... | E23 |
| BOLT, Screw & Bolt Extractor..... | E2 |
| BOLTS..... | |
| Lag..... | A24 |
| Machine (HHCS)..... | A21-A24 |
| Stove..... | A4 |
| Toggle..... | A6 |
| U Bolts..... | A31, C6 |
| BOOT COVERS..... | E30 |
| BUSHINGS..... | |
| Anti-Short..... | C11 |
| E.M.T..... | C10 |
| Ground, Insulated..... | C19 |
| K.O. Bushing, Nylon..... | C11 |

| | |
|-----------------------------|-----|
| Plastic..... | C10 |
| Reducing..... | C10 |
| Universal Plastic Stud..... | C12 |
| BX STAPLES..... | C1 |

C:

| | |
|--------------------------|---------|
| CABLE SAW..... | E15 |
| CABLE TIES..... | D4, D5 |
| CABLE TIES..... | |
| MOUNTING BASE..... | D4 |
| CARBIDE DRILLS..... | B12, E4 |
| CARDED BITS & TOOLS..... | E26-27 |
| CATERPILLARS..... | C14 |
| CAULKING GUN..... | E28 |
| CAUTION TAPES..... | D2-D3 |
| CEILING PLATE..... | C9 |
| CHAIN..... | A32 |
| CHANNEL NUTS..... | C6 |
| CLAMPS..... | |
| Beam..... | C9 |
| E.M.T..... | C6 |
| Grounding..... | C20-C21 |
| Ground Rod..... | C19 |
| Rigid Strut..... | C6 |
| Universal Strut..... | C6 |
| COMBO..... | |
| Fittings..... | C15 |
| Machine Screws..... | A2-A4 |
| Sheet Metal Screws..... | A14,A16 |
| CONCRETE..... | |
| Anchor System..... | B12 |
| Masonry Drills..... | B12 |
| CONDUIT..... | |
| Bodies..... | C24-C26 |
| Hangers..... | C5 |
| Line Packages..... | D8 |
| Measuring Tape..... | D7 |
| Nipples..... | C29 |
| Piston..... | D8 |
| CONNECTORS..... | C14-17 |
| COPPER TAPE..... | C3 |
| COUPLINGS..... | |
| Combo..... | C15 |
| No Thread..... | C18 |
| Rod..... | A25 |
| COVERS..... | |
| Aluminum..... | C26 |
| Multi-Guard..... | C28 |
| CRIMP SLEEVES..... | C22 |
| CUTTING OIL..... | D9 |

D:

| | |
|--------------------------|------------------|
| DIAL-A-DRILL..... | E3 |
| DIES..... | E11 |
| DIE SETS..... | E11 |
| DOT (Square) DRIVE..... | |
| Kits..... | B13-B14, B17-B18 |
| Screws..... | A3-4, A21 |
| DOT PACK..... | D5 |
| DOT-SLOT (Screws)..... | A3 |
| DOT-TIES..... | D4-D5 |
| DRILL & TAP KIT..... | E2 |
| DRILLS..... | |
| Bell Hanger..... | E6 |
| Concrete..... | B12 |
| Flex-A-Bit..... | E7 |
| High Speed..... | E3 |
| Masonry..... | B12, E4 |
| Pilot..... | E7 |
| SDS (Rotary Hammer)..... | E4 |
| Sets..... | E3 |
| Ship Auger..... | E5 |
| Spade..... | E6 |
| Speed D Feed..... | E7 |
| Step (Tip)..... | E1 |

INDEX - ALPHABETIC

DRIVE PINSB3
 DRIVE SCREWS.....A31
 DRIVER
 Magnetic Hand.....E23
 DRYWALL SCREWS.....A13
 DUCT SEAL (Prestoseal).....D11
 DUCT TAPED2
 DUST MASK.....E19

E:

EAR PROTECTION.....E18
 ENTRANCE CAPS.....C23
 ENTRANCE ELLS (SLB).....C23
 EXTENSIONS (Augers).....E5
 EYE BOLTS.....A30
 EYEWEAR
 Protective Goggles.....E19
 E-Z TOOLS.....A31

F:

FASTENERS Kits.....B16-B18
 FIRE STOP CAULKING
 Pads & Sticks.....D10
 FIRST AID KITS.....E16-E17
 FISH TAPE LEADER.....E15
 FIXTURE ITEMS.....A31-A32
 FLAT HANGER SCREWS.....A31
 FLEX-A-BIT.....E7
 FLOOR FLANGES.....C9
 FRAMER SCREWS.....A20

G:

GRAB-IT Screw Removal Kit..E2
 GASKETS
 Fiber-Neoprene.....C26
 Wall-Plate.....C14
 GLOVES.....E30-32
 Latex.....E30
 Work.....E30
 Flex Grip.....E31
 Hybrid.....E31
 Cut Resistant.....E32
 GOGGLES.....E14
 GROUND
 Bushings.....C19
 Clamps.....C20-C21
 Clips.....C22
 Hubs.....C21
 Pigtails.....C22
 Rod.....C19
 Rod Driver.....E29, C21
 Screws Ground.....C22

H:

HAMMERS.....E28
 HANDI FOAM.....D11
 Fire Blocking.....D11
 HAND TOTE.....E34-35
 HANGER
 Bolts.....A31
 Conduit.....C5
 Fluorescent Fixture.....A32
 Screws, Flat.....A31
 HARD HAT.....E12
 HAZARD TAPE.....D2-D3
 HEX NUTS.....A28
 HI SPEED DRILLS & SETS.....E3
 HOLE SAWS
 Kits, Arbors.....E8, E9
 HOOK ON, Clips/Straps.....C3
 HOOKS
 S.....A30
 Screw.....A30
 Screw Eye.....A30
 HUBS, GROUND.....C21
 HYDRAULIC PUNCH KITS.....E10
 HYBRID GLOVES.....E31

I:

INSERT BITS.....E24-E25

INSULATED GRD BUSH.....C19
 INSULATED NAIL STRAPS.C2
 INSULATING
 WALL PLATE GASKET.....C14
 INSULPADSD11

K:

K-LATH SCREWS.....A17
 K.O. BUSHINGS, NYLON.....C11
 K.O. SEALS - 3 pc.....C11
 K PVC CUTTERSE16
 KITS, Anchor
 Dot-Drive.....B13, B14
 Hex Head.....B13, B14
 Nylon.....B13-B14
 Harness Toggle.....B15
 Multi-Grip.....B13
 Wall Board.....B14
 Wall Board Toggle.....B15
 KITS, Assortment
 Dot-Drive Screw.....B15
 Hex Nut.....B15
 Hex Washer Screw.....B14
 Machine Screw.....B15
 Self-Drilling.....B16
 Sheet Metal Screw.....B18
 Stove Bolts.....B15
 Two-Way Screw.....B16, B17
 Wood Rockets.....B17
 Wall Dog.....B14
 Wall Plate Screw.....B17
 Washer.....B18
 KNEE PADSE35
 KNIFE, Lock Back Razor.....E14
 KNIFE SHARPENER.....E14

L:

LAG SCREWS.....A24
 LAG SHIELDS.....B5
 LEADER, FISH TAPE.....E15
 LINE PACKAGES.....D8
 LIQUID TITE CONN.....C16-17
 LIQUID TITE CONN. PVC...C16
 LOCKNUTS.....C13
 LUBRICANTS,
 SOLVENTS & CLEANERS
 Tef-Lube™.....D16
 All-4.....D16
 Electronic Component
 Cleaner.....D16
 Off-Line
 Contact Cleaner.....D16
 Nfp Safety Solvent H.D....D16
 Lfp Cleaner /
 Degreaser H.D.....D17
 Dust Air.....D17
 PB Rust-Solv.....D17
 Silicone Lubricant.....D17
 Cutting Oil.....D18
 Zinc Rich Galvanize.....D18
 Epoxy Insulating
 Coating.....D18
 Hornet & Wasp Spray.....D18
 Epoxy Insulating
 Coating.....D18
 Hornet & Wasp Spray.....D18
 Marking Device.....D17
 LUMBER CRAYON.....D13

M:

MASTIC, Roof.....D9
 MEASURING TAPE.....D7
 MEGAPRO DRIVERS.....E20-E21
 MOLLY (Wall-Grip)
 Anchors.....B5
 MULTI-DRIVE SCREW
 GUIDE KIT.....E25
 MULTI-GUARD COVERS.....C28

N:

NAIL STRAPS.....C2
 NIPPLES
 Conduit.....C13
 Offset.....C13
 NMC CONNECTORS.....C14
 NO THREAD CONN.....C18
 NUTS, Hex.....A26
 NYLON ANCHORS.....B1, B4
 NYLON FISH LINED7
 NYLON TOGGLE
 ANCHOR.....B4

O:

OFFSET NIPPLES.....C13

P:

PVC
 Cement.....D9
 Cutters.....E14
 Liquid-Tite Connectors.....C16-17
 Primer.....D9
 Saws.....E13
 PAIRS
 Chain.....A32
 Nail Straps.....C2
 Pull Line - Rope.....D6
 Staples.....C1

PAINT

Construction Marking.....D14
 Invert-a-Cap.....D14
 All-Purpose Marking.....D14
 Marking Devices.....D17
 Rust-Proof.....D15
 PICKS/SHOVELS.....E28
 PIGTAIL, Grounding.....C22
 PIPE SUPPORT.....C27, E36
 PLASTIC BUSHINGS.....C10
 PLASTIC INSULATED
 STAPLES.....C1
 PLATE STRAPS.....C2
 PLATES, Safety.....C2
 PLUMBER'S TAPE.....C3
 POUCHES (Tool).....E32-E34
 POWER BITS.....E24
 PRESTOSEAL (Duct Seal)..D11
 PROTECTIVE EYEWEAR.....E14
 PULL LINE.....D6-D8
 PULL ROPE.....D6
 PULLING ACCESSORIES...D8, E15
 PVC LIQUID-TITE
 CONNECTORS.....C16
 PULLING ELBOWS.....C23
 QUICK LEADER,
 FISH TAPE LEADER.....E15

Q:

CONNECTORS.....C29
 QUICK STICKS.....E15

R:

RAGS.....D12
 RAIN SUIT.....E18
 RATCHET DRIVERS,
 D131R.....E20
 RECIPROBLADES.....E12
 REDUCING
 Bushings.....C10
 Washers.....C12
 ROD
 Clamps, Ground Rod.....C21
 Copper, Ground Rod.....C19
 Couplings.....A25
 Rod Spike.....B5
 Threaded, Steel.....A25
 Threaded, Stainless.....A25
 ROD COUPLERS.....A25
 ROD HANGING
 SYSTEM.....B8-B11

ROMEX CONNECTORS.....C14
 REEL DISPENSERS.....E29
 ROMEX STAPLES.....C1
 ROOF Jack, RN.....C8
 Mastic.....D9
 ROTARY HAMMER DRILL.....E4

S:

SAFETY GOGGLES.....E19
 SAFETY Hats, Vests.....E18
 SAFETY PLATES.....C2
 SAWS
 Holesaw.....E8
 PVC Saw.....E13
 Snaggletooth Pro Saw.....E13
 Utility Saw.....E13
 SCREWDRIVER
 13 in 1 Ratchet.....E20
 15 in 1 STD + TP.....E20
 HVAC 14 in 1.....E21
 Tamperproof.....A7-A10, E23
 SCREWS
 Dot-Drive
 (SquareDrive).....A15
 Dot-Slot (Square/Slot).....A3
 Drive.....A31
 Drywall.....A13
 Flat Hanger.....A31
 Framer.....A20
 Grounding.....A5, C22
 Kits.....B14-B16
 K-Lath.....A17
 Lag.....A24
 Machine.....A1-A11
 Self-Drilling.....A18-A20
 Sharpeez.....A20
 Sheet Metal.....A14-A17
 Stove Bolts.....A4
 Tamper Proof.....A7-A10
 Two-Way (Combo).....A2-A4, A14
 Wall Plate.....A5
 Wood.....A12
 Wood Rockets.....A13, B17
 SCREW REMOVAL KIT.....E2
 SEALANT, RTV.....D11
 SEALING LOCKNUTS.....C13
 SEAL-TITE
 CONNECTORS.....C16-C17
 SERVICE LB'S (SLB).....C23
 SHARPEEZ.....A20
 SHARPENER, Knife.....E14
 SHIP AUGER.....E5
 SHOE COVERS.....E19
 SHOVELS/PICKS.....E28
 PULLING ELBOWS.....D11
 SILICONE SEALANT.....D11
 SLB.....C23
 SLEDGE HAMMER.....E28
 SNAP IN BLANKS.....C11
 SNAGGLETOOTH
 PRO SAW.....E13
 SOCKET ADAPTERS.....E22
 SOUND PADS (Insulpads).....D11
 SPADE DRILL BITS.....E6
 SPEED D FEED DRILLS.....E7
 SPIDER PLATE.....C26
 SQUARE DRIVE
 SCREWS.....A3, A15, A17, A18
 STAPLES.....C1
 STRAIN RELIEF CONN.....C15
 STRAPS
 1 Hole.....C4
 2 Hole.....C4
 Hook On Clips.....C3
 Nail.....C2
 Plate.....C2
 STRETCH FILM.....D12
 STUD DRIVERS.....B3
 SWITCH BOX SUPPORT.....C9

T:

TAMPER RESISTANT
 Bits.....A8-A10, E25
 Screws.....A7-A10



TWO WORDS: **TIMELY** **EFFICIENT**



TAPE
 Barricade.....D2
 Carton Sealing.....D12
 Color Coding.....D1
 Copper.....C3
 Detectable.....D3
 Duct.....D2
 Friction.....D1
 Hazard.....D2, D3
 Masking.....D2
 Pipe Wrap.....D2
 Plumbers, Steel.....C3
 PVC.....D1
 Rubber.....D1
 Underground.....D3

TERMINALS (Wire) KITS.....D13

THREADED ROD

HANGERS.....B8-B10

THREADLESS CONN.....C18

TIE DOWN Straps.....E35

TIP BITS.....E1

TOGGLE ANCHOR
 Nylon.....B4, B15

TOGGLE BOLTS.....A6

TOGGLE, Harness Type.....B4, B15

TOOLS
 Arbors.....E8
 Belts & Holders.....E32-E35
 Caulking Gun.....E28
 Concrete Installation Kit.....B12
 E-Z Hanger Bolt.....A31
 HBT (for 631).....A31
 Hammers.....E28
 Insert & Power Bits.....E22, E24-E26
 Lock Back Knife.....E25
 Magnetic Bit Holders.....E25
 PVC Cutter.....E14
 PVC Saw.....E13
 Rod Hanger Tool.....B11, E27
 Snaggletooth Pro Saw.....E13
 Saw, Utility.....E13
 Screw Drivers.....E20-E21
 Setting Tools ST, AT.....B4, B6
 Step Drill.....E1
 Stud Driver.....B3
 Wire Stripper/Cutter.....E14

TUF TOWELS.....D12

TWO WAY SCREWS.....A2-A4, A14, A16

U:
 U-BOLTS.....A31, C6
 UTILITY KNIFE, Lock Back.....E14
 UTILITY SAWS.....E13

WXYZ:
 WALL DOGS.....B14
 WALL-GRIP ANCHORS.....B5
 WALL PLATE
 Gaskets.....C14
 Screws.....A5, B17

WAREHOUSE SUPPLIES.....D12

WASHERS
 Fender.....A29
 Flat.....A28
 Lock.....A27
 Reducing.....C12
 While in Use Covers.....C28

WEATHERTITE HUBS.....C18

WEB Straps (Tie Down).....E35

WEDGE ANCHORS.....B7

WIRE & Rope Dispensers.....E29

WIRE HANGERS.....C3

WIRE MARKER BOOKS.....D13

WIRE Nut Driver.....E2

WIRE STRIPPER.....E14

WIRE Terminal (Kits).....D13

WOOD ROCKETS.....A13, B17

ZAMAC ANCHORS.....B3

THE NEW DOTTIE SLEEVE SYSTEM

Sleeve quantities of Fasteners & Hardware are now packed in our new heavy duty corrugated sleeves. When sleeve quantities are ordered you will experience the true convenience and efficiency of the Dottie Invincibox® merchandising system. Shipping and Receiving is now easier than ever, and with the heavy duty sleeve your order will arrive unharmed. The conveniently packaged quantities of 5 make receiving a breeze. Time is important to all of us, the new Invincibox® sleeve system allows you to save some.



CELEBRATING FIFTY YEARS



1965-2015



CORPORATE HEADQUARTERS

L.H. DOTTIE Co.

6131 GARFIELD AVE., COMMERCE, CA 90040
P:323.725.1000 P:800.982.1901 F:323.721.0000
LHDOTTIE.COM

CAT31D



7 81002 85413 5