



## WATER WORKS GASKETS

This is our new Water Works Catalog. All prices are each, F.O.B. Bakersfield, CA. Our terms are net 30 days. We are continually adding to our product line so please check with us on any item not shown that you may require.

Newby Rubber, Inc. has been manufacturing since 1958. We are proud of our past record, and will continue to provide our customers with the service and quality they expect and deserve. Please feel free to contact us on any requirement you might have.

Our CL-150 gaskets, Transition gaskets and Mechanical joint gaskets are manufactured to meet ASTM-D-1869-66 Specifications for Rubber Rings for Asbestos Cement Pipe, ASTM C564-68 Specifications for Rubber Rings for Cast Iron Soil Pipe, AWWA Standard C111/A21.11-07 and ASTM F477-76 Elastomeric Seals for Joining Plastic Pipe. ASTM C-923 Table 1, Manhole Stop Rings.

### SPECIAL ELASTOMERS

NITRILE (BUNA-N)  
NEOPRENE  
VITON (FLUOROELASTOMER)  
EPDM

### RESISTANT TO MOST

OIL  
LIGHT OIL RESISTANCE  
OIL & TEMPERATURE TO 350° F,  
GASOLINE, OZONE, HOT WATER  
& STEAM TO 500° F

**STORAGE:** Recommended storage would be in a plastic bag and/or a cardboard box, in a cool dry area. Do not store close to electric motors.

**STORAGE LIFE:** NITRILE - Several years.  
NEOPRENE - Indefinite - Long Life.  
VITON (Fluoroelastomer) - Several years.  
EPDM - Indefinite - Long Life.



Dear Customer,

Please allow me to take this opportunity to introduce myself. My name is Robert Leiterman and I am the sales manager for Newby Rubber, Inc. Founded in 1958, we are a rubber manufacturing facility which produces a wide array of rubber products for industries such as agriculture, food processing, waterworks, pump, oilfield and the military, to name a few.

Situated on four acres, our manufacturing plant has recently expanded to an 80,000 square foot facility within 5 buildings.

Compression and transfer molding is done in one of our 37 steam and electric presses, ranging in platen-size from 6" x 6" to 48" x 48" capable of closing pressures up to 450 tons. The unique automation of our 17 injection molding presses allows us to offer extremely competitive pricing on relatively small orders.

Our engineering department can design your tooling and have it machined in our on-site tool and die shop, enabling us to keep cost low and minimize lead time from design to production.

As we place quality as our top priority, our experienced technicians utilize our state-of-the-art lab in order to monitor every aspect of production. This ensures that our customers receive products that adhere to the most stringent quality guidelines.

Your association with Newby Rubber, Inc. allows you to benefit from our many years of experience as well as the expertise of a knowledgeable staff. We strive to combine the prompt and personal service of a small family business with the efficiency and competitive pricing of a large corporation.

We look forward to hearing from you and being able to be of service.

Sincerely,

Ernie Bentley

Sales Manager

320 Industrial Street, Bakersfield, CA 93307-2706  
(661) 327-5137 • Fax - (661) 327-8058  
website: [www.newbyrubber.com](http://www.newbyrubber.com) • e-mail: [sales@newbyrubber.com](mailto:sales@newbyrubber.com)

The logo for Newby Rubber Inc. features the word "NEWBY" in a large, bold, italicized sans-serif font.



## WARRANTY

Seller warrants its product to be free from defects in material and workmanship under normal use and service. This warranty shall not apply to defects resulting from misuse, abuse or accidents. The limit of seller's liability for failure of any of its products to meet the foregoing warranty or for breach of any other warranty, express or implied, shall be to supply an equivalent amount of products for any materials returned to seller within three (3) months of shipment and found to be defective by seller. Due to the widely varying conditions under which seller's products are used or installed, seller offers no warranty, express or implied, as to their length of service, life or suitability for any particular purpose. In no event shall seller be liable for incidental or consequential damages. No person is authorized to bind seller for any further warranty or obligation beyond that stated in this paragraph.

## RETURNING MERCHANDISE

**NO RETURNS** will be accepted without first obtaining a "Return Authorization" number.

**NO CREDIT** will be allowed on damaged goods.

There will be a 10% restocking charge on all items



## TABLE OF CONTENTS

Item	Page Number
<a href="#">JM RING TYPE CL-100</a>	<a href="#">1</a>
<a href="#">RING-TITE TYPE CL-150/200</a>	<a href="#">2</a>
<a href="#">RT-PVC DUAL HARDNESS</a>	<a href="#">3</a>
<a href="#">RT-DI TO CAST IRON (C-900) PIPE</a>	<a href="#">4-5</a>
<a href="#">PUSH-ON TO C-900 PIPE</a>	<a href="#">6</a>
<a href="#">PUSH-ON TO IPS PIPE</a>	<a href="#">7</a>
<a href="#">MECHANICAL JOINT GASKETS TO C-900 PIPE</a>	<a href="#">8</a>
<a href="#">MECHANICAL JOINT TRANSITION GASKETS TO IPS</a>	<a href="#">9</a>
<a href="#">MECHANICAL JOINT TRANSITION GASKET TO SDR-35</a>	<a href="#">10</a>
<a href="#">MANHOLE STOP RINGS</a>	<a href="#">11</a>
<a href="#">PIP &amp; IPS GASKETS</a>	<a href="#">12</a>
<a href="#">“C” (VICTUALIC) TYPE GASKETS</a>	<a href="#">13</a>
<a href="#">RUBBER RING PACKING</a>	<a href="#">14</a>
<a href="#">FIRE HYDRANT GASKETS</a>	<a href="#">15-31</a>





## TABLE OF CONTENTS

Item	Page Number
<a href="#">METER GASKETS</a>	<a href="#">40-41</a>
<a href="#">WASHER I.D.—O.D.</a>	<a href="#">42</a>
<a href="#">CAP GASKET</a>	<a href="#">43</a>
<a href="#">NOZZLE GASKET</a>	<a href="#">44-45</a>

Est. 1958



[Back to Table of Contents](#)

## JM RT TYPE CL-100

### RING-TITE TYPE FITTING TO AC PIPE

SIZE	PART NO.
10" CL-100	10064940
12" CL-100	10064945
14" CL-100	10064950
16" CL-100	10064955
18" CL-100	10064960
20" CL-100	10064962
24" CL-100	10064965

### DIMENSIONS

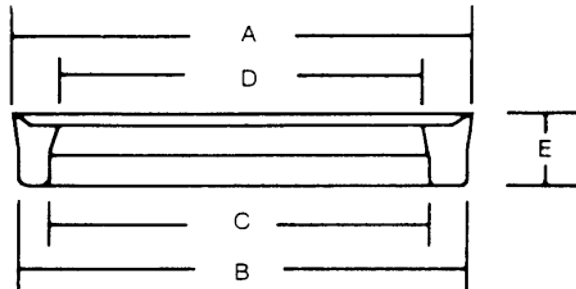

SIZE	A	B	C	D	E
10"	12.130	12.060	11.260	11.072	.800
12"	14.370	14.300	13.500	13.312	.800
14"	16.134	10.050	15.090	14.884	.850
16"	18.224	18.140	17.180	16.954	.850
18"	20.994	20.910	19.950	19.744	.850
20"	23.320	23.140	22.180	21.982	.850
24"	27.594	27.520	26.560	26.362	.850

Est. 1958



[Back to Table of Contents](#)

## JM RT TYPE CL-150/200

### RING-TITE TYPE FITTING TO AC PIPE

SIZE	PART NO.	PCS/BOX
3" CL-150/200	100650	200
4" CL-150/200	100675	200
6" CL-150/200	100700	200
8" CL-150/200	100725	150
10" CL-150/200	100750	100
12" CL-150/200	100775	100
14" CL-150/200	100800	50
16" CL-150/200	100825	50
18" CL-150	100830	25
20" CL-150	100835	25
24" CL-150	100837	

### DIMENSIONS

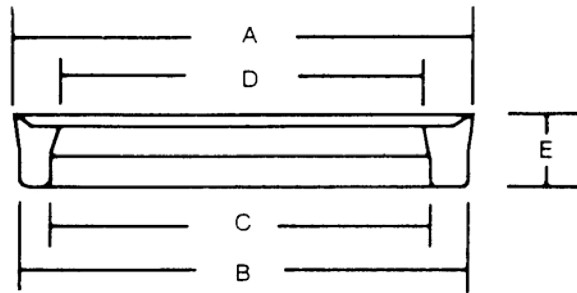

SIZE	A	B	C	D	E
3"	4.665	4.575	3.785	3.689	.790
4"	5.630	5.540	4.750	4.604	.790
6"	7.765	7.675	6.885	6.739	.790
8"	9.990	9.900	9.111	8.965	.790
10"	12.590	12.500	11.711	11.562	.790
12"	14.790	14.651	13.911	13.762	.790
14"	17.284	17.200	16.240	16.014	.850
16"	19.534	19.450	18.490	18.264	.850
18"	22.169	21.950	20.990	20.801	.850
20"	24.394	24.310	23.350	23.124	.850
24"	29.084	29.010	28.050	27.852	.850

Special material quoted on request.

Est. 1958



[Back to Table of Contents](#)

## RT-PVC GASKETS

### DUAL HARDNESS

### RING-TITE TYPE FITTING TO PVC (Iron Pipe Size) TYPE PIPE

SIZE	PART NO.	PCS/BOX
3" RT-PVC	104200	150
4" RT-PVC	104225	100
6" RT-PVC	104250	75
8" RT-PVC	104275	50

### DIMENSIONS

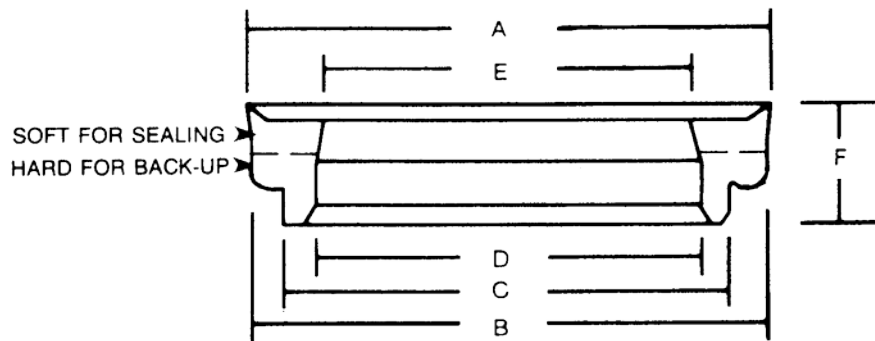

SIZE	A	B	C	D	E	F
3"	4.665	4.575	4.085	3.545	3.385	1.260
4"	5.630	5.540	5.050	4.510	4.350	1.260
6"	7.745	7.655	7.165	6.625	6.465	1.260
8"	10.040	9.950	9.500	8.720	8.560	1.260

Special material quoted on request.

Est. 1958



[Back to Table of Contents](#)

## RT-DI GASKETS

### DUAL HARDNESS

### RING-TITE TYPE FITTING TO CAST IRON SIZE (C-900 Type) PIPE

SIZE	PART NO.	PCS/BOX
4" RT-DI C-900	104075	150
6" RT-DI C-900	104100	100
8" RT-DI C-900	104125	50
10" RT-DI C-900	104150	25
12" RT-DI C-900	104175	25

### DIMENSIONS

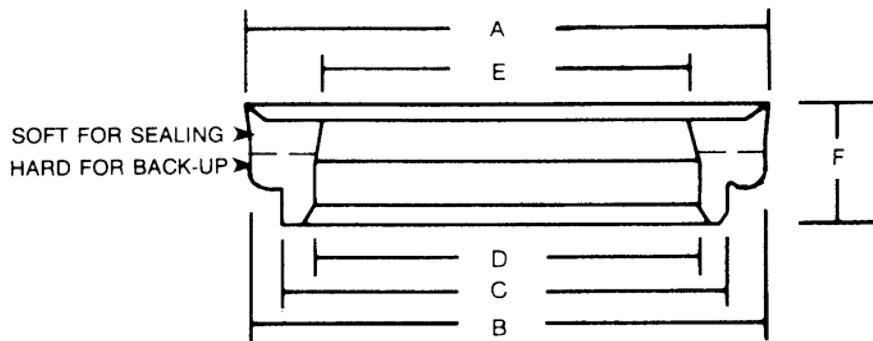

SIZE	A	B	C	D	E	F
4"	5.630	5.540	5.050	4.800	4.640	1.260
6"	7.746	7.655	7.250	6.869	6.709	1.260
8"	10.040	9.950	9.500	9.050	8.890	1.260
10"	12.595	12.500	11.850	11.100	11.010	1.260
12"	14.856	14.761	14.110	13.200	13.110	1.260

Special material quoted on request.

Est. 1958



[Back to Table of Contents](#)

## RT-DI GASKETS

### DUAL HARDNESS

### RING-TITE TYPE FITTING TO CAST IRON SIZE & C900 O.D. PIPE

### DIMENSIONS

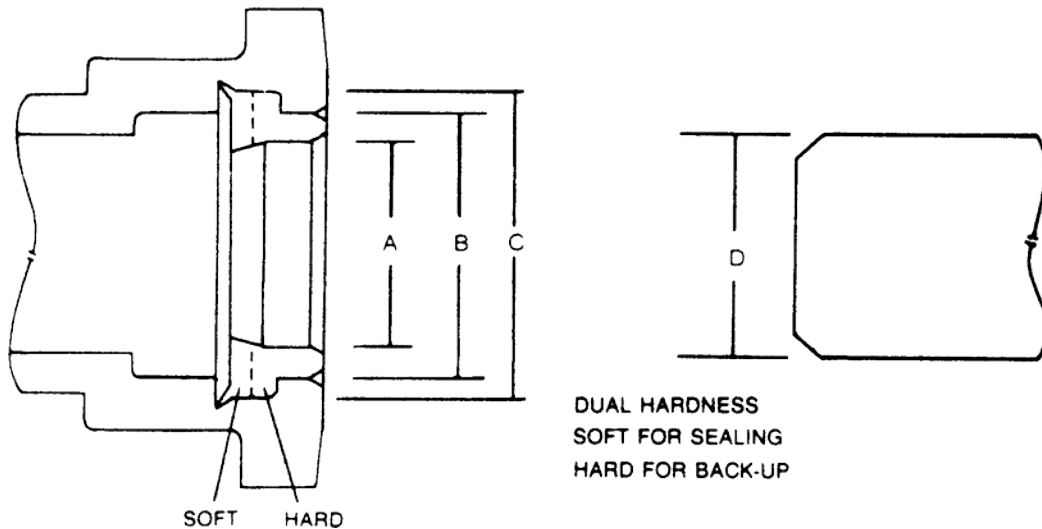

SIZE	A	B	C	D
4" RT-DI-C900	4.780	5.100	5.530	4.800
6" RT-DI-C900	6.780	7.200	7.630	6.900
8" RT-DI-C900	8.950	9.400	9.830	9.050
10" RT-DI-C900	11.040	11.950	12.380	11.100
12" RT-DI-C900	13.055	14.210	14.640	13.200

A-Gasket ID installed.

These RT-DI Gaskets are recommended for use with Cast Iron & C-900 pipe and are designed to hold 200# working pressure if all the dimensions are met. No guarantee is given nor should be implied as to the successful usage of these gaskets. We would particularly like to draw your attention to the "B" dimension of the fitting to be sure it is small enough to provide ample "back-up" for the gasket. These gaskets have been tested and have been used successfully in the field.

Est. 1958



[Back to Table of Contents](#)

## PUSH-ON GASKETS

### DUAL HARDNESS

### DUCTILE IRON PIPE - C900 TYPE

SIZE	PART NO.	PCS/BOX
3" PUSH-ON	107005	
4" PUSH-ON	107010	125
6" PUSH-ON	107015	75
8" PUSH-ON	107020	50
10" PUSH-ON	107025	25
12" PUSH-ON	107030	25
14" PUSH-ON	107034	

### DIMENSIONS

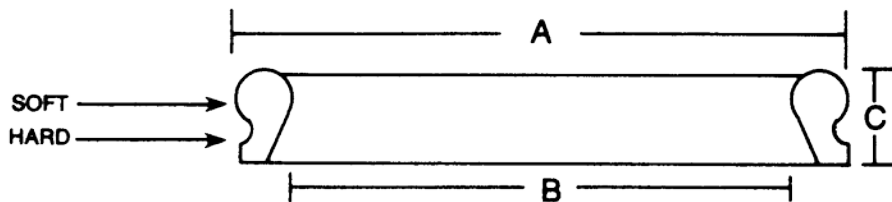

SIZE	A	B	C
4"	5.740	4.540	1.000
6"	7.860	6.600	1.000
8"	10.150	8.730	1.210
10"	12.250	10.830	1.300
12"	14.340	12.920	1.300

Special material quoted on request.

Est. 1958



[Back to Table of Contents](#)

## PUSH-ON GASKETS - IPS

### DUAL HARDNESS

### IRON PIPE - IPS TYPE TRANSITION

SIZE	PART NO.	PCS/BOX
4" PUSH-ON - IPS	107065	125
6" PUSH-ON - IPS	107070	50
8" PUSH-ON - IPS	107075	25
10" PUSH-ON - IPS	107080	25
12" PUSH-ON - IPS	107085	20

Larger Sizes are Available

### DIMENSIONS

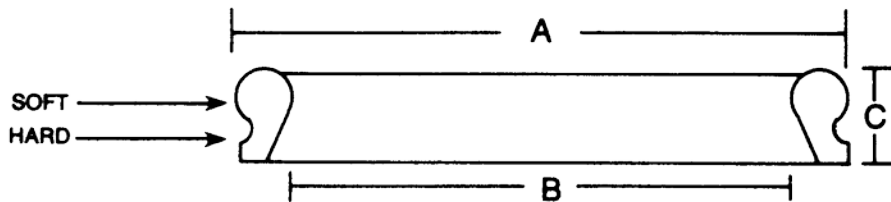

SIZE	A	B	C
4"	5.740	4.180	1.000
6"	7.860	6.310	1.000
8"	10.150	8.320	1.290
10"	12.100	10.300	1.360
12"	14.310	12.700	1.450

Special material quoted on request.



Est. 1958



[Back to Table of Contents](#)

## MECHANICAL JOINT GASKETS

### MECHANICAL JOINT FITTING TO CAST IRON SIZE (C-900) PIPE.

SIZE	PART NO.	PCS/BOX
3" MJ	102924	—
4" MJ	102925	125
6" MJ	102950	75
8" MJ	102975	50
10" MJ	103000	25
12" MJ	103025	25
14" MJ	103030	25
16" MJ	103035	25
24" MJ	103045	—

### DIMENSIONS

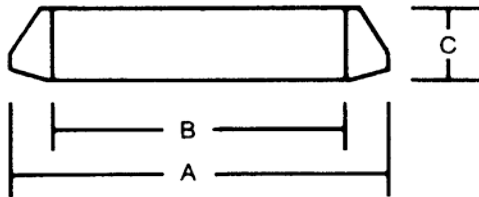

SIZE	A	B	C
3"	4.820	3.860	1.050
4"	5.950	4.680	1.200
6"	7.970	6.700	1.215
8"	10.140	8.875	1.215
10"	12.070	10.840	1.200
12"	14.190	12.930	1.200
14"	16.230	14.990	1.200
16"	18.310	17.070	1.200
24"	26.580	25.340	1.200

Special material quoted on request.

Est. 1958



[Back to Table of Contents](#)

## MECHANICAL JOINT TRANSITION GASKETS

MECHANICAL JOINT FITTING TO IRON PIPE SIZE (IPS, PVC) PIPE.

SIZE	PART NO.	PCS/BOX
3" MJ TRANS.	103050	175
4" MJ TRANS.	103075	100
6" MJ TRANS.	103100	75
8" MJ TRANS.	103125	50
10" MJ TRANS.	103150	25
12" MJ TRANS.	103175	25

### DIMENSIONS

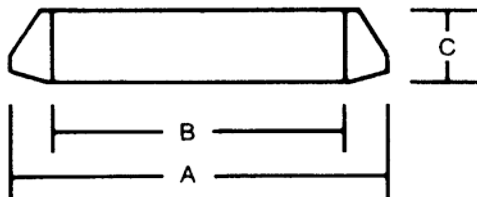

SIZE	A	B	C
3"	4.820	3.440	1.035
4"	5.950	4.380	1.237
6"	8.020	6.480	1.238
8"	10.140	8.480	1.250
10"	12.120	10.520	1.250
12"	14.200	12.500	1.250

Special material quoted on request.

Est. 1958



[Back to Table of Contents](#)

## MECHANICAL JOINT TRANSITION GASKETS

### MECHANICAL JOINT FITTING TO PVC SEWER SIZE (SDR-35) PIPE

SIZE	PART NO.	PCS/BOX
4" MJ TRANS.	103184	75
6" MJ TRANS.	103186	50
8" MJ TRANS.	103188	25
10" MJ TRANS.	103190	25
12" MJ TRANS.	103192	25

### DIMENSIONS

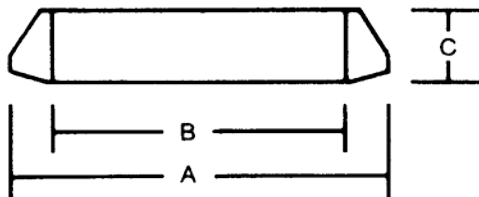

SIZE	A	B	C
4"	5.950	4.215	1.237
6"	8.020	6.275	1.238
8"	10.140	8.400	1.250
10"	12.120	10.500	1.250
12"	14.200	12.500	1.250

Special material quoted on request.

[Back to Table of Contents](#)

## MANHOLE STOP RINGS

TO BE USED WITH PVC THAT GOES INTO A MANHOLE  
AND IS CEMENTED IN PLACE.  
OUR MANHOLE STOP RINGS ARE MOLDED, NOT EXTRUDED.

### ILLUSTRATION

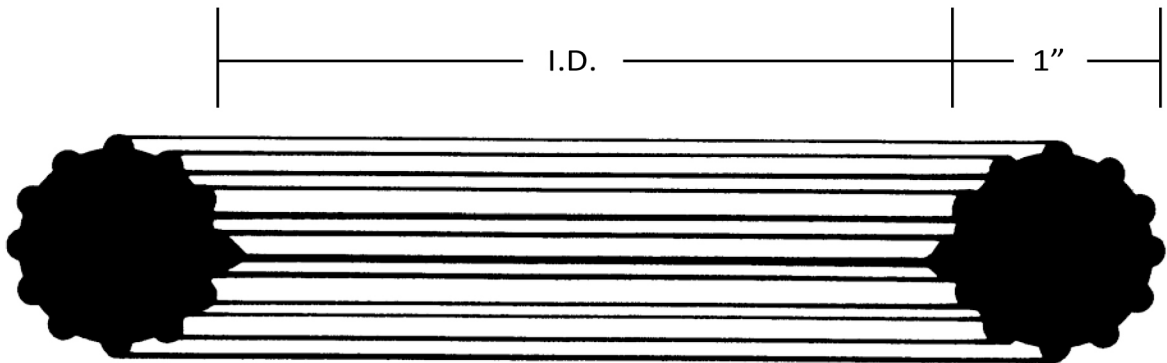

SIZE & TYPE	PART NO.	PCS/BOX	I.D.
4" MANHOLE STOP RING	102675	125	4
6" MANHOLE STOP RING	102700	75	5-7/8
8" MANHOLE STOP RING	102725	50	7-1/2
10" MANHOLE STOP RING	102750	25	10-1/4
12" MANHOLE STOP RING	102775	25	12-1/4
15" MANHOLE STOP RING	102800	25	13-3/8
18" MANHOLE STOP RING	102830	25	16-3/4
21" MANHOLE STOP RING	102833	25	21
24" MANHOLE STOP RING	102836	20	23-3/4
30" MANHOLE STOP RING	102844	15	30
36" MANHOLE STOP RING	102846	15	38

Other sizes quoted on request.

Est. 1958



[Back to Table of Contents](#)

## PIP & IPS GASKETS (Dresser Type, Romac & Others)

ITEM	PIPE OD	CROSS SECTION		PART NO.
		A	B	
2" IPS	2.380"	1/2"	x 29/32"	102407
2-1/2" IPS	2.880"	1/2"	x 29/32"	102408
3" IPS	2.500"	1/2"	x 29/32"	102409
4" IPS	4.500"	7/16"	x 29/32"	102410
4-1/2" IPS	5.000"	.475"	x .900"	102411
5" IPS	5.500"	3/8"	x 3/4"	102412
6" IPS	6.625"	1/2"	x 1"	102414
6" IPS	6.625"	3/8"	x 1"	102416
8" IPS	8.625"	1/2"	x 1"	102418
8" IPS	8.625"	3/8"	x 1"	102420
10" IPS	10.750"	1/2"	x 1"	102422
12" IPS	12.750"	1/2"	x 1"	102424
6" PIP	6.140"	3/8"	x 7/8"	103650
6" PIP	6.140"	1/2"	x 1"	103651
8" PIP	8.160"	3/8"	x 7/8"	103652
8" PIP	8.160"	1/2"	x 7/8"	103653
10" PIP	10.200"	1/2"	x 1"	103654
12" PIP	12.240"	1/2"	x 1"	103656
15.3" PIP	15.300"	1/2"	x 1"	103658
18.36" PIP	18.360"	1/2"	x 1"	103660
20.4" PIP	20.400"	1/2"	x 1"	103662

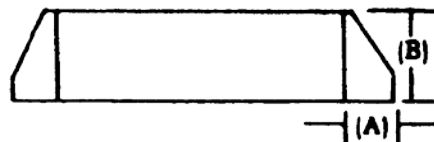

[Back to Table of Contents](#)

## “C” SHAPED TYPE (VICTAULIC TYPE)

(Fits #77, 78, 75 Couplings)

**EPDM\***

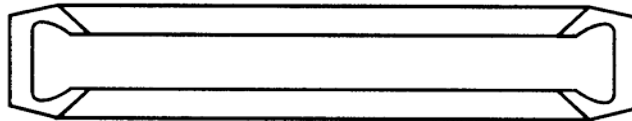

SIZE	PART NO.	PCS/BOX
2"	105925	500
2 1/2"	105928	300
3"	106000	300
4"	106025	150
5"	106026	150
6"	106050	125
8"	106075	50
10"	106077	50
12"	106079	50
14"	106080	50

\*Special material quoted on request.

Est. 1958



[Back to Table of Contents](#)

## RUBBER RING PACKING

### HYDRO TYPE

SIZE	PART NO.
4"	104292
6"	104294
8"	104296
12"	104298

### DIMENSIONS

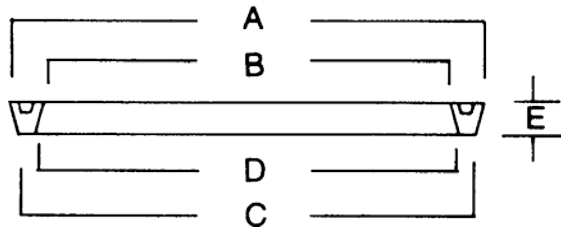

SIZE	A	B	C	D	E
4"	5.600	4.210	5.000	4.750	1.100
6"	7.660	6.320	7.125	6.875	1.100
8"	9.880	8.380	9.228	9.032	1.100
12"	13.600	12.300	13.120	12.880	1.100

[Back to Table of Contents](#)

## FIRE HYDRANT GASKETS

ITEM                      PARTNO.

FHG-1                      101301  
GREENBERG #74 TYPE

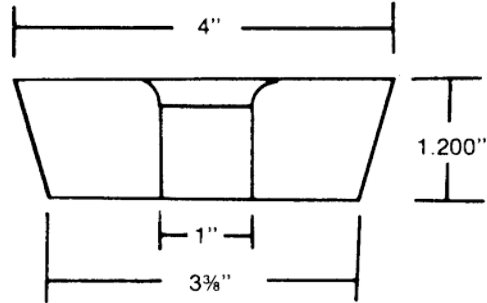

FHG-2                      101302  
4" COREY TYPE

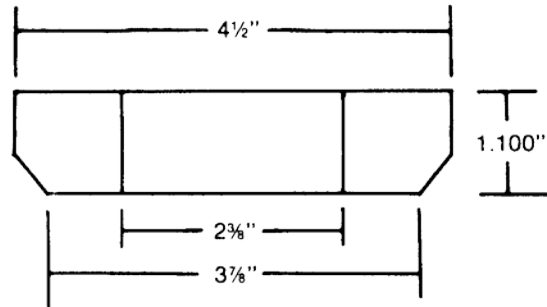

FHG-3                      101303  
COREY RUBBER TYPE

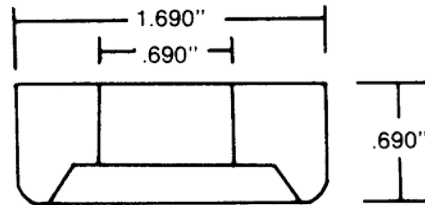

FHG-4                      101304  
DELMONTE 86 TYPE

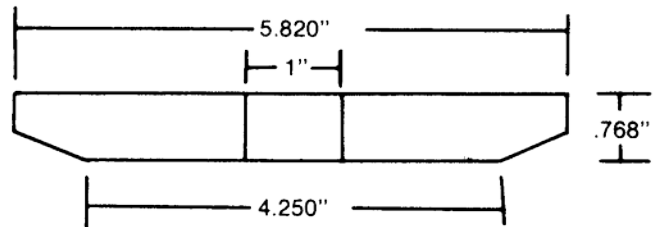

FHG-5                      101305  
GREENBERG #175 TYPE

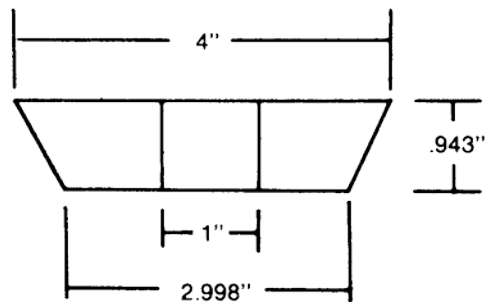



[Back to Table of Contents](#)

## FIRE HYDRANT GASKETS

ITEM PARTNO.  
FHG #6 101306

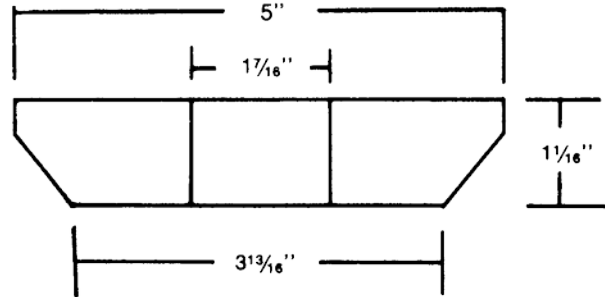

FHG #7 101307  
4-1/2" VO VALVE RUBBER TYPE

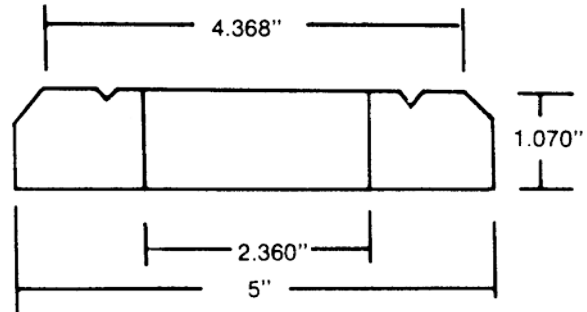

FHG #8 101308  
WHARF HYDRANT TYPE

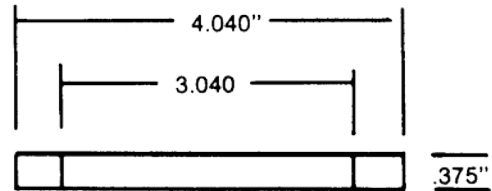

FHG #9 101309 FBS  
101309 NoFabric

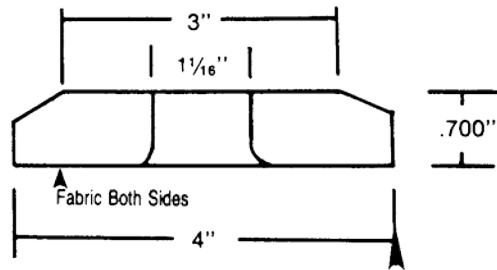

FHG #10 101310  
WHARF HYDRANT TYPE

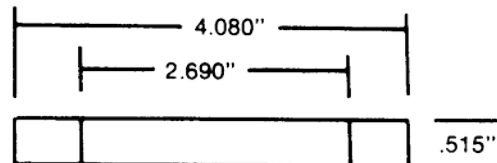

[Back to Table of Contents](#)

**FIRE HYDRANT GASKETS**

ITEM PARTNO.  
FHG #11 101311  
2-1/2" BALLOTA TYPE  
CLOW 850 TYPE

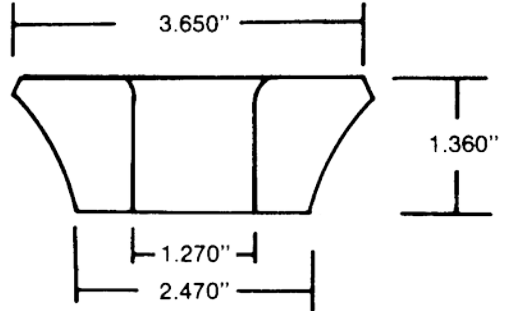

FHG #12 101312  
4" BALLOTA TYPE

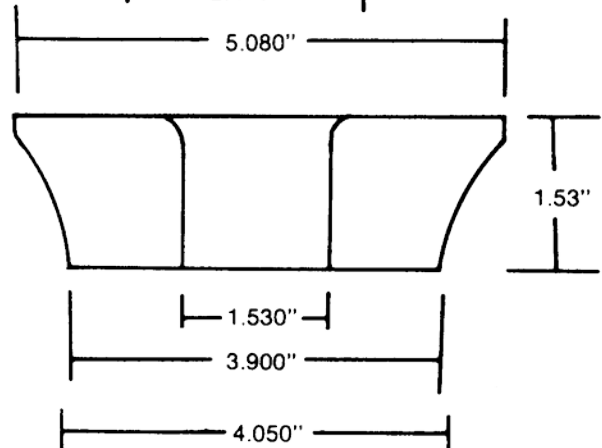

FHG #13 101313

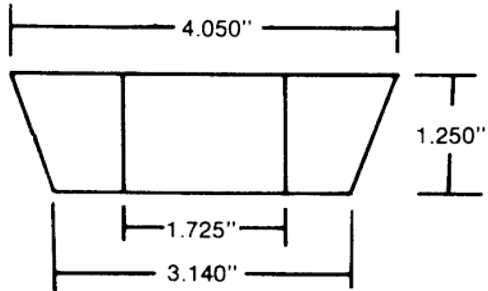

FHG #14 101314  
3-5/16" Diameter  
bolt holes on 2.938 B.C.

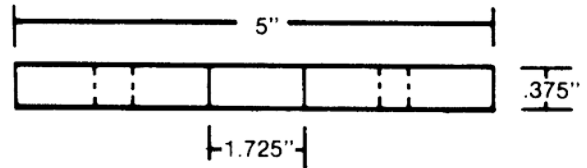

FHG #15 101315

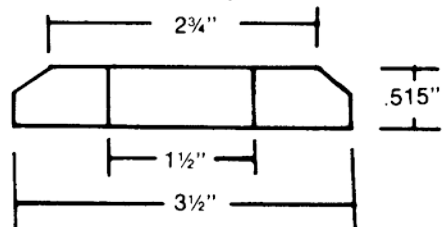

[Back to Table of Contents](#)

## FIRE HYDRANT GASKETS

ITEM PARTNO.  
FHG #16 101316

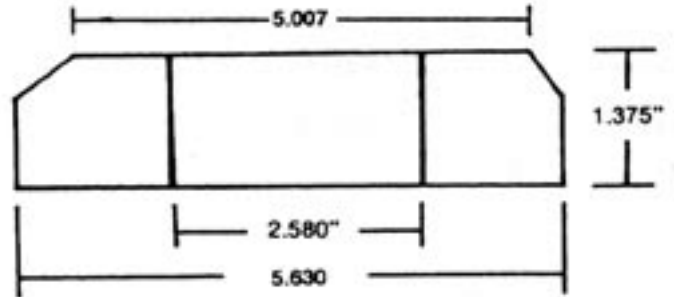

FHG #17 101317 No Fabric  
101317FBS  
GREENBERG TYPE  
LUDLOW 4-1/2" VO TYPE

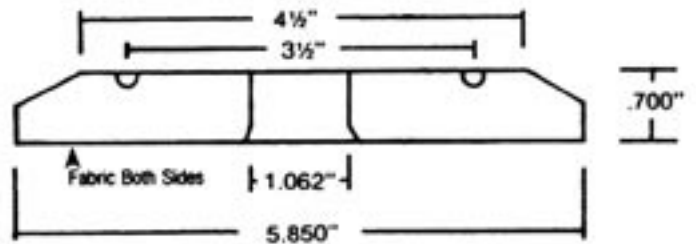

FHG #18 101318

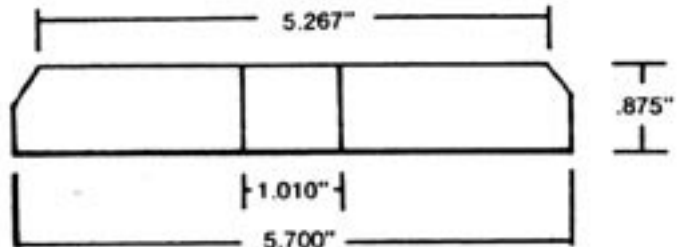

FHG #19 101319

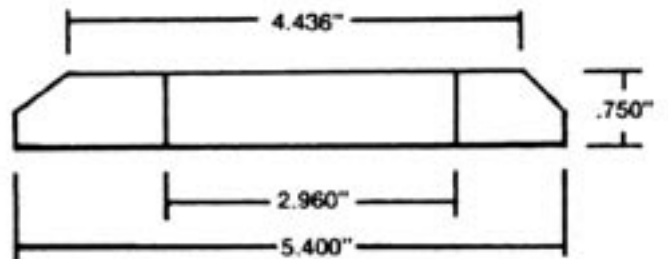

FHG #20 101320  
CLOW TYPE

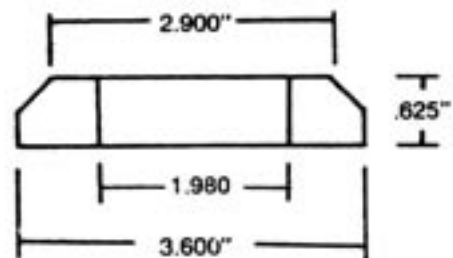

Est. 1958



[Back to Table of Contents](#)

## FIRE HYDRANT GASKETS

ITEM PARTNO.  
FHG #21 101321 FBS

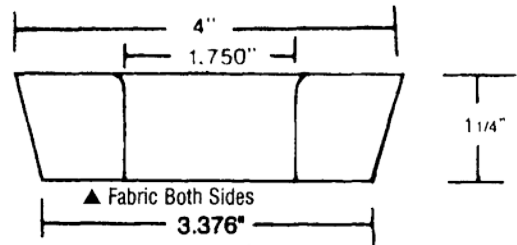

FHG #22 101322FBS

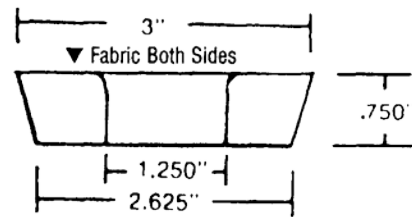

FHG #23 101323

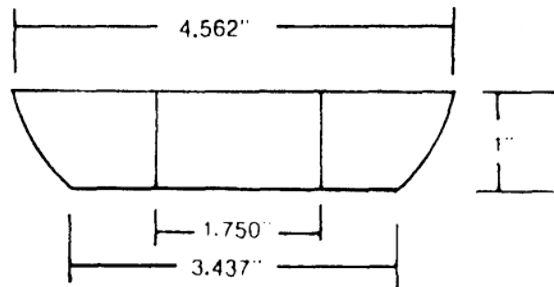

FHG #24 101324

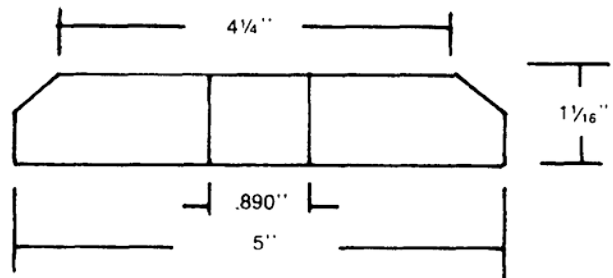

Est. 1958



[Back to Table of Contents](#)

## FIRE HYDRANT GASKETS

ITEM PART NO.  
FHG #25 101325

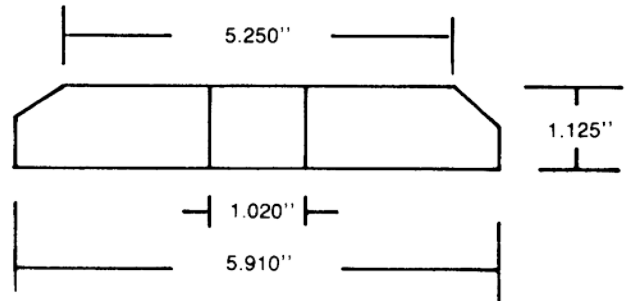

FHG #26 101326

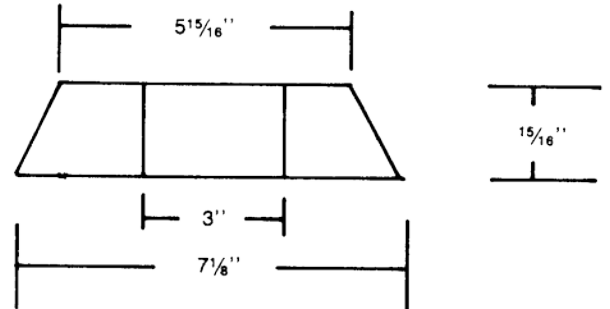

FHG #27 101327

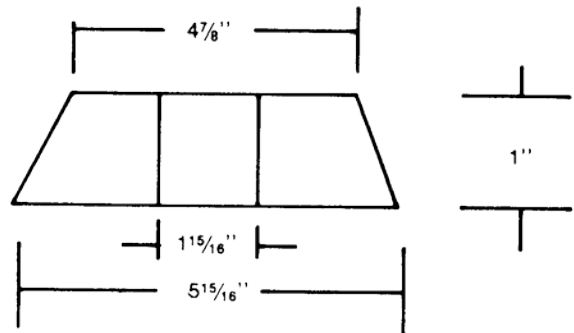

FHG #28 101328  
AMERICAN DARLING TYPE

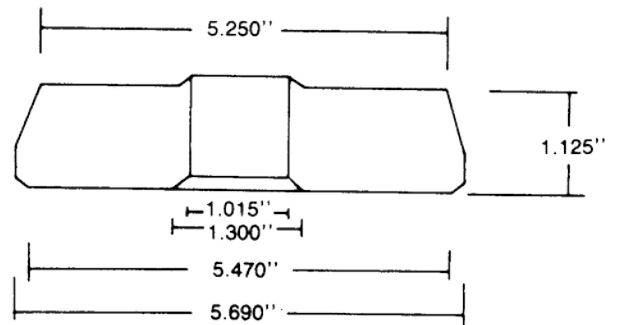

[Back to Table of Contents](#)

## FIRE HYDRANT GASKETS

ITEM                      PARTNO.  
 FHG #29                101329  
 AMERICAN DARLING TYPE  
 GENUINE IOWA

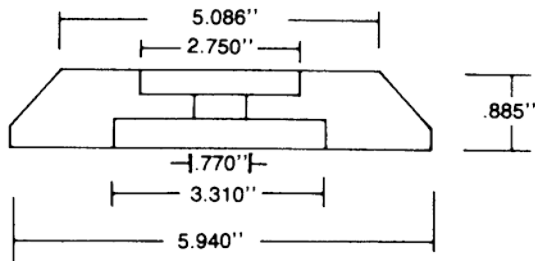

FHG #30                      101330

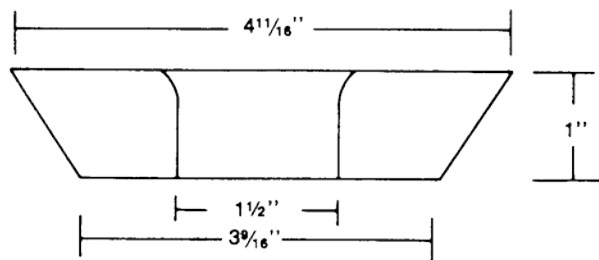

FHG #31                      101331

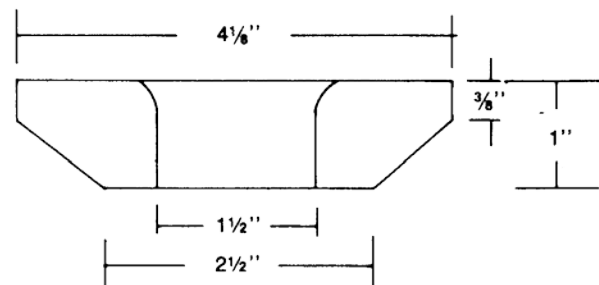

FHG #32                      101332  
 M & H-129 TYPE

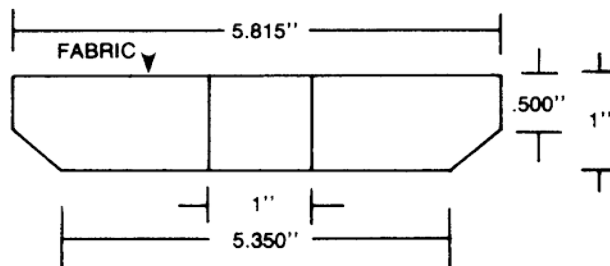

FHG #33                      101333

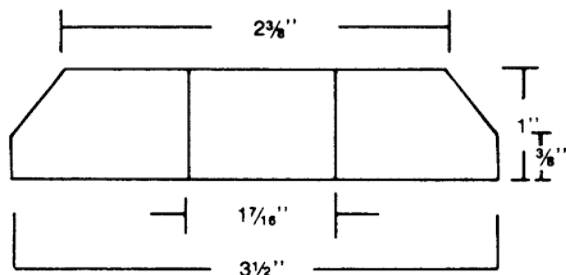

[Back to Table of Contents](#)

ITEM                      PARTNO.  
FHG #34                      101334  
(New Style)  
CLOW PART #12-333  
4- 1/4" VANGARD TYPE

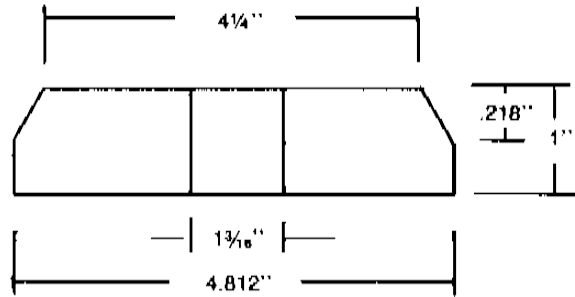

FHG #35                      101335  
(Old Style)  
CLOW PART #12-330

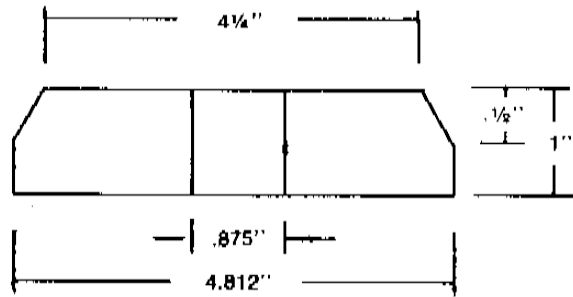

FHG #36                      101336  
WATEROUS TYPE WT77

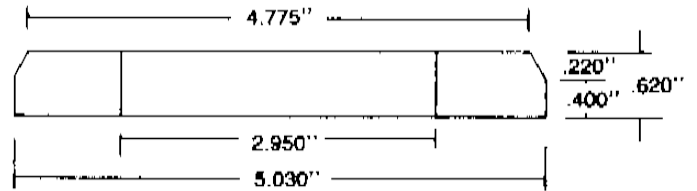

FHG #37                      101337  
WATEROUS TYPE WB67

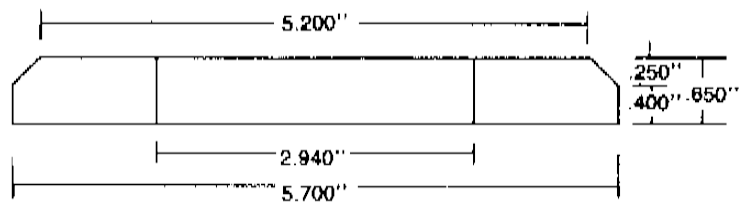

FHG #38                      101338  
RICH TYPE

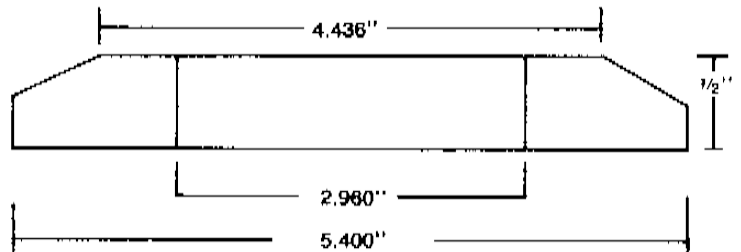

Est. 1958

# NEWBY

RUBBER INC

[Back to Table of Contents](#)

ITEM

PARTNO.

FHG #39

101339

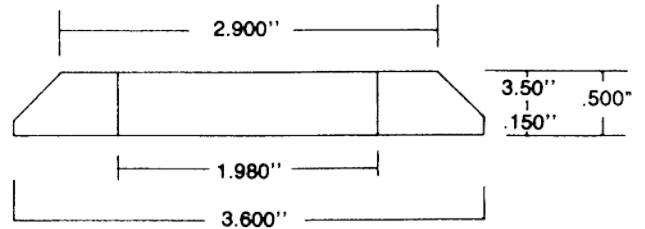

FHG #40

101340

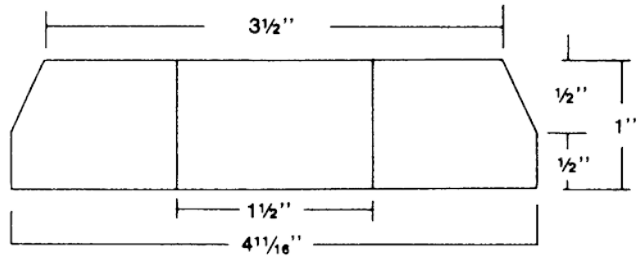

FHG #41

101341

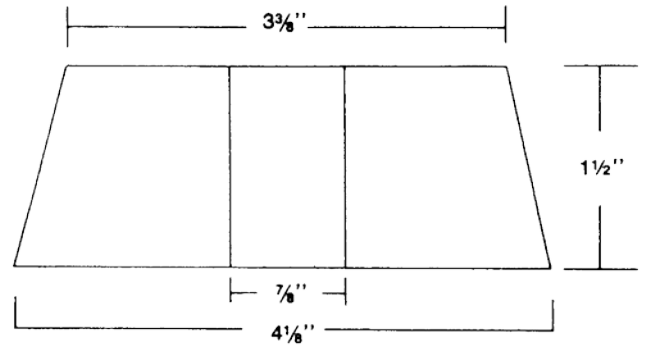

FHG #42

101342

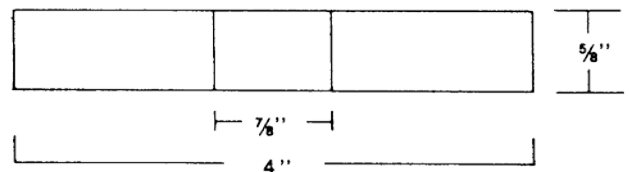



Est. 1958

# NEWBY

RUBBER INC

[Back to Table of Contents](#)

ITEM PARTNO.  
FHG #43 101343

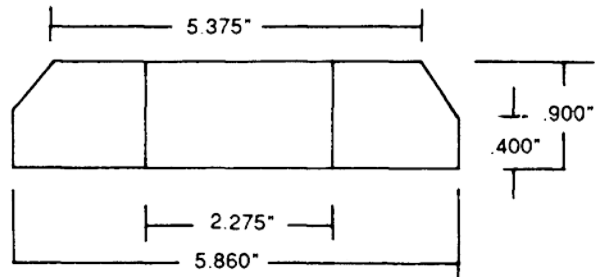

FHG #44 101344  
4-1/2" KENNEDY TYPE

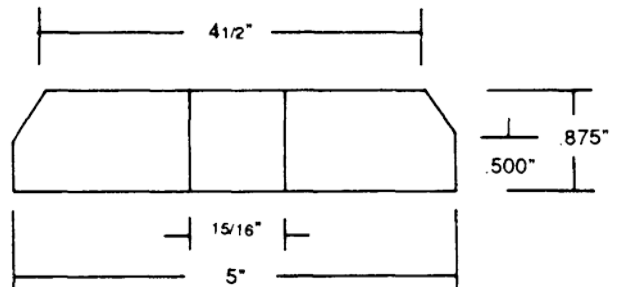

FHG #45 101345

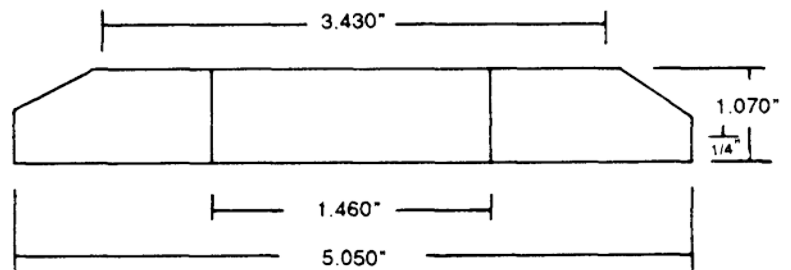

FHG #46 101346

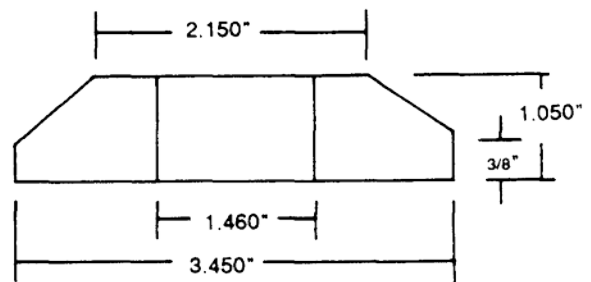

Est. 1958

# NEWBY

RUBBER INC

[Back to Table of Contents](#)

ITEM

PARTNO.

FHG #47

101347

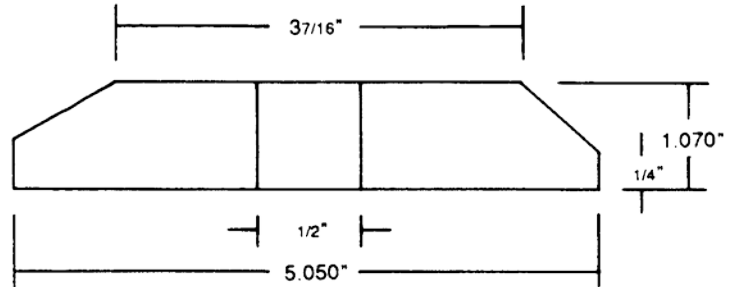

FHG #48

101348

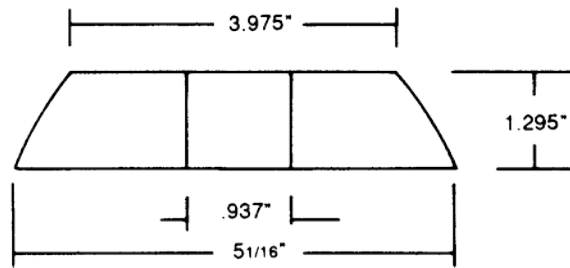

FHG #49

101349

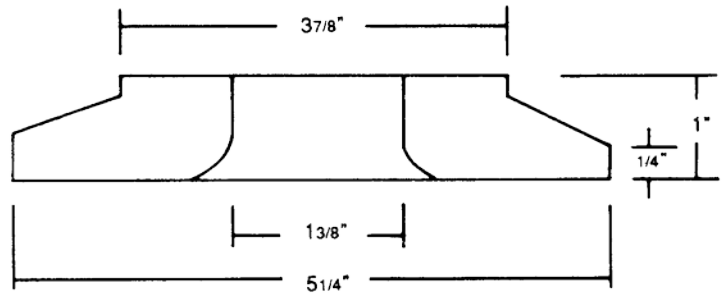

FHG #50

101350

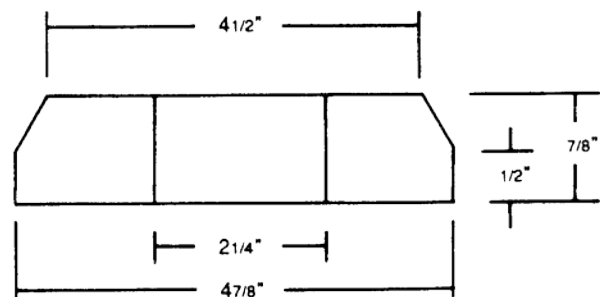

Est. 1958

# NEWBY

RUBBER INC

[Back to Table of Contents](#)

ITEM

PARTNO.

FHG #51

101351

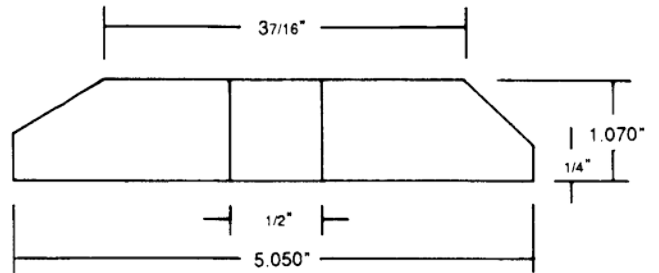

FHG #52

101352

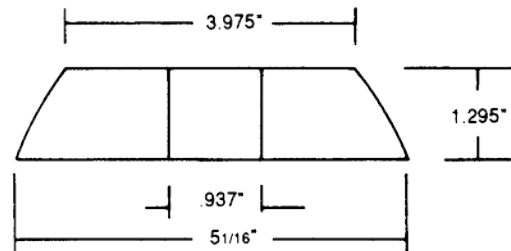

FHG #53

101353

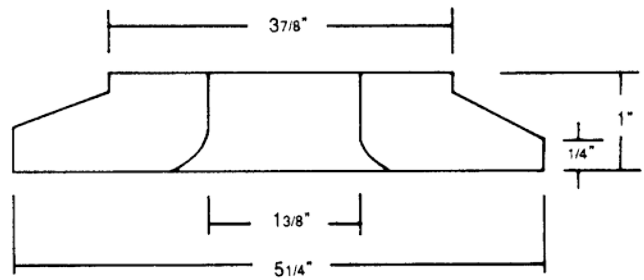

FHG #54

101354

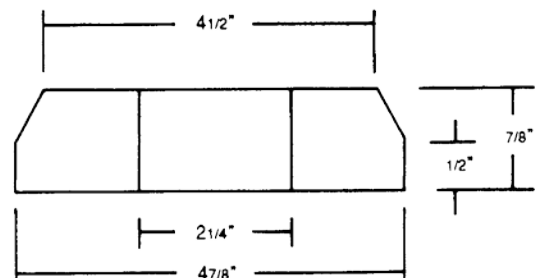

Est. 1958



[Back to Table of Contents](#)

## FIRE HYDRANT GASKETS

ITEM

PARTNO.

FHG #55

101355

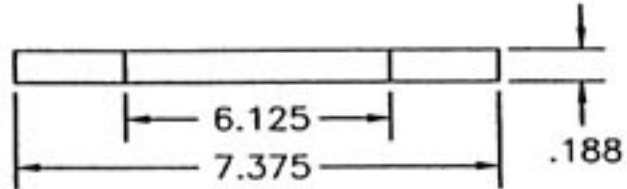

FHG #56

101356

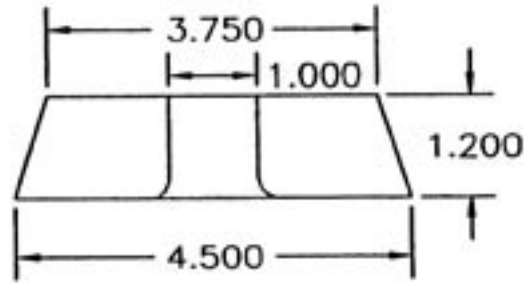

FHG #57

101357

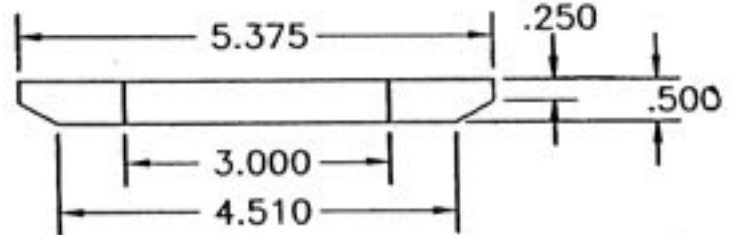

FHG #58

101358

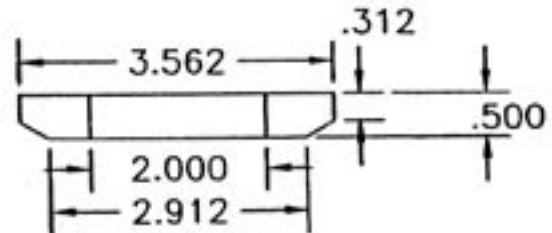

Est. 1958



[Back to Table of Contents](#)

## FIRE HYDRANT GASKETS

ITEM PARTNO.  
FHG #59 101359

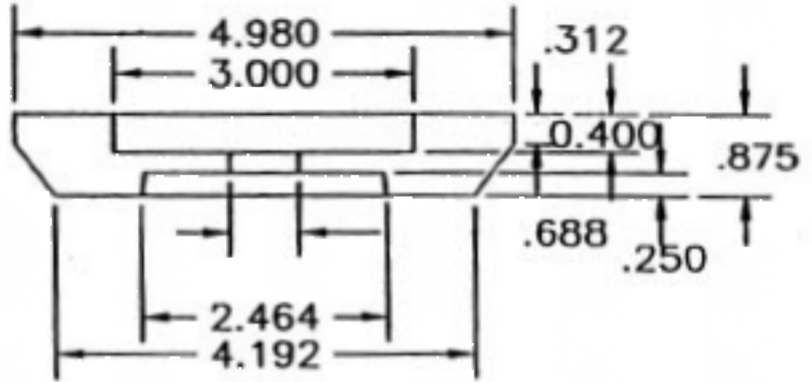

FHG #60 101360

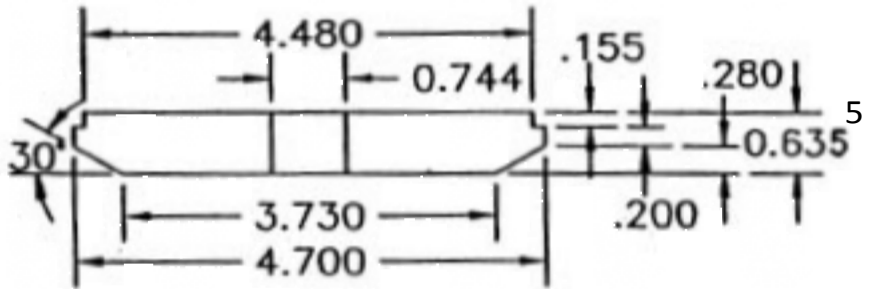

FHG #61 101361

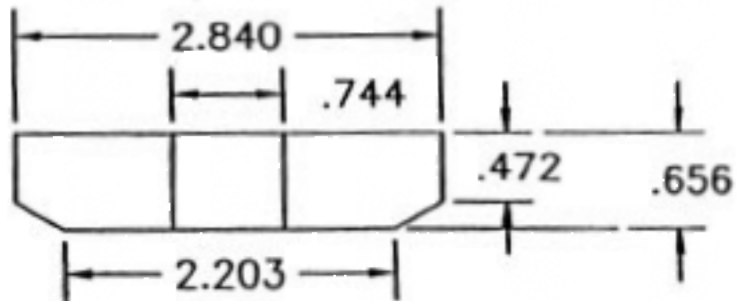

[Back to Table of Contents](#)

## FIRE HYDRANT GASKETS

ITEM PART NO.  
FHG #62 101362

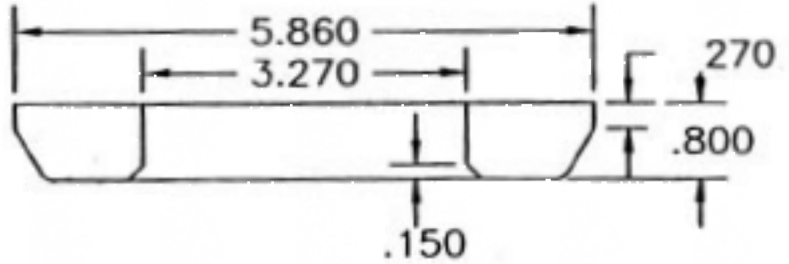

FHG #63 101363  
LUDLOW DRAIN VALVE

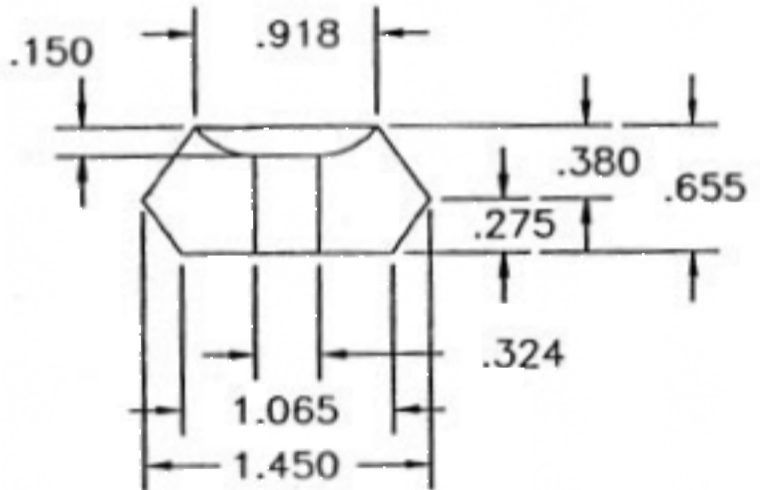

FHG #64 101364

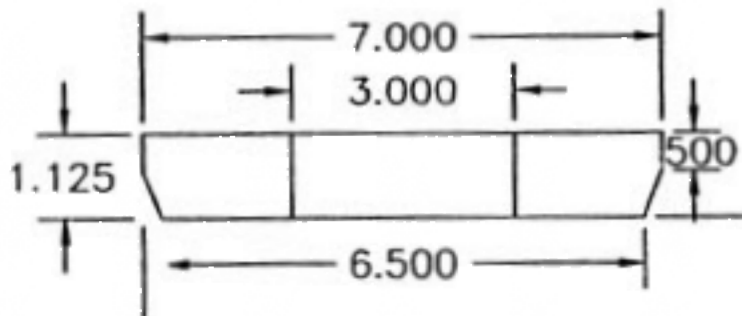

Est. 1958



[Back to Table of Contents](#)

## FIRE HYDRANT GASKETS

ITEM  
FHG #65

PART NO.  
101365

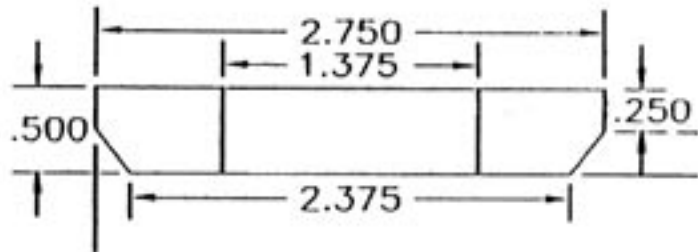

FHG #66  
CLOW

101366

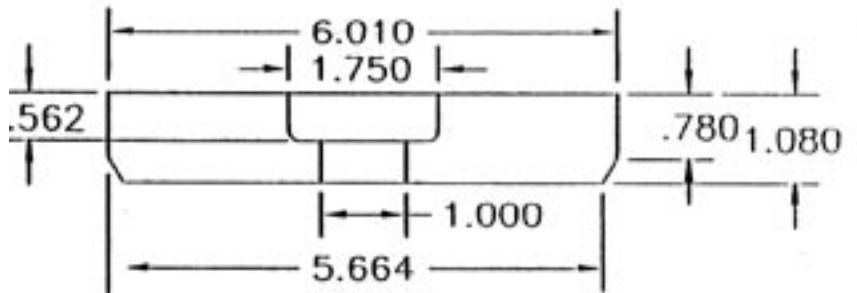

[Back to Table of Contents](#)

ITEM	PART NO.	
FHG # 68	.101368	<p>Technical drawing of FHG # 68 showing dimensions: 3.000, 1.500, 0.700, and 4.000.</p>
FHG # 69	.101369	<p>Technical drawing of FHG # 69 showing dimensions: 6.410, 4.080, 0.630, and 6.385.</p>
FHG # 70	.101370	<p>Technical drawing of FHG # 70 showing dimensions: 3.469, 0.906, 1.453, and 2.469.</p>
FHG # 71	.101371	<p>Technical drawing of FHG # 71 showing dimensions: 5.687, 1.030, 1.155, and 5.188.</p>
FHG # 72	.101372	<p>Technical drawing of FHG # 72 showing dimensions: 5.400, 1.060, 1.562, and 5.188.</p>



[Back to Table of Contents](#)

ITEM PARTNO.

FHG #73

101373

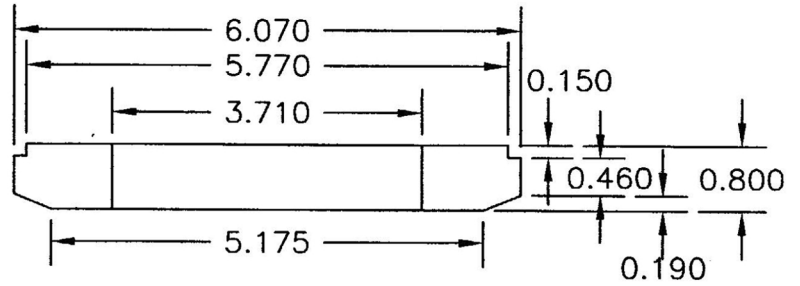

FHG #74

101374

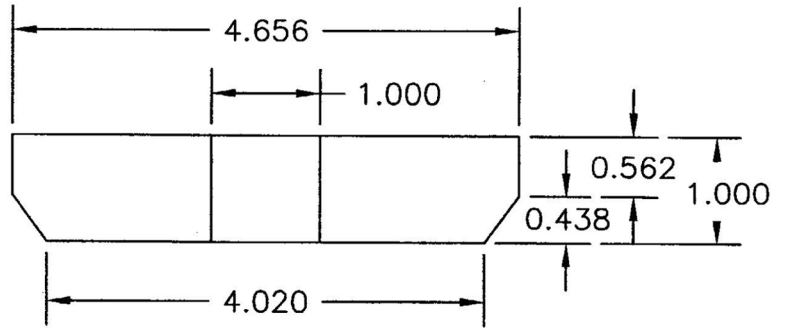

FHG #76

101376

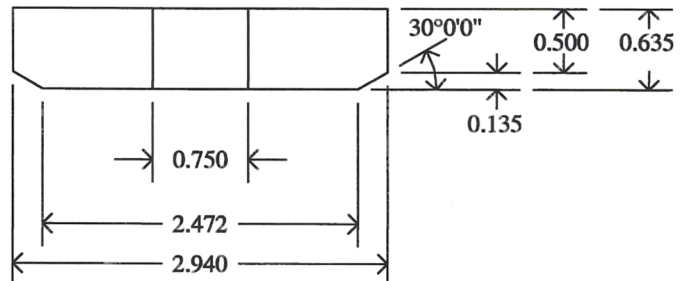

[Back to Table of Contents](#)

PART NO. 400102  
DROP IN METER GASKET  
1 1/2"  
1/8 THICK

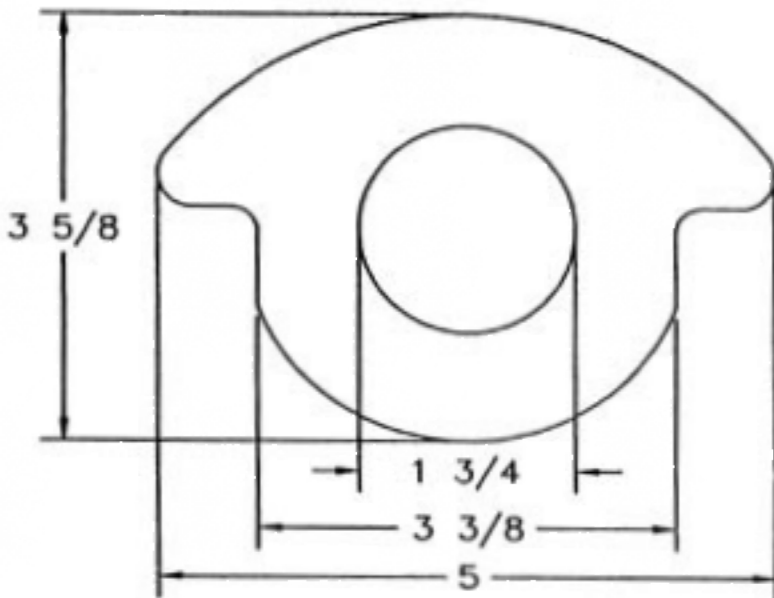

PART NO. 400103  
FULL FACE METER  
GASKET 1 1/2"  
1/8 THICK

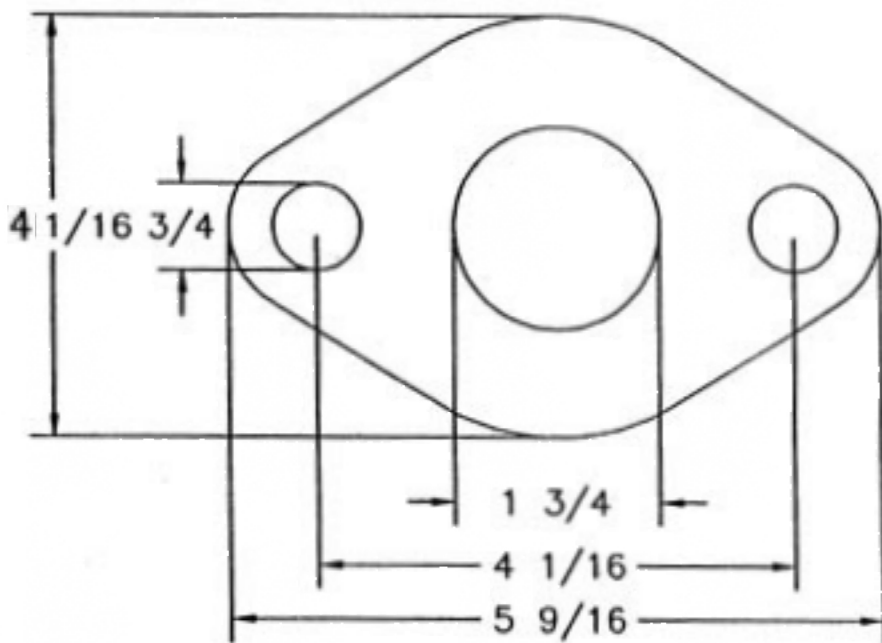

Est. 1958

# NEWBY

RUBBER INC

[Back to Table of Contents](#)

PART NO. 400100  
METER GASKET  
1/8 THICK

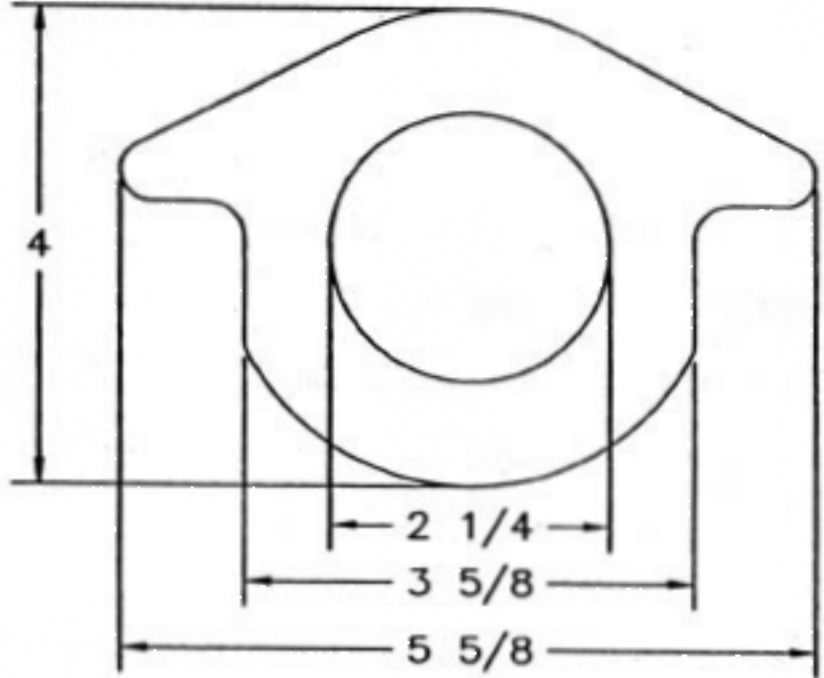

PART NO. 400101  
METER GASKET  
1/8 THICK

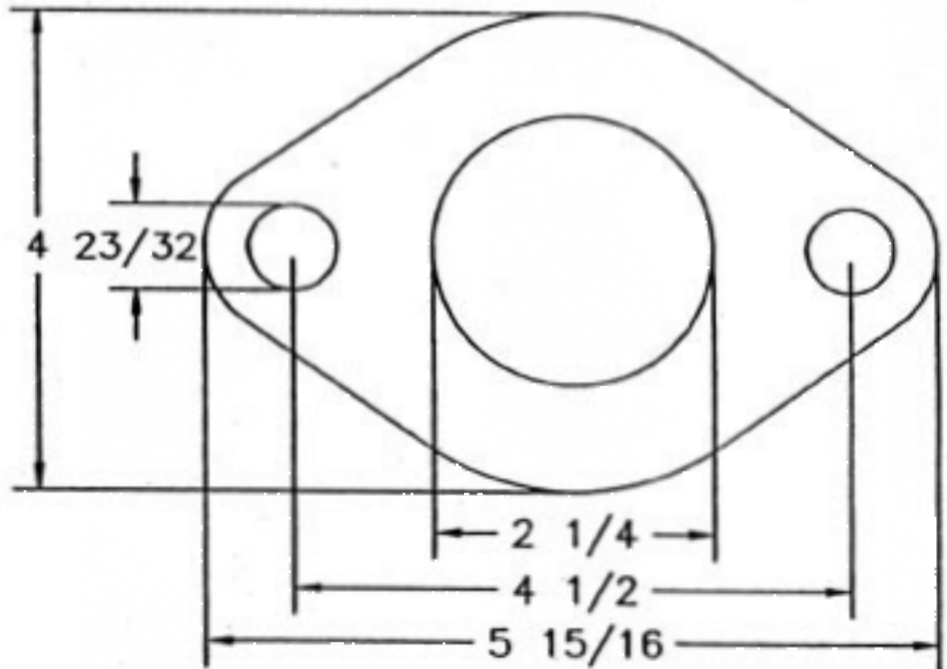

Est. 1958

# NEWBY

---

RUBBER INC

[Back to Table of Contents](#)

PART NO. 400300  
WASHER  
3/4 ID X 1 3/16 OD X 1/16 THICK

PART NO. 400301  
WASHER  
3/4 ID X 1 3/16 OD X 1/8 THICK

PART NO. 400302  
WASHER  
3/4 ID X 1 1/8 OD X 1/8 THICK

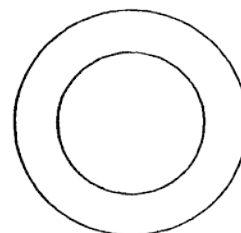

PART NO. 400305  
WASHER  
1 ID X 1 1/2 OD X 1/16 THICK

PART NO. 400306  
WASHER  
1 ID X 1 1/2 OD X 1/8 THICK

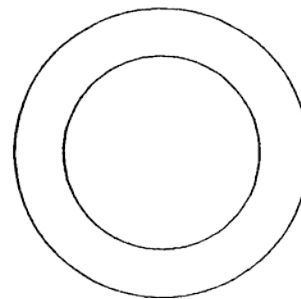

Est. 1958

**NEWBY**

**RUBBER INC**

[Back to Table of Contents](#)

PART NO. 400210  
2 1/2" CAP GASKET  
1/16 THICK

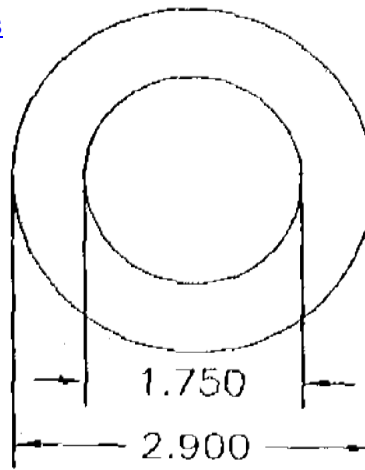

PART NO. 400220  
4" CAP GASKET  
1/16 THICK

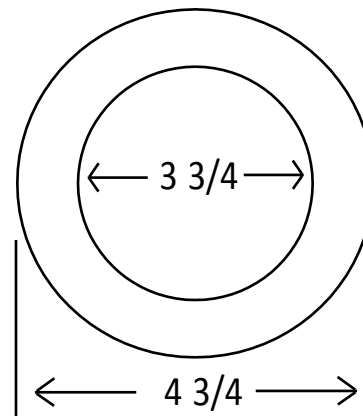

PART NO. 400225  
4 1/2" CAP GASKET  
1/16 THICK

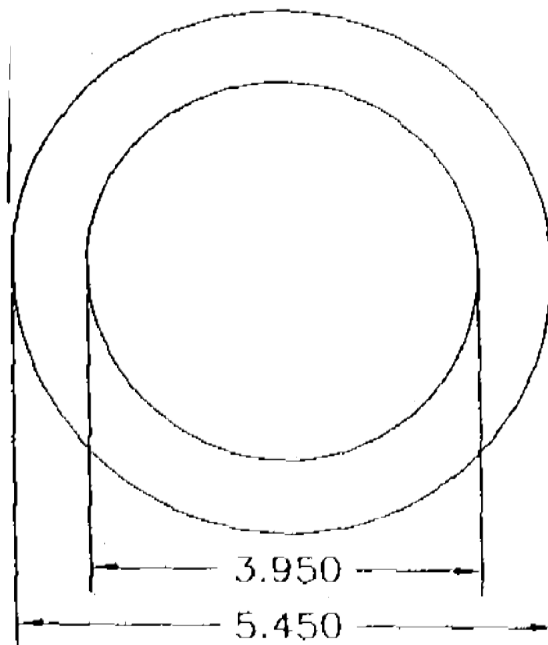

Est. 1958



[Back to Table of Contents](#)

PART NO. 400330  
NOZZLE GASKET  
3 1/16" THICK

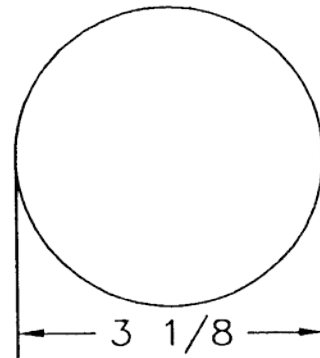

Est. 1958

# NEWBY

RUBBER INC

[Back to Table of Contents](#)

PART NO. 400320  
NOZZLE GASKET  
3/16" THICK

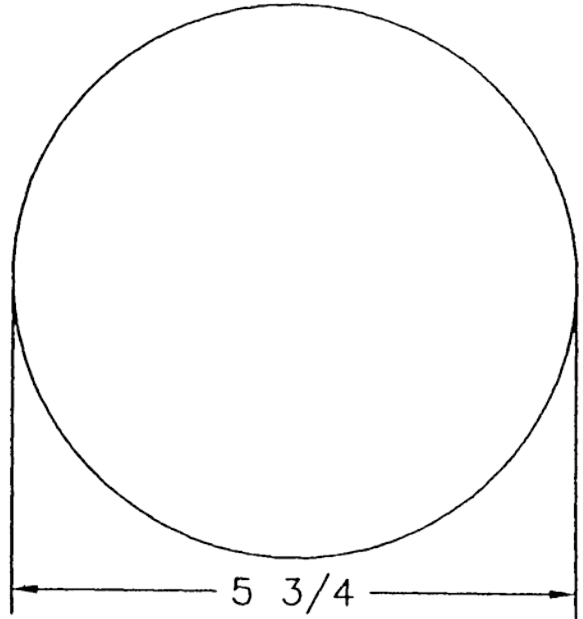

PART NO. 400310  
NOZZLE GASKET  
3/16" THICK

