

*Flexitallic*<sup>®</sup>

# SPIRAL WOUND GASKETS

Driven by the industry's need for safe, effective sealing solutions, Flexitallic invented the spiral wound gasket.



# FLEXITALLIC

The Flexitallic Group is the international market leader in the manufacture and supply of high quality, high value industrial static sealing products, delivering industrial gaskets on a global scale.



## **About us**

As the developer of the spiral wound gasket in 1912, we have built on this legacy of innovation with revolutionary products including Thermiculite<sup>®</sup> and Sigma<sup>®</sup>, The Flange Rescue Gasket winner of the NACE and Dupont Plunkett Awards, and most recently the Change<sup>™</sup> Gasket, set to transform the global sealing industry.

We have a global network of Allied Distributors across 30 countries. This ensures local demand is met quickly, providing a combination of the highest product quality and outstanding customer service.

Our extensive and varied product offering includes spiral wound gaskets, RTJ gaskets, Flexpro<sup>™</sup> Kammprofiles, sheet materials, dynamic and static packings, pipe support and custom rubber products. Drawing upon the group's rich history and present day values of leadership, quality, service and technology, we are at the forefront of developing sealing solutions for industries around the world.

In addition to a wide range of products, we also deliver world-class technical support and Joint Integrity training.



Based on sales and geographic reach, the Flexitallic Group has become *the* global supplier of industrial gaskets.

**Innovative Product Range**

We have a rich history of innovation, which has seen us lead the industry with many new products.

Over the years, our products have gained a reputation for quality, reliability and technology that is second to none.

**Customised Engineering Solutions**

Our Application Engineering, Production Engineering and R&D teams work closely together to design, develop and manufacture bespoke sealing solutions.

We have been responsible for a number of truly revolutionary products, including Thermiculite®, Sigma® and the Flange Rescue Gasket, which ensure we are able to continually meet the ever more stringent requirements of our customers.

**Flexitallic® Safe**

Over the last century, our aggressive R&D efforts have helped customers become Flexitallic® Safe. From the first Spiral Wound Gasket in 1912 to the ever evolving applications for Thermiculite®, our goal is to develop materials that push the parameters of heat, pressure and chemical resistance.

**Our Commitment to Quality**

We place great emphasis on maintaining international quality standards, and are approved to ISO 9001:2008, ISO 14001:2004 and OHSAS 18001:2007, API 6A and API 17D, to ensure we meet the highest possible standards for all our products and services.

We also invest heavily in test and quality assurance equipment to maintain our reputation for the highest quality products.

Our materials are subjected to a wide range of tests as specified by statutory regulations and customer requirements. These approvals enable our customers to make informed choices as to the suitability of a product for each and every application.

**Inside Industry**

We pride ourselves on not simply supplying products, but by supporting customers with a detailed knowledge of their industry and applications, so that products and services are tailored to their specific needs.

This unique approach means that we focus on providing more than just a product, but also a complete solution that adds genuine value to our clients.

**Global Distribution... Local Support**

Our products are distributed through a global network of Allied Distributors.

These carefully selected distribution partners are strategically located within their territory to deliver the best possible service and products to our customers. This approach means our products and know-how are available to the global industries we service.

**Allied Distributor**



**Licensee Manufacturer**



# CONTENTS

	PAGE
<b>INTRODUCTION</b>	1
<b>SPIRAL WOUND GASKETS</b>	3
<b>GASKET IDENTIFICATION</b>	4
<b>GASKET MATERIALS</b>	5
<b>GASKET SELECTION</b>	6
<b>STYLE CG &amp; CGI GASKETS</b>	7
<b>DIMENSIONAL DATA</b>	8
<b>TECHNICAL INFORMATION</b>	21
<b>SPECIAL APPLICATION GASKETS</b>	25
<b>THE ACADEMY OF JOINT INTEGRITY</b>	32

# SPIRAL WOUND GASKETS

Driven by the industry's need for safe, effective sealing solutions for increasingly demanding applications, Flexitallic invented the spiral wound gasket in 1912.



## First and Foremost

The concept of spiral wound gasket construction was originated by Flexitallic in 1912, starting a new era in safe, effective sealing. The primary purpose for this development was the increasingly severe temperatures and pressures used by U.S. refinery operators in the first half of the 20th century.

The necessity for a gasket to have the ability to recover cannot be over emphasised. The effects of pressure and temperature fluctuations, the temperature differential across the flange face, together with bolt stress relaxation and creep, demand a gasket with adequate flexibility and recovery to maintain a seal even under these varying service conditions. The Flexitallic Spiral Wound Gasket is the precision engineered solution to such problems, meeting the most exacting conditions of both temperature and pressure in flanged joints and similar assemblies and against virtually every known corrosive and toxic media.

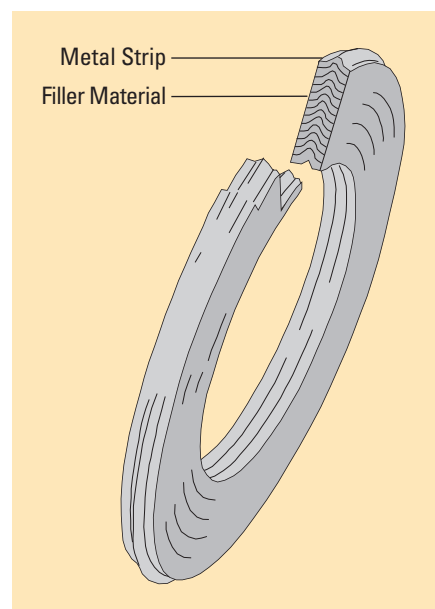

## GASKET IDENTIFICATION

Gaskets are colour coded to help expedite the selection and identity of the gaskets you need. The colour on the outside edge of the centering ring identifies both the winding and filler materials. The metallic winding material is designated by a solid colour. The filler materials are designated by colour stripes at equal intervals on the outside edge of the centering ring. Flexitallic colour coding meets the industry standard for metal and filler materials listed in ASME B16.20.

### Metallic Winding Materials

The metallic winding material is designated by a solid colour identification around the outside edge of the centering ring.

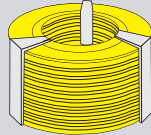

304SS  
Yellow

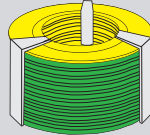

316LSS  
Green

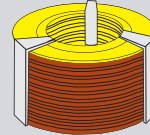

317L  
Maroon

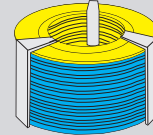

321SS  
Turquoise

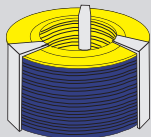

347SS  
Blue

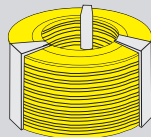

310SS  
No colour

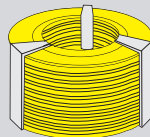

304LSS  
No colour

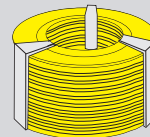

309SS  
No colour

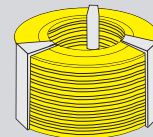

430SS  
No colour

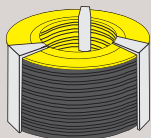

Alloy 20  
Black

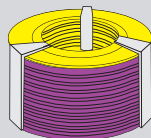

Titanium®  
Purple

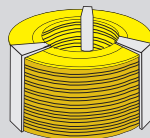

Inconel® 600/625  
Gold

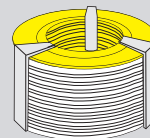

Incoloy® 800/825  
White

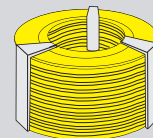

Inconel® X750  
No Colour

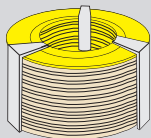

Hastelloy® C276  
Beige

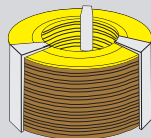

Hastelloy® B2  
Brown

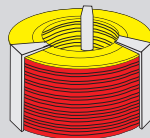

Nickel 200  
Red

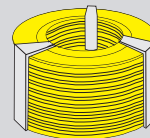

Zirconium  
No colour

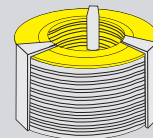

Carbon Steel  
Silver

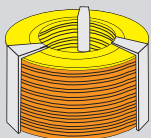

Monel®  
Orange

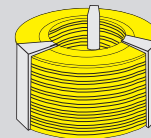

Duplex  
No colour

**Non Metallic Fillers**  
The gasket filler materials are designated by a number of stripes placed at equal intervals around the outside edge of the centering ring.

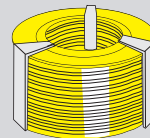

PTFE  
White Stripe

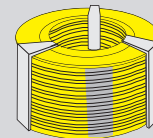

Flexicarb®  
Gray Stripe

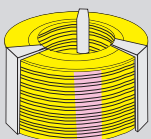

Flexite Super®  
Pink Stripe

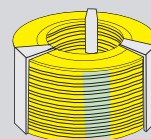

Ceramic  
Light Green Stripe

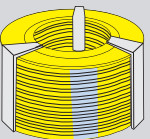

Thermiculite® 835  
Light Blue Stripe

# GASKET MATERIALS

METAL WINDING STRIP AS STANDARD		FILLER MATERIAL	GUIDE RING MATERIAL AS STANDARD
Stainless Steel	304	Flexicarb® flexible graphite	Carbon Steel
	316L	Thermiculite® 835	
<b>OTHERS</b>		Flexite Super®	<b>OTHERS</b>
Stainless Steel	304L	PTFE	Stainless Steel
	310	Ceramic	304
	316Ti	Non-sintered PTFE	304L
	317L		316
	321		316L
	347		316Ti
	430		310
	17-7PH		321
		Thermiculite®, FLEXITALLIC'S proprietary high-temperature, sealing material is comprised of chemically exfoliated and thermally exfoliated vermiculite.	347
Alloy 20			410
Monel®		This revolutionary patented product simulates the structure of exfoliated graphite but with one notable exception... gaskets made with Thermiculite® maintain their integrity, even at extreme temperatures.	Inconel®
Titanium®			600
Nickel® 200		Thermiculite® is thermally stable, ensuring against thermal oxidation, at temperatures in excess of 1000°C (Thermiculite® 835).	625
Inconel®	600		Monel®
	625		Titanium®
	X-750		Nickel®
Hastelloy®	B2		Incoloy®
	C276		800
Incoloy®	800		825
	825		Alloy 20
Duplex			Hastelloy®
Zirconium®			B2
Tantalum®			C276

## NOTES

Figures stated are for information only. Please refer to the current version of the original standards for dimensional information.

Selected materials should be compatible with operating temperature and chemicals. If in doubt, contact Flexitallic Technical Department.

We recommend a max continuous operating temperature of 260°C, above this decomposition starts to occur slowly, increasing rapidly above 400°C (750°C)

## IDENTIFICATION REQUIREMENTS

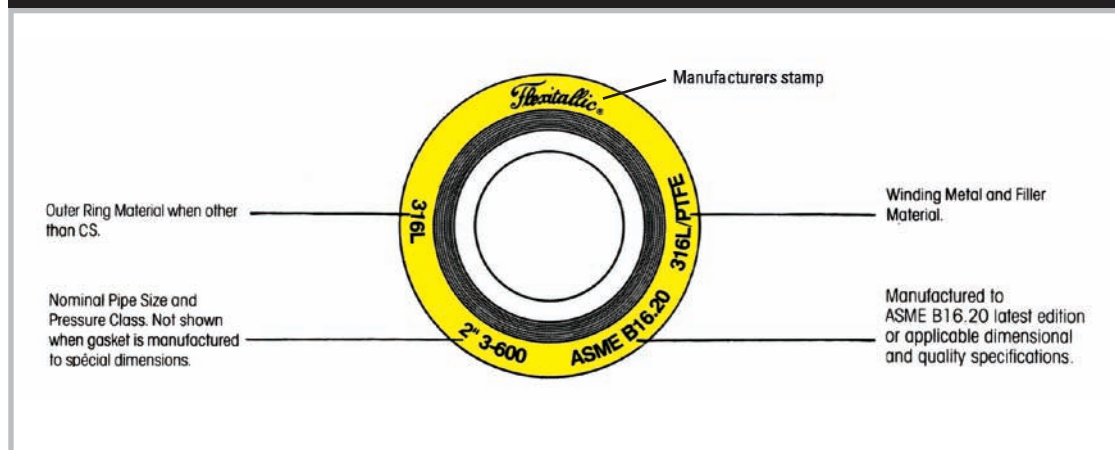

## GASKET SELECTION



**Style CG** – Is comprised of a sealing element and outer metal ring. The outer ring assists in locating the gasket on the mating flange faces and prevents over compression of the sealing element ensuring optimum sealing performance. Style CG gaskets are suitable for use on raised and flat faced flanged connections. Style CG gaskets are suitable for use in mild to moderate service conditions.

**Style CGI** – In addition to an outer metal ring the CGI style gasket is fitted with an inner metal ring, constraining the sealing element on both internal and external diameters. The inner ring functions as an additional compression stop and prevents inner buckling of the sealing element. It also creates a physical barrier between the sealing element and process stream shielding from heat and media while preventing erosion. Style CGI gaskets are suitable for use on raised and flat faced flanged connections and moderate to severe service conditions.

**Style R** – Is comprised of a sealing element, additional plies of metal are used at the start and termination of the winding process improving stability and sealing performance. Unlike other styles of spiral wound gasket compression of the sealing element is controlled by the use of the correct flange face configuration, style R gaskets are suitable for use on tongue and groove, male and female and flat to groove flanged connections.

**Style RIR** – Is comprised of a sealing element and inner metal ring. The inner ring functions as both a compression stop and creates a physical barrier between the sealing element and media stream. The inner ring is also designed to reduce turbulent flow, minimising flange erosion and prevents the build up debris in the annular space between the pipe bore and internal diameter of the gasket. Style RIR gaskets are suitable for use on male and female (spigot and recess) flanged connections.

Published as an indication of which Flexitallic spiral wound gasket best suits different pipe flange configurations and service conditions.

SELECTION GUIDE					
Flange Face					
	Raised Face	Flat Face	Male and Female	Tongue and Groove	Flat Face to Recess
Recommended Gasket Style For general duties					
	Style CG	Style CG	Style R	Style R	Style R
Recommended Gasket Style For high pressure/ temperature duty, also for gaskets with PTFE filler, corrosive or fluctuating pressure or temperature service conditions.					
	Style CGI	Style CGI	Style RIR	Style RIR	Style RIR

NOTES: Where style R gaskets are fitted it is essential that the flange is correctly dimensioned to provide a compression stop, as over compression can result in failure.



# STYLE CG & CGI GASKETS

Style CG

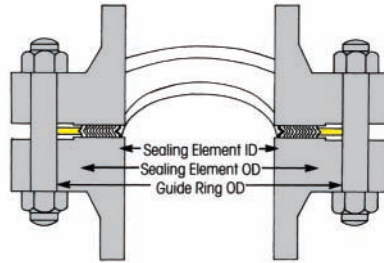

Style CGI

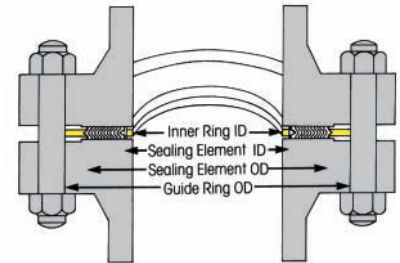

To suit standard raised face and flat face flanges.

All CG and CGI Gaskets for these standard flanges are 0.175 in (4.5mm) thick, fitted with 0.125 in (3.2mm) thick solid metal rings, unless otherwise stated.

### Special gaskets

Gaskets of special design can be engineered and fabricated using the same basic fundamentals of Flexitallic Spiral Wound Gasket design and construction to cover a wide range of applications in installations for which there are no industry-wide standards. Special gaskets have been designed for valves, pumps, compressors, turbines, boilers, heat exchangers, etc. Consult with Flexitallic engineers as early in the design stage as possible.

**Low Emission style Gaskets** are available, which conform to major oil refinery requirements in accordance with CFET March 2013 revision. Please speak to the Applications Engineering Department for further information.

**Note:** When using PTFE filler material, Spiral Wound Gaskets shall be fitted with an inner metal ring (i.e. style CGI).

Flexitallic style CG and CGI Spiral Wound Gaskets can be manufactured in accordance with all relevant gasket standards to suit the following flange designations.

Please note that gaskets for non-standard flanges are also readily available.

ASME B16.5  
ASME B16.47 Series A (MSS SP 44)  
ASME B16.47 Series B (API 605)  
BS 10  
BS 1560  
BS 4504  
BS EN 1092  
BS EN 1759  
DIN Flanges  
JIS Flanges

WHEN ORDERING PLEASE SPECIFY	EXAMPLE
Gasket style	Flexitallic Style "CGI" Spiral Wound Gasket
Nominal pipe size (NPS)	4"
Pressure rating	Class 900
Gasket standard	ASME B16.20
Winding materials	316L/Flexicarb (FG)
Outer ring material	Carbon Steel
Inner ring material	316L

## DIMENSIONAL DATA

### SPIRAL WOUND GASKETS

Dimensions to ASME B16.20  
to suit ASME B16.5 Flanges

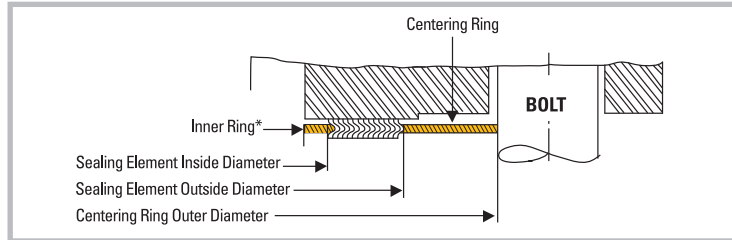
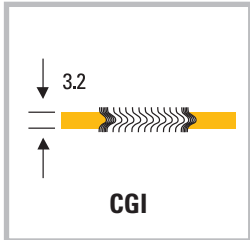
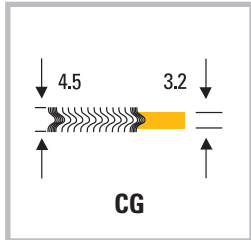

NOMINAL BORE	INNER RING ID						SEALING ELEMENT ID (1) (2)						SEALING ELEMENT OD						CENTERING RING OD (3)									
	#150	#300	#400 (5)	#600	#900 (5)	#1500	#2500 (5)	#150	#300	#400 (4)	#600	#900 (4)	#1500	#2500 (4)	#150	#300	#400	#600	#900	#1500	#2500	#150	#300	#400 (4)	#600	#900 (4)	#1500	#2500 (4)
mm																												
15	14.2	14.2	-	14.2	-	14.2	14.2	19.1	19.1	-	19.1	-	19.1	19.1	31.8	31.8	31.8	31.8	31.8	31.8	31.8	47.8	54.1	-	54.1	-	63.5	69.9
20	20.6	20.6	-	20.6	-	20.6	20.6	25.4	25.4	-	25.4	-	25.4	25.4	39.6	39.6	39.6	39.6	39.6	39.6	39.6	57.2	66.8	-	66.8	-	69.9	76.2
25	26.9	26.9	-	26.9	-	26.9	26.9	31.8	31.8	-	31.8	-	31.8	31.8	47.8	47.8	47.8	47.8	47.8	47.8	47.8	66.8	73.2	-	73.2	-	79.5	85.9
32	38.1	38.1	-	38.1	-	33.3	33.3	47.8	47.8	-	47.8	-	39.6	39.6	60.5	60.5	60.5	60.5	60.5	60.5	60.5	76.2	82.6	-	82.6	-	88.9	104.9
40	44.5	44.5	-	44.5	-	41.4	41.4	54.1	54.1	-	54.1	-	47.8	47.8	69.9	69.9	69.9	69.9	69.9	69.9	69.9	85.9	95.3	-	95.3	-	98.6	117.6
50	55.6	55.6	-	55.6	-	52.3	52.3	69.9	69.9	-	69.9	-	58.7	58.7	85.9	85.9	85.9	85.9	85.9	85.9	85.9	104.9	111.3	-	111.3	-	143.0	146.1
65	66.5	66.5	-	66.5	-	63.5	63.5	82.6	82.6	-	82.6	-	69.9	69.9	98.6	98.6	98.6	98.6	98.6	98.6	98.6	124.0	130.3	-	130.3	-	165.1	168.4
80	81.0	81.0	-	81.0	78.7	78.7	78.7	101.6	101.6	-	101.6	95.3	92.2	92.2	120.7	120.7	120.7	120.7	120.7	120.7	120.7	136.7	149.4	-	149.4	168.4	174.8	196.9
100	106.4	106.4	102.6	102.6	102.6	97.8	97.8	127.0	127.0	120.7	120.7	120.7	117.6	117.6	149.4	149.4	149.4	149.4	149.4	149.4	149.4	174.8	181.1	177.8	193.8	206.5	209.6	235.0
125	131.8	131.8	128.3	128.3	128.3	124.5	124.5	155.7	155.7	147.6	147.6	147.6	143.0	143.0	177.8	177.8	177.8	177.8	177.8	177.8	177.8	196.9	215.9	212.9	241.3	247.7	254.0	279.4
150	157.2	157.2	154.9	154.9	154.9	147.3	147.3	182.6	182.6	174.8	174.8	174.8	171.5	171.5	209.6	209.6	209.6	209.6	209.6	209.6	209.6	222.3	251.0	247.7	266.7	289.1	282.7	317.5
200	215.9	215.9	205.7	205.7	196.9	196.9	196.9	233.4	233.4	225.6	225.6	222.3	215.9	215.9	263.7	263.7	263.7	263.7	257.3	257.3	257.3	279.4	308.1	304.8	320.8	358.9	352.6	387.4
250	268.2	268.2	255.3	255.3	246.1	246.1	246.1	287.3	287.3	274.6	274.6	276.4	266.7	270.0	317.5	317.5	317.5	317.5	311.2	311.2	311.2	339.9	362.0	358.9	400.1	435.1	435.1	476.3
300	317.5	317.5	307.3	307.3	292.1	292.1	292.1	339.9	339.9	327.2	327.2	323.9	323.9	317.5	374.7	374.7	374.7	374.7	368.3	368.3	368.3	409.7	422.4	419.1	457.2	498.6	520.7	549.4
350	349.3	349.3	342.9	342.9	320.8	320.8	-	371.6	371.6	362.0	362.0	355.6	362.0	-	406.4	406.4	406.4	406.4	400.1	400.1	-	450.9	485.9	482.6	492.3	520.7	577.9	-
400	400.1	400.1	389.9	389.9	374.7	368.3	-	422.4	422.4	412.8	412.8	412.8	406.4	-	463.6	463.6	463.6	463.6	457.2	457.2	-	514.4	539.8	536.7	565.2	574.8	641.4	-
450	449.3	449.3	438.2	438.2	425.5	425.5	-	474.7	474.7	469.9	469.9	463.6	463.6	-	527.1	527.1	527.1	527.1	520.7	520.7	-	549.4	596.9	593.9	612.9	638.3	704.9	-
500	500.1	500.1	489.0	489.0	482.6	476.3	-	525.5	525.5	520.7	520.7	520.7	514.4	-	577.9	577.9	577.9	577.9	571.5	571.5	-	606.6	654.1	647.7	682.8	698.5	755.7	-
600	603.3	603.3	590.6	590.6	590.6	577.9	-	628.7	628.7	628.7	628.7	628.7	616.0	-	685.8	685.8	685.8	685.8	679.5	679.5	-	717.6	774.7	768.4	790.7	838.2	901.7	-

#### GENERAL NOTES

All dimensions are in mm.

Figures stated are for information only. Please refer to the current version of the original standards for dimensional information.

The gasket thickness tolerance is +/- .13 mm measured across the metallic portion of the gasket, not including the filler, which may protrude slightly beyond the metal.

The inner-ring thickness shall be 2.97mm to 3.33mm.

For sizes NPS 1/2 through NPS 3, the inside diameter tolerance is +/- 0.8mm; for larger sizes the inside diameter tolerance is +/- 1.5mm.

#### NOTES

- The gasket outside diameter tolerance for NPS 1/2 through to NPS 8 is +/-0.8mm; for NPS 10 through NPS 24 +1.5mm -0.8mm
- The gasket inside diameter tolerance for NPS 1/2 through to NPS 8 is +/-0.4mm; for NPS 10 through NPS 24 +/- 0.8mm
- The centering ring outside diameter tolerance is +/-0.8mm
- There are no Class 400 flanges in NPS 1/2 through NPS 3 (use Class 600), Class 900 flanges in NPS 1/2 through NPS 2 1/2 (use Class 1500), or Class 2500 flanges NPS 14 and larger
- There are no NPS 1/2 through NPS 3 Class 400 flanges (use Class 600), NPS 1/2 through NPS 2 1/2 Class 900 flanges (use Class 1500), or NPS 14 and larger Class 2500 flanges

# DIMENSIONAL DATA

## SPIRAL WOUND GASKETS

Dimensions to ASME B16.20  
to suit ASME B16.5 Flanges

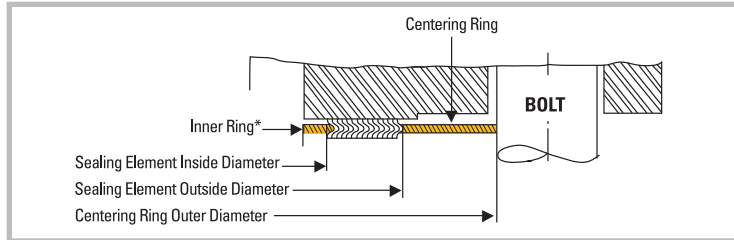
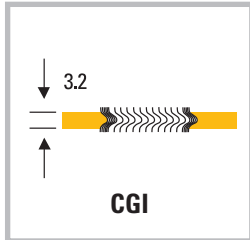
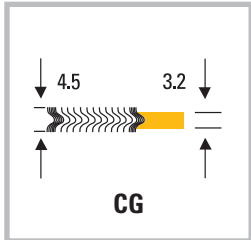

NOMINAL BORE	INNER RING ID						SEALING ELEMENT ID (1) (2)						SEALING ELEMENT OD						CENTERING RING OD (3)									
	#150	#300	#400 (5)	#600	#900 (5)	#1500	#2500 (5)	#150	#300	#400 (4)	#600	#900 (4)	#1500	#2500 (4)	#150	#300	#400	#600	#900	#1500	#2500	#150	#300	#400 (4)	#600	#900 (4)	#1500	#2500 (4)
1/2	0.56	0.56	-	0.56	-	0.56	0.56	0.75	0.75	-	0.75	-	0.75	0.75	1.25	1.25	1.25	1.25	1.25	1.25	1.25	1.88	2.13	-	2.13	0.00	2.50	2.75
3/4	0.81	0.81	-	0.81	-	0.81	0.81	1.00	1.00	-	1.00	-	1.00	1.00	1.56	1.56	1.56	1.56	1.56	1.56	1.56	2.25	2.63	-	2.63	0.00	2.75	3.00
1	1.06	1.06	-	1.06	-	1.06	1.06	1.25	1.25	-	1.25	-	1.25	1.25	1.88	1.88	1.88	1.88	1.88	1.88	1.88	2.63	2.88	-	2.88	0.00	3.13	3.38
1 1/4	1.50	1.50	-	1.50	-	1.31	1.31	1.88	1.88	-	1.88	-	1.56	1.56	2.38	2.38	2.38	2.38	2.38	2.38	2.38	3.00	3.25	-	3.25	0.00	3.50	4.13
1 1/2	1.75	1.75	-	1.75	-	1.63	1.63	2.13	2.13	-	2.13	-	1.88	1.88	2.75	2.75	2.75	2.75	2.75	2.75	2.75	3.38	3.75	-	3.75	0.00	3.88	4.63
2	2.19	2.19	-	2.19	-	2.06	2.06	2.75	2.75	-	2.75	-	2.31	2.31	3.38	3.38	3.38	3.38	3.38	3.38	3.38	4.13	4.38	-	4.38	0.00	5.63	5.75
2 1/2	2.62	2.62	-	2.62	-	2.50	2.50	3.25	3.25	-	3.25	-	2.75	2.75	3.88	3.88	3.88	3.88	3.88	3.88	3.88	4.88	5.13	-	5.13	0.00	6.50	6.63
3	3.19	3.19	-	3.19	3.10	3.10	3.10	4.00	4.00	-	4.00	3.75	3.63	3.63	4.75	4.75	4.75	4.75	4.75	4.75	4.75	5.38	5.88	-	5.88	6.63	6.88	7.75
4	4.19	4.19	4.04	4.04	4.04	3.85	3.85	5.00	5.00	4.75	4.75	4.75	4.63	4.63	5.88	5.88	5.88	5.88	5.88	5.88	5.88	6.88	7.13	7.00	7.63	8.13	8.25	9.25
5	5.19	5.19	5.05	5.05	5.05	4.90	4.90	6.13	6.13	5.81	5.81	5.81	5.63	5.63	7.00	7.00	7.00	7.00	7.00	7.00	7.00	7.75	8.50	8.38	9.50	9.75	10.00	11.00
6	6.19	6.19	6.10	6.10	6.10	5.80	5.80	7.19	7.19	6.88	6.88	6.88	6.75	6.75	8.25	8.25	8.25	8.25	8.25	8.25	8.25	8.75	9.88	9.75	10.50	11.38	11.13	12.50
8	8.50	8.50	8.10	8.10	7.75	7.75	7.75	9.19	9.19	8.88	8.88	8.75	8.50	8.50	10.38	10.38	10.38	10.38	10.13	10.13	10.13	11.00	12.13	12.00	12.63	14.13	13.88	15.25
10	10.56	10.56	10.05	10.05	9.69	9.69	9.69	11.31	11.31	10.81	10.81	10.88	10.50	10.63	12.50	12.50	12.50	12.50	12.25	12.25	12.25	13.38	14.25	14.13	15.75	17.13	17.13	18.75
12	12.50	12.50	12.10	12.10	11.50	11.50	11.50	13.38	13.38	12.88	12.88	12.75	12.75	12.50	14.75	14.75	14.75	14.75	14.50	14.50	14.50	16.13	16.63	16.50	18.00	19.63	20.50	21.63
14	13.75	13.75	13.50	13.50	12.63	12.63	-	14.63	14.63	14.25	14.25	14.00	14.25	-	16.00	16.00	16.00	16.00	15.75	15.75	-	17.75	19.13	19.00	19.38	20.50	22.75	-
16	15.75	15.75	15.35	15.35	14.75	14.50	-	16.63	16.63	16.25	16.25	16.25	16.00	-	18.25	18.25	18.25	18.25	18.00	18.00	-	20.25	21.25	21.13	22.25	22.63	25.25	-
18	17.69	17.69	17.25	17.25	16.75	16.75	-	18.69	18.69	18.50	18.50	18.25	18.25	-	20.75	20.75	20.75	20.75	20.50	20.50	-	21.63	23.50	23.38	24.13	25.13	27.75	-
20	19.69	19.69	19.25	19.25	19.00	18.75	-	20.69	20.69	20.50	20.50	20.50	20.25	-	22.75	22.75	22.75	22.75	22.50	22.50	-	23.88	25.75	25.50	26.88	27.50	29.75	-
24	23.75	23.75	23.25	23.25	23.25	22.75	-	24.75	24.75	24.75	24.75	24.75	24.25	-	27.00	27.00	27.00	27.00	26.75	26.75	-	28.25	30.50	30.25	31.13	33.00	35.50	-

### GENERAL NOTES

All dimensions are in inches.

Figures stated are for information only. Please refer to the current version of the original standards for dimensional information.

The gasket thickness tolerance is +/- .13 mm measured across the metallic portion of the gasket, not including the filler, which may protrude slightly beyond the metal.

The inner-ring thickness shall be 0.117 in to 0.131 in

For sizes NPS 1/2 through NPS 3, the insides diameter tolerance is +/- 0.03in; for larger sizes the inside diameter tolerance is +/- 0.06in.

### NOTES

1. The gasket outside diameter tolerance for NPS 1/2 through to NPS 8 is +/-0.03in for NPS 10 through NPS 24 +0.06in - 0.03in
2. The gasket inside diameter tolerance for NPS 1/2 through to NPS 8 is +/-0.016in; for NPS 10 through NPS 24 +/- 0.03in
3. The centering ring outside diameter tolerance is +/-0.03in
4. There are no Class 400 flanges in NPS 1/2 through NPS 3 (use Class 600), Class 900 flanges in NPS 1/2 through NPS 2 1/2 (use Class 1500), or Class 2500 flanges NPS 14 and larger
5. There are no NPS 1/2 through NPS 3 Class 400 flanges (use Class 600), NPS 1/2 through NPS 2 1/2 Class 900 flanges (use Class 1500), or NPS 14 and larger Class 2500 flanges

## DIMENSIONAL DATA

### STYLE CG & CGI GASKETS

Dimensions to suit ASME B16.5 & BS1560  
Small Diameter Screwed or Slip-on Flanges

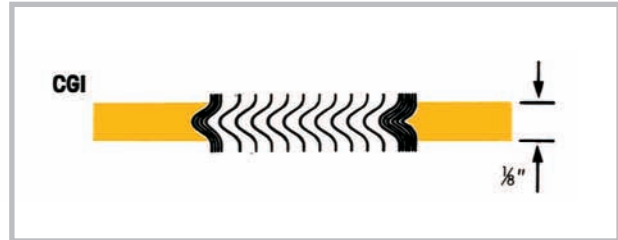
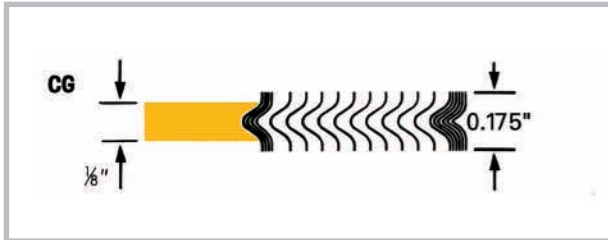

NOMINAL PIPE SIZE	INNER RING INSIDE DIAMETER		SEALING ELEMENT				GUIDE RING OUTSIDE DIAMETER											
			INSIDE DIA.		OUTSIDE DIA.		CLASS 150		CLASS 300		CLASS 400		CLASS 600		CLASS 900		CLASS 1500	
			INCHES	MM	INCHES	MM	INCHES	MM	INCHES	MM	INCHES	MM	INCHES	MM	INCHES	MM	INCHES	MM
1/4	-	-	0.56	14.3	0.88	22.2	1.75	44.5	1.75	44.5	1.75	44.5	1.75	44.5	-	-	-	-
1/2	0.56	14.3	0.94	23.8	1.25	31.8	1.88	47.6	2.13	54.0	2.13	54.0	2.13	54.0	2.50	63.5	2.50	63.5
3/4	0.81	20.6	1.19	30.2	1.56	39.7	2.25	57.2	2.63	66.7	2.63	66.7	2.63	66.7	2.75	69.9	2.75	69.9
1	1.06	27.0	1.44	36.5	1.88	47.6	2.63	66.7	2.88	73.0	2.88	73.0	2.88	73.0	3.13	79.4	3.13	79.4
1 1/4	1.38	34.9	1.88	47.6	2.38	60.3	3.00	76.2	3.25	82.6	3.25	82.6	3.25	82.6	3.50	88.9	3.50	88.9
1 1/2	1.63	41.3	2.13	54.0	2.75	69.9	3.38	85.7	3.75	95.3	3.75	95.3	3.75	95.3	3.88	98.4	3.88	98.4

#### GENERAL NOTES

All dimensions are in mm and inches.

#### NOTES

The above style CG & CGI Spiral Wound Gaskets are dimensioned to suit existing screwed or slip-on flanges for NPS 1/4 to 1-1/2 ASME B16.5 & BS 1560 flanges.

# DIMENSIONAL DATA

## SPIRAL WOUND GASKETS

Style CG & CGI ASME B16.20 Gaskets to suit ASME B16.47 Flanges Series A

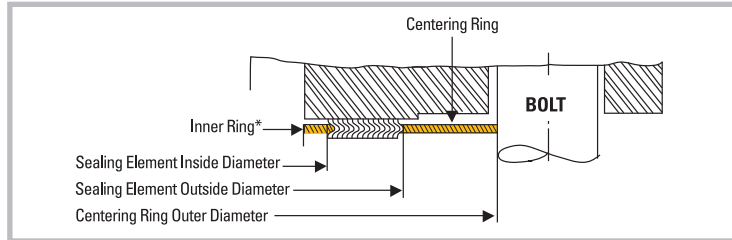
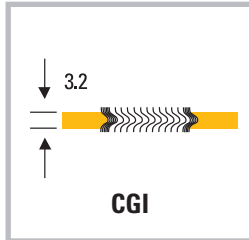
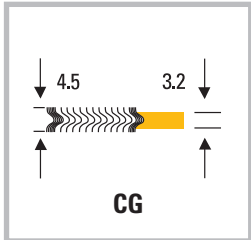

NOMINAL BORE	INNER RING ID					SEALING ELEMENT ID (2) (4)					SEALING ELEMENT OD (1) (4)					CENTERING RING OD (3) (4)				
	mm	#150	#300	#400	#600	#900 (4)	#150	#300	#400	#600	#900	#150	#300	#400	#600	#900	#150	#300	#400	#600
650	654.1	654.1	660.4	647.7	660.4	673.1	685.8	685.8	685.8	685.8	704.9	736.6	736.6	736.6	736.6	774.7	835.2	831.9	866.9	882.7
700	704.9	704.9	711.2	698.5	711.2	723.9	736.6	736.6	736.6	736.6	755.7	787.4	787.4	787.4	787.4	831.9	898.7	892.3	914.4	946.2
750	755.7	755.7	755.7	755.7	768.4	774.7	793.8	793.8	793.8	793.8	806.5	844.6	844.6	844.6	844.6	882.7	952.5	946.2	971.6	1009.7
800	806.5	806.5	812.8	812.8	812.8	825.5	850.9	850.9	850.9	850.9	860.6	901.7	901.7	901.7	901.7	939.8	1006.6	1003.3	1022.4	1073.2
850	857.3	857.3	863.6	863.6	863.6	876.3	901.7	901.7	901.7	901.7	911.4	952.5	952.5	952.5	952.5	990.6	1057.4	1054.1	1073.2	1136.7
900	908.1	908.1	917.7	917.7	920.8	927.1	955.8	955.8	955.8	958.9	968.5	1006.6	1006.6	1006.6	1009.7	1047.8	1117.6	1117.6	1130.3	1200.2
950	958.9	952.5	952.5	952.5	1009.7	977.9	977.9	971.6	990.6	1035.1	1019.3	1016.0	1022.4	1041.4	1085.9	1111.3	1054.1	1073.2	1104.9	1200.2
1000	1009.7	1003.3	1000.3	1009.7	1060.5	1028.7	1022.4	1025.7	1047.8	1098.6	1070.1	1070.1	1076.5	1098.6	1149.4	1162.1	1114.6	1127.3	1155.7	1251.0
1050	1060.5	1054.1	1051.1	1066.8	1111.3	1079.5	1073.2	1076.5	1104.9	1149.4	1124.0	1120.9	1127.3	1155.7	1200.2	1219.2	1165.4	1178.1	1219.2	1301.8
1100	1111.3	1104.9	1104.9	1111.3	1155.7	1130.3	1130.3	1130.3	1162.1	1206.5	1178.1	1181.1	1181.1	1212.9	1257.3	1276.4	1219.2	1231.9	1270.0	1368.6
1150	1162.1	1152.7	1168.4	1162.1	1219.2	1181.1	1178.1	1193.8	1212.9	1270.0	1228.9	1228.9	1244.6	1263.7	1320.8	1327.2	1273.3	1289.1	1327.2	1435.1
1200	1212.9	1209.8	1206.5	1219.2	1270.0	1231.9	1235.2	1244.6	1270.0	1320.8	1279.7	1286.0	1295.4	1320.8	1371.6	1384.3	1324.1	1346.2	1390.7	1485.9
1250	1263.7	1244.6	1257.3	1270.0	-	1282.7	1295.4	1295.4	1320.8	-	1333.5	1346.2	1346.2	1371.6	-	1435.1	1378.0	1403.4	1447.8	-
1300	1314.5	1320.8	1308.1	1320.8	-	1333.5	1346.2	1346.2	1371.6	-	1384.3	1397.0	1397.0	1422.4	-	1492.3	1428.8	1454.2	1498.6	-
1350	1358.9	1352.6	1352.6	1378.0	-	1384.3	1403.4	1403.4	1428.8	-	1435.1	1454.2	1454.2	1479.6	-	1549.4	1492.3	1517.7	1555.8	-
1400	1409.7	1403.4	1403.4	1428.8	-	1435.1	1454.2	1454.2	1479.6	-	1485.9	1505.0	1505.0	1530.4	-	1606.6	1543.1	1568.5	1612.9	-
1450	1460.5	1447.8	1454.2	1473.2	-	1485.9	1511.3	1505.0	1536.7	-	1536.7	1562.1	1555.8	1587.5	-	1663.7	1593.9	1619.3	1663.7	-
1500	1511.3	1524.0	1517.7	1530.4	-	1536.7	1562.1	1568.5	1593.9	-	1587.5	1612.9	1619.3	1644.7	-	1714.5	1644.7	1682.8	1733.6	-

### GENERAL NOTES

All dimensions are in mm.

Figures stated are for information only. Please refer to the current version of the original standards for dimensional information.

The gasket thickness tolerance is  $\pm 0.13$  mm measured across the metallic portion of the gasket, not including the filler, which may protrude slightly beyond the metal.

ASME B16.47 Series A flanges NPS 12 through NPS 24 have the same raised face dimensions as ASME B16.5 flanges.

The inner-ring thickness shall be 2.97 mm to 3.33 mm.

The inside diameter tolerance is  $\pm 3.0$  mm.

These inner rings are suitable for use with pipe walls 9.53 mm or thicker.

### NOTES

1. The gasket outside diameter tolerance for NPS 26 through NPS 60 is  $\pm 1.5$  mm

2. The gasket inside diameter tolerance for NPS 26 through NPS 34 is  $\pm 0.8$  mm; and the tolerance for NPS 36 through NPS 60 is  $\pm 1.5$  mm.

3. The centering ring outside diameter tolerance is  $\pm 0.8$  mm.

4. There are no Class 900 flanges NPS 50 and larger.

## DIMENSIONAL DATA

### SPIRAL WOUND GASKETS

Style CG & CGI ASME B16.20 Gaskets to suit ASME B16.47 Flanges Series A

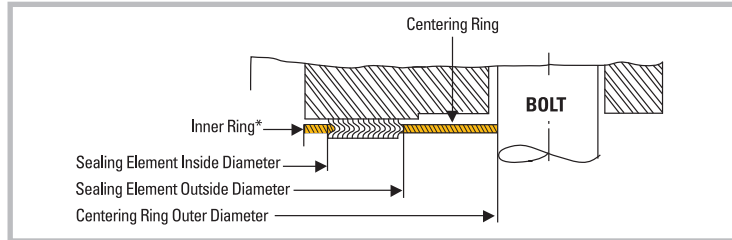
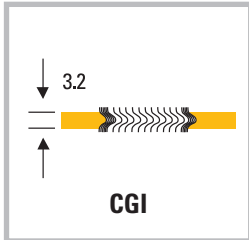
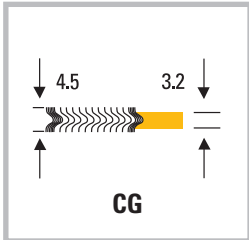

NOMINAL BORE	INNER RING ID					SEALING ELEMENT ID (2) (4)					SEALING ELEMENT OD (1) (4)					CENTERING RING OD (3) (4)				
	Inches	#150	#300	#400	#600	#900 (4)	#150	#300	#400	#600	#900	#150	#300	#400	#600	#900	#150	#300	#400	#600
26	25.75	25.75	26.00	25.50	26.00	26.50	27.00	27.00	27.00	27.00	27.75	29.00	29.00	29.00	29.00	30.50	32.88	32.75	34.13	34.75
28	27.75	27.75	28.00	27.50	28.00	28.50	29.00	29.00	29.00	29.00	29.75	31.00	31.00	31.00	31.00	32.75	35.38	35.13	36.00	37.25
30	29.75	29.75	29.75	29.75	30.25	30.50	31.25	31.25	31.25	31.25	31.75	33.25	33.25	33.25	33.25	34.75	37.50	37.25	38.25	39.75
32	31.75	31.75	32.00	32.00	32.00	32.50	33.50	33.50	33.50	33.50	33.88	35.50	35.50	35.50	35.50	37.00	39.63	39.50	40.25	42.25
34	33.75	33.75	34.00	34.00	34.00	34.50	35.50	35.50	35.50	35.50	35.88	37.50	37.50	37.50	37.50	39.00	41.63	41.50	42.25	44.75
36	35.75	35.75	36.13	36.13	36.25	36.50	37.63	37.63	37.63	37.75	38.13	39.63	39.63	39.63	39.75	41.25	44.00	44.00	44.50	47.25
38	37.75	37.50	37.50	37.50	39.75	38.50	38.50	38.25	39.00	40.75	40.13	40.00	40.25	41.00	42.75	43.75	41.50	42.25	43.50	47.25
40	39.75	39.50	39.38	39.75	41.75	40.50	40.25	40.38	41.25	43.25	42.13	42.13	42.38	43.25	45.25	45.75	43.88	44.38	45.50	49.25
42	41.75	41.50	41.38	42.00	43.75	42.50	42.25	42.38	43.50	45.25	44.25	44.13	44.38	45.50	47.25	48.00	45.88	46.38	48.00	51.25
44	43.75	43.50	43.50	43.75	45.50	44.50	44.50	44.50	45.75	47.50	46.38	46.50	46.50	47.75	49.50	50.25	48.00	48.50	50.00	53.88
46	45.75	45.38	46.00	45.75	48.00	46.50	46.38	47.00	47.75	50.00	48.38	48.38	49.00	49.75	52.00	52.25	50.13	50.75	52.25	56.50
48	47.75	47.63	47.50	48.00	50.00	48.50	48.63	49.00	50.00	52.00	50.38	50.63	51.00	52.00	54.00	54.50	52.13	53.00	54.75	58.50
50	49.75	49.00	49.50	50.00	-	50.50	51.00	51.00	52.00	-	52.50	53.00	53.00	54.00	-	56.50	54.25	55.25	57.00	-
52	51.75	52.00	51.50	52.00	-	52.50	53.00	53.00	54.00	-	54.50	55.00	55.00	56.00	-	58.75	56.25	57.25	59.00	-
54	53.50	53.25	53.25	54.25	-	54.50	55.25	55.25	56.25	-	56.50	57.25	57.25	58.25	-	61.00	58.75	59.75	61.25	-
56	55.50	55.25	55.25	56.25	-	56.50	57.25	57.25	58.25	-	58.50	59.25	59.25	60.25	-	63.25	60.75	61.75	63.50	-
58	57.50	57.00	57.25	58.00	-	58.50	59.50	59.25	60.50	-	60.50	61.50	61.25	62.50	-	65.50	62.75	63.75	65.50	-
60	59.50	60.00	59.75	60.25	-	60.50	61.50	61.75	62.75	-	62.50	63.50	63.75	64.75	-	67.50	64.75	66.25	68.25	-

#### GENERAL NOTES

All dimensions are in inches.

Figures stated are for information only. Please refer to the current version of the original standards for dimensional information.

The gasket thickness tolerance is  $\pm 0.005$ in measured across the metallic portion of the gasket, not including the filler, which may protrude slightly beyond the metal.

ASME B16.47 Series A flanges NPS 12 through NPS 24 have the same raised face dimensions as ASME B16.5 flanges.

#### NOTES

1. The gasket outside diameter tolerance for NPS 26 through NPS 60 is  $\pm 0.06$ in
2. The gasket inside diameter tolerance for NPS 26 through NPS 34 is  $\pm 0.03$ in and the tolerance for NPS 36 through NPS 60 is  $\pm 0.05$ in
3. The centering ring outside diameter tolerance is  $\pm 0.03$ in
4. There are no Class 900 flanges NPS 50 and larger.

# DIMENSIONAL DATA

## SPIRAL WOUND GASKETS

Style CG & CGI ASME B16.20 Gaskets to suit ASME B16.47 Flanges Series B

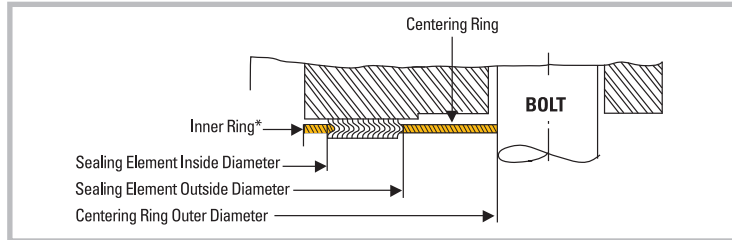
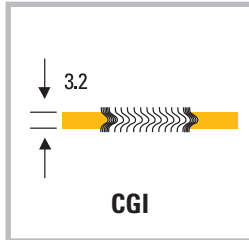
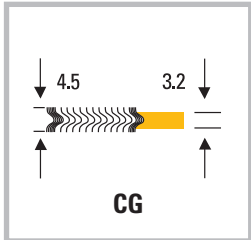

NOMINAL BORE	INNER RING ID					SEALING ELEMENT ID (2) (4)					SEALING ELEMENT OD (1) (4)					CENTERING RING OD (3) (4)				
	#150	#300	#400	#600	#900	#150 (4)	#300	#400	#600	#900	#150	#300	#400	#600	#900	#150	#300	#400	#600	#900
650	654.1	654.1	654.1	644.7	666.8	673.1	673.1	666.8	663.7	692.2	698.5	711.2	698.5	714.5	749.3	725.4	771.7	746.3	765.3	838.2
700	704.9	704.9	701.8	685.8	717.6	723.9	723.9	714.5	704.9	743.0	749.3	762.0	749.3	755.7	800.1	776.2	825.5	800.1	819.2	901.7
750	755.7	755.7	752.6	752.6	781.1	774.7	774.7	765.3	778.0	806.5	800.1	812.8	806.5	828.8	857.3	827.0	886.0	857.3	879.6	958.9
800	806.5	806.5	800.1	793.8	838.2	825.5	825.5	812.8	831.9	863.6	850.9	863.6	860.6	882.7	914.4	881.1	939.8	911.4	933.5	1016.0
850	857.3	857.3	850.9	850.9	895.4	876.3	876.3	866.9	889.0	920.8	908.1	914.4	911.4	939.8	971.6	935.0	993.9	962.2	997.0	1073.2
900	908.1	908.1	898.7	901.7	920.8	927.1	927.1	917.7	939.8	946.2	958.9	965.2	965.2	990.6	997.0	987.6	1047.8	1022.4	1047.8	1124.0
950	958.9	971.6	952.5	952.5	1009.7	974.9	1009.7	971.6	990.6	1035.1	1009.7	1047.8	1022.4	1041.4	1085.9	1044.7	1098.6	1073.2	1104.9	1200.2
1000	1009.7	1022.4	1000.3	1009.7	1060.5	1022.4	1060.5	1025.7	1047.8	1098.6	1063.8	1098.6	1076.5	1098.6	1149.4	1095.5	1149.4	1127.3	1155.7	1251.0
1050	1060.5	1085.9	1051.1	1066.8	1111.3	1079.5	1111.3	1076.5	1104.9	1149.4	1114.6	1149.4	1127.3	1155.7	1200.2	1146.3	1200.2	1178.1	1219.2	1301.8
1100	1111.3	1124.0	1104.9	1111.3	1155.7	1124.0	1162.1	1130.3	1162.1	1206.5	1165.4	1200.2	1181.1	1212.9	1257.3	1197.1	1251.0	1231.9	1270.0	1368.6
1150	1162.1	1178.1	1168.4	1162.1	1219.2	1181.1	1216.2	1193.8	1212.9	1270.0	1224.0	1254.3	1244.6	1263.7	1320.8	1255.8	1317.8	1289.1	1327.2	1435.1
1200	1212.9	1231.9	1206.5	1219.2	1270.0	1231.9	1263.7	1244.6	1270.0	1320.8	1270.0	1311.4	1295.4	1320.8	1371.6	1306.6	1368.6	1346.2	1390.7	1485.9
1250	1263.7	1267.0	1257.3	1270.0	-	1282.7	1317.8	1295.4	1320.8	-	1325.6	1355.9	1346.2	1371.6	-	1357.4	1419.4	1403.4	1447.8	-
1300	1314.5	1317.8	1308.1	1320.8	-	1333.5	1368.6	1346.2	1371.6	-	1376.4	1406.7	1397.0	1422.4	-	1408.2	1470.2	1454.2	1498.6	-
1350	1365.3	1365.3	1352.6	1378.0	-	1384.3	1403.4	1403.4	1428.8	-	1422.4	1454.2	1454.2	1479.6	-	1463.8	1530.4	1517.7	1555.8	-
1400	1422.4	1428.8	1403.4	1428.8	-	1444.8	1479.6	1454.2	1479.6	-	1478.0	1524.0	1505.0	1530.4	-	1514.6	1593.9	1568.5	1612.9	-
1450	1478.0	1484.4	1454.2	1473.2	-	1500.1	1535.2	1505.0	1536.7	-	1528.8	1573.3	1555.8	1587.5	-	1579.6	1655.8	1619.3	1663.7	-
1500	1535.2	1557.3	1517.7	1530.4	-	1557.3	1589.0	1568.5	1593.9	-	1586.0	1630.4	1619.3	1644.7	-	1630.4	1706.6	1682.8	1733.6	-

### GENERAL NOTES

All dimensions are in mm.

Figures stated are for information only. Please refer to the current version of the original standards for dimensional information.

The inner-ring thickness shall be 2.97 mm to 3.33 mm.

The inside diameter tolerance is +/-3.0 mm.

These Inner rings are suitable for use with pipe walls 9.53 mm or thicker.

The gasket thickness tolerance is +/-0.13mm measured across the metallic portion of the gasket, not including the filler, which may protrude slightly beyond the metal.

### NOTES

1. The gasket outside diameter tolerance for NPS 26 through NPS 60 is +/-1.5 mm
2. The gasket inside diameter tolerance for NPS 26 through NPS 34 is +/-0.8 mm, and the tolerance for NPS 36 through NPS 60 is +/-1.2 mm.
3. The centering ring outside diameter tolerance is +/-0.8 mm.
4. There are no Class 900 flanges NPS 50 and larger.

## DIMENSIONAL DATA

### SPIRAL WOUND GASKETS

Style CG & CGI ASME B16.20 Gaskets to suit ASME B16.47 Flanges Series B

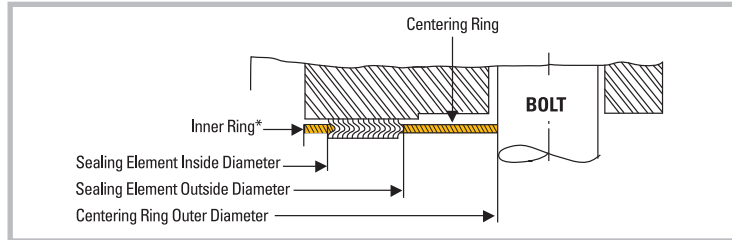
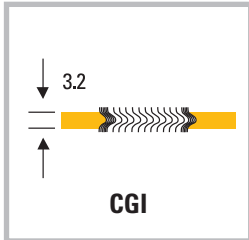
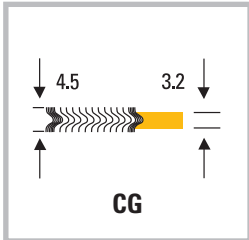

NOMINAL BORE	INNER RING ID					SEALING ELEMENT ID (2) (4)					SEALING ELEMENT OD (1) (4)					CENTERING RING OD (3) (4)				
	Inches	#150	#300	#400	#600	#900	#150 (4)	#300	#400	#600	#900	#150	#300	#400	#600	#900	#150	#300	#400	#600
26	25.75	25.75	25.75	25.38	26.25	26.50	26.50	26.25	26.13	27.25	27.50	28.00	27.50	28.13	29.50	28.56	30.38	29.38	30.13	33.00
28	27.75	27.75	27.63	27.00	28.25	28.50	28.50	28.13	27.75	29.25	29.50	30.00	29.50	29.75	31.50	30.56	32.50	31.50	32.25	35.50
30	29.75	29.75	29.63	29.63	30.75	30.50	30.50	30.13	30.63	31.75	31.50	32.00	31.75	32.63	33.75	32.56	34.88	33.75	34.63	37.75
32	31.75	31.75	31.50	31.25	33.00	32.50	32.50	32.00	32.75	34.00	33.50	34.00	33.88	34.75	36.00	34.69	37.00	35.88	36.75	40.00
34	33.75	33.75	33.50	33.50	35.25	34.50	34.50	34.13	35.00	36.25	35.75	36.00	35.88	37.00	38.25	36.81	39.13	37.88	39.25	42.25
36	35.75	35.75	35.38	35.50	36.25	36.50	36.50	36.13	37.00	37.25	37.75	38.00	38.00	39.00	39.25	38.88	41.25	40.25	41.25	44.25
38	37.75	38.25	37.50	37.50	39.75	38.37	39.75	38.25	39.00	40.75	39.75	41.25	40.25	41.00	42.75	41.13	43.25	42.25	43.50	47.25
40	39.75	40.25	39.38	39.75	41.75	40.25	41.75	40.38	41.25	43.25	41.88	43.25	42.38	43.25	45.25	43.13	45.25	44.38	45.50	49.25
42	41.75	42.75	41.38	42.00	43.75	42.50	43.75	42.38	43.50	45.25	43.88	45.25	44.38	45.50	47.25	45.13	47.25	46.38	48.00	51.25
44	43.75	44.25	43.50	43.75	45.50	44.25	45.75	44.50	45.75	47.50	45.88	47.25	46.50	47.75	49.50	47.13	49.25	48.50	50.00	53.88
46	45.75	46.38	46.00	45.75	48.00	46.50	47.88	47.00	47.75	50.00	48.19	49.38	49.00	49.75	52.00	49.44	51.88	50.75	52.25	56.50
48	47.75	48.50	47.50	48.00	50.00	48.50	49.75	49.00	50.00	52.00	50.00	51.63	51.00	52.00	54.00	51.44	53.88	53.00	54.75	58.50
50	49.75	49.88	49.50	50.00	-	50.50	51.88	51.00	52.00	-	52.19	53.38	53.00	54.00	-	53.44	55.88	55.25	57.00	-
52	51.75	51.88	51.50	52.00	-	52.50	53.88	53.00	54.00	-	54.19	55.38	55.00	56.00	-	55.44	57.88	57.25	59.00	-
54	53.75	53.75	53.25	54.25	-	54.50	55.25	55.25	56.25	-	56.00	57.25	57.25	58.25	-	57.63	60.25	59.75	61.25	-
56	56.00	56.25	55.25	56.25	-	56.88	58.25	57.25	58.25	-	58.18	60.00	59.25	60.25	-	59.63	62.75	61.75	63.50	-
58	58.19	58.44	57.25	58.00	-	59.07	60.44	59.25	60.50	-	60.19	61.94	61.25	62.50	-	62.19	65.19	63.75	65.50	-
60	60.44	61.31	59.75	60.25	-	61.31	62.56	61.75	62.75	-	62.44	64.19	63.75	64.75	-	64.19	67.19	66.25	68.25	-

#### GENERAL NOTES

All dimensions are in inches.

Figures stated are for information only. Please refer to the current version of the original standards for dimensional information.

The gasket thickness tolerance is  $\pm 0.005$ in measured across the metallic portion of the gasket, not including the filler, which may protrude slightly beyond the metal.

#### NOTES

1. The gasket outside diameter tolerance for NPS 26 through NPS 60 is  $\pm 0.06$ in
2. The gasket inside diameter tolerance for NPS 26 through NPS 34 is  $\pm 0.03$ in, and the tolerance for NPS 36 through NPS 60 is  $\pm 0.05$ in
3. The centering ring outside diameter tolerance is  $\pm 0.03$ in
4. There are no Class 900 flanges NPS 50 and larger



# DIMENSIONAL DATA

## SPIRAL WOUND GASKETS

Style CG & CGI Gaskets to BS EN 1514-2  
to suit BS EN 1092-1 Flanges

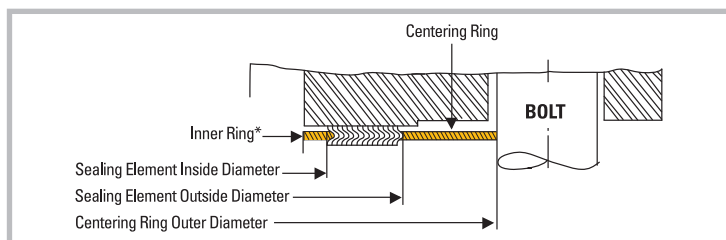
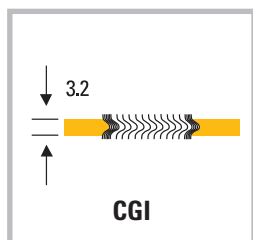
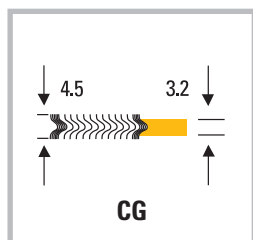

NOMINAL DIAMETER	INNER DIAMETER OF THE INNER RING	WIDTH OF THE INNER RING	INNER DIAMETER OF THE SEALING ELEMENT	WIDTH OF THE SEALING ELEMENT	INNER DIAMETER OF THE GUIDE RING	WIDTH OF THE SEALING ELEMENT	INNER DIAMETER OF THE GUIDE RING	OUTSIDE DIAMETER OF THE GUIDE RING TO EACH PRESSURE CLASS							
								PN10	PN16	PN25	DN40	PN63	PN100	PN160	
MM															
10	18	3	24	5	34	5	34	46	46	46	46	56	56	56	
15	23	3	29	5	39	5	39	51	51	51	51	61	61	61	
20	28	3	34	6	46	-	-	61	61	61	61	-	-	-	
25	35	3	41	6	53	6	53	71	71	71	71	82	82	82	
32	43	3	49	6	61	-	-	82	82	82	82	-	-	-	
40	50	3	56	6	68	6	68	92	92	92	92	103	103	103	
50	61	4.5	70	8	86	8	86	107	107	107	107	113	119	119	
65	77	4.5	86	8	102	10	106	127	127	127	127	137	143	143	
80	90	4.5	99	8	115	10	119	142	142	142	142	148	154	154	
100	115	6	127	8	143	10	147	162	162	168	168	174	180	180	
125	140	6	152	10	172	12	176	192	192	194	194	210	217	217	
150	167	6	179	10	199	12	203	218	218	224	224	247	257	257	
200	216	6	228	10	248	12	252	273	273	284	290	309	324	324	
250	267	6	279	12	303	14	307	327	329	340	352	364	391	388	
300	318	6	330	12	354	14	358	377	384	400	417	424	458	458	
350	360	8	376	12	400	14	404	437	444	457	474	486	512	-	
400	410	6	422	14	450	17	456	488	495	514	546	543	572	-	
500	510	6	522	14	550	17	556	593	617	624	628	657	704	-	
600	610	6	622	14	650	17	656	695	734	731	747	764	813	-	
700	710	6	722	17	756	20	762	810	804	833	852	879	950	-	
800	810	10	830	17	864	20	870	917	911	942	974	988	-	-	
900	910	10	930	17	964	20	970	1017	1011	1042	1084	1108	-	-	
1000	1010	10	1030	22	1074	25	1080	1124	1128	1154	1194	-	-	-	

### GENERAL NOTES

Dimensions in mm.

Figures stated are for information only. Please refer to the current version of the original standards for dimensional information.

The use of an inner ring is recommended for gaskets for use with PN100 Flanges and above.

Gasket dimensions are available to suit PN250 and above, consult the technical department.

Ref: EN1514-2 - standard

## DIMENSIONAL DATA

### STYLE R

Flexitallic dimensions for use with Male & Female and Tongue & Groove ASME 16.5 & BS EN1092

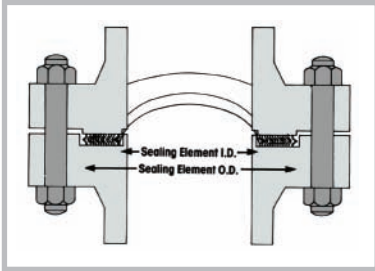

**Standard Style R** gaskets embody all the exclusive features of Flexitallic design for keeping compression values in balance with bolting and providing adequate resilience to compensate for variable stresses encountered in service. Standard Style R gaskets are manufactured to a nominal thickness of .125" (3.2mm). Optimum compression is in the range of .090" to .100" (2.3mm to 2.5mm) thick.

#### There are three types of Style R gaskets:

- (a) Style R-1 indicates gaskets for use with large male and female flanges.\*
- (b) Style R-3 indicates gaskets for use with large tongue and groove flanges.
- (c) Style R-4 indicates gaskets for use with small tongue and groove flanges.

*\*As a general rule, the use of Flexitallic Spiral Wound Gaskets with small male and female flange facings is not recommended.*

Dimensional limitations established by the proportions of the small tongue and groove facings limit the possibility of increasing gasket dimensions to improve the load carrying capacity in the higher pressure series. For this reason, it is suggested that large tongue and groove facings be selected for new construction when class 900, 1500 and 2500 flanges are to be used.

Style R-4 gaskets may be compressed an additional amount when exposed to the higher bolt loads, but not to the degree that the gasket will be crushed due to the radial support provided by the confining groove.

**Special Style R** gaskets are adaptable to non-standard flanges and can be designed and manufactured according to specifications for high and low pressure applications and for severe corrosive conditions.

When ordering special Style R gaskets for non-standard flanges and for special applications, contact the Applications Engineering Team.

NOMINAL PIPE SIZE	STYLE R1 FOR LARGE MALE & FEMALE								STYLE R3 FOR LARGE TONGUE & GROOVE				STYLE R4 FOR SMALL TONGUE & GROOVE			
	SEALING ELEMENT CLASS 150-1500				SEALING ELEMENT CLASS 2500				SEALING ELEMENT CLASS 150-2500				SEALING ELEMENT CLASS 150-2500			
	ID		OD		ID		OD		ID		OD		ID		OD	
	INCHES	MM	INCHES	MM	INCHES	MM	INCHES	MM	INCHES	MM	INCHES	MM	INCHES	MM	INCHES	MM
¼	0.50	12.7	1.00	25.4	-	-	-	-	0.50	12.7	1.00	25.4	-	-	-	-
½	1.00	25.4	1.38	34.9	0.19	20.6	1.38	34.9	1.00	25.4	1.38	34.9	1.00	25.4	1.38	35.1
¾	1.31	33.3	1.69	42.9	1.06	27.0	1.69	42.9	1.31	33.3	1.69	42.9	1.31	33.3	1.69	42.9
1	1.50	38.1	2.00	50.8	1.25	31.8	2.00	50.8	1.50	38.1	2.00	50.8	1.50	38.1	1.88	47.8
1 ¼	1.88	47.6	2.50	63.5	1.63	41.3	2.50	63.5	1.88	47.6	2.50	63.5	1.88	47.6	2.25	57.2
1 ½	2.12	54.0	2.88	73.0	1.88	47.6	2.88	73.0	2.12	54.0	2.88	73.0	2.12	54.0	2.50	63.5
2	2.88	73.0	3.62	92.1	2.38	60.3	3.62	92.1	2.88	73.0	3.62	92.1	2.88	73.0	3.25	82.6
2 ½	3.38	85.7	4.12	104.8	3.00	76.2	4.12	104.8	3.38	85.7	4.12	104.8	3.38	85.7	3.75	95.2
3	4.25	108.0	5.00	127.0	3.75	95.3	5.00	127.0	4.25	108.0	5.00	127.0	4.25	108.0	4.62	117.5
3 ½	4.75	120.6	5.50	139.7	-	-	-	-	4.75	120.6	5.50	139.7	4.75	120.6	5.12	130.2
4	5.19	131.8	6.19	157.2	4.75	120.7	6.19	157.2	5.19	131.8	6.19	157.2	5.19	131.8	5.69	144.5
4 ½	5.69	144.5	6.75	171.5	-	-	-	-	5.69	144.5	6.75	171.5	-	-	-	-
5	6.31	160.3	7.31	185.7	5.75	146.1	7.31	185.7	6.31	160.3	7.31	185.7	6.31	160.3	6.81	173.0
6	7.50	190.5	8.50	215.9	6.75	171.5	8.50	215.9	7.50	190.5	8.50	215.9	7.50	190.5	8.00	203.2
8	9.38	238.1	10.62	269.9	8.75	222.3	10.62	269.9	9.38	238.1	10.62	269.9	9.38	238.1	10.00	254.0
10	11.25	285.8	12.75	323.9	10.75	273.1	12.75	323.9	11.25	285.8	12.75	323.9	11.25	285.8	12.00	304.8
12	13.50	342.9	15.00	381.0	13.00	330.2	15.00	381.0	13.50	342.9	15.00	381.0	13.50	342.9	14.25	362.0
14	14.75	374.6	16.25	412.8	-	-	-	-	14.75	374.6	16.25	412.8	14.75	374.6	15.50	393.7
16	16.75	425.4	18.50	469.9	-	-	-	-	16.75	425.4	18.50	469.9	16.75	425.4	17.62	447.5
18	19.25	489.0	21.00	533.4	-	-	-	-	19.25	489.0	21.00	533.4	19.25	489.0	20.12	511.2
20	21.00	533.4	23.00	584.2	-	-	-	-	21.00	533.4	23.00	584.2	21.00	533.4	22.00	558.8
24	25.25	641.4	27.25	692.2	-	-	-	-	25.25	641.4	27.25	692.2	25.25	641.4	26.25	666.8

#### GENERAL NOTES

All dimensions are in mm and inches.

\*It is essential that Style R gaskets are fitted with a compression stop. Without a correctly dimensioned stop the gasket can easily be over-compressed resulting in failure. To provide a compression stop the depth of the tongue, groove or recess should be controlled to provide optimum compressed gasket thickness with metal to metal contact on the flange faces.

# DIMENSIONAL DATA

## SPIRAL WOUND GASKETS

Flexitallic dimensions for use with Large Male & Female ASME B16.5

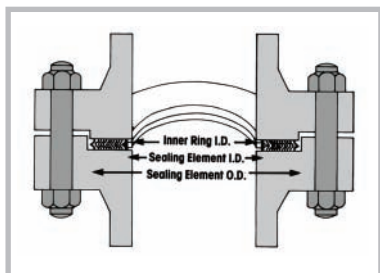

**Standard RIR** gaskets are manufactured to 0.125" (3.2mm) thickness. The gasket features a solid metal inner ring nominally 0.090" (2.3mm) thick, as an integrated part of its design. The inner ring provides a positive stop preventing the gasket from over compression and possible damage.

Special styles are available in other thickness.

NOMINAL PIPE SIZE	STYLE R1 FOR LARGE MALE AND FEMALE									
	INNER RING		SEALING ELEMENT CLASS 150 - 1500				SEALING ELEMENT CLASS 2500			
	ID		ID		OD		ID		OD	
	INCHES	MM	INCHES	MM	INCHES	MM	INCHES	MM	INCHES	MM
¼	-	-	0.50	12.7	1.00	25.4	-	-	-	-
½	0.56	14.2	1.00	25.4	1.38	34.9	0.81	20.6	1.38	34.9
¾	0.81	20.6	1.31	33.3	1.69	42.9	1.06	27.0	1.69	42.9
1	1.06	26.9	1.50	38.1	2.00	50.8	1.25	31.8	2.00	50.8
1 ¼	1.38	34.9	1.88	47.6	2.50	63.5	1.63	41.3	2.50	63.5
1 ½	1.63	41.3	2.12	54.0	2.88	73.0	1.88	47.6	2.88	73.0
2	2.06	52.4	2.88	73.0	3.62	92.1	2.38	60.3	3.62	92.1
2 ½	2.50	63.5	3.38	85.7	4.12	104.8	3.00	76.2	4.13	104.8
3	3.06	77.8	4.25	108.0	5.00	127.0	3.75	95.3	5.00	127.0
3 ½	3.56	90.5	4.75	120.6	5.50	139.7	-	-	-	-
4	4.06	103.2	5.19	131.8	6.19	157.2	4.75	120.7	6.19	157.2
4 ½	4.56	115.9	5.69	144.5	6.75	171.5	-	-	-	-
5	5.06	128.6	6.31	160.3	7.31	185.7	5.75	146.1	7.31	185.7
6	6.06	154.0	7.50	190.5	8.50	215.9	6.75	171.5	8.50	215.9
8	8.00	203.2	9.38	238.1	10.62	269.9	8.75	222.3	10.62	269.9
10	10.00	254.0	11.25	285.8	12.75	323.9	10.75	273.1	12.75	323.9
12	11.94	303.2	13.50	342.9	15.00	381.0	13.00	330.2	15.00	381.0
14	13.50	342.9	14.75	374.6	16.25	412.8	-	-	-	-
16	15.50	393.7	16.75	425.4	18.50	469.9	-	-	-	-
18	17.50	444.5	19.25	489.0	21.00	533.4	-	-	-	-
20	19.50	495.3	21.00	533.4	23.00	584.2	-	-	-	-
24	23.50	596.9	25.25	641.4	27.25	692.2	-	-	-	-

### GENERAL NOTES

All dimensions in mm and inches.

Figures stated are for information only. Please refer to the current version of the original standards for dimensional information.

## DIMENSIONAL DATA

### SPIRAL WOUND GASKETS

Dimensions to JIS B2404 for JIS B2220 & JIS B2238 - 2240 Flanges

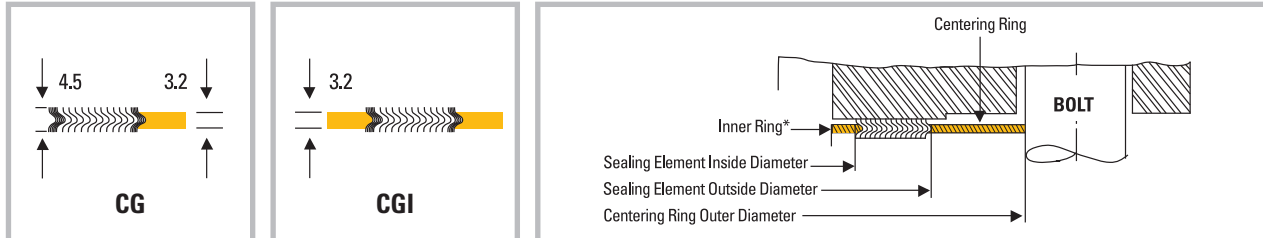

NOMINAL BORE	INNER RING ID (d1)					SEALING ELEMENT ID (d2)					SEALING ELEMENT OD (d3)					CENTERING RING OD (d4)				
	mm	10K	16 to 20K	30K	40K	63K	10K	16 to 20K	30K	40K	63K	10K	16 to 20K	30K	40K	63K	10K	16 to 20K	30K	40K
10	18.0	18.0	18.0	15.0	15.0	24.0	24.0	24.0	21.0	21.0	37.0	37.0	37.0	34.0	34.0	52.0	52.0	59.0	59.0	64.0
15	22.0	22.0	22.0	18.0	18.0	28.0	28.0	28.0	24.0	24.0	41.0	41.0	41.0	37.0	37.0	57.0	57.0	64.0	64.0	69.0
20	28.0	28.0	28.0	23.0	23.0	34.0	34.0	34.0	29.0	29.0	47.0	47.0	47.0	42.0	42.0	62.0	62.0	69.0	69.0	75.0
25	34.0	34.0	34.0	29.0	29.0	40.0	40.0	40.0	35.0	35.0	53.0	53.0	53.0	48.0	48.0	74.0	74.0	79.0	79.0	80.0
32	43.0	43.0	43.0	38.0	38.0	51.0	51.0	51.0	44.0	44.0	67.0	67.0	67.0	60.0	60.0	84.0	84.0	89.0	89.0	90.0
40	49.0	49.0	49.0	43.0	43.0	57.0	57.0	57.0	51.0	51.0	73.0	73.0	73.0	67.0	67.0	89.0	89.0	100.0	100.0	107.0
50	61.0	61.0	61.0	55.0	55.0	69.0	69.0	69.0	63.0	63.0	89.0	89.0	89.0	79.0	79.0	104.0	104.0	114.0	114.0	125.0
65	77.0	77.0	68.0	68.0	68.0	87.0	87.0	78.0	78.0	78.0	107.0	107.0	98.0	98.0	98.0	124.0	124.0	140.0	140.0	152.0
80	89.0	89.0	80.0	80.0	80.0	98.0	99.0	90.0	90.0	90.0	118.0	119.0	110.0	110.0	110.0	134.0	140.0	150.0	150.0	162.0
90	102.0	102.0	92.0	92.0	92.0	110.0	114.0	102.0	102.0	102.0	130.0	139.0	127.0	127.0	127.0	144.0	150.0	162.0	162.0	179.0
100	115.0	115.0	104.0	104.0	104.0	123.0	127.0	116.0	116.0	116.0	143.0	152.0	141.0	141.0	141.0	159.0	165.0	172.0	182.0	194.0
125	140.0	140.0	128.0	128.0	128.0	148.0	152.0	140.0	140.0	140.0	173.0	177.0	165.0	165.0	165.0	190.0	202.0	207.0	224.0	235.0
150	166.0	166.0	153.0	153.0	153.0	174.0	182.0	165.0	165.0	165.0	199.0	214.0	197.0	197.0	197.0	220.0	237.0	249.0	265.0	275.0
175	-	-	202.0	202.0	202.0	201.0	-	218.0	218.0	218.0	226.0	-	250.0	250.0	250.0	245.0	-	294.0	315.0	328.0
200	217.0	217.0	251.0	251.0	251.0	227.0	233.0	271.0	271.0	271.0	252.0	265.0	311.0	311.0	311.0	270.0	282.0	360.0	378.0	394.0
225	-	-	300.0	300.0	300.0	252.0	-	320.0	320.0	320.0	277.0	-	360.0	360.0	360.0	290.0	-	418.0	434.0	446.0
250	268.0	268.0	336.0	336.0	336.0	278.0	288.0	356.0	356.0	356.0	310.0	328.0	396.0	396.0	396.0	332.0	354.0	463.0	479.0	488.0
300	319.0	319.0	383.0	383.0	383.0	329.0	339.0	403.0	403.0	403.0	361.0	379.0	453.0	453.0	453.0	377.0	404.0	524.0	531.0	545.0
350	356.0	356.0	-	-	-	366.0	376.0	-	-	-	406.0	416.0	-	-	-	422.0	450.0	-	-	-
400	407.0	407.0	-	-	-	417.0	432.0	-	-	-	457.0	482.0	-	-	-	484.0	508.0	-	-	-
450	458.0	458.0	-	-	-	468.0	483.0	-	-	-	518.0	533.0	-	-	-	539.0	573.0	-	-	-
500	508.0	508.0	-	-	-	518.0	533.0	-	-	-	568.0	583.0	-	-	-	594.0	628.0	-	-	-
550	559.0	559.0	-	-	-	569.0	584.0	-	-	-	619.0	634.0	-	-	-	650.0	684.0	-	-	-
600	610.0	610.0	-	-	-	620.0	635.0	-	-	-	670.0	685.0	-	-	-	700.0	734.0	-	-	-

#### GENERAL NOTES

All dimensions are in mm.

Figures stated are for information only. Please refer to the current version of the original standards for dimensional information.

#### NOTES

With these dimensions the inner ring will not protrude into the bore of the pipe to be sealed.

# DIMENSIONAL DATA

## STYLE CG-RJ & CGI-RJ GASKETS

For use with ASME B16.5 and API 6A Ring Joint Flanges

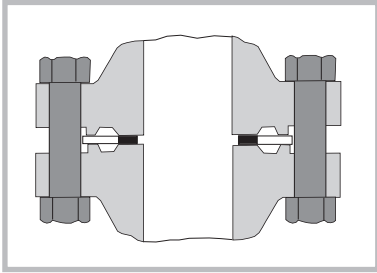

**CG-RJ and CGI-RJ** Spiral Wound Gaskets are designed for use, as a replacement maintenance item, of standard oval and octagonal ring joint gaskets. These gaskets are available for NPS ½ to 24 and pressure classes 150 to 1500. Gasket thickness is 0.175" (4.5mm) and the outer ring thickness is 0.125" (3.2mm).

**Style CGI-RJ gaskets** are fitted with an inner ring 0.125 (3.2mm) thick. Flexitallic recommends CGI-RJ gaskets for pressure classes 900 and above, and where operating temperatures are above 572 F (300 C). Consult our technical department for CGI-RJ gasket dimensions.

**Note:** Clearance dimensions between flange faces should be checked on close coupling pipework prior to installation of CG-RJ and CGI-RJ gaskets to ensure that optimum compression can be achieved without over stressing bolts and or flanges.

It is the user's responsibility to ensure that there is sufficient clearance between the flange bore and ring groove for proper seating of the gasket.

Dimensions are listed below for CG-RJ Spiral Wound Gaskets. Flexitallic's technical department should be consulted for CGI-RJ and API gasket sizes.

NOMINAL PIPE SIZE	PRESSURE CLASS																	
	150			300			400			600			900			1500		
	GASKET		RING	GASKET		RING	GASKET		RING	GASKET		RING	GASKET		RING	GASKET		RING
	ID	OD	OD	ID	OD	OD	ID	OD	OD	ID	OD	OD	ID	OD	OD	ID	OD	OD
½	-	-	-	0.69	1.06	2.13	0.69	1.06	2.13	0.69	1.06	2.13	0.69	1.06	2.50	0.69	1.06	2.50
¾	-	-	-	0.88	1.31	2.63	0.88	1.31	2.63	0.88	1.31	2.63	0.88	1.38	2.75	0.88	1.38	2.75
1	1.13	1.63	2.63	1.13	1.63	2.88	1.13	1.63	2.88	1.13	1.63	2.88	1.13	1.63	3.13	1.13	1.63	3.13
1 ¼	1.44	1.88	3.00	1.44	2.00	3.25	1.44	2.00	3.25	1.44	2.00	3.25	1.44	2.00	3.50	1.44	2.00	3.50
1 ½	1.69	2.19	3.38	1.69	2.38	3.75	1.69	2.38	3.75	1.69	2.38	3.75	1.69	2.38	3.88	1.69	2.38	3.88
2	2.13	2.88	4.13	2.13	2.75	4.38	2.13	2.75	4.38	2.13	2.75	4.38	2.25	3.25	5.63	2.25	3.25	5.63
2 ½	2.75	2.31	4.88	2.75	3.31	5.13	2.75	3.31	5.13	2.75	3.31	5.13	2.56	3.63	6.50	2.56	3.63	6.50
3	3.31	3.94	5.38	3.31	3.94	5.88	3.31	3.94	5.88	3.31	3.94	5.88	3.19	4.19	6.63	3.19	4.69	6.88
4	4.31	5.19	6.88	4.31	5.19	7.13	4.31	5.19	7.00	4.31	5.19	7.63	4.25	5.19	8.13	4.25	5.69	8.25
5	5.31	6.19	7.75	5.31	6.44	8.50	5.31	6.44	8.38	5.31	6.44	9.50	5.31	6.44	9.75	5.06	6.94	10.00
6	6.31	7.19	8.75	6.44	7.63	9.88	6.44	7.63	9.75	6.44	7.63	10.50	6.31	7.63	11.38	6.31	7.56	11.13
8	8.25	9.19	11.00	8.25	9.94	12.13	8.25	9.94	12.00	8.25	9.94	12.63	8.25	9.94	14.13	8.13	9.75	13.88
10	10.31	11.44	13.38	10.31	12.00	14.25	10.31	12.00	14.13	10.31	12.00	15.75	10.31	12.00	17.13	10.25	11.88	17.13
12	12.19	13.56	16.13	12.88	14.25	16.63	12.88	14.25	16.50	12.88	14.25	18.00	12.88	14.25	19.63	11.94	13.81	20.50
14	13.44	14.94	17.75	14.25	15.75	19.13	14.25	15.75	19.00	14.25	15.75	19.38	13.81	15.56	20.50	13.44	15.19	22.75
16	15.50	16.94	20.25	16.25	17.75	21.25	16.25	17.75	21.13	16.25	17.75	22.25	15.56	17.56	22.63	15.00	17.00	25.25
18	17.25	19.00	21.63	18.25	20.25	23.50	18.25	20.25	23.38	18.25	20.25	24.13	17.69	19.94	25.13	17.25	19.50	27.75
20	19.75	21.13	23.88	20.25	22.19	25.75	20.25	22.19	25.50	20.25	22.19	26.88	19.69	21.94	27.50	19.19	21.44	29.75
24	23.50	25.25	28.25	24.25	26.31	30.50	24.25	26.31	30.25	24.25	26.31	31.13	23.19	25.94	33.00	23.25	25.50	35.50

### GENERAL NOTES

All dimensions in inches.

## DIMENSIONAL DATA

### MAXIMUM BORE OF ASME B16.5 FLANGES

For use with CG & CGI Spiral Wound Gaskets

This table shows the maximum bore of flanges for which the Spiral Wound gasket dimensions shown are recommended considering the tolerances involved, possible eccentric installation, and the possibility that the gasket may extend into the assembled flange bore.

FLANGE SIZE (NPS)	PRESSURE CLASS								
	75	150	300	400	600	900	1500*	2500*	
1/2	No flanges	WN flange only <sup>a</sup>		No flanges Use Class 600	WN flange only <sup>a</sup>	No flanges Use Class 1500	WN flange only <sup>b</sup>		
3/4					WN flange only <sup>a</sup>				
1		SO flange <sup>c</sup> WN flange <sup>b</sup>		SO flange <sup>c</sup> WN flange <sup>b</sup>	SO flange <sup>c</sup> WN flange, any bore				
1-1/4									
1-1/2		SO flange <sup>c</sup> WN flange, any bore <sup>b</sup>		SO flange <sup>c</sup> WN flange, any bore					
2									
2-1/2		SO flange <sup>c</sup> WN flange, any bore		SO flange <sup>c</sup> WN flange, any bore	WN flange with SW bore (includes nozzle <sup>d</sup> but excludes SO flange)				
3									
4									
6		SO flange WN flange, any bore		WN flange with Schedule 10S bore described in ASME B36.19M (includes nozzle <sup>d</sup> but excludes SO flange)		WN Flange with Schedule 80 bore (excludes nozzle and SO flange)			
8									
10									
12		SO flange WN flange, any bore		WN flange with Schedule 10S bore described in ASME B36.19M (excludes nozzle <sup>d</sup> and SO flange) <sup>e</sup>		No flanges			
14									
16									
18									
20	SO flange WN flange, any bore		WN flange with Schedule 10S bore described in ASME B36.19M (excludes nozzle <sup>d</sup> and SO flange) <sup>e</sup>		No flanges				
24									

#### NOTES

SO = slip on and threaded; WN = welding neck; SW = standard wall.

<sup>a</sup> Inner rings are required for Class 900 gaskets, NPS 24; Class 1500 gaskets, NPS 12 through NPS 24; and Class 2500 gaskets; NPS 4 through NPS 12. These inner rings may extend into the pipe bore a maximum of 0.06 inch (1.5 millimeters) under the worst combination of maximum bore, eccentric installation, and additive tolerances.

<sup>b</sup> In these sizes the gasket is suitable for welding-neck flange with a standard-wall bore, if the gasket and the flanges are assembled concentrically. This also applies to nozzle. It is the user's responsibility to determine if the gasket is satisfactory for a flange of any larger bore.

<sup>c</sup> Gaskets in these sizes are suitable for slip-on flanges only if the gaskets and flanges are assembled concentrically.

<sup>d</sup> A nozzle is a long welding neck; the bore equals the flange NPS.

<sup>e</sup> An NPS 24 gasket is suitable for nozzles.

\* Spiral Wound gasket dimensions for use on screwed or slip-on flanges.

# TECHNICAL INFORMATION

## Assembly techniques.

### REQUIRED GASKET COMPRESSION

INITIAL GASKET THICKNESS mm	RECOMMENDED COMPRESSED THICKNESS mm
1.6	1.3/1.4
2.5	1.9/2.0
3.2	2.3/2.5
4.5	3.2/3.4
6.4	4.6/5.1
7.2	5.1/5.6

### Gasket Style Selection

Ensure that the correct style of gasket has been selected for the appropriate application.

All PTFE filled Spiral Wound Gaskets for raised face and flat face flanges should utilise an inner and outer guide ring. When using Style 'R' Spiral Wound Gaskets ensure that a compression stop is incorporated into the flange arrangement.

### Required Gasket Compression

For optimum sealing performance Flexitallic Spiral Wound Gaskets should be compressed to the thicknesses shown in the table left.

Spiral Wound Gaskets with internal or external guide rings i.e. Style CG and CGI, should be fully compressed to the guide ring. This will not damage the gasket or affect the sealing performance, since the rings are provided as a compression limiting stop.

### Flanges

Check that the flange faces are clean, in good condition and with a turned surface finish within the following range Ra 3.2 to 6.3 micro metres (125 to 250 micro inches).

### Bolting

Ensure that the correct bolting material is utilised to suit the operating conditions, taking into account the limitation of low yield strength bolts.

Ensure that the use of bolt lubrication is employed. For torque tightening methods Flexitallic recommends the use of molybdenum disulphide bolt lubrication or similar nickel based compound. Do not apply any lubricants when using PTFE coated fasteners. Consult with the coating manufacturers for product specific friction coefficients.

### Tightening Procedures

Controlled tightening procedures should be used when installing Spiral Wound Gaskets. Flexitallic recommends that the use of hydraulic tensioning equipment be considered where possible for bolt diameters 1-1/4" and above. Please refer to Flexitallic's Design Criteria for further technical information.

### STRESS RELAXATION OF BOLT STRESS & ALLOYS AT UPPER TEMPERATURE LIMITS

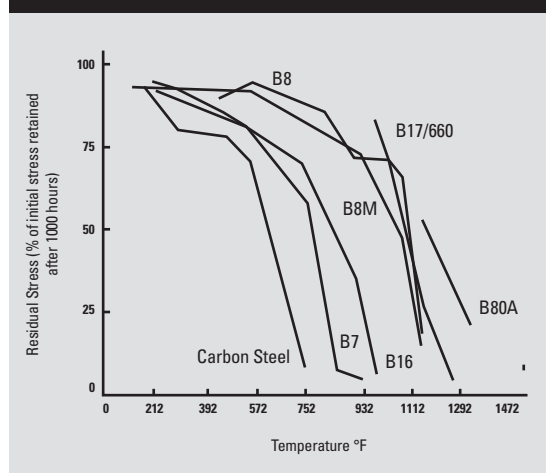

### THE IMPORTANCE OF BOLT LUBRICATION

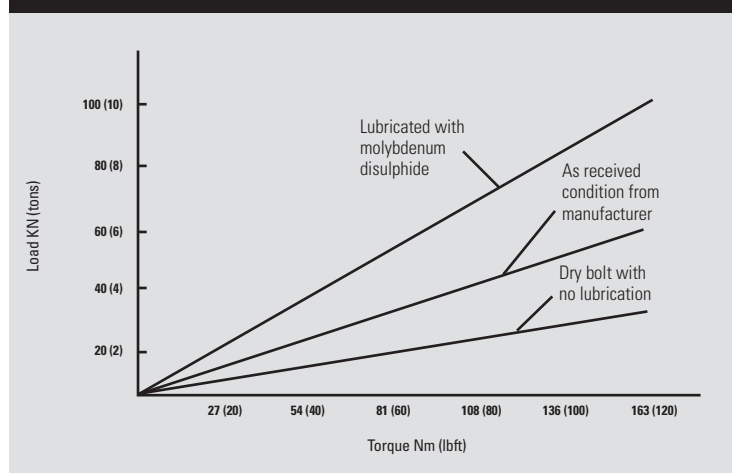

## INSTALLATION PROCEDURES

In order to ensure the optimum service life of metallic gasket materials, it is not only important to choose the correct material for the application but to install and maintain it correctly.

These guidelines are designed to assist the end user in the assembly of gasket materials.

### Installation of Metallic Gaskets

#### Flange Condition

- Remove the old gasket and check that the flange faces are clean and free from indentations and scoring. Radial (cross face) scoring is a particular concern and can lead to joint leakage
- For spiral wound gaskets, a surface finish of between 3.2µm to 6.3µm Ra (125 to 250 micro inch) is recommended. Use a surface comparator to check flange finishes.
- Check that the flange faces are parallel or that the pipework is sufficiently flexible to allow the flanges to be pulled parallel and concentric without excessive bolt loads.

#### Gasket

- Always use a new gasket
- Check that the gasket is in good condition and that the dimensions are correct for the class and size of the flanges
- Do not use jointing compounds, grease or lubricants with metallic gasket materials. These compounds can affect the contact friction between the gasket and the flange and can lead to creep and premature joint failure
- If there is a requirement to fix the gasket to the flange prior to assembly (e.g. large vertical flanges) then a light dusting of spray adhesive e.g. 3M 77 spray may be used. The adhesive should be applied sparingly and in isolated areas, and must be compatible with the fluid medium.

#### Bolting

- Ensure the bolt and nut threads are clean. Apply bolt lubrication to the bolt and nut threads and to the face of the nut to be tightened. Do not apply grease or bolt lubricant to the joint face. After cleaning and lubrication it should be possible to run the nut along the full length of the bolt by hand. If this is not possible the bolts and nuts should be refurbished or replaced
- Scrape, wire brush or file as necessary the back face of each flange where the bolt heads and nuts are to sit, ensuring that the surfaces are clean and flat
- If possible use hardened flat washers to ensure even transfer of the load.

#### Installation

- Ensure that the gasket is installed centrally
- It is recommended that the bolts are tightened using a controlled method such as torque or tension. If using a torque wrench, ensure that it is accurately calibrated
- Tighten bolts in a star-like crossing pattern in the following sequence
- Finger tighten nuts
- Tighten to 30% of the final load
- Tighten to 60% of the final load
- Tighten to full load
- Make a final tightening sequence, working around the flange, tightening each bolt in turn until the specified torque is achieved.

#### After Installation

Check that the flange faces are parallel using a suitable tool e.g. the Flange Gap Tool, which is available to purchase via The Academy of Joint Integrity ([www.academyofjointintegrity.com](http://www.academyofjointintegrity.com))



# TECHNICAL INFORMATION

## BOLTING DATA

For ASME B16.5 & BS 1560 Flanges

NOM PIPE SIZE (inches)	CLASS 150				CLASS 300				CLASS 400				CLASS 600			
	FLANGE DIAMETER	NO. OF BOLTS	BOLT DIAMETER	B.C. DIAMETER	FLANGE DIAMETER	NO. OF BOLTS	BOLT DIAMETER	B.C. DIAMETER	FLANGE DIAMETER	NO. OF BOLTS	BOLT DIAMETER	B.C. DIAMETER	FLANGE DIAMETER	NO. OF BOLTS	BOLT DIAMETER	B.C. DIAMETER
1/2	3.50	4	1/2	2.38	3.75	4	1/2	2.62	3.75	4	1/2	2.62	3.75	4	1/2	2.62
3/4	3.88	4	1/2	2.75	4.62	4	5/8	3.25	4.62	4	5/8	3.25	4.62	4	5/8	3.25
1	4.25	4	1/2	3.12	4.88	4	5/8	3.50	4.88	4	5/8	3.50	4.88	4	5/8	3.50
1 1/4	4.62	4	1/2	3.50	5.25	4	5/8	3.88	5.25	4	5/8	3.88	5.25	4	5/8	3.88
1 1/2	5.00	4	1/2	3.88	6.12	4	3/4	4.50	6.12	4	3/4	4.50	6.12	4	3/4	4.50
2	6.00	4	5/8	4.75	6.50	8	5/8	5.00	6.50	8	5/8	5.00	6.50	8	5/8	5.00
2 1/2	7.00	4	5/8	5.50	7.50	8	3/4	5.88	7.50	8	3/4	5.88	7.50	8	3/4	5.88
3	7.50	4	5/8	6.00	8.25	8	3/4	6.62	8.25	8	3/4	6.62	8.25	8	3/4	6.62
3 1/2	8.50	8	5/8	7.00	9.00	8	3/4	7.25	9.00	8	7/8	7.25	9.00	8	7/8	7.25
4	9.00	8	5/8	7.50	10.00	8	3/4	7.88	10.00	8	7/8	7.88	10.75	8	7/8	8.50
5	10.00	8	3/4	8.50	11.00	8	3/4	9.25	11.00	8	7/8	9.25	13.00	8	1	10.50
6	11.00	8	3/4	9.50	12.50	12	3/4	10.62	12.50	12	7/8	10.62	14.00	12	1	11.50
8	13.50	8	3/4	11.75	15.00	12	7/8	13.00	15.00	12	1	13.00	16.50	12	1 1/8	13.75
10	16.00	12	7/8	14.25	17.50	16	1	15.25	17.50	16	1 1/8	15.25	20.00	16	1 1/4	17.00
12	19.00	12	7/8	17.00	20.50	16	1 1/8	17.75	20.50	16	1 1/4	17.75	22.00	20	1 1/4	19.25
14	21.00	12	1	18.75	23.00	20	1 1/8	20.25	23.00	20	1 1/4	20.25	23.75	20	1 3/8	20.75
16	23.50	16	1	21.25	25.50	20	1 1/4	22.50	25.50	20	1 3/8	22.50	27.00	20	1 1/2	23.75
18	25.00	16	1 1/8	22.75	28.00	24	1 1/4	24.75	28.00	24	1 3/8	24.75	29.25	20	1 3/8	25.75
20	27.50	20	1 1/8	25.00	30.50	24	1 1/4	27.00	30.50	24	1 1/2	27.00	32.00	24	1 3/8	28.50
24	32.00	20	1 1/4	29.50	36.00	24	1 1/2	32.00	36.00	24	1 3/4	32.00	37.00	24	1 3/8	33.00

### GENERAL NOTES

Flange Diameter and Bolt Diameter dimensions are in inches. Figures stated are for information only. Please refer to the current version of the original standards for dimensional information.

NOM PIPE SIZE (inches)	CLASS 900				CLASS 1500				CLASS 2500			
	FLANGE DIAMETER	NO. OF BOLTS	BOLT DIAMETER	B.C. DIAMETER	FLANGE DIAMETER	NO. OF BOLTS	BOLT DIAMETER	B.C. DIAMETER	FLANGE DIAMETER	NO. OF BOLTS	BOLT DIAMETER	B.C. DIAMETER
1/2	4.75	4	3/4	3.25	4.75	4	3/4	3.25	5.25	4	3/4	3.50
3/4	5.12	4	3/4	3.50	5.12	4	3/4	3.50	5.50	4	3/4	3.75
1	5.88	4	7/8	4.00	5.88	4	7/8	4.00	6.25	4	7/8	4.25
1 1/4	6.25	4	7/8	4.38	6.25	4	7/8	4.38	7.25	4	1	5.13
1 1/2	7.00	4	1	4.88	7.00	4	1	4.88	8.00	4	1 1/8	5.75
2	8.50	8	7/8	6.50	8.50	8	7/8	6.50	9.25	8	1	6.75
2 1/2	9.62	8	1	7.50	9.62	8	1	7.50	10.50	8	1 1/8	7.75
3	9.50	8	7/8	7.50	10.50	8	1 1/8	8.00	12.00	8	1 1/4	9.00
4	11.50	8	1 1/8	9.25	12.25	8	1 1/4	9.50	14.00	8	1 1/2	10.75
5	13.75	8	1 1/4	11.00	14.75	8	1 1/2	11.50	16.50	8	1 3/4	12.75
6	15.00	12	1 1/8	12.50	15.50	12	1 3/8	12.50	19.00	8	2	14.50
8	18.50	12	1 3/8	15.50	19.00	12	1 3/8	15.50	21.75	12	2	17.25
10	21.50	16	1 3/8	18.50	23.00	12	1 3/8	19.00	26.50	12	2 1/2	21.25
12	24.00	20	1 3/8	21.00	26.50	16	2	22.50	30.00	12	2 3/4	24.38
14	25.25	20	1 1/2	22.00	29.50	16	2 1/4	25.00	-	-	-	-
16	27.75	20	1 3/8	24.25	32.50	16	2 1/2	27.75	-	-	-	-
18	31.00	20	1 3/8	27.00	36.00	16	2 3/4	30.50	-	-	-	-
20	33.75	20	2	29.50	38.75	16	3	32.75	-	-	-	-
24	41.00	20	2 1/2	35.50	46.00	16	3 1/2	39.00	-	-	-	-

### GENERAL NOTES

Flange Diameter and Bolt Diameter dimensions are in inches. Figures stated are for information only. Please refer to the current version of the original standards for dimensional information.

## TECHNICAL INFORMATION

### FACING DIMENSIONS

For ASME B16.5 & BS 1560 Flanges

Class 150, 300, 400, 600, 900, 1500 and 2500

NOM PIPE SIZE (inches)	OUTSIDE DIAMETER See note 3			I.D. OF LARGE & SMALL TONGUE See Notes 3 & 5	OUTSIDE DIAMETER See note 3			I.D. OF LARGE & SMALL GROOVE See Notes 3 & 5	HEIGHT		DEPTH OF GROOVE OR FEMALE
	RAISED FACE, LAPPED, LARGE MALE, & LARGE TONGUES See Note 5	SMALL MALE See Notes 4 & 5	SMALL TONGUE See Note 5		LARGE FEMALE & LARGE GROOVE See Note 5	SMALL FEMALE See Notes 4 & 5	SMALL GROOVE See Note 5		RAISED FACE CLASS 150 & 300 See Note 1	RAISED FACE LARGE & SMALL MALE & TONGUE CLASS 400, 600, 900, 1500 & 2500 See Note 2	
1/2	1.38	0.72	1.38	1.00	1.44	0.78	1.44	0.94	0.06	0.25	0.19
3/4	1.69	0.94	1.69	1.31	1.75	1.00	1.75	1.25	0.06	0.25	0.19
1	2.00	1.19	1.88	1.50	2.06	1.25	1.94	1.44	0.06	0.25	0.19
1-1/4	2.50	1.50	2.25	1.88	2.56	1.56	2.31	1.81	0.06	0.25	0.19
1-1/2	2.88	1.75	2.50	2.12	2.94	1.81	2.56	2.06	0.06	0.25	0.19
2	3.62	2.25	3.25	2.88	3.69	2.31	3.31	2.81	0.06	0.25	0.19
2-1/2	4.12	2.69	3.75	3.38	4.19	2.75	3.81	3.31	0.06	0.25	0.19
3	5.00	3.31	4.62	4.25	5.06	3.38	4.69	4.19	0.06	0.25	0.19
3-1/2	5.50	3.81	5.12	4.75	5.56	3.88	5.19	4.69	0.06	0.25	0.19
4	6.19	4.31	5.69	5.19	6.25	4.38	5.75	5.12	0.06	0.25	0.19
5	7.31	5.38	6.81	6.31	7.38	5.44	6.88	6.25	0.06	0.25	0.19
6	8.50	6.38	8.00	7.50	8.56	6.44	8.06	7.44	0.06	0.25	0.19
8	10.62	8.38	10.00	9.38	10.69	8.44	10.06	9.31	0.06	0.25	0.19
10	12.75	10.50	12.00	11.25	12.81	10.56	12.06	11.19	0.06	0.25	0.19
12	15.00	12.50	14.25	13.50	15.06	12.56	14.31	13.44	0.06	0.25	0.19
14	16.25	13.75	15.50	14.75	16.31	13.81	15.56	14.69	0.06	0.25	0.19
16	18.50	15.75	17.62	16.75	18.56	15.81	17.69	16.69	0.06	0.25	0.19
18	21.00	17.75	20.12	19.25	21.06	17.81	20.19	19.19	0.06	0.25	0.19
20	23.00	19.75	22.00	21.00	23.06	19.81	22.06	20.94	0.06	0.25	0.19
24	27.25	23.75	26.25	25.25	27.31	23.81	26.31	25.19	0.06	0.25	0.19

#### GENERAL NOTES

Flange Diameter and Bolt Diameter dimensions are in inches.

Figures stated are for information only.

Please refer to the current version of the original standards for dimensional information.

#### NOTES

1. Regular facing for class 150 and 300 steel flanged fittings and companion flange standards is a 0.06in raised face. Classes 400, 600, 900, 1500, and 2500 pipe flanges and fittings are regularly furnished with a 0.25in raised face. In all cases the raised face must be added to the minimum flange thickness.
2. Regular facing for class 400, 600, 900, 1500, and 2500 flange thickness dimensions.
3. Tolerance of plus or minus 0.016in. is allowed on the inside and outside diameters of all facings.
4. For small male and female joints care should be taken in the use of these dimensions to insure that pipe used is thick enough to permit sufficient bearing surface to prevent the crushing of the gasket. The dimensions apply particularly on lines where the joint is made on the end of the pipe. Screwed companion flanges for small male and female joints are furnished with plain face and are threaded with American Standard Locknut Thread.
5. Gaskets for male-female and tongue-groove joints shall cover the bottom of the recess with minimum clearances taking into account the tolerances prescribed in Note 3.

# SPECIAL APPLICATION GASKETS

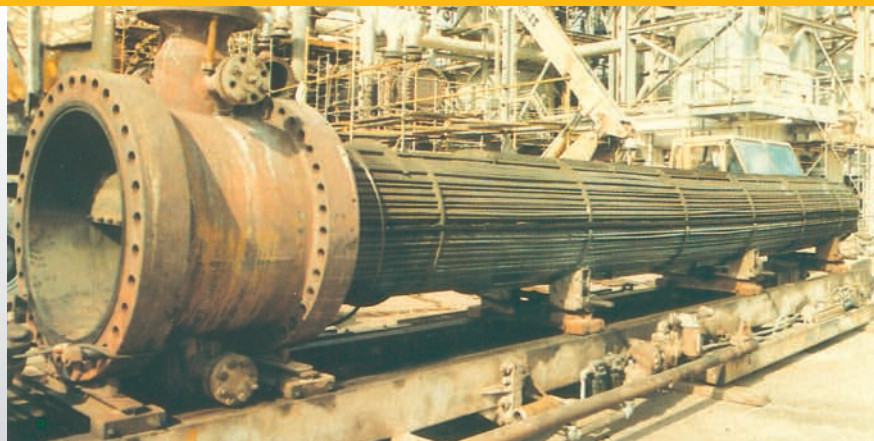

## Heat Exchanger Gaskets.

### Exchanger Gaskets with Spiral Wound Outer Ring (ALTERNATIVES HE-CG, HE-CGI)

Flexitallic special HE-CGI Gaskets with spiral wound outer ring are primarily designed for TEMA male and female flanges and are custom built to suit the design conditions of individual heat exchanger vessels. These gaskets are available in an extensive range of materials.

This style incorporates several special features, as follows:

1. The outer wound nose to ensure correct sealing element location in the flange recess.
2. A spiral wound sealing element to ensure a positive seal under fluctuating temperature and pressure conditions.
3. A solid metal inner ring to protect the sealing element and act as a compression stop. As an optional extra, inner rings can also be supplied with nylon location screws to secure the gasket to the flange on assembly.
4. Can be supplied with pass partition bars in any configuration. Pass bars are secured to the inner ring and can be supplied in either solid metal or double jacketed construction.

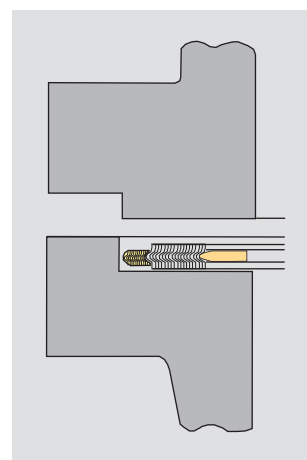

**STYLE HX-RIR**

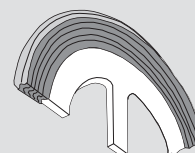

### HEAT EXCHANGERS WITH FLAT FACE OR RAISED FACE FLANGES SHOULD UTILISE STYLE CG AND CGI SPIRAL WOUND GASKETS

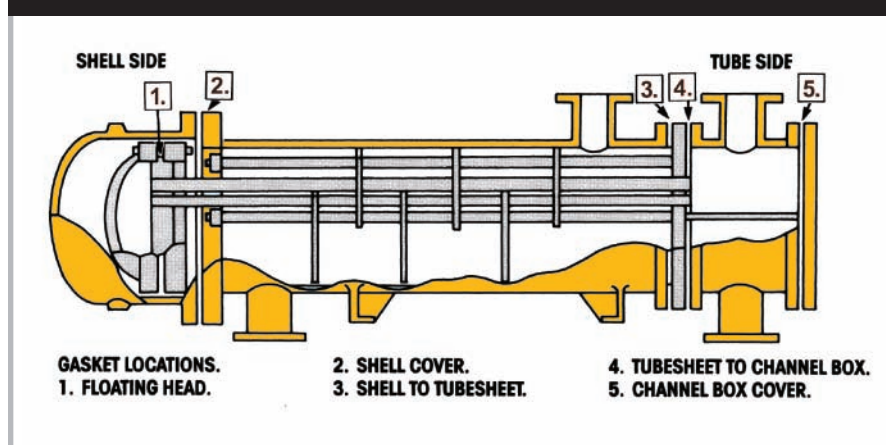

## SPECIAL APPLICATION GASKETS



### Carrier Ring Gaskets.

The **carrier ring** concept consists of a solid metal ring with a machined recess in each face. Spiral Wound Gaskets are then located in each of the machined recesses.

This type of arrangement has been successfully used in sealing problematic flanges and vessels in the nuclear, power and petrochemical industries. The major benefits of the carrier ring assembly are due to the double spiral wound gasket being present. This results in a very high recovery gasket, ensuring that the bolt load is maintained on the sealing elements when arduous pressure / temperature cycling occurs in service, thus maintaining a seal.

Carrier rings can be used on flat face, raised face or tongue and groove type flange, as well as non standard flange configurations. They can be supplied for both small and large diameter nominal bores up to class 2500 pressure rating. Carrier rings are also tailor made to suit specific flange arrangements and design conditions.

#### Typical Applications

The carrier ring concept has been extensively used in the power generation industries, petrochemical and nuclear industries.

Typical applications are as follows:

##### Heat Exchanger

Operating Pressure: 2900 psi  
Temperature: 200°C  
Tube Sheet

##### H.P. Heaters, Fossil Fired Generators, H.O.T. Construction, Steam Service

Operating Pressure: 700 psi  
Temperature: 370°C

##### Materials Utilised

316L/Flexicarb®  
17-7PH/Flexicarb®  
Inc X750 HT (Special high recovery material)

##### Catalytic Crackers

720°C, Regenerators, 2980 mm OD  
Hydrocarbon Service, Refineries



# SPECIAL APPLICATION GASKETS

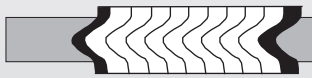

**Traditional Spiral Wound Gasket with Inner Ring**



**LSI Gasket**

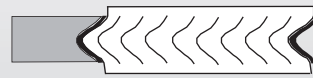

**LS Gasket**

## Style LS™ & LSI Low Stress Range of Spiral Wound Gaskets.

The **LS gasket** offers the same high integrity seal associated with the spiral wound gasket however, the LS and LSI has been designed in such a way that compression and sealing requirements are achieved under very low seating stresses. These gaskets are intended for use on class 150 and 300 applications, where customers traditionally do not use Spiral Wound Gaskets due to concerns about exceeding allowable design stresses.

The traditional spiral wound gasket has its steel windings protruding above the compression stop; this requires a significant loading stress to compress the gasket to its optimum operating thickness.

The LS and LSI gaskets have only soft Flexicarb® or PTFE filler protruding above metal windings and guide ring; therefore as the gasket is compressed, the Flexicarb® or PTFE filler is readily compressed thus producing the sealing mechanism at an earlier stage as compared to the conventionally manufactured spiral wound gasket.

The **“LSI” gasket** retains more of its initial stress or tightness, even when subjected to high temperatures, unlike PTFE sheet gaskets.

Available in a variety of metals, engineered to suit specific applications.

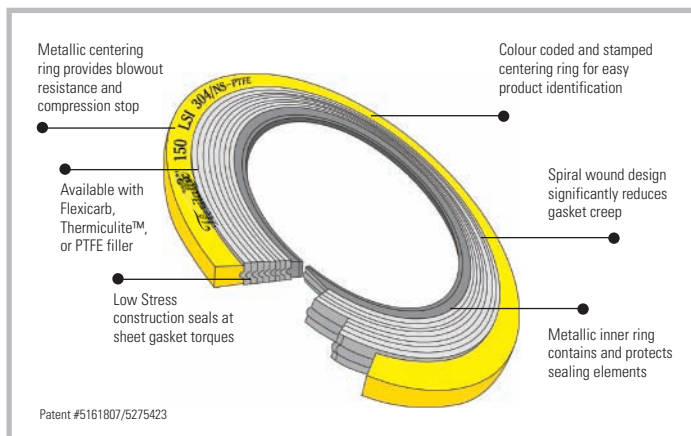

### FLEXITALLIC LSI VS. PTFE SHEET

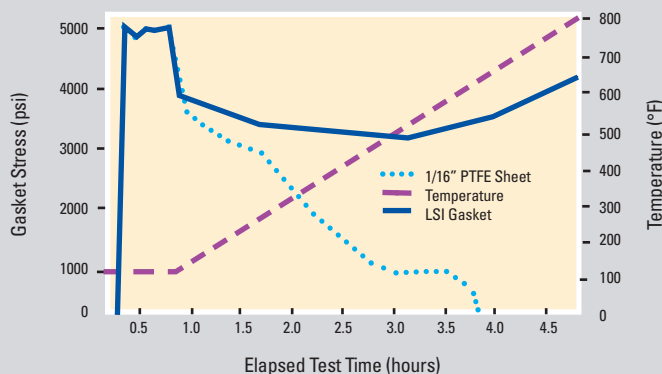

### LOWER BOLT STRESS-REDUCED FUGITIVE EMISSIONS

Flexitallic recommend minimum bolt torque figures for use with the 'LSI' gasket on ASME/B16.5 Flanges.\*

NPS (in)	N/m	NPS (in)	N/m
1/2	34	5	111
3/4	34	6	111
1	34	8	111
1 1/4	34	10	178
1 1/2	34	12	178
2	67	14	273
2 1/2	67	16	273
3	67	18	395
3 1/2	67	20	397
4	67	24	559

Note: Minimum Required torques may be even lower depending on gasket size and bolt materials. Please contact Flexitallic's Technical Department for more information.

\*Above torque values are for class 150 ASME flanges  
Torque values for 300# available on request

### GENERAL NOTES

Dimensions in mm.

Figures stated are for information only. Please refer to the current version of the original standards for dimensional information.

Please select correct gasket style for your particular application. See page 6 "Gasket Selection".

## SPECIAL APPLICATION GASKETS



Standard Style M



Style T Pear



Style T Square

### For Boiler Cap and Manhole Cover Assemblies.

#### Style M & MC & MCS

Spiral Wound Gaskets for Boiler Manhole Cover Assemblies.

The Flexitallic manhole gasket spiral constructions incorporate modified compression values to provide seating loads within the normal range of cover assemblies.

#### Size/Range Specification

Available in circular, obround, and oval shapes to suit standard manhole plate configurations.



STYLE M GASKETS

STYLE MC GASKETS

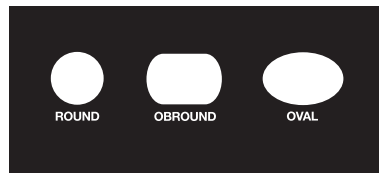

ROUND

OBROUND

OVAL

#### Style T

Spiral Wound Gaskets for Boiler Handhole and Tubecap Assemblies.

The design features of the basic Flexitallic spiral wound construction alleviate the need for sealing compound. Particularly suitable where old and pitted faces have rendered other gaskets ineffective.

#### Size/Range Specification

Available in several standard shapes:

Supplied in thicknesses of 3.2mm (0.125in.) or 4.5mm (0.175 in.).

The standard thickness of 4.5mm (0.175in.) is recommended for use in assemblies where the seat is relatively broad and bolting load is low.



BASIC SPIRAL CONSTRUCTION OF STYLE T GASKETS

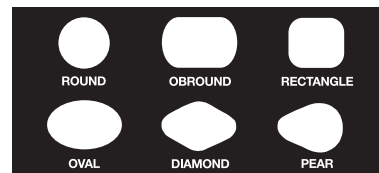

ROUND

OBROUND

RECTANGLE

OVAL

DIAMOND

PEAR

Gaskets for boiler handhole, tubecap and manhole covers incorporating the unique Flexitallic Spiral Wound profile and specially manufactured with Flexicarb® filler, are ideal for corrosive, high pressure or temperature duties. Flexitallic's anticipation of developments in modern steam generating and engineering equipment and ability to design to specific requirements are the guarantee of the perfect seal at minimum maintenance cost with consistently high standards of performance.

- High safety factor related to specific operating conditions
- Compression loadings proportional to safe stresses of cover assemblies
- Resilient under concentrated and fluctuating loads
- Prolonged trouble-free service
- Reduced seat cleaning time

#### Materials

Standard materials are Type 304 Stainless Steel and Flexicarb windings. Special materials to suit specific operating conditions are available.

#### To Order

With all orders or inquiries please submit the following:

- a) Name of boiler or equipment manufacturer
- b) Gasket style
- c) Dimensions of gasket
- d) Gasket thickness
- e) Flange width of gasket
- f) Pressure service rating
- g) Gasket material preference

# SPECIAL APPLICATION GASKETS



*Thermiculite® 835 Spiral Wound Gasket with Heat Treated Inconel X-750 Winding*

Thermiculite® 835 Heat Treated Inconel X-750 Spiral Wound Gasket.

Increased safety.  
Proven results.  
Proven cost savings.

### Severe cyclic conditions?

For the most demanding cyclic conditions, the choice is Flexitallic's Thermiculite® 835 Spiral Wound Gasket with Heat Treated Inconel X-750 winding.

Differential thermal expansion and contraction of components in a bolted joint, due to the effects of cyclic conditions, requires that extra resiliency be built into the joint or the gasket to compensate for fluctuating load conditions.

Normal gasket materials do not provide sufficient resiliency, and therefore cannot compensate for the adverse effects of cyclic conditions. Special Heat Treated Inconel X-750 gasket materials have been developed by Flexitallic to ensure that joint integrity is maintained during thermal cycles.

In OEM and End User testing comparing the performance of standard 316L SS windings vs. Heat Treated Inconel X-750 windings (precipitation hardened), HT Inconel X-750 winding material significantly increased the yield strength resulting in increased springback before leakage, or usable recovery.

Specify Flexitallic's proprietary precipitation hardened Inconel X-750 windings in applications where there are concerns about:

- Cyclic conditions
- Differential thermal expansion and contraction
- Radial shear
- Bolt relaxation
- Hot torquing
- Mating flanges of dissimilar metals

**When ordering this material it is important that you specify Precipitation Hardened Inconel X750 Windings, or Inconel X750HT.**

### FULL SCALE TEST RESULTS (AVERAGED) GASKET DIMENSIONS 1032 x 1067 x 4.5

Winding Material	316L SS	Heat Treated Inconel X-750
Initial Thickness	4.5	4.5
Compressed Thickness	3.1	3.1
Total Springback	0.3	0.3
Spingback to Leakage @ 2500 psi Test Pressure	0.1	0.2



*Ethylene Cracker Unit*

## SPECIAL APPLICATION GASKETS

### Low Emission Gasket.

**The Flexitallic Low Emission gasket** is a high performance spiral wound gasket that has been specially engineered to exceed stringent oil and gas industry fugitive emissions requirements, such as those found in the Chevron Fugitive Emissions Test (CFET).

Gaskets to suit standard ASME B16.5 and B16.47 flanged connections remain diametrically unchanged and in this respect are dimensionally compliant with ASME B16.20. Enhanced sealing performance is achieved by modification of the sealing element. The key design features are specification of the filler thickness range 0.36 to 0.41mm; ASME B16.20 does not specify filler thickness and typically 0.5mm thick is used. In addition filler protrusion is specified to be within the range of 0.2 to 1.0mm above the metal winding; resulting in a thicker sealing element.

Compression requirements for LE gaskets are different from those specified in ASME B16.20 that stipulates a compressed sealing element

thickness for a given bolt stress irrespective of pressure class. LE gaskets are required to compress within specified limits based on directly applied gasket stress. Gaskets made to LE construction requirements are designed to compress to between 0.76 and 1.27mm above the guide ring thickness when subjected to a compressive stress of 128 MPa (see diagram A, left).

Independent testing in accordance with the CEFT protocol has shown that Flexitallic LE gaskets comfortably exceed allowable fugitive emissions leakage levels. Leakage testing of ASME Class 150 CGI spiral wound gaskets in accordance with the PVRC ROTT procedure shows that Flexitallic LE gaskets require significantly lower bolt stress to achieve a T3 tightness class (see diagram B, below).

For more information regarding Flexitallic Low Emission spiral wound gaskets please contact the Flexitallic Applications Engineering Team.

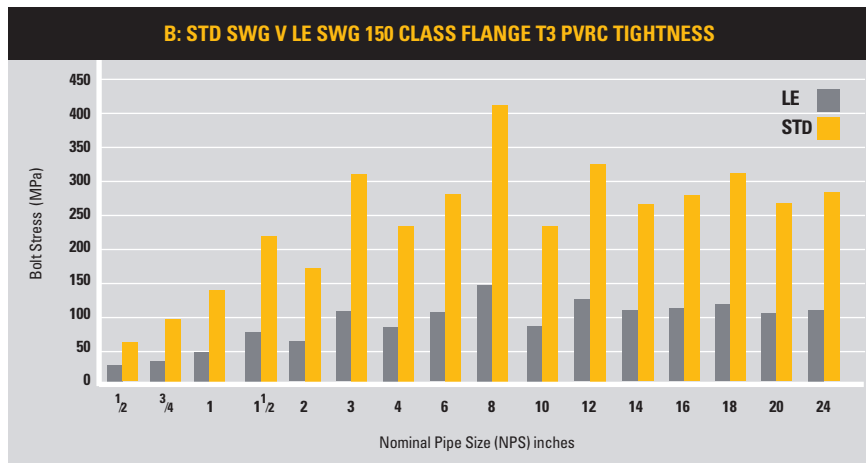
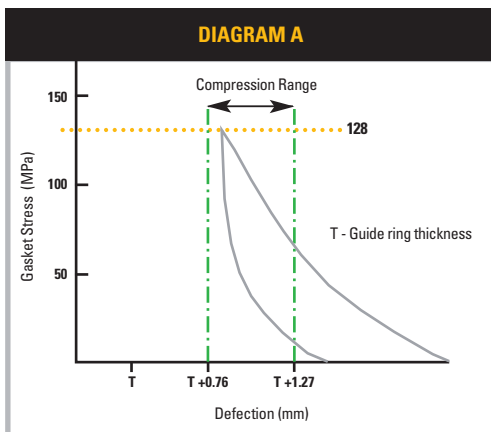



# SPECIAL APPLICATION GASKETS

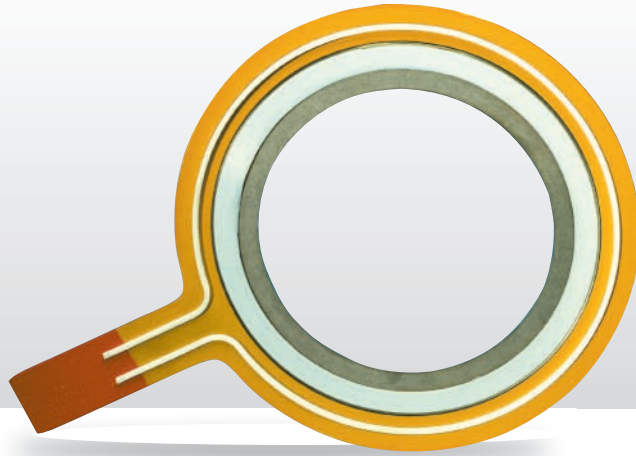

The Baker Gasket.  
For HF Acid & other  
hazardous chemical  
applications.

### Problem

A leak occurs on HF service

- HF can attack the bolts causing bolt failure.
- A small emission goes undetected.

### Solution

- Prevents HF attacking the bolts.
- Early detection of small leaks.
- Containment of HF emissions.
- Improves maintenance (detect & repair).
- Requires no modification to the flanges.
- Designed to suit Class 150 & 300 flanges.
- Contains no respirable fibers.

### What are the benefits?

The Baker gasket offers the user the reliability of a spiral wound gasket with the additional back-up of an emissions containment system should a leak occur. Reduced maintenance costs through an improved 'Detect & Repair' program. Improvements in plant operators Health & Safety profile.

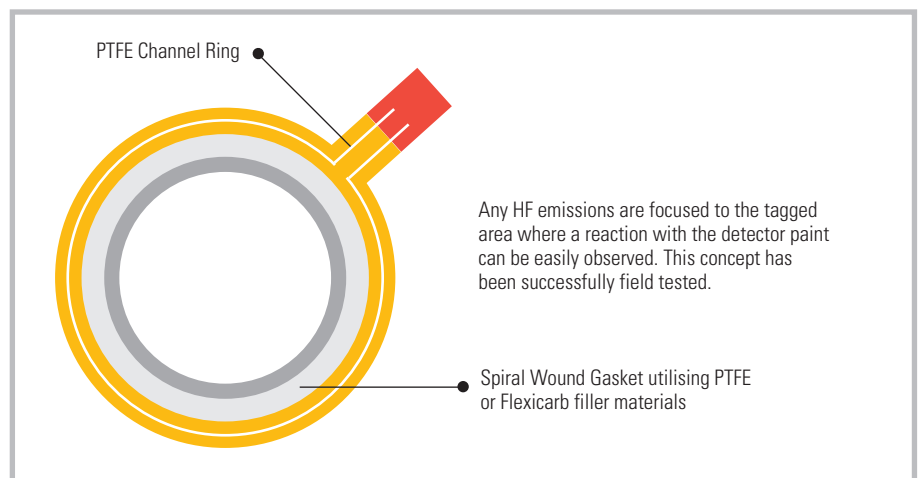
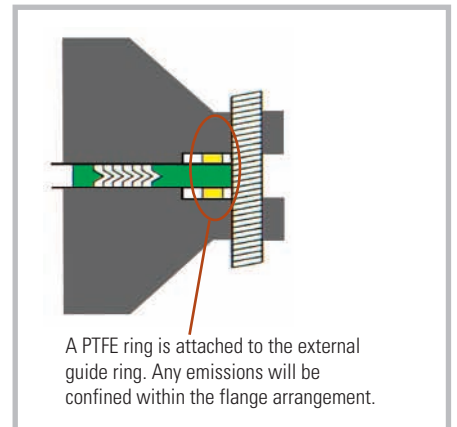

## THE ACADEMY OF JOINT INTEGRITY



Flexitallic can offer speciality training and consultancy via The Academy of Joint Integrity.



“Fundamental to successful joint integrity is the training of the personnel involved in the process of inspection, assembly and tightening of bolted connections.

The Academy provides a range of cost effective tailored training courses to suit the needs of the client or contractor.”

**Gary Milne**  
Technical Training Manager

### Training Courses

The Academy of Joint Integrity offers Accredited and Awareness Training Courses to all personnel who are involved in the assembly and tightening of flanged bolted connections. Mentoring and assessment programmes also complement the training provision. All our training courses are given by industry professionals who themselves have current and relevant industry-based experience.

The Academy is a member of the Energy Institute and has contributed to the latest UK Oil and Gas best practice guidelines, specific to Joint Integrity Management. The Academy is also an active member of an ASME sub-committee, developing new initiatives for Pressure Boundary Bolted Flange Joint Assembly.

Academy training courses incorporate ECITB Mechanical Joint Integrity MJ10, MJ18, MJ19, Energy Institute, European (EN1591 part 4) and ASME PCC-1 2013 methods and procedures.

### Location

The Academy has dedicated facilities in Aberdeen, Teesside, Humberside and West Yorkshire.

Training is also offered within our overseas operations.

### Courses

Training can be delivered in a variety of ways:

- At the Academy, utilising our purpose built training centres
- At the clients premises, utilising mobile training rigs and equipment
- At one of our training facilities in Aberdeen, Teesside and Humberside

### Benefits

- Legislation compliance
- Motivated workforce with best practice skills
- Reduced costs with increased asset integrity
- Access to the latest technical standards and procedures
- Sealing and integrity modules providing greater knowledge
- Alliance and structured support from a world class technical / training team

**For further information on the range of courses available visit [www.academyofjointintegrity.com](http://www.academyofjointintegrity.com)**



*The Academy of Joint Integrity™*



# PRODUCT RANGE:

- Corriculite<sup>®</sup>
- Change<sup>™</sup> Gasket
- Thermiculite<sup>®</sup>
- I-Flex Isolation Kits
- Sigma<sup>®</sup> PTFE
- Flange Rescue Gaskets (FRG)
- Spiral Wound Gaskets
- Kammprofile Gaskets
- Ring Type Joints
- HDS1 Insulating Kits
- Novus Sheet Jointing
- Cut Gaskets
- Solid Metallic Gaskets
- Compression Packings
- Academy of Joint Integrity – Training

**For more information on our range of product and services please visit [www.flexitallic.eu](http://www.flexitallic.eu) or email [contactus@flexitallic.eu](mailto:contactus@flexitallic.eu)**

## UNITED KINGDOM

### Flexitallic UK Ltd

Scandinavia Mill  
Hunsworth Lane  
Cleckheaton  
West Yorkshire, BD19 4LN  
UK  
Tel. +44 1274 851273  
Fax. +44 1274 300303  
www.flexitallic.eu

**Branches also in Aberdeen,  
Middlesbrough, Ellesmere  
Port and Cardiff.**

## UNITED ARAB EMIRATES

### Flexitallic LLC

Plot 108, Road E  
Al Hamra Industrial Area  
Ras Al Khaimah  
UNITED ARAB EMIRATES  
Tel. +971 (0)7 243 4305  
Fax. +971 (0)7 243 4306  
www.flexitallic.ae

## SINGAPORE

### Flexitallic Ltd

*Singapore Branch*  
Level 42 Suntec Tower Three  
8 Temasek Boulevard  
SINGAPORE  
038988  
Tel: +65 68663638  
www.flexitallic.eu

## UNITED STATES

### Custom Rubber Products

2625 Bennington  
Houston  
Texas 77093  
USA  
Tel. +1 713 691 2211  
Fax. +1 713 691 3005  
www.customrubber.com

## FRANCE

### Siem Supranite

*a Flexitallic Company*  
31-33 Rue de Mogador  
75009 Paris  
FRANCE  
Tel. +33 (0)1 48 88 88 88  
Fax. +33 (0)1 47 66 88 44  
www.siem.fr

## KAZAKHSTAN

### Novus Sealing Caspian LLP

*a Flexitallic Joint Venture*  
7v Atambayev St.  
Atyrau 060005  
REPUBLIC OF KAZAKHSTAN  
Tel: +7 7122 309936  
Fax: +7 7122 309937  
www.novussealingcaspian.com

## CANADA

### Flexitallic Canada Ltd

4340 - 78 Avenue  
Edmonton  
Alberta, T6B 3J5  
CANADA  
Tel. +780 466 5050  
Fax. +780 465 1177  
www.flexitallic.ca

## GERMANY

### Flexitallic GmbH

Halskestr. 4a  
47877 Willich  
GERMANY  
Tel: +49 (0) 2154 95363-0  
Fax: +49 (0) 2154 95363-29  
www.flexitallic-gmbh.de

## CHINA

### Flexitallic Gasket Technology (Suzhou) Co., Ltd

Building A, 1868 Guangming Rd  
Technological Development Zone  
WuJiang Economic 215200  
CHINA  
Tel. +86 512 6303 2839  
Fax. +86 512 6303 2879  
www.china.flexitallic.com

## UNITED STATES

### Flexitallic US LLC

6915 Highway 225  
Deer Park  
Texas 77536  
USA  
Tel. +1 281 604 2400  
Fax. +1 281 604 2415  
www.flexitallic.com

## About The Flexitallic Group

The Flexitallic Group is a global leader in specialised sealing solutions and products serving the oil and gas, power generation, chemical and petrochemical industries in emerging and developed markets. Focused on the upstream, downstream and power generation sectors, it has operations in France, the United States, Canada, Mexico, the United Kingdom, Germany, the United Arab Emirates, Kazakhstan and China plus a network of worldwide licensing partners and distributors.

[www.theflexitallicgroup.com](http://www.theflexitallicgroup.com)