



EG-30 thru -75 PEG-30 thru -65

Gas-Fired Boilers – Series 4

Control supplement – Standing pilot

For additional information, refer to . . .

EG • PEG • EGH Boiler manual
for Natural or Propane gas
(tankless heater application optional)

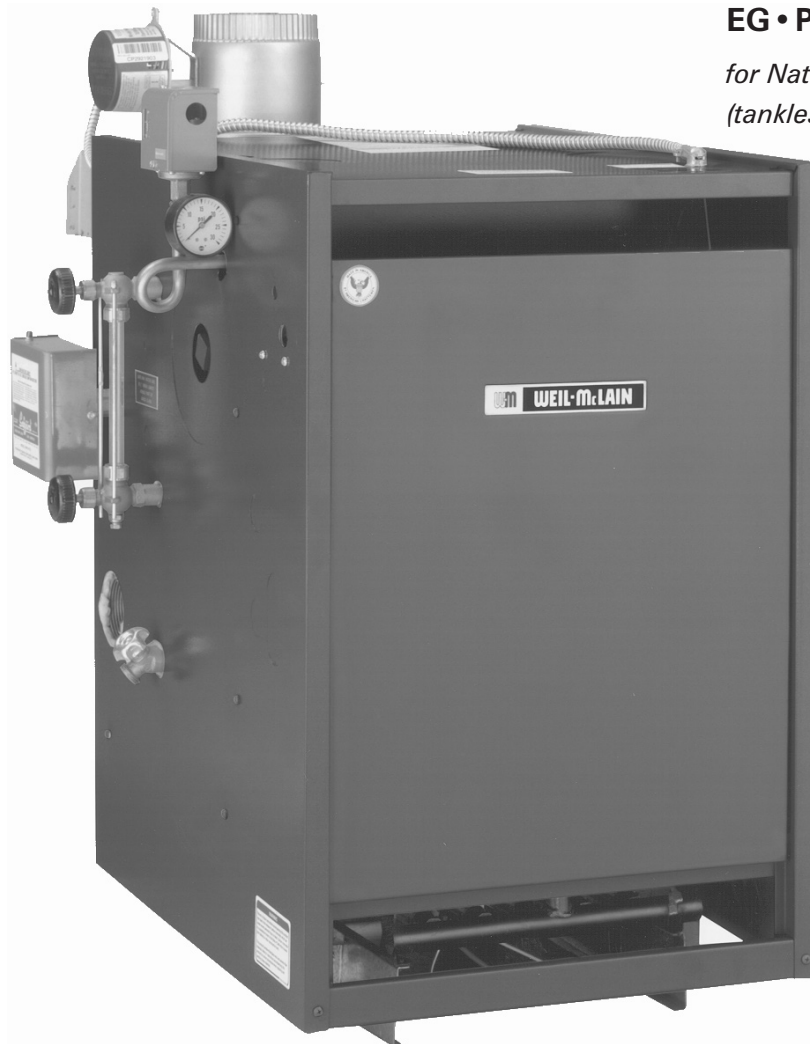

WARNING

This supplement must only be used by a qualified heating installer/service technician. **Before installing**, read all instructions, including this supplement, the boiler manual and any related documents. Perform steps in the order given. Failure to comply could result in severe personal injury, death or substantial property damage.



Please read this page first!

Hazard definitions

The following defined terms are used throughout these instructions to bring attention to the presence of hazards of various risk levels or to important information concerning the life of the product.

- ⚠ DANGER** Indicates presence of hazards that **will cause severe** personal injury, death or substantial property damage.
- ⚠ WARNING** Indicates presence of hazards that **can cause severe** personal injury, death or substantial property damage.
- ⚠ CAUTION** Indicates presence of hazards that **will or can cause minor** personal injury or property damage.
- NOTICE** Indicates special instructions on installation, operation or maintenance that are important but not related to personal injury or property damage.

Note to the installer

- ⚠ WARNING** Controls must only be installed by a Weil-McLain distributor or other qualified installer/service technician in accordance with this Supplement and all applicable codes and requirements of the authority having jurisdiction. Read this Control Supplement completely before beginning the installation. If the information in this Supplement is not followed exactly, a fire, explosion, carbon monoxide emission or other hazardous conditions can result, causing severe personal injury, death or substantial property damage.
- ⚠ WARNING** This system is used on gas-fired boilers without vent dampers as shipped from the factory. This system is not offered for retrofit. Any attempt to apply the system components to boilers shipped for use with a different control system will not be covered under boiler warranty and can cause severe personal injury, death or substantial property damage.
- NOTICE** When calling or writing about the boiler, please have the boiler model number from the boiler rating label and the CP number from the boiler jacket.



Table of contents

Hazard definitions and Note to the installer	2
Control installation – EG-30 thru -75 water boilers without tankless heaters	4-5
Control installation – EG-30 thru -65 water boilers with tankless heaters.....	6-7
Control installation – EG-30 thru -75 and PEG-30 thru -65 steam boilers with probe... ..	8-9
Control installation – EG-30 thru -75 steam boilers with float-type low water cutoff.....	10-11
Damper installation	12-13
Checkout procedure	14
Lighting instructions	15-18
Troubleshooting.....	19-23
Replacement parts.....	24

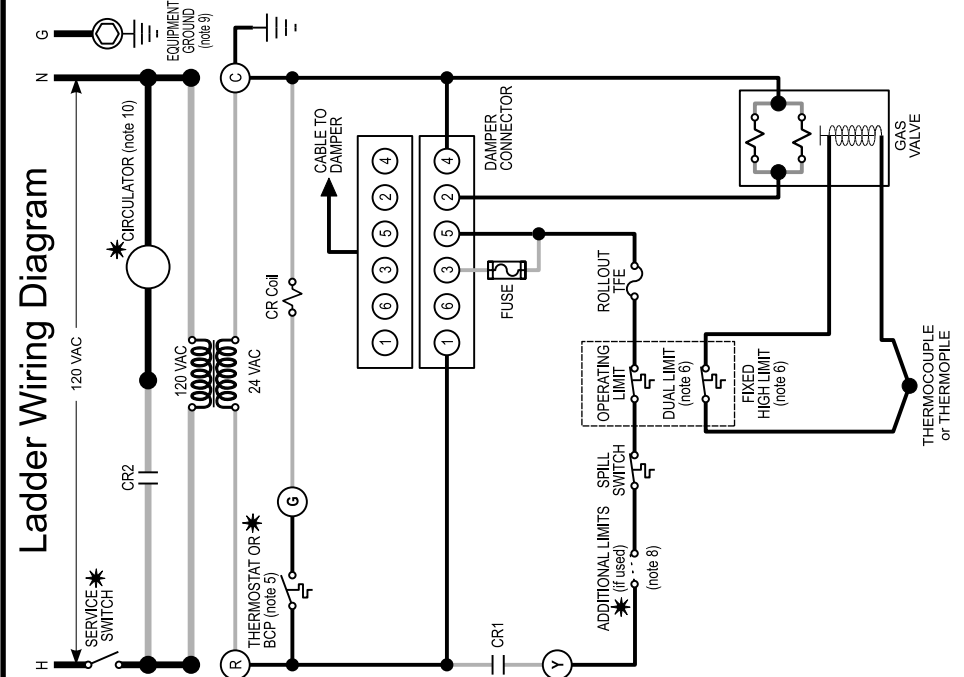
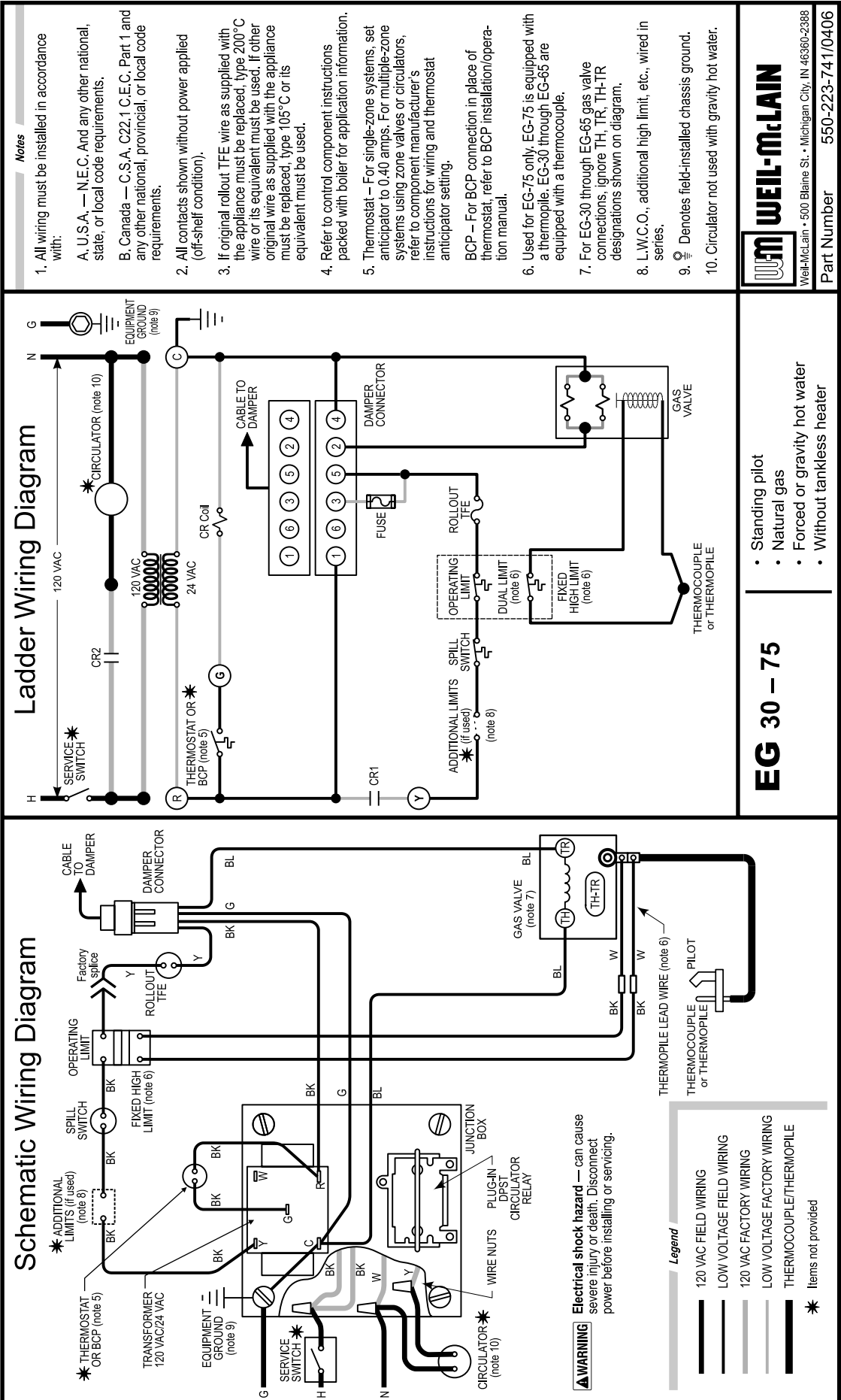

Notes

1. All wiring must be installed in accordance with:
 - A. U.S.A. — N.E.C. And any other national, state, or local code requirements.
 - B. Canada — C.S.A. C22.1 C.E.C. Part 1 and any other national, provincial, or local code requirements.
2. All contacts shown without power applied (off-shelf condition).
3. If original rollout TFE wire as supplied with the appliance must be replaced, type 200°C wire or its equivalent must be used. If other original wire as supplied with the appliance must be replaced, type 105°C or its equivalent must be used.
4. Refer to control component instructions packed with boiler for application information.
5. Thermostat — For single-zone systems, set anticipator to 0.40 amps. For multiple-zone systems using zone valves or circulators, refer to component manufacturer's instructions for wiring and thermostat anticipator setting.
- BCP — For BCP connection in place of thermostat, refer to BCP installation/operation manual.
6. Used for EG-75 only. EG-75 is equipped with a thermopile. EG-30 through EG-65 are equipped with a thermocouple.
7. For EG-30 through EG-65 gas valve connections, ignore TH, TR, TH-TR designations shown on diagram.
8. L.W.C.O., additional high limit, etc., wired in series.
9. Denotes field-installed chassis ground.
10. Circulator not used with gravity hot water.

EG 30 — 75

- Standing pilot
- Natural gas
- Forced or gravity hot water
- Without tankless heater

WEIL-McLAIN
 Weil-McLain • 500 Blaine St. • Michigan City, IN 46360-2388

Part Number 550-223-741/0406



Control installation

WARNING For your safety, turn off electrical power supply and turn off external gas supply valve before attempting to work on the boiler. Failure to comply can cause severe personal injury, death or substantial property damage.

EG-30 thru -65 water boilers without tankless heaters

1. Mount and wire controls per wiring diagram, page 4, and Figure 1.
 - a. Attach junction box inside left jacket panel with #8-32 x 1/2" machine screws provided.
 - b. Install transformer with plug-in relay receptacle and relay.
 - c. Operating and limit circuit wiring must be 18 gauge or heavier.
2. Bring supply wiring to boiler. Must be 14 gauge or heavier.
3. Proceed to page 12.

Figure 1

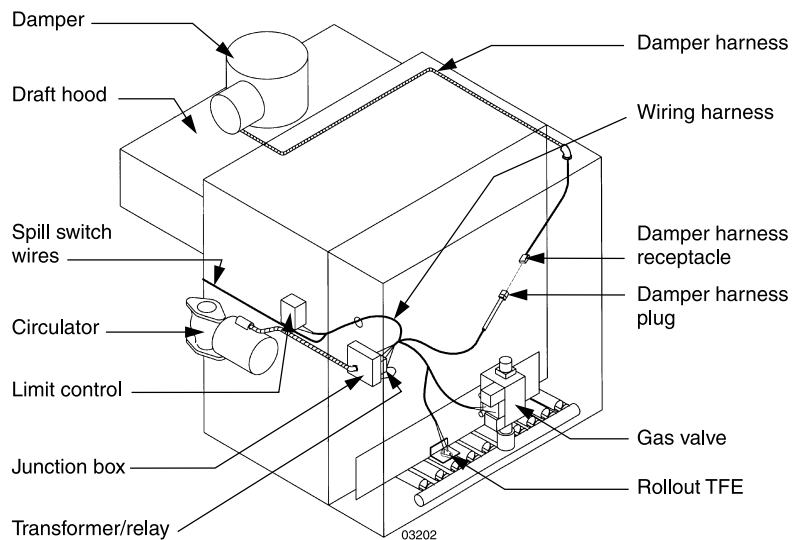

EG-75 water boilers without tankless heaters

1. Mount and wire controls per wiring diagram, page 4, and Figure 2.
 - a. Attach junction box inside left jacket panel with #8-32 x 1/2" machine screws and green ground nuts provided.
 - b. Install transformer with plug-in relay receptacle and relay. In Canada, use chain and hook strain relief.
 - c. Operating and limit circuit wiring must be 18 gauge or heavier.
2. Bring supply wiring to boiler. Must be 14 gauge or heavier.
3. Proceed to page 12.

Figure 2

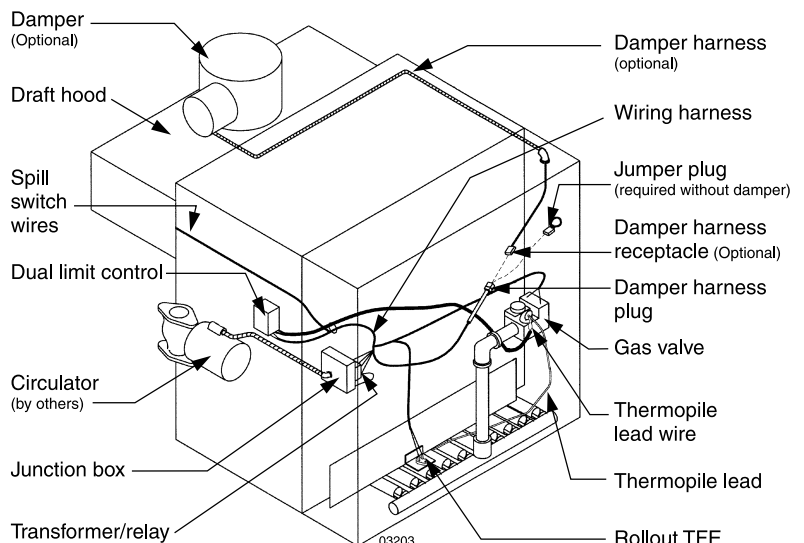

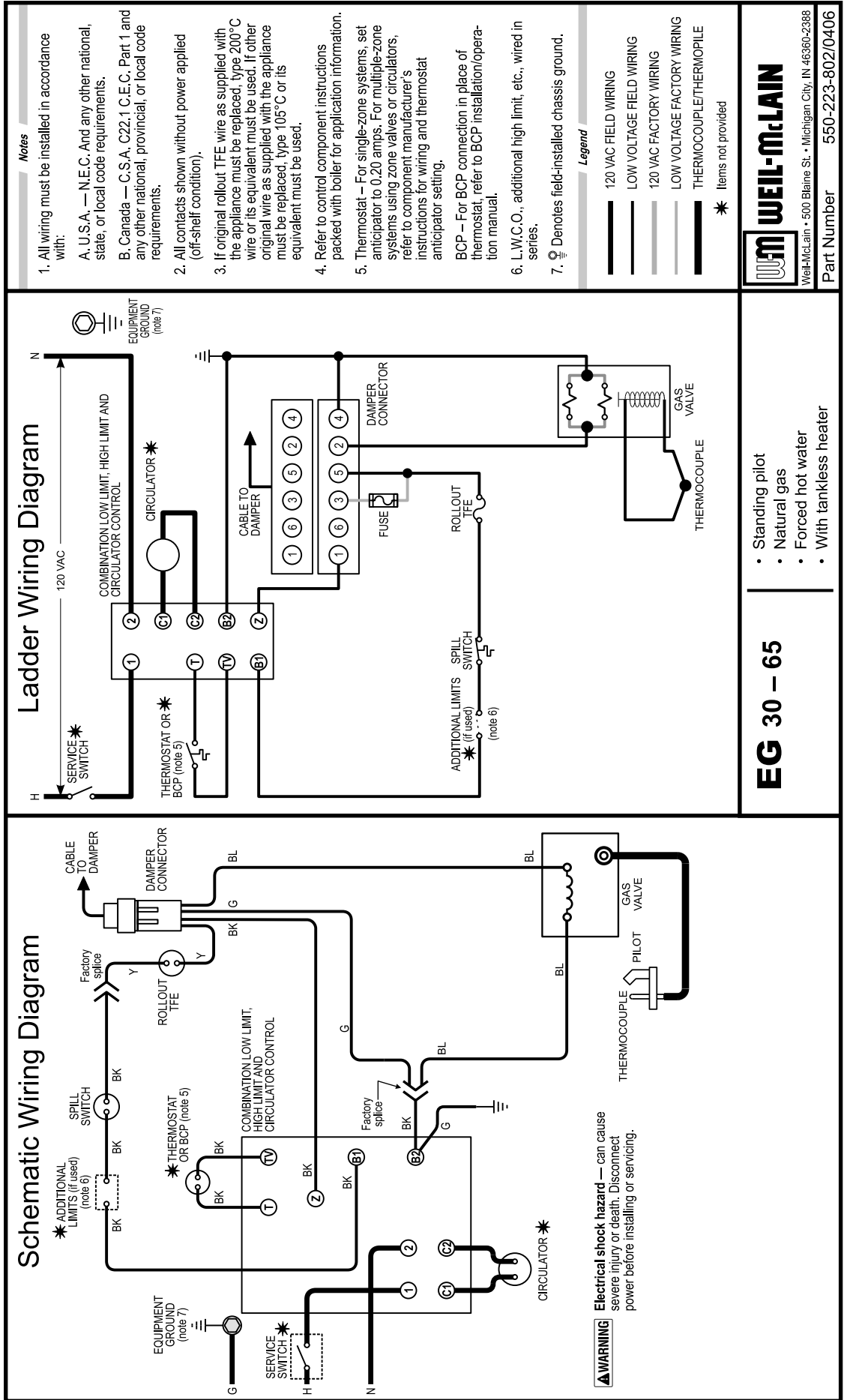



Control installation continued

⚠ WARNING For your safety, turn off electrical power supply and turn off external gas supply valve before attempting to work on the boiler. Failure to comply can cause severe personal injury, death or substantial property damage.

EG-30 thru -65 water boilers with tankless heaters

1. Mount and wire controls per wiring diagram, page 6, and Figure 3.
 - a. Install combination limit control and relay in tapping. See Boiler Manual control tapping table. Operating and limit circuit wiring must be 14 gauge or heavier.
2. Bring supply wiring to boiler. Must be 14 gauge or heavier.
3. Proceed to page 12.

Figure 3

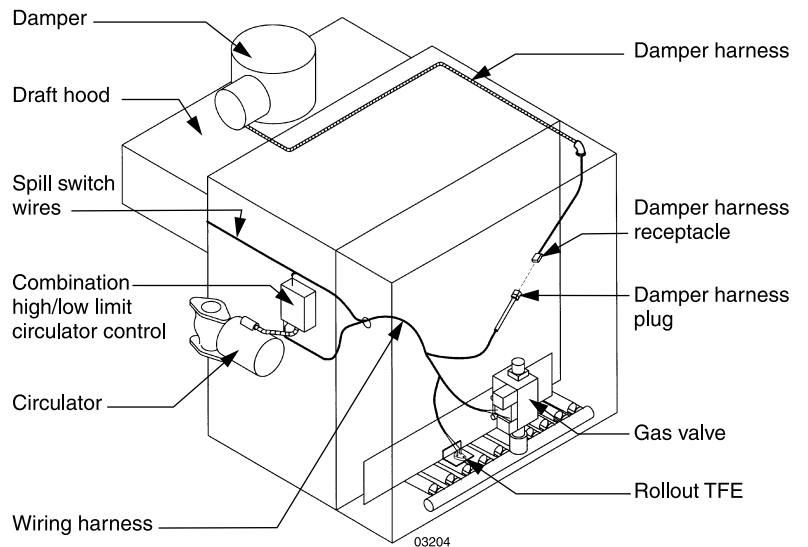

Note: Tankless heater not available on EG-75 standing pilot boilers.

- ### Notes
- All wiring must be installed in accordance with:
 - U.S.A. — N.E.C. And any other national, state, or local code requirements.
 - Canada — C.S.A. C22.1, C.E.C. Part 1 and any other national, provincial, or local code requirements.
 - All contacts shown without power applied (off-shelf condition).
 - If original rollout TFE wire as supplied with the appliance must be replaced, type 200°C wire or its equivalent must be used. If other original wire as supplied with the appliance must be replaced, type 105°C or its equivalent must be used.
 - Refer to control component instructions packed with boiler for application information.
 - Thermostat — Set anticipator to match ampere draw of gas valve plus vent damper (if used).
 - BCP — For BCP connection in place of thermostat, refer to BCP installation/operation manual.
 - For EG/PEG-30 through EG/PEG-65 gas valve connections, ignore TH, TR, TH-TR designations shown on diagram.
 - L.W.C.O., additional high limit, etc., wired in series.
 - Denotes field-installed chassis ground.
 - Operating control required with tankless heater.
 - Adjust limit control to desired system setting. Adjust high limit to minimum 2 PSI above system setting to avoid nuisance pilot outage.
 - Used for EG-75 only. EG-75 is equipped with a thermopile. EG/PEG-30 through EG/PEG-65 are equipped with a thermocouple.

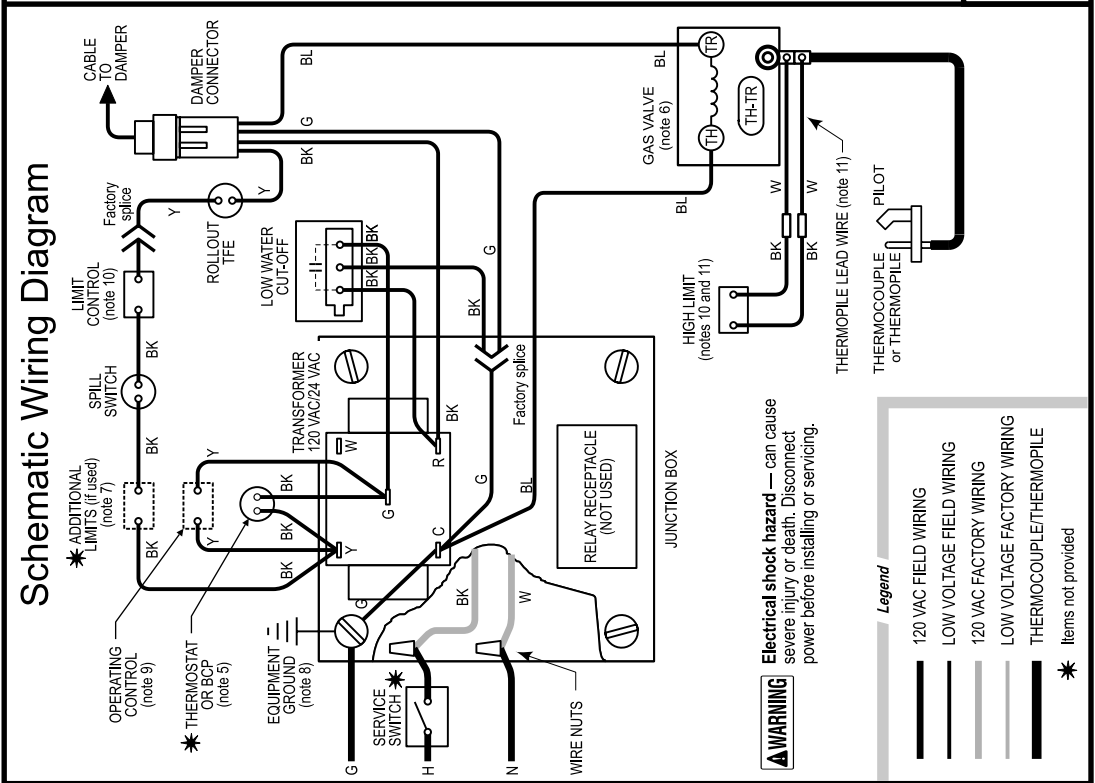
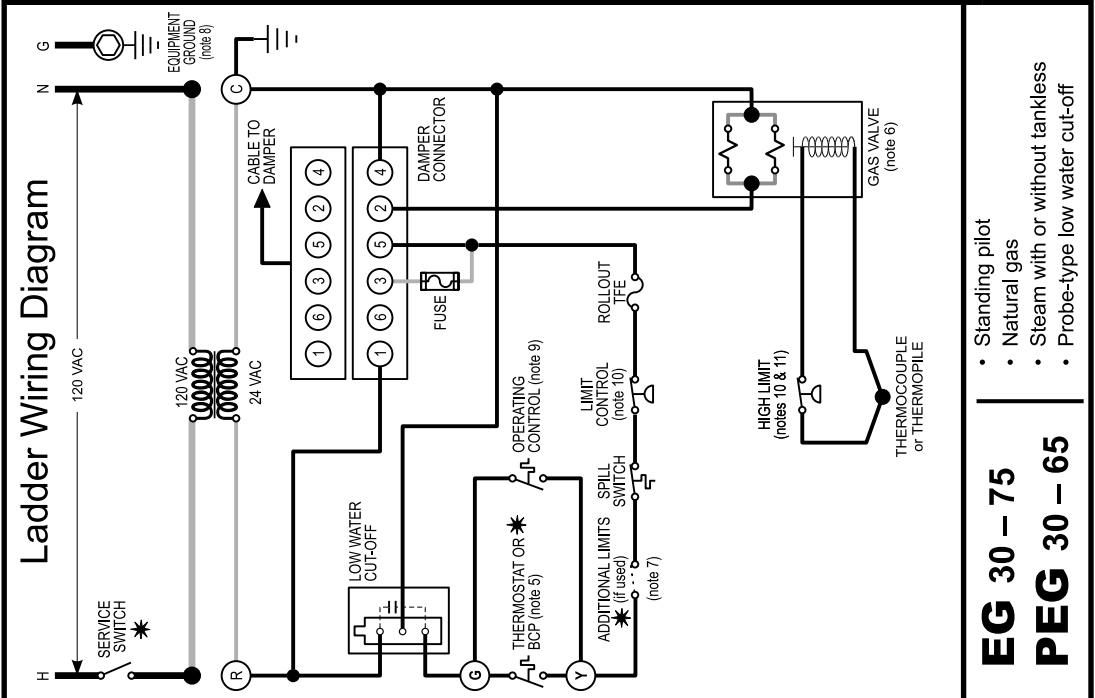

- ### EG 30 – 75 PEG 30 – 65
- Standing pilot
 - Natural gas
 - Steam with or without tankless
 - Probe-type low water cut-off

Weil-McLain • 500 Blaine St. • Michigan City, IN 46360-2388

Part Number 550-223-743/0110

WARNING Electrical shock hazard — can cause severe injury or death. Disconnect power before installing or servicing.



Control installation continued

WARNING For your safety, turn off electrical power supply and turn off external gas supply valve before attempting to work on the boiler. Failure to comply can cause severe personal injury, death or substantial property damage.

EG-30 thru -65 and PEG-30 thru -65 steam boilers with probe-type low water cutoff

1. Mount and wire controls per wiring diagram, page 8, and Figure 4.
 - a. Attach junction box inside left jacket panel with #8-32 x 1/2" machine screws provided.
 - b. Install transformer with plug-in relay receptacle.
 - c. Operating and limit circuit wiring must be 18 gauge or heavier.
2. Bring supply wiring to boiler. Must be 14 gauge or heavier.
3. Proceed to page 12.

Figure 4

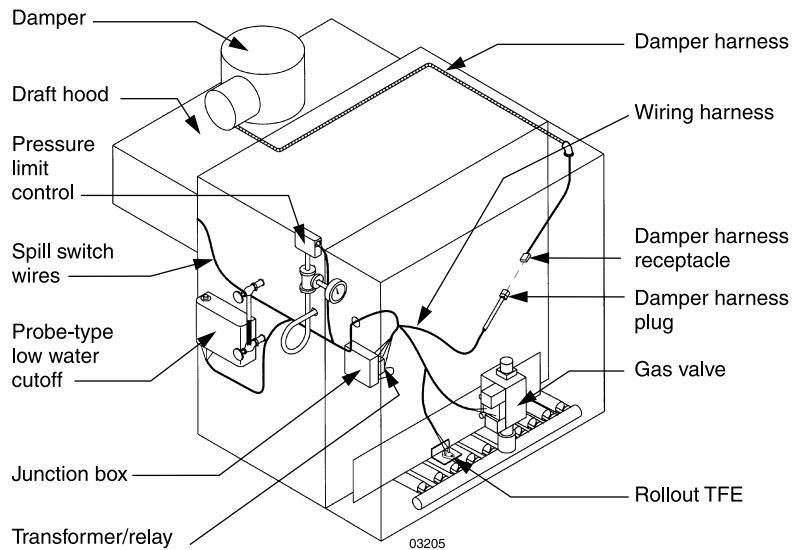

EG-75 steam boilers with probe-type low water cutoff

1. Mount and wire controls per wiring diagram, page 8, and Figure 5.
 - a. Attach junction box inside left jacket panel with #8-32 x 1/2" machine screws and green ground nuts provided.
 - b. Install transformer with plug-in relay receptacle. In Canada, use chain and hook strain relief.
 - c. Operating and limit circuit wiring must be 18 gauge or heavier.
2. Bring supply wiring to boiler. Must be 14 gauge or heavier.
3. Proceed to page 12.

Figure 5

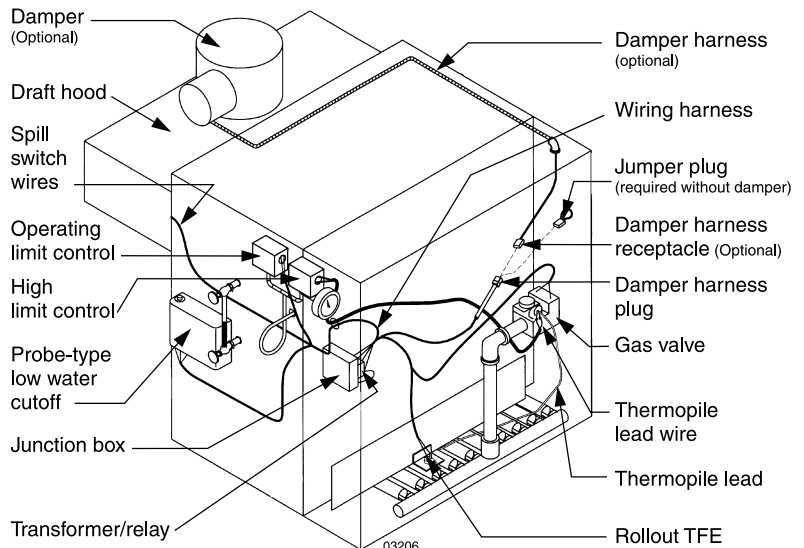

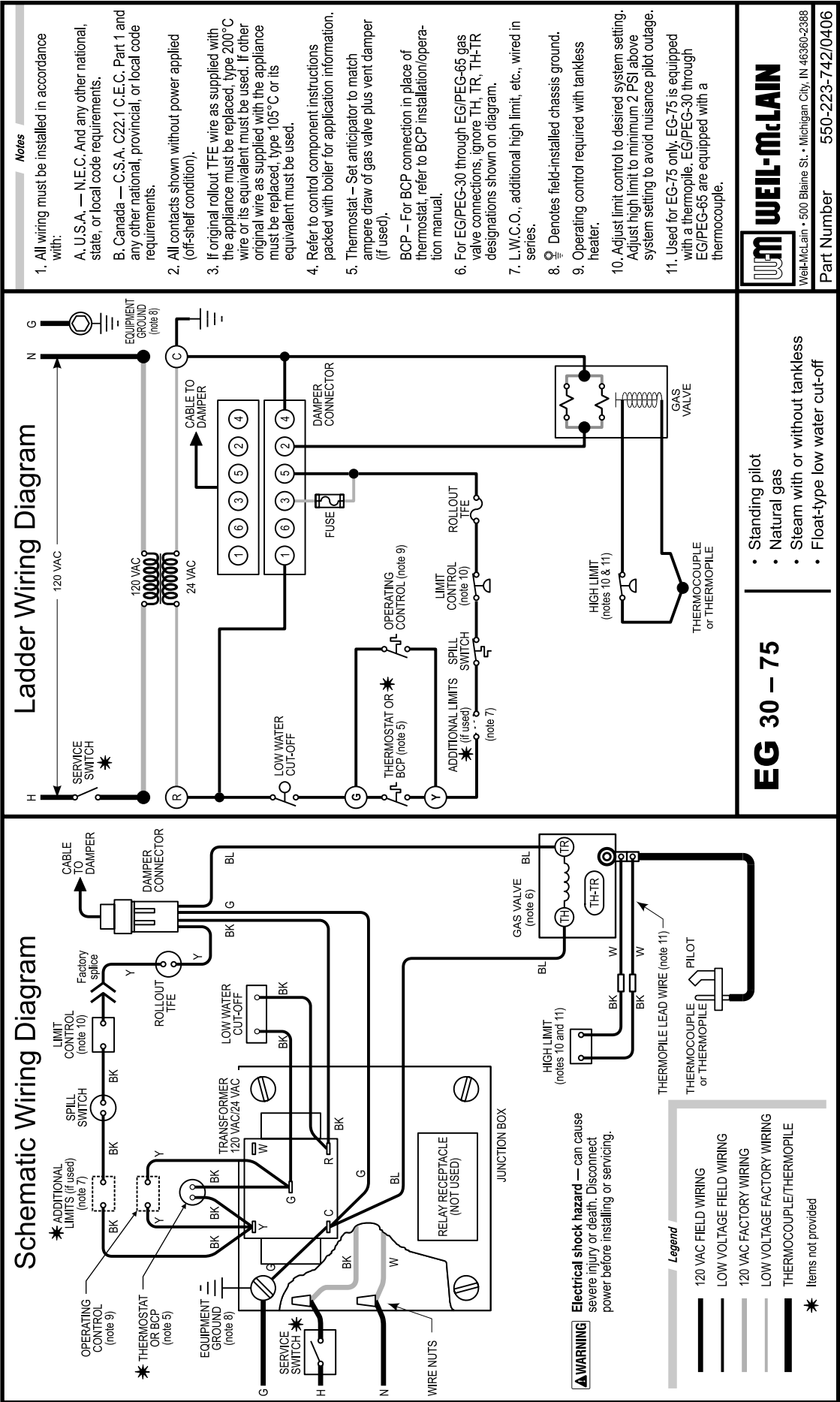

Schematic Wiring Diagram

Ladder Wiring Diagram

Notes

1. All wiring must be installed in accordance with:
 - A. U.S.A. — N.E.C. And any other national, state, or local code requirements.
 - B. Canada — C.S.A. C22.1 C.E.C. Part 1 and any other national, provincial, or local code requirements.
2. All contacts shown without power applied (off-shelf condition).
3. If original rollout TFE wire as supplied with the appliance must be replaced, type 200°C wire or its equivalent must be used. If other original wire as supplied with the appliance must be replaced, type 105°C or its equivalent must be used.
4. Refer to control component instructions packed with boiler for application information.
5. Thermostat — Set anticipator to match ampere draw of gas valve plus vent damper (if used).
6. For EG/PEG-30 through EG/PEG-65 gas valve connections, ignore TH, TR, TH-TR designations shown on diagram.
7. L.W.C.O., additional high limit, etc., wired in series.
8. ⚡ Denotes field-installed chassis ground.
9. Operating control required with tankless heater.
10. Adjust limit control to desired system setting. Adjust high limit to minimum 2 PSI above system setting to avoid nuisance pilot outage.
11. Used for EG-75 only. EG-75 is equipped with a thermopile. EG/PEG-30 through EG/PEG-65 are equipped with a thermocouple.

EG 30 – 75

- Standing pilot
- Natural gas
- Steam with or without tankless
- Float-type low water cut-off

WEIL-McLAIN
 Weil-McLain • 500 Blaine St. • Michigan City, IN 46360-2388
Part Number 550-223-742/0406

⚠ WARNING Electrical shock hazard — can cause severe injury or death. Disconnect power before installing or servicing.

Legend

- 120 VAC FIELD WIRING
- LOW VOLTAGE FIELD WIRING
- 120 VAC FACTORY WIRING
- LOW VOLTAGE FACTORY WIRING
- THERMOCOUPLE/THERMOPILE
- ⚡ Items not provided



Control installation continued

WARNING For your safety, turn off electrical power supply and turn off external gas supply valve before attempting to work on the boiler. Failure to comply can cause severe personal injury, death or substantial property damage.

EG-30 thru -65 steam boilers with float-type low water cutoff

1. Mount and wire controls per wiring diagram, page 10, and Figure 6.
 - a. Attach junction box inside left jacket panel with #8-32 x 1/2" machine screws provided.
 - b. Install transformer with plug-in relay receptacle.
 - c. Operating and limit circuit wiring must be 18 gauge or heavier.
2. Bring supply wiring to boiler. Must be 14 gauge or heavier.
3. Proceed to page 12.

Figure 6

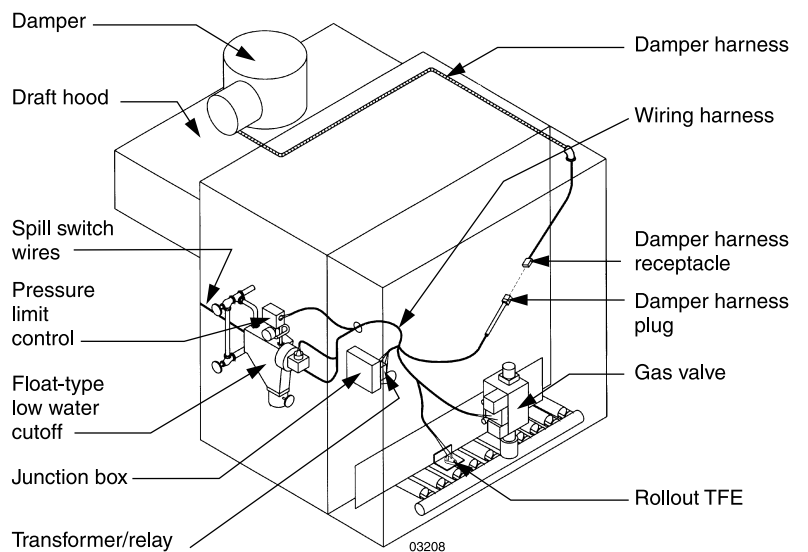

EG-75 steam boilers with float-type low water cutoff

1. Mount and wire controls per wiring diagram, page 10, and Figure 7.
 - a. Attach junction box inside left jacket panel with #8-32 x 1/2" machine screws and green ground nuts provided.
 - b. Install transformer with plug-in relay receptacle. In Canada, use chain and hook strain relief.
 - c. Operating and limit circuit wiring must be 18 gauge or heavier.
2. Bring supply wiring to boiler. Must be 14 gauge or heavier.
3. Proceed to page 12.

Figure 7

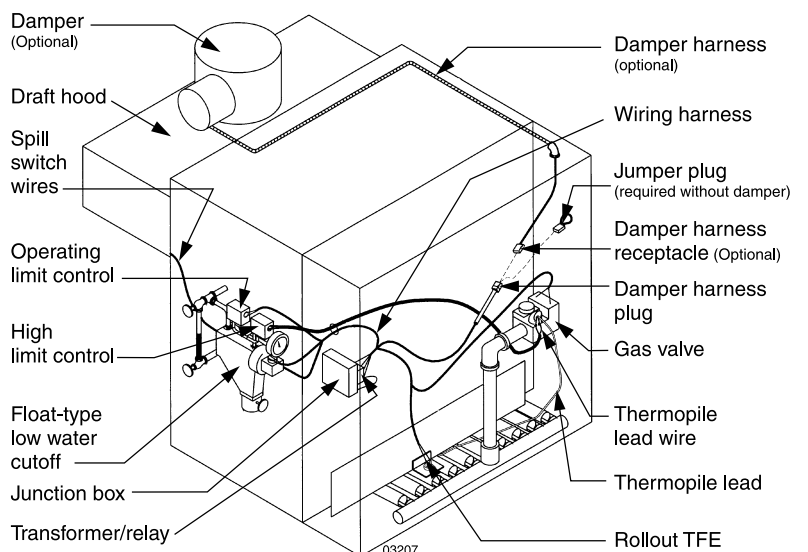



Damper installation

NOTICE Once damper is installed, boiler will not operate without a damper installed.

WARNING Only dampers listed in the Replacement parts table on page 24 are approved for use on EG and PEG Series 4 standing pilot boilers. Any other vent damper installed could cause severe personal injury or death.

The following boiler models must have damper installed:

- EG-30 thru EG-65, natural or propane gas.
- PEG-30 thru PEG-65, steam, natural gas.

The following boiler models may have damper installed:

- EG-75, natural or propane gas.

Figure 8 Vent damper assemblies

Effikal or Field Controls Johnson Controls damper damper

Refer to vent manufacturer's instructions to install plug (shipped with damper) in damper hole.

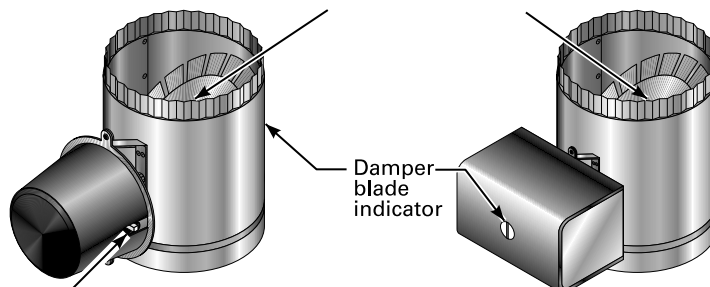

Hold-open switch (Effikal or Field Controls only) — Install vent damper so that switch is visible and accessible to user.

59325



Damper installation continued

Minimum clearances to combustibles

Provide a minimum of 6" between the vent damper and any combustible material. (Provide a minimum of 46" between jacket top and combustible ceiling.) See EG • PEG • EGH Boiler manual for complete clearance requirements.

Installation

⚠ DANGER Do not modify draft hood or damper, or make another connection between draft hood and damper or boiler except as noted below. This will void CSA certification and will not be covered by Weil-McLain warranty. Any changes will cause severe personal injury, death, or substantial property damage.

1. Install vent damper horizontally or vertically as shown in vent damper manufacturer's instructions. Vent damper must be installed so that it serves only one boiler and so damper blade indicator is visible to the user. See Figure 8.
2. Screws or rivets used to secure the vent damper to the draft hood must not interfere with rotation of the damper blade.
3. Install damper harness between damper actuator and knockout in jacket top panel. Use strain relief connectors and locknuts to secure both ends of the damper harness.

⚠ CAUTION Keep wiring harness clear of all hot surfaces.

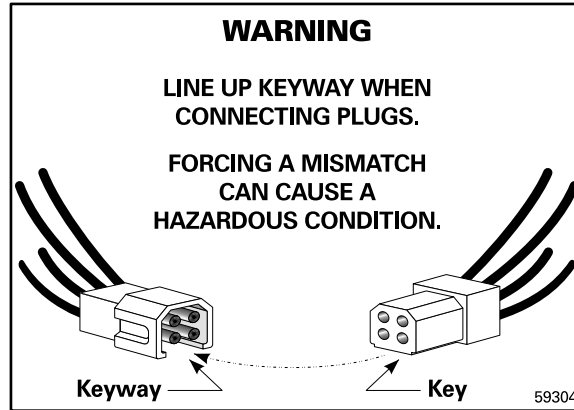

4. Read and apply the harness plug warning label (shown above) so that it is visible after installation.
5. Plug damper harness receptacle into damper harness plug.

⚠ DANGER Bypassing (jumpering) vent damper will cause flue products such as carbon monoxide to escape into the house. This will cause severe personal injury or death.

⚠ CAUTION After boiler has operated once, if either end of the harness is disconnected, the system safety shutdown will occur. The boiler will not operate until harness is reconnected.

NOTICE **Effikal or Field Controls damper—** Damper hold open switch must be in "Automatic Operation" position for system to operate properly.



Checkout procedure

1. See pages 15-18 for “Lighting Instructions”.
2. Raise room thermostat to call for heat. Damper actuator will slowly open damper.
3. When damper is fully open, main gas valve will open and main burners will ignite.

⚠ DANGER Damper must be fully open before main burners light. If damper does not fully open, flue products will escape into house, causing severe personal injury or death.

4. Lower thermostat setting. Main burner flames will go out, then damper will close.
5. Repeat steps 1 through 3 several times to verify operation.
6. Return thermostat to normal setting.

Room thermostat anticipator settings

Water without tankless heater — 0.40 amps

Water with tankless heater — 0.20 amps

Steam — Select based on gas valve and damper. See table below.

Gas valve	Without damper (amps)	With Effikal damper (amps)	With Johnson damper (amps)
Honeywell VR8200	0.50	0.60	0.70
Honeywell VR8300	0.70	0.80	0.90
Robertshaw 7200ER	0.40	0.50	0.60
Robertshaw 7000ERHC	0.20	0.30	0.40



Lighting instructions — Robertshaw 7200

FOR YOUR SAFETY READ BEFORE LIGHTING

WARNING If you do not follow these instructions exactly, a fire or explosion may result causing property damage, personal injury or loss of life.

- A. This appliance has a pilot, which must be lighted by hand. When lighting the pilot, follow these instructions exactly.
- B. **BEFORE LIGHTING**, smell all around the appliance area for gas. Be sure to smell next to the floor because some gas is heavier than air and will settle on the floor. See below.
- C. Use only your hand to depress or move the selector arm. Never use tools. If the selector arm will not depress or move by hand, don't try to repair it, call a qualified service technician. Force or attempted repair may result in a fire or explosion.
- D. Do not use this appliance if any part has been under water. Immediately call a qualified service technician to inspect the appliance and to replace any part of the control system and any gas control, which has been under water.

WHAT TO DO IF YOU SMELL GAS

- Do not try to light any appliance.
- Do not touch any electric switch; do not use any phone in your building.
- Immediately call your gas supplier from a neighbor's phone. Follow the gas supplier's instructions.
- If you cannot reach your gas supplier, call the fire department.

LIGHTING INSTRUCTIONS

1. **STOP!** Read the safety information above on this label.
2. Set the thermostat to lowest setting.
3. Turn off all electrical power to the appliance.
4. Remove front panel.
5. Depress and move selector arm left ↶ to "OFF." Note: Selector arm cannot be moved to "OFF" unless selector arm is depressed slightly. Do not force.
6. Wait five (5) minutes to clear out any gas. Then smell for gas, including near the floor. If you smell gas, STOP! Follow "B" in the safety information above. If you don't smell gas, go to the next step.
7. Remove access panel located above burners.
8. Find pilot – follow metal tube from gas control. The pilot is between two burners behind the access panel.
9. Move selector arm on gas control right ↷ to "SET" position.
10. Hold selector arm in "SET" position and immediately light the pilot with a match. Continue to hold selector arm to "SET" for about one-half (1/2) minute after the pilot is lit.
11. Release selector arm. Pilot should remain lit. If pilot goes out, repeat steps 5 through 11.
 - If the pilot will not stay lit after several tries, move selector arm left ↶ to "OFF" and call your service technician or gas supplier.
12. Replace access panel.
13. Turn selector arm left ↶ to "ON."
14. Turn on all electric power to the appliance.
15. Set thermostat to desired setting.
16. Replace front panel.

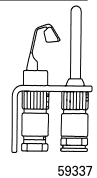
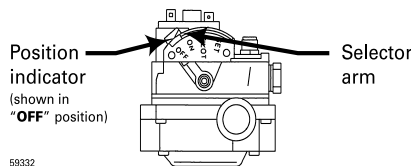

TO TURN OFF GAS TO THE APPLIANCE

1. Set the thermostat to lowest setting.
2. Turn off all electric power to the appliance if service is to be performed.
3. Remove front panel.
4. Depress and move selector arm left ↶ to "OFF." Do not force.
5. Replace front panel.

550-223-039(0906)



Lighting instructions — Honeywell VR8200/VR8300

Natural gas boilers only

FOR YOUR SAFETY READ BEFORE LIGHTING

WARNING If you do not follow these instructions exactly, a fire or explosion may result causing property damage, personal injury or loss of life.

- A. This appliance has a pilot, which must be lighted by hand. When lighting the pilot, follow these instructions exactly.
- B. **BEFORE LIGHTING**, smell all around the appliance area for gas. Be sure to smell next to the floor because some gas is heavier than air and will settle on the floor. See below.
- C. Use only your hand to push down the reset button or turn the gas control knob. Never use tools. If the knob or reset button will not operate by hand, don't try to repair it, call a qualified service technician. Force or attempted repair may result in a fire or explosion.
- D. Do not use this appliance if any part has been under water. Immediately call a qualified service technician to inspect the appliance and to replace any part of the control system and any gas control, which has been under water.

WHAT TO DO IF YOU SMELL GAS

- Do not try to light any appliance.
- Do not touch any electric switch; do not use any phone in your building.
- Immediately call your gas supplier from a neighbor's phone. Follow the gas supplier's instructions.
- If you cannot reach your gas supplier, call the fire department.

LIGHTING INSTRUCTIONS

1. **STOP!** Read the safety information above on this label.
2. Set the thermostat to lowest setting.
3. Turn off all electrical power to the appliance.
4. Remove front panel.
5. Turn gas control knob clockwise ↻ to "OFF."

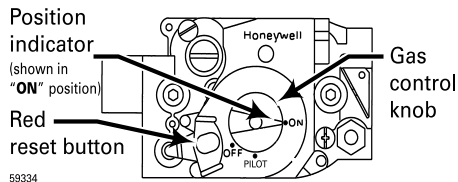

6. Wait five (5) minutes to clear out any gas. Then smell for gas, including near the floor. If you smell gas, **STOP!** Follow "B" in the safety information above. If you don't smell gas, go to the next step.
7. Remove access panel located above burners.

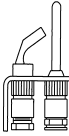
8. Find pilot – follow metal tube from gas control. The pilot is between two burners behind the access panel.
9. Turn gas control knob counterclockwise ↻ to "PILOT." 
10. Push in red reset button and hold. Immediately light the pilot with a match. Continue to hold reset button in for about one (1) minute after the pilot is lit.
11. Release reset button. Pilot should remain lit. If pilot goes out, repeat steps 5 through 11.
 - If reset button stays depressed after release, stop and immediately call your service technician or gas supplier.
 - If the pilot will not stay lit after several tries, turn the gas control knob clockwise ↻ to "OFF" and call your service technician or gas supplier.
12. Replace access panel.
13. Turn gas control knob counterclockwise ↻ to "ON."
14. Turn on all electric power to the appliance.
15. Set thermostat to desired setting.
16. Replace front panel.

TO TURN OFF GAS TO THE APPLIANCE

1. Set the thermostat to lowest setting.
2. Turn off all electric power to the appliance if service is to be performed.
3. Remove front panel.
4. Turn gas control knob clockwise ↻ to "OFF."
5. Replace front panel.

550-223-038(0906)



Lighting instructions — Honeywell VR8200/VR8300 Propane boilers only

FOR YOUR SAFETY READ BEFORE LIGHTING

WARNING If you do not follow these instructions exactly, a fire or explosion may result causing property damage, personal injury or loss of life.

- A. This appliance has a pilot, which must be lighted by hand. When lighting the pilot, follow these instructions exactly.
- B. **BEFORE LIGHTING**, smell all around the appliance area for gas. Be sure to smell next to the floor because some gas is heavier than air and will settle on the floor. See below.
- C. Use only your hand to push down the reset button or turn the gas control knob. Never use tools. If the knob or reset button will not operate by hand, don't try to repair it, call a qualified service technician. Force or attempted repair may result in a fire or explosion.
- D. Do not use this appliance if any part has been under water. Immediately call a qualified service technician to inspect the appliance and to replace any part of the control system and any gas control, which has been under water.

WHAT TO DO IF YOU SMELL GAS

- Do not try to light any appliance.
- Do not touch any electric switch; do not use any phone in your building.
- Immediately call your gas supplier from a neighbor's phone. Follow the gas supplier's instructions.
- If you cannot reach your gas supplier, call the fire department.

LIGHTING INSTRUCTIONS

1. **STOP!** Read the safety information above on this label.
2. Set the thermostat to lowest setting.
3. Turn off all electrical power to the appliance.
4. Remove front panel.
5. Turn gas control knob clockwise ↻ to "OFF."

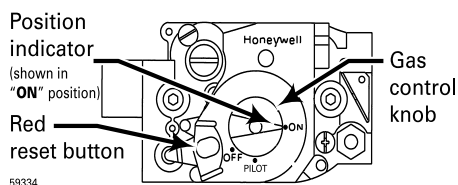

6. Wait five (5) minutes to clear out any gas. Then smell for gas, including near the floor. If you smell gas, **STOP!** Follow "B" in the safety information above. If you don't smell gas, go to the next step.
7. Remove access panel located above burners.

8. Find pilot – follow metal tube from gas control. The pilot is between two burners behind the access panel.
9. Turn gas control knob counterclockwise ↻ to "PILOT."
10. Push in red reset button and hold. Immediately light the pilot with a match. Continue to hold reset button in for about one (1) minute after the pilot is lit.
11. Release reset button. Pilot should remain lit. If pilot goes out, repeat steps 5 through 11.
 - If reset button stays depressed after release, stop and immediately call your service technician or gas supplier.
 - If the pilot will not stay lit after several tries, turn the gas control knob clockwise ↻ to "OFF" and call your service technician or gas supplier.
12. Replace access panel.
13. Turn gas control knob counterclockwise ↻ to "ON."
14. Turn on all electric power to the appliance.
15. Set thermostat to desired setting.
16. Replace front panel.

TO TURN OFF GAS TO THE APPLIANCE

1. Set the thermostat to lowest setting.
2. Turn off all electric power to the appliance if service is to be performed.
3. Remove front panel.
4. Turn gas control knob clockwise ↻ to "OFF."
5. Replace front panel.

550-223-040(0906)

Lighting instructions — Robertshaw 7000ERHC

FOR YOUR SAFETY READ BEFORE LIGHTING

WARNING If you do not follow these instructions exactly, a fire or explosion may result causing property damage, personal injury or loss of life.

- A. This appliance has a pilot, which must be lighted by hand. When lighting the pilot, follow these instructions exactly.
- B. **BEFORE LIGHTING**, smell all around the appliance area for gas. Be sure to smell next to the floor because some gas is heavier than air and will settle on the floor. See below.
- C. Use only your hand to push down the reset button or turn the gas control knob. Never use tools. If the knob or reset button will not operate by hand, don't try to repair it, call a qualified service technician. Force or attempted repair may result in a fire or explosion.
- D. Do not use this appliance if any part has been under water. Immediately call a qualified service technician to inspect the appliance and to replace any part of the control system and any gas control, which has been under water.

WHAT TO DO IF YOU SMELL GAS

- Do not try to light any appliance.
- Do not touch any electric switch; do not use any phone in your building.
- Immediately call your gas supplier from a neighbor's phone. Follow the gas supplier's instructions.
- If you cannot reach your gas supplier, call the fire department.

LIGHTING INSTRUCTIONS

1. **STOP!** Read the safety information above on this label.
2. Set the thermostat to lowest setting.
3. Turn off all electrical power to the appliance.
4. Remove front panel.
5. Depress gas control knob slightly and turn clockwise ↻ to "OFF." Note: Gas control knob cannot be turned to "OFF" unless knob is depressed slightly. Do not force.

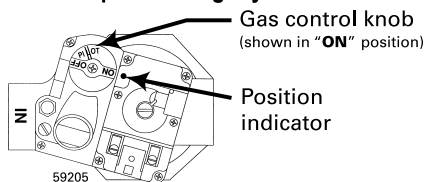

6. Wait five (5) minutes to clear out any gas. Then smell for gas, including near the floor. If you smell gas, **STOP!** Follow "B" in the safety information above. If you don't smell gas, go to the next step.
7. Remove access panel located above burners.
8. Find pilot – follow metal tube from gas control. The pilot is between two burners behind the access panel.

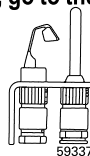

9. Turn gas control knob counterclockwise ↻ to "PILOT."
10. Depress gas control knob and hold. Immediately light the pilot with a match. Continue to hold gas control knob in for about one (1) minute after the pilot is lit.
 - If pilot can be lit without depressing gas control knob, turn gas knob clockwise ↻ to "OFF" and call your service technician or gas supplier.
11. Release gas control knob. Pilot should remain lit. If pilot goes out, repeat steps 5 through 11.
 - If gas control knob stays depressed after release, stop and immediately call your service technician or gas supplier.
 - If pilot will not stay lit after several tries, turn the gas control knob clockwise ↻ to "OFF" and call your service technician or gas supplier.
12. Replace access panel.
13. Turn gas control knob counterclockwise ↻ to "ON."
14. Turn on all electric power to the appliance.
15. Set thermostat to desired setting.
16. Replace front panel.

TO TURN OFF GAS TO THE APPLIANCE

1. Set the thermostat to lowest setting.
2. Turn off all electric power to the appliance if service is to be performed.
3. Remove front panel.
4. Depress gas control knob slightly and turn clockwise ↻ to "OFF."
5. Replace front panel.

550-223-081(0706)



Troubleshooting

⚠ DANGER Burner access panel must be in position during boiler operation to prevent momentary flame rollout on ignition of main flame. Severe personal injury or substantial property damage will result.

⚠ WARNING Never jumper (bypass) any device except for momentary testing as outlined in Troubleshooting Charts. Substantial property damage and/or severe personal injury could occur.

⚠ WARNING Label all wires prior to disconnection when servicing controls. Wiring errors can cause improper and dangerous operation.

⚠ WARNING Verify proper operation after servicing. See vent damper manufacturer’s instructions packed with vent damper for additional information. Failure to comply could result in severe personal injury, death or substantial property damage.

Before troubleshooting

1. Have a voltmeter that can check 120 VAC, 24 VAC, and a continuity tester.
2. Check for 120 VAC (minimum 102 to maximum 132) to boiler.
3. Be sure pilot is lit. See “Lighting instructions” on pages 15-18 for details.
4. Make sure thermostat is calling for heat and contacts (including appropriate zone controls) are closed. Check for 24VAC between thermostat wire nuts and ground.

In event of vent damper failure:

Effikal or Field Controls vent damper

If troubleshooting chart recommends replacing actuator and actuator is not immediately available, damper blade can be fixed in an open position to allow boiler operation. **Manually turning blade can cause actuator damage.** Follow these instructions only in case of no heat or damper actuator malfunction.

1. Move damper service switch to **Hold Damper Open** position. Apply call for heat to boiler. Damper blade should then rotate to open position and boiler will fire.
2. If step 1 does not open damper, manually rotate damper blade to open position using wrench or pliers on flat shaft between damper and actuator. Boiler will fire. Verify that damper service switch is in Hold Damper Open position (Figure 9).
3. **Do not leave vent damper permanently in this position.** Replace actuator immediately. If vent damper is left in open position, boiler will not operate at published efficiencies.

Johnson Controls vent damper

If troubleshooting chart recommends replacing actuator and actuator is not immediately available, damper blade can be fixed in an open position to allow boiler operation. Follow these instructions only in case of no heat or damper actuator malfunction. See Figure 9.

1. Turn off power to boiler.

⚠ WARNING Failure to turn off power to boiler can result in severe personal injury, death or substantial property damage.

2. Refer to vent damper manufacturer’s instructions for procedure to fix vent damper in open position.
3. Turn on power to boiler.
4. Using wrench or pliers on flat shaft section, manually rotate damper blade until green light turns on. Boiler will fire (Figure 9).
5. Do not leave vent damper permanently in this position. Replace actuator immediately. If vent damper is left in open position, boiler will not operate at published efficiencies.

Figure 9 Manually opening vent damper

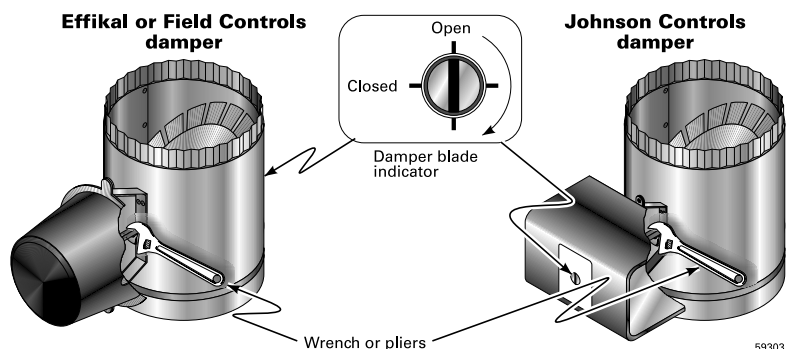

Troubleshooting continued

Pilot does not stay lit — Troubleshooting thermocouple or thermopile and high limit control circuit

1. Checking thermocouple or thermopile open system (Figure 10):
 - a. Use an electronic multimeter, with leads fitted with alligator clips. Set meter scale to DC Millivolts.
 - b. Unscrew thermocouple or thermopile fitting from gas valve.
 - c. Attach one meter lead to the end of the thermocouple or thermopile gas valve fitting.
 - d. Attach other meter lead to thermocouple or thermopile lead (copper surface).
 - e. Follow Lighting Instruction label on boiler (also found in Control Supplement or User's Information Manual) to light the pilot burner only, and hold the pilot flame manually. (DO NOT light main burner.)
 - f. Check the reading on the multimeter. The reading should be around 28 millivolts for a thermocouple, or 700 millivolts for a thermopile.
 - g. If multimeter reading is significantly less than above and pilot flame is appropriate, replace the thermocouple or thermopile.
2. Checking thermopile and high limit control circuit closed system (Figure 11):
 - a. Use an electronic multimeter, with leads fitted with alligator clips. Set meter scale to DC Millivolts.
 - b. Loosen the insulated terminal on the TOP thermopile lead wire enough to allow clipping a multimeter alligator clip to the spade terminal.
 - c. Attach the other multimeter lead to the thermopile lead (copper surface). Light the pilot burner per step 1 e, above.
 - d. Check the reading on the multimeter. The reading should be around 400 millivolts.
 - e. If reading is significantly less than 400 millivolts, check tightness of lead wire assembly in gas valve. If the connections are secure and you have checked the thermopile per step 1 above, replace the thermopile lead wire assembly.
 - f. If reading on TOP thermopile lead wire is around 400 millivolts, move the multimeter alligator clip to the BOTTOM thermopile lead wire terminal and check multimeter reading.
 - g. If multimeter does not read around 400 millivolts, check wiring connections and wire integrity to the high limit control.
 - h. Check voltage at each limit terminal to make sure limit is closed. Correct pressure or temperature condition causing any limit to be open. Replace limit if necessary.

Figure 10

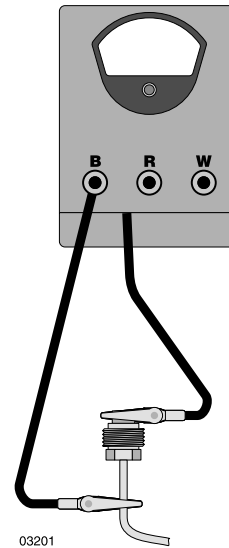
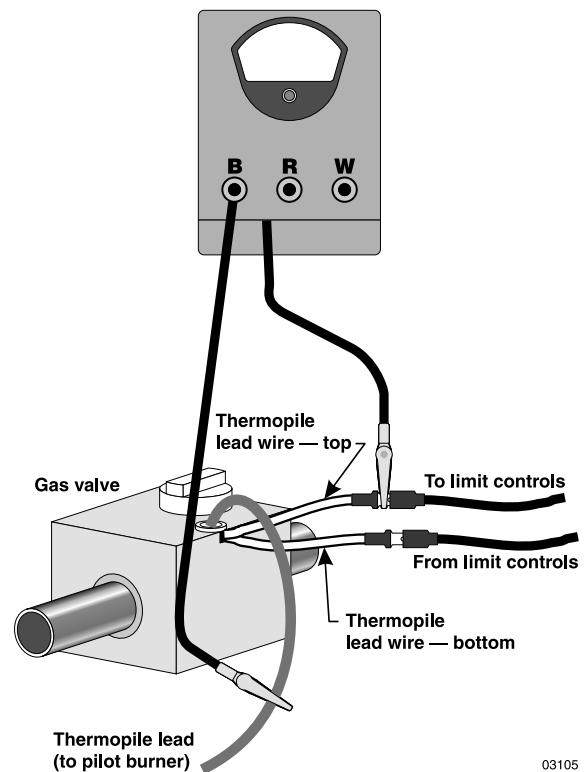

Figure 11





Troubleshooting continued

Chart 1: Boiler will not fire – water boilers without tankless

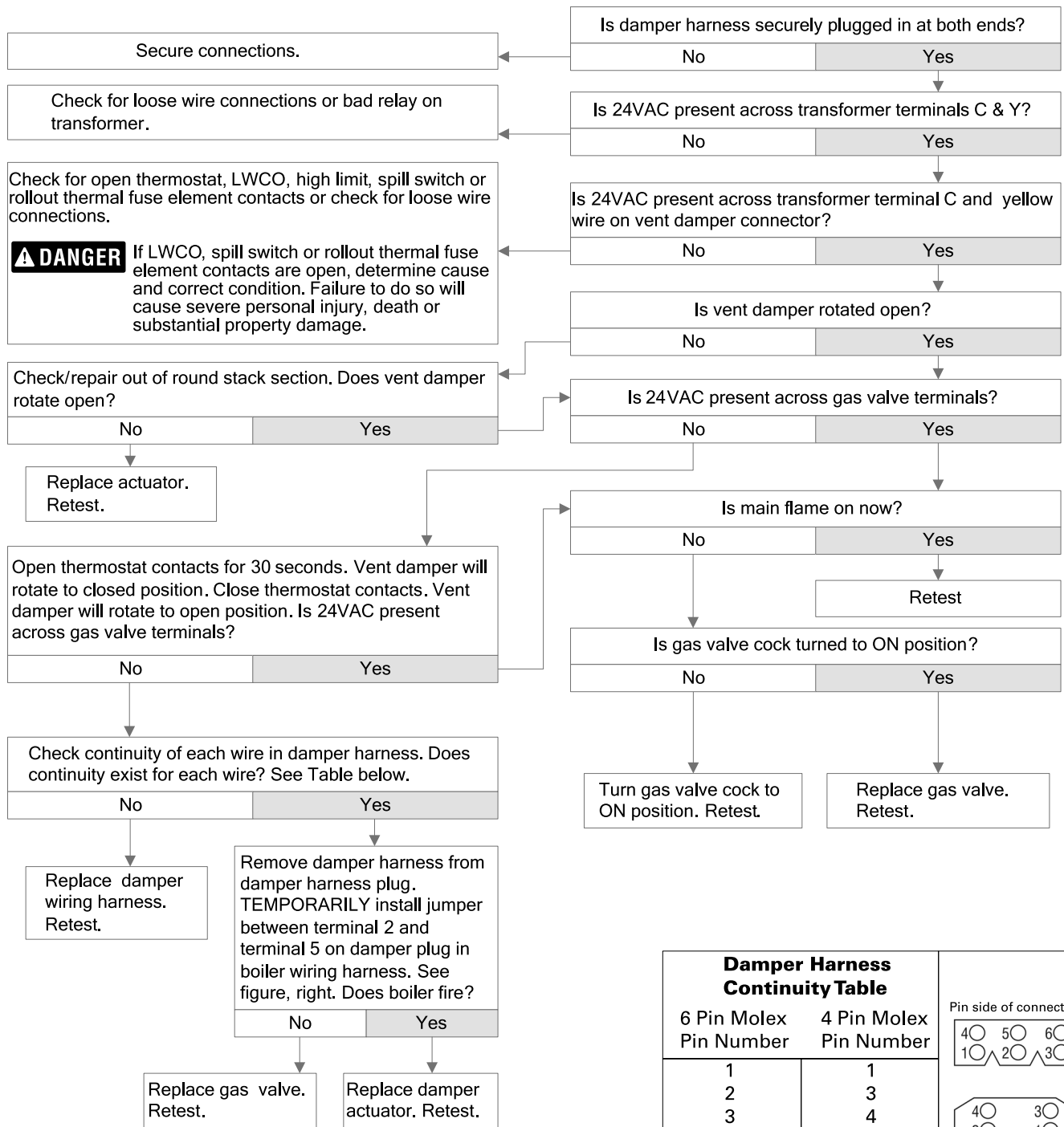

Damper Harness Continuity Table		Pin side of connectors
6 Pin Molex Pin Number	4 Pin Molex Pin Number	
1	1	
2	3	
3	4	
4	Not used	
5	2	
6	Not used	

03106



Troubleshooting continued

Chart 2: Boiler will not fire – water boilers with tankless

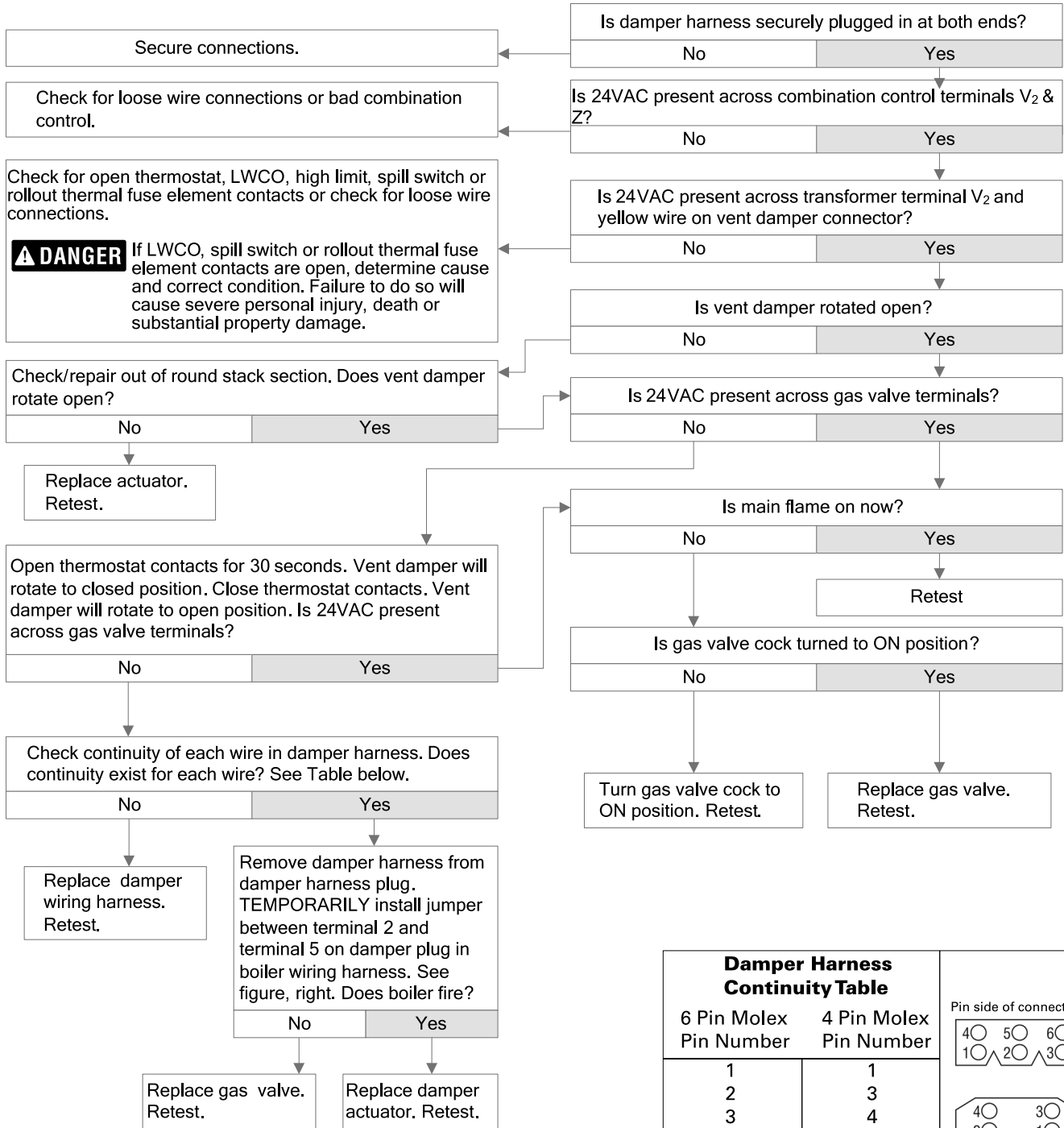

⚠ DANGER If LWCO, spill switch or rollout thermal fuse element contacts are open, determine cause and correct condition. Failure to do so will cause severe personal injury, death or substantial property damage.

Damper Harness Continuity Table		Pin side of connectors
6 Pin Molex Pin Number	4 Pin Molex Pin Number	
1	1	4○ 5○ 6○ 1○ 2○ 3○
2	3	
3	4	4○ 3○ 2○ 1○
4	Not used	
5	2	
6	Not used	

03106



Troubleshooting continued

Chart 3: Boiler will not fire – steam boilers with or without tankless

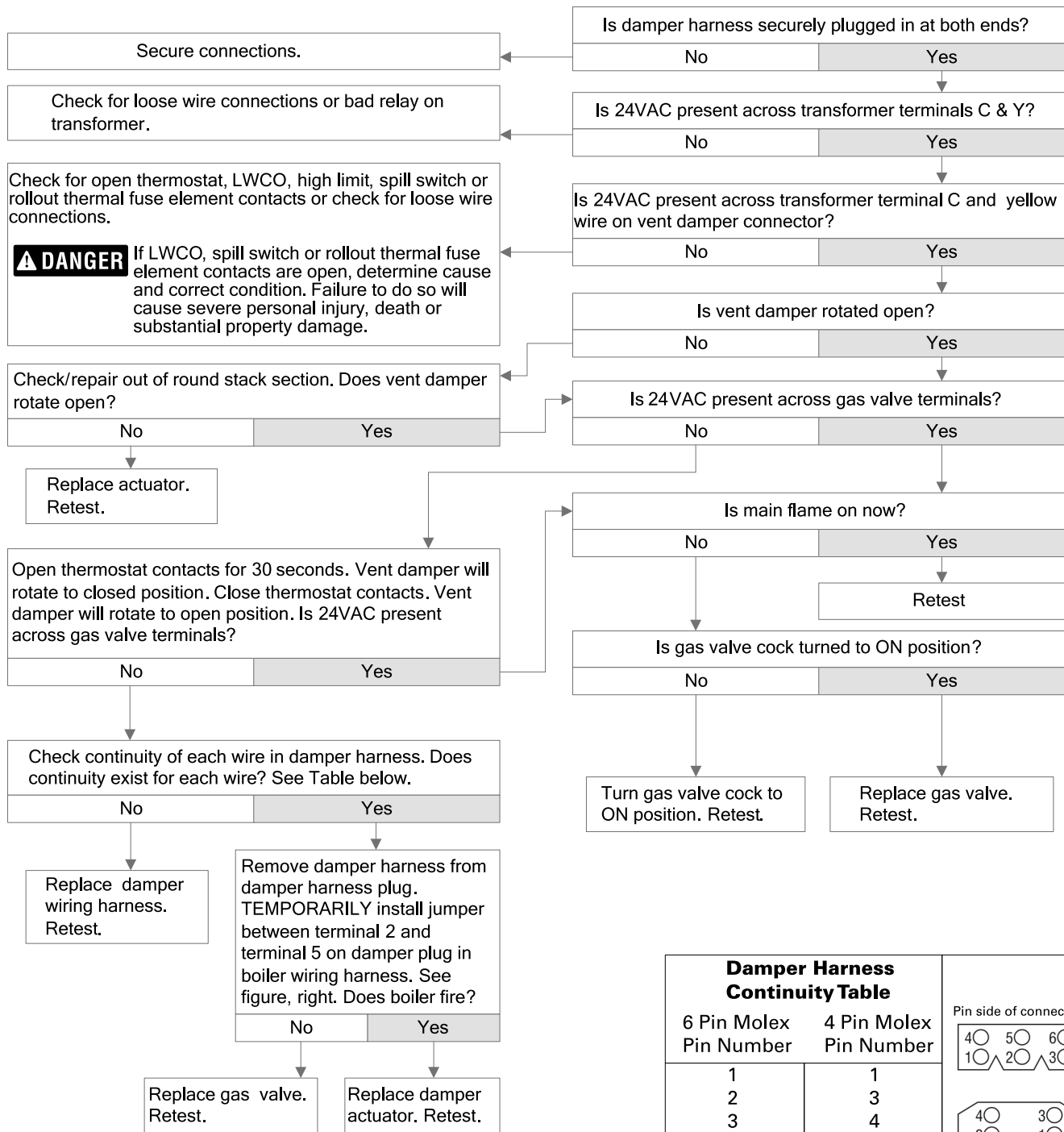

Damper Harness Continuity Table		Pin side of connectors
6 Pin Molex Pin Number	4 Pin Molex Pin Number	
1	1	
2	3	
3	4	
4	Not used	
5	2	
6	Not used	

03106



Replacement parts



Only dampers listed below are approved for use on EG-30 thru 75 Series 4, and PEG-30 thru 55 Series 4, standing pilot ignition system boilers. Any other damper installed can cause severe personal injury or death.

Description		Manufacturer / Mfr's part number	Weil-McLain part number
Damper assembly	5" — EG-30 and EG-35; PEG-30 and PEG-35	Effikal RVGP-KS-5BKF Field Controls GVD-5 Johnson Q35GD-2	381-800-475
	6" — EG-40 and EG-45; PEG-40 and PEG-45	Effikal RVGP-KS-6BKF Field Controls GVD-6 Johnson Q35GF-2	381-800-476
	7" — EG-50 and EG-55; PEG-50 and PEG-55	Effikal RVGP-KS-7BKF Field Controls GVD-7 Johnson Q35GH-2	381-800-477
	8" — EG-65 and EG-75; PEG-65	Effikal RVGP-KS-8BKF Field Controls GVD-8 Johnson Q35GK-2	381-800-478
Damper actuator		Effikal RVGP	510-512-337
Damper harness		Weil-McLain	591-391-795
Boiler wiring harness	EG-30 thru 75 water EG-35 thru 65 water with tankless EG-30 thru 75, steam, float LWCO EG-30 thru 75, PEG-30 thru 65, steam, probe LWCO	Weil-McLain	591-391-864 591-391-865 591-391-866 591-391-867
Pilot kit	EG/PEG-30 thru 65 Natural gas Propane gas	Weil-McLain	510-811-640 510-811-642
Pilot burner, EG-75		Honeywell Q327A1642	511-330-186
Thermopile, 36" long, EG-75		Robertshaw CP-2	511-724-259
Second pressuretrol wire harness		Weil-McLain	591-391-825
Thermopile lead wire, 5", EG-75		Robertshaw	590-850-561
Gas valve, natural gas	1/2" x 1/2", sizes 30 thru 50	Honeywell VR8200A2116 Robertshaw 7200ER 7A0-A1B-042	511-044-360
	3/4" x 3/4", 1.2 step, sizes 55 thru 65	Honeywell VR8300C4050	511-044-256
	3/4" x 1", size 75	Robertshaw 7000ERHC-S7C	511-044-505
Gas valve, propane gas	1/2" x 1/2", Propane gas, sizes 30 thru 50	Honeywell VR8200C1074	511-044-258
	3/4" x 3/4", Propane gas, sizes 55 thru 65	Honeywell VR8300C4100	511-044-257
	3/4" x 1", Propane gas, size 75	Robertshaw 7000ERHC-S7C	511-044-506



Weil-McLain
500 Blaine Street
Michigan City, IN 46360-2388
<http://www.weil-mclain.com>