



Features

- Integral flange.
- Right drain.
- Integral lumbar support and armrests for comfort.
- Textured bottom surface.
- Integral apron.
- 60" (1524 mm) x 36" (914 mm) x 20" (508 mm)

Material

- Acrylic

Installation

- Alcove

Recommended Accessories

K- 7161-AF Bath Drain



Codes/Standards

CSA B45.5/IAPMO Z124

ASTM E162

ASTM E662





Greenguard UL 2818 - Gold

KOHLER® One-Year Limited Warranty

See website for detailed warranty information.

Available Color/Finishes

Color tiles intended for reference only.

Color	Code	Description
	0	White
	96	Biscuit
	47	Almond
	NY	Dune
	G9	Sandbar

No changes in measurements if connected with drain illustrated. (K-7161-AF)

■ Recommended Faucet Area

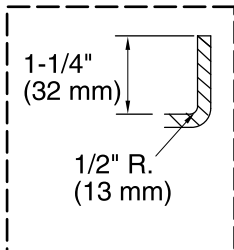

Flange Detail

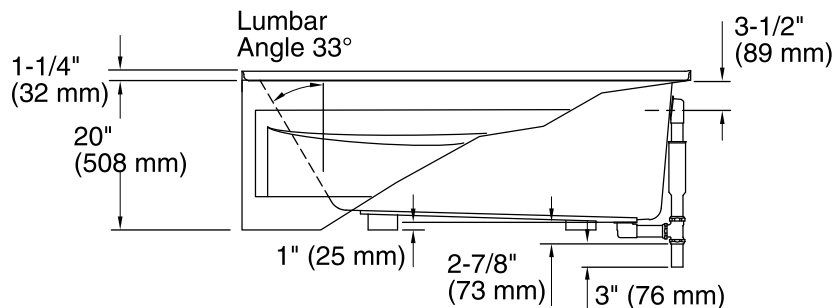
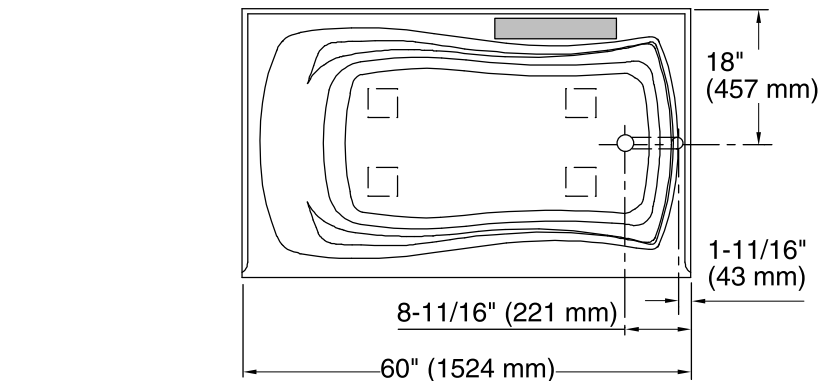
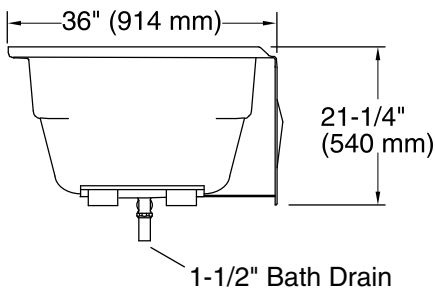

Technical Information

All product dimensions are nominal.

Installation:	3-Wall Alcove
Drain location:	Right
Basin area, bottom:	46" x 24" (1168 mm x 610 mm)
Basin area, top:	54" x 27" (1372 mm x 686 mm)
Weight:	62 lbs (28.1 kg)
Minimum floor load:	41 lbs/ft ² (200.2 kg/m ²)
Water depth:	14" (356 mm)
Water capacity:	63 gal (238.5 L)

Notes

Measure your actual product for rough-in details.

Install this product according to the installation instructions.

The hot water supply should be 70% of the capacity of the bath or greater. Installations will vary.

If installing a rim-mount faucet, make sure there is no interference with drain overflow before drilling any holes. Consult local and national codes for minimum air gap requirements if installing a spout on the faucet deck.