

Bodyvette Stop Bodyspray 28467XX1 Installation

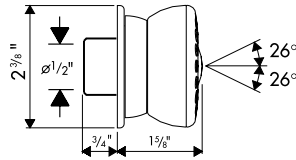
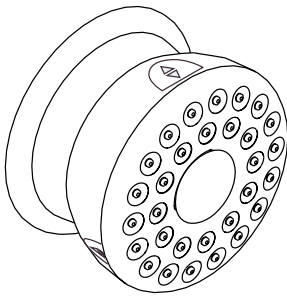

Required tools:

- Adjustable wrench - available at hardware and auto parts stores
- Plumber's thread tape (such as Teflon™ tape)
- Compatible, non-staining waterproof sealer

Bodyspray placement:

Custom shower systems are sized to the user or users. Bodysprays are normally placed at the upper back, middle back, and upper thigh. Always position bodysprays according to the preferences of the user(s).

Pressure Balancing Loop

If installing bodysprays in a bank of 3 or fewer, a pressure balancing loop is not necessary.

If installing bodysprays in a bank of 4 or greater, a pressure balancing loop must be used to keep the pressure even between the bodysprays.

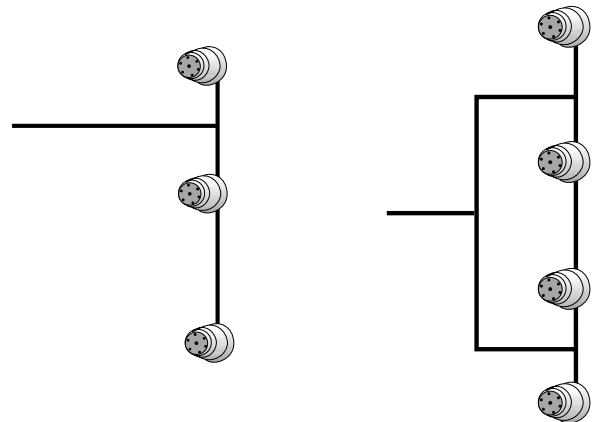

Rough-in Suggestion:

This installation requires a 1/2" male threaded pipe fitting **recessed 3/8"** from the surface of the finished wall. The plumber should install a properly anchored 1/2" female pipe fitting (i.e. a drop-ear ell) recessed into the wall, into which a brass pipe nipple of proper length can be fitted once the finished wall is complete.

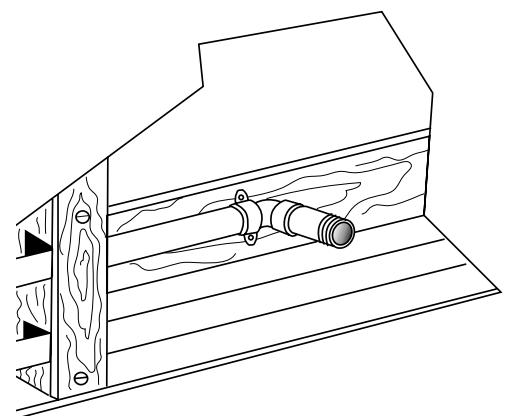

Installation Instructions

- Install 1/2" male threaded pipe fitting, recessed 3/8" behind the surface of the finished wall. Wrap the threads with plumbers' thread tape.
- Place the sealing gasket and trim ring against the wall. Screw the spray body through the trim ring and gasket, and onto the male pipe fitting. If the pipe fitting is recessed properly, the spray body will hold the trim ring firmly against the wall.

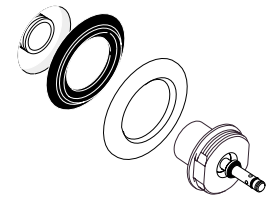

- Screw the escutcheon over the spray body.

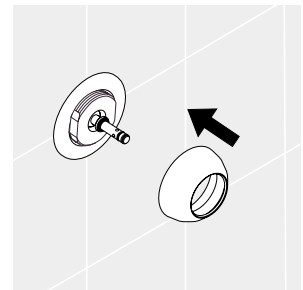

- Push the spray face firmly over the spray body. Secure in place with the white c-clip.

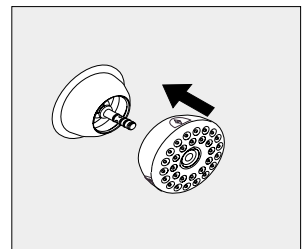

- Cover the c-clip with the cover.

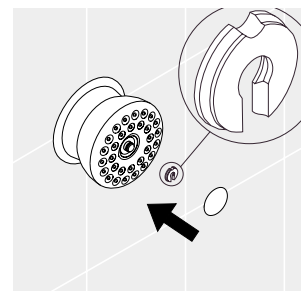

User Instructions

The Bodyvette Stop has a built-in temporary shutoff, which will allow you to temporarily stop the bodyspray. Pull the spray face out to shut the water down to a trickle, and push in to allow the water to flow.

