

### Features

- End drain.
- Integral lumbar support.
- 71-3/4" (1822 mm) x 36" (914 mm) x 20-7/8" (530 mm)

### Material

- Cast iron with Safeguard® finish.

### Installation

- Drop-in or under-mount.

### Required Accessories

K- 7169-AF 1-1/2" Contoured Pop-up Drain

### Recommended Accessories

K- 582 Under-mount Installation Kit

K- 1179 Vinyl Tiling-in Bead



### Codes/Standards











ASME A112.19.1/CSA B45.2

### KOHLER® Lifetime Limited Warranty for Cast Iron Components

See website for detailed warranty information.

### Available Color/Finishes

*Color tiles intended for reference only.*

Color	Code	Description
	0	White
	96	Biscuit
	47	Almond
	NY	Dune
	95	Ice™ Grey
	G9	Sandbar
	33	Mexican Sand™
	K4	Cashmere
	58	Thunder™ Grey
	7	Black Black™

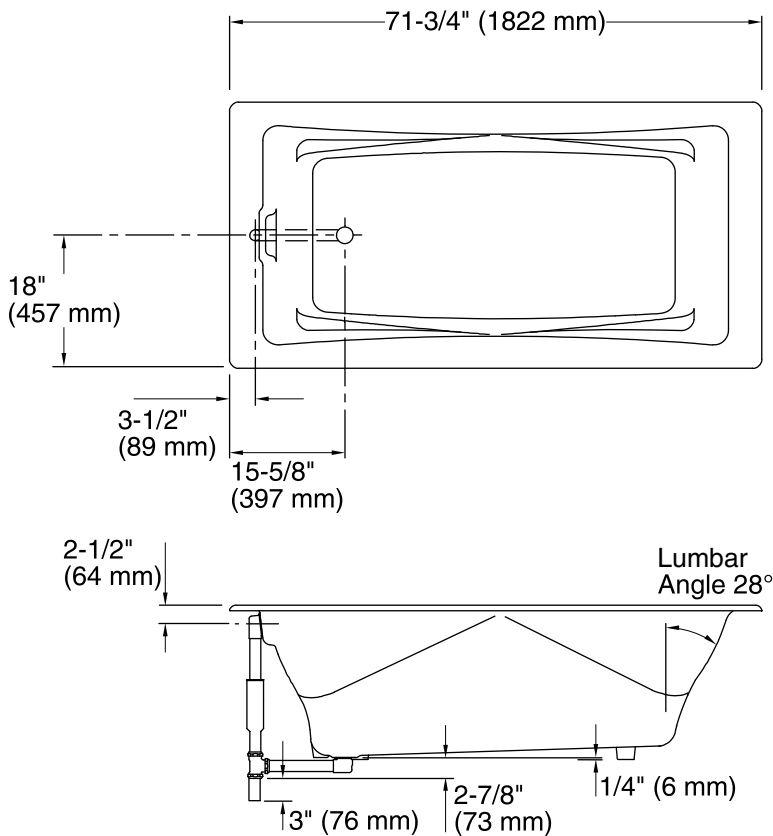

No change in measurements if connected with drain illustrated. (K-7169-AF)

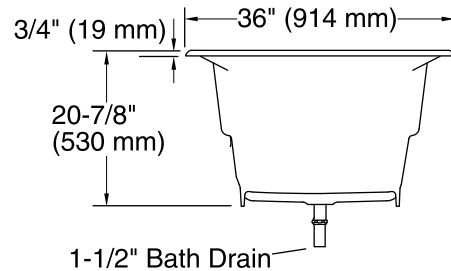

### Technical Information

All product dimensions are nominal.

Installation:	Drop-in, Under-mount
Drain location:	End
Basin area, bottom:	49" x 22" (1245 mm x 559 mm)
Basin area, top:	62" x 28" (1575 mm x 711 mm)
Weight:	404 lbs (183.3 kg)
Minimum floor load:	65 lbs/ft <sup>2</sup> (317.4 kg/m <sup>2</sup> )
Water depth:	17" (432 mm)
Water capacity:	89 gal (336.9 L)
Cutout:	Drop-in, 70-1/4" x 34-1/2" (1784 mm x 876 mm)
Template:	Under-mount, K-582, required, not included

### Notes

Measure your actual product for rough-in details.

Install this product according to the installation instructions.

The hot water supply should be 70% of the capacity of the bath or greater. Installations will vary.