



ej

# New England Municipal and Construction Castings



# Table of Contents

**Loading Requirements  
Cross Reference** **4  
89**

## New England Municipal and Construction Castings

Section	Description	Page
<b>Introduction</b>	New England Municipal and Construction Castings	3
	Loading Requirements, Proof Load Testing, Material Selection, and State Product Number Nomenclature	4
<b>General Overview</b>	We are EJ	5
	A Legacy is Cast	6
	Product Lines	7
	Capabilities	8
<b>Massachusetts Municipal and DOT Castings</b>	Massachusetts Cleanout/Monument Boxes	10
	Massachusetts Municipal Manhole Frames Covers	11
	Massachusetts Municipal Drainage Frames Grates	20
	Traps and Hoods	30
	MassDOT Frames, Covers, and Grates	32
<b>Rhode Island Municipal and DOT Castings</b>		37
	Rhode Island Municipal Frames, Covers, and Grates	38
	RIDOT Frames, Covers, and Grates	43
<b>Connecticut Municipal and DOT Castings</b>		49
	Connecticut Municipal Manhole Frames, Covers, and Grates	50
	Connecticut DOT	59
<b>New Hampshire Municipal Castings</b>		61
	New Hampshire Catch Basins	62
	New Hampshire Manhole Frame and Cover	64
<b>Vermont Municipal Castings</b>		65
	Vermont Standard Frame and Cover	66
	Vermont Drainage Frames and Grates	67
<b>Maine Municipal and DOT Castings</b>		71
	Maine Municipal Frames, Covers, and Grates	72
	MaineDOT Frames, Covers, and Grates	73
<b>Utility and Telecommunication Castings</b>		75
	1802-1825 Frames and Covers	76
	National Grid	77
	Northeast Utilities	78
	NSTAR	79
<b>Additional Solutions and Information</b>		81
<b>Cross Reference</b>		89

Square hole hook lock grate  
(page 24)

# New England Municipal and Construction Castings



**Complex infrastructure systems need reliable access solutions.**  
EJ products stand up to the task for urban, rural, industrial, and other applications.

## One Brand. Many Solutions.

Once known as East Jordan Iron Works, EJ is a family-owned company that has grown into a global supplier of infrastructure access solutions. Along the way, EJ acquired the strengths and talents of several reputable companies including LeBaron Foundry Corporation, formerly located in Brockton, Massachusetts.

EJ customers in the New England region can expect a robust portfolio of products and services designed to meet their specific needs—all backed by a legacy built on trust and reliability.

When doing business with EJ, you will receive the personal attention you are accustomed to, backed by an established global brand that delivers quality, value, and exceptional customer focus.

Thank you for considering products and services from EJ. We are eager to assist you with your continuing or future infrastructure needs.



**Loading Requirements**

All of our products are designed to meet or exceed the specified loading requirements. They conform to AASHTO and ASTM standards. These standards specify material quality and load requirements.

**Proof Load Testing**

All H-20 heavy duty traffic rated construction castings must pass a proof load test conducted in accordance with AASHTO M306 guidelines. The proof load testing procedure calls for the load to be concentrated on a 9" x 9" contact area in the center of the cover or grate and hold 40,000 pounds for one minute. Following the test the casting is carefully inspected. Cracks or permanent deformation are cause for rejection. Frequently, EJ castings are tested far beyond the specified proof load, often to destruction.

**Material Selection**

Depending on the model, our construction castings can be manufactured using either gray iron or ductile iron. Gray iron has an unequalled record of success as a material for construction castings. Gray iron is highly resistant to corrosion and maintains compressive strength, abrasion resistance, vibration absorption, and low-notch sensitivity. Additionally, gray iron has a long service life and is very cost effective. Ductile iron combines the advantages of gray iron with greater strength, toughness, higher impact resistance and increased durability without additional weight. Because it has the ability to withstand greater loads without failure, it is often specified for extra-heavy load applications.

**State Product Number Nomenclature**

When referencing state specific product numbers listed in this catalog, the following diagram will help you to understand the nomenclature. Note that some state specific products have been adopted for use in states outside of their original designation.

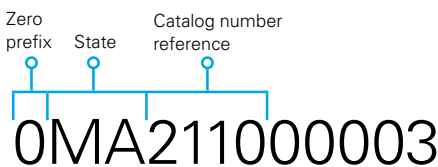

Gray and Ductile Iron Load Ratings and Descriptions

Rating	Acceptable Load Weight (lbs)	Description
Airport Extra Heavy Duty	Max. 200,000	Casting has been proof load tested to a minimum 200,000 lbs. This includes an additional safety factor over FAA design loading.
Extra Heavy Duty	Max. 100,000	Casting has been proof load tested to 100,000 - 200,000 lbs. This meets the design loading associated with the FAA wheel loading.
Heavy Duty	Max. 40,000	Casting must meet the requirements of AASHTO M306 to be classified as heavy duty. AASHTO M306 requires that castings bear a minimum of 40,000 lbs on a 9" x 9" area.
Medium Duty	Max. 16,000	Castings designated as medium duty accept loading from 16,000 - 40,000 lbs. These castings can accept standard traffic loading, and are in conformance with H-20/HS-20 (wheel load of 16,000 lbs. on a tire contact area of 8" x 20") or Federal Specification RR-F-621D (25,000 lbs. on a 9" x 9" load contact area).
Light Duty	Max. 2,500	Light duty castings are able to withstand some vehicular loading, but are not designed to accept roadway traffic. Items can accept loading from 2,500-16,000 lbs. These products may be subject to occasional traffic from process maintenance, mowers, etc.
Non-traffic	Under 2,500	Castings designated as non-traffic are intended for use in areas that are not subject to vehicle traffic. Generally nothing over 2,500 lbs. should be placed on these items. Duty rating is 0 - 2,500 lbs.

**Heavy Duty Rating**

Unless otherwise noted, products in this catalog are Heavy Duty rated. Please refer to product drawings for specific details.

**Made in the USA**

All products are Made in the USA and meet Buy America requirements.

**If You Don't See It, Ask Us**

Products listed in this catalog are not all inclusive. Visit [ejco.com](http://ejco.com), or contact your EJ sales representative, for our full line of products, information, product drawings, and additional support.

# We are EJ

EJ is the leader in the design, manufacture and distribution of access solutions for water, sewer, drainage, telecommunications and utility networks worldwide.

EJ offers the broadest range of high-quality infrastructure access solutions. Our distribution coverage continues to expand into new markets. As an entrepreneurial family-owned company, we have a long, successful heritage of meeting change with innovation.

Since our founding in 1883, we have grown by providing access solutions to meet the demands of the world's growing infrastructure. Fueled by innovation, our design, manufacturing and distribution processes continue to evolve—creating solutions that provide an unparalleled customer experience.

EJ is a family-owned company that has a long history of fostering strong customer relationships. These relationships are supported with personal contact from company representatives, a complete offering of product literature, a comprehensive web site (ejco.com), trade show exhibits, as well as seminars and training opportunities. All these services help to provide customers with the product information required for successful projects.

Wherever you are, EJ provides access solutions that adhere to the local specifications in a timely and competitive manner. We also work with our customers to produce access solutions to meet their specialized requirements. Our sales staff around the world understands the unique needs of your market.

Our people: our core strength. While working together, employees use their expertise, knowledge, and ability to achieve positive results. Core values at EJ include, safety and security, honesty and integrity, environmental responsibility, respect for others, quality and excellence and social responsibility. These core values are imbedded into our culture and are practiced daily throughout the organization.

Our state-of-the-art manufacturing plants employ world class machinery, systems and processes to produce specified products efficiently and on time.

Wherever you are, whatever your specific requirement might be, EJ has the best access solutions for your infrastructure project.



### Product Range

EJ offers a comprehensive portfolio of products and services, including municipal and construction castings, fabricated products, water distribution solutions and other infrastructure access solutions.

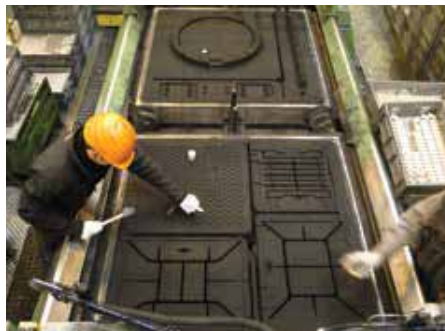

### Quality Manufacturing

Integrating technology, lean processes and over a century of experience in crafting metal castings and fabrications, keeps our facilities performing at peak efficiencies.



### Distribution Network

Access solution products, including municipal and construction castings, are available worldwide at our internal stocking locations and from our extensive network of distribution partners.

# A Legacy is Cast



William E. Malpass (standing back right, next to window) with employees during the 1920s.

The EJ legacy dates back to 1883 when William E. Malpass and his father-in-law Richard W. Round established a foundry on the shores of Lake Charlevoix, in the town of East Jordan, Michigan, USA. This foundry was called East Jordan Iron Works and originally produced cast parts for the lumber industry, machinery, ships, agricultural equipment and railroads.

In the 1920s, when the lumbering era came to a close, the company expanded into new markets allowing continued success in changing times and shifted to the production of street castings, water works valves, fire hydrants and various industrial castings.

During World War II the foundry produced castings for the war effort.

In the 1950s, semi-automation was introduced into the foundry. During the 60s, the third generation converted the foundry to an automated high-pressure molding line. By integrating automatic sand processing and mechanized casting handling systems, the company was operating the largest

automated molding line in the United States and maximized production capabilities.

Since the mid-1980s, the business has been led by the fourth generation descendants of the Malpass family. They have transformed the Midwest business into an international leader of construction castings.

In the 1990s, new acquisitions throughout the United States allowed the company to expand product lines, sales offices, distribution capabilities and customer service across North America. In 2001, a new foundry was built in Oklahoma, providing additional capacity to service the construction castings market.

The 21st century had barely introduced itself when East Jordan Iron Works began turning its attention to expansion in other parts of the world, including Cavanagh Foundry in Ireland (2000), Norinco in France (2004), McCoy Construction Castings in Canada (2006) and HaveStock in Australia (2010).

In 1999, the fifth generation of the Malpass family began joining the company to continue the strong family commitment to its success. Dedicated to maintaining the company's long-established culture and values, they are significantly involved in strategies and priorities, bringing a renewed energy and enthusiasm to the company.

In 2012, East Jordan Iron Works and its affiliated companies began doing business using the same name and brand, EJ. One global name and brand, supported by a single mission, vision and set of values has unified the company. This action leverages all company resources to improve internal operations, as well as provide superior product offerings and services to its valued customers. EJ has supplied products to infrastructure projects in over 140 countries around the world.

EJ continues to be 100% owned and operated by the Malpass family with corporate headquarters located in East Jordan, Michigan.



# Product Lines

## Street Castings

- Manhole Frames and Covers
- Curb Inlets and Frames
- Utility Castings
- Airport and Port Authority Castings
- Tree Grates
- Trench Grates
- Drainage Grates
- DURALAST® Detectable Warning Plates



## Fabricated Products

- Grating
- Riser Rings
- INFRA-RISER® Adjustment Risers
- Aluminum Access Hatches
- Custom Fabrications



## Water Products

- WaterMaster® Fire Hydrants
- FlowMaster® RW Gate Valves
- Valve Boxes
- Meter Boxes

## Innovative Access Solutions

- Captive Hinge Grates/Covers
- ERGO® and ERGO® XL Access Assemblies
- Ductile Hinged Hatch Access Assemblies
- 5624 Heavy Duty Hinged Grates
- SELFLEVEL® Access Assemblies
- REVOLUTION® Access Assemblies
- ERMATIC® Modular Covers
- Multi-Leaf® Hinged Covers
- COMPRESSION® Access Assemblies
- Composite Access Covers



## Innovative Features

- LOCKEO® Security Feature
- Mechanical Strut Lift Assist
- Cam Lock
- EON LOCK® Designs
- EPIC® Pick Bar
- MPIC® Multi-tool Pick Bar



# Capabilities

## Service

- Employees with localized knowledge throughout the world
- On-site assistance
- Seminars and technical presentations
- Communicate new product innovations
- Assistance with specification process

## Innovative Use of Technology

- Electronic invoicing
- EDI transactions
- ejco.com—comprehensive product database with advanced search and browsing capabilities
- Electronic certification of materials provided upon request
- CAD and PDF drawings available electronically

## Quality Manufacturing

- Product research and development
- Commitment to reinvestment
- North America ISO 9001 certified facilities
- Europe ISO 9001, ISO 14001, OHSAS 18001 certified facilities
- Australia ISO 9001 certified facilities

## Foundry Facilities

- East Jordan, Michigan
- Ardmore, Oklahoma
- Picardie/St. Crepin, France

## Fabrication Facilities

- Birr, Ireland
- Youngstown, Ohio
- Cicero, New York
- Tooele, Utah
- Ardennes/Bogny sur Meuse, France
- Geebung/Queensland, Australia

## Water Products Manufacturing

- East Jordan, Michigan

## Distribution

- Delivering products quickly and smoothly worldwide
- Stocking branch locations throughout U.S., Canada, Europe, and Australia
- Distribution centers located in Michigan, Oklahoma, Ireland, France, and Australia

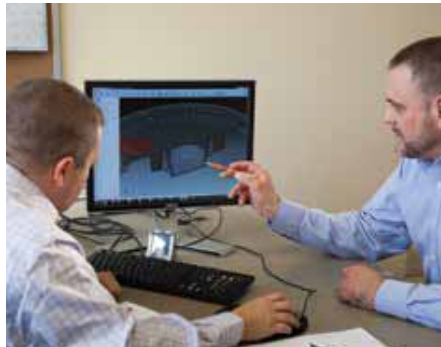



# Massachusetts Municipal and DOT Castings



## CLEANOUT/MONUMENT BOXES

### Features

Heavy duty

### Options

Custom badging/lettering

Security bolting

7", 8", or 10" frame height

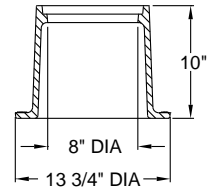
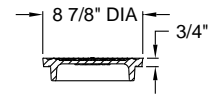

OMA157000006 frame and cover

### Frame Options

Frame Height	Product Number
9	OMA157000001

Note: all dimensions are in inches.

### 9" Cover Options

Cover Type	Lettering	Product Number
Solid*	Plain	OMA157000002
Solid*	Sewer	OMA157000003
Solid*	Drain	OMA157000004
Solid*	Cleanout	OMA157000005

\* Bolted cover available

### Additional Assembly Options

Frame Height	Cover Size	Flange Size	Product Number
7	8	13 1/4	00296520C03
8	12	18	0DE156400001
8	10 1/4	15 (across flats) 16 (outside)	00156621C02
10	9	13 3/4	OMA157000006

Note: all dimensions are in inches.

## 24" MANHOLE FRAMES, COVERS, AND GRATES

### Features

Heavy duty

### Options

Solid, flat grate, or ADA grate

Custom badging/lettering

Gasket seal covers

4", 6", or 8" frame height

EPIC® pick bar

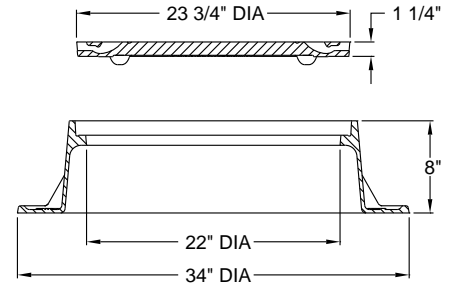

OMA124000014 frame and cover

### Frame Options

Frame Height	Product Number
4	OMA124000021
6	OMA124000022
8	OMA124000023

Note: all dimensions are in inches.

### 24" Cover Options

Cover Type	Lettering	Product Number
Solid*	Plain	OMA124000024
Solid*	Sewer	OMA124000025
Solid*	Drain	OMA124000026
Solid, gasket seal	Plain	OMA124000027
Solid, gasket seal	Sewer	OMA124000028
Flat grate	Dump No Waste!	OMA124000029
ADA grate	Dump No Waste!	OMA112000001

\*Bolted cover available

### Cover Options



Flat grate



ADA grate



Gasket cover



Watertite assembly



## 26" MANHOLE FRAMES, COVERS, AND GRATES

### Features

Heavy duty

### Options

Solid, flat grate, or ADA grate

Custom badging/lettering

Gasket seal covers

4", 6", or 8" frame height

EPIC® pick bar



OMA211000024 frame and cover

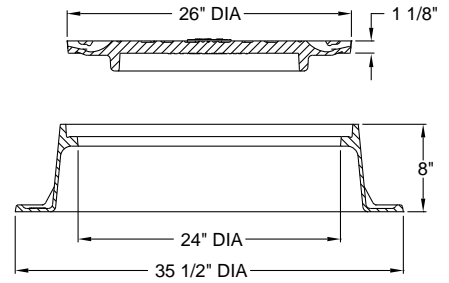

OMA211000024 dimensions shown

### Frame Options

Frame Height	Product Number
4	OMA226000001
6	OMA226000002
8	OMA211000038

Note: all dimensions are in inches.

### 26" Cover Options

Cover Type	Lettering	Product Number
Solid*	Plain	OMA211000039
Solid*	Sewer	OMA211000040
Solid*	Drain	OMA211000041
Solid, gasket seal	Plain	OMA211000042
Solid, gasket seal	Sewer	OMA211000043
ADA grate	Dump No Waste!	OMA211000045
Flate grate	Dump No Waste!	OMA211000044

\*Bolted cover available.

### Cover Options



Solid plain open pick hole



ADA grate



Flate grate



Gasket cover



Watertite assembly

## 32" MANHOLE FRAMES AND COVERS

### Features

Heavy duty

### Options

- Solid, flat grate, or ADA grate
- Custom badging/lettering
- Gasket seal covers
- 4", 6", or 8" frame height
- EPIC® pick bar
- Security bolting



OMA200000008 frame and cover

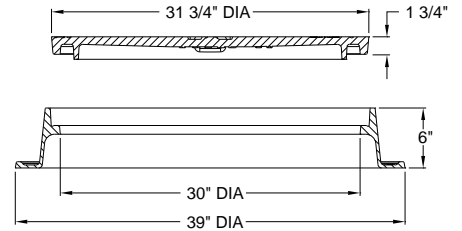

OMA200000008 dimensions shown

### Frame Options

Frame Height	Product Number
4	OMA200000022
6	OMA200000023
8	OMA200000024

Note: all dimensions are in inches.

### Cover Options

Cover Type	Lettering	Product Number
Solid*	Plain	OMA200000025
Solid*	Sewer	OMA200000026
Solid*	Drain	OMA200000027
Solid, gasket seal	Plain	OMA200000028
Solid, gasket seal	Sewer	OMA200000029

\* Bolted cover available



OMA200000020 32 x 6 watertite assembly plain



OMA200000030 gasket seal CATV

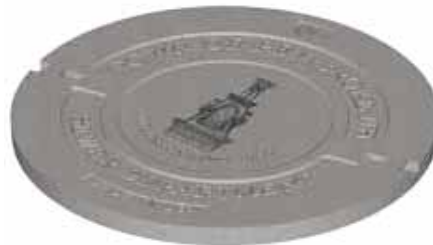

00200656 Pembroke cover

## WORCESTER 23" FRAMES, COVERS, AND GRATES



OMA105000010 frame and cover

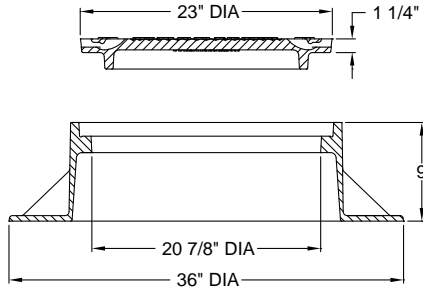

OMA105000010 dimensions shown

### Frame Options

Frame Height	Product Number
4	OMA105000014
9 standard	OMA105000004
9 bolted	00105613

Note: all dimensions are in inches.

### Cover Options

Cover Type	Lettering	Product Number
Solid	Worcester A Town Since June 14, 1722 A City Since Feby 29, 1848	OMA105000005
Solid, gasket seal	Worcester A Town Since June 14, 1722 A City Since Feby 29, 1848	OMA105000008
Flat grate	Plain	OMA105000009

\*Bolted cover available

### Cover Options



Worcester logo cover



Watertite assembly



Gasket seal



Flat grate



## BOSTON WATER AND SEWER COMMISSION (BWSC) FRAMES AND COVERS

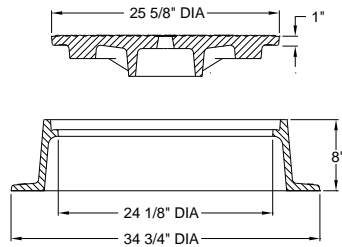

0MA211000030 frame and cover

Frame Options

Frame Height	Product Number
8	0MA211000046

Cover Options

Lettering	Product Number
Boston Sewer	0MA211000047
Boston Drain	0MA211000048

Note: all dimensions are in inches.

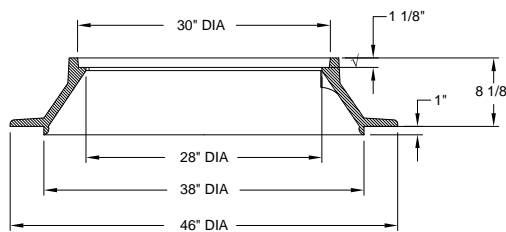

00191711 frame and 00191723 cover

Frame Options

Frame Height	Product Number
8 1/8	00191711

Cover Options

Lettering	Product Number
Boston Sewer	00191721
Boston Drain	00191723

Note: all dimensions are in inches.

## FROST PROOF MANHOLE FRAME AND COVER

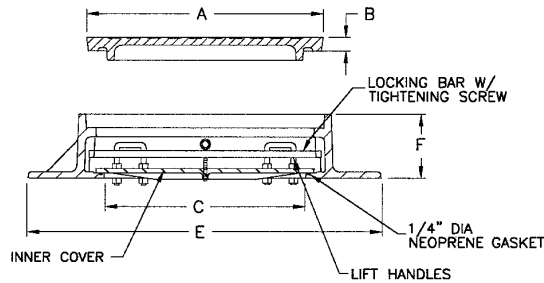

1123 series frost proof manhole assembly

### Frost Proof Manhole Assembly Options

<b>A</b> Cover Diagram	<b>B</b> Cover Thickness	<b>C</b> Clear Open	<b>E</b> Flange Dia.	<b>F</b> Frame Height	Series Number
24	1 1/2	19 7/8	33 7/8	7	1123
26	1 1/2	22	39	7	1041
25 3/5	1 1/4	22 1/16	43 1/4	11 1/2	1706
26	1 1/2	22 1/8	38 3/4	7	1044
28 3/4	1 3/8	24 1/2	37 1/2	7	1893
31 3/4	1 3/8	28	40	7	1233
32	1 1/2	28	40	6 1/2	1323
38 1/2	1 1/2	34	45	10 1/8	1583

Note: all dimensions are in inches.

## HAND HOLE/PULL BOX FRAMES AND COVERS



OMA801200002 frame and 00801221 solid cover



00811812 frame and 00811825 BSWC cover



OMA801000003 frame and OMA801000012 electric cover



OMA801300001 frame and OMA801300014 CATV cover

### Hand Hole/Pull Box Assembly Options

Cover Size	Lettering	Cover Thickness	Clear Opening	Frame Height	Flange Dim.	Product Number
12 x 12	Plain	1	10 3/4 SQ	3 1/2	17 1/4 SQ	OMA801200002 / 00801221
16 x 18	BWSC	1 3/8	15 7/8 x 13 15/16	6 1/2	25 5/8 x 23 5/8	00811812 / 00811825
23 3/4 x 23 3/4	Electric	15/16	21 7/8 SQ	3	30 SQ	OMA801000003 / OMA801000012*
12 3/4 x 24 3/4	CATV	1 1/2	24 x 12	3	29 3/4 x 17 3/4	OMA801300001 / OMA801300014

\* Medium duty rated  
Note: all dimensions are in inches.



## V-1600/V-1800 FRAMES AND COVERS

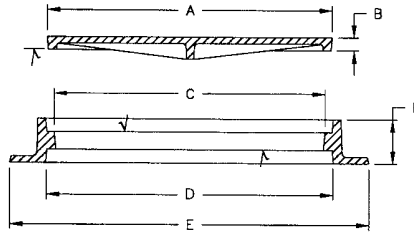

V-1600-4 assembly

### Features

Heavy duty

Reversible frame (BF = V-1600, TF = V-1800)

### Options

Solid or vented covers

Special lettered covers

Custom logo covers

Bolted assemblies

Grates (see V-3600/V-3800)

Hinged unit available in select sizes

V-1600/V-1800 Frame and Cover Options

Catalog Number	A Cover Diameter	B Cover Thickness	C Clear Opening	D Frame Opening	E Flange Diameter	F Height
V-1600-1	19 1/4	1 1/2	18 1/4	19 1/2	24	4
V-1600-2	23 1/2	1 1/2	22	23 3/4	28 1/2	4
V-1600-3	25 3/8	1 1/2	24	25 5/8	32 1/8	4
V-1600-4	31 3/4	1 3/8	30	32 1/8	38	4
V-1600-5	38	2	36	38 1/4	46	6
V-1600-6	50 1/4	2	48	50 1/2	56 1/2	6
V-1800-1	19 1/4	1 1/2	18 1/4	20 1/2	24	4
V-1800-2	23 1/2	1 1/2	22	24 3/4	28 1/2	4
V-1800-3	25 3/8	1 1/2	24	26 5/8	32 1/8	4
V-1800-4	31 15/16	1 3/8	30	33 1/8	38	4
V-1800-5	38	2	36	40	46	6
V-1800-6	50 1/4	2	48	52	56 1/2	6

Note: all dimensions are in inches.

## V-1610/V-1810 FRAMES AND COVERS

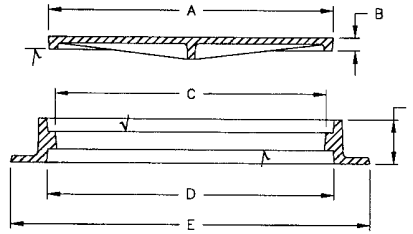

V-1610-4 assembly

Features  
 Heavy duty  
 Reversible frame

Options  
 Special lettered covers  
 Logo covers  
 Bolted assembly  
 Grates (see V-3610)

V-1610/V-1810 Frame and Cover Options

Catalog Number	Pipe Size	A Cover Dia.	B Cover Thickness	C Clear Opening	D Frame Opening	E Flange Dia.	F Height
V-1610-1	12	10 1/4	1 1/2	8 1/2	10 1/2	14 1/2	4
V-1610-2	15	13 1/4	1 1/2	11 1/2	14 1/2	17 5/8	4
V-1610-3	18	16 1/4	1 1/2	14 3/8	17 1/2	20 1/2	4
V-1610-4	24	21 7/8	1 1/2	20 1/4	23 5/8	26 5/8	4
V-1610-5	30	27 7/8	1 1/2	26 3/8	29 3/8	32 1/2	4 1/8
V-1610-6	36	33 7/8	1 1/2	32	35 1/2	38 1/2	4 1/8
V-1610-7	42	39 5/8	1 1/2	38 1/4	41 1/2	44 1/2	4
V-1610-8	48	45 3/4	1 1/2	43 3/4	47 3/4	50 1/2	4
V-1810-1	12	10 1/4	1 1/2	8 1/2	10 1/2	14 1/2	4
V-1810-2	15	13 1/4	1 1/2	11 1/2	14 1/2	17 5/8	4
V-1810-3	18	16 1/4	1 1/2	14 1/2	17 1/2	20 1/2	4
V-1810-4	24	21 7/8	1 1/2	20 1/4	23 5/8	26 5/8	4
V-1810-5	30	27 7/8	1 1/2	26 3/8	29 1/8	32 1/2	4
V-1810-6	36	33 7/8	1 1/2	32	35 5/8	38 1/2	4
V-1810-7	42	39 5/8	1 1/2	38 1/4	41 1/2	44 1/2	4
V-1810-8	48	45 3/4	1 1/2	44 1/2	47 3/4	50 1/2	4

Note: all dimensions are in inches.

## 24" X 24" CATCH BASINS



OMA552000028 3 flange frame and square grate

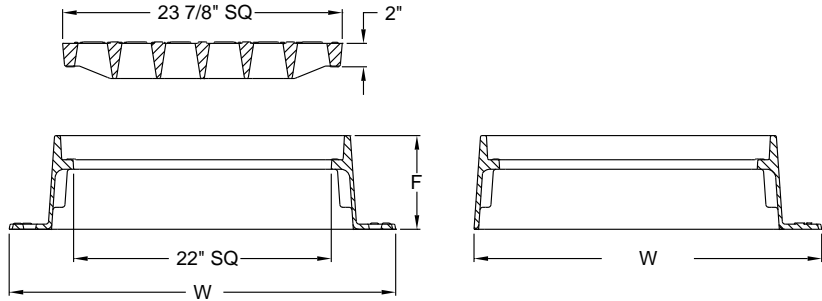

3 flange dimensions shown



OMA554000006 4 flange frame

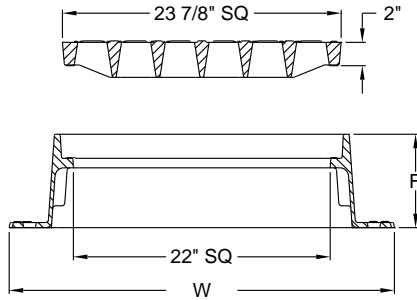

4 flange dimensions shown

See page 21 for grate and assembly options

Frame Options

F Frame Height	Flange	W Flange Dimension	Product Number
<b>Standard Frame</b>			
4	3 flange	32 x 29 1/8	OMA554000001
4	4 flange	32 x 32	OMA554000002
6	3 flange	33 x 29 7/8	OMA554000003
6	4 flange	33 x 33	OMA554000004
8	3 flange	33 x 29 11/16	OMA554000005
8	4 flange	33 x 33	OMA554000006
<b>Drop Inlet</b>			
4	3 flange	32 x 29	OMA552000016
4	4 flange	32 SQ	OMA552000015
<b>Heavy Frame</b>			
8	3 flange	34 x 30 5/16	OMA552000081
8	4 flange	34 SQ	OMA552000082

Note: all dimensions are in inches.



Grates Options



Standard grate



Square hole grate



ADA grate

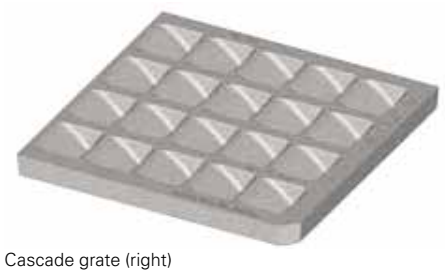

Cascade grate (right)  
\* left hand also available

24" x 24" Grate Options

Grate Type	Product Number
Standard grate	OMA552000074
Square hole grate	OMA552000075
Cascade grate (left)	OMA552000076
Cascade grate (right)	OMA552000077
ADA grate	OMA552000078

24" x 24" Catch Basin Assembly Options

Frame Height	Flanges	Product Number
<b>Standard Grate</b>		
4	3 flange	OMA552000018
4	4 flange	OMA552000019
6	3 flange	OMA552000020
6	4 flange	OMA552000021
8	3 flange	OMA552000022
8	4 flange	OMA552000023
<b>Square Hole Grate</b>		
4	3 flange	OMA552000024
4	4 flange	OMA552000025
6	3 flange	OMA552000026
6	4 flange	OMA552000027
8	3 flange	OMA552000028
8	4 flange	OMA552000029
<b>ADA Grate</b>		
4	3 flange	OMA552000042
4	4 flange	OMA552000043
6	3 flange	OMA552000044
6	4 flange	OMA552000045
8	3 flange	OMA552000046
8	4 flange	OMA552000047

Note: all dimensions are in inches.

24" x 24" Catch Basin Assembly Options

Frame Height	Flanges	Direction	Product Number
<b>Cascade Grate</b>			
4	3 flange	Left	OMA552000030
4	3 flange	Right	OMA552000032
4	4 flange	Left	OMA552000031
4	4 flange	Right	OMA552000033
6	3 flange	Left	OMA554600001
6	3 flange	Right	OMA554600002
6	4 flange	Left	OMA552000035
6	4 flange	Right	OMA552000037
8	3 flange	Left	OMA552000038
8	3 flange	Right	OMA552000040
8	4 flange	Left	OMA552000039
8	4 flange	Right	OMA552000041

Note: all dimensions are in inches.



## 24" X 48" CATCH BASINS

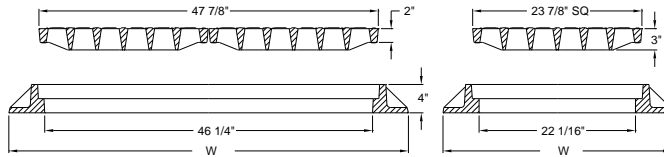

OMA544400012 frame

Note: 4 flange shown. 3 flange available with long side deleted or short flange deleted

4 flange dimensions shown

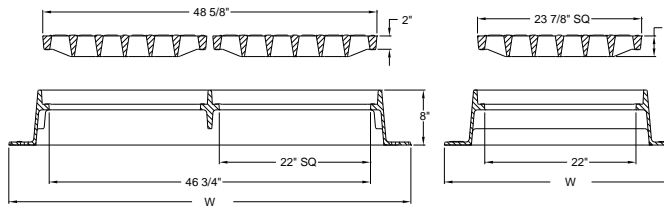

OMA544000002 frame

Note: 4 flange shown. 3 flange available with long side deleted or short flange deleted

4 flange dimensions shown

### Frame Options

Frame	Flange	W Flange Dimension	Product Number
4	3 flange (long flange deleted)	56 3/8 x 29 5/16	OMA544400011
4	3 flange (short flange deleted)	53 3/8 x 32 1/4	OMA544400106
4	4 flange	56 3/8 x 32 1/4	OMA544400012
8*	3 flange (long flange deleted)	58 1/2 x 30 3/16	OMA544000001
8*	3 flange (short flange deleted)	54 15/16 x 33 3/4	OMA544400107
8*	4 flange	58 1/2 x 33 3/4	OMA544000002

\*8" frames feature center support bar  
Note: all dimensions are in inches.

See page 2 for grate and assembly options

Grates Options



Standard grate



Square hole grate



ADA grate



Cascade grate (right)  
\* left hand also available

24" x 48" Grate Options

Grate Type	Product Number
Standard grate	OMA552000074
Square hole grate	OMA552000075
Cascade grate (left)	OMA552000076
Cascade grate (right)	OMA552000077
ADA grate	OMA552000078

Note: 2 grates required per frame

24" x 48" Catch Basin Assembly Options

Frame Height	Flanges	Product Number
<b>Standard Grate</b>		
4	3 flange (long flange deleted)	OMA544400001
4	3 flange (short flange deleted)	OMA544400100
4	4 flange	OMA544400001
8	3 flange (long flange deleted)	OMA552000064
8	3 flange (short flange deleted)	OMA552000202
8	4 flange	OMA552000065
<b>Square Hole Grate</b>		
4	3 flange (long flange deleted)	OMA544400003
4	3 flange (short flange deleted)	OMA544400101
4	4 flange	OMA544400004
8	3 flange (long flange deleted)	OMA552000066
8	3 flange (short flange deleted)	OMA552000203
8	4 flange	OMA552000067
<b>ADA Grate</b>		
4	3 flange (long flange deleted)	OMA544400009
4	3 flange (short flange deleted)	OMA544400105
4	4 flange	OMA544400010
8	3 flange (long flange deleted)	OMA552000072
8	3 flange (short flange deleted)	OMA552000206
8	4 flange	OMA552000073

Note: all dimensions are in inches.

24" x 48" Catch Basin Assembly Options

Frame Height	Flanges	Direction	Product Number
<b>Cascade Grate</b>			
4	3 flange (short flange deleted)	Left	OMA544400102
4	3 flange (long flange deleted)	Left	OMA544400005
4	3 flange (short flange deleted)	Right	OMA544400103
4	3 flange (long flange deleted)	Right	OMA544400007
4	4 flange	Left	OMA544400006
4	4 flange	Right	OMA544400008
8	3 flange (short flange deleted)	Left	OMA552000204
8	3 flange (long flange deleted)	Left	OMA552000068
8	3 flange (short flange deleted)	Right	OMA552000205
8	3 flange (long flange deleted)	Right	OMA552000070
8	4 flange	Left	OMA552000069
8	4 flange	Right	OMA552000071

Note: all dimensions are in inches.

## CITY OF BOSTON 28" X 28" FRAMES, COVERS, AND GRATES



OMA728800018 3 flange frame with grate



3 flange frame with BSD cover

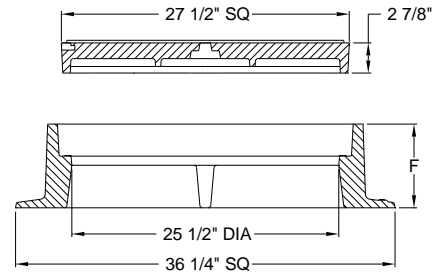

4 flange dimensions shown

### Frame Options

F	Frame Height	Flanges	Product Number
	4	3 flange	OMA728800022
	4	4 flange	OMA728800023
	8	3 flange	OMA728800012
	8	4 flange	OMA728800013

### 28" x 28" Grate and Cover Options

Cover Type	Product Number
Solid, BSD	00728825
Grate	OMA728800014

Note: all dimensions are in inches.



00726725 Charles River catch basin sign

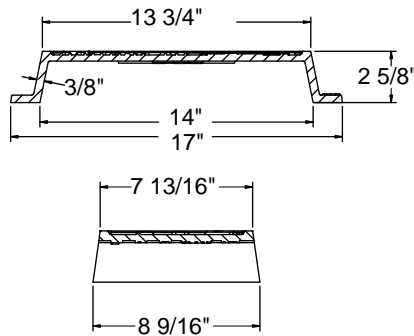

### Catch Basin Sign Options

Product Number	Lettering
00726722	Don't Dump Drains to Boston Harbor
00726724	Don't Dump Drains to Neponset River
00726728	Don't Dump Drains to Charles River

## SQUARE HOLE HOOK LOCK GRATE



24" square hole hook lock grate

### Grate Options

Grate Type	Product Number
Hook lock square hole grate	00552064A01

Note: grate fits all frames listed on page 20.

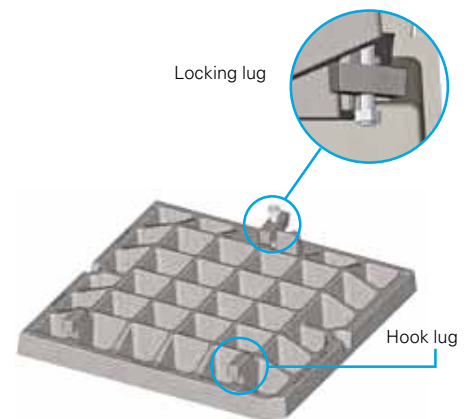

Underside view

## WORCESTER 28" X 28" FRAMES AND GRATES

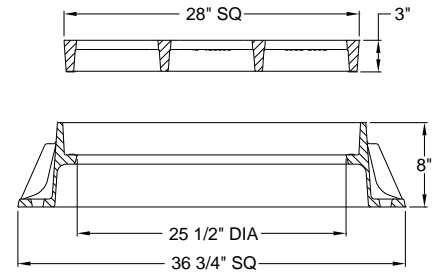

0MA728800018 Worcester 3 flange frame and grate

0MA728800019 Worcester 4 flange frame and grate

4 flange dimensions shown

### Frame Options

Frame Height	Flanges	Product Number
8	3 flange	0MA728800015
8	4 flange	0MA728800016

### 28" x 28" Grate Options

Cover Type	Product Number
Grate	0MA728800017

Note: all dimensions are in inches.

## "D" FRAMES AND GRATES

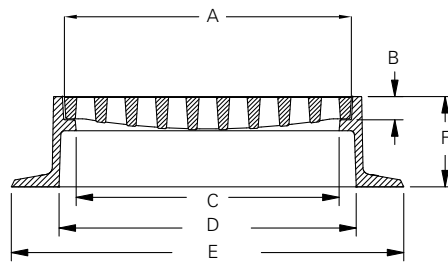

00726811 / 00726831 frame and grate

00727833 grate

### "D" Frame Options

F Frame Height	C Clear Opening	D Flange Opening	E Flange Size	Product Number
8	24	27 1/8	35 13/16	00726811
8 1/16	23 15/16	27 13/16	35 3/8	00727811

Note: all dimensions are in inches.

### "D" Grate Options

A Cover Width	B Cover Thk.	Product Number
26	2	00726831
26 1/2	2	00727831
26 1/2	2	00727833*

\* Features lock lug  
Note: all dimensions are in inches.



## V-5600 REVERSIBLE FRAMES AND GRATES



V-5622 assembly

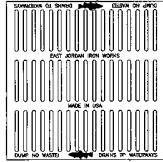

V-5622-80  
ADA compliant‡

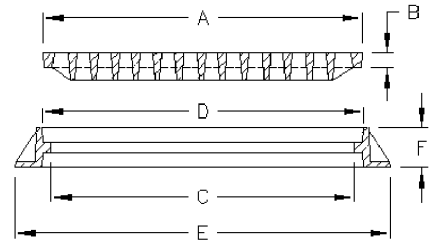

Heavy duty  
Reversible unit  
Special lettered grates

Options  
ADA compliant grates  
Extra heavy duty grates  
Vane grates

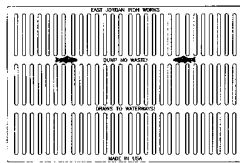

V-5660-80  
ADA compliant‡ with "DUMP NO WASTE!"

**See page 27 for V-5600 series frame and grate options**

V-5600 Reversible Frame and Grate Options

Series Number	Grate Number	Cover Number	A Grate Size	B Grate Thk.	C Clear Opening	D Frame Opening	E Flange Dim.	F Frame Ht.	Open Area Sq. In.
<b>Square</b>									
V-5613	V-5713	V-6713	13 3/8	1 9/16	11 5/8	13 5/8	19 1/8	4	55
V-5620	V-5720	V-6720	19 3/4	1 1/2	18	20	25 1/2	4	175
V-5622	V-5622	V-6622	23 3/4	1 1/2	22	24	29 1/4	4	266
	V-5622**		23 3/4	1 1/2	22	24	29 1/4	4	266
	V-5622-2†		23 3/4	1 1/2	22	24	29 1/4	4	200
	V-5622-80‡		23 3/4	1 1/2	22	24	29 1/4	4	156
	V-5622-5§		23 3/4	1 1/2	22	24	29 1/4	4	269
V-5622-1					22	26 1/4	32	5	
V-5624	V-5624	V-6624	25 3/4	1 1/2	24	26	31 3/8	4	295
	V-5624-80		25 3/4	1 1/2	24	26	31 3/8	4	194
	V-5624		25 3/4	1 1/2	24	26	31 3/8	4	295
V-5626-1	V-5626	V-6726	25 3/4	2	24	26	32	5	321
	V-5726**		25 3/4	2	24	26	32	5	321
	V-5726-80‡		25 3/4	2	24	26	32	5	194
V5626-2			25 3/4	2	24	26	32	6	
V-5630	V-5630	V-6630	31 3/4	1 1/2	30 1/8	32	37 1/2	4	474
	V-5630**		31 3/4	1 1/2	30 1/8	32	37 1/2	4	472
	V5630-80‡		31 7/8	1 1/2	30 1/8	32	37 1/2	4	283
V-5632	V-5732	V-6732	31 7/8	2	30	32 1/8	38 1/8	5	490
	V-5732**		31 7/8	2	30	32 1/8	38 1/8	5	490
	V-5732‡		31 7/8	2	30	32 1/8	38 1/8	5	283
V-5636	V-5636	V-6636	37 1/2	1 1/2	36	37 3/4	43 1/4	4	651
	V-5636**		37 1/2	1 1/2	36	37 3/4	43 1/4	4	651
	V-5636‡		37 1/2	1 1/2	36	37 3/4	43 1/4	4	305
V-5642 (2P)	V-5742 (2P)	V-6642 (2P)	43 7/8	2	42	44 1/4	49 3/4	5	868
	V-5742 (2P)**		43 7/8	2	42	44 1/4	49 3/4	5	868
V-5648 (2P)	V-5648 (2P)	V-6648 (2P)	50 5/8	1 5/8	48 5/8	51	58 3/4	4 3/8	820
<b>Rectangular</b>									
V-5660	V-5660	V-6660	23 3/4 x 35 3/4	1 1/2	22 x 34	34 x 36	29 1/2 x 41 1/2	4	390
	V-5660‡		23 3/4 x 35 3/4	1 1/2	22 x 34	34 x 36	29 1/2 x 41 1/2	4	260
V-5662	V-5662	No cover	25 5/8 x 31 3/4	1 1/2	24 x 30	26 x 32	31 3/8 x 37 3/8	4	390
V-5665	V-5665	V-6665	25 3/4 x 37 3/4	1 1/2	24 1/8 x 36 1/8	26 x 38	31 1/2 x 43 1/2	4	463
V5667	V-5667 (2P)	V-6667 (2P)	25 3/4 x 49 3/4	1 1/2	24 x 48	26 x 50	31 1/2 x 55 1/2	4	598
V-5668	V-5668	V-6668	31 3/4 x 37 3/4	2	30 x 36	32 1/8 x 38	38 1/4 x 44 1/4	5	562
V-5669	V-5669 (2P)	No cover	31 3/4 x 49 3/4	1 1/2	30 1/8 x 48 1/8	32 x 50	37 1/2 x 55 1/2	4	724
V-5670	V-5670 (2P)	V-6670 (2P)	37 3/4 x 49 3/4	1 1/2	36 1/8 x 48 1/8	38 x 50	43 1/2 x 55 1/2	4	708

\* Watertite option may have differing dimensions  
 ‡ ADA Compliant Grate  
 \*\* Ductile Iron Extra Heavy Duty Grate

† Vane Grate  
 § Special Opening  
 (2P) 2 Piece (2 frames/2 covers/2 grates)

Note: all dimensions are in inches.

## V-5700 FRAME AND GRATE SERIES



V-5724 assembly

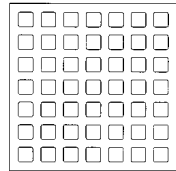

V-5724-2

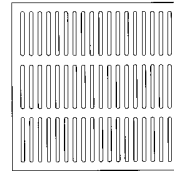

V-5724-80#

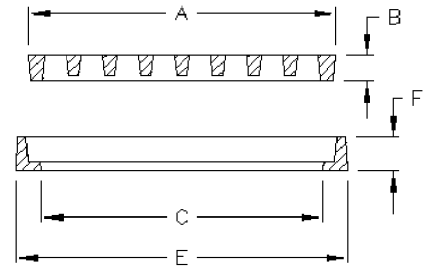

Heavy duty  
ADA compliant grates available

**See page 29 for V-5700 series frame and grate options**

V-5700 Reversible Frame and Grate Options

Series Number	Grate Number	Cover Number	A Grate Size	B Grate Thk.	C Clear Opening	E Frame Size	F Frame Ht.	Open Area Sq. In.
<b>Square</b>								
V-5708	V-5708	No cover	9 3/8	1	7 3/4	11	1 1/2	33
V-5712	V-5712	V-6712	12	7/8	10 1/2	13 7/8	1 1/4	66
	V-5712‡		12	7/8	10 1/2	13 7/8	1 1/4	43.33
V-5713	V-5713	V-6713	13 3/8	1 9/16	11 5/8	15 3/8	2 1/8	55
V-5714	V-5714	V-6714	14 1/2	1	13 1/4	16	1 9/16	76
No frame	V-5715‡	No cover	14 3/4	1 3/16				58
V-5716	V-5716	No cover	15 7/8	1 1/8	14 1/4	17 1/2	1 3/4	90
V-5718	V-5718	V-6718	18	1 1/2	16 3/8	19 1/2	2	152
V-5720	V-5720	V-6720	19 3/4	1 1/2	18 1/4	21 1/4	2	175
	V-5720‡		19 3/4	1 1/2	18 1/4	21 1/4	2	105
V-5724	V-5724-1	V-6724	24	1 7/8	22 1/4	25 7/8	2 5/8	268
	V-5724-2		24	1 7/8	22 1/4	25 7/8	2 5/8	212
	V-5724-4**		24	1 7/8	22 1/4	25 7/8	2 5/8	336
	V-5724-80‡		24	1 7/8	22 1/4	25 7/8	2 5/8	164
	V-4896 (beehive)		24	1 7/8	22 1/4	25 7/8	2 5/8	446
V-5724-1 (w/flange)			24	1 7/8	22 1/8	30	2 5/8	
V-5726-1	V-5726	V-6726	25 3/4	2	22 1/4	27 7/8	2 3/4	321
	V-5726**		25 3/4	2	22 1/4	27 7/8	2 3/4	321
	V-5726-80‡		25 3/4	2	22 1/4	27 7/8	2 3/4	194
V-5728	V-5728	No cover	28	2	25 7/8	30 1/8	2 3/4	370
V-5732	V-5732	V-6732	31 7/8	2	30 1/4	33 3/4	2 3/4	490
	V-5732-80‡		31 7/8	2	30 1/4	33 3/4	2 3/4	283
V-5736	V-5736	V-6736	38 1/4	2	36 1/2	40 3/8	2 3/4	652
	V-5736**		38 1/4	2	36 1/2	40 3/8	2 3/4	652
	V-5736-80‡		38 1/4	2	36 1/2	40 3/8	2 3/4	356
V-5742	V-5742 (2P)	V-6642 (2P)	43 7/8	2	42 1/8	45 7/8	2 3/4	868
	V-5742 (2P)**		43 7/8	2	42 1/8	45 7/8	2 3/4	868
V-5748 (non-traffic) (steel angle frame)	V-5648 (2P)	V-6648	50 9/16	1 1/2	48	51 1/2		820
<b>Rectangular</b>								
V-5751	V-5751	V-6751	13 7/8 x 25 7/8	1	12 x 24	15 5/16 x 27 3/8	1 1/2	158
V-5752	V-5752	No cover	18 x 23 3/4	1 3/8	16 1/4 x 22	19 3/8 x 25 1/8	2	188
V-5754	V-5754-1 (1" slots)	No cover	17 7/8 x 35 7/8	2	15 5/8 x 33 5/8	20 1/4 x 38 1/4	2 3/4	245
V-5760	V-5760	No cover	24 x 36	2	21 1/2 x 33 1/2	28 x 40 1/4	2 3/4	413
	7510 M3‡		23 7/8 x 35 3/4	2	21 1/2 x 33 1/2	28 x 40 1/4	2 3/4	446
	7510 M4		23 7/8 x 35 3/4	2	21 1/2 x 33 1/2	28 x 40 1/4	2 3/4	324
	7510 M1 (DG)		23 5/8 x 35 5/8	2	21 1/2 x 33 1/2	28 x 40 1/4	2 3/4	410
V-5763	V-5763	No cover	25 7/8 x 31 7/8	1 3/4	24 5/8 x 30 3/8	27 7/8 x 33 7/8	2 3/8	402
V-5766	V-5666	V-6666	25 7/8 x 37 7/8	2	24 3/8 x 36 3/8	28 x 40	3	397
V-5770	V-5670 (2P)	V-6670 (2P)	37 3/4 x 49 3/4	1 1/2	36 x 48	39 3/4 x 51 3/4	2 1/4	708

† Vane Grate

\*\* Ductile Iron Extra Heavy Duty Grate

‡ ADA Compliant Grate

(2P) 2 Piece (2 frames/2 covers/2 grates)

(DG) Diagonal Grate

(CG) Concave Grate

Note: all dimensions are in inches.



## BEEHIVE FRAMES AND GRATES



### Beehive Assembly Options

Frame Height	Flange Size	Grate Size	Grate Height	Product Number
<b>Beehive Grate</b>				
6	28 1/4	22	7	OMA801300020
7	35 7/16	26	6	OMN120500025

Note: all dimensions are in inches.

OMA801300020 22" x 6" frame and beehive grate

## TRAPS AND HOODS

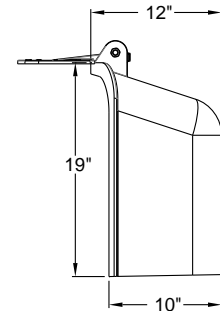
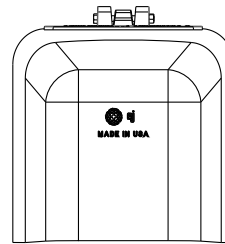
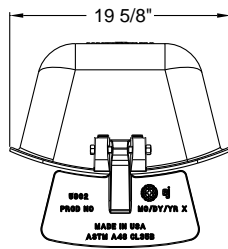

OMAL20200001 catch basin hood

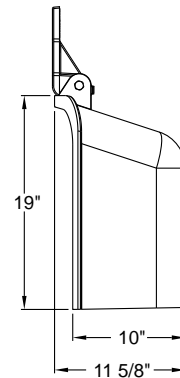
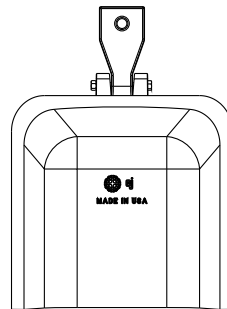
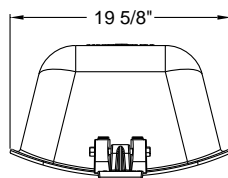

OMAL20200005 catch basin hood

## TRAPS AND HOODS (CONTINUED)

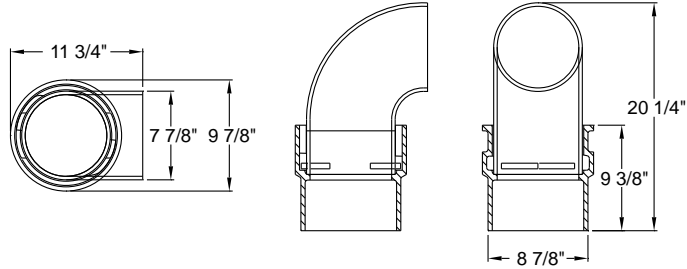

0MALB2100008 catch basin trap

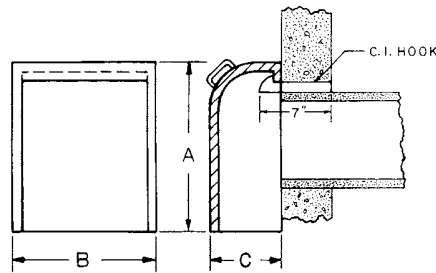

00595469 pipe catch basin trap

### 5954 Series Assembly Options

Pipe Size	A	B	C	Product Number
6	16	12	6 1/2	00595466
8	18	12	6 1/2	00595467
10	20	12	6 1/2	00595468
12	22	16 3/8	6 1/2	00595470
12 (24" radius)	22	16 1/2	6 1/2	00595469
15	25	20 1/2	6 1/2	00595475

Note: all dimensions are in inches.

## MASSDOT FRAMES AND COVERS

### Standard 26" Manhole



MassDOT Type B manhole frame and cover  
OMA211000101



MassDOT Type A manhole frame and cover  
OMA211000100



MassDOT bolted manhole frame and cover assembly  
OMA211000054

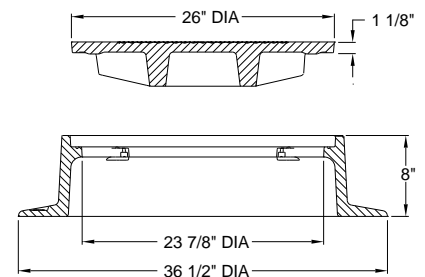
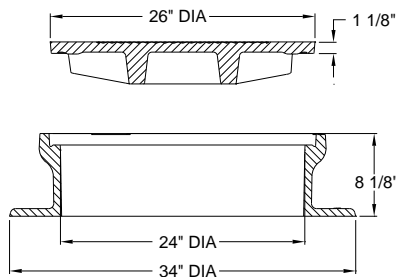
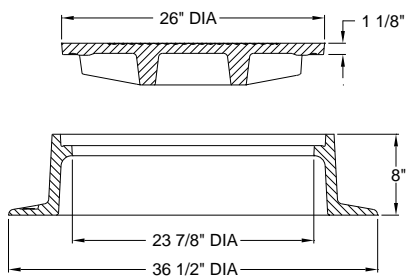

#### Frame Options

Frame Type	Product Number
Type B	OMA211000002
Type A	OMA211000001

Note: all dimensions are in inches.

#### Cover Options

Cover Type	Lettering	Product Number
Solid*	Plain	OMA211000003
Solid	Sewer	OMA211000004
Solid	Drain	OMA211000005

\* Bolted cover available

## MASSDOT FRAMES AND GRATES

### Cascade Grates



MassDOT 8" 3 flange frame and left flow cascade grate  
OMA552000103



MassDOT 8" 4 flange frame and right flow cascade grate  
OMA552000106

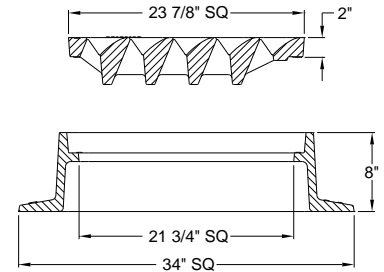

4 flange dimensions shown

#### Frame Options

Flange	Product Number
3 flange	OMA552000010
4 flange	OMA552000011

#### Grate Options

Grate Type	Product Number
Cascade (left)	OMA552000076
Cascade (right)	OMA552000077

### Hook Lock Cascade Grates



MassDOT B-1 hook lock 3 flange frame and left flow cascade grate  
OMA552000004



MassDOT B-2 hook lock 4 flange frame and left flow cascade grate  
OMA552000007

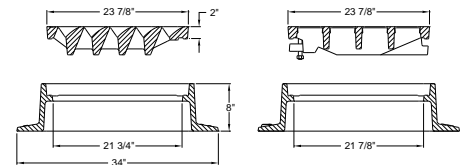

4 flange dimensions shown

#### Frame Options

Flange	Product Number
3 flange	OMA552000003
4 flange	OMA552000002

Note: all dimensions are in inches.

#### Grate Options

Grate Type	Product Number
Hook lock cascade (left)	OMA555000004
Hook lock cascade (left)	OMA555000005



Underside view

## MASSDOT FRAMES AND GRATES

### Bar Grate



MassDOT 3 flange frame and A-1 bar grate  
OMA552000100

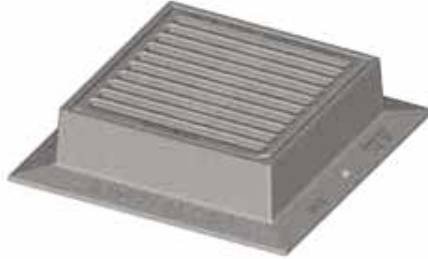

MassDOT 4 flange frame and A-1 bar grate  
OMA552000101

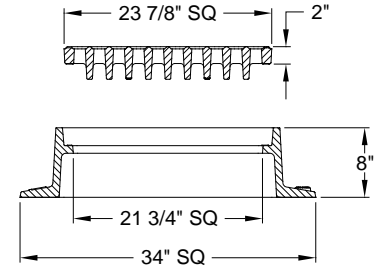

4 flange dimensions shown

Frame Options

Flange	Product Number
3 flange	OMA552000010
4 flange	OMA552000011

Grate Options

Grate Type	Product Number
Bar grate	OMA552000014

Note: all dimensions are in inches.

### Hook Lock Bar Grate



MassDOT 3 flange frame and A-4 bar grate  
OMA552000008



MassDOT 4 flange frame and A-4 bar grate  
OMA552000009

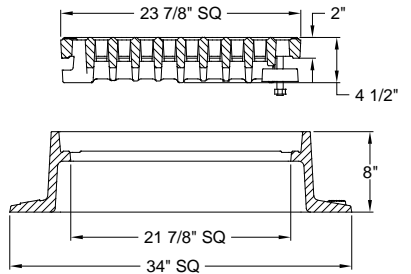

4 flange dimensions shown

Frame Options

Flange	Product Number
3 flange	OMA552000003
4 flange	OMA552000002

Grate Options

Grate Type	Product Number
Hook lock bar grate	OMA552000001

Note: all dimensions are in inches.



## MASSDOT FRAMES AND GRATES

### Drop Inlet Bar Grate

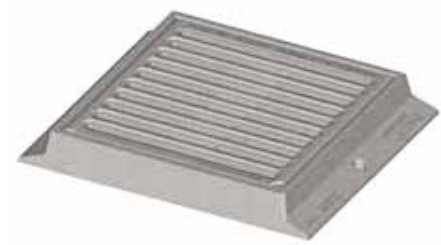

MassDOT 2 flange frame and A-1 bar grate  
0MA552000113



MassDOT 3 flange frame and A-1 bar grate  
0MA552000115



MassDOT 4 flange frame and A-1 bar grate  
0MA552000117

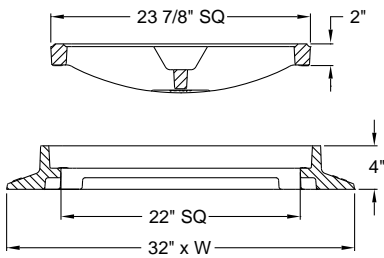

Available in 2, 3 or 4 flange design

#### Frame Options

Flange	W	Product Number
2 flange	26	0MA552500001
3 flange	29	0MA552500016
4 flange	32	0MA552500015

Note: all dimensions are in inches.

#### Grate Options

Grate Type	Product Number
Bar grate	0MA552000014

## MASSDOT FRAMES AND COVERS

### Electrical



MassDOT  
12 x 12 x 3-1/2 pull box frame and cover



MassDOT  
24 x 24 x 3 reversible frame and DOT logo cover



MassDOT  
8 x 23 x 2-1/2 pull box frame and cover



MassDOT  
13 x 25 x 3 pull box frame and cover



00211056A01 MassDOT 6" frame and 27 1/2" cover



00124837A01 MassDOT 6" manhole assembly



00227045A01 MassDOT 6" manhole assembly with transitional manhole frame with 42" square base flange

#### MassDOT Assembly Options

Cover Size	Cover Thickness	Clear Opening	Flange Size	Flange	Frame Height	Load Rating	Product Number
<b>Rectangular / Square</b>							
12 x 12	1	10 3/4	17 1/4	4 flange	3 1/2	Heavy Duty	0MA801200001
23 3/4 x 23 3/4	15/16	21 7/8	30	4 flange	3	Medium Duty	0MA805300001
22 7/8 x 7 15/16	1	21 1/2 x 6 1/2	28 1/2 x 13 3/4	4 flange	2 1/2	Heavy Duty	0MA801100003
24 3/4 x 12 3/4	1-1/2	24 x 12	29 3/4 x 17 3/4	4 flange	3	Heavy Duty	0MA801300003
<b>Round</b>							
26 DIA	1 1/8	24 DIA	34 DIA	N/A	8 1/8	Heavy Duty	00211056A01
23 3/4 DIA	1 1/4	22 DIA	34 DIA	N/A	6	Heavy Duty	00124837A01
27 1/2 DIA	1	26 DIA	42 SQ	N/A	6	Heavy Duty	00227045A01

Note: all dimensions are in inches.

# Rhode Island Municipal and DOT Castings



## CRANSTON

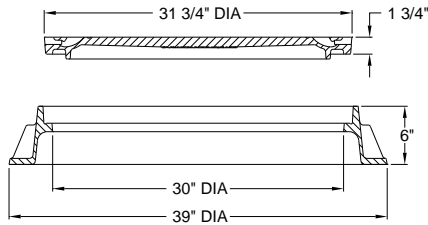

00200677A01 Cranston Sewer frame and cover

002006002W01 Cranston watertite assembly

### Frame Options

Frame Height	Product Number
6	00200611

Note: all dimensions are in inches.

### Cover Options

Cover Type	Lettering	Product Number
Solid*	Cranston Sewer [current year]	00200677

\* Watertite bolted assembly available

## PROVIDENCE

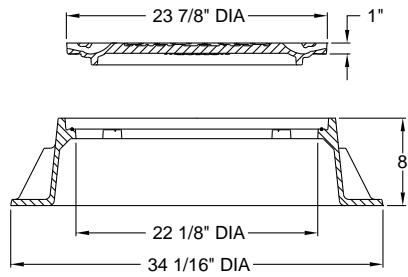

00240834B01 Providence frame and 4 bolt cover assembly

Frame Options

Frame Height	Product Number
8	00242019

Cover Options

Cover Type	Lettering	Product Number
Solid	City of Providence	00240834

Note: all dimensions are in inches.

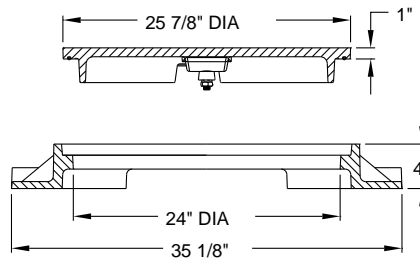

001040081A02 Providence frame and cam lock cover assembly

Frame Options

Frame Height	Product Number
4	00225311

Cover Options

Cover Type	Lettering	Product Number
Solid, gasketed with cam locks	City of Providence	001040081A01

Note: all dimensions are in inches.

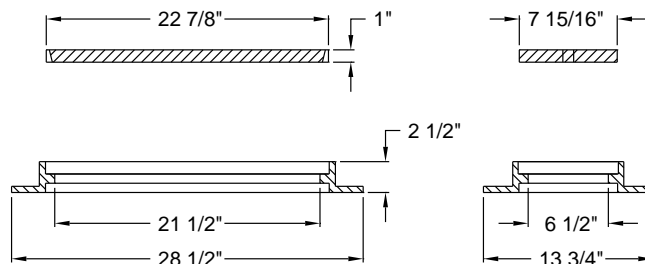

00801144B01 Providence chute frame and 2 bolt cover assembly

Frame Options

Frame Height	Product Number
2 1/2	00801111

Cover Options

Cover Type	Lettering	Product Number
Solid, bolted	City of Providence	00801144

Note: all dimensions are in inches.



PROVIDENCE (CONTINUED)



005520001C01 3 flange frame and cascade grate



005520001C02 4 flange frame and cascade grate

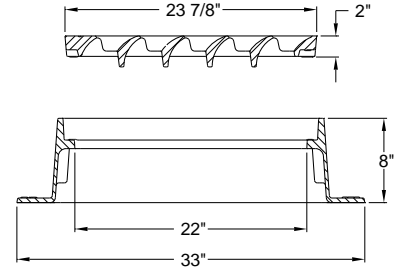

005520002C01 3 flange frame and square hole grate



005520002C02 4 flange frame and square hole grate

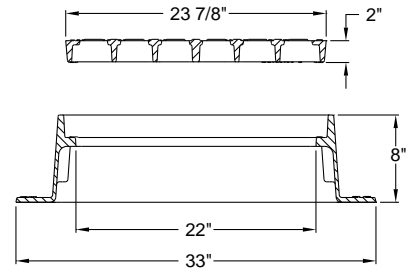

Frame Options

Flange	Product Number
3 flange	00554813
4 flange	00554811

Grate Options

Grate Type	Product Number
Square hole	005520002
Cascade	005520001

Note: all dimensions are in inches.



45660040 4" tall reversible frame and grate

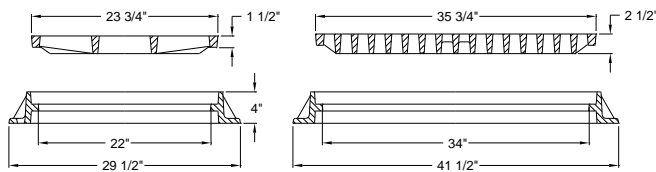

Frame Options

Frame Height	Product Number
4	45660010

Grate Options

Lettering	Product Number
Dump no waste! Drains to waterways	45660033

Note: all dimensions are in inches.

## WARWICK

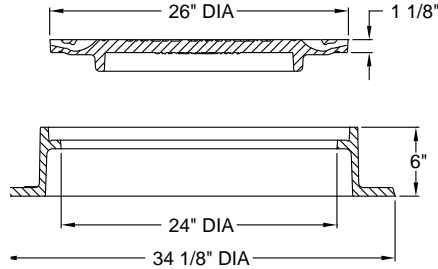

00211147C05 Warwick frame and cover

Frame Options

Frame Height	Product Number
6	00226611

Note: all dimensions are in inches.

26" Cover Options

Cover Type	Lettering	Product Number
Solid	City of Warwick	00211147

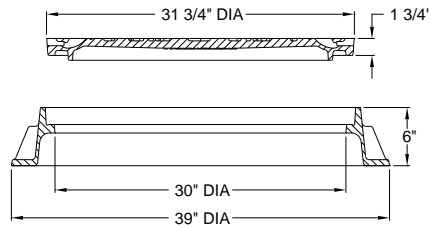

00200687A01 Warwick frame and sewer cover

Frame Options

Frame Height	Product Number
6	00200611

Note: all dimensions are in inches.

32" Cover Options

Cover Type	Lettering	Product Number
Solid, vented	seWer	00200687

## WOONSOCKET

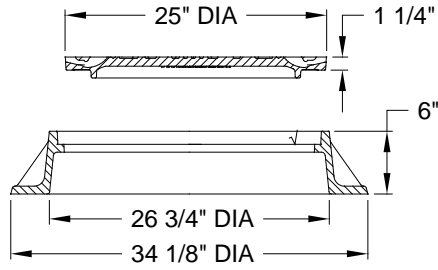

00125851A01 1256Z 1258C Woonsocket sewer undipped 6" assembly

00125850 Woonsocket drain cover

### Frame Options

Frame Height	Product Number
6	00125611

### Cover Options

Cover Type	Lettering	Product Number
Solid	Woonsocket Drain	00125850
Solid	Woonsocket Sewer	00125851

Note: all dimensions are in inches.

## RIDOT FRAMES AND GRATES

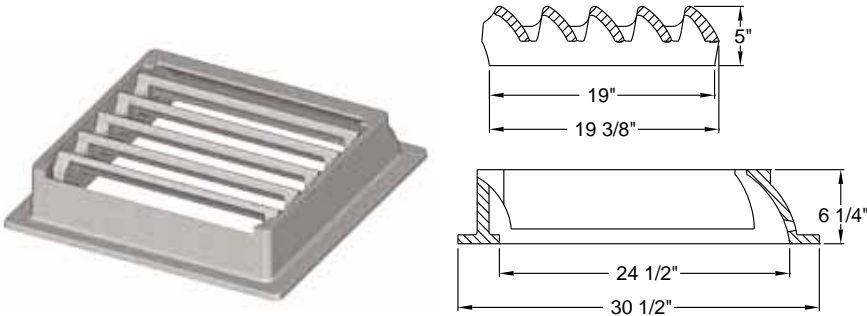

ORI547000003 RIDOT 6.3.3 5 bar cascade frame and grate

### RIDOT Frame

Clear Opening	Flange Size	Flange	Frame Height	RIDOT Standard	Product Number
22 x 24 1/2	29 1/2 x 30 1/2	4 flange	6 1/4	6.3.3	ORI547000001

Note: all dimensions are in inches.

### RIDOT Grate

Grate Type	Cover Size	Grate Thickness	RIDOT Standard	Product Number
5 bar cascade	23 1/2 x 19	5	6.3.3	ORI547000002

Note: all dimensions are in inches.

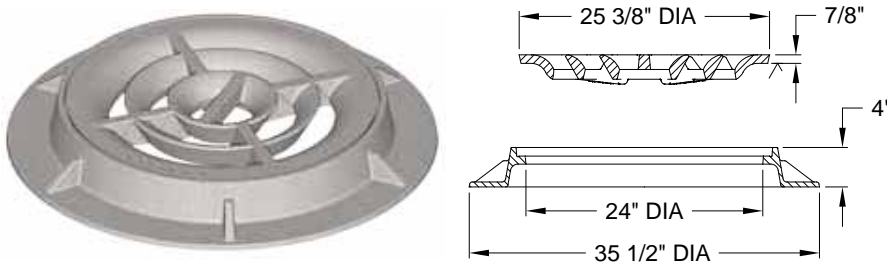

ORILK2840003 RIDOT 6.4.1 26 x 4 frame and grate

### Frame Option

Frame Height	RIDOT Standard	Product Number
4	6.4.1	00120513

### Grate Option

Grate Dia.	RIDOT Standard	Product Number
25 3/8	6.4.1	00120533

Note: all dimensions are in inches.

## RIDOT FRAMES AND COVERS

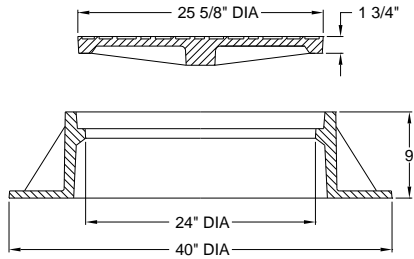

0RI225000009 RIDOT 6.2.1 26" x 9" frame & "RIDOT" cover

0RI225000009 dimensions shown

### Frame Options

Frame Height	Frame Type	RIDOT Standard	Product Number
4	Square	6.1.0 and 6.1.1	0RI225000001
6	Round	6.2.0	0RI223000001
9	Round	6.2.1	0RI225000003

### 26" Cover Options

Lettering	RIDOT Standard	Product Number
RIDOT	6.1.0	0RI225000011
RIDOT	6.1.1	0RI225000006
RIDOT	6.2.0	0RI223000002
RIDOT	6.2.1	0RI225000010

Note: all dimensions are in inches.



0RI225000001 6.1.0/6.1.1 26" x 6" square flange frame

0RI223000001 6.2.0 26" x 6" frame



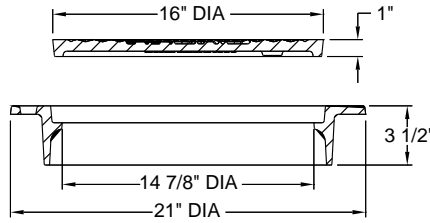

ORI29000004 RIDOT 18.2.0 16 x 3 1/2 frame & electric cover

ORI29000004 dimensions shown

ORI225615000 18.2.2 26 x 9 frame and electric cover

Frame Options\*

Frame Height	Cover Dia.	RIDOT Standard	Product Number
3 1/2	16	18.2.0	ORI290400001
6	20	18.2.1	ORI106100008
9	26	18.2.2	ORI225615002

\* Drilled and tapped for electrical grounding  
Note: all dimensions are in inches.

Cover Options\*

Cover Dia.	Cover Type	Lettering	RIDOT Standard	Product Number
16	Solid	Electric	18.2.0	ORI290400002
16	Solid	Signal	18.2.0	ORI290400003
20	Solid	Electric	18.2.1	ORI106100009
20	Solid	Signal	18.2.1	ORI106100003
26	Solid	Electric	18.2.2	ORI225615003
26	Solid	Signal	18.2.2	ORI225615004

\* Drilled and tapped for electrical grounding  
Note: all dimensions are in inches.



ORI290400003 RIDOT 18.2.0 16" signal cover drilled and tapped for electrical grounding



ORI225615004 RIDOT 18.2.2 26" signal cover drilled and tapped for electrical grounding

## RIDOT FRAMES AND GRATES

### Frames

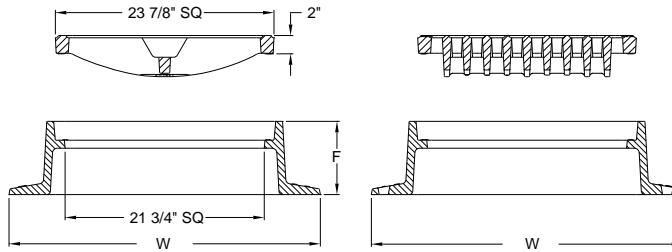

ORI552000003 RIDOT 24" x 24" x 8" 4 flange frame  
6.3.0 / 6.3.1 / 6.3.2 / 6.3.4

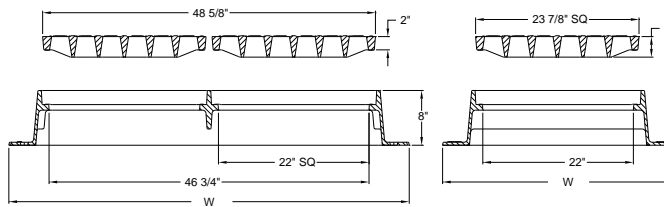

ORI544000004 RIDOT 4 flange double frame  
3.3.4 / 3.3.5

#### Rhode Island DOT Frame

Opening Type	W Flange Dimension	Flange	F Frame Height	RIDOT Standard	Product Number
Single	34 x 30 5/16	3 flange	8	6.3.0, 6.3.1, 6.3.2, 6.3.4	ORI552000001
Single	34 x 34	4 flange	8	6.3.0, 6.3.1, 6.3.2, 6.3.4	ORI552000003
Double	58 1/2 x 30 3/16	3 flange	8	3.3.4, 3.3.5	ORI544000001
Double	58 1/2 x 33 3/4	4 flange	8	3.3.4, 3.3.5	ORI544000004

Note: all dimensions are in inches.

Grates



ORI552000002 RIDOT 24" x 24" square hole grate 6.3.0



ORI552000006 RIDOT 24" x 24" slotted grate 6.3.1



ORI552000010 RIDOT 24" x 24" bike safe grate 6.3.2



ORI552000014 RIDOT 24" x 24" cascade left grate 6.3.4



ORI552000015 RIDOT 24" x 24" cascade right grate 6.3.4

24" x 24" Rhode Island DOT Grate

Cover Type	Cover Thk.	RIDOT Standard	Product Number
Square hole	2	6.3.0	ORI552000002
Slotted bar	2	6.3.1	ORI552000006
Bike safe	2	6.3.2	ORI552000010
Cascade grate (left)	2	6.3.4	ORI552000014
Cascade grate (right)	2	6.3.4	ORI552000015

Note: all dimensions are in inches.



# Connecticut Municipal and DOT Castings



## 24" MANHOLE FRAMES AND COVERS

### Eighth District Sewer, Greater New Haven Water Pollution Control Authority, Hamden, Manchester, Milford, Southington, Stafford, and Wallingford

Features  
Heavy duty

Options  
Solid, flat grate, or ADA grate  
Custom badging/lettering  
Gasket seal covers  
4", 6", or 8" frame height  
EPIC® pick bar

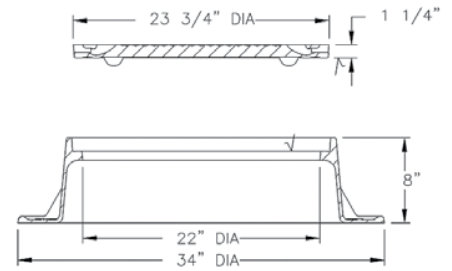

8" frame and cover

#### Frame Options

Frame Height	Product Number
4	00124411
6	00124611
8	00124811

Note: all dimensions are in inches.

#### 24" Cover Options

Municipality	Cover Type	Lettering	Product Number
Eighth District Sewer	Solid	Sewer	00133856
GNHWPCA	Solid	GNHWPCA logo	00124677
GNHWPCA	Solid, watertite assembly	GNHWPCA logo	OCT124800004
Hamden	Solid	Hamden Storm	00124879
Manchester	Solid	Town of Manchester Drain	00133871
Manchester	Solid	Town of Manchester Sewer	00133872
Milford	Solid	Milford Sewer	00124865
Southington	Solid	Sewer	00124825
Southington	Solid	Storm	00124827
Stafford	Solid	Stafford Sewer	00124869
Wallingford	Solid	Wallingford Storm	00124844

#### Cover Options



00133856 Eighth District sewer cover



00133871 Town of Manchester drain cover



00124677 GNHWPCA logo cover



## BRIDGEPORT



OCT211100001 8" frame and solid cover

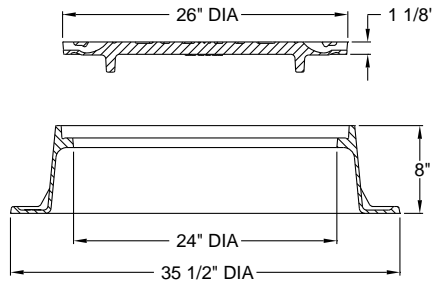

OCT211100001 frame and cover dimensions shown

### Frame Options

Frame Height	Product Number
4	00226411
6	00226611
8	00211111

Note: all dimensions are in inches.

### 26" Cover

Cover Type	Lettering	Product Number
Solid	WPCA Bridgeport Sewer	00211157

## BRISTOL



OCT224000001 frame and cover

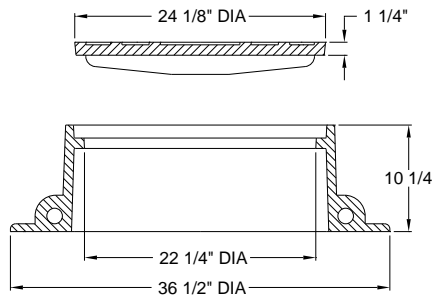

OCT224000001 frame and cover dimensions shown

### Frame Options

Frame Height	Product Number
4	00241015S01
6	00124615S01
8	00124815S01
10	00224011

Note: all dimensions are in inches.

### 24" Cover

Cover Type	Product Number
Solid	00224021

## DANBURY

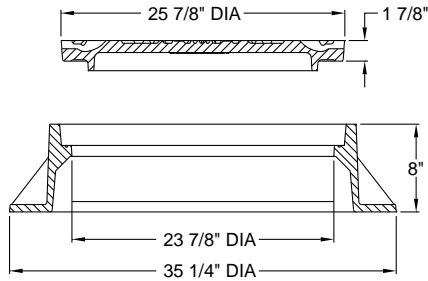

00126823 / 00126811 frame and cover

### Frame Options

Frame Height	Product Number
8	00126811

Note: all dimensions are in inches.

### 24" Cover

Cover Type	Lettering	Product Number
Solid	City of Danbury Sanitary Sewer	00126823
Solid	City of Danbury Storm Sewer	00126829

## EAST LYME

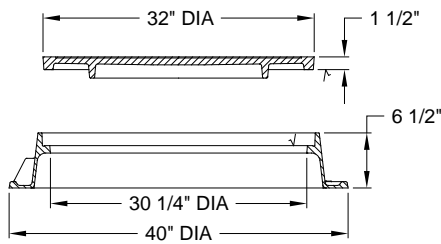

00132213 / 00132257 frame and cover

### Frame Options

Frame Height	Product Number
6.5	00132213

Note: all dimensions are in inches.

### 32" Cover

Cover Type	Lettering	Product Number
Solid	Plain	00132221
Solid	Sewer	00132257

## HARTFORD MDC

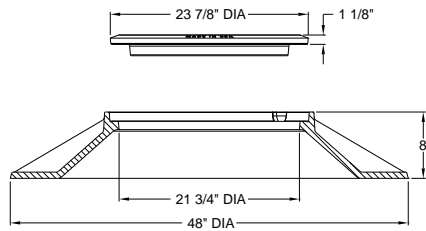

00220523C02 frame and sewer cover

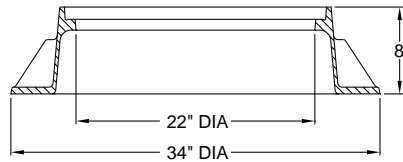

00124819 frame

Frame Options

Frame Height	Flange Diameter	Product Number
8	48	00220513
8	34	00124819

Note: all dimensions are in inches.

24" Cover

Cover Type	Additional Cover Description	Lettering	Product Number
Solid		Sewer	00220521
Solid	Vented 1 hole	Sewer	00220523
Solid	Vented 1 hole, Gasket	Sewer	00220546
Solid*	Gasket	Sewer	00220548
Solid		Water	00220525
Solid	Vented 1 hole	Water	00220549
Solid	Vented 1 hole	Storm Drain	00220527
Solid		Storm Drain	00220528
Grate		Dump no pollutants outfall to streams	00244031

\*Watertite bolted assembly available, product number 00220548W03



00244031 grate

## MERIDEN

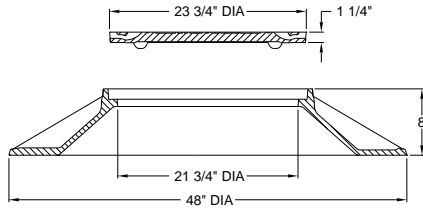

00124878A02 wide base frame and Meriden sewer cover.

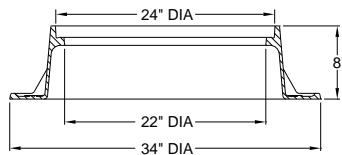

00124811 top hat frame

### Frame Options

Frame Type	Frame Height	Product Number
Wide Base*	8	00220515
Top Hat*	8	00124811

\* Bolted frame available  
Note: all dimensions are in inches.

### 24" Cover

Cover Type	Lettering	Standard Number
Solid*	Meriden Sewer	00124878
Solid	Meriden Storm	00124875

\* Bolted cover available.

### Additional Top Hat Frame Options

Frame Height	Product Number
4	00124411
6	00124611

Note: all dimensions are in inches.

## MIDDLETOWN

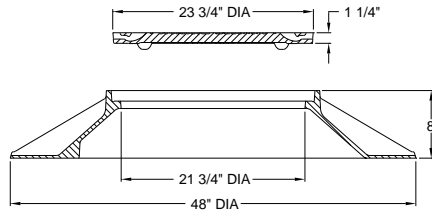

00220515 / 00124862 8" standard frame and solid cover

00220515 / 00124862 8" standard frame and solid cover dimensions shown

### Frame Options

Frame Height	Standard Number	Watertite Number
4	00124411	00124413
6	00124611	00124613
8	00220515	00220517

Note: all dimensions are in inches.

### 24" Cover

Cover Type	Lettering	Product Number
Solid	Middletown	00124862
Solid, watertite	Middletown	00124863
Solid, vent holes	Middletown	00124862D01

## NEW BRITAIN

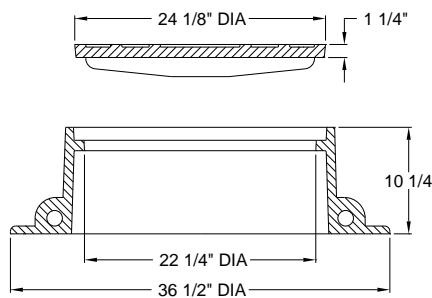

00224020A01 frame and cover

00224020A01 dimensions shown

### Frame Options

Frame Height	Product Number
4	00241015S01
6	00124615S01
8	00124815S01
10	00224011

Note: all dimensions are in inches.

### 24" Cover

Cover Type	Lettering	Product Number
Solid, vent holes	Plain	00224020
Solid, vent holes	SW	00224022

## NEW HAVEN

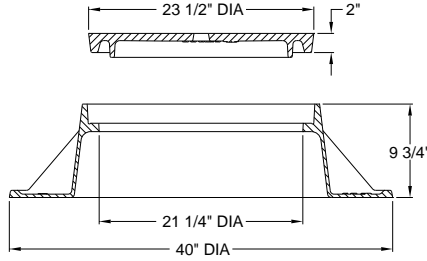

9" frame and New Haven cover

### Frame Options

Frame Height	Product Number
9	00224211

Note: all dimensions are in inches.

### 24" Cover

Cover Type	Lettering	Product Number
Solid, vented	New Haven	00224221
Solid, vented	New Haven Storm	00224223

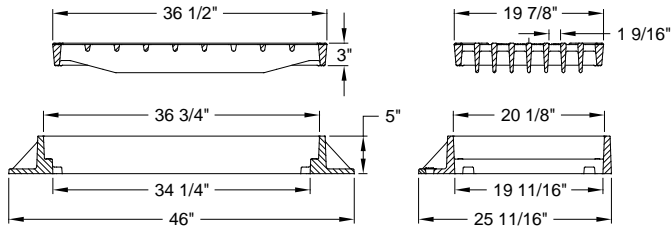

00774017 / 00774031 3 flange Type A frame and grate

00774017 / 00774031 3 flange Type A frame and grate dimensions shown

### Frame Options

Frame Height	Flanges	Product Number
5	3	00774017
5	4	00774015

Note: all dimensions are in inches.

### 16" x 33" Grate

Grate Style	Standard Product Number	Bolted Product Number
Type A	00774031	00774033
Type B	00774041	00774043



00774041 Type B grate



## NORTH HAVEN

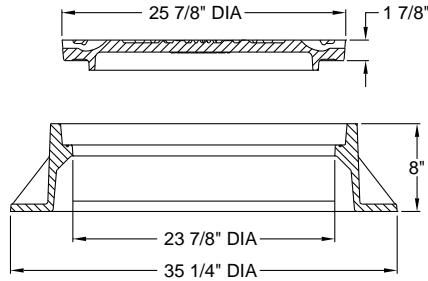

00126811 / 00126822 frame and cover

Frame

Frame Height	Product Number
8	00126811

Note: all dimensions are in inches.

26" Cover

Cover Type	Lettering	Product Number
Solid	Sewer	00126822
Solid	Drain	00126824

## TRUMBULL

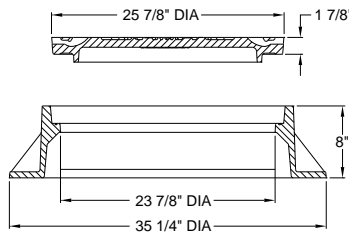

00126811 / 00126822 frame and cover

00126811 / 00126822 frame and cover dimensions

Frame Options

Frame Height	Product Number
8	00126811
10	00226011

Note: all dimensions are in inches.

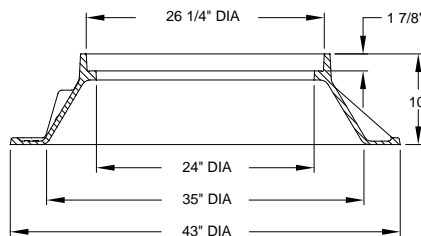

00226011 frame

00226011 frame dimensions

26" Cover

Cover Type	Lettering	Product Number
Solid	Sewer	00126822
Solid	Drain	00126824
Solid, gasket seal	Sewer	00126827

## WATERBURY



City of Waterbury logo sewer

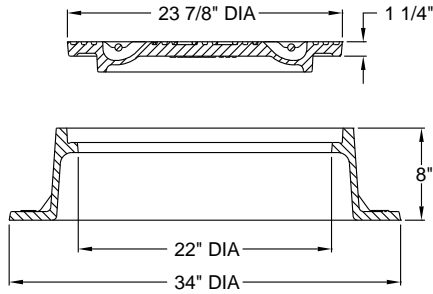

00124725 / 00124725 dimensions shown

Frame Options

Frame Height	Product Number
4	00241015
6	00124615
8	00124815

Note: all dimensions are in inches.

24" Cover

Cover Type	Lettering	Product Number
Solid	Waterbury Sanitary Sewer	00124725
Solid	City of Waterbury Logo Storm Drain	00124670
Solid	City of Waterbury Logo Sewer	00124671



00759107 curb inlet assembly

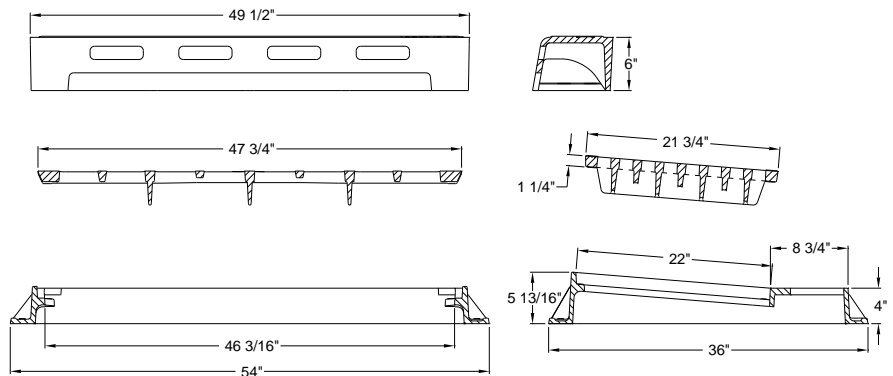

Frame Option

Frame Height	Product Number
4	00759113

Note: all dimensions are in inches.

Grate Option

Lettering	Product Number
Dump No Waste Drains to Waterways	00759039

Hood Option

Lettering	Product Number
Dump No Waste Drains to Waterways	00759062

## CONNECTICUT DOT

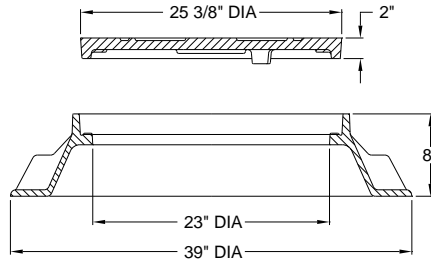

OCT121000006 CDOT 8" frame and cover

OCT121000006 dimensions shown

### Frame

Frame Height	Product Number
4	00121411
8	OCT121000003

### 25" Cover

Cover Type	Lettering	Product Number
Solid	CDOT	OCT121000005

Note: all dimensions are in inches.



# New Hampshire Municipal Castings



## CATCH BASINS



0NH552000003 NH DOT Type A and F 8" 4 flange frame



0NH532000007 NH DOT Type B 4" 4 flange frame



0NH532000003 NH DOT Type B 8" 4 flange frame

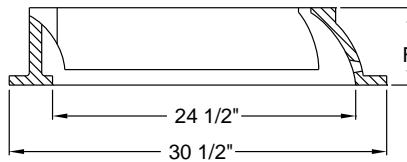
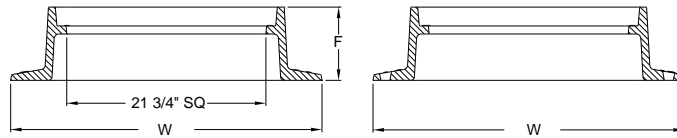

0NH547000001 Type E frame

### Frame Options

Frame Type	F Frame Height	Flange	W Flange Dimensions	Product Number
Type A & F	8	3 flange	34 x 30 5/16	0NH552000001
Type A & F	8	4 flange	34 x 34	0NH552000003
Type B	4	3 flange	28 3/16 x 29	0NH532000005
Type B	4	4 flange	31 3/16 x 29	0NH532000007
Type B	8	3 flange	28 3/16 x 29	0NH532000001
Type B	8	4 flange	31 3/16 x 29	0NH532000003
Type E	6 1/4	4 flange	30 1/2 x 29 1/2	0NH547000001

Note: all dimensions are in inches.



Grates



0NH552000002 NH DOT Type A slotted grate



0NH532000008 NH DOT Type B grate



0NH547000002 NH DOT Type E 5-bar cascade grate



0NH552000012 NH DOT Type F cascade grate left



0NH552000010 NH DOT Type F cascade grate right



0NH552000016 square hole grate

New Hampshire Grate Options

Grate Type	Grate Size	Product Number
Type A slotted	23 7/8 x 23 7/8	0NH552000002
Type B	23 1/4 x 21	0NH532000008
Type E 5-bar cascade	23 1/2 x 19 3/8	0NH547000002
Type F cascade (left)	23 7/8 x 23 7/8	0NH552000012
Type F cascade (right)	23 7/8 x 23 7/8	0NH552000010
Square hole	23 7/8 x 23 7/8	0NH552000016

Note: all dimensions are in inches.

## MANHOLE FRAME AND COVER

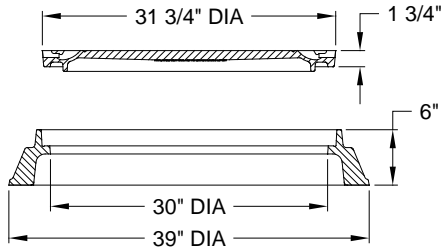

0NH200600003 NH 32" x 6" standard manhole frame and cover plain

0NH200600003 dimensions shown

### Frame Options

Frame Height	Product Number
4	0MA200000022
6	0NH200000001

### Cover Options

Lettering	Product Number
Plain	0NH200000002
Sewer	0NH200600001
Drain	0NH200600002

Note: all dimensions are in inches.

# Vermont Municipal Castings



## VERMONT STANDARD FRAME AND COVER

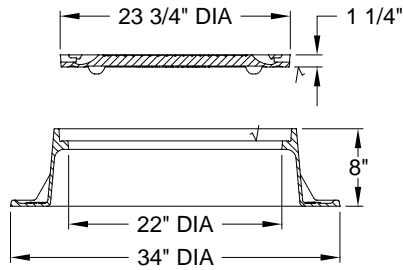

0VT124000003 Vermont standard frame and cover

Frame

Frame Height	Product Number
8	0VT124000001

24" Cover

Cover Type	Lettering	Product Number
Solid	Plain	0VT124000002

Note: all dimensions are in inches.

## DROP INLET



0VT554600002 4 flange drop inlet frame



0VT554600001 3 flange drop inlet frame

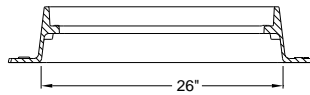
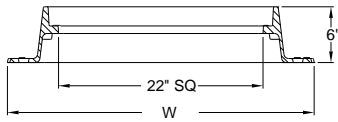

Frame Options

Frame Height	Flange	W Flange Dimensions	Product Number
6	3	29 7/8 x 33	0VT554600001
6	4	33 x 33	0VT554600002

Note: all dimensions are in inches.



0VT552000002 Type A slotted bar grate



0VT552000015 Type D square hole grate

Grate Options

Grate Type	Product Number
<b>Type A</b>	
Slotted bar	0VT552000002
<b>Type D</b>	
Square hole	0VT552000015
<b>Type E</b>	
Cascade (left)	0VT552000007
Cascade (right)	0VT552000008



0VT552000007 Type E cascade (left)



0VT552000008 Type E cascade (right)

## TYPE A, D AND E FRAMES



0VT552000003 3 flange frame



0VT552000001 4 flange frame

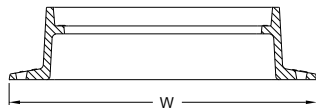
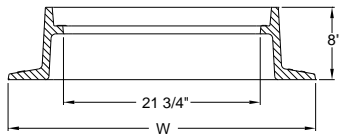

Frame Options

Frame Height	Flange	W Flange Dimension	Product Number
<b>Type A, D and E</b>			
8	3 flange	30 5/16 x 34	0VT552000003
8	4 flange	34 x 34	0VT552000001

Note: all dimensions are in inches.

## DOUBLE TYPE A FRAMES



0VT544000002 Double Type A 3 flange frame

Frame Options

Frame Height	Flange	W Flange Dimension	Product Number
<b>Double Type A</b>			
8	3 flange	30 3/16 x 58 1/2	0VT544000002
8	4 flange	33 3/4 x 58 1/2	0VT544000001

Note: all dimensions are in inches.



0VT544000001 Double Type A 4 flange frame

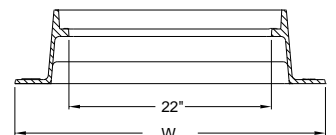
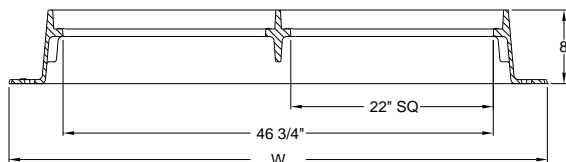



## TYPE A, D AND E GRATES



0VT552000002 Type A slotted bar grate



0VT552000015 Type D square hole grate



0VT552000007 Type E cascade (left)



0VT552000008 Type E cascade (right)

Grate Options

Grate Type	Product Number
<b>Type A</b>	
Slotted bar	0VT552000002
<b>Type D</b>	
Square hole	0VT552000015
<b>Type E</b>	
Cascade (left)	0VT552000007
Cascade (right)	0VT552000008

## TYPE B



0VT547000005 Type B frame and grate assembly

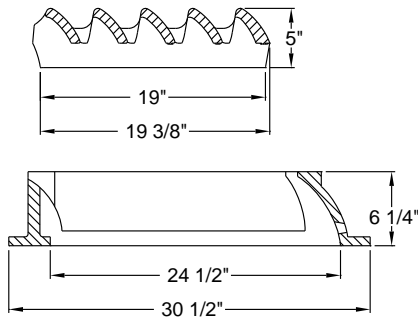

### Frame Options

Frame Height	Flange	Product Number
6 1/4	4 flange	0VT547000001

Note: all dimensions are in inches.

### Grate Options

Grate Type	Product Number
5 bar cascade	0VT547000002

# Maine Municipal and DOT Castings



CITY OF PORTLAND

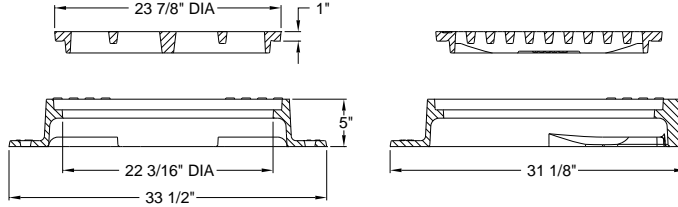

OME552000018 frame and grate

Frame Options

Frame Height	Product Number
5	OME552000019

24" Grate

Grate Type	Lettering	Product Number
Flat Grate	Dump No Pollutants Outfall to Streams	OME552000020

Note: all dimensions are in inches.

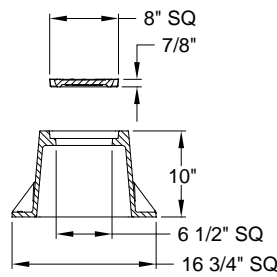

00836023A01 frame and cover

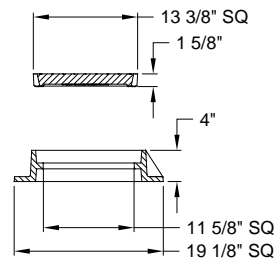
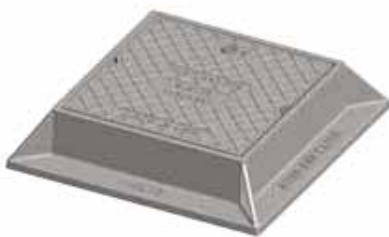

46713021A01 frame and cover

Note: frame is reversible

Frame Options

Frame Height	Product Number
4	46713021
10	00836011

Portland Survey Monument Cover

Cover Type	Cover Size	Lettering	Product Number
Solid	8 x 8	Portland DPS Survey Monument	00836023
Solid	13 3/8 x 13 3/8	Portland DPS Survey Monument	45613010

Note: all dimensions are in inches.

## MAINE DOT FRAME AND COVER

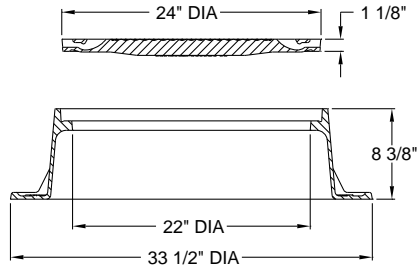

0ME126000005 Maine DOT frame and cover

Frame Options

Frame Height	Product Number
8	0ME126000002

24" Cover

Cover Type	Lettering	Product Number
Solid	Plain	0ME126000003

Note: all dimensions are in inches.

## MAINE DOT CATCH BASIN FRAMES AND GRATES

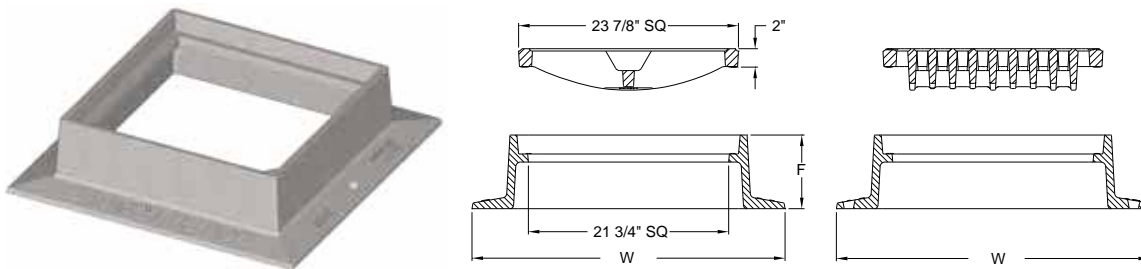

0ME552000012 Maine DOT 24" x 24" x 8"  
4 flange frame

### Frame Options

F Frame Height	Flange	W Flange Dimension	MaineDOT	Product Number
8	3 flange	34 x 30 5/16	Type A	0ME552000001
8	4 flange	34 x 34	Type B	0ME552000003

Note: all dimensions are in inches.



0ME552000002 24" x 24" bar grate



0ME552000016 24" x 24" cascade grate with corner  
left off

Note: this product ships with no cut corner

### 24" x 24" Grate Options

Grate Type	Product Number
Bar grate	0ME552000002
Cascade type grate -no cut corners	0ME552000016



# Utility and Telecommunication Castings



## 1802—1825 FRAME AND COVER



1825 Type A2

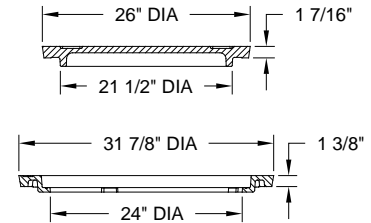
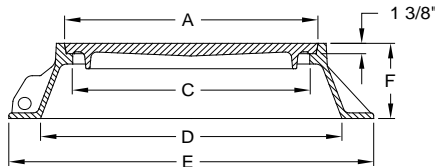

Type E outer cover with 1040 26" diameter inner cover  
Use with the 1820 & 1825 frames

### Features

- Vertical and horizontal machined surfaces
- Stackable frames

### Options

- Custom logo covers
- TYPE E 1810 outer cover
- Special lettered covers
- Gasket seal covers
- Two bolt assembly
- Two pent bolt assembly
- Cam lock assembly
- Pick bars, drop handles, closed pick holes
- Adjusting risers



Type Aa hex design



Type A3 hex design with pick bars

Frame supplied with 4 - 1" diameter base flange holes on 43 1/2" bolt circle  
\*Available with 49" base flange

All units can be secured

### 1802—1825 Frame and Cover Assembly Options

Series Number	Reference	A Cover Diameter	C Clear Opening	D Frame Opening	E Flange Diameter	F Frame Height
1802	SB-27	28 15/16	27	34	46	5 5/8
1805	B-27	28 15/16	27	34	46	10
1820	SB-30	31 15/16	30	37	46	5 5/8
1825	B-30	31 15/16	30	38	46	10

Note: all dimensions are in inches.

Many of the covers in this series are manufactured with corporate names and their respective logos. These names and images are the protected property of our customers. EJ maintains custom covers for dozens of electrical, telecommunication, and other utility companies. Please contact your nearest EJ office for information regarding new or existing designs.

## NATIONAL GRID



OMA227600004 frame with OMA227600001 cover



OMA228600000 frame, OMA227600002 adaptor, and OMA227600001 cover



OMA290400001 frame with OMA290400002 cover

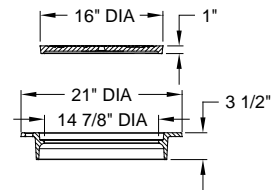
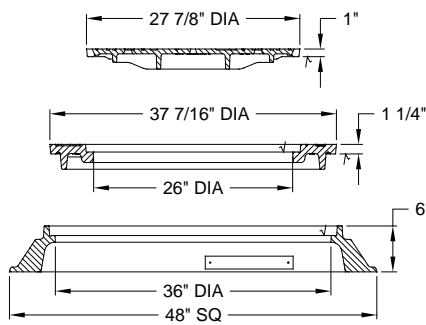
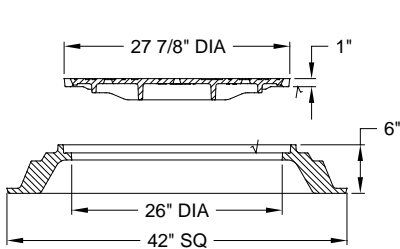

### Frame Options

Frame Height	Frame Type	Flange Dim.	Product Number
3 1/2	Top flange	21 dia.	OMA290400001
6	Bottom flange	42 x 42	OMA228600000
6	Bottom flange	48 x 48	OMA227600004

Note: all dimensions are in inches.

### Cover and Grate Options

Cover Diameter	Cover Type	Lettering	Product Number
16	Solid, vent holes	Electric Service	OMA290400002
27 7/8	Solid, vent holes	Electric Service	OMA227600001
37 7/16 outside dia. (for 27 7/8 cover)	Solid, adaptor	N/A	OMA227600002

Note: all dimensions are in inches.

## NORTHEAST UTILITIES

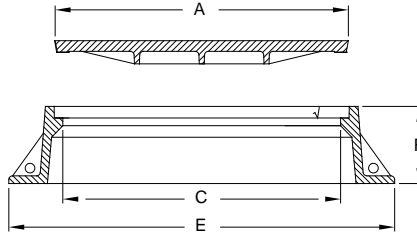

OMA380000001 Northeast Utilities frame and 38" cover

### Frame Options

A Cover Dia.	C Clear Opening	E Flange Dia.	F Frame Height	Product Number
32	30	49	5 5/8	OMA320000002
38	36	50	6	OMA380000005
38	36	50	10	OMA380000002

Note: all dimensions are in inches.

### Cover Options

A Cover Dia.	Cover Type	Lettering	Product Number
32	Solid, vent holes	Electric	OMA320000003
38	Solid, vent holes	Electric	OMA380000003

Note: all dimensions are in inches.

## NSTAR

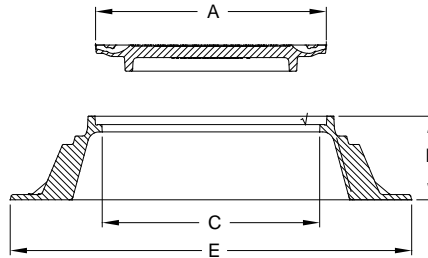
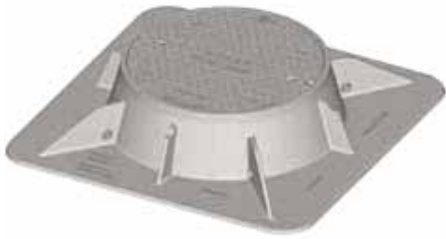

OMA227000002 NSTAR Electric No. 1 frame and No. 1C cover

### Frame Options

NSTAR Frame Type	NSTAR Cat. ID No.	A Cover Diameter	C Clear Opening	E Flange Diameter	F Frame Height	Product Number
No. 0-L shallow frame	24055	37 7/16	36	48 x 48	6	00228612
No. 1-L frame	1385	27 9/16	26	48 x 48	6	OMA227400000
No. 0 frame	1382	37 7/16	36	48 x 48	10	OMA228000000
No. 1 frame	1384	27 9/16	26	48 x 48	10	OMA227000001

Note: all dimensions are in inches.

### Grates/Vented Covers



OMA227200014 NSTAR Electric No. 1V grate



00158035 NSTAR Electric No. 0 ventilated cover

### Adaptor



OMA228000001 NSTAR No. 0 adaptor

### Cover and Grate Options

Cover Diameter	NSTAR Cover Type	NSTAR Cat. ID No.	Product Number
27 9/16	No. 1 cover	1347	OMA227200001
27 9/16	No. 1V grate	1348	OMA227200014
37 7/16	No. 0 ventilated	19483	00158035
37 7/16 outside (for 27 9/16 cover)	No. 0 adaptor	1097	OMA228000001

Note: all dimensions are in inches.

## NSTAR (CONTINUED)

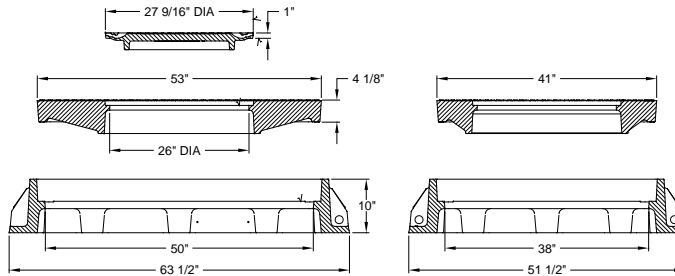
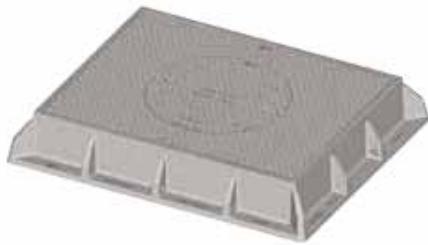

OMA227200020 NSTAR No. 00 frame,  
No. 00 solid cover adaptor and No. 1 cover

### Frame Options

Frame Height	NSTAR Frame Type	NSTAR Cat. ID Number	Product Number
10	No. 00 frame	1383	OMA227300000

Note: all dimensions are in inches.

### Cover Options

Cover Size	NSTAR Cover Type	NSTAR Cat. ID Number	Product Number
53 x 41 outside dim.	No. 00 adaptor	1098	OMA227300001
53 x 41 outside dim.	No. 00 vented adaptor	19700	00227335

Note: all dimensions are in inches.



00227335 NSTAR No. 00 vented adaptor

## Additional Solutions and Information





## MANHOLE FRAMES AND COVERS



EJ produces street castings to meet ASTM and AASHTO criteria. In addition, our castings meet federal and state DOT specifications, and that of individual customers. Non-traffic, light, medium, heavy, extra heavy-duty, and extra heavy-duty airport are the load designations assigned, which indicate where (on which application) a product should be used.

As a result of continued research and development—the product line is increasingly expanding—and has become more complex and diverse than ever. New features such as ergonomic lift-assist devices; new configurations that are more modular and scalable; new advanced security attributes help prevent theft or mitigate explosions; and applied technology provides capabilities like remote sensing with wireless telemetry.

## DRAINAGE CASTINGS



Drainage castings or grates are designed to accept water and can be round, square, or rectangular. They are typically sold with a frame, curb inlet frame, monument box, or bridge drain. Some markets call these slotted covers.

Specifying the appropriate drainage solution is an important part of a storm water management plan. EJ offers a wide array of products designed for storm water drainage including ditch grates, pipe grates, curb and gutter inlets, and catch basins. Drainage castings are available as an assembly or set. EJ also offers bridge drains, scuppers, and ADA grates.

Optional “Dump No Waste! Drains To Waterways” and other permanent cast-in lettering is an effective, low cost, and long-term means to support local environmental initiatives.

## TRENCH GRATES



From pedestrian areas to airport loading ramps, EJ has the trench drainage solution to fit your application. With a grate that is designed to be supported on two sides, it is expandable and available in numerous widths.

Grating options include parallel grates, perpendicular cross-street drainage, and ADA styles - available in 24" lengths, and widths from 8" to 51". Frames available in standard 24", 36", and 48" lengths.

Standard heavy duty grates and covers are suitable for general traffic service and AASHTO H-20 loading conditions. Our ADA style trench grating and solid trench covers are available for either general traffic loading or non-traffic applications. Extra heavy duty (EXA) airport trench grating is made with ductile iron and is proof load tested to 200,000 pounds.

For that artistic touch, EJ offers designer trench grates that can stand alone architectural enhancements, or can accompany matching tree grate designs.

## AIRPORT AND PORT AUTHORITY



Environments that undergo excessive load conditions require construction castings specifically designed to meet or exceed heavy duty load rating standards. EJ offers many solutions for these types of applications.

From round or square manhole frames and covers, catch basins, drainage inlets, trench grating, and mooring eyes, EJ has you covered.

All extra heavy duty construction castings are manufactured with gray iron conforming to ASTM A48 Class 35B and ductile iron conforming to ASTM A536. Many of our airport castings can be made-to-order with custom logos and messaging, in most languages, to meet your project specifications.

## UTILITY AND TELECOMM CASTINGS



EJ offers a comprehensive line of high quality utility construction casting solutions for specialized applications such as telecommunication, electric, gas, traffic signals, and street lighting.

Utilities are the lifeblood of any facility, and uninterrupted service is crucial. Our product designs offer superior access and unparalleled security for critical infrastructure —available in a variety of sizes, shapes, materials, and load ratings to fit the needs of any project.

EJ is the world leader in telecommunication and utility solutions, offering features and attributes to meet your unique requirements:

- Ergonomic and safety
- Vented covers
- Composite materials
- Wireless monitoring
- Specialty and custom
- Explosion mitigation

## INNOVATIVE ACCESS SOLUTIONS



Innovative access solutions are a classification of products that address issues beyond standard manhole frames and covers. This product series includes ergonomic solutions, advanced locking mechanisms, and products that prolong your infrastructure.

For example, the SELFLEVEL® manhole assembly allows the upper frame cover to adjust with the surface of the roadway; keeping the cover level at all times. This product is ideal for extreme freeze/thaw (frost heave) environments.

INFRA-RISER® adjustment risers prolong structure life by dissipating traffic vibrations.

The mechanical strut on our ductile iron hatch line reduces the lifting force of covers weighing up to 560 pounds to less than 35 pounds.

EJ has taken generations of knowledge and experience and fine-tuned designs to offer you the best innovative access solutions.

## ERMATIC RANGE AND OTHER MODULAR SOLUTIONS



Worldwide, the ERMATIC® modular system is one of the most adaptable product ranges in the industry. This comprehensive and highly engineered range of access covers can be customized to fit any underground vault dimension or cover configuration. Some of the world's most prestigious infrastructure projects have selected the ERMATIC range as their preferred solution: from airports, docks and tunnels to sewage, telecommunications and other utility networks.

Specifiers, contractors, and end users choose this product because it is reliable, durable and serviced by the most professional technical support teams. EJ provides solutions that lead the industry, act as best-in-class benchmarks, and satisfy the most demanding customer expectation.

Features and options include security locking, various load ratings and standard sizes between 2' x 2' to 10' x 17'. Custom sizes are available to fit your needs. Cover options include solid or recessed for concrete infill or brick pavers. This product is manufactured at our regional facility in France.

## HINGED HATCH ACCESS ASSEMBLIES



Hinged access assemblies offer ergonomic benefits with the strength of ductile iron. The 8190 and 8210 series of hinged hatch access assemblies are typically installed in traffic areas, airports, and ports.

This hatch provides a secure and easy access point to underground utility structures, and the mechanical strut reduces the lifting force of the cover to less than 35 pounds. The pre-assembled unit saves time and money on the job site; just "drop and pour." The cover opens to 105 degrees and removes at 90 degrees, and features a self-engaging safety bar.

## COMPOSITE COVERS AND FRAMES



Field performance has proven that composite manhole covers are ideal for the most challenging environment. Safety for pedestrian traffic and utility workers has driven EJ to develop an advanced solution offering the highest level of safety and performance. Composite manhole covers will conduct neither stray voltage nor high heat, thus shielding pedestrians from the underground environment. The advanced ergonomic aspects of composite manhole covers and frames help to safeguard the municipal workforce from injuries.

Contact your local Sales Representative for the solution that best fits your unique needs: stray voltage, heat transfer, steam covers, ergonomics, radio frequency and cellular transmissions, theft (no scrap value), corrosion, identification (color options), and noise abatement.

Patented design features and advanced fiber reinforced polymer (FRP) material technology make our composite products strong, lightweight, and safe for everyone.



## ALUMINUM ACCESS HATCHES



EJ has a broad offering of access hatch products available in aluminum, steel, and ductile iron.

Our hatches are designed to provide easy and secure access to below ground, and below floor installations. The aluminum SAFE HATCH® safety grate system is available in all hatch series. This additional fall through protection and controlled confined space entry enhances worker safety. Heavy duty stainless steel hinges are standard on all units.

Access hatches are used in areas such as sewer pump stations, water treatment plants, gas valve vaults, water meter pits, water valve vaults, telephone and electric vaults, industrial plant pits, fuel storage pits, de-icing control facilities, storm drains, monitoring wells, and collection pits.

EJ also has a complete line of fabricated steel reticuline and welded type drainage grates.

Our modern manufacturing facilities are capable of producing custom fabrications. Contact our expert design team next time you need a custom solution for your project.

## RISER RINGS



Riser rings are an adjustable solution to bring a manhole or catch basin to grade on your resurfacing projects. They are used in conjunction with a frame to increase its overall height. A typical application would be during pavement overlays.

Avoid unnecessary project costs by eliminating extra labor, equipment and materials. There are reduced traffic disruptions—when the street is paved the job is done and the manhole cover is finished to grade.

- Solid or adjustable styles
- Steel and cast iron risers available to fit all your grade adjustments
- Load tested to ensure dependable strength and long lasting durability
- Large inventory ready for delivery nationwide
- Made to order sizes for custom application
- Sloped risers available
- DOT approved in many states

## ADJUSTMENT RISERS



Maintain the integrity of your infrastructure by reducing traffic vibration damage. Adjust any manhole or catch basin to grade on your resurfacing projects, new installations, or rehabilitation work with INFRA-RISER® rubber composite adjustment risers.

Below ground, the rubber composite adjustment riser reduces traffic vibration damage—prolonging the life of manhole structures and surrounding pavement:

- Protects against load concentration stress
- Dramatically reduces water infiltration
- Perfect grade adjustment in moments with uniform precision
- Will not break, split, rot, crack, or chip
- Made of 92% recycled raw materials
- Round, square, and rectangular designs; flat and tapered risers, select bolt hole patterns
- Custom sizes available

INFRA-RISER adjustment riser is a simple, economic, efficient, and long-lasting solution. It dissipates the energy transferred between the casting and the manhole structure.

## FIRE HYDRANTS



WaterMaster® Fire Hydrants have set the standard for reliability and ease of maintenance. With 2 and 3-nozzle hydrant designs, along with multiple shoe connection options, WaterMaster hydrants offer the right options to meet your standard specifications. All hydrants are compliant with the Reduction of Lead in Drinking Water Act 2011. Computer aided design and analysis, along with ductile iron construction, ensures superior performance. All cast components are made and assembled in the USA.

Each hydrant is pressure tested to twice the rated working pressure. WaterMaster 5CD250 and 5BR250 fire hydrants meet or exceed the requirements of ANSI/AWWA C502 Standard for Dry-Barrel Fire Hydrants, Underwriters Laboratories Standard UL246, and Factory Mutual 1510.

Options include individual hydrants being assembled to your (municipal) specification. Additionally, EJ offers hydrant accessories, including the snow barrel for BR models to keep hydrants accessible for areas with high snowfall, and Storz nozzle connections for quick pumper nozzle attachment.

## GATE VALVES



FlowMaster® Resilient Wedge Gate Valves are designed to control the flow of water in fire hydrant applications—but can also be utilized for other water distribution or sewer system applications. All valves are compliant with the Reduction of Lead in Drinking Water Act 2011.

The valves incorporate quality parts and a simple design. All-ductile iron construction delivers superior strength, impact resistance and reduced weight ensuring long service life. All valve parts are manufactured and assembled in the USA.

Available in 2" through 24" sizes, with multiple end connections, and bevel or spur gear operators for 20" and 24" valves. The valves are available as either an assembly or set.

FlowMaster valves meet or exceed the performance requirements of AWWA C515 and Underwriters Laboratories Standards UL262. The valve body and other ductile iron components are manufactured from material conforming to ASTM A536. The wedge is fully rubber encapsulated to meet ASTM D429 requirements.

## VALVE BOXES



Valve boxes are used to access an underground valve and can be adjustable using multiple pieces with either a screw type or slip type arrangement.

Valve boxes are available to accommodate 4" through 20" valves.

- Natural gray iron or water-based asphaltic coating
- Covers with special lettering and custom logos
- Locking lids
- Valve box risers—raise valve box lid to adapt to a new grade
- Made in the USA

The slip type has interchangeable pieces that allow for overall height adjustment with parts sliding past each other, while the screw type has interchangeable pieces that allow for overall height adjustment with parts threaded into each other. Valve boxes are available as either an assembly or set.



## METER BOXES



The meter box product is specifically intended to cover a water meter. It is typically large enough to allow for inspection and limited access, and is often intended for non-traffic situations.

EJ offers an assortment of meter boxes, covers, and rings to fit your application. Our broad meter box product offering includes customized logo covers to help promote your identity, special lettered covers that clearly identify the access point, and touch read covers.

- Oval meter boxes
- Round meter boxes
- Rectangular meter boxes
- Meter pits
- Meter lids
- Meter box cover accessories including security locking

Meter boxes are available as either an assembly or set.

## TREE GRATES



Style your surroundings with timeless and appealing streetscape products manufactured by EJ. Tree grates are durable, functional, and architecturally appealing, and promote healthy tree growth. Designed for pedestrian traffic; our full line of tree grates provide natural drainage and enhance any urban, campus, or park setting.

The slotted design allows for efficient watering and is ADA compliant for pedestrian safety. The narrow slot of an ADA grate also prohibits litter from collecting in the tree well and minimizes the growth of weeds.

Optional expandable tree openings consist of removable center rings, which are a convenient way to adjust diameter of the grate opening as the tree trunk grows in width. Other options include security bolting features, and light port options.

Cast iron grating is strong and stands up to harsh environmental conditions. As an added value, the tree grates can carry community logos and mottos and are made in the USA.

## DETECTABLE WARNING PLATES



DURALAST® Detectable Warning Plates help warn visually impaired pedestrians of the approaching street. Engineered to outlast the sidewalk, this cast iron plate is a long-lasting streetscape product that can withstand rigorous urban conditions, such as snow plows, street cleaning machines, and vehicular traffic.

Lower your maintenance and product life cycle costs by using DURALAST detectable warnings—your ADA compliant and environmentally friendly solution.

- Long-wearing cast iron (over 500 times more wear resistant than composites\*)
- Withstands vehicular and snow plow traffic
- Corrosion resistant
- Permanently embedded into concrete
- Comply with the latest ADA guidelines regarding pedestrian and vehicular traffic

\*An independent third party laboratory test was conducted to determine the wear index values of DURALAST® Detectable Warning Plates versus a competing composite surface. Test results indicate that DURALAST plates are over 500 times more wear resistant than composites.

# ejco.com

Featuring a comprehensive product database with advanced search and browsing capabilities

### Information for Registered Users

- Quick and easy registration
- PDF sales drawings for download
- Specification information
- Customizable project lists
- Detailed product info

### Up-to-date Product Resources

- Literature
- Videos
- Installation instructions

### The Video Tour

- Collection of online videos providing an overview of key features and functions

### Finding your Solution

- Search by Product Line
- Search by Project Type
- Search Bar
- Narrow Search by Product Attributes
- Search by Regional Specification

### Product Specifications

- Available only to registered users
- National and international specifications
- Local Standards—City, County, State

### Project Lists

- Simple to create
- Quick access to frequently used products
- Helps manage complex projects
- Feature—request a quote with a click of a button
- Feature—print project list
- Feature—e-mail project list
- No limit to the number of lists

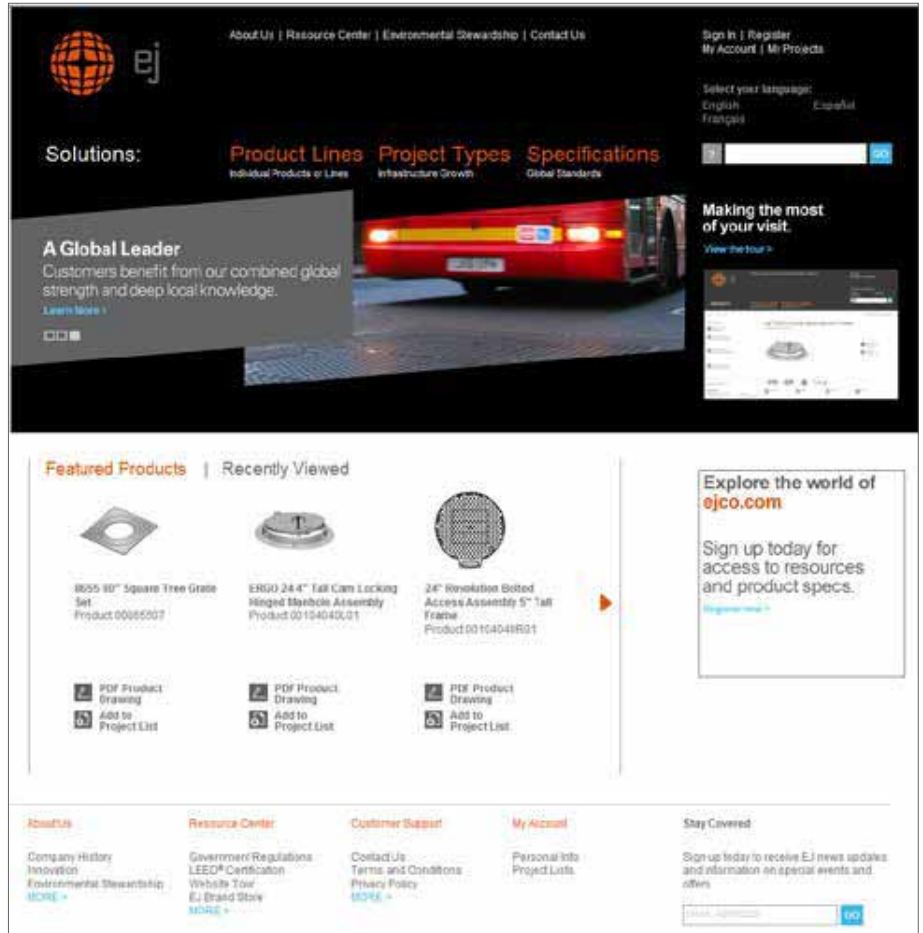

The Website Tour is available on the home page, and in the Resource Center

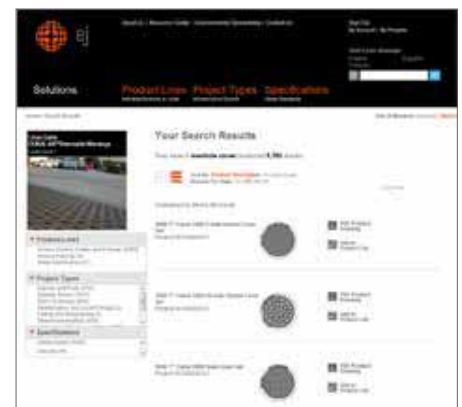

The search results can be narrowed by using the facets and attributes on the left



# Cross Reference



## CROSS REFERENCE MASSACHUSETTS

LeBaron No.	EJ Product No.	Description	Page No.	LeBaron No.	EJ Product No.	Description	Page No.
<b>9" x 10" Frame and Covers</b>				<b>9" x 10" Frame and Covers</b>			
LA0910	OMA157000001	9 X 10 FRAME	10	L32C22	OMA200000027	32 X 1-3/4 COVER DRAIN	13
L09C3	OMA157000002	9 X 3/4 COVER PLAIN	10	L32C22ST	OMA200000028	32 X 1-3/4 SEALTITE PLAIN COVER	13
L09C3	OMA157000003	9 X 3/4 COVER SEWER	10	L32C22ST SEWER	OMA200000029	32 X 1-3/4 SEALTITE SEWER COVER	13
L09C3	OMA157000004	9 X 3/4 COVER DRAIN	10	<b>City of Worcester Frames and Covers</b>			
L09C3	OMA157000005	9 X 3/4 COVER CLEANOUT	10	N/A	OMA105000014	WORCESTER 23 X 4 FRAME	14
<b>24" Frames</b>				LC239	OMA105000004	WORCESTER 23 X 9 FRAME	14
LA244	OMA124000021	24 X 4 FRAME	11	LC239	00105613	1056ZPT 9" TALL FRAME FOR BOLTING WITH EON FEATURE	14
LA246	OMA124000022	24 X 6 FRAME	11	L23C1	OMA105000005	WORCESTER PLAIN COVER	14
LA248	OMA124000023	24 X 8 FRAME	11	L23C1ST	OMA105000008	WORCESTER SEALTITE COVER	14
<b>24" Covers</b>				L23G1	OMA105000009	WORCESTER GRATE	14
L24C32	OMA124000024	24 X 1-1/4 COVER PLAIN	11	<b>Boston Water and Sewer Commission Frame and Covers</b>			
L24C32	OMA124000025	24 X 1-1/4 COVER SEWER	11	LJ101A FRAME	OMA211000046	BWSC 26 X 8 FRAME	15
L24C32	OMA124000026	24 X 1-1/4 COVER DRAIN	11	L26C08 COVER	OMA211000047	COVER - "BOSTON SEWER"	15
L24C32ST PLAIN	OMA124000027	24 X 1-1/4 SEALTITE PLAIN COVER	11	L26C08 COVER	OMA211000048	COVER - "BOSTON DRAIN"	15
L24C32ST SEWER	OMA124000028	24 X 1-1/4 SEALTITE SEWER COVER	11	LJ115	00191711	1917Z FRAME 8-1/8"	15
<b>24" Grates</b>				L30C5	00191721	1917 VENTED COVER BOSTON SEWER L30C5	15
L24G6	OMA124000029	24 X 1-1/4 GRATE	11	L30C5	00191723	1917 VENTED COVER BOSTON DRAIN L30C5	15
L24G7 ADA	OMA112000001	24 X 1 1/4 GRATE "ADA"	11	<b>Hand Hole / Pull Box Frames and Covers</b>			
<b>26" Frames</b>				S612F	OMA801200002	MASSDOT 12X12X3-1/2 PULL BOX FRAME	17
LA264-2	OMA226000001	26 X 4 FRAME	12	S212C	00801221	8012A SOLID JUNCTION BOX COVER	17
LA266	OMA226000002	26 X 6 FRAME	12	LV1618	00811812	8118Z 4 FLG FR	17
LA268-4	OMA211000038	26 X 8 FRAME	12	LV1618C	00811825	8118A BWSC DIAMOND TOP CV	17
<b>26" Covers</b>				S324F	OMA801000003	MASSDOT 24X24X3 REVERSIBLE FRAME	17
L26C26	OMA211000039	26 X 1-1/8 COVER	12	S224C	OMA801000012	24 X 24 COVER - "ELECTRIC"	17
L26C26	OMA211000040	26 X 1-1/8 SEWER COVER	12	LV1325	OMA801300001	MASSDOT 13X25X3 PULL BOX FRAME	17
L26C26	OMA211000041	26 X 1-1/8 DRAIN COVER	12	LV1325C	OMA801300014	COVER - "CATV"	17
L26C26ST	OMA211000042	26 X 1-1/8 SEALTITE PLAIN COVER	12	<b>24" x 24" Frames</b>			
L26C26ST SEWER	OMA211000043	26 X 1-1/8 SEALTITE SEWER COVER	12	LF 244-2 3FLG	OMA554000001	24 X 4 3-FLANGE FRAME	20
<b>26" Grates</b>				LF 244-2 4FLG	OMA554000002	24 X 4 4-FLANGE FRAME	20
L26G5 GRATE	OMA211000044	26 X 1-1/8 GRATE	12	LF 246-2 3FLG	OMA554000003	24 X 6 3-FLANGE FRAME	20
L26G13 ADA GRATE	OMA211000045	26 X 1-1/8 ADA GRATE	12	LF 246-2 4FLG	OMA554000004	24 X 6 4-FLANGE FRAME	20
<b>32" Frames</b>				LF 248-5 3FLG	OMA554000005	24 X 8 3-FLANGE FRAME	20
LA324-5	OMA200000022	32 X 4 FRAME	13	LF 248-5 4FLG	OMA554000006	24 X 8 4-FLANGE FRAME	20
LA326-5	OMA200000023	32 X 6 FRAME	13	LK125 3FLG	OMA552000016	24X24X4 3-FLANGE HEAVY FRAME	20
LA328-5	OMA200000024	32 X 8 FRAME	13	<b>32" Covers</b>			
<b>32" Covers</b>				L32C22	OMA200000025	32 X 1-3/4 COVER PLAIN	13
L32C22	OMA200000026	32 X 1-3/4 COVER SEWER	13	L32C22	OMA200000026	32 X 1-3/4 COVER SEWER	13

Products listed in cross reference section are not all inclusive of products available. Contact your local EJ representative for more information.

## CROSS REFERENCE MASSACHUSETTS (CONTINUED)

LeBaron No.	EJ Product No.	Description	Page No.	LeBaron No.	EJ Product No.	Description	Page No.
LK125 4FLG	OMA552000015	24X24X4 4-FLANGE HEAVY FRAME	20	L27DG1 GR	00727831	7278 GRATE	25
LK123 3 FLG	OMA552000081	24X24X8 3-FLANGE HEAVY FRAME	20	L27DG3	00727833	7278 GRATE WITH LOCK LUG	25
LK124 4 FLG	OMA552000082	24X24X8 4-FLANGE HEAVY FRAME	20	<b>Beehive Frame and Grate</b>			
<b>24" x 24" Grates</b>				LCG226-2	OMA801300020	22 X 6 BEEHIVE FRAME & GRATE ASSEMBLY	30
L24SG17	OMA552000074	24 X 24 STANDARD GRATE	21	N/A	OMN120500025	MN 1205Z 7" FR & 1205 02 BEEHIVE GR	30
L24SG01	OMA552000075	24 X 24 SQUARE HOLE GRATE	21	<b>Traps and Hoods</b>			
L24SG1	00552064A01	5520M5 UND DNW CAM HORN GR	24	L202	0MAL20200001	CATCH BASIN HOOD ASSEMBLY	30
L24SG18L	OMA552000076	24 X 24 CASCADE LEFT GRATE	21	L202	0MAL20200002	L202 HOOD	30
L24SG18R	OMA552000077	24 X 24 CASCADE RIGHT GRATE	21	L202H	0MAL20200003	L202H HANGER	30
L24SG20	OMA552000078	24 X 24 ADA GRATE	21	L202SH	0MAL20200005	CATCH BASIN HOOD ASSEMBLY	30
<b>24" x 48" Frames</b>				L218	0MALB2100008	CATCH BASIN TRAP	31
LV2448-1 3FLG LSD	OMA544400011	24X48X4 3-FLANGE DOUBLE FRAME	22	N/A	00595466	5954 UND 6" TRAP	31
LV2448 3FLG SSD	OMA544400106	24X48X4 3-FLANGE DOUBLE FRAME	22	N/A	00595467	5954 UND 8" TRAP	31
LV2448-1 4FLG	OMA544400012	24X48X4 4-FLANGE DOUBLE FRAME	22	N/A	00595468	5954 UND 10" TRAP	31
LV2448-2 3FLG LSD	OMA544000001	24X48X8 3-FLANGE DOUBLE FRAME	22	N/A	00595470	5954 UND 12" TRAP STRAIGHT	31
LV2448-2 3FLG SSD	OMA544400107	24X48X8 3-FLANGE DOUBLE FRAME	22	N/A	00595469	5954 UND 12" TRAP 24" RADIUS	31
LV2448-2 4FLG	OMA544000002	24X48X8 4-FLANGE DOUBLE FRAME	22	N/A	00595475	5954 UND 15" TRAP STRAIGHT	31
<b>City of Boston 28" x 28" x 8" Frames and Grates</b>				<b>MassDOT</b>			
LF284 3 FLG	OMA728800022	28 X 28 X 4 FRAME 3 FLANGE	24	LK110A	OMA211000002	MASSDOT TYPE B MANHOLE FRAME	32
LF284 4 FLG	OMA728800023	28 X 28 X 4 FRAME 4 FLANGE	24	L26C2	OMA211000003	26 X 1-1/8 COVER	32
LF288 3 FLG	OMA728800012	28 X 28 X 8 3-FLANGE FRAME	24	L26C02	OMA211000004	26 X 1-1/8 SEWER COVER	32
LF288 4 FLG	OMA728800013	28 X 28 X 8 4-FLANGE FRAME	24	L26C02	OMA211000005	26 X 1-1/8 DRAIN COVER	32
L28SC1	00728825	7288A VENTED 1 HOLE COVER BSD	24	LK110	OMA211000001	MASSDOT TYPE A MANHOLE FRAME	32
L28SG1	OMA728800014	28 X 28 GRATE	24	LK120	OMA552000010	MA 24X24X8 3 FLANGE FRAME	33
L0814C01	00726721	7267PL BOSTON HARBOR UND	24	L24SG7	OMA552000014	MA 24 X 24 A-1 BAR GRATE	35
L0814C02	00726723	7267PL NEPONSET RIVER UND	24	LK121	OMA552000011	MA 24X24X8 4 FLANGE FRAME	33
L0814C03	00726725	7267PL CHARLES RIVER UND	24	L24SG7	OMA552000014	MA 24 X 24 A-1 BAR GRATE	34
<b>City of Worcester 28" x 28" x 8" Frames and Grate</b>				LK120	OMA552000010	MA 24X24X8 3 FLANGE FRAME	34
LF288 3 FLG	OMA728800015	28 X 28 X 8 FRAME 3FLG	25	LK120-M	OMA552000003	MASSDOT 24X24X8 3 FLG FRM FOR H&L	34
LF288 4 FLG	OMA728800016	28 X 28 X 8 FRAME 4FLG	25	LK121-M	OMA552000002	MASSDOT 24X24X8 4 FLG FRM FOR H&L	34
L28SG1	OMA728800017	28 X 28 GRATE	25	L24SG24	OMA552000001	MASSDOT A-4 HOOK & LOCK BAR GRATE	34
<b>"D" Frames and Grates</b>				L24SG18-L	OMA552000076	MA 24X24 CASCADE LEFT GR	21
LD-268-1	00726811	7268Z "D" STYLE UND	25	L24SG18-R	OMA552000077	MA 24X24 CASCADE RIGHT GR	21
LD278-2 FR	00727811	7278 8" TALL CATCH BASIN FRAME	25	L24SG23-L	OMA555000004	MASSDOT B-1 HOOK & LOCK CSCADE GR L	33
L26DG1	00726831	7268M1 "D" STYLE UND	25	L24SG23-R	OMA555000005	MASSDOT B-2 HOOK & LOCK CSCADE GR R	33
				LK125-2FLG	OMA552500001	MA 24X24X4 DROP INLET 2 FLANGE FRM	35

Products listed in cross reference section are not all inclusive of products available. Contact your local EJ representative for more information.



## CROSS REFERENCE MASSACHUSETTS (CONTINUED)

LeBaron No.	EJ Product No.	Description	Page No.	LeBaron No.	EJ Product No.	Description	Page No.
LK125-3FLG	0MA552000016	MA 24X24X4 DROP INLET 3 FLANGE FRM	35	<b>5 Bar Cascade Frame and Grate</b>			
LK125-4FLG	0MA552000015	MA 24X24X4 DROP INLET 4 FLANGE FRM	35	LK450	ORI547000001	RI 6.3.3 24 X 22 X 5 4 FLANGE FRAME	43
L24SG7	0MA552000014	MA 24 X 24 A-1 BAR GRATE	35	L2422G1	ORI547000002	RI 6.3.3 24 X 22 5-BAR CASCADE GRATE	43
S612F	0MA801200002	MASSDOT 12X12X3-1/2 PULL BOX FRAME	17	<b>Circular Drain Frame and Grate</b>			
S324F	0MA801000003	MASSDOT 24X24X3 REVERSIBLE FRAME	17	LK284	00120513	1205Z1 4" TALL FRAME	43
LV1325	0MA801300001	MASSDOT 13X25X3 PULL BOX FRAME	17	L424G1	00120533	1205M2 CIRCULAR VANE GRATE	43

## RHODE ISLAND

### Municipal Frames and Covers

LA326-5	00200611	2006Z 6" TALL FRAME	38	L26C10	ORI225000011	RI 26" RIDOT COVER W/ HOLES	44
L32C22	00200677	2006C UND CRANS SW YR HL1 L32C22	38	L26C2 (84)	ORI225000006	RI 26" RIDOT HEAVY DUTY COVER	44
LJP10	00242019	2420Z1PT UND FRAME STACKABLE	39	L26C14	ORI223000002	RI 6.2.0 26" RIDOT COVER	44
L24C8	00240834	2408CPT UND EPIC CITY OF PROVIDENCE	39	L26C10	ORI225000010	RI 6.2.1 26" RIDOT COVER	44
LK253	00225311	2253Z UND FR FLG3	39	<b>Handhole Frames and Covers</b>			
N/A	001040081A01	1040AGS CAM SPC MCH 1" DP CV ASY	39	LJ104	ORI290400001	RI 18.2.0 16X3-1/2 FR D&T ONLY	45
LV0823	00801111	8011Z 2-1/2" TALL JUNCTION BOX FRAME	39	L16C1 "ELECTRIC" D&T	ORI290400002	RI 18.2.0 16" ELECTRIC D&T ONLY	45
L0823C	00801144	8011A UND CITY OF PROVIDENCE CV	39	L16C1 "SIGNAL" D&T	ORI290400003	RI 18.2.0 16" SIGNAL COVER D&T ONLY	45
LF248-5 3 FLG	00554813	5548Z 8" TALL CATCH BASIN FRAME WITH 3 FLANGES	40	LA206	ORI106100008	RI 18.2.1 20 X 6 FR D&T ONLY	45
LF248-5 4 FLG	00554811	5548Z 8" TALL CATCH BASIN FRAME WITH 4 FLANGES	40	L20C1 "ELECTRIC" D&T	ORI106100009	RI 18.2.1 20" ELECTRIC D&T ONLY	45
L24SG1	005520002	5520M5 DI UND DNW PROVIDENCE GR	40	L20C1 "SIGNAL"	ORI106100003	RI 18.2.1 20" SIGNAL COVER	45
L24SG1	005520001	5520M4 DI UND DNW PROVIDENCE GR	40	LK256-2	ORI225615002	RI 18.2.1 26 X 9 FR D&T ONLY	45
LJP15	45660010	V5660 4" TALL REVERSIBLE FRAME	40	L26C6A	ORI225615003	RI 18.2.2 26" ELECTRIC COVER D&T ONLY	45
L2436G1/G2	45660033	V5660 GRATE DUMP NO WASTE! DRAINS TO WATERWAYS	40	L26C6A	ORI225615004	RI 18.2.2 26" SIGNAL COVER D&T ONLY	45
LA/LC266	00226611	2266Z 6" TALL FRAME	41	<b>24" x 24" Single Frames</b>			
L26C26	00211147	2111A UND EPIC WARWICK CV	41	LK120	ORI552000001	RI 24 X 24 X 8 3 FLANGE FRAME	46
LA326-5	00200611	2006Z 6" TALL FRAME	41	LK121	ORI552000003	RI 24 X 24 X 8 4 FLANGE FRAME	46
L32C22-WARWICK	00200687	2006C1 HL1 UND W SW LO L32C22	41	<b>24" x 48" Single Frames</b>			
LC256-2	00125611	1256Z 6" TALL FRAME	42	LV2448-2	ORI544000001	RI 3 FLANGE DOUBLE FRAME	46
L25C8-WD	00125850	1258A WOONSOCKET DRN HL2 UND CV	42	LV2448-2	ORI544000004	RI 4 FLANGE DOUBLE FRAME	46
L25C8-WS	00125851	1258C WOONSOCKET SW HL2 UND CV	42	<b>24" x 24" Grates</b>			
				L24SG1	ORI552000002	RI 24 X 24 SQUARE HOLE GRATE	47
				L24SG7	ORI552000006	RI 24 X 24 SLOTTED GRATE	47
				L24SG15	ORI552000010	RI 24 X 24 BIKE SAFE GRATE	47
				L24SG18-L	ORI552000014	RI 24 X 24 CASCADE GRATE L	47

Products listed in cross reference section are not all inclusive of products available. Contact your local EJ representative for more information.

## CROSS REFERENCE RHODE ISLAND (CONTINUED)

LeBaron No.	EJ Product No.	Description	Page No.	LeBaron No.	EJ Product No.	Description	Page No.
L24SG18-R	0RI552000015	RI 24 X 24 CASCADE GRATE R	47	<b>East Lyme</b>			

## CONNECTICUT

### 24" Manhole Frames and Covers

LA244	00124411	1244Z UND FRAME	50	<b>Hartford MDC</b>			
LA246	00124611	1246Z UND FRAME	50	LJ105	00220513	2205Z UND PH1 FRAME	53
LA248	00124811	1248Z UND FRAME	50	N/A	00124819	1248Z2 DI UND PH1 FRAME	53
L24C32	00133856	1338A UND EIGHTH DISTRICT SEW COVER	50	L24C21	00220521	2205A UND SEWER COVER	53
L24C32	00124677	1246C UND GNHWPCA LO HL2 OPH2 COVER	50	L24C21	00220523	2205C UND HL1 SEWER COVER	53
L24C32	0CT124800004	GNHWPCA 8" WATERTITE ASSEMBLY	50	L24C21	00220546	2205CGS UND SEWER COVER HL1	53
L24C32	00124879	1248B UND EP HL8 DRL HAMDEN STM COVER	50	L24C21	00220548	2205AGS UND SEWER COVER	53
L24C32	00133871	1338A UND TOWN MANCHESTER DRN COVER	50	L24C21	00220525	2205A UND WTR COVER	53
L24C32	00133872	1338A UND TOWN MANCHESTER SEWER COVER	50	L24C21	00220549	2205C UND HL1 WTR COVER	53
L24C32A	00124865	1248A UND EPIC MILFORD SEWER	50	L24C21	00220527	2205C UND STM DRN HL1 COVER	53
L24C32A	00124825	1248A UND EPIC SEWER COVER	50	L24C21	00220528	2205A UND STM DRN COVER	53
L24C32A	00124827	1248A UND EPIC STM COVER	50	L24G1-SP	00244031	2440M UND DNP TROUT LO GRATE	53
L24C32	00124869	1248AGS UND EPIC STAFFORD SEWER COVER	50	<b>Meriden</b>			
L24C32A	00124844	1248A UND EPIC WALLINGFORD	50	LJ116	00220515	2205Z1 UND 1 1/4" SEAT FR	54
<b>Bridgeport</b>				LC248-8	00124811	1248Z UND FRAME	54
LA264-2	00226411	2264Z UND FRAME	51	L24C32-SW	00124878	1248A UND EPIC MERIDEN SEWER	54
LA266	00226611	2266Z UND FRAME	51	L24C36-ST	00124875	1248A UND EPIC MERIDEN STM	54
LC268-2	00211111	2111Z UND FRAME	51	LA244	00124411	1244Z UND FRAME	54
L26C17	00211157	2111A UND BRIDGEPORT WPCA SEWER EPIC	51	LA246	00124611	1246Z UND FRAME	54
<b>Bristol</b>				<b>Middletown</b>			
LC244-SP	00241015S01	2410Z1 UND FRAME SPC MACH 24 3/8"	51	LA244	00124411	1244Z 4" TALL FRAME	55
LC246-2SP	00124615S01	1246Z1 UND FR HVY SPC MACH 24 3/8"	51	LA246	00124611	1246Z 6" TALL FRAME	55
LC248-1SP	00124815S01	1248Z1 UND FR HVY SPC MACH 24 3/8"	51	LJ105	00220515	2205Z1 8" TALL FRAME WITH 1-1/4" SEAT DEPTH	55
LC240	00224011	2240Z UND FRAME	51	LA244	00124413	1244ZPT 4" TALL FRAME FOR BOLTING WITH EON FEATURE	55
L24C23-ST	00224021	2240A SOLID COVER WITH GASKET	51	LA246	00124613	1246ZPT 6" TALL FRAME FOR BOLTING WITH EON FEATURE	55
<b>Danbury</b>				LA248	00220517	1248ZPT 8" TALL FRAME FOR BOLTING WITH EON FEATURE	55
LA268-3	00126811	1268Z UND FRAME	52	L24C32	00124862	1248A UND EPIC MIDDLETOWN COVER	55
L26C27-DAN-SS	00126823	1268A SOLID COVER DANBURY SANITARY SEWER	52	L24C32B	00124863	1248APT UND EPIC MIDDLETOWN CV	55
L26C27-DAN-ST	00126829	1268A UND DANBURY STM SW CV	52	L24C32	00124862D01	1248C UND EPIC MIDDLETOWN HL4 COVER	55
				<b>New Britain</b>			
				LC244-SP	00241015S01	2410Z1 UND FRAME SPC MACH 24 3/8"	55

Products listed in cross reference section are not all inclusive of products available. Contact your local EJ representative for more information.



## CROSS REFERENCE CONNECTICUT (CONTINUED)

LeBaron No.	EJ Product No.	Description	Page No.
LC246-2SP	00124615S01	1246Z1 UND FR HVY SPC MACH 24 3/8"	55
LC248-1SP	00124815S01	1248Z1 UND FR HVY SPC MACH 24 3/8"	55
LC240	00224011	2240Z UND FRAME	55
L24C23	00224020	2240C UND HL4 COVER	55
L24C23	00224022	2240C UND SEWER HL4 COVER	55
<b>New Haven</b>			
LC240-2	00224211	2242Z UND FR	56
L24C33	00224221	2242B UND NEW HAVEN COVER	56
L24C33	00224223	2242B UND NEW HAVEN STM COVER	56
N/A	00774017	7740Z2PT UND FLG3 FR	56
N/A	00774015	7740Z1PT UND FLG4 FR	56
N/A	00774031	7740M1 DI UND DNW TR LO GR TYPE A	56
N/A	00774041	7740M2 DI UND DNW TR LO GR TYPE B	56
N/A	00774033	7740M1 DI UND BLT4 DNW TR LO TYPE A	56
N/A	00774043	7740M2 DI UND BLT4 DNW TR LO TYPE B	56
<b>North Haven</b>			
LA268-3	00126811	1268Z UND FRAME	57
L26C1S	00126822	1268A UND SEWER COVER	57
L26C1S	00126824	1268A UND DRN COVER	57
<b>Trumbull</b>			
LA268-3	00126811	1268Z UND FRAME	57
LE260	00226011	2260Z UND FRAME	57
L26C1S	00126822	1268A UND SEWER COVER	57
L26C1S	00126824	1268A UND DRN COVER	57
L26C1S	00126827	1268AGS UND SEWER COVER	57
<b>Waterbury</b>			
LC244	00241015	2410Z1 UND FRAME W/O MUD RG 4"	58
LC246-2	00124615	1246Z1 UND FRAME HVY	58
LC248-1	00124815	1248Z1 UND FRAME HVY	58
L24C32-WSS	00124725	1247A UND WATERBURY SAN SEWER	58
L24C32-WST	00124670	1246C UND HL1 WATERBURY STM DRN LO	58
L24C32 WS LOGO	00124671	1246A UND WATERBURY SEWER LO COVER	58
LV2248-5	00759113	7591Z1 UND FRAME	58
L2248G7	00759039	7590M3 UND DNW GR	58
LV2248CU5	00759062	7590T1 6" UND TYNS DNW DTW TRO LO	58

LeBaron No.	EJ Product No.	Description	Page No.
<b>Connecticut DOT Frame and Covers</b>			
LK310	OCT121000003	CONNDOT STANDARD MANHOLE FRAME	59
LA254-SP	00121411	1214Z 4" TALL FRAME WITH SLOTTED BASE FLANGE HOLES	59
L25C3	OCT121000005	CONNDOT MANHOLE COVER - OPEN PICKHOLE	59

## NEW HAMPSHIRE

### Catch Basins

LK120-300	0NH552000001	NH DOT TYPE A, E, & F 3-FLANGE FRAME	62
LK121-400	0NH552000003	NH DOT TYPE A, E, & F 4-FLANGE FRAME	62
LK424	0NH532000005	NH TYPE B 3 FLANGE 4" TALL FRAME	62
LK424	0NH532000007	NH TYPE B 4 FLANGE 4" TALL FRAME	62
LK420	0NH532000001	NH TYPE B 3 FLG 8" TALL FRAME	62
LK420	0NH532000003	NH TYPE B 4 FLG 8" TALL FRAME	62
LK450	0NH547000001	NH TYPE E FRAME	62
L24SG7	0NH552000002	NH TYPE A SLOTTED GRATE	63
L2123G1	0NH532000008	NH TYPE B GRATE	63
L2422G1	0NH547000002	NH OLD TYPE E 5 BAR CASCADE GRATE	63
L24SG18	0NH552000012	NH TYPE F CASCADE GRATE L	63
L24SG18	0NH552000010	NH TYPE F CASCADE GRATE R	63
L24SG1	0NH552000016	NH SQUARE HOLE GRATE	63

### Manhole Frames and Covers

LA324-5	0MA200000022	32 X 4 FRAME	64
LA326-5	0NH200000001	NH 32 X 6 STANDARD MANHOLE FRAME	64
L32C22	0NH200000002	NH 32" STANDARD MANHOLE COVER PLAIN	64
L32C22	0NH200600001	NH 32" STANDARD MANHOLE COVER SEWER	64
L32C22	0NH200600002	NH 32" STANDARD MANHOLE COVER DRAIN	64

## VERMONT

### Standard Frame and Cover

LC248	OVT124000001	VT STANDARD FRAME	66
L24C01	OVT124000002	VT STANDARD COVER	66

### Drop Inlet Frames

LF246-300	OVT554600001	VT 3 FLANGE DROP INLET FRAME	67
-----------	--------------	------------------------------	----

Products listed in cross reference section are not all inclusive of products available. Contact your local EJ representative for more information.



## CROSS REFERENCE VERMONT (CONTINUED)

LeBaron No.	EJ Product No.	Description	Page No.	LeBaron No.	EJ Product No.	Description	Page No.
LF246-400	0VT554600002	VT 4 FLANGE DROP INLET FRAME	67	L28C11	OMA227600001	NATIONAL GRID 28" ELECTRIC SERVICE COVER	77
<b>24" x 24" Grates</b>				L2836X1	OMA227600002	NATIONAL GRID 38" ADAPTOR	77
L24SG07-000	0VT552000002	VT TYPE A SLOTTED BAR GRATE	67	LE276-3	OMA227600004	NATIONAL GRID 28 X 6 FRAME	77
L24SG01-000	0VT552000015	VT TYPE D SQUARE HOLE GRATE	67	LJ104	OMA290400001	NATIONAL GRID 16 X 3 1/2 FRAME	77
L24SG18	0VT552000007	VT TYPE E CASCADE GRATE LEFT	67	L16C01	OMA290400002	NATIONAL GRID 16" ELECTRIC SERVICE COVER	77
L24SG18	0VT552000008	VT TYPE E CASCADE GRATE RIGHT	67	<b>Northeast Utilities</b>			
<b>Type A, D, &amp; E and Double Type A Frames</b>				LE380-2	OMA380000002	NORTHEAST UTILITIES 38 X 10 FRAME	78
LK123-300	0VT552000003	VT TYPE A, D, & E 3 FLANGE FRAME	68	L38C05	OMA380000003	NORTHEAST UTILITIES 38 COVER 5 HOLE ELECTRIC	78
LK124-400	0VT552000001	VT TYPE A, D, & E 4 FLANGE FRAME	68	LE3265	OMA320000002	NORTHEAST UTILITIES 32 FRAME	78
LV2448-2-300	0VT544000002	VT TYPE A DOUBLE 3 FLANGE FRAME	68	LE32C18	OMA320000003	NORTHEAST UTILITIES 32 COVER 5 HOLE ELECTRIC	78
LV2448-2-400	0VT544000001	VT TYPE A DOUBLE 4 FLANGE FRAME	68	LE386-2	OMA380000005	NORTHEAST UTILITIES 38 X 6 FRAME	78
<b>Type B Frame and Cover</b>				L38C05	OMA380000003	NORTHEAST UTILITIES 38 COVER 5 HOLE ELECTRIC	78
LK450-000	0VT547000001	VT TYPE B FRAME	70	<b>NSTAR</b>			
L2422G01-000	0VT547000002	VT TYPE B 5 BAR CASCADE GRATE	70	LE270-2	OMA227000001	NSTAR #1384 NO. 1 MANHOLE FRAME	79

## MAINE

### City of Portland

N/A	0ME552000019	PORTLAND STANDARD DR5 24 X 5 FRAME	72
L24C12	0ME126000003	ME 24" PLAIN SOLID COVER 604(7)	72

### Main DOT Frame and Cover

LK610	0ME126000002	ME 24 X 8 FRAME 604(16)	73
L24C12	0ME552000020	ME 24" PLAIN SOLID COVER 604(7)	73

### Maine DOT Catch Basin Frames and Grates

LK126	0ME552000001	ME TYPE A 3 FLG FRM & BAR GRATE	74
LK127	0ME552000003	ME 24 X 24 X 8 FR 4 FLG 604(5) TY B	74
L24SG7	0ME552000002	ME 24 X 24 BAR GRATE 604(5)	74
L24SG18	0ME552000016	ME 24X24 GR NO CUT CORNERS 604(4)	74

## UTILITY AND TELECOMMUNICATION

### National Grid

LE386	OMA228600000	NATIONAL GRID 38 X 6 SQUARE BASE FRAME	77
-------	--------------	--	----

L28C11	OMA227600001	NATIONAL GRID 28" ELECTRIC SERVICE COVER	77
L2836X1	OMA227600002	NATIONAL GRID 38" ADAPTOR	77
LE276-3	OMA227600004	NATIONAL GRID 28 X 6 FRAME	77
LJ104	OMA290400001	NATIONAL GRID 16 X 3 1/2 FRAME	77
L16C01	OMA290400002	NATIONAL GRID 16" ELECTRIC SERVICE COVER	77

### Northeast Utilities

LE380-2	OMA380000002	NORTHEAST UTILITIES 38 X 10 FRAME	78
L38C05	OMA380000003	NORTHEAST UTILITIES 38 COVER 5 HOLE ELECTRIC	78
LE3265	OMA320000002	NORTHEAST UTILITIES 32 FRAME	78
LE32C18	OMA320000003	NORTHEAST UTILITIES 32 COVER 5 HOLE ELECTRIC	78
LE386-2	OMA380000005	NORTHEAST UTILITIES 38 X 6 FRAME	78
L38C05	OMA380000003	NORTHEAST UTILITIES 38 COVER 5 HOLE ELECTRIC	78

### NSTAR

LE270-2	OMA227000001	NSTAR #1384 NO. 1 MANHOLE FRAME	79
L28C06	OMA227200001	NSTAR #20453 NO. 1 MANHOLE COVER	79
LE276-4	OMA227400000	NSTAR #1385 NO. 1-L MANHOLE FRAME	79
L28C06	OMA227200001	NSTAR #20453 NO. 1 MANHOLE COVER	79
LE380	OMA228000000	NSTAR #1382 NO. 0 MANHOLE FRAME	79
LE2836X3	OMA228000001	NSTAR #1097 NO. 0 MANHOLE ADAPTOR	79
L28G4	OMA227200014	NSTAR #1348 NO. 1301 GRATE	79
L28G5	OMA227200015	28" NSTAR VENTED COVER	79

### Verizon

LE296	OMA180200000	VERIZON FRAME, MANHOLE SB27 542303	N/A
L29C02	OMA180500000	VERIZON COVER, MANHOLE B27 87028647	N/A
LE290	OMA180500001	VERIZON FRAME, MANHOLE B27 11048273	N/A
LE326	OMA182000000	VERIZON FRAME, MANHOLE SB30 11000169	N/A
L32C13	OMA181000000	VERIZON COVER, MANHOLE B30 87028646	N/A
LE320	OMA182500000	VERIZON FRAME, MANHOLE B30 87028675	N/A

Products listed in cross reference section are not all inclusive of products available. Contact your local EJ representative for more information.











CATV

 EJ

MADE IN USA





ej

ejco.com  
800 626 4653



**Americas**

**800 626 4653**  
231 536 2261

**EMEA**

Europe, Middle East  
and Africa

**+33 (0)344 08 28 00**

**Asia-Pacific**

**+61 (0)7 3216 5000**

East Jordan Iron Works, Inc., East Jordan, Michigan, USA, and its affiliated companies including Norinco in France, Cavanagh in Ireland, McCoy Construction Castings in Canada, and HaveStock in Australia, have been conducting business under one brand, EJ, since 2012.

One global name and brand unifies the company and supports our vision to be the global leader in infrastructure access solutions.

**EJ**

1125 Pearl Street  
Brockton, MA 02301  
508 586 3130 tel  
508 580 2740 fax  
us.sales@ejco.com

Registered Mark(s)

