

QUALITY EVAPORATIVE COOLER PRODUCTS



Aspen Snow-Cool™

**A Full Line of Evaporative Cooler
Pads, Pumps, Motors, Accessories & Covers**



PPS PACKAGING COMPANY

Aspen Snow-Cool™

Cooling Media

Aspen Snow-Cool™ Info	1-2
Cooler Pads	2-5
Excelsior Rolls	5
Tempo Rolls	5
Single Inlet	6

Pumps	7-8
--------------------	-----

Motors & Motor Kits	9-10
--------------------------------------	------

Water Supply & Control

Floats, Screens, Drains	12
Tubing & Clamps	13
Valves & Compression Fittings	14
Brass	15

Water Distribution

Distribution Tube Cleaner	
Heads & Tubes	16
Kits	17

Power Supply Accessories

V-Belts, Motor Pulleys, Shafts, Bearings, Collar/Washers, & Blower Pulleys	18-20
--	-------

Electrical

Switches & Cords	22-23
------------------------	-------

Miscellaneous	24
----------------------------	----

Cooler Care Products	25-26
-----------------------------------	-------

Cooler Covers	27-31
----------------------------	-------

Terms & Conditions	32
-------------------------------------	----

- A** Water Distribution System
- B** Electrical Box
- C** Aspen Snow-Cool™ Premier Cooler Pads, and Rolls
- D** Mighty Cool Cooler Pump
- E** Float Valve
- F** Overflow Drain
- G** Pump Hose
- H** Bleed-Off Tee
- I** Spider Bearing
- J** Blower
- K** Motors, Switches & Other Electrical Components
- L** Motor Pulley
- M** V-Belt
- N** Shaft and Bearing
- O** Blower Pulley

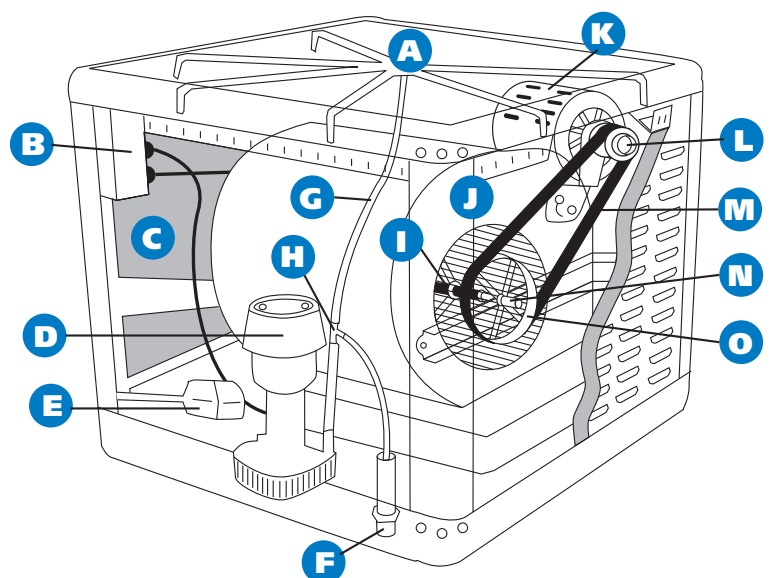

PPS PACKAGING COMPANY

3189 E. Manning Ave., PO Box 427,
Fowler, CA 93625-0427

(800) 344-6819 • (559) 834-1641 • FAX: (559) 834-2011
www.ppspackaging.com • www.aspensnowcool.com

PRE-SEASON MAINTENANCE

on Your Evaporative Cooler

Maintenance at the start of the season will insure dependable operation and maximize cooling efficiency of your evaporative cooler

- *Disconnect all electrical power*
- *Remove cooler cover. Cover should be cleaned, folded and stored in a cool dry area*
- *If applicable, remove slide damper in vertical duct*
- *Remove pad frames. Remove cooler pads. Clean pad frames. A wire brush may be needed to totally remove all mineral deposits. Paint metal pad frames with Aspen Snow-Cool™ Paint. Do not paint plastic pad frames.*
- *Clean water reservoir (cooler pan). A paint scraper and/or a wire brush may be needed to remove all mineral deposits. Cover all voids and exposed (unprotected) areas with Aspen Snow-Cool™ Submarine Sealer Cooler Coating. Do not coat plastic or powder coated cooler reservoirs.*
- *Remove belt and check for cracks or excessive wear. Replace if necessary.*
- *Spin the blower pulley. The blower pulley and shaft need to rotate freely. If the pulley rotates, but the shaft does not, the set screw may need to be tightened. If the shaft does not rotate easily, the blower bearings may need to be replaced. Check the blower pulley and replace if bent or deformed. Oil blower bearings*
- *Spin the motor pulley. The motor pulley and shaft need to rotate freely. If the pulley rotates, but the shaft does not, the set screw may need to be tightened. If the shaft does not rotate easily, the motor may need to be replaced. Check the motor pulley and replace if bent or deformed. If applicable, oil motor bearings.*
- *Check alignment of the motor pulley and blower pulley. They should be in line with each other.*
- *If cooler coating was applied, make sure it has had sufficient time to cure, prior to turning on water.*
- *Turn water on.*
- *Check float valve. Lift the float to see if the incoming water shuts off completely. If not, replace float valve.*
- *Turn the power on.*
- *Turn the pump on. If the pump does not run, replace it with a Mighty Cool Cooler Pump. Check for adequate water flow through the distributor tubes. If there is not adequate water flow, check the pump elbow, pump hose, distributor head, distributor tubes, and drip trays for obstructions. Clear the obstructions or replace defective parts.*
- *Turn pump off.*
- *Turn motor on. Check operation on low and high speeds (for two speed motors).*
- *Turn motor off.*
- *Install belt and check for proper tension.*
- *Install a set of new Aspen Snow-Cool™ Cooler Pads into pad frames. Make sure the pads cover the entire vented area of each frame.*
- *Install pad frames back into the cooler.*

Your evaporative cooler should now be ready for operation.

Keep Your Cooler Cooling With Aspen Snow-Cool!™

Aspen Snow-Cool™

The Coolest Cooler Pad

- 7% Cooler Air
- Fewer Pump & Water Flow Problems
- Quickest Cool Air Delivery
- Reduced Operating Costs
- Fewer Roof Trips

U.S. Patent No. 6,183,579 B1



Aspen Snow-Cool™ pads have been known for years as the finest in the market. Still, we knew we could do better. Cooler pads hold water, but any material that doesn't absorb water reduces overall cooling efficiency.

- We created the Premier Pad by starting with our pure Aspen excelsior. The open cellular structure of this excelsior allows our Premier Pad to hold more water. The result? More evaporative wicking area per square inch than any other evaporative cooler pad.
- We added Grid-Flo™ stitching, our exclusive all-natural biodegradable thread, that creates the most even flow of water throughout the pad surface. Special stitching creates fiber-stabilizing grids, which prevent hot spots that cost extra money to cool. Grid-Flo™ stitching also eliminates pad sagging that makes evaporative coolers inefficient. And, this new stitching requires fewer roof trips by reducing the debris that clogs pumps and filters.
- Best of all, Uni-Pad™ construction wets out the pad in a rapid and uniform pattern, making rooms cool quickly.

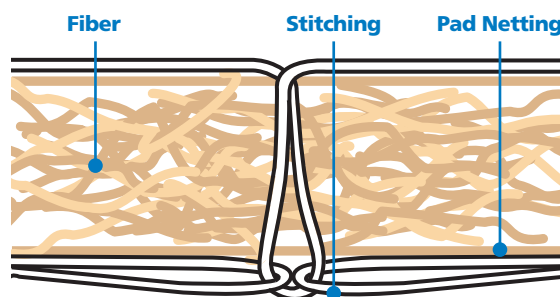

Fiber

- Aspen wood excelsior
- Natural wood color and free of objectionable odor
- Curled & barbed in cutting for added water holding capacity
- Mechanical layering into uniformly thick & dense mats

Pad Netting, Stitching & Structure

- Biodegradable stitching securing mat to netting
- Stitching penetrates matting, secures netting to stabilize and unitize the construction and eliminate sagging
- Each stitching seam runs the entire length of the pad
- Stitching seams spaced every 2" across the pad width
- Stitching will penetrate the pad, securing the net surfaces every 4" to create a quilt-like saturation system
- Pad ends adhesively sealed with enough netting to contain loose fibers

Finishing Requirements

- Stated pad dimensions shall be absolute minimum sizes
- 5% enlargement above stated pad dimensions is acceptable!

**More Efficient with 7% Colder Air,
Less Maintenance, and Fewer Trips to the Roof**

Premier Cooler Pad with Grid-Flo™ Stitching

Aspen Snow-Cool™ Premier Pad vs. CoolPad®

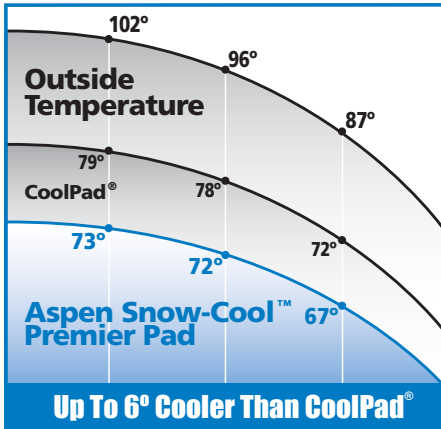

Aspen Snow-Cool™ Premier Pad vs. Tempo Roll

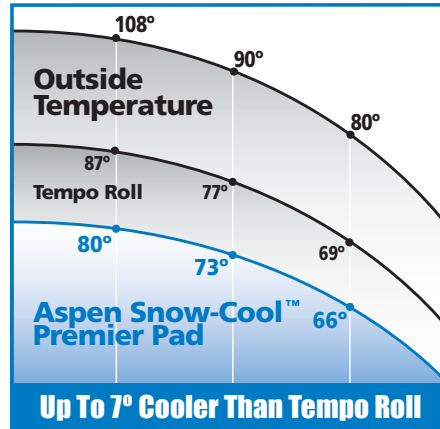

Cooler Than CoolPad® By Research Products & Tempo Roll By Ahlstrom Filtration LLC

Aspen Snow-Cool™ Premier Cooler Pad with Grid-Flo™ Stitching, CoolPad® (by Research Products Corporation, Avondale, Arizona) and Tempo Roll (by Ahlstrom Filtration LLC, Groesbeck, Texas) were recently tested* side by side in identical side discharge coolers. Results show that Aspen Snow-Cool™ Premier Pad with Grid-Flo™ Stitching delivered up to 7° cooler air than paper or synthetic pads.

*Testing was performed by PPS Packaging Company Engineering Department. Inquire for detailed test results.

Design Feature

- Integrated, Uni-Pad™ construction
- Stitched-grid format stabilizes fiber for even water distribution
- No-Sag stitching, design and construction
- Grid-Flo™ design for fastest pad saturation
- Integrated stitching & end-seaming contains debris
- Elimination of water channeling

Consumer Benefit

- Even air flow
- Cooler air, lower average temperature
- More efficient operation
- Quickest cool air delivery available
- Fewer pump & water flow problems
- No hot spots

Individually Packaged Premier Stitched Cooler Pads

Number	Description	UPC Code	Pkg/Qty	Weight per BDL	Pallet Qty
1IP	28" X 34"	0 53523 00201-3	Bundle/24	56.0#	432
2IP	22" X 34"	0 53523 00202-0	Bundle/24	44.0#	432
3IP	24" X 30"	0 53523 00203-7	Bundle/24	43.0#	432
4IP	20" X 36"	0 53523 00204-4	Bundle/24	42.0#	432
5IP	24" X 36"	0 53523 00205-1	Bundle/24	51.0#	432
6IP	20" X 22"	0 53523 00206-8	Bundle/24	26.0#	864
7IP	22" X 24"	0 53523 00207-5	Bundle/24	32.0#	864
8IP	30" X 36"	0 53523 00208-2	Bundle/24	63.0#	432
9IP	22" X 30"	0 53523 00209-9	Bundle/24	34.0#	432
10IP	22" X 50"	0 53523 00210-5	Bundle/24	66.0#	432
11IP	24" X 40"	0 53523 00211-2	Bundle/24	56.0#	432
12IP	28" X 32"	0 53523 00212-9	Bundle/24	52.0#	432

Premier Cooler Pad with Grid-Flo™ Stitching



Individually Packaged Premier Stitched Cooler Pads

Number	Description	UPC Code	Pkg/Qty	Weight per BDL	Pallet Qty
15IP	36" X 42"	0 53523 00215-0	Bundle/12	45.0#	216
16IP	18" X 22"	0 53523 00216-7	Bundle/24	23.0#	864
18IP	26" X 30"	0 53523 00218-1	Bundle/24	46.0#	432
19IP	20" X 27"	0 53523 00219-8	Bundle/24	32.0#	432
23IP	18" X 36"	0 53523 00223-5	Bundle/24	39.0#	432
24IP	32" X 36"	0 53523 00224-2	Bundle/12	34.0#	216
30IP	32" X 40"	0 53523 00230-3	Bundle/12	37.0#	216
44IP	24" X 27"	0 53523 00244-0	Bundle/24	35.0#	432
45IP	24" X 24"	0 53523 00245-7	Bundle/24	34.0#	864
46IP	29" X 29"	0 53523 00246-4	Bundle/24	50.0#	432
49IP	30" X 30"	0 53523 00249-5	Bundle/24	52.0#	432
52IP	18" X 26"	0 53523 00252-5	Bundle/24	31.0#	864
56IP	25" X 33"	0 53523 00256-3	Bundle/24	49.0#	432

Aspen Snow-Cool™ Premier Aireze Pads - Individually Poly-Wrapped

Number	Description	UPC Code	Pkg/Qty	Weight per BDL
IP120AIR	28" X 120"	0 53523 00274-7	Bundle/5	34.0#
IP124AIR	28" X 124"	0 53523 00270-9	Bundle/5	35.0#
IP126AIR	28" X 126"	0 53523 00271-6	Bundle/5	38.0#
IP138AIR	28" X 138"	0 53523 00272-3	Bundle/5	39.0#
IP144AIR	28" X 144"	0 53523 00275-4	Bundle/5	40.0#
IP168AIR	28" X 168"	0 53523 00273-0	Bundle/5	47.0#

- Ideal for HVAC contractors.
- No additional wrapping paper to dispose of.

Bulk Premier Stitched Cooler Pads

Number	Description	UPC Code	Pkg/Qty	Weight per BDL	Pallet Qty
1B	28" X 34"	0 53523 00101-6	Bundle/24	46.0#	432
2B	22" X 34"	0 53523 00102-3	Bundle/24	36.0#	432
3B	24" X 30"	0 53523 00103-0	Bundle/24	35.0#	432
4B	20" X 36"	0 53523 00104-7	Bundle/24	34.0#	432
5B	24" X 36"	0 53523 00105-4	Bundle/24	42.0#	432
6B	20" X 22"	0 53523 00106-1	Bundle/24	22.0#	864
7B	22" X 24"	0 53523 00107-8	Bundle/24	26.0#	864
8B	30" X 36"	0 53523 00108-5	Bundle/24	52.0#	432
9B	22" X 30"	0 53523 00109-2	Bundle/24	32.0#	432
10B	22" X 50"	0 53523 00110-8	Bundle/24	54.0#	432
11B	24" X 40"	0 53523 00111-5	Bundle/24	46.0#	432
12B	28" X 32"	0 53523 00112-2	Bundle/24	43.0#	432
13B	25" X 58"	0 53523 00113-9	Bundle/12	35.0#	216
14B	18" X 30"	0 53523 00114-6	Bundle/24	26.0#	432
15B	36" X 42"	0 53523 00115-3	Bundle/12	37.0#	216
16B	18" X 22"	0 53523 00116-0	Bundle/24	19.0#	864
17B	18" X 48"	0 53523 00117-7	Bundle/24	42.0#	432
18B	26" X 30"	0 53523 00118-4	Bundle/24	38.0#	432
19B	20" X 27"	0 53523 00119-1	Bundle/24	26.0#	432
21B	28" X 40"	0 53523 00121-4	Bundle/24	54.0#	432
23B	18" X 36"	0 53523 00123-8	Bundle/24	32.0#	432
24B	32" X 36"	0 53523 00124-5	Bundle/12	29.0#	216
30B	32" X 40"	0 53523 00130-6	Bundle/12	31.0#	216
32B	36" X 36"	0 53523 00132-0	Bundle/12	31.0#	216
33B	38" X 46"	0 53523 00133-7	Bundle/12	42.0#	216
35B	18" X 16"	0 53523 00135-1	Bundle/24	13.0#	864
39B	14" X 22"	0 53523 00139-9	Bundle/24	15.0#	864
40B	30" X 60"	0 53523 00140-5	Bundle/12	43.0#	216
41B	20" X 54"	0 53523 00141-2	Bundle/24	52.0#	432
44B	24" X 27"	0 53523 00144-3	Bundle/24	30.0#	432
45B	24" X 24"	0 53523 00145-0	Bundle/24	28.0#	864
46B	29" X 29"	0 53523 00146-7	Bundle/24	41.0#	432
47B	28" X 56"	0 53523 00147-4	Bundle/12	36.0#	216

Bulk Premier Cooler Pads

Number	Description	UPC Code	Pkg/Qty	Weight per BDL	Pallet Qty
48B	34" X 39"	0 53523 00148-1	Bundle/12	32.0#	216
49B	30" X 30"	0 53523 00149-8	Bundle/24	43.0#	432
50B	23" X 28"	0 53523 00150-4	Bundle/24	30.0#	432
51B	32" X 32"	0 53523 00151-1	Bundle/24	49.0#	432
52B	18" X 26"	0 53523 00152-8	Bundle/24	21.0#	864
53B	22" X 44"	0 53523 00153-5	Bundle/24	46.0#	432
54B	24" X 47"	0 53523 00154-2	Bundle/24	54.0#	432
55B	34" X 44"	0 53523 00155-9	Bundle/12	36.0#	216
56B	25" X 33"	0 53523 00156-6	Bundle/24	41.0#	432
58B	22" X 56"	0 53523 00158-0	Bundle/12	30.0#	216

Premier Cooler Rolls

Aspen Snow-Cool™ Cooler Rolls

Cut roll to desired length with a heavy pair of shears. Install same as cooler pads.



Number	Description	UPC Code	Pkg/Qty	Weight per Roll	Rolls per Pallet
20R	20" X 24'	0 53523 00320-1	Roll/1	12.0#	48
24R	24" X 24'	0 53523 00324-9	Roll/1	14.0#	48
28R	28" X 24'	0 53523 00328-7	Roll/1	17.0#	32
30R	30" X 24'	0 53523 00330-0	Roll/1	18.0#	32
36R	36" X 24'	0 53523 00336-2	Roll/1	22.0#	32

Tempo Rolls

Synthetic Cooler Rolls

Cut roll to desired length with a heavy pair of shears. Install same as cooler pads.



Number	Description	UPC Code	Pkg/Qty	Weight per Roll
TR29X144	29" X 144"	0 53523 01520-4	Roll/1	3.0#
TR33X160	33" X 160"	0 53523 01521-1	Roll/1	4.0#
TR36X240	36" X 240"	0 53523 01523-5	Roll/1	7.0#

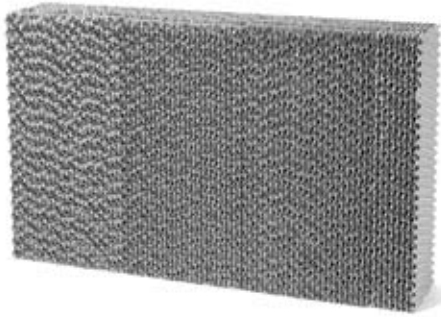

Single Inlet Evaporative Cooler Media

Our single inlet cooler media is engineered to provide optimal thermal performance and longevity. Produced from a cellulose base proven to be one of the most durable single-inlet evaporative cooling products on the market. (Corrugated angles are 45° X 15°)

2 piece construction for easy installation.

SPECIAL SIZES AVAILABLE UPON REQUEST

Single Inlet Evaporative Cooler Media

Number	Description	UPC Code	Pkg/Qty	Carton Weight
AR-1 / PR-1	8" Thick X 40" W X 23" H - Fits MasterCool® (prior to 2009) / AeroCool® 4800	0 53523 01901-1	Carton/1	8.0#
AC-1	8" Thick X 40" W X 28" H - Fits MasterCool® 6500 (prior to 2009)	0 53523 01902-8	Carton/1	10.0#
AR-2	12" Thick X 40" W X 23" H - Fits MasterCool® (prior to 2009)	0 53523 01914-1	Carton/1	12.0#
AC-2	12" Thick X 40" W X 28" H - Fits MasterCool® (prior to 2009)	0 53523 01915-8	Carton/1	15.0#
AI-1*	8" Thick X 48" W X 44.5" H - Fits Industrial MasterCool® (prior to 2009)	0 53523 01903-5	Carton/1	19.0#
AI-2*	12" Thick X 48" W X 44.5" H - Fits Industrial MasterCool® (prior to 2009)	0 53523 01904-2	Carton/1	26.0#
CR-5	8" Thick X 33" W X 17" H - Fits UltraCool® 3500	0 53523 01940-0	Carton/1	6.0#
CR-1	8" Thick X 41" W X 22.5" H - Fits UltraCool® 5000 / ComfortCool® / 2009 MasterCool® 5000	0 53523 01905-9	Carton/1	9.0#
CC-1	8" Thick X 41" W X 29" H - Fits UltraCool® 7000 / ComfortCool® / 2009 MasterCool® 7000	0 53523 01906-6	Carton/1	11.0#
CR-2	12" Thick X 41.25" W X 22.5" H - Fits UltraCool® / 2009 MasterCool® 5000-12	0 53523 01931-8	Carton/1	12.0#
CC-2	12" Thick X 41.25" W X 29" H - Fits UltraCool® / 2009 MasterCool® 7000-12	0 53523 01932-5	Carton/1	15.0#
CI-1	12" Thick X 44.75" W X 36.75" H - Fits Industrial UltraCool® / 2009 MasterCool®	0 53523 01941-7	Carton/1	21.0#
CI-2	12" Thick X 48" W X 46.75" H - Fits Industrial UltraCool® / 2009 MasterCool®	0 53523 01942-4	Carton/1	27.0#
PC-1	8" Thick X 40" W X 30" H - Fits AeroCool® 6800	0 53523 01908-0	Carton/1	10.0#
PC-2	12" Thick X 40" W X 30" H - Fits AeroCool® 6800-12	0 53523 01992-9	Carton/1	15.0#
BR-S	3.5" Thick X 31.5" W X 17" H - Fits Breeze Air	0 53523 01943-1	Carton/1	12.0#
BR-L	3.5" Thick X 31.5" W X 25" H - Fits Breeze Air	0 53523 01944-8	Carton/1	16.0#

*(2 pads per cooler)

MasterCool® and UltraCool® are registered trademarks of Champion Cooler Corp. / ComfortCool® is a registered trademark of Essick Air Products / AeroCool® is a registered trademark of Phoenix Manufacturing, Inc. PPS Packaging Company is not affiliated with Champion Cooler Corp; Essick Air Products; or Phoenix Manufacturing, Inc.

Aspen Snow-Cool™

MIGHTY COOL™ Cooler Pumps

- Larger Pump Motors
- Sealed Ball Bearing
- Resetable Thermal Overload Protection
- Flame Retardant Plastic
- Patented Design
4856971 & 5431548
- UL Classified



MIGHTY COOL™ Concentric Cooler Pumps



P-5G
For Coolers
2500 - 5500 CFM

P-7G
For Coolers
5500 - 7500 CFM

Powerful Concentric Style Motors

- All Metal Motor Housing
- Resetable Thermal Overload Protection
- Grounded Cord
- All Plastic Parts Are Flame Retardant
- 45° Elbow For Pump Hose
- UL Classified

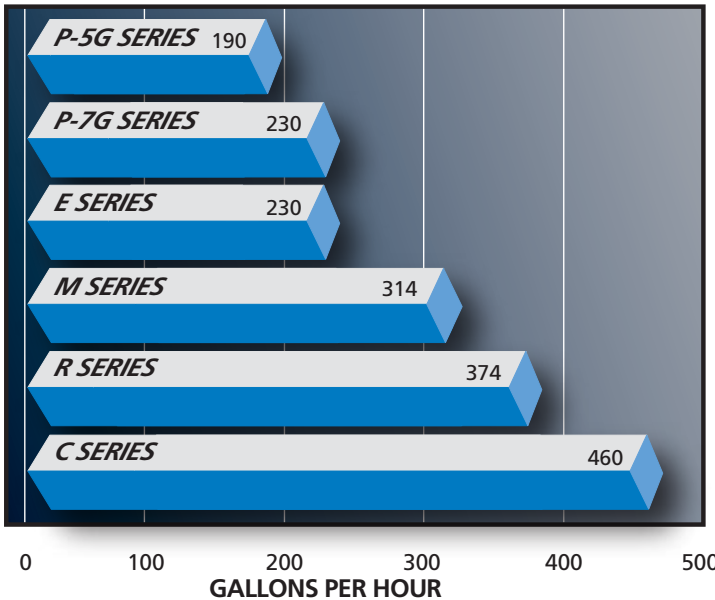

Pump Flow Rate Test

TESTED AT 32" HEAD HEIGHT*

**Testing was performed by PPS Packaging Company Engineering Department. Inquire for detailed test results.*

Mighty Cool™ Cooler Pumps - All Pumps are UL Classified

Number	Description	UPC Code	Pkg/Qty	Carton Weight	Pallet Qty
Promotional Cooler Pumps - UL Classified - 90 Day Warranty					
P-5G	Concentric Cooler Pump; 2,500 to 5,500 CFM; 120 V w/cord & plug	0 53523 01825-0	Carton/12	29.0#	288
P-7G	Concentric Cooler Pump; 5,500 to 7,500 CFM; 120 V w/cord & plug	0 53523 01830-4	Carton/12	30.0#	288
Mighty Cool™ Cooler Pumps - UL Classified - 2 Year Warranty					
E-5500	2,500 to 5,500 CFM, 120 V w/cord & plug	0 53523 01850-2	Carton/12	30.0#	288
M-7500	5,000 to 7,500 CFM, 120 V w/cord & plug	0 53523 01851-9	Carton/12	33.0#	288
R-10000	6,500 to 10,000 CFM, 120 V w/cord & plug	0 53523 01852-6	Carton/12	37.0#	288
Commercial & Single Inlet Cooler Pumps - UL Classified - 2 Year Warranty					
C-15000	15,000 to 21,000 CFM, 120 V w/cord & plug	0 53523 01853-3	Carton/12	41.0#	288
C-15000-2	15,000 to 21,000 CFM, 240 V w/cord & plug	0 53523 01854-0	Carton/12	41.0#	288



P-5G



P-7G



E-5500



M-7500



R-10000



C-15000 (120 V)
C-15000-2 (240 V)

Motors & Motor Kits



81514 81534 81554 81574
81524 81544 81564

Number	Description	UPC Code	Pkg/Qty	Carton Weight	Pallet Qty
81514	1/3-HP, 1-Speed – 120 Volt Cooler Motor	0 53523 81514-9	Box/1	15.0#	120
81524	1/3-HP, 2-Speed – 120 Volt Cooler Motor	0 53523 81524-8	Box/1	15.0#	120
81534	1/2-HP, 1-Speed – 120 Volt Cooler Motor	0 53523 81534-7	Box/1	15.0#	120
81544	1/2-HP, 2-Speed – 120 Volt Cooler Motor	0 53523 81544-6	Box/1	15.0#	120
81554	3/4-HP, 1-Speed – 120 Volt Cooler Motor	0 53523 81554-5	Box/1	15.0#	120
81564	3/4-HP, 2-Speed – 120 Volt Cooler Motor	0 53523 81564-4	Box/1	18.0#	120
81574	1-HP, 2-Speed – 120 Volt Cooler Motor	0 53523 81574-3	Box/1	20.0#	75

Cooler Motor Kits - Assembled



81614 81634
81624 81674

Number	Description	UPC Code	Pkg/Qty	Carton Weight
81614	1/3-HP, 2-Speed – 120 Volt Cooler Motor with 36" Motor Cord (Conventional Plug) attached, also includes Motor Clamps & 3-1/4" X 1/2" Variable Pulley	0 53523 81614-6	Box/1	16#
81624	1/2-HP, 2-Speed – 120 Volt Cooler Motor with 36" Motor Cord (Conventional Plug) attached, also includes Motor Clamps & 3-3/4" X 1/2" Variable Pulley	0 53523 81624-5	Box/1	18#
81634	3/4-HP, 2-Speed – 120 Volt Cooler Motor with 36" Motor Cord (Conventional Plug) attached, also includes Motor Clamps & 3-3/4" X 1/2" Variable Pulley	0 53523 81634-4	Box/1	19.5#
81674	1-HP, 2-Speed – 120 Volt Cooler Motor with 36" Motor Cord (Conventional Plug) attached, also includes Motor Clamps & 4.15" X 5/8" Variable Pulley	0 53523 81674-0	Box/1	30.5#

Cooler Motor Kits - Assembled For Single Inlet Coolers

Number	Description	UPC Code	Pkg/Qty	Carton Weight
81644	1/2-HP, 2-Speed – 120 Volt Cooler Motor with 36" Motor Cord (Mini Plug) attached, also includes 3-3/4" X 1/2" Variable Pulley & Motor Clamps	0 53523 81644-3	Box/1	18#
81654	3/4-HP, 2-Speed – 120 Volt Cooler Motor with 36" Motor Cord (Mini Plug) attached, also includes 3-3/4" X 1/2" Variable Pulley & Motor Clamps	0 53523 81654-2	Box /1	19#
81664	1-HP, 2-Speed – 120 Volt Cooler Motor with 36" Motor Cord (Mini Plug) attached, also includes Motor Clamps & 4.15" X 5/8" Variable Pulley	0 53523 81664-1	Box/1	29#

- 100% Copper Wound Motors
- Sealed Ball Bearings (No Additional Oiling is Required)
- Automatic Reset Thermal Overload Protection
- UL Recognized

Installation Kits For Motors (Motor Sold Separately)



81642
81632

Number	Description	UPC Code	Pkg/Qty	Carton Weight
81642	Motor installation kit for 1/3 HP Motor <i>Kit includes: 3-1/4" X 1/2" variable pulley, 36" motor cord, motor clamps</i>	0 53523 81642-9	Bag/10	13.5#
81632	Motor installation kit for 1/2 & 3/4 HP Motor <i>Kit includes: 3-3/4" X 1/2" variable pulley, 36" motor cord, motor clamps</i>	0 53523 81632-0	Bag/10	17.5#

Aspen Snow-Cool™ Accessories

Water Control Accessories

The most vital element of your evaporative cooler is water, and these water control products are designed to maximize its cooling power. With accessories ranging from tubing to floats, these products are made of durable, high quality materials and feature the Aspen Snow-Cool™ quality guarantee.

Water Supply Accessories

Designed to ensure a steady, adequate supply of water to your cooler, Aspen Snow-Cool™ water supply products are as reliable as they are convenient. These accessories make it easier than ever to keep you cool all season long!

Water Distribution Accessories

Aspen Snow-Cool™ water distribution products keep your cooler operating smoothly and efficiently. Distribution heads, tube restraints, and additional accessories are sure to provide you with the dependable operation you deserve.

Water Distribution Kits

Delivering maximum quality and convenience, these Aspen Snow-Cool™ kits make cooler repair a snap. Choose from the Water Distribution Kit, Pump Installation Kit, Bleed-Off Kit, and Water Hookup Kit...and fix your cooler with no sweat!

Power Supply Accessories

Improving your cooler's power supply no longer has to be a headache. Included in this Aspen Snow-Cool™ family of accessories are such essentials as pulleys, motors, and everything in between, ready for fast and easy installation.



Water Control Accessories

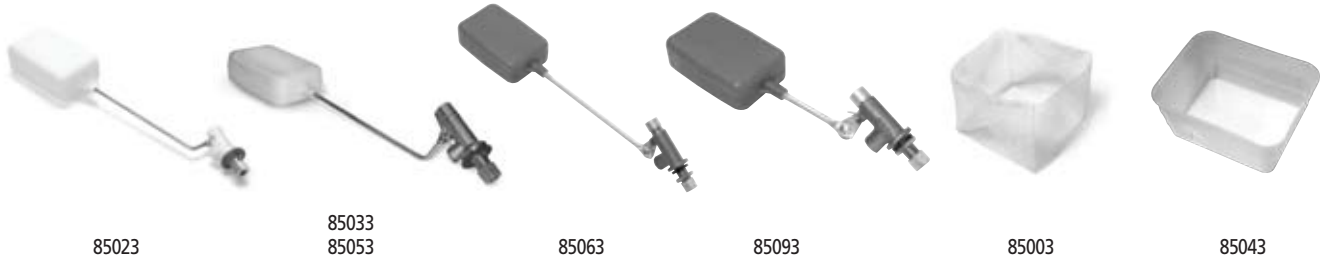

Number	Description	UPC Code	Pkg/Qty	Carton Weight
85023	Float Valve – Brass & Poly, 1/4"	0 53523 85023-2	Label/10	1.5#
85033	Float Valve – Brass, 1/4"	0 53523 85033-1	Label/10	2.5#
85053	Float Valve – Brass, 3/8"	0 53523 85053-9	Label/10	2.8#
85063	Float Valve – Brass, 1/4" w/ adjust. arm	0 53523 85063-8	Label/10	2.5#
85093	Float Valve – Brass, 1/4" w/ adjust. short arm	0 53523 85093-5	Label/10	2.3#
85003	Pump Screen Poly – Mesh	0 53523 85003-4	Label/10	0.5#
85043	Molded Poly Pump Basket	0 53523 85043-0	Label/10	1.0#
82082	Poly Cooler Drain with Overflow Pipe	0 53523 82082-2	Clamshell/10	1.0#
82172	Nylon Cooler Drain with Overflow Pipe	0 53523 82172-0	Clamshell/10	1.5#
82212	Brass Cooler Drain with Overflow Pipe	0 53523 82212-3	Clamshell/10	3.0#
82091	Nylon Cooler Drain	0 53523 82091-4	Bulk/25	0.5#
82092	Nylon Cooler Drain	0 53523 82092-1	Clamshell/10	0.2#
82101	Brass Cooler Drain	0 53523 82101-0	Bulk/25	2.6#
82102	Brass Cooler Drain	0 53523 82102-7	Clamshell/10	1.2#
82181	Cooler Drain Washer – Rubber	0 53523 82181-2	Bulk/25	0.1#



Water Control Accessories



82231
82232



82281
82282



82112



83033 83023
83183 83013



83173 83043
83153 83053

Number	Description	UPC Code	Pkg/Qty	Carton Weight
82231	Overflow Pipe Non-threaded	0 53523 82231-4	Bulk/25	0.75#
82232	Overflow Pipe Non-threaded	0 53523 82232-1	Clamshell/10	0.3#
82281	Overflow Pipe Threaded	0 53523 82281-9	Bulk/25	0.75#
82282	Overflow Pipe Threaded	0 53523 82282-6	Clamshell/10	0.3#
82112	Ring Clamps for 1/2" Pump Hose – 2 Per Pkg	0 53523 82112-6	Clamshell/10	0.5#
83183	Poly Tubing 1/4" X 25' Black Color	0 53523 83183-5	Label/20	7.5#
83173	Poly Tubing 1/4" X 25' Natural Color	0 53523 83173-6	Label/20	7.5#
83023	Poly Tubing 1/4" X 50' Black Color	0 53523 83023-4	Label/20	14.0#
83153	Poly Tubing 1/4" X 50' Natural Color	0 53523 83153-8	Label/20	14.0#
83133	Poly Tubing 1/4" X 50' Copper Color	0 53523 83133-0	Label/10	7.5#
83033	Poly Tubing 1/4" X 100' Black Color	0 53523 83033-3	Label/20	28.0#
83043	Poly Tubing 1/4" X 100' Natural Color	0 53523 83043-2	Label/20	28.0#
83143	Poly Tubing 1/4" X 100' Copper Color	0 53523 83143-9	Label/10	14.0#
83013	Poly Tubing 1/4" X 1000' Black Color	0 53523 83013-5	Label/1	12.0#
83053	Poly Tubing 1/4" X 1000' Natural Color	0 53523 83053-1	Label/1	12.0#
83113	Copper Tubing 1/4" X 25'	0 53523 83113-2	Label/10	14.5#
83123	Copper Tubing 1/4" X 50'	0 53523 83123-1	Label/5	14.5#
83063	Vinyl Pump Tubing 1/2" X 5'	0 53523 83063-0	Label/10	3.5#



83133
83143



83113
83123



83063

Water Supply Accessories

All packaged compression fittings come with plastic tube adapters for use with either copper tubing or poly tubing. (Note: Plastic tube adapters are NOT included in bulk packaging of compression fittings.)



86061
86062

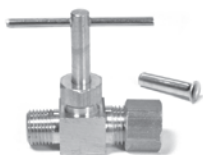

86081
86082

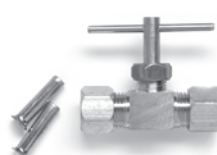

86121
86122



86011
86012

Number	Description	UPC Code	Pkg/Qty	Carton Weight
86061	Angle Needle Valve 1/4" X 1/8" MPT	0 53523 86061-3	Bulk/50	10.0#
86062	Angle Needle Valve 1/4" X 1/8" MPT	0 53523 86062-0	Clamshell/10	2.0#
86081	Straight Needle Valve 1/4" X 1/8" MPT	0 53523 86081-1	Bulk/50	10.0#
86082	Straight Needle Valve 1/4" X 1/8" MPT	0 53523 86082-8	Clamshell/10	1.9#
86121	Compression Needle Valve 1/4" (In Line)	0 53523 86121-4	Bulk/50	6.0#
86122	Compression Needle Valve 1/4" (In Line)	0 53523 86122-1	Clamshell/10	1.1#
86011	Compression Nuts 1/4"	0 53523 86011-8	Bulk/50	0.7#
86012	Compression Nuts 1/4" – 4 Per Pkg	0 53523 86012-5	Clamshell/10	0.7#
86001	Compression Sleeve 1/4"	0 53523 86001-9	Bulk/50	0.1#
86002	Compression Sleeve 1/4" – 5 Per Pkg	0 53523 86002-6	Clamshell/10	0.1#
86091	Compression Tee 1/4"	0 53523 86091-0	Bulk/50	5.0#
86092	Compression Tee 1/4"	0 53523 86092-7	Clamshell/10	1.0#
86021	Compression Union 1/4"	0 53523 86021-7	Bulk/50	5.0#
86022	Compression Union 1/4"	0 53523 86022-4	Clamshell/10	0.9#
86003	Compression Nut & Sleeve 1/4" – 2 Per Pkg	0 53523 86003-3	Clamshell/10	0.4#



86001
86002

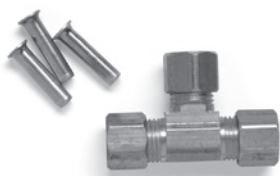

86091
86092

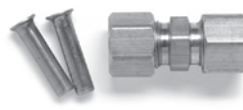

86021
86022



86003

Water Supply Accessories



86031
86032



86251
86252



86351
86352



86041
86042



86071
86072



86232

Number	Description	UPC Code	Pkg/Qty	Carton Weight
86031	Male Coupling 1/4" X 1/8" MPT For Copper Or Plastic Tube	0 53523 86031-6	Bulk/50	3.0#
86032	Male Coupling 1/4" X 1/8" MPT For Copper Or Plastic Tube	0 53523 86032-3	Clamshell/10	0.5#
86251	Poly Tube Barbed Adapter 1/4"	0 53523 86251-8	Bulk/50	0.7#
86252	Poly Tube Barbed Adapter 1/4" – 2 Per Pkg	0 53523 86252-5	Clamshell/10	0.3#
86351	1/4" Poly Tube Insert	0 53523 86351-5	Bulk/50	1.0#
86352	1/4" Poly Tube Insert – 4 Per Pkg	0 53523 86352-2	Clamshell/10	1.0#
86041	Plastic Tube Adapter 1/4"	0 53523 86041-5	Bulk/50	0.7#
86042	Plastic Tube Adapter 1/4" – 4 Per Pkg	0 53523 86042-2	Clamshell/10	0.7#
86071	Brass Sill Cock (Garden Hose Thread)	0 53523 86071-2	Bulk/25	12.0#
86072	Brass Sill Cock (Garden Hose Thread)	0 53523 86072-9	Clamshell/10	4.8#
86232	Brass Sill Cock (3/4" Pipe Thread)	0 53523 86232-7	Clamshell/10	4.8#
86211	Pipe Adapter 1/2" MPT X 1/2" FPT w/ 1/8" FPT Side Tap	0 53523 86211-2	Bulk/25	6.0#
86212	Pipe Adapter 1/2" MPT X 1/2" FPT w/ 1/8" FPT Side Tap	0 53523 86212-9	Clamshell/10	2.4#
86221	Pipe Adapter 3/4" MPT X 3/4" FPT w/ 1/8" FPT Side Tap	0 53523 86221-1	Bulk/25	6.0#
86222	Pipe Adapter 3/4" MPT X 3/4" FPT w/ 1/8" FPT Side Tap	0 53523 86222-8	Clamshell/10	2.5#
86051	Self Tapping Saddle Valve 1/4"	0 53523 86051-4	Bulk/25	6.0#
86052	Self Tapping Saddle Valve 1/4"	0 53523 86052-1	Clamshell/10	2.5#
86262	1/4" X 1/4" Speedfit Tee	0 53523 86262-4	Clamshell/10	1.0#
86272	1/4" Speedfit Union	0 53523 86272-3	Clamshell/10	1.0#
86282	1/4" X 1/8" MPT Speedfit Male Coupling	0 53523 86282-2	Clamshell/10	1.0#



86211
86212



86221
86222



86051
86052



86262



86272



86282

Water Distribution Accessories



Number	Description	UPC Code	Pkg/Qty	Carton Weight
82011	Water Distribution Adapter	0 53523 82011-2	Bulk/25	1.0#
82012	Water Distribution Adapter	0 53523 82012-9	Clamshell/10	0.2#
82021	Distribution Tubes – 20"	0 53523 82021-1	Bulk/50	2.0#
82022	Distribution Tubes – 20" – 4 Per Pkg	0 53523 82022-8	Bag/10	1.8#
81992	Distribution Tube Cleaner	0 53523 81992-5	Clamshell/10	3.2#
81592	MEK	0 53523 81592-7	Clamshell/10	1.2#
82031	Distribution Head Plugs	0 53523 82031-0	Bulk/25	0.25#
82041	Distribution Heads, 3-Way Side	0 53523 82041-9	Bulk/25	1.2#
82042	Distribution Heads, 3-Way Side	0 53523 82042-6	Clamshell/10	0.5#
82061	Distribution Heads, 4-Way Down	0 53523 82061-7	Bulk/25	1.2#
82062	Distribution Heads, 4-Way Down	0 53523 82062-4	Clamshell/10	0.5#
82051	Distribution Heads, 6-Way Side	0 53523 82051-8	Bulk/25	1.2#
82052	Distribution Heads, 6-Way Side	0 53523 82052-5	Clamshell/10	0.5#
82071	Distribution Heads, 8-Way Down	0 53523 82071-6	Bulk/25	1.2#
82072	Distribution Heads, 8-Way Down	0 53523 82072-3	Clamshell/10	0.5#
82191	Bleed-Off Tee 1/2" X 2"	0 53523 82191-1	Bulk/25	1.0#
82192	Bleed-Off Tee 1/2" X 2"	0 53523 82192-8	Clamshell/10	2.0#
82242	Distribution Tube Flow Equalizer – 4 Per Pkg	0 53523 82242-0	Clamshell/10	0.2#
82252	Water Restrictor Clamp	0 53523 82252-9	Clamshell/10	0.5#
82262	Distributor Tube Clamp Tradewinds – 4 Per Pkg	0 53523 82262-8	Clamshell/10	0.5#
83101	Tube Retainer Clip	0 53523 83101-9	Bulk/50	0.5#
83102	Tube Retainer Clip – 4 Per Pkg	0 53523 83102-6	Clamshell/10	0.4#

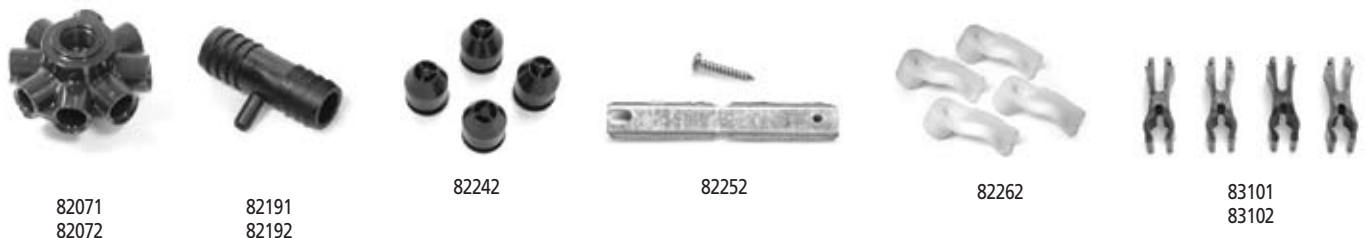

Cooler Kits



82002



83072



83162



83082



83092

Number	Description	UPC Code	Pkg/Qty	Carton Weight
82002	Distribution Head Kit <i>Kit Includes: 8-way head, 5 head plugs, water distribution adapter, and MEK.</i>	0 53523 82002-0	Clamshell/10	1.6#
83072	Water Hook-Up Kit With Poly Tubing <i>Kit Includes: Brass sill cock, 1/4" poly tubing, 1/4" x 1/8" angle valve.</i>	0 53523 83072-2	Bag/10	10.0#
83162	Water Hook-Up Kit With Copper Tubing <i>Kit Includes: Brass sill cock, 1/4" copper tubing, 1/4" x 1/8" angle valve.</i>	0 53523 83162-0	Bag/10	19.0#
83082	Bleed-Off Kit <i>Kit Includes: 1/4" poly tubing, bleed-off tee, hose clamps and a water restrictor clamp.</i>	0 53523 83082-1	Bag/10	4.1#
83092	Pump Installation Kit – Standard <i>Kit Includes: Pump screen, water distribution adapter, 1/2" x 5' pump hose, 1/2" ring clamps, poly drain & overflow pipe, 1/4" float valve, and water restrictor clamp.</i>	0 53523 83092-0	Bag/10	6.0#
82202	Water Distribution Kit – Universal Fits All <i>Kit Includes: 8-way head, 8 tubes, 5 plugs, water distribution adapter, MEK.</i>	0 53523 82202-4	Bag/10	6.0#
82122	Water Distribution Kit – 3-way Side <i>Kit Includes: 3-way head, 3 tubes, water distribution adapter, MEK.</i>	0 53523 82122-5	Bag/10	5.0#
82132	Water Distribution Kit – 4-way Down <i>Kit Includes: 4-way head, 4 tubes, water distribution adapter, MEK.</i>	0 53523 82132-4	Bag/10	5.0#
82142	Water Distribution Kit – 6-way Side <i>Kit Includes: 6-way head, 6 tubes, water distribution adapter, MEK.</i>	0 53523 82142-3	Bag/10	5.4#
82152	Water Distribution Kit – 8-way Down <i>Kit Includes: 8-way head, 8 tubes, water distribution adapter, MEK.</i>	0 53523 82152-2	Bag/10	6.0#
82162	Water Distribution Kit – 6-way Down <i>Kit Includes: 8-way head, 6 tubes, 2 plugs, water distribution adapter, MEK.</i>	0 53523 82162-1	Bag/10	5.4#

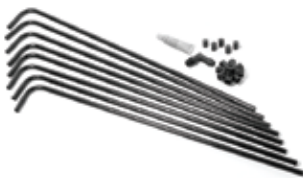

82202



82122



82132



82142



82152



82162

Power Supply Accessories

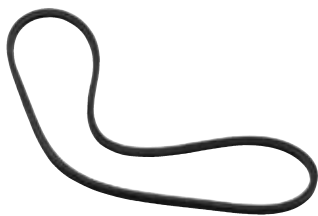

Number	Description	UPC Code	Pkg/Qty	Carton Weight
88273	30" V-Belt	0 53523 88273-8	Label/5	2.0#
88283	40" V-Belt	0 53523 88283-7	Label/5	2.0#
88003	44" V-Belt	0 53523 88003-1	Label/5	2.2#
88013	45" V-Belt	0 53523 88013-0	Label/5	2.2#
88023	46" V-Belt	0 53523 88023-9	Label/5	2.2#
88033	47" V-Belt	0 53523 88033-8	Label/5	2.2#
88043	48" V-Belt	0 53523 88043-7	Label/5	2.3#
88063	50" V-Belt	0 53523 88063-5	Label/5	2.3#
88083	52" V-Belt	0 53523 88083-3	Label/5	2.3#
88093	53" V-Belt	0 53523 88093-2	Label/5	2.4#
88103	54" V-Belt	0 53523 88103-8	Label/5	2.4#
88113	55" V-Belt	0 53523 88113-7	Label/5	2.4#
88123	56" V-Belt	0 53523 88123-6	Label/5	2.5#
88133	57" V-Belt	0 53523 88133-5	Label/5	2.6#
88143	58" V-Belt	0 53523 88143-4	Label/5	2.6#
88153	59" V-Belt	0 53523 88153-3	Label/5	2.6#
88163	60" V-Belt	0 53523 88163-2	Label/5	2.7#
88173	61" V-Belt	0 53523 88173-1	Label/5	2.7#
88183	62" V-Belt	0 53523 88183-0	Label/5	2.8#
88193	63" V-Belt	0 53523 88193-9	Label/5	2.8#
88203	65" V-Belt	0 53523 88203-5	Label/5	2.9#
88213	66" V-Belt	0 53523 88213-4	Label/5	2.9#
88223	67" V-Belt	0 53523 88223-3	Label/5	3.0#
88243	68" V-Belt	0 53523 88243-1	Label/5	3.0#
88253	69" V-Belt	0 53523 88253-0	Label/5	3.2#

Power Supply Accessories



87201 87251 87211
87202 87252 87212

87281 87313 87303
87282 87323

87333 87293
87243

87171 87401 87181
87172 87402 87182

87411 87421
87412 87422

Number	Description	UPC Code	Pkg/Qty	Carton Weight
87251	Fixed Motor Pulley (2-1/4" X 1/2") Zinc	0 53523 87251-7	Bulk/25	10.0#
87252	Fixed Motor Pulley (2-1/4" X 1/2") Zinc	0 53523 87252-4	Clamshell/5	2.6#
87201	Fixed Motor Pulley (2-3/4" X 1/2") Zinc	0 53523 87201-2	Bulk/25	16.0#
87202	Fixed Motor Pulley (2-3/4" X 1/2") Zinc	0 53523 87202-9	Clamshell/5	3.0#
87211	Fixed Motor Pulley (3" X 1/2") Zinc	0 53523 87211-1	Bulk/25	16.0#
87212	Fixed Motor Pulley (3" X 1/2") Zinc	0 53523 87212-8	Clamshell/5	3.3#
87281	Fixed Motor Pulley (3-1/2" X 1/2") Zinc	0 53523 87281-4	Bulk/25	21.0#
87282	Fixed Motor Pulley (3-1/2" X 1/2") Zinc	0 53523 87282-1	Clamshell/5	4.0#
87303	Variable Motor Pulley (3-1/4" X 1/2") Zinc	0 53523 87303-3	Clamshell/5	5.0#
87323	Variable Motor Pulley (3-1/2" X 1/2") Zinc	0 53523 87323-1	Clamshell/5	6.0#
87313	Variable Motor Pulley (3-3/4" X 1/2") Zinc	0 53523 87313-2	Clamshell/5	6.5#
87333	Variable Motor Pulley (3-1/4" X 1/2") Cast Iron	0 53523 87333-0	Clamshell/5	6.3#
87243	Variable Motor Pulley (3-3/4" X 1/2") Cast Iron	0 53523 87243-2	Clamshell/5	7.8#
87293	Variable Motor Pulley (4.15" X 5/8") Cast Iron	0 53523 87293-7	Clamshell/5	9.1#
87401	Pillow Block Bearing 5/8"	0 53523 87401-6	Bulk/25	7.5#
87402	Pillow Block Bearing 5/8"	0 53523 87402-3	Clamshell/5	1.5#
87181	Pillow Block Bearing 3/4"	0 53523 87181-7	Bulk/25	10.0#
87182	Pillow Block Bearing 3/4"	0 53523 87182-4	Clamshell/5	2.0#
87171	Pillow Block Bearing 1"	0 53523 87171-8	Bulk/25	10.0#
87172	Pillow Block Bearing 1"	0 53523 87172-5	Clamshell/5	2.0#
87411	Pillow Block Bearing – High Rise 3/4"	0 53523 87411-5	Bulk/25	11.0#
87412	Pillow Block Bearing – High Rise 3/4"	0 53523 87412-2	Clamshell/5	2.2#
87421	Pillow Block Bearing – High Rise 1"	0 53523 87421-4	Bulk/25	11.0#
87422	Pillow Block Bearing – High Rise 1"	0 53523 87422-1	Clamshell/5	2.2#



87133
87143



87452
87462



87153
87163

Number	Description	UPC Code	Pkg/Qty	Carton Weight
87133	Spider Bearing 3/4"	0 53523 87133-6	Label/1	1.0#
87143	Spider Bearing 1"	0 53523 87143-5	Label/1	1.0#
87462	Ball and Cushion 3/4"	0 53523 87462-7	Clamshell/10	2.5#
87452	Ball and Cushion 1"	0 53523 87452-8	Clamshell/10	2.5#
87153	Cooler Shaft – Hollow 3/4" X 24"	0 53523 87153-4	Label/1	1.0#
87163	Cooler Shaft – Hollow 1" X 24"	0 53523 87163-3	Label/1	1.1#
87011	Collar and Leather Gasket 3/4"	0 53523 87011-7	Bulk/25	2.5#
87012	Collar and Leather Gasket 3/4"	0 53523 87012-4	Clamshell/10	1.2#
87021	Collar and Leather Gasket 1"	0 53523 87021-6	Bulk/25	2.5#
87022	Collar and Leather Gasket 1"	0 53523 87022-3	Clamshell/10	1.2#
87392	Leather Gasket 3/4" – 2 Per Pkg	0 53523 87392-7	Clamshell/10	0.1#
87382	Leather Gasket 1" – 2 Per Pkg	0 53523 87382-8	Clamshell/10	0.1#
87513	7" X 5/8" Blower Pulley Zinc	0 53523 87513-6	Label/1	1.0#
87503	7" X 3/4" Blower Pulley Zinc	0 53523 87503-7	Label/1	1.1#
87533	9" X 3/4" Blower Pulley Zinc	0 53523 87533-4	Label/1	1.3#
87073	10" X 3/4" Blower Pulley Zinc	0 53523 87073-5	Label/1	1.8#
87083	11" X 3/4" Blower Pulley Zinc	0 53523 87083-4	Label/1	2.0#
87093	12" X 3/4" Blower Pulley Zinc	0 53523 87093-3	Label/1	2.3#
87193	14" X 3/4" Blower Pulley Zinc	0 53523 87193-0	Label/1	3.0#
87103	10" X 1" Blower Pulley Zinc	0 53523 87103-9	Label/1	1.8#
87113	11" X 1" Blower Pulley Zinc	0 53523 87113-8	Label/1	2.0#
87123	12" X 1" Blower Pulley Zinc	0 53523 87123-7	Label/1	2.5#
87223	14" X 1" Blower Pulley Zinc	0 53523 87223-4	Label/1	3.3#



87021 87011
87022 87012



87392
87382



87503 87103 87073 87093 87123 87513
87533 87113 87083 87193 87223

Aspen Snow-Cool™

MIGHTY COOL™

Digital Thermostat



Digital Thermostat 120V / 240V

- For use with any brand or type of cooler
- Supports both 120V / 240V up to 1HP
- Saves Water & Electricity
- Easy to install and use
- Automatically cools to set temperature
- Automatically switches between motor speeds for efficiency and comfort
- Operates only when needed - 12 hour delay "ON" and "OFF" setting
- Easy to see - Large back lighted digital display
- UL Recognized



Electrical Accessories



81122
81122S



81272
81272S



81282



81002

Number	Description	UPC Code	Pkg/Qty	Carton Weight
81122	2-Speed, 6-Position Wall Switch, 1 Gang Plastic, Screw Type <i>120 V, 13.8 Amps, up to 3/4 HP.</i>	0 53523 81122-6	Bag/10	2.5#
81122S	2-Speed, 6-Position Wall Switch, 1 Gang Plastic, Screw Type – Spanish <i>120 V, 13.8 Amps, up to 3/4 HP.</i>	0 53523 81222-3	Bag/10	2.5#
81272	2-Speed, 6-Position Wall Switch, 1 Gang Metal, Screw Type <i>120 V, 13.8 Amps, up to 3/4 HP.</i>	0 53523 81272-8	Bag/10	2.5#
81272S	2-Speed, 6-Position Wall Switch, 1 Gang Metal, Screw Type – Spanish <i>120 V, 13.8 Amps, up to 3/4 HP.</i>	0 53523 81777-8	Bag/10	2.5#
81282	2-Speed, 6-Position Wall Switch, 2 Gang Metal, Screw Type <i>120 V, 13.8 Amps, up to 3/4 HP.</i>	0 53523 81282-7	Bag/10	2.5#
81002	2-Speed, 6-Position Switch Only, Long Shaft, QC <i>1/2 HP, 120-240 V, 15 Amps @ 120 V, 7.5 Amps @ 240 V.</i>	0 53523 81052-6	Bag/5	1.5#
81052	2-Speed, 6-Position Wall Switch Only, Short Shaft, Screw Type <i>120 V, 13.8 Amps, up to 3/4 HP.</i>	0 53523 81002-1	Bag/5	1.5#
81042	Wall Switch Knob	0 53523 81042-7	Clamshell/10	0.5#
81062	Knob 6 Position – Short Shaft	0 53523 81062-5	Clamshell/10	0.5#
81072	Knob 6 Position – Long Shaft	0 53523 81072-4	Clamshell/10	0.5#
88425	Digital Thermostat <i>120-240 V, 20 Amps, 1/3 HP To 1 HP.</i>	0 53523 88425-1	Clamshell/5	3.5#



81052



81042



81062



81072



88425

Electrical Accessories



81562



81202



81102



81082



81092



81112

Number	Description	UPC Code	Pkg/Qty	Carton Weight
81562	Pigtail Pump Receptacle 10" <i>120 V, 15-amp receptacle for pump. 18 gauge, 10" lead wires.</i>	0 53523 81562-0	Clamshell/10	3.0#
81202	Cooler Pump Receptacle, 240 V <i>240 V, 15- amp receptacle for pump. 18-gauge, 10" lead wires.</i>	0 53523 81202-5	Clamshell/10	1.6#
81102	10" Pigtail Motor Receptacle <i>120 V/240 V, 15-amp receptacle for up to 1-HP motor. 14-gauge, 10" lead wires.</i>	0 53523 81102-8	Clamshell/10	3.0#
81082	36" Motor Plug, 1-Speed <i>120 V, 14-gauge/4-wire, 36" long cord, up to 1-HP.</i>	0 53523 81082-3	Clamshell/10	4.4#
81092	36" Motor Plug, 2-Speed <i>120 V, 14-gauge/4-wire, 36" long cord up to 1-HP.</i>	0 53523 81092-2	Clamshell/10	4.5#
81112	36" Mini Motor Plug, 2-Speed <i>120 V, Fits MasterCool models prior to 2009</i>	0 53523 81112-7	Clamshell/10	4.7#
81132	84" 2-Speed, 3/4-HP Angled Plug Motor Cord <i>14-gauge/4-wire hook-up for up to 3/4-HP, 2-speed motor. 84" cord.</i>	0 53523 81132-5	Bag/10	3.0#
81603	Cooler Motor Base <i>Standard motor base for 1/3, 1/2 or 3/4-HP drive motors.</i>	0 53523 81603-0	Label/1	1.0#
81142	10' Cooler Whip – 120 Volt <i>Pre-wired electrical hook-up for coolers; 14-gauge/3-wire for motor, 15-amp, up to 1-HP; 16-gauge/2-wire for pump.</i>	0 53523 81142-4	Bag/10	26.0#
81571	Motor Clamps – 2 Clamps Per Set	0 53523 81571-2	Bulk/25 Sets	2.5#
81572	Motor Clamps – 2 Clamps Per Pkg	0 53523 81572-9	Bag/10	1.0#
81233	14/5 Electric Wire S.J.T. (14-Gauge/5-Strand) <i>14-gauge electrical hook-up cable for pump and motor.</i>	0 53523 81233-9	Spool/250'	30.4#



81132



81603



81142



81571
81572



81233



87032



87372



87362



87343

Number	Description	UPC Code	Pkg/Qty	Carton Weight
87032	Pad Frame Latch – 2 Per Pkg	0 53523 87032-2	Clamshell/10	0.4#
87372	Pad Frame Latch For Tradewinds – 4 Per Pkg	0 53523 87372-9	Clamshell/10	0.5#
87362	Wire Pad Frame Latch For Tradewinds – 4 Per Pkg	0 53523 87362-0	Clamshell/10	0.9#
87343	Pulley Puller	0 53523 87343-9	Label/5	6.2#
87052	Cooler Leg Kit, Square Corner	0 53523 87052-0	Bag/6	37.0#
87042	Cooler Leg Kit, Round Corner	0 53523 87042-1	Bag/6	37.0#
81703	6-Way Grill Diffuser <i>Ceiling mount grill. Will fit 4,500 to 6,500 CFM coolers. Made of durable plastic. Will not rust. Fits 13", 16", 18" or 20" duct. NOTE: This grill has a punch-out for rotary switch.</i>	0 53523 81703-7	Label/1	4.0#

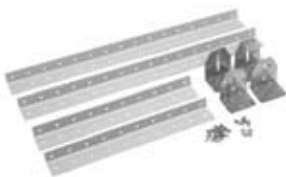

87052
87042



81703

The Original Line of Cooler Care Products

303 Cooler Guard

Evaporative Cooler Water Treatment

- Stops cooler odors
- Materially reduces the amount of calcium, mineral, and rust deposits which normally form during cooler operation.
- Improves cooler efficiency by keeping your pads cleaner and by insuring maximum water absorption by all pad fibers.

300 Submarine Sealer

- Stops rust and corrosion
- Repairs leaks
- Easy to apply with brush, roller or cloth
- Adheres to nearly any surface
- Follow label directions for proper use
- Water Based

Cooler Care Products



308-0



300-0



300-1
300-5



303-PT

Number	Description	UPC Code	Pkg/Qty	Carton Weight	Pallet Qty
308-0	Submarine Sealer (14-Oz. Aerosol)	0 08388 30800-8	Case/12	15.0#	960
300-0	Submarine Sealer (1-Quart)	0 08388 30004-0	Case/12	30.0#	672
300-1	Submarine Sealer (1-Gallon)	0 08388 30010-1	Case/6	60.0#	210
300-5	Submarine Sealer (5-Gallon)	0 08388 30050-7	Case/1	55.0#	36
303-PT	Cooler Guard (1-Pint)	0 08388 30305-8	Case/12	14.0#	1200
303-0	Cooler Guard (1-Quart)	0 08388 30304-1	Case/12	26.0#	576
303-1	Cooler Guard (1-Gallon)	0 08388 30310-2	Case/4	32.0#	192
305	Snow Fresh Cake <i>A water treating compound designed to reduce ALGAE build-up in the water pan, as well as lime and alkali build-up in the cooler and pads. Helps keep the air fresh.</i>	0 08388 30500-7	Case/12	2.5#	
81563	Anode Kit <i>Sacrificial metal rod that controls rust, corrosion, and mineral build-up in cooler cabinet.</i>	0 53523 81563-7	Case/10	2.8#	



303-0



303-1



305



81563



81583

88533 88553
88543

Number	Description	UPC Code	Pkg/Qty	Carton Weight
81583	Zoom Spout Cooler Oil	0 53523 81583-5	Case/24	4.0#
88533	Paint, Aerosol - Tan (12.5-Oz. Can)	0 53523 88533-3	Case/12	12.6#
88543	Paint, Aerosol - Grey (12.5-Oz. Can)	0 53523 88543-2	Case/12	12.6#
88553	Paint, Aerosol - Aluminum (12.5-Oz. Can)	0 53523 88553-1	Case/12	12.6#

Winterizing Your Evaporative Cooler

Maintenance at the end of the season will help prolong the life of your cooler. Here are some steps you can take to prepare your cooler for the upcoming winter season.

- Disconnect all electrical power.
- Shut off water and drain cooler. Make sure you also drain water out of all water supply lines.
- Scrape and/or wire brush metal cabinet and pad racks. Touch up the paint on all exposed (unprotected) metal areas. (Do not paint plastic coolers.)
- Check and oil blower bearings.
- Check blower pulley and replace if bent or deformed.
- Check motor pulley and replace if bent or deformed.
- If applicable, oil motor bearings.
- Remove belt and store in cool, dry place.
- If applicable, slide damper in vertical duct.
- Install new Aspen Snow-Cool™ Premier cooler pads into pad racks.
- Install cooler cover.

Following these steps will make your “start-up” faster and easier next spring.

Make sure you use “Aspen Snow-Cool™” products for all of your evaporative cooler maintenance needs.

Aspen Snow-Cool™

PRECISION FIT

Canvas Cooler Covers

Heavy Weight Canvas Cooler Covers For All Residential & Industrial Coolers

- Covers are treated to be water repellant
- Protects your cooler from winter weather elements
- Reduces heat loss
- Prevents cold air from blowing in
- Easy to install...Easy to remove
- A size for every cooler
- Lasts for years with proper care
- Made in the U.S.A.

Loop & Lock™ Closure System

All Down Discharge Covers will have a split corner and feature our "Loop and Lock" fasteners to provide maximum protection and perfect fit.



Canvas Turbine Ventilator Covers

For turbine ventilators 10" to 14" throat diameter, and up to 19" overall diameter.



D = DOWN DISCHARGE

Width	Depth	Height	Number	UPC Code	Pkg/Qty	Carton Weight
28"	28"	29"	C-76-D	0 53523 01022-3	Box/5	18#
28"	28"	32"	C-282832-D	0 53523 01201-2	Box/5	21#
28"	28"	34"	C-13-D	0 53523 01002-5	Box/5	14#
32"	30"	30"	C-323030-D	0 53523 01170-1	Box/5	20#
34"	34"	36"	C-61-D	0 53523 01006-3	Box/5	24#
34"	34"	40"	C-5-D	0 53523 01008-7	Box/5	25#
34"	34"	45"	C-6-D	0 53523 01028-5	Box/5	28#
37"	37"	32"	C-130-D	0 53523 01009-4	Box/5	24#
37"	37"	42"	C-55-D	0 53523 01011-7	Box/5	31#
37"	37"	45"	C-54-D	0 53523 01013-1	Box/5	32#
38"	38"	40"	C-56-D	0 53523 01034-6	Box/5	33#
39"	39"	36"	C-51-D	0 53523 01036-0	Box/5	26#
40"	37"	30"	C-403730-D	0 53523 01171-8	Box/5	28#
40"	40"	28"	C-7-D	0 53523 01037-7	Box/5	30#
40"	40"	46"	C-44-D	0 53523 01015-5	Box/5	38#
41"	41"	29"	C-10-D	0 53523 01016-2	Box/5	26#
41"	41"	33"	C-414133-D	0 53523 01172-5	Box/5	26#
42"	42"	54"	C-125-D	0 53523 01039-1	Box/5	43#
45"	45"	35"	C-11-D	0 53523 01017-9	Box/5	37#
45"	45"	38"	C-53-D	0 53523 45453-9	Box/5	40#
46"	46"	26"	C-464626-D	0 53523 01174-9	Box/5	28#
46"	46"	34"	C-464634-D	0 53523 01175-6	Box/5	36#
51"	51"	56"	C-63-D	0 53523 01047-6	Box/3	31#
52"	52"	52"	C-77-D	0 53523 01049-0	Box/2	20#
62"	62"	62"	C-72-D	0 53523 01054-4	Box/2	32#

Cooler Covers



S = SIDE DISCHARGE

Width	Depth	Height	Number	UPC Code	Pkg/Qty	Carton Weight
22"	22"	27"	C-222227-S	0 53523 22227-5	Box/5	12#
24"	18"	28"	C-2-S	0 53523 01018-6	Box/5	12#
28"	28"	29"	C-76-S	0 53523 01021-6	Box/5	16#
28"	28"	32"	C-282832-S	0 53523 01169-5	Box/5	17#
28"	28"	34"	C-13-S	0 53523 01001-8	Box/5	13#
28"	28"	41"	C-112-S	0 53523 01003-2	Box/5	16#
32"	21"	31"	C-322131-S	0 53523 01203-6	Box/5	16#
32"	30"	30"	C-323030-S	0 53523 01204-3	Box/5	13#
34"	28"	40"	C-4-S	0 53523 01004-9	Box/5	16#
34"	34"	36"	C-61-S	0 53523 01005-6	Box/5	20#
34"	34"	40"	C-5-S	0 53523 01007-0	Box/5	22#
37"	37"	42"	C-55-S	0 53523 01010-0	Box/5	28#
37"	37"	45"	C-54-S	0 53523 01012-4	Box/5	30#
38"	38"	40"	C-56-S	0 53523 01034-6	Box/5	23#
39"	39"	36"	C-51-S	0 53523 01035-3	Box/5	35#
40"	37"	30"	C-403730-S	0 53523 01176-3	Box/5	34#
40"	40"	46"	C-44-S	0 53523 01014-8	Box/5	35#
42"	42"	54"	C-125-S	0 53523 01038-4	Box/5	24#
46"	46"	26"	C-464626-S	0 53523 01080-3	Box/5	26#
46"	46"	34"	C-464634-S	0 53523 01176-3	Box/5	30#
51"	51"	56"	C-63-S	0 53523 01046-9	Box/3	35#
53"	40"	45"	C-45-S	0 53523 01050-6	Box/5	31#
62"	62"	62"	C-72-S	0 53523 01053-7	Box/2	32#

Diameter	Height	Number	UPC Code	Pkg/Qty	Carton Weight
34"	34"	C-3434-RD	0 53523 01015-6	Box/5	20#
40"	34"	C-4034-RD	0 53523 01128-2	Box/5	24#
44"	36"	C-4436-RD	0 53523 01125-1	Box/5	28#
45"	34"	C-4534-RD	0 53523 01177-0	Box/5	23#
54"	36"	C-5436-RD	0 53523 01097-1	Box/5	34#
44"	36"	C-4436-RS	0 53523 01126-8	Box/5	31#

Turbine Ventilator Covers



Number	Description	UPC Code	Pkg/Qty	Carton Weight
C-12-T	For 10" to 14" throat diameter, and up to 19" overall diameter	0 53523 01099-5	Box/25	19.0#

Single Inlet Evaporative Cooler Covers

D = DOWN DISCHARGE, S = SIDE DISCHARGE

Fits Champion "Ultra Cool", "MasterCool"

Width	Depth	Height	Number	UPC Code	Pkg/Qty	Carton Weight
42"	45"	28"	UC-50-D	0 53523 01076-6	Box/5	25#
42"	49"	28"	UC-5012-D	0 53523 01078-0	Box/5	28#
42"	48"	35"	UC-70-D	0 53523 01081-0	Box/5	34#
42"	52"	35"	UC-7012-D	0 53523 01083-4	Box/5	27#
42"	45"	28"	UC-50-S	0 53523 01077-3	Box/5	27#
42"	49"	28"	UC-5012-S	0 53523 01079-7	Box/5	28#
42"	48"	35"	UC-70-S	0 53523 01082-7	Box/5	28#
42"	52"	35"	UC-7012-S	0 53523 01084-1	Box/5	27#

MasterCool® and UltraCool® are registered trademarks of Champion Cooler Corp. / ComfortCool® is a registered trademark of Essick Air Products / AeroCool® is a registered trademark of Phoenix Manufacturing, Inc. PPS Packaging Company is not affiliated with Champion Cooler Corp; Essick Air Products; or Phoenix Manufacturing, Inc.

Fits Phoenix "Aero Cool"

D = DOWN DISCHARGE, S = SIDE DISCHARGE

Width	Depth	Height	Number	UPC Code	Pkg/Qty	Carton Weight
42"	43"	28"	AC-4800-D	0 53523 01070-4	Box/5	30#
42"	45"	35"	AC-6800-D	0 53523 01072-8	Box/5	36#
42"	43"	28"	AC-4800-S	0 53523 01071-1	Box/5	31#
42"	45"	35"	AC-6800-S	0 53523 01073-5	Box/5	36#

Fits "MasterCool" Prior to 2009

D = DOWN DISCHARGE, S = SIDE DISCHARGE

Width	Depth	Height	Number	UPC Code	Pkg/Qty	Carton Weight
42"	43"	28"	MC-430-D	0 53523 01057-5	Box/5	30#
42"	47"	28"	MC-8343-D	0 53523 08343-2	Box/5	28#
42"	43"	33"	MC-630-D	0 53523 01059-9	Box/5	28#
42"	47"	33"	MC-8363-D	0 53523 08363-0	Box/5	32#
42"	60"	38"	ICM-430-D	0 53523 01061-2	Box/5	32#
42"	60"	43"	ICM-630-D	0 53523 01063-6	Box/5	30#
42"	26"	33"	MC-55-S	0 53523 01080-3	Box/5	19#
42"	43"	28"	MC-440-S	0 53523 01058-2	Box/5	23#
42"	47"	28"	MC-8344-S	0 53523 08344-4	Box/5	25#
42"	43"	33"	MC-640-S	0 53523 01060-5	Box/5	28#
42"	47"	33"	MC-8364-S	0 53523 78360-8	Box/5	29#
42"	60"	38"	ICM-440-S	0 53523 01062-9	Box/5	30#
42"	60"	43"	ICM-640-S	0 53523 01064-3	Box/5	28#

MasterCool® and UltraCool® are registered trademarks of Champion Cooler Corp. / ComfortCool® is a registered trademark of Essick Air Products / AeroCool® is a registered trademark of Phoenix Manufacturing, Inc. PPS Packaging Company is not affiliated with Champion Cooler Corp; Essick Air Products; or Phoenix Manufacturing, Inc.

Please contact us for sizes not listed.

Terms and Conditions of Sale

Terms

- Net 30 days. All orders are subject to credit approval.

Freight

- Contact Customer Service Department for freight policy.

Pricing

- Prices are subject to change without notice.
- Invoices are subject to price in effect at time of shipment.
- When clerical errors and omissions occur, PPS reserves the right to make corrections.

Back-Ordering

- All back-orders will be filled unless advised otherwise by the customer in advance.

Broken Carton Orders

- PPS will not break cartons/bundles/cases. Orders for less than full cartons/bundles/cases will be shipped at next highest quantity of bundle/carton/case.

Late Payment

- A late payment charge of 1.5% per month will be charged on past due invoices.
- The customer is responsible for PPS reasonable attorney's fees and collection costs to collect delinquent accounts.

Warranty and Return Product Policy

- The manufacturer's motor warranty is for one year from date of sale.
- Pumps are warranted for two years from date of sale to the customer.
- Promotional pumps (P-5G and P-7G) are warranted for 90 days from date of sale to customer.
- All other products are warranted for 90 days from date of sale to customer.
- Defective products must be reported to our Customer Service Department for disposition instructions.
- Warranty credit will be credited to customer account and applied to next purchase from PPS.

Claims

- Claims for shortages or damages must be noted on the freight bill at the time of delivery, and a copy of the freight bill faxed to PPS Customer Service.
- Claims for shortages must be reported to PPS in writing within 5 working days of the shipment. Also, the claim must be supported by a copy of the freight bill and detailed receiver or they will not be honored.
- All other claims against PPS invoices must be submitted within 15 days of the invoice date to be considered by PPS.

Buy Backs

- PPS does not provide for buy-back of excess product at the end of the cooler season.

Plan-o-grams

- PPS plan-o-grams available for 4', 8' and 12'.

Ordering Errors

- If a product was ordered in error, a Returned Good Authorization (RGA) will be needed before the product may be returned. All returned product is subject to a 25% restocking charge and all freight charges are at the customer's expense.
- Once the RGA has been issued, return the product to:

*PPS PACKAGING CO.
3189 E. Manning Ave.
Fowler, CA 93625*

Ship all product PREPAID and include the RGA # on the packing list.



PPS PACKAGING COMPANY

3189 E. Manning Ave., PO Box 427,
Fowler, CA 93625-0427
(800) 344-6819 • (559) 834-1641 • FAX: (559) 834-2011
www.ppspackaging.com • www.aspensnowcool.com

QUALITY EVAPORATIVE COOLER PRODUCTS

Aspen Snow-Cool™

PPS Packaging Company was founded in 1976 with our manufacturing facility and corporate office located in central California. While manufacturing Aspen excelsior cooler pads, we are always looking for ways to improve our own line of evaporative cooler products. Whether it's our Aspen Snow-Cool™ Premier Cooler Pads with Grid-Flo™ stitching; our exclusive Loop & Lock™ closure system on our cooler covers; or our patented product line of Mighty Cool™ Cooler Pumps, our innovations keep your evaporative cooler running at its highest efficiency. In addition, we also provide our customers with a complete line of cooler care products, parts and accessories. With our products sold around the world, PPS Packaging Company stays dedicated to being your independent, dependable source for quality cooler products and superior customer support.



3189 E. Manning Ave., PO Box 427 • Fowler, CA 93625-0427
(800) 344-6819 • (559) 834-1641 • FAX: (559) 834-2011

www.ppspackaging.com • www.aspensnowcool.com