

ATTENTION INSTALLER

Read this installation template before installing humidifier. Warranty is void unless humidifier is installed by qualified heating and air conditioning contractor due to possible misapplication of product. This product must be installed in compliance with all local, state, and federal codes. Proper humidification and humidity control require that the home be constructed with local codes and good building practices.

⚠ WARNING

ELECTRICAL SHOCK HAZARD. Disconnect power to the furnace before installing humidifier.

⚠ CAUTION

SHARP EDGES. Use care when cutting and handling ductwork.

HOT WATER CAN SCALD. Shut off hot water supply before tapping into hot water supply.

NOTICE

FREEZING TEMPERATURES CAN BURST WATER PIPES.

Do not install humidifier where freezing may occur.

CONDENSATION DAMAGE OR MOLD CAN OCCUR.

Locate return duct mounted humidifier control at least 6" upstream of humidifier, or fresh air intake for accurate humidity sensing.

Locate wall mount humidifier control in areas unaffected by drafts or heat sources for accurate humidity sensing.

Reduce the setting on the humidifier control if condensation forms on windows or in unheated spaces.

EQUIPMENT DAMAGE MAY OCCUR.

Do not install humidifier on the furnace jacket.

Do not connect the power cord to multi-speed furnace blower motors or blower motors other than 120 VAC. Use Aprilaire Model 50 Current Sensing Relay. Do not alter 120 VAC plug or hardwire the unit.

Do not install the humidifier on a plenum face at the blanked end of the cooling coil.

If water pressure exceeds 125 psi, reduce water pressure with devices allowed by local codes.

Do not use water with temperature greater than 140°F.

Do not install humidifier on systems with differential pressure greater than 0.4 w.g. between the supply and return plenums.

When installing the humidifier control on the return duct of a downflow furnace, ensure the blower continues to run after a heat call is satisfied.

SPECIFICATIONS

Humidifier Dimensions:

Width: 15-29/32"
Height (including solenoid valve and drain spud): 18"
Depth: 10-11/32"

Plenum Opening: 14-3/4"W x 14-5/16"H

Water Feed Rate: 3 gph

Electrical Data: 24 VAC, 60 Hz, 0.8 Amp

Water Panel®: Model 35

FURNISHED ITEMS

- 24 VAC transformer
- Automatic Digital Humidifier Control and Outdoor Temperature Sensor (Model 700 only)
- Manual Humidifier Control (Model 700M only)
- Humidifier Control Installation Instructions
- Saddle valve
- Humidifier Installation Template

ITEMS NOT FURNISHED

- Mounting screws (sheet metal screws)
- Water supply line (1/4" O.D. copper)
- Drain line (1/2" I.D. hose)
- Low voltage wire
- Model 50 current sensing relay (if required)

INSTALLATION OPTIONS

Aprilaire® Model 700 and 700M can be installed on either the supply plenum or cold air return of a forced air handling system. The humidifier dimensions and serviceability must be considered when selecting the best location for the humidifier.

Hot water is recommended (140°F max) to provide maximum evaporative capacity. It is also recommended when the Blower Activation Feature is used with an Automatic Digital Humidifier Control, or on a heat pump system. The humidifier functions with cold, hot, softened, or unsoftened water.

RECOMMENDED

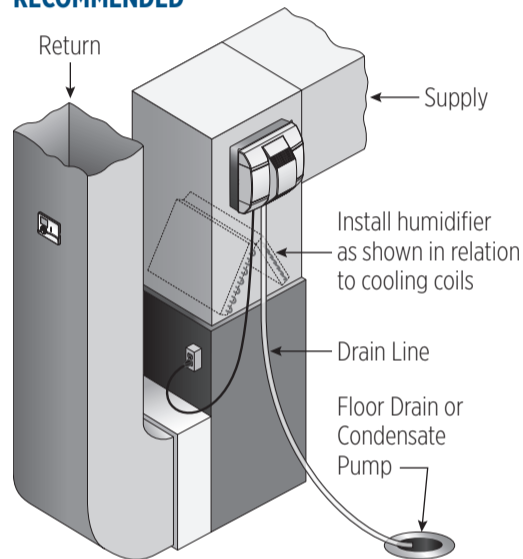

RECOMMENDED

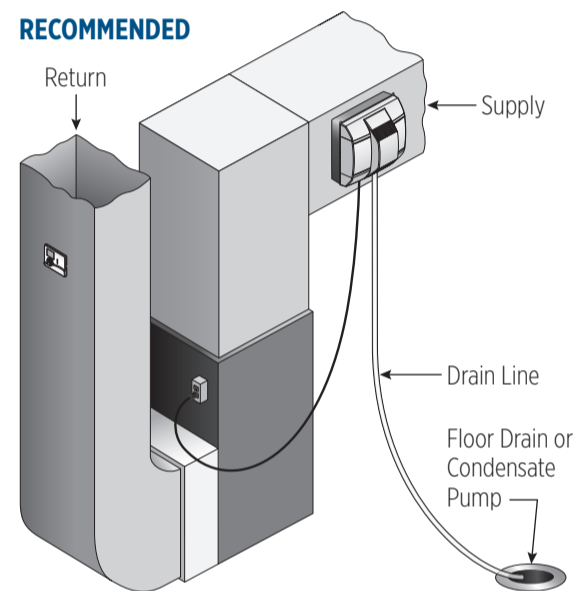

ALTERNATE

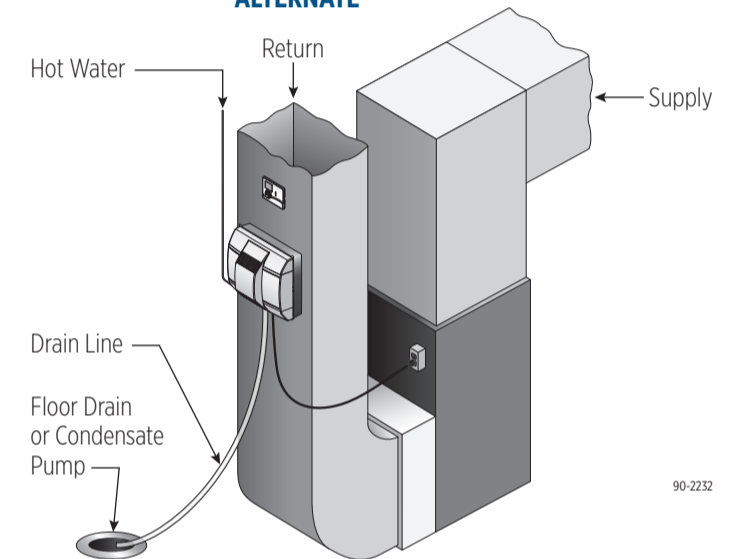

PARTS LIST

1. Front Cover
2. Base
3. Orifice Plate
4. Motor Mount Bridge
5. Scale Control Insert
6. Water Panel®
7. Water Distribution Tray
8. Fan Blade
9. Motor
10. Motor Mount Gasket
11. Relay
12. Power Cord
13. Strain Relief Bushing
14. Solenoid Valve
15. Connector Plug
16. Feed Tube
17. Nozzle
18. Relay Connector
19. Transformer
20. Strainer
21. Orifice

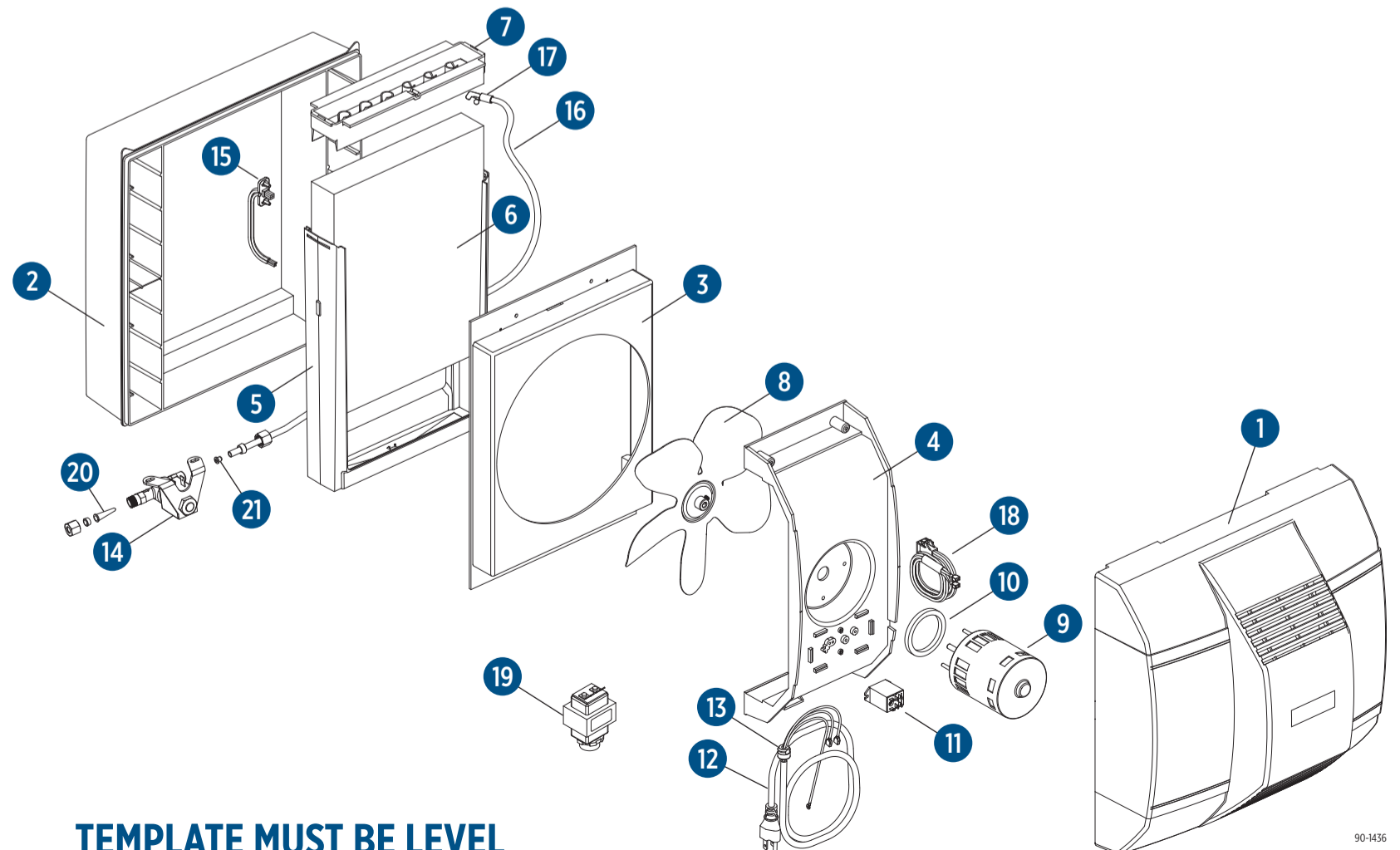

TEMPLATE MUST BE LEVEL

INSTALLATION INSTRUCTIONS

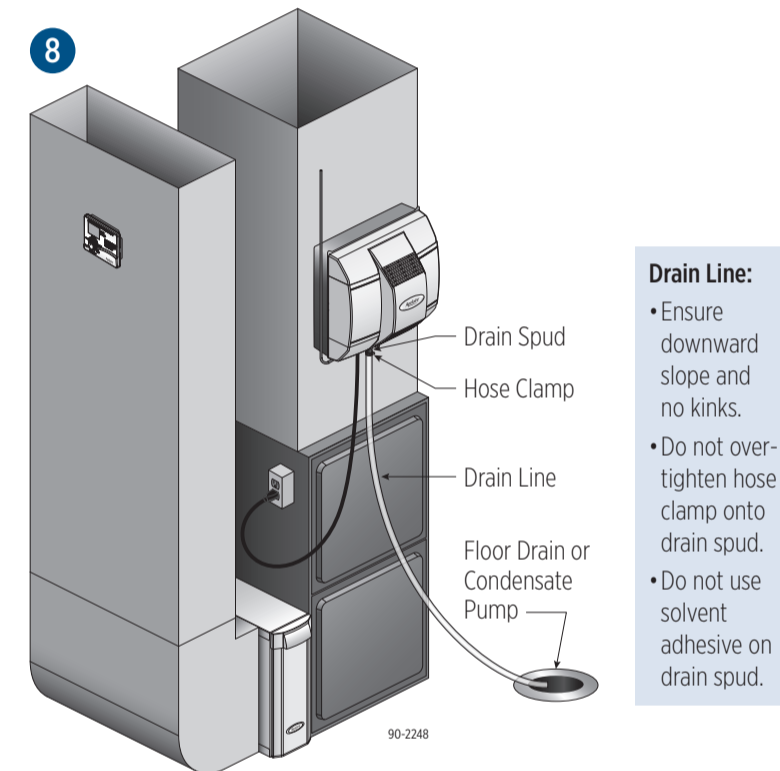
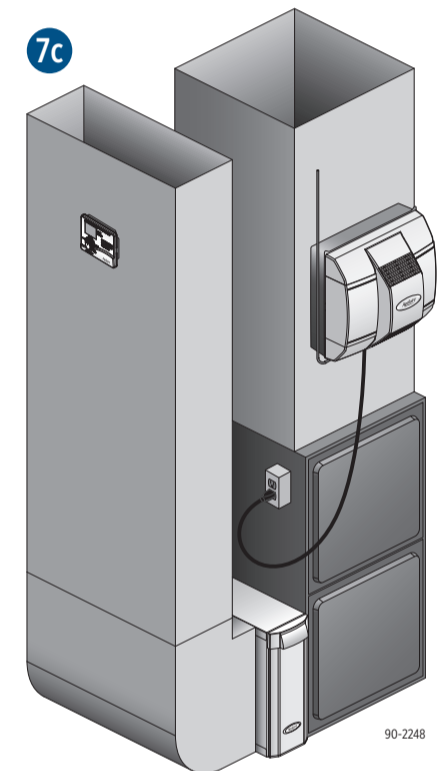
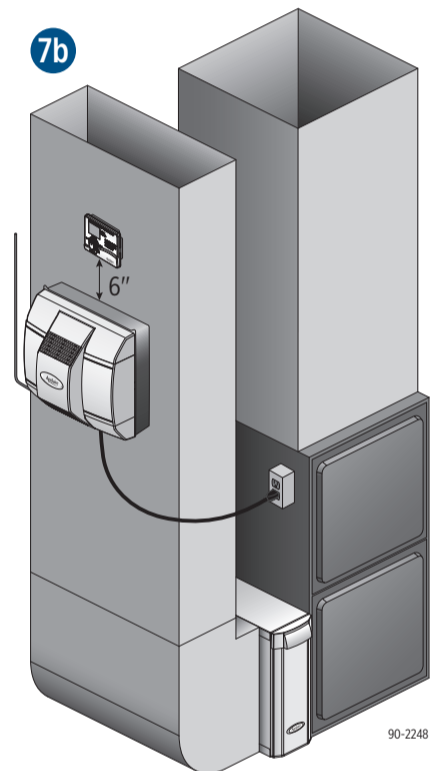
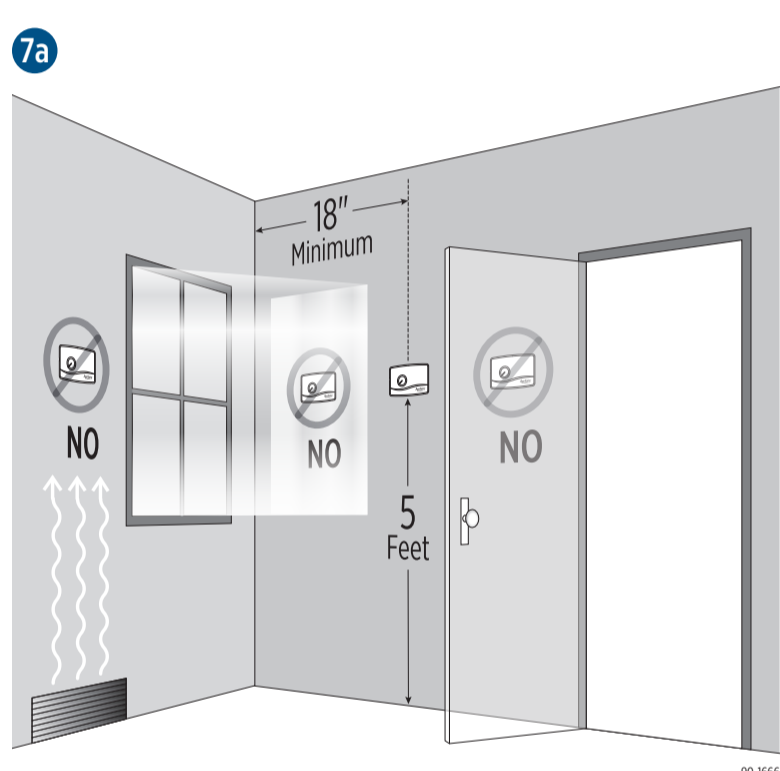
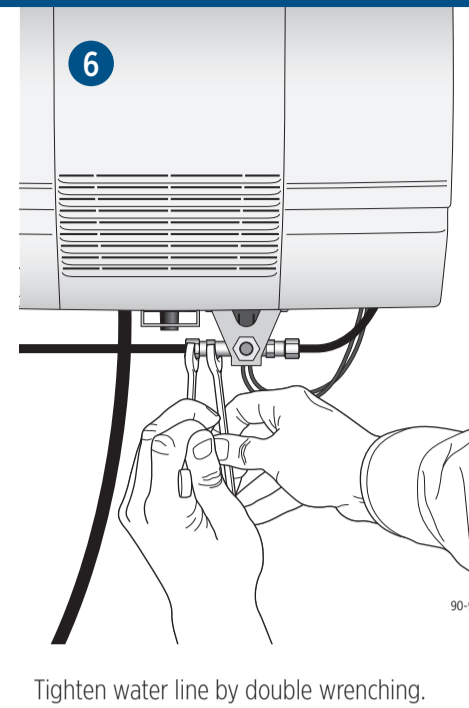
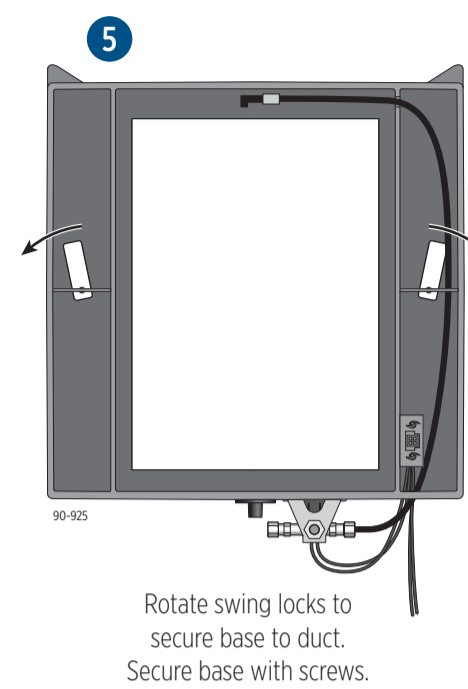
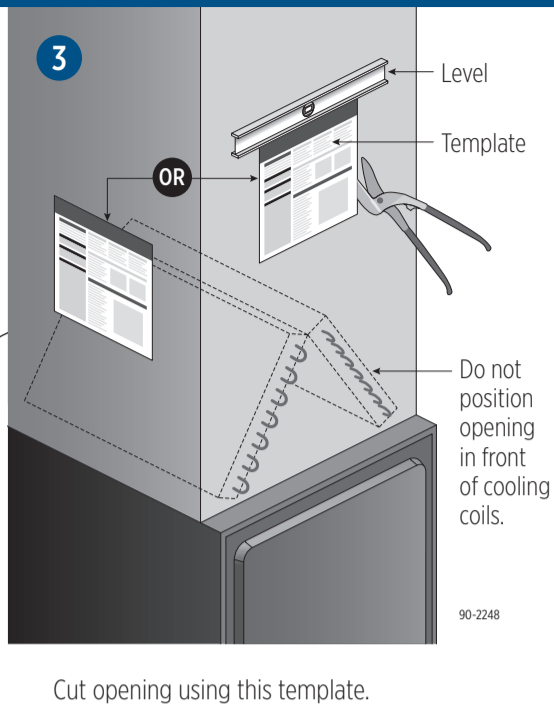
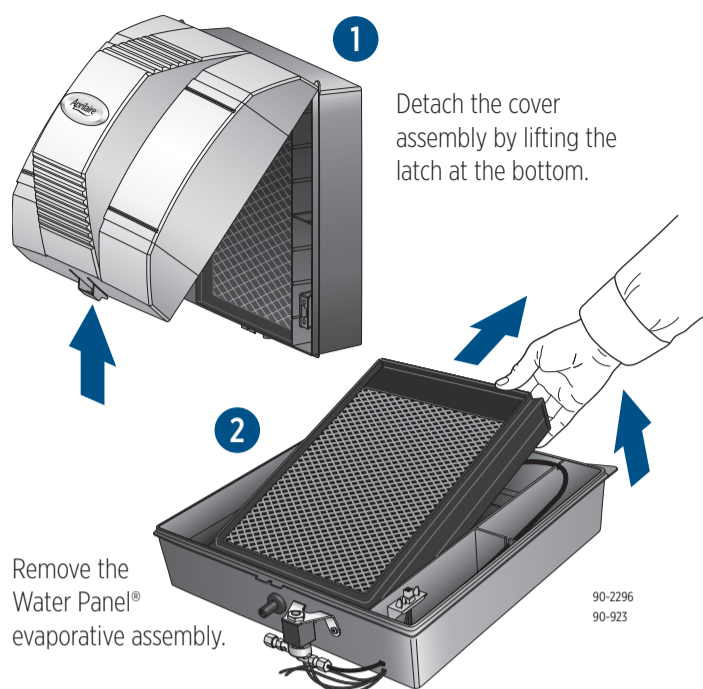

Drain Line:

- Ensure downward slope and no kinks.
- Do not over-tighten hose clamp onto drain spud.
- Do not use solvent adhesive on drain spud.

MODEL 700 DIGITAL HUMIDIFIER CONTROL WIRING

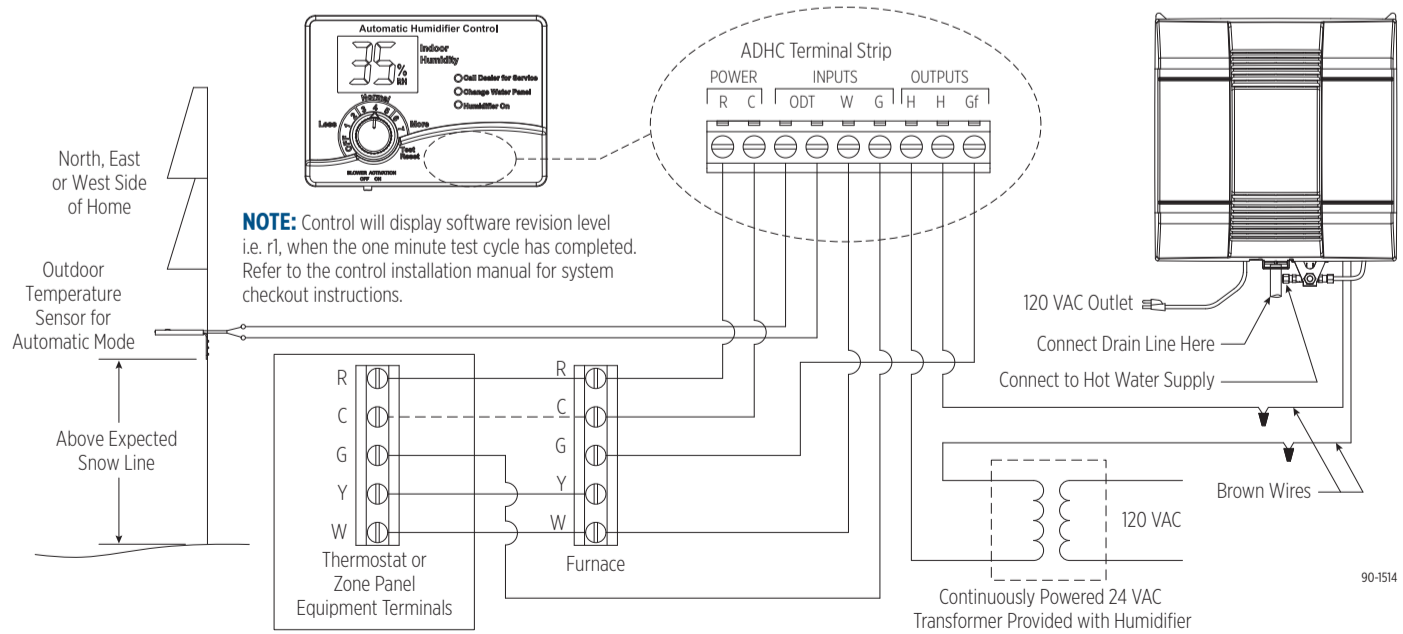

MODEL 700M MANUAL CONTROL WIRING

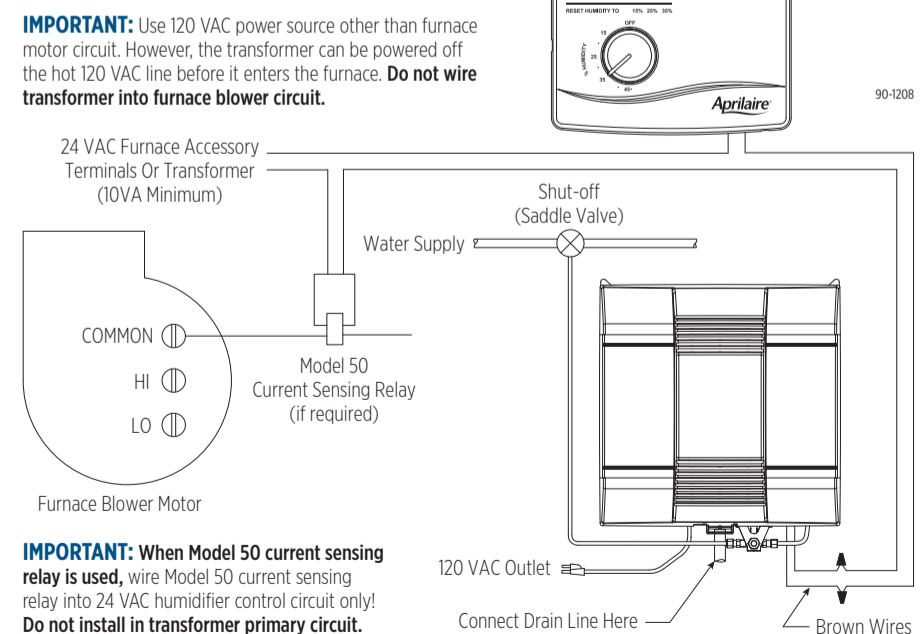

INSTALLATION CHECKLIST

- Saddle valve is fully open.
- All plumbing connections are watertight.
- Unit is plugged into 120 VAC outlet.
- Humidifier functions properly.
- Owner's manual has been given to homeowner.