



### Features

- Integral flange.
- Right drain.
- Integral lumbar support and armrests for comfort.
- Textured bottom surface.
- 66" (1676 mm) x 35-7/8" (911 mm) x 20" (508 mm)

### Material

- Acrylic

### Hydrotherapy

- Single-speed whirlpool offers 5 fully adjustable hydro-massage jets for water flow and direction.
- Pump with air switch for whirlpool.
- Built-in 1500 W heater.

### Installation

- Alcove

### Recommended Accessories

- K- 1234 Apron
- K- 7161-AF Bath Drain
- K- 9695 5-Jet Trim Kit
- K- 24916 Wireless Music Kit



### Codes/Standards





ASME A112.19.7/CSA B45.10  
CSA B45.5/IAPMO Z124  
ASTM E162  
ASTM E662  
UL 1795  
Greenguard UL 2818 - Gold  
CARB P2

### KOHLER® One-Year Limited Warranty

See website for detailed warranty information.

### Available Color/Finishes

*Color tiles intended for reference only.*

Color	Code	Description
	0	White
	96	Biscuit
	47	Almond
	NY	Dune
	G9	Sandbar

No change in measurements if connected with drain illustrated. (K-7161-AF)

■ Recommended Faucet Area

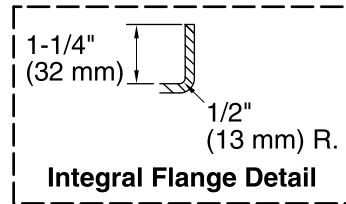

Pump/Control Access  
(if apron is not used)  
20" (508 mm) W x 15" (381 mm) H

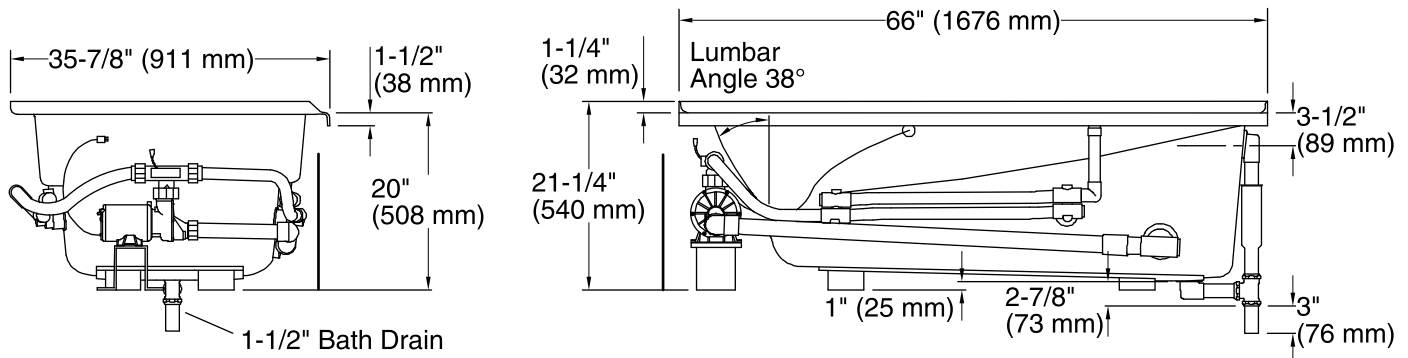
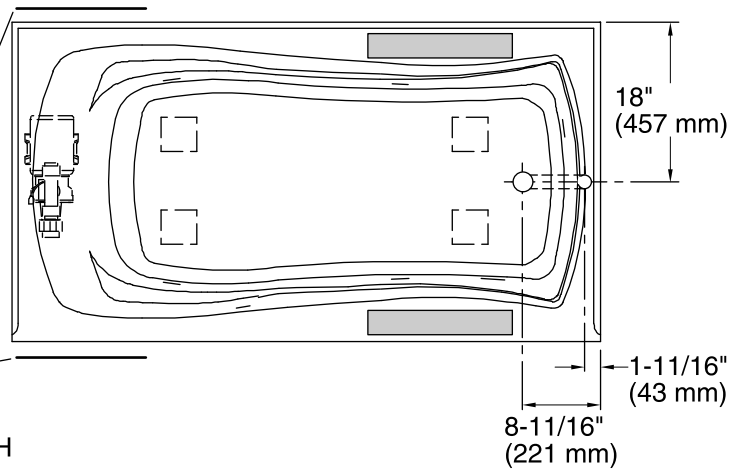

### Required Electrical Service

Two dedicated circuits required, protected with Class A Ground-Fault Circuit-Interrupter (GFCI) or Residual Current Device (RCD).

Pump: 120 V, 15 A, 60 Hz  
Heater: 120 V, 15 A, 60 Hz

### Technical Information

All product dimensions are nominal.

Installation: 3-Wall Alcove  
Drain location: Right  
Basin area, bottom: 48" x 24" (1219 mm x 610 mm)  
Basin area, top: 59" x 30" (1499 mm x 762 mm)  
Weight: 115 lbs (52.2 kg)  
Minimum floor load: 43 lbs/ft<sup>2</sup> (209.9 kg/m<sup>2</sup>)  
Water depth: 14" (356 mm)  
Water capacity: 67 gal (253.6 L)  
Electrical component rating: Pump: 120 V, 7.5 A, 60 Hz  
Heater: 120 V, 12.5 A, 60 Hz, 1500 W  
Pump speed: Single  
Minimum flat for door: 2-1/2" (64 mm)

### Notes

Measure your actual product for rough-in details.

Install this product according to the installation instructions.

The hot water supply should be 70% of the capacity of the bath or greater. Installations will vary.

Provide one grounded electrical outlet within 24" (610 mm) of each component.

If installing a rim-mount faucet, make sure there is no interference with drain overflow or whirlpool system before drilling any holes. Consult local and national codes for minimum air gap requirements if installing a spout on the faucet deck.