

**Effective Date 6/17/2008
With Addendums Thru 12/1/2009**

**Supersedes Price Book
3/18/2008**

tyco ***Fire Suppression
& Building Products***

U. S. List Prices

for

**Sprinklers, Devices, Grooved Piping,
CPVC, Accessories and Repair Parts**

Tyco Fire Products Sprinkler Terms & Conditions

General Terms & Conditions

Sales by Tyco Fire & Building Products ("TFBP") shall be subject to the terms and conditions herein, which terms and conditions may vary from time to time and Buyer's purchase order shall constitute acceptance of such terms and conditions. Buyer's purchase order, if at variance with the terms and conditions herein, shall not be binding upon TFBP unless specifically accepted by TFBP in writing.

Price Terms

All prices and quotes are FOB point of shipment and subject to change without notice.

Payment Terms

2.0% 10/30. Prompt pay discount of 2% allowed within 10 days of invoice date and due at 30 days. Delinquent payments are subject to 1.5% monthly service charge (18% annually) on unpaid balances; or if such rate is prohibited under applicable law, then at such rate as is permissible. TFBP further reserves the right to reclaim goods, which may be in the Buyer's possession in the event of Buyer's breach of the payment terms.

Minimum Billing

The Minimum Billing Policy is \$50.00 per Order. The Minimum Billing amount does not apply to orders for service/repair parts.

Shipping & Freight

"Free Freight" terms will be provided on orders of \$2,500.00 in value or greater.

Shipments within the Continental U.S. and Canada will be at the sole discretion of TFBP. If the Buyer specifies a more expensive routing, the Buyer assumes total transportation expenses and will be charged the actual freight expense incurred.

Shipments to destinations other than the Continental U.S. and Canada will be subject to special handling, packaging, and freight charges and billed to the Buyer.

Unless specifically indicated in writing to the contrary, TFBP reserves the right to make partial shipments.

Shipping Date & Delivery

Shipping date and delivery specified are subject to any priorities or allocations necessitated by Government orders or regulations, and time and manner of delivery are subject to any delay on the part of the Buyer(s) in supplying necessary data, or by any changes in data at the Buyer(s) insistence, and/or to delays caused by Acts of God, strikes, lock-outs, riots, war, breakdowns, priorities or embargoes, accidents, civil or military authority, shortages of labor, delay in suppliers (or supplies) of material, difficulty in obtaining raw material, and any other cause beyond TFBP's reasonable control. Delay in delivery for any of the aforementioned causes shall proportionately extend the time of delivery hereunder. TFBP shall be compensated for any and all extra costs and expenses occasioned by delays attributable to the Buyer(s).

Every effort will be made to fill orders within the time stated, but under no circumstances will TFBP be responsible for or the Buyer(s) entitled to consequential damages arising out of or owing to any delays in delivery whatever or for causes beyond TFBP's reasonable control.

Special Orders

Special material orders and made-to-order products may not be cancelled unless agreed to by TFBP in writing, and upon agreement to compensation for work already performed. Any special material, TFBP non-manufactured items, or items deemed to be nonstandard may not be cancelled. **All returned items are subject to a 25% restocking fee.**

Limited Warranty

Products manufactured by TFBP are warranted solely to the original Buyer for **ten (10) years** against defects in material and workmanship when paid for and properly installed and maintained under normal use and service. This warranty will expire ten (10) years from date of shipment by TFBP. No warranty is given for products or components manufactured by companies not affiliated by ownership with TFBP or for products and components which have been subject to misuse, improper installation, corrosion, or which have not been installed, maintained, modified or repaired in accordance with applicable Standards of the National Fire Protection Association (NFPA), and/or the standards of any other Authorities Having Jurisdiction. Materials found by TFBP to be defective shall be either repaired or replaced, at TFBP's sole option. TFBP neither assumes, nor authorizes any person to assume for it, any other obligation in connection with the sale of products or parts of products. TFBP shall not be responsible for sprinkler system design errors or inaccurate or incomplete information supplied by Buyer or Buyer's representatives.

IN NO EVENT SHALL TFBP BE LIABLE, IN CONTRACT, TORT, STRICT LIABILITY OR UNDER ANY OTHER LEGAL THEORY, FOR INCIDENTAL, INDIRECT, SPECIAL OR CONSEQUENTIAL DAMAGES, INCLUDING BUT NOT LIMITED TO LABOR CHARGES, REGARDLESS OF WHETHER TFBP WAS INFORMED ABOUT THE POSSIBILITY OF SUCH DAMAGES, AND IN NO EVENT SHALL TFBP'S LIABILITY EXCEED AN AMOUNT EQUAL TO THE SALES PRICE.

The foregoing warranty is made in lieu of any and all other warranties express or implied, including warranties of merchantability and fitness for a particular purpose.

Tyco Fire Products Sprinkler Terms & Conditions

Terms & Conditions

Table of Contents

Return Goods Policy

1. The request to return material must include the description of material, reason for return, customer order number and/or customer invoice number to enable the request to be processed. No materials may be returned without this information.
2. When the request is approved, a Return Authorization form will be completed and include a predetermined number for reference and advise where the material should be returned. The Return Authorization form will contain a Packing list copy which must accompany materials when they are returned. Return Authorizations are valid for 30 days only from date of issue.
3. No credit will be issued for returned materials without an approved Return Authorization.
4. Materials being returned due to order entry and/or shipping errors on the part of TFBP will be credited at full value providing the materials are returned within 30 days from the date of the original shipment.
5. Full credit will be issued for defective materials only after the material has been inspected and verified by TFBP.
6. A 25% restocking charge and/or a \$10.00 minimum charge, whichever is greater, will be assessed on products for inspecting, handling and restocking the material, and the total credit will depend upon the resale value of the material. Returned freight will be at the customer's expense.
7. Items purchased for resale by TFBP may be returned under the Manufacturer's terms and conditions only. If the Manufacturer will not accept the materials, credit will not be issued by TFBP to the Buyer.
8. Non-stock manufactured items will be evaluated on an individual basis with credit being issued if the items can be resold or converted to stock. If not, credit will be issued for salvage value.
9. Credit will not be issued for discontinued items. Items no longer manufactured or items superseded by another model are defined as discontinued.
10. Fire Protection Products must be less than two (2) years old for return consideration and of reasonable quantities.
11. To receive consideration for credit, material must be in resalable condition. In cases where materials must be reconditioned and/or missing parts replaced, the customer will be charged the normal 25% restocking charge for products; plus the actual plant cost for labor and material required to put the item in new condition and available for resale. Credit will not be issued for materials previously installed unless covered by Item No. 5 above.
12. Material that has been approved for return must be packed in such a way as to prevent damage during shipment. The use of original packaging is preferred. Credit cannot be issued for materials damaged in transit due to improper packaging.
13. Grooved and Mechanical Grooved Products identified in gray in the TFBP Price Book are fabricated items and are not subject to order cancellation or return.

Claims

Claims by the Buyer for billing errors, shortages, freight charges or allowances of any kind must be made within thirty (30) days from receipt of the material.

9/30/2008 Price Book Addendums

	<i>Description</i>	<i>Date</i>
Grinnell Roll Groovers		9/30/2008
CPVC		9/1/2008

Table of Contents

Section 1 - Standard Spray Sprinklers

Model TY-L, Pendent, Recessed Pendent & Upright, K=5.6, 1/2" N.P.T.	1-1
Model TY-L, Pendent, Recessed Pendent & Upright, K=8.0, 3/4" N.P.T.	1-2
Model TY-L, Pendent, Recessed Pendent and Upright Sprinklers, K=8.0, 1/2" N.P.T.	1-3
Model TY-L, Horizontal Sidewall Sprinkler, K=5.6, 1/2" N.P.T.	1-3
Model TY-FRL, Pendent, Recessed Pendent & Upright, Quick Response Sprinkler, K=2.8, 1/2" N.P.T.	1-4
Model TY-FRL, Pendent, Recessed Pendent & Upright, Quick Response Sprinkler, K=5.6, 1/2" N.P.T.	1-5
Model TY-FRL, Pendent & Upright, Quick Response Sprinkler, K=8.0, 3/4" N.P.T.	1-6
Model TY-FRL, Horizontal Sidewall Sprinkler, K=5.6, 1/2" N.P.T.	1-6
TY-B, 5mm Bulb, Pendent, Recessed Pendent and Upright, K=5.6, 1/2" N.P.T.	1-7
TY-B, 5mm Bulb, Pendent and Upright Sprinklers, K=8.0, 1/2" N.P.T.	1-8
TY-B, 5mm Bulb, Pendent, Recessed Pendent and Upright Sprinklers, K=8.0, 3/4" N.P.T.	1-9
TY-B, 5mm Bulb, Horizontal, Recessed Horizontal, and Vertical Sidewall Sprinklers, K=5.6, 1/2" N.P.T.	1-10
TY-FRB, 3mm Bulb, Quick Response, Pendent, Recessed Pendent and Upright Sprinklers, K=2.8, 1/2" N.P.T.	1-11
TY-FRB, 3mm Bulb, Quick Response, Pendent, Recessed Pendent and Upright Sprinklers, K=4.2, 1/2" N.P.T.	1-12
TY-FRB, 3mm Bulb, Quick Response, Pendent, Recessed Pendent and Upright Sprinkler, K=5.6, 1/2" N.P.T.	1-13
TY-FRB, 3mm Bulb, Quick Response, Pendent, Recessed Pendent and Upright Sprinkler, K=8.0, 3/4" N.P.T.	1-14
TY-FRB, 3mm Bulb, Quick Response, Horizontal, Recessed Horizontal Sidewall and Vertical Sidewall, K=5.6, 1/2" N.P.T.	1-15
Series RFII, Standard Response, "Royal Flush II" Pendent Concealed Sprinklers, K=5.6, 1/2" N.P.T.	1-16
Series RFII, Quick Response, "Royal Flush II" Pendent Concealed Sprinklers, K=5.6, 1/2" N.P.T.	1-17
Model TYQRF, Quick Response Standard Coverage, Flush Pendent Sprinkler, K=5.6, 1/2" N.P.T.	1-18

Section 2 - Extended Coverage Sprinklers

Model EC-25, Upright, Area/Density, Extended Coverage, K=25.2, 1" N.P.T.	2-1
Model EC-17, Pendent and Recessed Pendent Sprinklers K=16.8, 3/4" N.P.T.	2-1
Series EC-14, Upright Sprinklers, K=14.0, 3/4" N.P.T.	2-2
Series EC-14, Pendent and Recessed Pendent Sprinklers, K=14.0, 3/4" N.P.T.	2-3
Series EC-11, Pendent, Recessed Pendent and Upright Sprinklers, K=11.2, 3/4" N.P.T.	2-4
TY-FRB, 3mm Bulb, Quick Response, Extended Coverage, Horizontal & Recessed Horizontal Sidewall, K=5.6, 1/2" N.P.T.	2-5
TY-FRB, 3mm Bulb, Quick Response, Extended Coverage, Horizontal & Recessed Horizontal Sidewall, K=8.0, 3/4" N.P.T.	2-6
ELO SW-20 ECOH, Sidewall Sprinklers, K=11.2, 3/4" N.P.T.	2-7
ELO SW-24 ECOH, Sidewall Sprinklers, K=11.2, 3/4" N.P.T.	2-7
ELOC Extended Coverage, Concealed Sprinklers, K=11.2, 3/4" N.P.T.	2-7
Series RFII, "Royal Flush II" Pendent Concealed Sprinklers Extended Coverage, Quick & Standard Response, K=5.6.	2-8
Model TY-FRL, Extended Coverage Quick Response, Horizontal Sidewall Sprinkler, K=5.6, 1/2" N.P.T.	2-9
Model TY-FRL, Quick Response, Extended Coverage Horizontal Sidewall Sprinklers, K=8.0, 3/4" N.P.T.	2-9
CHEC, ECLH Concealed Horizontal Sidewall Extended Coverage Sprinklers, K=8.0, 3/4" N.P.T.	2-9
EC-8 QR, ECLH, Pendent and Recessed Pendent Sprinklers, K=8.0, 3/4" N.P.T.	2-10
EC-5 QR, Pendent, Recessed Pendent and Sidewall Sprinklers, K=5.6, 1/2" N.P.T.	2-10

Terms & Conditions

Table of Contents

Table of Contents

Section 3- Storage Sprinklers

Model ESFR-25™, Early Suppression, Fast Response Sprinkler, K=25.2, 1" N.P.T. 3-1

ESFR-17, Early Suppression, Fast Response Upright Sprinkler, K=16.8, 3/4" N.P.T. 3-1

ESFR-17, Early Suppression, Fast Response Pendent Sprinkler, K=16.8, 3/4" N.P.T. 3-1

Model ESFR-1, Early Suppression, Fast Response Sprinkler, K=14.0, 3/4" N.P.T. 3-2

Ultra K17, Upright, Thread Specific Application, K=16.8, 3/4" N.P.T. 3-2

Model K17-231, Thread, Upright, K=16.8, 3/4" N.P.T. 3-3

Model K17-231, Thread, Pendent, K=16.8, 3/4" N.P.T. 3-3

Model ELO-231 and ELO-231B, Standard Response, Upright and Pendent Sprinklers, K=11.2, 1/2" N.P.T. & 3/4" N.P.T. 3-4

ELO-231 FRB, Quick Response, Upright, Pendent Sprinklers, K=11.2, 3/4" N.P.T. 3-5

LD Large Drop Upright Sprinklers, K=11.2, 3/4" N.P.T. 3-5

TY-B, 5mm Bulb, Standard Response, Intermediate Level Upright and Pendent Sprinklers w/Shield, K=5.6, 1/2" N.P.T. 3-6

TY-B, 5mm Bulb, Standard Response, Intermediate Level Upright and Pendent Sprinklers w/Shield, K=8.0, 3/4" N.P.T. 3-7

TY-FRB, 3mm Bulb, Quick Response, Intermediate Level Upright and Pendent Sprinklers w/Shield, K=5.6, 1/2" N.P.T. 3-8

TY-FRB, 3mm Bulb, Quick Response, Intermediate Level Upright and Pendent Sprinklers w/Shield, K=8.0, 3/4" N.P.T. 3-9

TY-L, Standard Response, Intermediate Level Upright and Pendent Sprinklers w/Shield, K=5.6, 1/2" N.P.T. 3-10

TY-L, Standard Response, Intermediate Level Upright and Pendent Sprinklers w/Shield, K=8.0, 3/4" N.P.T. 3-11

TY-FRL, Quick Response, Intermediate Level Upright and Pendent Sprinkler w/Shield, K=5.6, 1/2" N.P.T. 3-12

TY-FRL, Quick Response, Intermediate Level Upright and Pendent Sprinkler w/Shield, K=8.0, 3/4" N.P.T. 3-13

Section 4 - Residential Sprinklers

Model LFII - Low Flow Pendent, Fast Response, K=3.0, 1/2" N.P.T. 4-1

Model LFII, Low Flow Horizontal Sidewall, K=4.2, 1/2" N.P.T. 4-1

Model LFII - Low Flow Horizontal Sidewall, K=4.4, 1/2" N.P.T. 4-2

Model LFII - Low Flow Pendent, K=4.9 pendent, 1/2" N.P.T. 4-2

Model LFII - Residential Concealed Pendent Domed Plate, K=4.9 (pendent), 1/2" N.P.T. 4-3

Model LFII - Residential Concealed Sprinkler, K=4.2, 1/2" N.P.T. 4-3

Model LFII - Residential Concealed Sprinkler, K=4.9, 1/2" N.P.T. 4-4

Model LFII, Residential Flush Pendent, K=4.2, 1/2" N.P.T. 4-4

Model LFII, Residential Flush Horizontal Sidewall Sprinkler, K=4.2, 1/2" N.P.T. 4-5

Model LFII, Residential NFPA 13 Optimized Horizontal Sidewall Sprinkler, K=5.8 & K=5.6, 1/2" N.P.T. 4-6

Model LFII - Residential NFPA 13 Optimized Pendent Recessed & Concealed, K=6.9, 3/4" N.P.T. 4-7

Section 5 - Dry Sprinklers

Series DS-1, Dry, Standard Coverage, Pendent, Upright & Horizontal Sidewall, Standard Response, K=5.6 5-1

Series DS-1, Dry, Standard Coverage, Pendent, Upright & Horizontal Sidewall, Quick Response, K=5.6 5-2

Series DS-1, Dry, Extended Coverage, Horizontal Sidewall, Quick Response & Standard Response, K=5.6 5-3

Series DS-2, Dry, ELO Standard Coverage, Pendent, Standard Response, K=11.2 5-4

Series DS-2, Dry, ELO Standard Coverage, Pendent, Quick Response, K=11.2 5-5

Series DS-2, Dry, ELO Extended Coverage, Pendent, Quick Response & Standard Response, K=11.2 5-6

Series DS-3, Dry, Extended Coverage Ordinary Hazard (ECOH), Horizontal Sidewall, 1" NPT, 3 mm bulb, K=11.2 5-7

Series DS-C, Dry Concealed, Standard Response, K=5.6 5-8

Series DS-C, Dry Concealed, Quick Response, K=5.6 5-9

Series DS-ECC, Dry Extended Concealed Coverage, Quick Response, K=5.6. 5-10

Terms & Conditions

Table of Contents

Table of Contents

Section 6 - Special Sprinklers

Illusion™ Casino Sprinkler ELO Extra Large Orifice, Concealed Pendent Sprinklers, K=11.2, 3/4" N.P.T.	6-1
Model CC2, Combustible Concealed Space Upright Sprinklers, K=5.6, 1/2" N.P.T.	6-1
Model CC2, Combustible Concealed Space Upright Sprinklers, K=4.2, 1/2" N.P.T.	6-2
Model CC1, Combustible Concealed Space Upright Sprinklers, K=3.0, 1/2" N.P.T.	6-2
Window Sprinklers, K=5.6, 1/2" N.P.T.	6-2
Attic Sprinklers, K=4.2 1/2" NPT, K=5.6, 1/2" NPT & K=8.0, 3/4" NPT Models BB, SD, HIP & AP	6-3
TFP TY-B, Stainless Steel & Titanium, Upright and Pendent Sprinkler, K=5.6 & 8.0, 1/2" & 3/4" N.P.T.	6-4
TFP TY-B, Stainless Steel & Titanium, Vertical & Horizontal Sidewall Sprinkler, K=5.6 & 8.0, 1/2" & 3/4" N.P.T.	6-5
TFP TY-FRB, Stainless Steel & Titanium, Upright and Pendent Sprinkler, QR, K=5.6 & 8.0, 1/2" & 3/4" N.P.T.	6-6
TFP TY-FRB, Stainless Steel & Titanium, Vertical & Horizontal Sidewall Sprinkler, QR, K=5.6 & 8.0, 1/2" & 3/4" N.P.T.	6-7
TFP MAX, Institutional Pendent, Quick Response Sprinkler, K=5.6, 1/2" N.P.T.	6-8
TFP MAX, Institutional Horizontal Sidewall, Quick Response Sprinkler, K=5.6, 1/2" N.P.T.	6-9
TY-B, 5mm Bulb, Conventional (Old Style) Sprinklers, K=5.6, 1/2" N.P.T.	6-10
TY-B, 5mm Bulb, Conventional (Old Style) Sprinklers, K=8.0, 3/4" NPT	6-11
TY-FRB, 3mm Bulb, Quick Response, Conventional (Old Style) Sprinklers, K=5.6, 1/2" N.P.T.	6-12
TY-FRB, 3mm Bulb, Quick Response, Conventional (Old Style) Sprinklers, K=8.0, 3/4" NPT	6-13
Issue "D" Quartzoid® Series – High Temperature, K=5.6, 1/2" N.P.T.	6-14
Issue "D" Quartzoid® Series – High Temperature, K=8.0, 3/4" NPT	6-14

Section 7 - Nozzles and Sprinkler Accessories

Protectospray Nozzles Model D-3, 1/2" N.P.T.	7-1
Protectospray Nozzles, Model EA-1	7-2
Mulsifyre Nozzles, 800 Series, 3/4" NPT Connection.	7-3
High Velocity Spray Nozzles Type HV	7-3
Cooling Tower Nozzles, 3/4" NPT, K=2.90	7-4
Exposure Sprinklers, Model A, 1/2" NPT.	7-4
Model B, 3/4" NPT, Exposure Nozzles	7-4
Model B-1, 1/2" Foam Water Sprinkler, 1/2" Male NPT	7-5
U.S. Navy Nozzle, Type G, 1/2" NPT	7-5
U.S. Navy Nozzle, Type SB, 1/2" NPT	7-5
Protectospray Nozzles, Type D4-A, 1/2" NPT.	7-6
Type AM4 WaterMist Nozzles, Open Type, 1/2" NPT	7-6
Type AM6, WaterMist Nozzles, Bulb Type, 1/2" NPT	7-7
Type AM10 WaterMist Nozzles, Open Type, 1/2" NPT	7-7
Type AM11 WaterMist Nozzles, Bulb Type, 1/2" NPT	7-8
Type AM22 WaterMist Nozzles, Bulb Type, 1/2" NPT	7-8
Type AM24 WaterMist Nozzles, Bulb Type, 1/2" NPT	7-9
Model FTR-1 Fixed Temperature Release for Deluge & Preaction Systems Wet or Dry Pilot Release Service, 1/2" NPT	7-9
Blow-Off Caps and Dust Caps for Mulsifyre Projectors and Nozzles	7-10
Blow-Off Plugs for Protectospray Nozzles, Model D-3	7-10
Miscellaneous Escutcheons	7-10
Typical Escutcheons	7-11
Sprinkler Head Cabinets.	7-12
G1 and G4 Sprinkler Guards, G1/S1 and G4/S3 Guards and Shields	7-12
G2 Guard, WS-2 Shield and WSG-2 Guard & Shield for ELO-231 Series	7-12
Special Services	7-12
Sprinkler Wrenches	7-13

Terms & Conditions

Table of Contents

Table of Contents

Section 8- Wet System Valves

Alarm Valves Model AV-1-300	8-1, 8-2
Shotgun CV-1FR Riser Check Valve	8-2
Residential Domestic Shutoff Valve	8-3
Riser Manifolds – Commercial & Residential	8-3
Model RC-1 Retard Chamber	8-3
Resi-Risers	8-4

Section 9 - Water Motor Alarms

Water Motor Alarm Model WMA-1	9-1
-------------------------------------	-----

Section 10 - Dry Pipe Valves

DPV-1 Dry Pipe Valve (4" and 6")	10-1
--	------

Section 11 - Quick Opening Devices

QRS Electronic Accelerator	11-1
Dry Pipe Valve Accelerator, Model ACC-1	11-1
Model DP-1, Dry Pilot Actuator	11-2

Section 12 - Air Maintenance Devices

Air Maintenance Devices	12-1
Accessories for Air Maintenance Devices	12-1

Section 13 - Deluge Valves & Accessories

Model DV-5 Deluge Valves, Diaphragm Style	13-1, 13-2
Model DP-1, Dry Pilot Actuator	13-3
Deluge Valve Accessories	13-3
Full Deluge Systems and Components	
DV-5 Deluge, Wet Pilot Actuation – 1½" thru 8"	13-4
DV-5 Deluge, Dry Pilot Actuation – 1½" thru 8"	13-5
DV-5 Deluge, Electric Actuation – 1½" thru 8"	13-6
Red-E-Cabinets, With DV-5 Valves, Deluge, Double Interlock and Preaction Systems in Cabinets	13-7 – 13-9
Red-E-Cabinets, With "MCC" Mist Control Center, Preassembled Fire Pump, Controller, Deluge Valve Cabinet.	13-10
Model DV-5 Valve Deluge and Preaction Pre-Trimmed	13-11

Section 14 - Preaction Systems

Full Preaction Systems and Components	
DV-5 Single Interlock, Wet Pilot Actuation, 1½" thru 8"	14-1
DV-5 Single Interlock, Dry Pilot Actuation, 1½" thru 8"	14-2
DV-5 Single Interlock, Electric Actuation, 1½" thru 8"	14-3
DV-5 Double Interlock, Electric/Pneumatic Actuation, 1½" thru 8"	14-4
DV-5 Double Interlock, Electric/Electric Actuation, 1½" thru 8"	14-5
Optional Equipment for Single Interlock, Preaction Systems, Supervised	14-6
Preaction Trim for Model DV-5	14-7, 14-8

Terms & Conditions

Table of Contents

Table of Contents

Section 15 - General Purpose Valves

Model CV-1F Grooved Check Valves	15-1
Model BFV-N Butterfly Valves - Wafer Style w/ Supervisory Switches - 250psi -	15-2
Model BFV-N Butterfly Valves - Lug Style w/ Supervisory Switches - 250psi -	15-2
Additional Wafer and Lug Lengths, w/PIVA	15-2
Model BFV-N Butterfly Valves - G x G, Gear Operated w/ Tamper Switches - 300psi -	15-3
Model PRV-1 Pressure Regulating Valve, 2" thru 8", 250 psi, Pilot Operated	15-3

Section 16 - Specialty Items

Valve System Accessories	16-1
Model F350 Sectional Control Accessories	16-1
Model F1321 Sight Flow Connection	16-1
Ball Drip Valves	16-1
Fill or Drip Cups	16-1
DD-1 (Drum Drip) Wiliag Drain	16-1
Manual Control Stations	16-2
Model G16AC812 Automatic Supervisory Air Supply	16-2
Water and Air Gauges	16-2
Fusible Links/Fire Door Links Type C	16-2
Zonecheck Flow Switch Tester	16-3
Model "A" Strainers and SS Baskets	16-3
Model "B-1" Strainer, Painted Finish and SS Baskets	16-4
Model "C" Strainer, Heavy Duty, Welded Body	16-5
Sprinkler Identification Signs	16-5
Restriction Unions	16-5

**Section 17 - Steel Pipe & Threaded Fittings
(Not Shown)**

Terms & Conditions

Table of Contents

Table of Contents

Section 18 - Grooved Products

#772 Rigid Coupling, w/Grade "A" EPDM Fire Protection Gasket Pre-Lubricated Gasket	18-1
#772 Rigid Tri-Seal Coupling, Recommended for dry pipe systems and freezer applications.	18-1
#705 Flexible Coupling, w/Grade "A" EPDM Fire Protection Gasket Pre-Lubricated Gasket	18-2
#705 Flexible Tri-Seal Coupling, w/Grade "E" EPDM Tri-Seal Gasket	18-2
#716 Reducing Coupling, w/Grade "E" EPDM Gasket Non-Lubricated.	18-3
#716 Reducing Coupling Plate	18-3
#71 Grooved Flange Adapter, with Grade "E" EPDM Gasket Non-Lubricated	18-4
Figure 71 Metal Washer.	18-4
Figure 71 Flange Adapter Nut, Bolt and Gasket Kit.	18-4
Replacement Gaskets	18-4
Nut, Bolt & Gasket Kit	18-5
Grinnell Gasket Lubricant	18-5
Grinnell Pipe Tape	18-5
#510 Fire Protection Grooved 90° Elbow.	18-6
#510S Fire Protection Short Pattern Grooved 90° Elbow	18-6
#510DE 90 W/ 1" Outlet.	18-6
#326 Drain 90 w/ 1" Outlet Schedule 10	18-6
#501 Fire Protection Grooved 45° Elbow.	18-7
#312 Grooved 22½° Elbow	18-7
#313 Grooved 11¼° Elbow	18-7
#519 Fire Protection Grooved Tee	18-8
#519S Fire Protection Short Pattern Grooved Tee.	18-8
#260 Grooved Cap, Cap w/ ½" Tap & Cap w/ 1" Tap.	18-9
#321 Grooved Reducing Tee	18-10
#550 Cast Concentric Reducer , #350 Fabricated Concentric Reducer	18-11
#341 Grooved x Flanged Adapter* 150# - Schedule 40	18-12
#342 Grooved x Flanged Adapter* 300# - Schedule 40	18-12
#320 Grooved x Thread Tee.	18-12
Standpipe Tee	18-12
#507/50L Bullhead Tee	18-12
#323 Grooved x Thread Reducing Tee	18-13
#327 Grooved Cross	18-13
#372 Reducer - Small End Threaded	18-14
#391 Groove x Male Thread- Adapter Nipple	18-14
#392 Groove x Groove- Adapter Nipple.	18-15
#393 Groove x Plain- Adapter Nipple	18-15
#730 Threaded Mechanical Tee with Domestic Grade "E" EPDM Gasket, Threaded Outlet	18-16
#730 Grooved Mechanical Tee Domestic with Grade "E" EPDM Gasket, Grooved Outlet.	18-17
#730 Threaded Mechanical Cross with Domestic Grade "E" EPDM Gasket	18-18
#730 Grooved Mechanical Cross with Grade "E" EPDM Gasket.	18-19
#40-5 Strap	18-19
Ada-Cap®	18-20
Grooved Butterfly Valves Fire Protection	18-20
Figure CV-1 Check Valve Grv x Grv.	18-20
Grinnell Import Fire Protection Products	
#577 Import Light Weight Rigid Coupling	18-21
#705 Import Fire Protection Flexible Coupling	18-21
# 510 Import Full Pattern - Grooved 90° Elbow	18-22
# 510S Import Short Pattern - Grooved 90° Elbow	18-22
# 501 Import Full Pattern - Grooved 45° Elbow	18-22
# 519 Import Full Pattern - Grooved Tee.	18-23
# 519S Import Short Pattern - Grooved Tee	18-23
# 260 Import Cap & Cap Tapped ½", 1" Painted.	18-23, 18-24
#150 Import Grooved Concentric Reducers - Cast.	18-24
#121 Import Grooved Reducing Tee - Cast.	18-24
Roll Groovers & Accessories	18-25
Roll Selection Chart.	18-26
Grooved Couplings & Fittings - Pieces Per Carton / Pieces Per Case	18-27 - 18-28

Terms & Conditions

Table of Contents

Table of Contents

Section 19 - CPVC

CPVC Pipe	19-1
Cap (Slip)	19-1
Coupling (Slip x Slip)	19-1
Reducing Coupling (Slip x Slip)	19-1
90° Elbow (Slip x Slip)	19-1
45° Elbow (Slip x Slip)	19-1
Tee (Slip x Slip x Slip)	19-1
Reducing Tee (Slip x Slip x Slip)	19-2
Cross (Slip x Slip x Slip x Slip)	19-2
Reducer Bushing (Slip x Slip)	19-2
Female Sprinkler Head Adapter (Slip x Fipt) with Brass Threaded Insert	19-2
Back-to-Back Tee, Sprinkler Head Adapter (Fipt x Fipt x Slip) with Brass Threaded Inserts	19-3
Back-to-Back Cross Sprinkler Head Adapter (Slip x Fipt) with Brass Threaded Inserts	19-3
Spigot Sprinkler Head Adapter (Slip x Fipt) with Brass Threaded Insert	19-3
Sprinkler Head 90° Elbow (Slip x Fipt) with Brass Threaded Insert	19-3
Sprinkler Head Tee (Slip x Female) with Brass Threaded Insert	19-3
CPVC to Female Adapter (slip x female) with Brass Threaded Insert	19-3
Male Adapter (Slip x Male) with Brass Threaded Insert	19-3
Grooved Coupling Adapter (Groove x Slip)	19-3
Primers & Cements	19-4
Accessories	19-4
Fire Stop	19-4
Rothenberger Tools	19-4
Tyco Fire Products CPVC Tools	19-4
McNulty Tools	19-4
Reed Tool Manufacturing	19-4

Terms & Conditions

Table of Contents

Table of Contents

Section 20 - Miscellaneous

Discontinued Valve Replacement Parts	
Model "AF" or "AG" - 4" Dry Pipe Valve (2002)	20-1
Model "AF" or "AG" - 6" Dry Pipe Valves (2002)	20-1
Model "H & K" - 4" Dry Pipe Valve (1988)	20-1
Model "H & K" - 6" Dry Pipe Valve (1988)	20-1
Model "D" - 2" & 2½" Dry Pipe Valve (1988)	20-2
Model "D" - 3" Dry Pipe Valve (1988)	20-2
Model "D" - 4" Dry Pipe Valve (1988)	20-2
Model "A" - 4" Deluge Valve (2001)	20-2
Model "A" - 6" Deluge Valve (2001)	20-2
Model DV-3 Deluge Valve (2007)	20-3
Model "F" and "G" - 2½" thru 8" Alarm Valve (2003)	20-3
Model "AF" 2", 2½" and 3" Dry Pipe Valves/Trim (2007)	20-4
Model F-302 & F-3021, 4" Dry Pipe Valve Replacement Parts (2002)	20-4
Model F-302 & F-3021, 6" Dry Pipe Valve Replacement Parts (2002)	20-4
Model A-2, 2" Dry Pipe Valve Replacement Parts (1999)	20-4
Model B Deluge Valve (2004)	20-5
Model DV-1 Deluge Valves (2007)	20-5
Model E Alarm Check Valve 8" - (1999)	20-6
Model F Alarm Check Valves 4" & 6" - (1999)	20-6
Model A-1 Dry Pipe Valves, Flange x Flange 4" & 6" (2002)	20-6
Model A-1 Dry Pipe Valves, Flange x Groove 4" & 6" (2002)	20-6
Model F and G Dry Pipe Valves 3", 4" & 6" (1985)	20-7
Model "A-1" Preaction Valve (2003)	20-7
Model "D" - Deluge Valve 3", 6" & Coils - (Electromatic) (2002)	20-8
Model BB - Exhauster (2006)	20-8
Model TCV-1 - Thermal Control Valve (2006)	20-8
Discontinued Sprinkler Accessories	
A Royal Flush Concealed Ceiling Plate Assembly (2002)	20-9
Model A Metal Screw-On Escutcheon Assemblies (2002)	20-9
Sprinkler Head Guards and Shields (2002)	20-9
Replacement Cover Plate for F690/F692 & Star Stealth S110/S112 (2002)	20-9
Aquarius Escutcheon Plates (2001)	20-9
Starmist Escutcheons (2002)	20-10
PH2, Institutional Pendant, Standard Response Sprinkler, K=5.6, ½" N.P.T. (2005)	20-10
PH5, Institutional Horizontal Sidewall, Standard Response Sprinkler, K=5.6, ½" N.P.T. (2005)	20-11

Terms & Conditions

Table of Contents

Table of Contents

Section 21 - Electrical

Electrical	
Waterflow Switches	21-1
Tamper Switches - OS&Y	21-1
Tamper Switches - Butterfly/PIV	21-1
Pressure Switches	21-1
Explosion Proof Switches	21-1
Switches for Copper Systems	21-1
Electric Bells	21-1
Weatherproof Backbox	21-1
Horns	21-1
Release Panel	21-1
Batteries for Release Panel	21-1
Corrosion Inhibiting Device	21-1
Corrosion Monitoring Station	21-1
Solenoid Valves	
Ordinary Location	21-1
Hazardous Location	21-1
Heat Detectors	21-2
Horn Strobes	21-2
General Air Products	
Air Compressors	21-2, 21-3
Magnetic Line Starter	21-3
Riser Mount Kits - Universal Bracket	21-3
Dry Air Pacs	21-3
Accessories	21-3
Quell Fire Sprinkler Systems Products	
Thermocable LHD - Linear Heat Detection Wire, PVC Jacket (Vinyl)	21-3
Mounting Straps, Temperatures -40°F to 185°F	21-3, 21-4
Mounting Clips and Clamps, Temperatures -40°F to 185°F	21-4
GuideWire Mounting Accessories	21-5
Surface Mounting	21-5
Installation	21-5
Cable Connecting Accessories	21-5
Cable Splicing Accessories	21-6
Fire Alarm Control / Releasing Panel - Modules	21-6

Terms & Conditions

Table of Contents

Table of Contents

Section C - Valves and Hose Equipment

Kennedy Valves	
O.S.&Y. Gate Valve UL/FM Resilient Wedge w/ 3/4" Tap and Plug - Model #4068A	C-1
O.S.&Y. Valve Flanged x Grooved - Model #7092A.	C-1
Grooved Check Valve - Model #426	C-1
Iron Body Swing Check Valves UL/FM Flanged 175 PSI – Model 126A.	C-1
Wafer Check Valves UL/FM 300 PSI – Model 706	C-1
Flanged PIV Non Rising Stem Gate Valve Resilient Wedge – Model 4701	C-1
PIV, NRS Gate Valve UL/FM Mechanical Joint w/Accessories Resilient Wedge – Model 4071	C-1
#01G - Grooved BFV	C-1
#01G - Wafer BFV	C-1
Wall Post Indicator Model 641-13 Includes Stem and Coupling	C-1
Vertical Post Indicator (Formerly Model #741)	C-1
Babbitt Valve Chainwheels	
Cast Iron Standard Chainwheel	C-1
Epoxy Coated Corrosion Resistant Chainwheel	C-1
Hot Dipped Galvanized Standard Chain	C-1
United Brass Bronze Valves	
Globe Valves	C-2
Swing Checks	C-2
Ball Valves	C-2
Angle Valves	C-2
OS&Y Valves	C-2
Milwaukee Butterball Valves	
Valve with two (2) tamper switches	C-2
Valve only	C-2
Trim Valves	
Globe Valves	C-2
Swing Checks	C-2
Ball Valves	C-2
Angle Valves	C-2
Hose Valves & FDC's	
Hose Valves	C-3
STORZ Equipment	C-3
Fire Department Connections	C-3
Crocker Standpipe and Hose Equipment	
Hose Rack Units	C-3
Adjustable Fog Nozzles	C-3
Fire Hose	C-3
Hose Valves	C-3
Pressure Restricting Hose Valves	C-3
Fire Department Inlet Connections	C-4, C-5
Check Valves	C-5
Storz Connections (with Plate & Cap)	C-5
Roof Manifolds (Body Only)	C-5
Cabinets	C-5
Guardian Standpipe and Hose Equipment	
Hose Rack Units	C-6
Adjustable Fog Nozzles	C-6
Fire Hose	C-6
Hose Valves	C-6
Reducer	C-6
Pressure Restricting Hose Valves	C-6, C-7
Fire Department Inlet Connections	C-7
Check Valves	C-7
Storz Connections (with Plate & Cap)	C-7
Roof Manifolds (Body Only)	C-8
Cabinets	C-8

Terms & Conditions

Table of Contents

Table of Contents
Section "D" Backflow

Ames	
Model Maxim M200 With FxG OS&Y Valve	D-1
Model Maxim M200 With Grooved Butterfly Valve	D-1
Model Maxim M300 DCDA With FxG OS&Y Valve (GPM Meter)	D-1
Model Maxim M300 DCDA With FxG OS&Y Valve (CFM Meter)	D-1
Model Maxim M300 DCDA With Grooved Butterfly Valve (GPM Meter)	D-1
Model Maxim M300 DCDA With Grooved Butterfly Valve (CFM Meter)	D-1
Model Maxim M400 With FxG OS&Y Valve	D-1
Model Maxim M400N With Grooved Butterfly Valve	D-1
Model Maxim M500 RPDA With FxG OS&Y Valve (GPM Meter)	D-1
Model Maxim M500 RPDA With FxG OS&Y Valve (CFM Meter)	D-1
Model Maxim M500N RPDA With Grooved Butterfly Valve (GPM Meter)	D-1
Model Maxim M500N RPDA With Grooved Butterfly Valve (CFM Meter)	D-1
Model 1000 DCV Detector Check	D-1
Model 1005 DCV Detector Check	D-1
Model 2000B Brass Double Check Assy.	D-1
Model 3000B Brass Assembly	D-2
Model 4000B Brass Reduced Pressure Backflow Assy.	D-2
Model 2000 SS Double Check Backflow Assembly	D-2
Model 3000 SS Double Check Detector Backflow Assembly	D-2
Model 4000 SS Reduced Pressure Backflow Prevention Assembly	D-2
Model 5000 SS Reduced Pressure Detector Assembly	D-2
Air Gap Drains Model 2001 SS Double Check Assembly	D-2
Maxim/Colt Air Gap Drains	D-2
Colt	
Model C200 Double Check Assembly	D-3
Model C300 Double Check Detector Assembly	D-3
Model C400 Reduced Pressure Assembly	D-3
Model C500 Reduced Pressure Detector Assembly	D-3
Febco	
Model 850 Double Check Assembly	D-3
Model 870V (Vertical) Double Check Assembly	D-3
Model 856 Double Check Detector Assembly	D-3
Model 876V (Vertical) Double Check Detector Assembly (w/ O.S.&Y. Valves)	D-4
Model 860 Reduced Pressure Assembly (w/ O.S.&Y. Valves)	D-4
Model 880V Reduced Pressure Assembly	D-4
Model 826 Reduced Pressure Detector Assembly	D-4
Model 830 Double Check Assembly	D-4
Model 831 Double Check Assembly	D-4
Model 850U Double Check Assembly	D-4
Model 850 Double Check Assembly	D-4
Model 860 Reduced Pressure Assembly	D-4
Model 825 Y Reduced Pressure Assembly	D-4
Air Gaps Drains	D-4
Watts Regulator (Small Backflow Preventors)	
Model 007 LF, Model 007 QT Double Check Backflow	D-5
Model 009 LF, Model 009 QT Reduced Pressure Backflow.	D-5
Air Gap Drains	D-5
Backflow Repair Kits	D-5
Model 709 Double Check Valve Backflow Assembly	D-5
Model 007/709 Double Check Detector Assembly	D-5
Model 009/909 Reduced Pressure Zone Backflow Preventor	D-5, D-6
Model 909 Reduced Pressure Zone Backflow Detector Assembly	D-6

Terms & Conditions

Table of Contents

Table of Contents
Section "F" Pipe & Accessories

Terms & Conditions

Table of Contents

SCI	SCI Coop-Let F.T. & Grooved	F-1
Merit	Grooved Outlets	F-2
	Adjustable Drop Nipples	F-2
	Flexhead Drop Nipples	F-2
	Welded Flange	F-2
	Test/Drain Assemblies	F-2
	Sight Drains	F-2
	Bolt, Nut, Gasket Kits	F-2
	Red Rubber Gaskets	F-3
	Split Rings Plastic Floor and Ceiling Plates	F-3
	Flanged Fittings	
	Flanged 90° Elbow	F-3
	Flanged 45° Elbow	F-3
	Flanged Straight Tee	F-3
	Flanged Reducing Tee	F-3
	Cast Iron Companion Flange	F-4
	Flanged Concentric Reducer	F-4
	Blind Flange	F-4
	Long Radius Flanged 90° Elbow	F-4
	Floor Flange	F-4
	Flanged Reducing 90° Elbow	F-4
	Flanged Bull Tee	F-4
	Flanged Eccentric Reducer	F-4
	Ductile Iron Fittings	
	#811 Ductile Iron 90° Elbows	F-4
	#813 Ductile Iron 45° Elbows	F-4
	#814 Ductile Iron Tees	F-4
	#818 Ductile Iron Couplings	F-5
	#820 Ductile Iron Caps	F-5
	#817 Ductile Iron Crosses	F-5
	#719 Ductile Iron Plugs	F-5
	#825 Ductile Iron Extension Pieces	F-5
	#817 Ductile Iron Reducing Crosses	F-5
	#827 Ductile Iron Hex Bushings	F-5
	#816 Ductile Iron Reducing Couplings	F-5
	#830 Ductile Iron Unions	F-5
	#812 Ductile Iron Reducing 90° Elbows	F-5
	Malleable Iron Plug	F-5
	#815 Ductile Iron Reducing Tees	F-6
	Central Sprinkler California Fittings	F-6
	Standard Black Nipple	F-7
	Extra Heavy Black Nipple	F-8
	Galvanized Nipple	F-8

Table of Contents
Section "H" Hangers

Erico Hangers	
CPVC Hangers & Surge Restraints	H-1
CPVC Hangers - Head Set Bracket	H-1
Heavy Duty Swivel Hanger - Model 115	H-1
Beam Clamps - Model 300	H-1
Heavy Duty Beam Clamps - Model 547	H-1
Steel C-Clamp - Model 200	H-1
Eye Sockets - Model 37	H-1
300-C Retaining Strap (Bulk Units)	H-1
Eye Socket Offset - Model 38	H-1
Wide Flange Purlin Clamp - Model 315	H-1
Steel Wood Drive Screw - Model 43	H-1
Steel Rod Coupling - Model 25	H-2
Knurled Hanger Inserts - Model 100N	H-2
Coach Screw Rod Machine Thread - Model 41	H-2
Lag Screw - Model 42	H-2
Clevis Hanger Standard - Model 400	H-2
Concrete Insert Nut - Model 355N	H-2
Nail Plate - Model 30482	H-2
Plastic Rod Button - Model 15	H-2
Toggle - Model 148	H-2
Pipe Clamp Standard - Model 450	H-2
Riser Clamp - Model 510	H-2
Steel Side Beam Attachment - Model 325	H-3
Tapped Side Beam Steel Connector - Model 328	H-3
Steel Wall Plate - Model 365	H-3
Yook U Type Hanger - Model 135 (Fits 1" & 1¼" Pipe)	H-3
Yook Wrap-a-Round U Type Hanger Model 137	H-3
Strut Clamp - Model RIGD	H-3
Multi-Flange Rod Hanger	H-3
Tolco for CPVC	
Hangers for CPVC Plastic Pipe, Model 22, Model 23, Model 24	H-4
Ring Hangers - Model 200	H-4
Tolco Earthquake Bracing	
Fast Clamp Sway Brace Attachment - #1000 & #1001	H-4
Longitudinal 4-way Brace Attachment - #907	H-4
Non-Threaded Structural Attachment - #909	H-4
Threaded Structural Attachment - #910	H-4
Threaded Straight Fittings - #975	H-4
Pipe Clamp for Sway Bracing - #4A	H-4
Beam Clamp Retaining Straps - #69	H-4
Threaded Rod Company	
All Thread Rod	H-5
All Thread Stud	H-5
Elco Ind. - Hanger Mate	
Wood, Metal, Concrete Application	H-5
Drive Sockets	H-5
Sammy Super Screw	
Steel, Concrete, Wood	H-6
Nut Drivers	H-6
Sammy Screw Sidewinder	H-6
Sammy Screw X-Press	H-6
Swivel-Head Sammy Screw - Wood and Steel	H-6
Afcon	
Sway Brace Clamp Model E-001, Model 410, Model E-020	H-7
Threaded Attachment End - Model E-070	H-7
Locking Attachment - Model 077	H-7
U-Bolt With Nut - Model 240	H-7
Surge Restrainer	H-7
Afcon for CPVC	H-7

Terms & Conditions

Table of Contents

Table of Contents
Section "J" Lubricants

Terms & Conditions

Table of Contents

LA-CO Industries	
Thread Sealant Paste	J-1
Gasket Lubricant	J-1
Cutting Oil	J-1
Hand Cleaner	J-1
Tape	J-1
Pipe Markers (Valve Action)	J-1
Flux	J-1
Permabond International	
Perma-Lok	J-1
Noble Company "Fire Fighter"	
Anti-Freeze - Glycol for Steel Pipe (pre-mix, concentrate, pure)	J-1
Gasket Lubricant	
Silicon Gasket Lubricant	J-1
FPPI Sealant	
FPPI PipeFit Thread Sealant	J-2
FPPI PipeFit AS Anaerobic Sealant	J-2
Oatey Great White Thread Selant	J-2

Section "K" Misc.

MIFAB / PMR	
Access Doors	K-1
Acudor Products	
Access Door, Flush, Prime coated steel, UF5000	K-1
Central Casting	
Boxes	K-1

Price Book - Section 1 Standard Spray Sprinklers

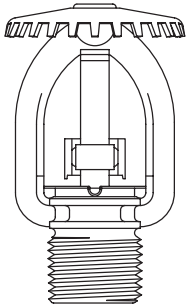
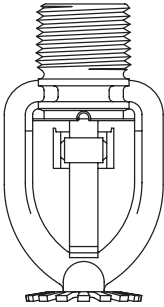
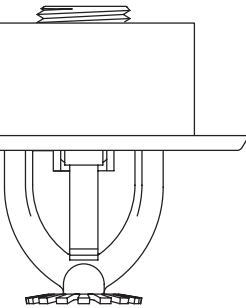
Model TY-L, K=5.6, 1/2" NPT						
100 Box Quantity (Upright 21.5 lbs/box (SIN TY3111), Pendent 19 lbs/box (SIN TY3211))						
	C.O.	Upright	Pendent	Finish	Temperature	List Price
		53-111-1-165	53-112-1-165	Brass	165°F/74°C	\$19.50
		53-111-1-212	53-112-1-212	Brass	212°F/100°C	\$19.50
		53-111-1-280	53-112-1-280	Brass	280°F/138°C	\$19.50
		53-111-9-165	53-112-9-165	Chrome	165°F/74°C	\$24.00
	▶	53-111-9-212	53-112-9-212	Chrome	212°F/100°C	\$24.00
	▶	53-111-9-280	53-112-9-280	Chrome	280°F/138°C	\$24.00
	▶	53-111-7-165	53-112-7-165	Lead Coated	165°F/74°C	\$50.75
	▶	53-111-7-212	53-112-7-212	Lead Coated	212°F/100°C	\$50.75
	▶	53-111-7-280	53-112-7-280	Lead Coated	280°F/138°C	\$50.75
	▶	53-111-6-165	53-112-6-165	Wax Coated	165°F/74°C	\$48.50
	▶	53-111-6-212	53-112-6-212	Wax Coated	212°F/100°C	\$48.50
	▶	53-111-8-165	53-112-8-165	Wax over Lead Coated	165°F/74°C	\$68.00
▶	53-111-8-212	53-112-8-212	Wax over Lead Coated	212°F/100°C	\$68.00	
	Recessed Escutcheons (Order Separately)					
		56-705-2-010	1/2" Brass Plated (Style 20)			\$7.70
		56-705-9-010	1/2" Chrome Plated (Style 20)			\$5.30
	56-705-4-010	1/2" White Color Coated (Style 20)			\$5.30	
	Sprinkler Wrench					
		56-000-1-849	W-Type 9 Wrench			\$36.50
	56-000-1-948	W-Type 10 Wrench (Recessed Only)			\$56.75	
Technical Data Sheet: TFP110						

See latest Technical Data Sheets for specific Approvals, Listings, Design Parameters & available finishes. Sprinkler heads & escutcheons are priced separately unless otherwise noted.

Items marked "C.O." are made to order and may require longer delivery times. Please contact customer service for availability.

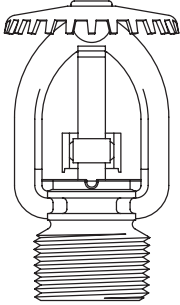
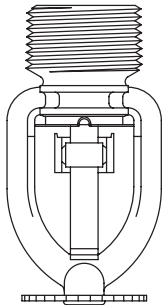
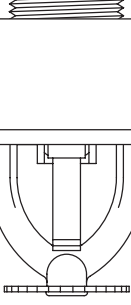
Model TY-L, K=8.0, 3/4" Male NPT						
100 Box Quantity (Upright 21.5 lbs/box (SIN TY4111), Pendent 21.5 lbs/box (SIN TY4211))						
	C.O.	Upright	Pendent	Finish	Temperature	List Price
		53-101-1-165	53-102-1-165	Brass	165°F/74°C	\$33.25
	▶	53-101-1-212	53-102-1-212	Brass	212°F/100°C	\$33.25
		53-101-1-280	53-102-1-280	Brass	280°F/138°C	\$33.25
		53-101-9-165	53-102-9-165	Chrome	165°F/74°C	\$38.00
	▶	53-101-9-212	53-102-9-212	Chrome	212°F/100°C	\$38.00
	▶	53-101-7-165	53-102-7-165	Lead Coated	165°F/74°C	\$80.50
	▶	53-101-7-212	53-102-7-212	Lead Coated	212°F/100°C	\$80.50
	▶	53-101-7-280	53-102-7-280	Lead Coated	280°F/138°C	\$80.50
	▶	53-101-6-165	53-102-6-165	Wax Coated	165°F/74°C	\$76.00
	▶	53-101-6-212	53-102-6-212	Wax Coated	212°F/100°C	\$76.00
	▶	53-101-6-280	53-102-6-280	Wax Coated	280°F/138°C	\$76.00
	▶	53-101-8-165	53-102-8-165	Wax over Lead Coated	165°F/74°C	\$103.00
▶	53-101-8-212	53-102-8-212	Wax over Lead Coated	212°F/100°C	\$103.00	
	Recessed Escutcheons (Order Separately)					
		56-705-2-011	3/4" Brass Recessed (Style 30)			\$7.70
		56-705-9-011	3/4" Chrome Recessed (Style 30)			\$5.50
	56-705-4-011	3/4" White Recessed (Style 30)			\$5.50	
	Sprinkler Wrench					
		56-000-1-849	W-Type 9 Wrench			\$36.50
	56-000-1-948	W-Type 10 Wrench (Recessed Only)			\$56.75	
Technical Data Sheet: TFP110						

See latest Technical Data Sheets for specific Approvals, Listings, Design Parameters & available finishes. Sprinkler heads & escutcheons are priced separately unless otherwise noted.

Items marked "C.O." are made to order and may require longer delivery times. Please contact customer service for availability.

Price Book - Section 1 Standard Spray Sprinklers

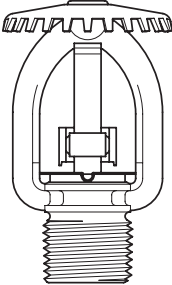
Model TY-L, K=8.0, 1/2" Male NPT, Pendent, Recessed Pendent and Upright Sprinklers						
100 Box Quantity (Upright 21.5 lbs/box (SIN TY4811), Pendent 21.5 lbs/box (SIN TY4911))						
	<i>C.O.</i>	<i>Upright</i>	<i>Pendent</i>	<i>Finish</i>	<i>Temperature</i>	<i>List Price</i>
		53-106-1-165	53-107-1-165	Brass	165°F/74°C	\$59.00
	▶	53-106-1-212	53-107-1-212	Brass	212°F/100°C	\$59.00
		53-106-1-280	53-107-1-280	Brass	280°F/138°C	\$59.00
	▶	53-106-7-165	53-107-7-165	Lead Coated	165°F/74°C	\$110.00
	▶	53-106-7-212	53-107-7-212	Lead Coated	212°F/100°C	\$110.00
	▶	53-106-7-280	53-107-7-280	Lead Coated	280°F/138°C	\$110.00
	▶	53-106-6-165	53-107-6-165	Wax Coated	165°F/74°C	\$105.00
	▶	53-106-6-212	53-107-6-212	Wax Coated	212°F/100°C	\$105.00
	▶	53-106-6-280	53-107-6-280	Wax Coated	280°F/138°C	\$105.00
	▶	53-106-8-165	53-107-8-165	Wax over Lead	165°F/74°C	\$129.50
	▶	53-106-8-212	53-107-8-212	Wax over Lead	212°F/100°C	\$129.50
	Recessed Escutcheons (Order Separately)					
		56-705-2-010	1/2" Brass Plated (Style 20)			\$7.70
		56-705-9-010	1/2" Chrome Plated (Style 20)			\$5.30
		56-705-4-010	1/2" White Color Coated (Style 20)			\$5.30
Sprinkler Wrench						
		56-000-1-849	W-Type 9 Wrench			\$36.50
		56-000-1-948	W-Type 10 Wrench (Recessed Only)			\$56.75
Technical Data Sheet: TFP110						

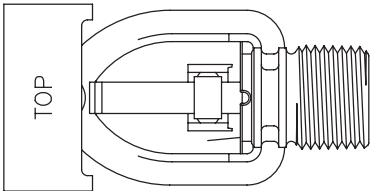
Model TY-L, K=5.6, 1/2" NPT, Horizontal Sidewall Sprinkler						
100 Box Quantity (19 lbs/box) (SIN TY3311)						
	<i>C.O.</i>	<i>Horiz. Sidewall</i>	<i>Finish</i>	<i>Temperature</i>	<i>List Price</i>	
		53-113-1-165	Brass	165°F/74°C	\$34.75	
	▶	53-113-1-212	Brass	212°F/100°C	\$34.75	
		53-113-1-280	Brass	280°F/138°C	\$34.75	
	▶	53-113-9-165	Chrome	165°F/74°C	\$38.50	
		53-113-9-212	Chrome	212°F/100°C	\$38.50	
		53-113-9-280	Chrome	280°F/138°C	\$38.50	
Sprinkler Wrench						
		56-000-1-849	W-Type 9 Wrench			\$36.50
Technical Data Sheet: TFP120						

See latest Technical Data Sheets for specific Approvals, Listings, Design Parameters & available finishes. Sprinkler heads & escutcheons are priced separately unless otherwise noted.

Items marked "C.O." are made to order and may require longer delivery times. Please contact customer service for availability.

Model TY-FRL , K=2.8, 1/2" NPT, Quick Response Sprinkler

100 Box Quantity (Upright 20 lbs/box (SIN TY1121), Pendent 18.5 lbs/box (SIN TY1221))

Section 1
Standard Spray Sprinklers

Section 2
Extended Coverage Sprinklers

Section 3
Storage Sprinklers

Section 4
Residential Sprinklers

Section 5
Dry Sprinklers

Section 6
Special Sprinklers

Section 7
Nozzles and Sprinkler Accessories

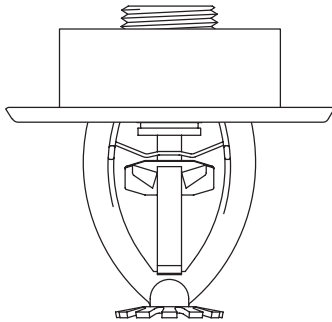
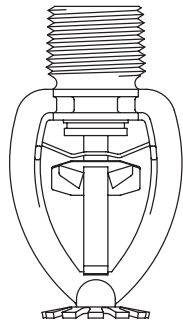
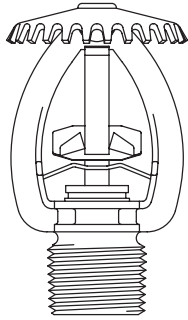

C.O.	Upright	Pendent	Finish	Temperature	List Price
	58-973-1-165	58-981-1-165	Brass	165°F/74°C	\$72.25
	58-973-1-212	58-981-1-212	Brass	212°F/100°C	\$72.25
	58-973-9-165	58-981-9-165	Chrome	165°F/74°C	\$78.00
	58-973-9-212	58-981-9-212	Chrome	212°F/100°C	\$78.00

Recessed Escutcheons (Order Separately)

	56-705-2-010	1/2" Brass (Style 20)	\$7.70
	56-705-9-010	1/2" Chrome (Style 20)	\$5.30
	56-705-4-010	1/2" White (Style 20)	\$5.30

Sprinkler Wrench

	56-000-1-849	W-Type 9 Wrench	\$36.50
	56-798-1-001	W-Type 12 (Recessed Only)	\$52.00

Technical Data Sheet: TFP130

See latest Technical Data Sheets for specific Approvals, Listings, Design Parameters & available finishes. Sprinkler heads & escutcheons are priced separately unless otherwise noted.

Items marked "C.O." are made to order and may require longer delivery times. Please contact customer service for availability.

Price Book - Section 1 Standard Spray Sprinklers

Model TY-FRL, K=5.6, 1/2" NPT, Quick Response Sprinkler							Section 1 Standard Spray Sprinklers
100 Box Quantity (Upright 20 lbs/box (SIN TY3121), Pendent 18.5 lbs/box (SIN TY3221))							
<i>C.O.</i>	<i>Upright</i>	<i>Pendent</i>	<i>Description</i>	<i>Temperature</i>	<i>List Price</i>		
	58-974-1-165	58-982-1-165	Brass	165°F/74°C	\$64.25		
	58-974-1-212	58-982-1-212	Brass	212°F/100°C	\$64.25		
	58-974-9-165	58-982-9-165	Chrome	165°F/74°C	\$70.00		
	58-974-9-212	58-982-9-212	Chrome	212°F/100°C	\$70.00		
Recessed Escutcheons (Order Separately)							
	56-705-2-010	1/2" Brass (Style 20)			\$7.70		
	56-705-9-010	1/2" Chrome (Style 20)			\$5.30		
	56-705-4-010	1/2" White (Style 20)			\$5.30		
Sprinkler Wrench							
	56-000-1-849	W-Type 9 Wrench			\$36.50		
	56-798-1-001	W-Type 12 (Recessed Only)			\$52.00		
Technical Data Sheet: TFP130							

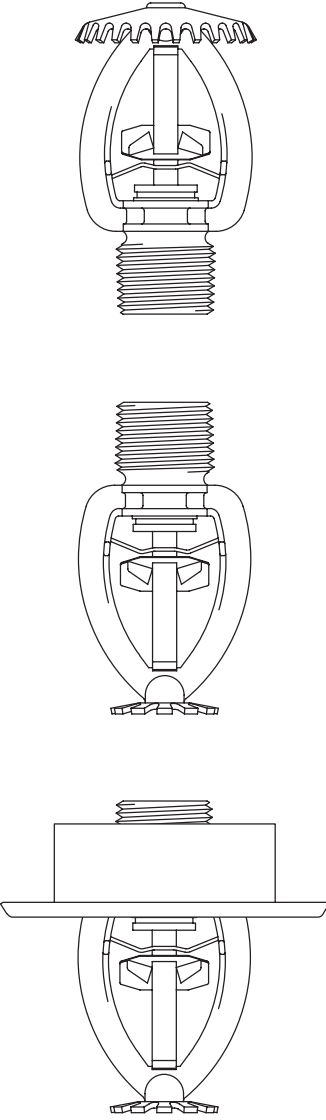

See latest Technical Data Sheets for specific Approvals, Listings, Design Parameters & available finishes. Sprinkler heads & escutcheons are priced separately unless otherwise noted.

Items marked "C.O." are made to order and may require longer delivery times. Please contact customer service for availability.

Model TY-FRL, K=8.0, 3/4" NPT, Quick Response Sprinkler

100 Box Quantity (Upright 25 lbs/box (SIN TY4121), Pendent 25 lbs/box (SIN TY4221))

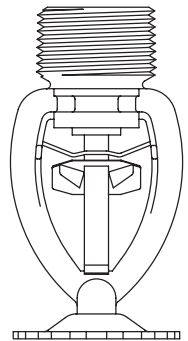
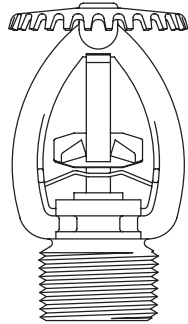

C.O.	Upright	Pendent	Description	Temperature	List Price
	58-174-1-165	58-172-1-165	Brass	165°F/74°C	\$75.00
	58-174-1-212	58-172-1-212	Brass	212°F/100°C	\$75.00
	58-174-9-165	58-172-9-165	Chrome	165°F/74°C	\$90.75
	58-174-9-212	58-172-9-212	Chrome	212°F/100°C	\$90.75

Sprinkler Wrench

56-000-1-849	W-Type 9 Wrench	\$36.50
---------------------	-----------------	---------

Technical Data Sheet: TFP130

Model TY-FRL, K=5.6, 1/2" NPT, Horizontal Sidewall Quick Response Sprinkler

100 Box Quantity (20 lbs/box) (SIN TY3321)

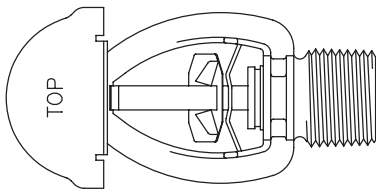

C.O.	Horiz. Sidewall	Finish	Temperature	List Price
	58-946-1-165	Brass	165°F/74°C	\$82.00
▶	58-946-1-212	Brass	212°F/100°C	\$82.00
	58-946-9-165	Chrome	165°F/74°C	\$90.25
▶	58-946-9-212	Chrome	212°F/100°C	\$90.25

Sprinkler Wrench

56-000-1-849	W-Type 9 Wrench	\$36.50
---------------------	-----------------	---------

Technical Data Sheet: TFP140

See latest Technical Data Sheets for specific Approvals, Listings, Design Parameters & available finishes. Sprinkler heads & escutcheons are priced separately unless otherwise noted.

Items marked "C.O." are made to order and may require longer delivery times. Please contact customer service for availability.

Price Book - Section 1 Standard Spray Sprinklers

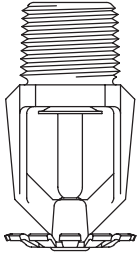
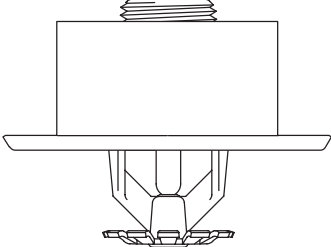
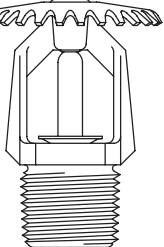
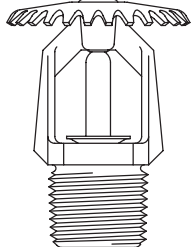
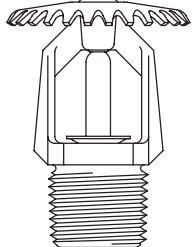
TY-B, 5mm Bulb, K=5.6, 1/2" NPT Pendent, Recessed Pendent and Upright						
100 Box Quantity (Upright 18 lbs/box (SIN TY3151), Pendent 17 lbs/box (SIN TY3251))						
	<i>C.O.</i>	<i>Upright</i>	<i>Pendent</i>	<i>Finish</i>	<i>Temperature</i>	<i>List Price</i>
	▶	57-570-1-135	57-571-1-135	Brass	135°F/57°C	\$15.00
		57-570-1-155	57-571-1-155	Brass	155°F/68°C	\$14.25
	▶	57-570-1-175	57-571-1-175	Brass	175°F/79°C	\$15.00
		57-570-1-200	57-571-1-200	Brass	200°F/93°C	\$14.25
		57-570-1-286	57-571-1-286	Brass	286°F/141°C	\$14.25
	▶	57-570-1-360	57-571-1-360	Brass	360°F/182°C	\$17.75
	▶	57-570-9-135	57-571-9-135	Chrome	135°F/57°C	\$17.75
		57-570-9-155	57-571-9-155	Chrome	155°F/68°C	\$16.75
	▶	57-570-9-175	57-571-9-175	Chrome	175°F/79°C	\$17.75
	▶	57-570-9-200	57-571-9-200	Chrome	200°F/93°C	\$17.75
	▶	57-570-9-286	57-571-9-286	Chrome	286°F/141°C	\$17.75
	▶	57-570-9-360	57-571-9-360	Chrome	360°F/182°C	\$21.00
	▶	57-570-4-135	57-571-4-135	White	135°F/57°C	\$17.75
		57-570-4-155	57-571-4-155	White	155°F/68°C	\$16.75
	▶	57-570-4-175	57-571-4-175	White	175°F/79°C	\$17.75
		57-570-4-200	57-571-4-200	White	200°F/93°C	\$17.75
	▶	57-570-4-286	57-571-4-286	White	286°F/141°C	\$17.75
	▶	57-570-4-360	57-571-4-360	White	360°F/182°C	\$21.00
		57-570-X-155	57-571-X-155	Black	155°F/68°C	\$43.00
		57-570-X-200	57-571-X-200	Black	200°F/93°C	\$43.00
	▶	57-570-7-135	57-571-7-135	Lead Coated	135°F/57°C	\$46.50
	▶	57-570-7-155	57-571-7-155	Lead Coated	155°F/68°C	\$46.50
	▶	57-570-7-175	57-571-7-175	Lead Coated	175°F/79°C	\$46.50
	▶	57-570-7-200	57-571-7-200	Lead Coated	200°F/93°C	\$46.50
	▶	57-570-7-286	57-571-7-286	Lead Coated	286°F/141°C	\$46.50
	▶	57-570-7-360	57-571-7-360	Lead Coated	360°F/182°C	\$46.50
	▶	57-570-6-135	57-571-6-135	Wax Coated	135°F/57°C	\$43.00
	▶	57-570-6-155	57-571-6-155	Wax Coated	155°F/68°C	\$43.00
	▶	57-570-6-175	57-571-6-175	Wax Coated	175°F/79°C	\$43.00
	▶	57-570-6-200	57-571-6-200	Wax Coated	200°F/93°C	\$43.00
	▶	57-570-6-286	57-571-6-286	Wax Coated	286°F/141°C	\$43.00
	▶	57-570-8-135	57-571-8-135	Wax over Lead Coated	135°F/57°C	\$61.75
	▶	57-570-8-155	57-571-8-155	Wax over Lead Coated	155°F/68°C	\$61.75
	▶	57-570-8-175	57-571-8-175	Wax over Lead Coated	175°F/79°C	\$61.75
	▶	57-570-8-200	57-571-8-200	Wax over Lead Coated	200°F/93°C	\$61.75
	▶	57-570-8-286	57-571-8-286	Wax over Lead Coated	286°F/141°C	\$61.75
	Recessed Escutcheons (Order Separately)					
	56-701-2-010	1/2" Brass Plated (Style 10)				\$7.70
	56-701-9-010	1/2" Chrome Plated (Style 10)				\$5.30
	56-701-4-010	1/2" White Color Coated (Style 10)				\$5.30
	56-701-6-010	1/2" Black Color Coated (Style 10)				\$6.90
Sprinkler Wrench						
	56-000-6-387	W-Type 6 Wrench				\$40.75
	56-850-4-001	W-Type 7 Wrench (Recessed Only)				\$68.25
Technical Data Sheet: TFP151						

See latest Technical Data Sheets for specific Approvals, Listings, Design Parameters & available finishes. Sprinkler heads & escutcheons are priced separately unless otherwise noted.

Items marked "C.O." are made to order and may require longer delivery times. Please contact customer service for availability.

TY-B, 5mm Bulb, K=8.0, 1/2" NPT, Pendent and Upright Sprinklers,

100 Box Quantity (Upright 21 lbs/box (SIN TY4851), Pendent 21 lbs/box (SIN TY4951))

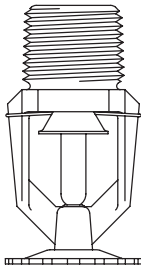
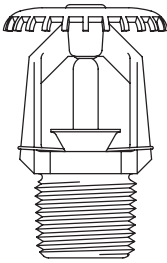
	<i>C.O.</i>	<i>Upright</i>	<i>Pendent</i>	<i>Finish</i>	<i>Temperature</i>	<i>List Price</i>
	▶	57-560-1-135	57-561-1-135	Brass	135°F/57°C	\$20.75
		57-560-1-155	57-561-1-155	Brass	155°F/68°C	\$20.75
	▶	57-560-1-175	57-561-1-175	Brass	175°F/79°C	\$20.75
		57-560-1-200	57-561-1-200	Brass	200°F/93°C	\$20.75
		57-560-1-286	57-561-1-286	Brass	286°F/141°C	\$20.75
	▶	57-560-1-360	57-561-1-360	Brass	360°F/182°C	\$23.00
	▶	57-560-9-135	57-561-9-135	Chrome	135°F/57°C	\$23.00
		57-560-9-155	57-561-9-155	Chrome	155°F/68°C	\$23.00
	▶	57-560-9-175	57-561-9-175	Chrome	175°F/79°C	\$23.00
	▶	57-560-9-200	57-561-9-200	Chrome	200°F/93°C	\$23.00
	▶	57-560-9-286	57-561-9-286	Chrome	286°F/141°C	\$23.00
	▶	57-560-9-360	57-561-9-360	Chrome	360°F/182°C	\$25.75
	▶	57-560-4-135	57-561-4-135	White	135°F/57°C	\$23.00
		57-560-4-155	57-561-4-155	White	155°F/68°C	\$23.00
	▶	57-560-4-175	57-561-4-175	White	175°F/79°C	\$23.00
	▶	57-560-4-200	57-561-4-200	White	200°F/93°C	\$23.00
	▶	57-560-4-286	57-561-4-286	White	286°F/141°C	\$23.00
	▶	57-560-4-360	57-561-4-360	White	360°F/182°C	\$25.75
Sprinkler Wrench						
		56-000-6-387	W-Type 6 Wrench			\$40.75
Technical Data Sheet: TFP151						
Section 1 Standard Spray Sprinklers						
Section 2 Extended Coverage Sprinklers						
Section 3 Storage Sprinklers						
Section 4 Residential Sprinklers						
Section 5 Dry Sprinklers						
Section 6 Special Sprinklers						
Section 7 Nozzles and Sprinkler Accessories						

See latest Technical Data Sheets for specific Approvals, Listings, Design Parameters & available finishes. Sprinkler heads & escutcheons are priced separately unless otherwise noted.

Items marked "C.O." are made to order and may require longer delivery times. Please contact customer service for availability.

Price Book - Section 1 Standard Spray Sprinklers

TY-B, 5mm Bulb, K=8.0, 3/4" NPT, Pendent, Recessed Pendent and Upright Sprinklers							
100 Box Quantity (Upright 21 lbs/box (SIN TY4151), Pendent 21 lbs/box (SIN TY4251))							
	<i>C.O.</i>	<i>Upright</i>	<i>Pendent</i>	<i>Finish</i>	<i>Temperature</i>	<i>List Price</i>	
	▶	57-590-1-135	57-591-1-135	Brass	135°F/57°C	\$17.50	
		57-590-1-155	57-591-1-155	Brass	155°F/68°C	\$16.50	
	▶	57-590-1-175	57-591-1-175	Brass	175°F/79°C	\$17.50	
		57-590-1-200	57-591-1-200	Brass	200°F/93°C	\$16.50	
		57-590-1-286	57-591-1-286	Brass	286°F/141°C	\$16.50	
	▶	57-590-1-360	57-591-1-360	Brass	360°F/182°C	\$20.00	
		▶	57-590-9-135	57-591-9-135	Chrome	135°F/57°C	\$20.00
			57-590-9-155	57-591-9-155	Chrome	155°F/68°C	\$20.00
		▶	57-590-9-175	57-591-9-175	Chrome	175°F/79°C	\$20.00
		▶	57-590-9-200	57-591-9-200	Chrome	200°F/93°C	\$20.00
		▶	57-590-9-286	57-591-9-286	Chrome	286°F/141°C	\$20.00
		▶	57-590-9-360	57-591-9-360	Chrome	360°F/182°C	\$22.75
	▶	57-590-4-135	57-591-4-135	White	135°F/57°C	\$20.00	
		57-590-4-155	57-591-4-155	White	155°F/68°C	\$20.00	
	▶	57-590-4-175	57-591-4-175	White	175°F/79°C	\$20.00	
	▶	57-590-4-200	57-591-4-200	White	200°F/93°C	\$20.00	
	▶	57-590-4-286	57-591-4-286	White	286°F/141°C	\$20.00	
	▶	57-590-4-360	57-591-4-360	White	360°F/182°C	\$22.75	
	▶	57-590-7-135	57-591-7-135	Lead Coated	135°F/57°C	\$50.25	
	▶	57-590-7-155	57-591-7-155	Lead Coated	155°F/68°C	\$50.25	
	▶	57-590-7-175	57-591-7-175	Lead Coated	175°F/79°C	\$50.25	
	▶	57-590-7-200	57-591-7-200	Lead Coated	200°F/93°C	\$50.25	
	▶	57-590-7-286	57-591-7-286	Lead Coated	286°F/141°C	\$50.25	
	▶	57-590-7-360	57-591-7-360	Lead Coated	360°F/182°C	\$50.25	
	▶	57-590-6-135	57-591-6-135	Wax Coated	135°F/57°C	\$47.00	
	▶	57-590-6-155	57-591-6-155	Wax Coated	155°F/68°C	\$47.00	
	▶	57-590-6-175	57-591-6-175	Wax Coated	175°F/79°C	\$47.00	
	▶	57-590-6-200	57-591-6-200	Wax Coated	200°F/93°C	\$47.00	
	▶	57-590-6-286	57-591-6-286	Wax Coated	286°F/141°C	\$47.00	
	▶	57-590-8-135	57-591-8-135	Wax over Lead Coated	135°F/57°C	\$65.75	
	▶	57-590-8-155	57-591-8-155	Wax over Lead Coated	155°F/68°C	\$65.75	
	▶	57-590-8-175	57-591-8-175	Wax over Lead Coated	175°F/79°C	\$65.75	
	▶	57-590-8-200	57-591-8-200	Wax over Lead Coated	200°F/93°C	\$65.75	
	▶	57-590-8-286	57-591-8-286	Wax over Lead Coated	286°F/141°C	\$65.75	
Recessed Escutcheons (Order Separately)							
		56-700-2-010	3/4" Brass Recessed (Style 40)			\$7.70	
		56-700-9-010	3/4" Chrome Recessed (Style 40)			\$5.50	
		56-700-4-010	3/4" White Recessed (Style 40)			\$5.50	
Sprinkler Wrench							
		56-000-6-387	W-Type 6 Wrench			\$40.75	
		56-850-4-001	W-Type 7 Wrench (Recessed Only)			\$68.25	
Technical Data Sheet: TFP151							

See latest Technical Data Sheets for specific Approvals, Listings, Design Parameters & available finishes. Sprinkler heads & escutcheons are priced separately unless otherwise noted.

Items marked "C.O." are made to order and may require longer delivery times. Please contact customer service for availability.

TY-B, 5mm Bulb, K=5.6, 1/2" NPT, Horizontal, Recessed Horizontal, and Vertical Sidewall Sprinklers

100 Box Quantity (Upright 18 lbs/box (SIN TY3351), Pendent 18 lbs/box (SIN TY3451))

	C.O.	Horiz. Sidewall	Vertical	Finish	Temperature	List Price
Section 1 Standard Spray Sprinklers	▶	57-578-1-135	57-575-1-135	Brass	135°F/57°C	\$27.75
		57-578-1-155	57-575-1-155	Brass	155°F/68°C	\$27.75
	▶	57-578-1-175	57-575-1-175	Brass	175°F/79°C	\$27.75
		57-578-1-200	57-575-1-200	Brass	200°F/93°C	\$27.75
		57-578-1-286	57-575-1-286	Brass	286°F/141°C	\$27.75
	▶	57-578-1-360	57-575-1-360	Brass	360°F/182°C	\$31.75
Section 2 Extended Coverage Sprinklers	▶	57-578-9-135	57-575-9-135	Chrome	135°F/57°C	\$29.75
		57-578-9-155	57-575-9-155	Chrome	155°F/68°C	\$29.75
	▶	57-578-9-175	57-575-9-175	Chrome	175°F/79°C	\$29.75
		57-578-9-200	57-575-9-200	Chrome	200°F/93°C	\$29.75
	▶	57-578-9-286	57-575-9-286	Chrome	286°F/141°C	\$29.75
	▶	57-578-9-360	57-575-9-360	Chrome	360°F/182°C	\$35.75
Section 3 Storage Sprinklers	▶	57-578-4-135	57-575-4-135	White	135°F/57°C	\$29.75
		57-578-4-155	57-575-4-155	White	155°F/68°C	\$29.75
	▶	57-578-4-175	57-575-4-175	White	175°F/79°C	\$29.75
	▶	57-578-4-200	57-575-4-200	White	200°F/93°C	\$29.75
	▶	57-578-4-286	57-575-4-286	White	286°F/141°C	\$29.75
	▶	57-578-4-360	57-575-4-360	White	360°F/182°C	\$35.75
Section 4 Residential Sprinklers	▶	57-578-7-135	57-575-7-135	Lead Coated	135°F/57°C	\$56.50
	▶	57-578-7-155	57-575-7-155	Lead Coated	155°F/68°C	\$56.50
	▶	57-578-7-175	57-575-7-175	Lead Coated	175°F/79°C	\$56.50
	▶	57-578-7-200	57-575-7-200	Lead Coated	200°F/93°C	\$56.50
	▶	57-578-7-286	57-575-7-286	Lead Coated	286°F/141°C	\$56.50
	▶	57-578-7-360	57-575-7-360	Lead Coated	360°F/182°C	\$56.50
Section 5 Dry Sprinklers	▶	57-578-6-135	57-575-6-135	Wax Coated	135°F/57°C	\$53.75
	▶	57-578-6-155	57-575-6-155	Wax Coated	155°F/68°C	\$53.75
	▶	57-578-6-175	57-575-6-175	Wax Coated	175°F/79°C	\$53.75
	▶	57-578-6-200	57-575-6-200	Wax Coated	200°F/93°C	\$53.75
	▶	57-578-6-286	57-575-6-286	Wax Coated	286°F/141°C	\$53.75
Section 6 Special Sprinklers	▶	57-578-8-135	57-575-8-135	Wax over Lead Coated	135°F/57°C	\$72.25
	▶	57-578-8-155	57-575-8-155	Wax over Lead Coated	155°F/68°C	\$72.25
	▶	57-578-8-175	57-575-8-175	Wax over Lead Coated	175°F/79°C	\$72.25
	▶	57-578-8-200	57-575-8-200	Wax over Lead Coated	200°F/93°C	\$72.25
	▶	57-578-8-286	57-575-8-286	Wax over Lead Coated	286°F/141°C	\$72.25
Recessed Escutcheons (Order Separately)						
	56-701-2-010	1/2" Brass Plated (Style 10)				\$7.70
	56-701-9-010	1/2" Chrome Plated (Style 10)				\$5.30
	56-701-4-010	1/2" White Color Coated (Style 10)				\$5.30
Sprinkler Wrench						
	56-000-6-387	W-Type 6 Wrench				\$40.75
	56-850-4-001	W-Type 7 Wrench (Recessed Only)				\$68.25
Technical Data Sheet: TFP161						

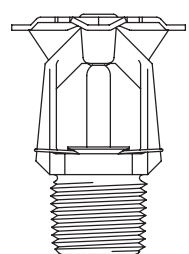
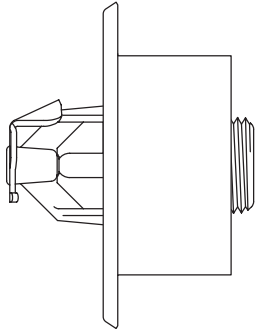
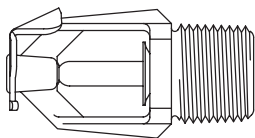

See latest Technical Data Sheets for specific Approvals, Listings, Design Parameters & available finishes. Sprinkler heads & escutcheons are priced separately unless otherwise noted.

Items marked "C.O." are made to order and may require longer delivery times. Please contact customer service for availability.

Price Book - Section 1 Standard Spray Sprinklers

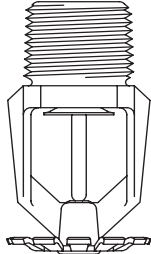
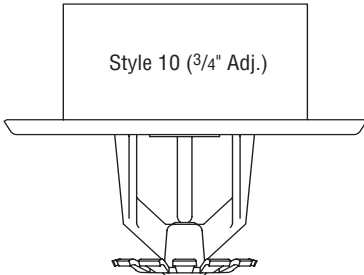
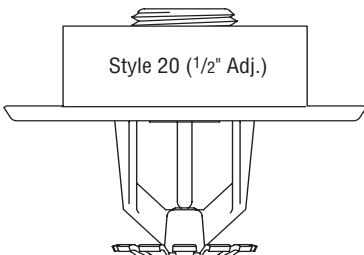
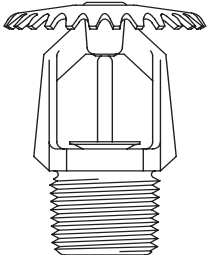
TY-FRB, 3mm Bulb, Quick Response, K=2.8, 1/2" NPT, Pendent, Recessed Pendent and Upright Sprinklers							
100 Box Quantity (Upright 18 lbs/box (SIN TY1131), Pendent 17 lbs/box (SIN TY1231))							
	C.O.	Upright	Pendent	Finish	Temperature	List Price	
	▶	57-330-1-135	57-331-1-135	Brass	135°F/57°C	\$31.50	
		57-330-1-155	57-331-1-155	Brass	155°F/68°C	\$31.50	
	▶	57-330-1-175	57-331-1-175	Brass	175°F/79°C	\$31.50	
		57-330-1-200	57-331-1-200	Brass	200°F/93°C	\$31.50	
	▶	57-330-1-286	57-331-1-286	Brass	286°F/141°C	\$31.50	
	 <p style="text-align: center;">Style 10 (3/4" Adj.)</p>	▶	57-330-9-135	57-331-9-135	Chrome	135°F/57°C	\$34.25
			57-330-9-155	57-331-9-155	Chrome	155°F/68°C	\$34.25
		▶	57-330-9-175	57-331-9-175	Chrome	175°F/79°C	\$34.25
			57-330-9-200	57-331-9-200	Chrome	200°F/93°C	\$34.25
		▶	57-330-9-286	57-331-9-286	Chrome	286°F/141°C	\$34.25
		 <p style="text-align: center;">Style 20 (1/2" Adj.)</p>	▶	57-330-4-135	57-331-4-135	White	135°F/57°C
			57-330-4-155	57-331-4-155	White	155°F/68°C	\$34.25
▶	57-330-4-175		57-331-4-175	White	175°F/79°C	\$34.25	
	57-330-4-200		57-331-4-200	White	200°F/93°C	\$34.25	
▶	57-330-4-286		57-331-4-286	White	286°F/141°C	\$34.25	
	Recessed Escutcheons (Order Separately)						
		56-701-2-010	1/2" Brass Plated (Style 10)			\$7.70	
		56-701-9-010	1/2" Chrome Plated (Style 10)			\$5.30	
		56-701-4-010	1/2" White Color Coated (Style 10)			\$5.30	
		56-705-2-010	1/2" Brass Plated (Style 20)			\$7.70	
		56-705-9-010	1/2" Chrome Plated (Style 20)			\$5.30	
	56-705-4-010	1/2" White Color Coated (Style 20)			\$5.30		
Sprinkler Wrench							
	56-000-6-387	W-Type 6 Wrench				\$40.75	
	56-850-4-001	W-Type 7 Wrench (Recessed Only)				\$68.25	
Technical Data Sheet: TFP 171							

Section 1
Standard Spray Sprinklers

Section 2
Extended Coverage Sprinklers

Section 3
Storage Sprinklers

Section 4
Residential Sprinklers

Section 5
Dry Sprinklers

Section 6
Special Sprinklers

Section 7
Nozzles and Sprinkler Accessories

See latest Technical Data Sheets for specific Approvals, Listings, Design Parameters & available finishes. Sprinkler heads & escutcheons are priced separately unless otherwise noted.

Items marked "C.O." are made to order and may require longer delivery times. Please contact customer service for availability.

**TY-FRB, 3mm Bulb, Quick Response, K=4.2,
1/2" NPT, Pendent, Recessed Pendent and Upright Sprinklers**

100 Box Quantity (Upright 18 lbs/box (SIN TY2131), Pendent 17 lbs/box (SIN TY2231))

Section 1
Standard Spray Sprinklers

Section 2
Extended Coverage Sprinklers

Section 3
Storage Sprinklers

Section 4
Residential Sprinklers

Section 5
Dry Sprinklers

Section 6
Special Sprinklers

Section 7
Nozzles and Sprinkler Accessories

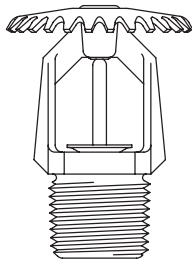
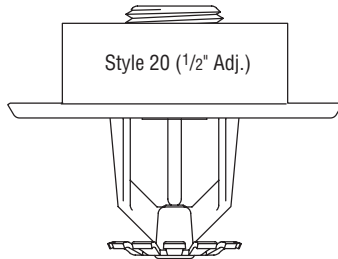
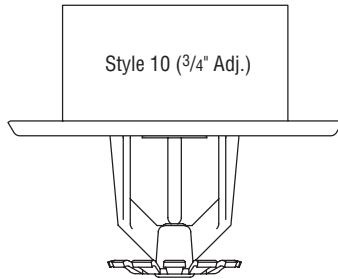
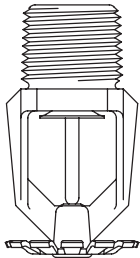

C.O.	Upright	Pendent	Finish	Temperature	List Price
▶	57-340-1-135	57-341-1-135	Brass	135°F/57°C	\$31.50
	57-340-1-155	57-341-1-155	Brass	155°F/68°C	\$31.50
▶	57-340-1-175	57-341-1-175	Brass	175°F/79°C	\$31.50
	57-340-1-200	57-341-1-200	Brass	200°F/93°C	\$31.50
▶	57-340-1-286	57-341-1-286	Brass	286°F/141°C	\$31.50
▶	57-340-9-135	57-341-9-135	Chrome	135°F/57°C	\$34.25
	57-340-9-155	57-341-9-155	Chrome	155°F/68°C	\$34.25
▶	57-340-9-175	57-341-9-175	Chrome	175°F/79°C	\$34.25
▶	57-340-9-200	57-341-9-200	Chrome	200°F/93°C	\$34.25
▶	57-340-9-286	57-341-9-286	Chrome	286°F/141°C	\$34.25
▶	57-340-4-135	57-341-4-135	White	135°F/57°C	\$34.25
	57-340-4-155	57-341-4-155	White	155°F/68°C	\$34.25
▶	57-340-4-175	57-341-4-175	White	175°F/79°C	\$34.25
▶	57-340-4-200	57-341-4-200	White	200°F/93°C	\$34.25
▶	57-340-4-286	57-341-4-286	White	286°F/141°C	\$34.25
Recessed Escutcheons (Order Separately)					
	56-701-2-010	1/2" Brass Plated (Style 10)			\$7.70
	56-701-9-010	1/2" Chrome Plated (Style 10)			\$5.30
	56-701-4-010	1/2" White Color Coated (Style 10)			\$5.30
	56-705-2-010	1/2" Brass Plated (Style 20)			\$7.70
	56-705-9-010	1/2" Chrome Plated (Style 20)			\$5.30
	56-705-4-010	1/2" White Color Coated (Style 20)			\$5.30
Sprinkler Wrench					
	56-000-6-387	W-Type 6 Wrench			\$40.75
	56-850-4-001	W-Type 7 Wrench (Recessed Only)			\$68.25

Technical Data Sheet: TFP171

See latest Technical Data Sheets for specific Approvals, Listings, Design Parameters & available finishes. Sprinkler heads & escutcheons are priced separately unless otherwise noted.

Items marked "C.O." are made to order and may require longer delivery times. Please contact customer service for availability.

Price Book - Section 1 Standard Spray Sprinklers

TY-FRB, 3mm Bulb, Quick Response, K=5.6, 1/2" NPT, Pendant, Recessed Pendant and Upright Sprinkler

100 Box Quantity (Upright 18 lbs/box (SIN TY3131), Pendant 17 lbs/box (SIN TY3231))

	C.O.	Upright	Pendant	Finish	Temperature	List Price		
	▶	57-370-1-135	57-371-1-135	Brass	135°F/57°C	\$26.25	Section 1 Standard Spray Sprinklers	
		57-370-1-155	57-371-1-155	Brass	155°F/68°C	\$24.50		
	▶	57-370-1-175	57-371-1-175	Brass	175°F/79°C	\$26.25		
		57-370-1-200	57-371-1-200	Brass	200°F/93°C	\$24.50		
		57-370-1-286	57-371-1-286	Brass	286°F/141°C	\$24.50		
	▶	57-370-9-135	57-371-9-135	Chrome	135°F/57°C	\$28.50		Section 2 Extended Coverage Sprinklers
		57-370-9-155	57-371-9-155	Chrome	155°F/68°C	\$26.75		
	▶	57-370-9-175	57-371-9-175	Chrome	175°F/79°C	\$28.50		
	▶	57-370-9-200	57-371-9-200	Chrome	200°F/93°C	\$28.50		
	▶	57-370-9-286	57-371-9-286	Chrome	286°F/141°C	\$28.50		
	▶	57-370-4-135	57-371-4-135	White	135°F/57°C	\$26.75	Section 3 Storage Sprinklers	
		57-370-4-155	57-371-4-155	White	155°F/68°C	\$26.75		
	▶	57-370-4-175	57-371-4-175	White	175°F/79°C	\$26.75		
	▶	57-370-4-200	57-371-4-200	White	200°F/93°C	\$26.75		
	▶	57-370-4-286	57-371-4-286	White	286°F/141°C	\$26.75		
		57-370-X-155	57-371-X-155	Black	155°F/68°C	\$75.00		
		57-370-X-200	57-371-X-200	Black	200°F/93°C	\$75.00		
	▶	57-370-7-135	57-371-7-135	Lead Coated	135°F/57°C	\$75.00		Section 4 Residential Sprinklers
	▶	57-370-7-155	57-371-7-155	Lead Coated	155°F/68°C	\$75.00		
	▶	57-370-7-175	57-371-7-175	Lead Coated	175°F/79°C	\$75.00		
▶	57-370-7-200	57-371-7-200	Lead Coated	200°F/93°C	\$75.00			
▶	57-370-7-286	57-371-7-286	Lead Coated	286°F/141°C	\$75.00			
	Recessed Escutcheons (Order Separately)						Section 5 Dry Sprinklers	
		56-701-2-010	1/2" Brass Plated (Style 10)			\$7.70		
		56-701-9-010	1/2" Chrome Plated (Style 10)			\$5.30		
		56-701-4-010	1/2" White Color Coated (Style 10)			\$5.30		
		56-701-6-010	1/2" Black Color Coated (Style 10)			\$6.90		
		56-705-2-010	1/2" Brass Plated (Style 20)			\$7.70		
		56-705-9-010	1/2" Chrome Plated (Style 20)			\$5.30		
		56-705-4-010	1/2" White Color Coated (Style 20)			\$5.30		
		56-705-6-010	1/2" Black Color Coated (Style 20)			\$6.90		
	Sprinkler Wrench							Section 6 Special Sprinklers
	56-000-6-387	W-Type 6 Wrench			\$40.75			
	56-850-4-001	W-Type 7 Wrench (Recessed Only)			\$68.25	Section 7 Nozzles and Sprinkler Accessories		
Technical Data Sheet: TFP171								

See latest Technical Data Sheets for specific Approvals, Listings, Design Parameters & available finishes. Sprinkler heads & escutcheons are priced separately unless otherwise noted.

Items marked "C.O." are made to order and may require longer delivery times. Please contact customer service for availability.

**TY-FRB, 3mm Bulb, Quick Response, K=8.0, 3/4" NPT, Pendant,
Recessed Pendant and Upright Sprinkler**

100 Box Quantity (Upright 18 lbs/box (SIN TY4131), Pendant 17 lbs/box (SIN TY4231))

Section 1
Standard Spray Sprinklers

Section 2
Extended Coverage Sprinklers

Section 3
Storage Sprinklers

Section 4
Residential Sprinklers

Section 5
Dry Sprinklers

Section 6
Special Sprinklers

Section 7
Nozzles and Sprinkler Accessories

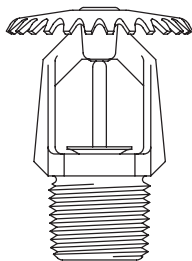
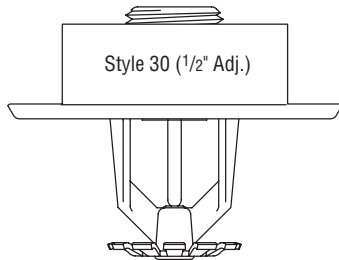
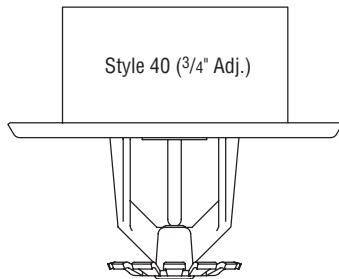
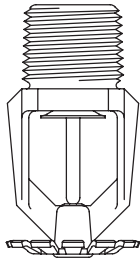

C.O.	Upright	Pendant	Finish	Temperature	List Price
▶	57-390-1-135	57-391-1-135	Brass	135°F/57°C	\$34.75
	57-390-1-155	57-391-1-155	Brass	155°F/68°C	\$34.75
▶	57-390-1-175	57-391-1-175	Brass	175°F/79°C	\$34.75
▶	57-390-1-200	57-391-1-200	Brass	200°F/93°C	\$34.75
	57-390-1-286	57-391-1-286	Brass	286°F/141°C	\$34.75
▶	57-390-9-135	57-391-9-135	Chrome	135°F/57°C	\$37.00
	57-390-9-155	57-391-9-155	Chrome	155°F/68°C	\$37.00
▶	57-390-9-175	57-391-9-175	Chrome	175°F/79°C	\$37.00
	57-390-9-200	57-391-9-200	Chrome	200°F/93°C	\$37.00
▶	57-390-9-286	57-391-9-286	Chrome	286°F/141°C	\$37.00
▶	57-390-4-135	57-391-4-135	White	135°F/57°C	\$37.00
	57-390-4-155	57-391-4-155	White	155°F/68°C	\$37.00
▶	57-390-4-175	57-391-4-175	White	175°F/79°C	\$37.00
	57-390-4-200	57-391-4-200	White	200°F/93°C	\$37.00
▶	57-390-4-286	57-391-4-286	White	286°F/141°C	\$37.00
▶	57-390-7-135	57-391-7-135	Lead Coated	135°F/57°C	\$84.75
▶	57-390-7-155	57-391-7-155	Lead Coated	155°F/68°C	\$84.75
▶	57-390-7-175	57-391-7-175	Lead Coated	175°F/79°C	\$84.75
▶	57-390-7-200	57-391-7-200	Lead Coated	200°F/93°C	\$84.75
▶	57-390-7-286	57-391-7-286	Lead Coated	286°F/141°C	\$84.75
Recessed Escutcheons (Order Separately)					
	56-705-2-011	3/4" Brass Recessed (Style 30)			\$7.70
	56-705-9-011	3/4" Chrome Recessed (Style 30)			\$5.50
	56-705-4-011	3/4" White Recessed (Style 30)			\$5.50
	56-700-2-010	3/4" Brass Plated (Style 40)			\$7.70
	56-700-9-010	3/4" Chrome Plated (Style 40)			\$5.50
	56-700-4-010	3/4" White Recessed (Style 40)			\$5.50
Sprinkler Wrench					
	56-000-6-387	W-Type 6 Wrench			\$40.75
	56-850-4-001	W-Type 7 Wrench (Recessed Only)			\$68.25
Technical Data Sheet: TFP171					

See latest Technical Data Sheets for specific Approvals, Listings, Design Parameters & available finishes. Sprinkler heads & escutcheons are priced separately unless otherwise noted.

Items marked "C.O." are made to order and may require longer delivery times. Please contact customer service for availability.

Price Book - Section 1 Standard Spray Sprinklers

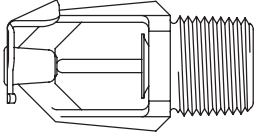
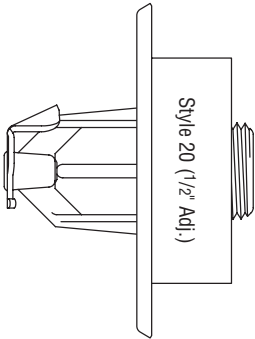
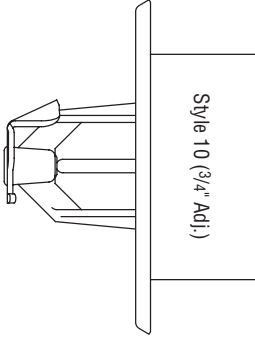
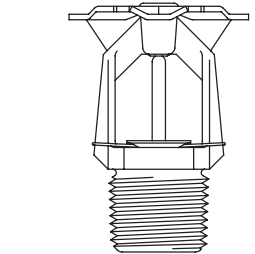
TY-FRB, 3mm Bulb, Quick Response, K=5.6, 1/2" NPT Horizontal Sidewall Sprinkler, Recessed Horizontal Sidewall and Vertical Sidewall						
100 Box Quantity (18 lbs/box) (Horizontal Sidewall SIN TY3331) (Vertical Sidewall SIN TY3431)						
	C.O.	Horiz. Sidewall	Vertical Sidewall	Finish	Temperature	List Price
	▶	57-378-1-135	57-375-1-135	Brass	135°F/57°C	\$47.50
		57-378-1-155	57-375-1-155	Brass	155°F/68°C	\$47.50
	▶	57-378-1-175	57-375-1-175	Brass	175°F/79°C	\$47.50
		57-378-1-200	57-375-1-200	Brass	200°F/93°C	\$47.50
	▶	57-378-1-286	57-375-1-286	Brass	286°F/141°C	\$47.50
	▶	57-378-9-135	57-375-9-135	Chrome	135°F/57°C	\$51.25
		57-378-9-155	57-375-9-155	Chrome	155°F/68°C	\$51.25
	▶	57-378-9-175	57-375-9-175	Chrome	175°F/79°C	\$51.25
		57-378-9-200	57-375-9-200	Chrome	200°F/93°C	\$51.25
	▶	57-378-9-286	57-375-9-286	Chrome	286°F/141°C	\$51.25
	▶	57-378-4-135	57-375-4-135	White	135°F/57°C	\$51.25
		57-378-4-155	57-375-4-155	White	155°F/68°C	\$51.25
	▶	57-378-4-175	57-375-4-175	White	175°F/79°C	\$51.25
	▶	57-378-4-200	57-375-4-200	White	200°F/93°C	\$51.25
	▶	57-378-4-286	57-375-4-286	White	286°F/141°C	\$51.25
	▶	57-378-7-135	57-375-7-135	Lead Coated	135°F/57°C	\$84.75
	▶	57-378-7-155	57-375-7-155	Lead Coated	155°F/68°C	\$84.75
	▶	57-378-7-175	57-375-7-175	Lead Coated	175°F/79°C	\$84.75
	▶	57-378-7-200	57-375-7-200	Lead Coated	200°F/93°C	\$84.75
	▶	57-378-7-286	57-375-7-286	Lead Coated	286°F/141°C	\$84.75
Recessed Escutcheons (Order Separately)						
		56-701-2-010	1/2" Brass (Style 10)			\$7.70
		56-701-9-010	1/2" Chrome (Style 10)			\$5.30
		56-701-4-010	1/2" White (Style 10)			\$5.30
		56-705-2-010	1/2" Brass (Style 20)			\$7.70
		56-705-9-010	1/2" Chrome (Style 20)			\$5.30
		56-705-4-010	1/2" White (Style 20)			\$5.30
Sprinkler Wrench						
		56-000-6-387	W-Type 6 Wrench			\$40.75
		56-850-4-001	W-Type 7 Wrench (Recessed Only)			\$68.25
Technical Data Sheet: TFP176						

See latest Technical Data Sheets for specific Approvals, Listings, Design Parameters & available finishes. Sprinkler heads & escutcheons are priced separately unless otherwise noted.

Items marked "C.O." are made to order and may require longer delivery times. Please contact customer service for availability.

Series RFII, 5.6 K-factor, Standard Response, "Royal Flush II" Pendent Concealed Sprinklers

80 Box Quantity (29 lbs/box) (SIN TY3504 - 250 psi)

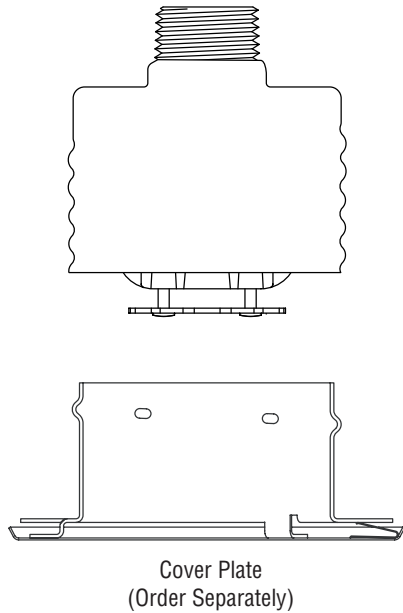

Note:
All "Special Order" cover plates are special ordered and are Non-Returnable. Please see "Terms & Conditions"

C.O.	Pendent	Finish	Temperature	List Price
High Pressure (250 psi)				
▶	51-790-1-155	Brass	155°F/68°C	\$34.50
▶	51-790-1-200	Brass	200°F/93°C	\$34.50
Cover Plate (135° F for use with 155° F Sprinkler)				
80 Box Quantity (14.5 lbs/box)				
	56-792-1-135	Brass	135°F/57°C	\$17.75
	56-792-9-135	Chrome	135°F/57°C	\$17.75
	56-792-0-135	Grey White	135°F/57°C	\$17.75
	56-792-4-135	Signal (Bright) White	135°F/57°C	\$17.75
▶	56-792-X-135	Special Order*	135°F/57°C	\$19.25
Cover Plate (165° F for use with 200° F Sprinkler)				
80 Box Quantity (14.5 lbs/box)				
	56-792-1-165	Brass	165°F/74°C	\$17.75
	56-792-9-165	Chrome	165°F/74°C	\$17.75
	56-792-0-165	Grey White	165°F/74°C	\$17.75
	56-792-4-165	Signal (Bright) White	165°F/74°C	\$17.75
▶	56-792-X-165	Special Order*	165°F/74°C	\$19.25
Notes				
	6012	*Special Order paint match subject to set-up charge. (Net Price)		\$315.50
Sprinkler Wrench				
	56-000-1-075	RFII Wrench		\$68.25
Air and Dust Seal				
	56-908-1-001	Air and Dust Seal		\$9.80
Technical Data Sheet: TFP181				

Section 1
Standard Spray Sprinklers

Section 2
Extended Coverage Sprinklers

Section 3
Storage Sprinklers

Section 4
Residential Sprinklers

Section 5
Dry Sprinklers

Section 6
Special Sprinklers

Section 7
Nozzles and Sprinkler Accessories

See latest Technical Data Sheets for specific Approvals, Listings, Design Parameters & available finishes. Sprinkler heads & escutcheons are priced separately unless otherwise noted.

Items marked "C.O." are made to order and may require longer delivery times. Please contact customer service for availability.

Price Book - Section 1 Standard Spray Sprinklers

Series RFII, 5.6 K-factor, Quick Response, "Royal Flush II" Pendent Concealed Sprinklers

80 Box Quantity (29 lbs/box) (SIN TY3505 - 250 psi)

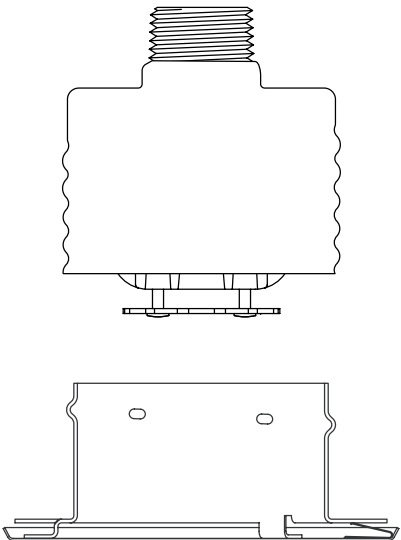
	C.O.	Pendent	Finish	Temperature	List Price
 <p style="text-align: center;">Cover Plate (Order Separately)</p> <p style="text-align: center;">Note: All "Special Order" cover plates are special ordered and are Non-Returnable. Please see "Terms & Conditions"</p>	High Pressure (250 psi)				
	▶	51-792-1-155	Brass	155°F/68°C	\$33.25
	▶	51-792-1-200	Brass	200°F/93°C	\$33.25
	Cover Plate (135° F for use with 155° F Sprinkler)				
	80 Box Quantity (14.5 lbs/box)				
		56-792-1-135	Brass	135°F/57°C	\$17.75
		56-792-9-135	Chrome	135°F/57°C	\$17.75
		56-792-0-135	Grey White	135°F/57°C	\$17.75
		56-792-4-135	Signal (Bright) White	135°F/57°C	\$17.75
	▶	56-792-X-135	Special Order*	135°F/57°C	\$19.25
	Cover Plate (165° F for use with 200° F Sprinkler)				
	80 Box Quantity (14.5 lbs/box)				
		56-792-1-165	Brass	165°F/74°C	\$17.75
		56-792-9-165	Chrome	165°F/74°C	\$17.75
		56-792-0-165	Grey White	165°F/74°C	\$17.75
		56-792-4-165	Signal (Bright) White	165°F/74°C	\$17.75
	▶	56-792-X-165	Special Order*	165°F/74°C	\$19.25
	Notes				
		6012	*Special Order paint match subject to set-up charge. (Net Price)		\$315.50
	Sprinkler Wrench				
	56-000-1-075	RFII Wrench		\$68.25	
Air and Dust Seal					
	56-908-1-001	Air and Dust Seal		\$9.80	
Technical Data Sheet: TFP181					

Section 1	Standard Spray Sprinklers
Section 2	Extended Coverage Sprinklers
Section 3	Storage Sprinklers
Section 4	Residential Sprinklers
Section 5	Dry Sprinklers
Section 6	Special Sprinklers
Section 7	Nozzles and Sprinkler Accessories

See latest Technical Data Sheets for specific Approvals, Listings, Design Parameters & available finishes. Sprinkler heads & escutcheons are priced separately unless otherwise noted.

Items marked "C.O." are made to order and may require longer delivery times. Please contact customer service for availability.

Model TYQRF, K=5.6, Quick Response Standard Coverage, Flush Pendent Sprinklers

(SIN TY3261)

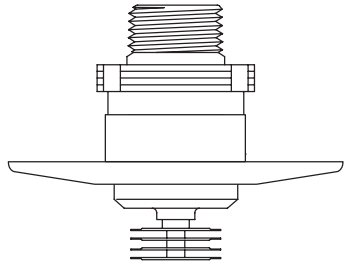

<i>C.O.</i>	<i>Pendent</i>	<i>Finish</i>	<i>Temperature</i>	<i>List Price</i>
	53-261-9-162	Chrome	162°F (72°C)	\$49.00
	53-261-4-162	White	162°F (72°C)	\$49.00
	53-261-6-162	Black	162°F (72°C)	\$55.00
Trim Plates (Order Separately)				
	56-123-9-001	Chrome Escutcheon		\$6.10
	56-123-4-001	White Escutcheon		\$6.10
	56-123-6-001	Black Escutcheon		\$6.10
Sprinkler Wrench				
	56-000-4-947	Wrench (Socket Only)		\$73.00
	56-000-4-948	Socket/Ratchet Wrench		\$108.50
	56-000-4-300	Protective Cover Removal Tool		\$24.25
Technical Data Sheet: TFP190				

Section 1
Standard Spray Sprinklers

Section 2
Extended Coverage Sprinklers

Section 3
Storage Sprinklers

Section 4
Residential Sprinklers

Section 5
Dry Sprinklers

Section 6
Special Sprinklers

Section 7
Nozzles and Sprinkler Accessories

See latest Technical Data Sheets for specific Approvals, Listings, Design Parameters & available finishes. Sprinkler heads & escutcheons are priced separately unless otherwise noted.

Items marked "C.O." are made to order and may require longer delivery times. Please contact customer service for availability.

Price Book - Section 2 Extended Coverage Sprinklers

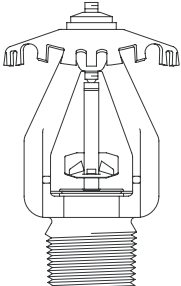
Model EC-25, K=25.2, 1" NPT, Upright, Area/Density, Extended Coverage (SIN TY9128)						
SIN TY9128						
	C.O.	Upright	Description	Temperature	List Price	
			58-450-1-165	Brass	165°F/74°C	\$76.75
			58-450-1-214	Brass	214°F/101°C	\$76.75
	Sprinkler Wrench					
			56-872-1-025	W-Type 1 Wrench		\$52.00
Technical Data Sheet: TFP213						

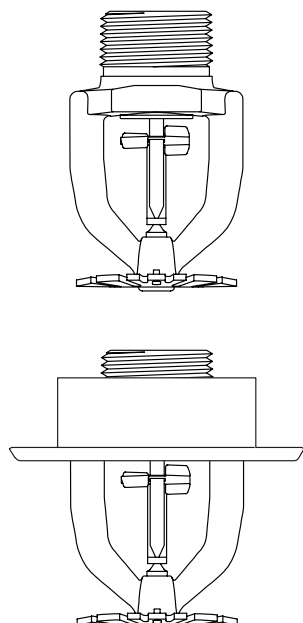
Model EC-17, Pendent and Recessed Pendent Sprinklers K=16.8, 3/4" N.P.T.						
SIN TY7228						
	C.O.	Upright	Description	Temperature	List Price	
			51-310-1-160	Brass	160°F/71°C	\$51.25
			51-310-1-212	Brass	212°F/100°C	\$51.25
			51-310-9-160	Chrome	160°F/71°C	\$54.50
			51-310-9-212	Chrome	212°F/100°C	\$54.50
			51-310-4-160	White	160°F/71°C	\$54.50
			51-310-4-212	White	212°F/100°C	\$54.50
	Recessed Escutcheons (Order Separately)					
			56-705-2-011	3/4" Brass Recessed (Style 30)		\$7.70
			56-705-9-011	3/4" Chrome Recessed (Style 30)		\$5.50
			56-705-4-011	3/4" White Recessed (Style 30)		\$5.50
	Sprinkler Wrench					
			56-895-1-001	W-Type 3 Wrench		\$56.75
			56-000-6-856	W-Type 24 Wrench (Recessed Only)		\$68.25
	Technical Data Sheet: TFP215					

See latest Technical Data Sheets for specific Approvals, Listings, Design Parameters & available finishes. Sprinkler heads & escutcheons are priced separately unless otherwise noted.

Items marked "C.O." are made to order and may require longer delivery times. Please contact customer service for availability.

Series EC-14, Upright Sprinklers K=14.0, 3/4" N.P.T.

100 Box Quantity 27 lbs/box SIN TY6137

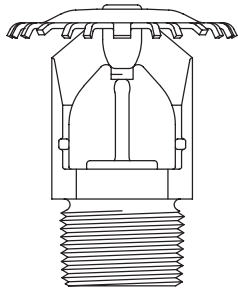

C.O.	Upright	Description	Temperature	List Price
▶	51-896-1-135	Brass	135°F/57°C	\$68.25
	51-896-1-155	Brass	155°F/68°C	\$68.25
▶	51-896-1-175	Brass	175°F/79°C	\$68.25
	51-896-1-200	Brass	200°F/93°C	\$68.25
▶	51-896-1-286	Brass	286°F/141°C	\$68.25
▶	51-896-9-135	Chrome	135°F/57°C	\$71.25
	51-896-9-155	Chrome	155°F/68°C	\$71.25
▶	51-896-9-175	Chrome	175°F/79°C	\$71.25
	51-896-9-200	Chrome	200°F/93°C	\$71.25
▶	51-896-9-286	Chrome	286°F/141°C	\$71.25
▶	51-896-4-135	White	135°F/57°C	\$71.25
	51-896-4-155	White	155°F/68°C	\$71.25
▶	51-896-4-175	White	175°F/79°C	\$71.25
	51-896-4-200	White	200°F/93°C	\$71.25
▶	51-896-4-286	White	286°F/141°C	\$71.25
	51-896-X-155	Black	155°F/68°C	\$103.50
	51-896-X-200	Black	200°F/93°C	\$103.50
▶	51-896-7-135	Lead Coated	135°F/57°C	\$103.50
▶	51-896-7-155	Lead Coated	155°F/68°C	\$103.50
▶	51-896-7-175	Lead Coated	175°F/79°C	\$103.50
▶	51-896-7-200	Lead Coated	200°F/93°C	\$103.50
▶	51-896-7-286	Lead Coated	286°F/141°C	\$103.50
Sprinkler Wrench				
	56-895-1-001	W-Type 3 Wrench		\$56.75

Technical Data Sheet: TFP220

Section 1
Standard Spray Sprinklers

Section 2
Extended Coverage Sprinklers

Section 3
Storage Sprinklers

Section 4
Residential Sprinklers

Section 5
Dry Sprinklers

Section 6
Special Sprinklers

Section 7
Nozzles and Sprinkler Accessories

See latest Technical Data Sheets for specific Approvals, Listings, Design Parameters & available finishes. Sprinkler heads & escutcheons are priced separately unless otherwise noted.

Items marked "C.O." are made to order and may require longer delivery times. Please contact customer service for availability.

Price Book - Section 2 Extended Coverage Sprinklers

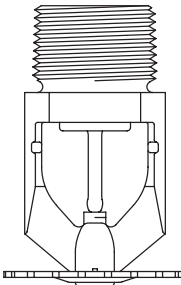
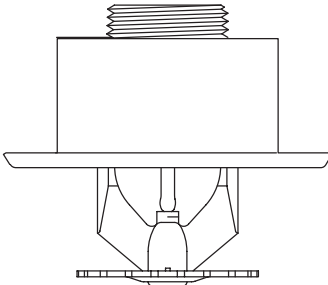
Series EC-14, Pendent and Recessed Pendent Sprinklers K=14.0, 3/4" N.P.T.						
100 Box Quantity, 27 lbs/box (SIN TY6237)						
	C.O.	Pendent	Description	Temperature	List Price	
	▶	51-895-1-135	Brass	135°F/57°C	\$48.00	
		51-895-1-155	Brass	155°F/68°C	\$48.00	
	▶	51-895-1-175	Brass	175°F/79°C	\$48.00	
		51-895-1-200	Brass	200°F/93°C	\$48.00	
	▶	51-895-1-286	Brass	286°F/141°C	\$48.00	
	▶	51-895-9-135	Chrome	135°F/57°C	\$50.50	
		51-895-9-155	Chrome	155°F/68°C	\$50.50	
	▶	51-895-9-175	Chrome	175°F/79°C	\$50.50	
		51-895-9-200	Chrome	200°F/93°C	\$50.50	
	▶	51-895-9-286	Chrome	286°F/141°C	\$50.50	
	▶	51-895-4-135	White	135°F/57°C	\$50.50	
		51-895-4-155	White	155°F/68°C	\$50.50	
	▶	51-895-4-175	White	175°F/79°C	\$50.50	
	▶	51-895-4-200	White	200°F/93°C	\$50.50	
	▶	51-895-4-286	White	286°F/141°C	\$50.50	
			51-895-X-155	Black	155°F/68°C	\$95.00
			51-895-X-200	Black	200°F/93°C	\$95.00
	▶		51-895-7-135	Lead Coated	135°F/57°C	\$95.00
	▶		51-895-7-155	Lead Coated	155°F/68°C	\$95.00
	▶		51-895-7-175	Lead Coated	175°F/79°C	\$95.00
▶		51-895-7-200	Lead Coated	200°F/93°C	\$95.00	
▶		51-895-7-286	Lead Coated	286°F/141°C	\$95.00	
	Recessed Escutcheons (Order Separately)					
		56-705-2-011	3/4" Brass Recessed (Style 30)		\$7.70	
		56-705-9-011	3/4" Chrome Recessed (Style 30)		\$5.50	
		56-705-4-011	3/4" White Recessed (Style 30)		\$5.50	
		56-705-6-011	3/4" Black Recessed (Style 30)		\$7.00	
		56-700-2-010	3/4" Brass Recessed (Style 40)		\$7.70	
		56-700-9-010	3/4" Chrome Recessed (Style 40)		\$5.50	
		56-700-4-010	3/4" White Recessed (Style 40)		\$5.50	
		56-700-6-010	3/4" Black Recessed (Style 40)		\$7.00	
		208102	3/4" Chrome Recessed (Style 60)		\$5.50	
		208104	3/4" White Recessed (Style 60)		\$5.50	
		208107	3/4" Brass Recessed (Style 60)		\$7.70	
	Sprinkler Wrench					
		56-895-1-001	W-Type 3 Wrench		\$56.75	
		56-665-7-001	W-Type 22 (Recessed Only)		\$68.25	
Technical Data Sheet: TFP220						

Section 1 Standard Spray Sprinklers
 Section 2 Extended Coverage Sprinklers
 Section 3 Storage Sprinklers
 Section 4 Residential Sprinklers
 Section 5 Dry Sprinklers
 Section 6 Special Sprinklers
 Section 7 Nozzles and Sprinkler Accessories

See latest Technical Data Sheets for specific Approvals, Listings, Design Parameters & available finishes. Sprinkler heads & escutcheons are priced separately unless otherwise noted.

Items marked "C.O." are made to order and may require longer delivery times. Please contact customer service for availability.

Series EC-11, Pendent, Recessed Pendent and Upright Sprinklers - K=11.2, 3/4" NPT

100 Box Quantity (Upright 27 lbs/box (SIN TY5137), Pendent 27 lbs/box (SIN TY5237))

Section 1
Standard Spray Sprinklers

Section 2
Extended Coverage Sprinklers

Section 3
Storage Sprinklers

Section 4
Residential Sprinklers

Section 5
Dry Sprinklers

Section 6
Special Sprinklers

Section 7
Nozzles and Sprinkler Accessories

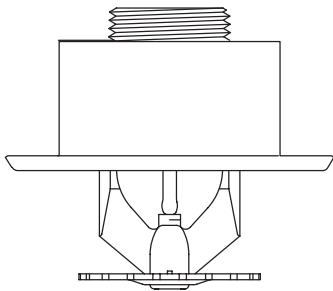
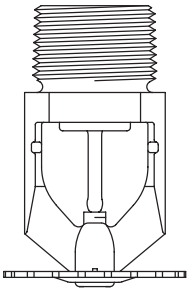
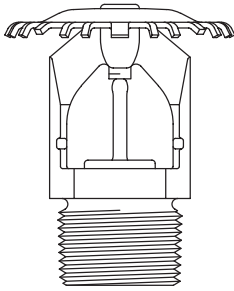

C.O.	Upright	Pendent	Description	Temperature	List Price
▶	51-894-1-135	51-893-1-135	Brass	135°F/57°C	\$43.75
	51-894-1-155	51-893-1-155	Brass	155°F/68°C	\$43.75
▶	51-894-1-175	51-893-1-175	Brass	175°F/79°C	\$43.75
	51-894-1-200	51-893-1-200	Brass	200°F/93°C	\$43.75
▶	51-894-1-286	51-893-1-286	Brass	286°F/141°C	\$43.75
▶	51-894-9-135	51-893-9-135	Chrome	135°F/57°C	\$45.50
	51-894-9-155	51-893-9-155	Chrome	155°F/68°C	\$45.50
▶	51-894-9-175	51-893-9-175	Chrome	175°F/79°C	\$45.50
▶	51-894-9-200	51-893-9-200	Chrome	200°F/93°C	\$45.50
▶	51-894-9-286	51-893-9-286	Chrome	286°F/141°C	\$45.50
▶	51-894-4-135	51-893-4-135	White	135°F/57°C	\$45.50
	51-894-4-155	51-893-4-155	White	155°F/68°C	\$45.50
▶	51-894-4-175	51-893-4-175	White	175°F/79°C	\$45.50
▶	51-894-4-200	51-893-4-200	White	200°F/93°C	\$45.50
▶	51-894-4-286	51-893-4-286	White	286°F/141°C	\$45.50
	51-894-X-155	51-893-X-155	Black	155°F/68°C	\$86.00
	51-894-X-200	51-893-X-200	Black	200°F/93°C	\$86.00
▶	51-894-7-135	51-893-7-135	Lead Coated	135°F/57°C	\$86.00
▶	51-894-7-155	51-893-7-155	Lead Coated	155°F/68°C	\$86.00
▶	51-894-7-175	51-893-7-175	Lead Coated	175°F/79°C	\$86.00
▶	51-894-7-200	51-893-7-200	Lead Coated	200°F/93°C	\$86.00
▶	51-894-7-286	51-893-7-286	Lead Coated	286°F/141°C	\$86.00
Recessed Escutcheons (Order Separately)					
	56-705-2-011	3/4" Brass Recessed (Style 30)			\$7.70
	56-705-9-011	3/4" Chrome Recessed (Style 30)			\$5.50
	56-705-4-011	3/4" White Recessed (Style 30)			\$5.50
	56-705-6-011	3/4" Black Recessed (Style 30)			\$7.00
	56-700-2-010	3/4" Brass Recessed (Style 40)			\$7.70
	56-700-9-010	3/4" Chrome Recessed (Style 40)			\$5.50
	56-700-4-010	3/4" White Recessed (Style 40)			\$5.50
	56-700-6-010	3/4" Black Recessed (Style 40)			\$7.00
	208102	3/4" Chrome Recessed (Style 60)			\$5.50
	208104	3/4" White Recessed (Style 60)			\$5.50
	208107	3/4" Brass Recessed (Style 60)			\$7.70
Sprinkler Wrench					
	56-895-1-001	W-Type 3 Wrench			\$56.75
	56-665-7-001	W-Type 22 (Recessed Only)			\$68.25
Technical Data Sheet: TFP220					

See latest Technical Data Sheets for specific Approvals, Listings, Design Parameters & available finishes. Sprinkler heads & escutcheons are priced separately unless otherwise noted.

Items marked "C.O." are made to order and may require longer delivery times. Please contact customer service for availability.

Price Book - Section 2 Extended Coverage Sprinklers

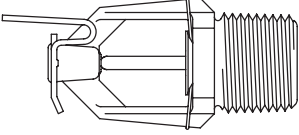
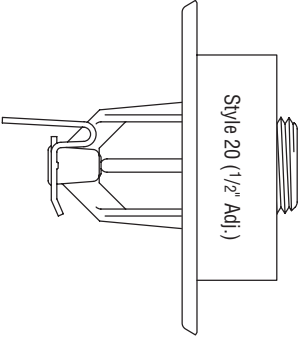
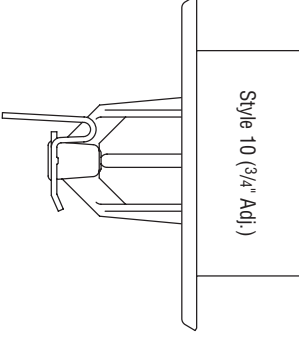
TY-FRB, 3 mm Bulb, K=5.6, 1/2" NPT, Quick Response Extended Coverage, Horizontal Sidewall and Recessed Horizontal Sidewall Sprinklers						
100 Box Quantity (21 lbs/box) (SIN TY3332)						
	C.O.	Horizontal Sidewall	Finish	Temperature	List Price	
  	▶	57-376-1-135	Brass	135°F/57°C	\$28.25	
		57-376-1-155	Brass	155°F/68°C	\$28.25	
	▶	57-376-1-175	Brass	175°F/79°C	\$28.25	
	▶	57-376-9-135	Chrome	135°F/57°C	\$30.50	
		57-376-9-155	Chrome	155°F/68°C	\$30.50	
	▶	57-376-9-175	Chrome	175°F/79°C	\$30.50	
	▶	57-376-4-135	White	135°F/57°C	\$30.50	
		57-376-4-155	White	155°F/68°C	\$30.50	
	▶	57-376-4-175	White	175°F/79°C	\$30.50	
	Recessed Escutcheons (Order Separately)					
		56-701-2-010	1/2" Brass Recessed (Style 10)			\$7.70
		56-701-9-010	1/2" Chrome Recessed (Style 10)			\$5.30
	56-701-4-010	1/2" White Recessed (Style 10)			\$5.30	
	56-705-2-010	1/2" Brass Recessed (Style 20)			\$7.70	
	56-705-9-010	1/2" Chrome Recessed (Style 20)			\$5.30	
	56-705-4-010	1/2" White Recessed (Style 20)			\$5.30	
Sprinkler Wrench						
	56-000-6-387	W-Type 6 Wrench			\$40.75	
	56-850-4-001	W-Type 7 Wrench (Recessed Only)			\$68.25	
Technical Data Sheet: TFP296						

Section 1
Standard Spray Sprinklers

Section 2
Extended Coverage Sprinklers

Section 3
Storage Sprinklers

Section 4
Residential Sprinklers

Section 5
Dry Sprinklers

Section 6
Special Sprinklers

Section 7
Nozzles and Sprinkler Accessories

See latest Technical Data Sheets for specific Approvals, Listings, Design Parameters & available finishes. Sprinkler heads & escutcheons are priced separately unless otherwise noted.

Items marked "C.O." are made to order and may require longer delivery times. Please contact customer service for availability.

TY-FRB, 3 mm Bulb, K=8.0, 3/4" NPT, Quick Response-Extended Coverage, Horizontal Sidewall and Recessed Horizontal Sidewall Sprinklers

100 Box Quantity (21 lbs/box) (SIN TY4332)

C.O.	Sidewall	Finish	Temperature	List Price
▶	57-396-1-135	Brass	135°F/57°C	\$29.00
	57-396-1-155	Brass	155°F/68°C	\$29.00
▶	57-396-1-175	Brass	175°F/79°C	\$29.00
▶	57-396-9-135	Chrome	135°F/57°C	\$32.75
	57-396-9-155	Chrome	155°F/68°C	\$32.75
▶	57-396-9-175	Chrome	175°F/79°C	\$32.75
▶	57-396-4-135	White	135°F/57°C	\$32.75
	57-396-4-155	White	155°F/68°C	\$32.75
▶	57-396-4-175	White	175°F/79°C	\$32.75

Recessed Escutcheons (Order Separately)

	56-705-2-011	3/4" Brass Recessed (Style 30)	\$7.70
	56-705-9-011	3/4" Chrome Recessed (Style 30)	\$5.50
	56-705-4-011	3/4" White Recessed (Style 30)	\$5.50
	56-700-2-010	3/4" Brass Recessed (Style 40)	\$7.70
	56-700-9-010	3/4" Chrome Recessed (Style 40)	\$5.50
	56-700-4-010	3/4" White Recessed (Style 40)	\$5.50

Sprinkler Wrench

	56-000-6-387	W-Type 6 Wrench	\$40.75
	56-850-4-001	W-Type 7 Wrench (Recessed Only)	\$68.25

Technical Data Sheet: TFP296

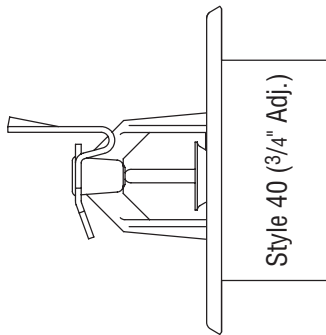
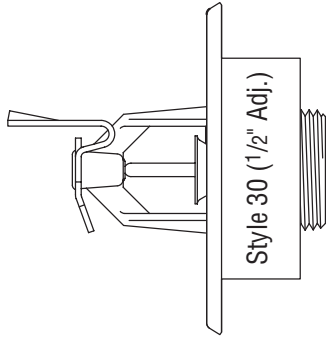
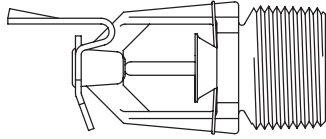

Section 1
Standard Spray Sprinklers

Section 2
Extended Coverage Sprinklers

Section 3
Storage Sprinklers

Section 4
Residential Sprinklers

Section 5
Dry Sprinklers

Section 6
Special Sprinklers

Section 7
Nozzles and Sprinkler Accessories

See latest Technical Data Sheets for specific Approvals, Listings, Design Parameters & available finishes. Sprinkler heads & escutcheons are priced separately unless otherwise noted.

Items marked "C.O." are made to order and may require longer delivery times. Please contact customer service for availability.

Price Book - Section 2 Extended Coverage Sprinklers

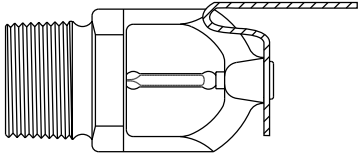
ELO SW-20 ECOH, Sidewall Sprinklers, K=11.2, 3/4" N.P.T.						
100 Box Quantity (32 lbs/box) (SIN TY5332)						
	C.O.	Part No.	Model	Finish	Temperature	List Price
		51-072-1-155	ECOH ELO S/W-20	Brass	155°F/68°C	\$104.50
		51-072-1-200	ECOH ELO S/W-20	Brass	200°F/93°C	\$104.50
		51-072-9-155	ECOH ELO S/W-20	Chrome	155°F/68°C	\$108.00
		51-072-9-200	ECOH ELO S/W-20	Chrome	200°F/93°C	\$108.00
		51-072-4-155	ECOH ELO S/W-20	White	155°F/68°C	\$108.00
		51-072-4-200	ECOH ELO S/W-20	White	200°F/93°C	\$108.00
Sprinkler Wrench						
	56-895-1-001	W-Type 3 Wrench				\$56.75
Technical Data Sheet: TFP230						

Section 1
Standard Spray Sprinklers

Section 2
Extended Coverage Sprinklers

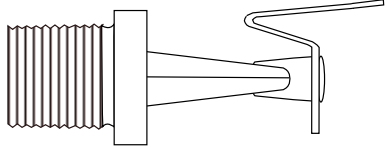
ELO SW-24 ECOH, Sidewall Sprinklers, K=11.2, 3/4" N.P.T.						
100 Box Quantity (32 lbs/box) (SIN TY5337)						
	C.O.	Part No.	Model	Finish	Temperature	List Price
		51-073-1-200	ECOH ELO SW-24	Brass	200°F/93°C	\$104.50
		51-073-9-200	ECOH ELO SW-24	Chrome	200°F/93°C	\$108.00
		51-073-4-200	ECOH ELO SW-24	White	200°F/93°C	\$108.00
Sprinkler Wrench						
	56-895-1-001	W-Type 3 Wrench				\$56.75
Technical Data Sheet: TFP230						

Section 3
Storage Sprinklers

Section 4
Residential Sprinklers

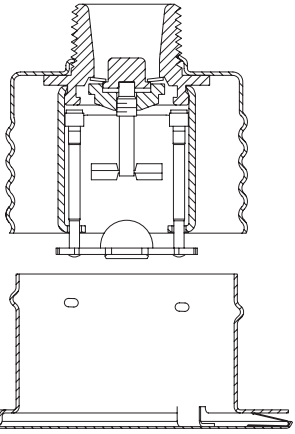
ELOC Extended Coverage, Concealed Sprinklers, K=11.2, 3/4" N.P.T. (SIN TY5522)						
	C.O.	Part No.	Model	Finish	Temperature	List Price
		50-701-1-160	ELOC	Brass	160°F/71°C	\$45.50
		50-701-1-212	ELOC	Brass	212°F/100°C	\$45.50
	Cover Plates (Order Separately)					
		56-892-1-135	ELOC Cover Plate	Brass	135°F/57°C	\$17.75
		56-892-9-135	ELOC Cover Plate	Chrome	135°F/57°C	\$17.75
		56-892-9-165	ELOC Cover Plate	Chrome	165°F/74°C	\$17.75
		56-892-0-135	ELOC Cover Plate	Grey White	135°F/57°C	\$17.75
		56-892-0-165	ELOC Cover Plate	Grey White	165°F/74°C	\$17.75
		56-892-4-135	ELOC Cover Plate	Signal (Bright) White	135°F/57°C	\$17.75
		56-892-X-135	ELOC Cover Plate	Special Order*	135°F/57°C	\$20.75
Clean Room Seals (Order Separately)						
	56-908-1-001	ELOC Clean Room Seal				\$9.80
Sprinkler Wrench						
	56-000-1-265	W-Type 18 Wrench				\$68.25
Notes						
	6012	*Special Order paint match subject to set-up charge. (Net Price)				\$315.50
Technical Data Sheet: TFP250						

Note: All "Special Order" cover plates are special ordered and are Non-Returnable. Please see "Terms & Conditions"

Section 5
Dry Sprinklers

Section 6
Special Sprinklers

Section 7
Nozzles and Sprinkler Accessories

See latest Technical Data Sheets for specific Approvals, Listings, Design Parameters & available finishes. Sprinkler heads & escutcheons are priced separately unless otherwise noted.

Items marked "C.O." are made to order and may require longer delivery times. Please contact customer service for availability.

Series RFII, 5.6 K-factor, "Royal Flush II" Pendent Concealed Sprinklers
Extended Coverage, Quick and Standard Response

80 Box Quantity (29 lbs/box) (SIN TY3532)

Section 1
Standard Spray Sprinklers

Section 2
Extended Coverage Sprinklers

Section 3
Storage Sprinklers

Section 4
Residential Sprinklers

Section 5
Dry Sprinklers

Section 6
Special Sprinklers

Section 7
Nozzles and Sprinkler Accessories

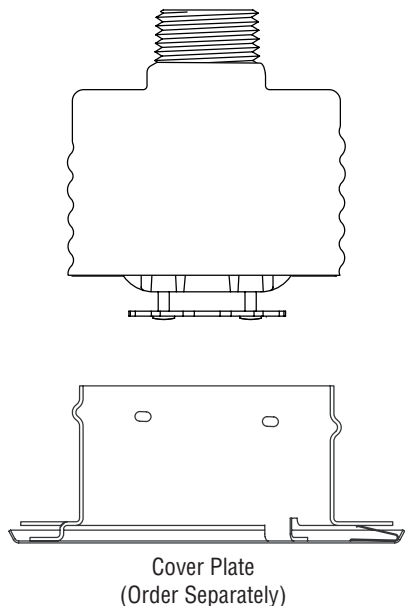

Note: All "Special Order" cover plates are special ordered and are Non-Returnable. Please see "Terms & Conditions"

C.O.	Pendent	Finish	Temperature	List Price
Standard Pressure (175 psi)				
	51-794-1-155	Bronze	155°F/68°C	\$35.75
	51-794-1-200	Bronze	200°F/93°C	\$35.75
Cover Plate (135° F for use with 155° F Sprinkler)				
80 Box Quantity (14.5 lbs/box)				
	56-792-1-135	Brass	135°F/57°C	\$17.75
	56-792-9-135	Chrome	135°F/57°C	\$17.75
	56-792-0-135	Grey White	135°F/57°C	\$17.75
	56-792-4-135	Signal (Bright) White	135°F/57°C	\$17.75
	56-792-X-135	Special Order*	135°F/57°C	\$19.25
Cover Plate (165° F for use with 200° F Sprinkler)				
80 Box Quantity (14.5 lbs/box)				
	56-792-1-165	Brass	165°F/74°C	\$17.75
	56-792-9-165	Chrome	165°F/74°C	\$17.75
	56-792-0-165	Grey White	165°F/74°C	\$17.75
	56-792-4-165	Signal (Bright) White	165°F/74°C	\$17.75
	56-792-X-165	Special Order*	165°F/74°C	\$19.25
Air and Dust Seal				
	56-908-1-001	Air and Dust Seal		\$9.80
Sprinkler Wrench				
	56-000-1-075	RFII Wrench		\$68.25
Notes				
	6012	*Special Order paint match subject to set-up charge. (Net Price)		\$315.50
Technical Data Sheet: TFP260				

See latest Technical Data Sheets for specific Approvals, Listings, Design Parameters & available finishes. Sprinkler heads & escutcheons are priced separately unless otherwise noted.

Items marked "C.O." are made to order and may require longer delivery times. Please contact customer service for availability.

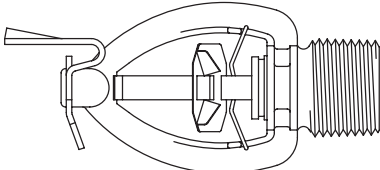
Model TY-FRL, K=5.6, 1/2" NPT Extended Coverage Quick Response Horizontal Sidewall Sprinkler					
100 Box Quantity (20 lbs/box) (SIN TY3322)					
	C.O.	Horizontal Sidewall	Finish	Temperature	List Price
		58-970-1-165	Brass	165°F/74°C	\$61.50
		58-970-9-165	Chrome	165°F/74°C	\$69.50
	Sprinkler Wrench				
		56-000-1-849	W-Type 9 Wrench		\$36.50
Technical Data Sheet: TFP280					

Section 1
Standard Spray Sprinklers

Section 2
Extended Coverage Sprinklers

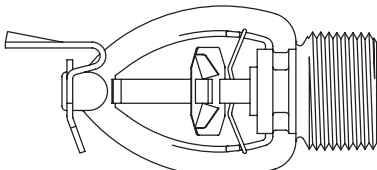
Model TY-FRL, K=8.0, 3/4" NPT, Quick Response Extended Coverage Horizontal Sidewall Sprinklers					
100 Box Quantity (25 lbs/box) (SIN TY4322)					
	C.O.	Horizontal Sidewall	Description	Temperature	List Price
	▶	58-170-1-140	Brass	140°F/60°C	\$69.50
		58-170-1-165	Brass	165°F/74°C	\$69.50
	▶	58-170-9-140	Chrome	140°F/60°C	\$77.50
		58-170-9-165	Chrome	165°F/74°C	\$77.50
	Sprinkler Wrench				
		56-000-1-849	W-Type 9 Wrench		\$36.50
Technical Data Sheet: TFP280					

Section 3
Storage Sprinklers

Section 4
Residential Sprinklers

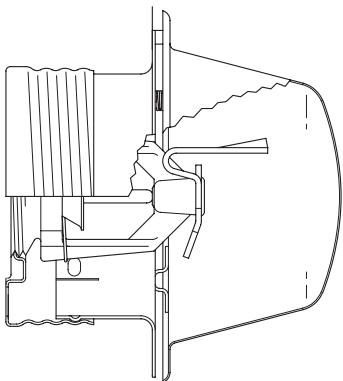
CHEC Concealed Horizontal Sidewall Extended Coverage Sprinklers K=8.0, 3/4" N.P.T. ECLH (SIN TY4332)						
	C.O.	Number	Model	Temperature	List Price	
		51-396-1-155	CHEC Sidewall	155°F/68°C	\$29.75	
	Cover Plate (Order Separately)					
		56-396-4-135	Signal (Bright) White			\$16.75
		56-396-9-135	Chrome			\$16.75
		56-396-X-135	Special Order			\$16.75
	Sprinkler Wrench					
		56-850-4-001	Wrench W-Type 7		\$68.25	
	Notes					
		6012	*Special Order paint match subject to set-up charge. (Net Price)			\$315.50
	Technical Data Sheet: TFP265					

Note: All "Special Order" cover plates are special ordered and are Non-Returnable. Please see "Terms & Conditions"

Section 5
Dry Sprinklers

Section 6
Special Sprinklers

Section 7
Nozzles and Sprinkler Accessories

See latest Technical Data Sheets for specific Approvals, Listings, Design Parameters & available finishes. Sprinkler heads & escutcheons are priced separately unless otherwise noted.

Items marked "C.O." are made to order and may require longer delivery times. Please contact customer service for availability.

EC-8 QR Pendent and Recessed Pendent Sprinklers K=8.0, 3/4" N.P.T. ECLH

100 Box Quantity (24 lbs/box) (SIN TY4232)

Section 1
Standard Spray Sprinklers

Section 2
Extended Coverage Sprinklers

Section 3
Storage Sprinklers

Section 4
Residential Sprinklers

Section 5
Dry Sprinklers

Section 6
Special Sprinklers

Section 7
Nozzles and Sprinkler Accessories

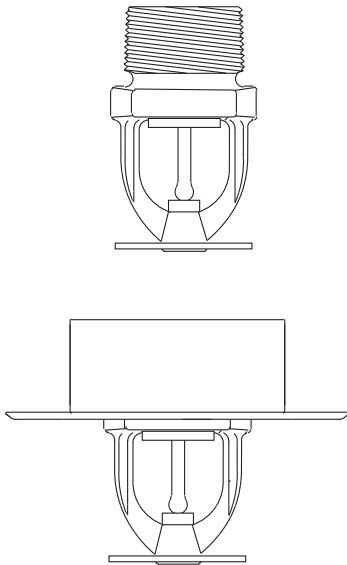

C.O.	Number	Model	Finish	Temperature	List Price
	50-801-1-135	EC-8 QR	Brass	135°F/57°C	\$30.75
	50-801-1-155	EC-8 QR	Brass	155°F/68°C	\$30.75
	50-801-9-135	EC-8 QR	Chrome	135°F/57°C	\$33.50
	50-801-9-155	EC-8 QR	Chrome	155°F/68°C	\$33.50
	50-801-4-135	EC-8 QR	White	135°F/57°C	\$33.50
	50-801-4-155	EC-8 QR	White	155°F/68°C	\$33.50
Recessed Escutcheons (Order Separately)					
	56-705-2-011	3/4" Brass Recessed (Style 30)			\$7.70
	56-705-9-011	3/4" Chrome Recessed (Style 30)			\$5.50
	56-705-4-011	3/4" White Recessed (Style 30)			\$5.50
	56-700-2-010	3/4" Brass Recessed (Style 40)			\$7.70
	56-700-9-010	3/4" Chrome Recessed (Style 40)			\$5.50
	56-700-4-010	3/4" White Recessed (Style 40)			\$5.50
Sprinkler Wrench					
	56-895-1-001	W-Type 3 Wrench			\$56.75
	56-000-6-838	W-Type 23 Wrench (Recessed Only)			\$68.25
Technical Data Sheet: TFP223					

EC-5 QR Pendent, Recessed Pendent and Sidewall Sprinklers K=5.6, 1/2" N.P.T.

100 Box Quantity (Pendent 15 lbs/box (SIN TY3232), Sidewall 16 lbs/box (SIN TY3302))

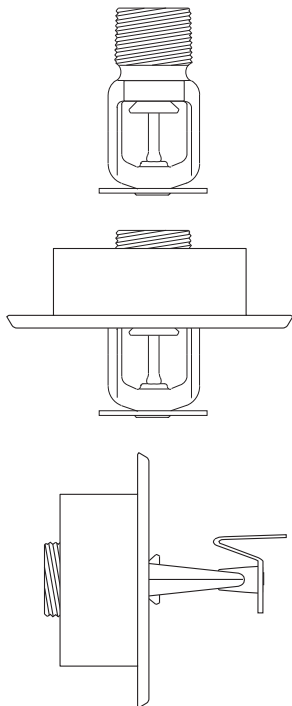

C.O.	Pendent	Sidewall	Model	Finish	Temperature	List Price
	51-051-1-135	51-053-1-135	EC-5 1/2"	Brass	135°F/57°C	\$34.75
	51-051-1-155	51-053-1-155	EC-5 1/2"	Brass	155°F/68°C	\$34.75
	-	51-053-1-200	EC-5 1/2"	Brass	200°F/93°C	\$34.75
	51-051-9-135	51-053-9-135	EC-5 1/2"	Chrome	135°F/57°C	\$37.50
	51-051-9-155	51-053-9-155	EC-5 1/2"	Chrome	155°F/68°C	\$37.50
	-	51-053-9-200	EC-5 1/2"	Chrome	200°F/93°C	\$37.50
	51-051-4-135	51-053-4-135	EC-5 1/2"	White	135°F/57°C	\$37.50
	51-051-4-155	51-053-4-155	EC-5 1/2"	White	155°F/68°C	\$37.50
	-	51-053-4-200	EC-5 1/2"	White	200°F/93°C	\$37.50
Recessed Escutcheons (Order Separately)						
	56-711-2-010	1/2" Brass Recessed (Style 50)				\$7.70
	56-711-9-010	1/2" Chrome Recessed (Style 50)				\$5.30
	56-711-4-010	1/2" White Recessed (Style 50)				\$5.30
Sprinkler Wrench						
	56-000-6-387	W-Type 6 Wrench				\$40.75
	56-850-4-001	W-Type 7 Wrench (Recessed Only)				\$68.25
Technical Data Sheet: Pendent-TFP228, Sidewall-TFP298						

See latest Technical Data Sheets for specific Approvals, Listings, Design Parameters & available finishes. Sprinkler heads & escutcheons are priced separately unless otherwise noted.

Items marked "C.O." are made to order and may require longer delivery times. Please contact customer service for availability.

Price Book - Section 3 Storage Sprinklers

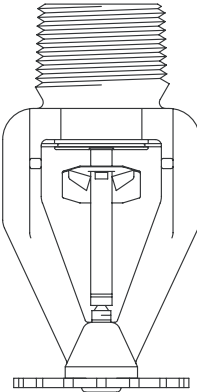
Model ESRF-25™, K=25.2, 1" NPT, Early Suppression, Fast Response Sprinkler					
50 Box Quantity (23 lbs/box) (SIN TY9226)					
	C.O.	Pendent	Description	Temperature	Price
		58-441-1-165	Brass	165°F (74°C)	\$73.00
		58-441-1-214	Brass	214°F (101°C)	\$73.00
	Sprinkler Wrench				
			56-872-1-025	W-Type 1 Wrench	
Technical Data Sheet: TFP312					

Section 1
Standard Spray Sprinklers

Section 2
Extended Coverage Sprinklers

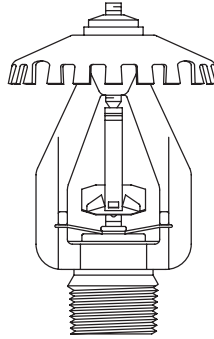
ESFR-17, K=16.8, 3/4" NPT, Early Suppression, Fast Response Upright Sprinkler					
50 Box Quantity (20 lbs/box) (SIN TY7126)					
	C.O.	Upright	Description	Temperature	Price
		58-447-1-165	Brass	165°F (74°C)	\$66.00
		58-447-1-214	Brass	214°F (101°C)	\$66.00
	Sprinkler Wrench				
			56-001-0-686	W-Type 21 Wrench	
Technical Data Sheet: TFP316					

Section 3
Storage Sprinklers

Section 4
Residential Sprinklers

Section 5
Dry Sprinklers

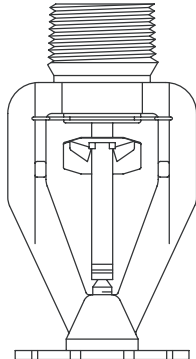
ESFR-17, K=16.8, 3/4" NPT, Early Suppression, Fast Response Pendent Sprinkler					
50 Box Quantity (20 lbs/box) (SIN TY7226)					
	C.O.	Pendent	Description	Temperature	Price
		58-445-1-165	Brass	165°F (74°C)	\$51.50
		58-445-1-214	Brass	214°F (101°C)	\$51.50
	Sprinkler Wrench				
			56-001-0-686	W-Type 21 Wrench	
Technical Data Sheet: TFP315					

Section 6
Special Sprinklers

Section 7
Nozzles and Sprinkler Accessories

See latest Technical Data Sheets for specific Approvals, Listings, Design Parameters & available finishes. Sprinkler heads & escutcheons are priced separately unless otherwise noted.

Items marked "C.O." are made to order and may require longer delivery times. Please contact customer service for availability.

Standard Spray Sprinklers
Section 1

Extended Coverage Sprinklers
Section 2

Storage Sprinklers
Section 3

Residential Sprinklers
Section 4

Dry Sprinklers
Section 5

Special Sprinklers
Section 6

Nozzles and Sprinkler Accessories
Section 7

Model ESFR-1, K=14.0, 3/4" NPT, Early Suppression, Fast Response Sprinkler

50 Box Quantity (21 lbs/box) (SIN TY6226)

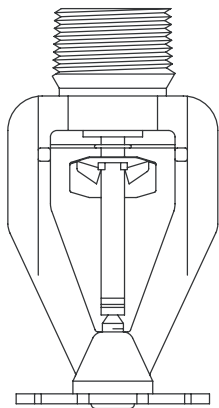

C.O.	Pendent	Description	Temperature	Price
	58-440-1-165	Brass	165°F (74°C)	\$42.00
	58-440-1-214	Brass	214°F (101°C)	\$42.00
Sprinkler Wrench				
	56-872-1-001	W-Type 2 Wrench		\$40.75

Technical Data Sheet: TFP318

Ultra K17, Upright, K=16.8, 3/4" Thread Specific Application

100 Box Quantity (31 lbs/box) (SIN TY7153)

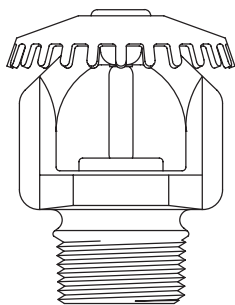

C.O.	Upright	Description	Temperature	Price
	51-887-1-155	Brass	155°F/68°C	\$59.75
	51-887-1-200	Brass	200°F/93°C	\$59.75
	51-887-1-286	Brass	286°F/141°C	P.O.A.
Sprinkler Wrench				
	56-892-1-001	W-Type 8 Wrench		\$68.25

Technical Data Sheet: TFP330

See latest Technical Data Sheets for specific Approvals, Listings, Design Parameters & available finishes. Sprinkler heads & escutcheons are priced separately unless otherwise noted.

Items marked "C.O." are made to order and may require longer delivery times. Please contact customer service for availability.

Price Book - Section 3 Storage Sprinklers

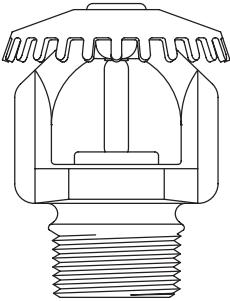
Model K17-231, K=16.8, 3/4" Thread, Upright Sprinkler					
100 Box Quantity, 31 lbs/box (SIN TY7151)					
	C.O.	Upright	Description	Temperature	Price
		51-888-1-155	Brass	155°F/68°C	\$34.25
		51-888-1-200	Brass	200°F/93°C	\$34.25
		51-888-1-286	Brass	286°F/141°C	\$34.25
	Sprinkler Wrench				
	56-892-1-001	W-Type 8 Wrench			\$68.25
<p>Technical Data Sheet: TFP332</p>					

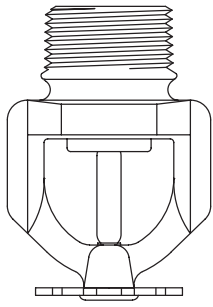
Model K17-231, K=16.8, 3/4" Thread, Pendent Sprinkler					
100 Box Quantity, 27 lbs/box (SIN TY7251)					
	C.O.	Pendent	Description	Temperature	Price
		51-889-1-155	Brass	155°F/68°C	\$31.75
		51-889-1-200	Brass	200°F/93°C	\$31.75
		51-889-1-286	Brass	286°F/141°C	\$31.75
	Sprinkler Wrench				
	56-892-1-001	W-Type 8 Wrench			\$68.25
<p>Technical Data Sheet: TFP332</p>					

Section 1
Standard Spray Sprinklers

Section 2
Extended Coverage Sprinklers

Section 3
Storage Sprinklers

Section 4
Residential Sprinklers

Section 5
Dry Sprinklers

Section 6
Special Sprinklers

Section 7
Nozzles and Sprinkler Accessories

See latest Technical Data Sheets for specific Approvals, Listings, Design Parameters & available finishes. Sprinkler heads & escutcheons are priced separately unless otherwise noted.

Items marked "C.O." are made to order and may require longer delivery times. Please contact customer service for availability.

**Model ELO-231 and ELO-231B, Standard Response,
Upright and Pendent Sprinklers K=11.2, 1/2" & 3/4" N.P.T.**

100 Box Quantity (ELO-231 - Upright 33 lbs/box (SIN-TY5111), Pendent 31lbs/box (SIN-TY5211), Upright - 1/2 NPT -TY5811)
(ELO-231B - Upright 36 lbs/box (SIN-TY5151), Pendent 33 lbs/box (SIN-TY5251), Upright - 1/2 NPT - TY5851)

Section 1
Standard Spray Sprinklers

Section 2
Extended Coverage Sprinklers

Section 3
Storage Sprinklers

Section 4
Residential Sprinklers

Section 5
Dry Sprinklers

Section 6
Special Sprinklers

Section 7
Nozzles and Sprinkler Accessories

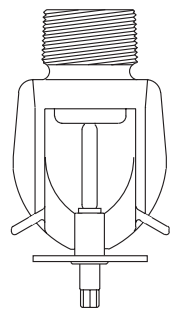
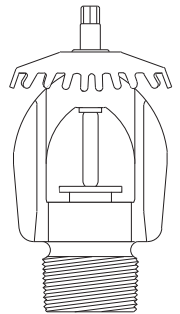
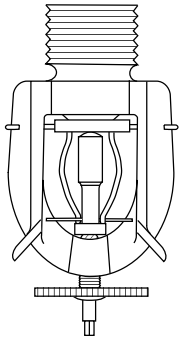
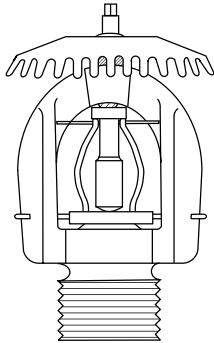

C.O.	Upright	Pendent	Model	Finish	Temperature	List Price
	50-510-1-155	50-512-1-155	ELO-231B	Brass	155°F/68°C	\$31.75
	50-510-1-200	50-512-1-200	ELO-231B	Brass	200°F/93°C	\$31.75
	50-510-1-286	50-512-1-286	ELO-231B	Brass	286°F/121°C	\$31.75
▶	50-510-7-155	50-512-7-155	ELO-231B	Lead Coated	155°F/68°C	\$72.50
▶	50-510-7-200	50-512-7-200	ELO-231B	Lead Coated	200°F/93°C	\$72.50
▶	50-510-7-286	50-512-7-286	ELO-231B	Lead Coated	286°F/121°C	\$72.50
▶	50-510-6-155	50-512-6-155	ELO-231B	Wax Coated	155°F/68°C	\$66.50
▶	50-510-6-200	50-512-6-200	ELO-231B	Wax Coated	200°F/93°C	\$66.50
▶	50-510-6-286	50-512-6-286	ELO-231B	Wax Coated	286°F/121°C	\$66.50
▶	50-510-8-155	50-512-8-155	ELO-231B	Wax over Lead	155°F/68°C	\$108.50
▶	50-510-8-200	50-512-8-200	ELO-231B	Wax over Lead	200°F/93°C	\$108.50
▶	50-510-8-286	50-512-8-286	ELO-231B	Wax over Lead	286°F/121°C	\$108.50
	50-110-1-165	50-112-1-165	ELO-231	Brass	165°F/74°C	\$33.50
	50-110-1-212	50-112-1-212	ELO-231	Brass	212°F/100°C	\$35.75
	50-110-1-286	50-112-1-286	ELO-231	Brass	286°F/141°C	\$33.50
▶	50-110-7-165	50-112-7-165	ELO-231	Lead Coated	155°F/68°C	\$72.50
▶	50-110-7-212	50-112-7-212	ELO-231	Lead Coated	200°F/93°C	\$72.50
▶	50-110-7-286	50-112-7-286	ELO-231	Lead Coated	286°F/121°C	\$72.50
▶	50-110-6-165	50-112-6-165	ELO-231	Wax Coated	155°F/68°C	\$66.50
▶	50-110-6-212	50-112-6-212	ELO-231	Wax Coated	200°F/93°C	\$66.50
▶	50-110-6-286	50-112-6-286	ELO-231	Wax Coated	286°F/121°C	\$66.50
▶	50-110-8-165	50-112-8-165	ELO-231	Wax over Lead	155°F/68°C	\$108.50
▶	50-110-8-212	50-112-8-212	ELO-231	Wax over Lead	200°F/93°C	\$108.50
▶	50-110-8-286	50-112-8-286	ELO-231	Wax over Lead	286°F/121°C	\$108.50
▶	50-501-1-155	-	ELO-231B x 1/2	Brass	155°F/68°C	\$47.75
▶	50-501-1-200	-	ELO-231B x 1/2	Brass	200°F/93°C	\$47.75
▶	50-501-1-286	-	ELO-231B x 1/2	Brass	286°F/121°C	\$47.75
▶	50-210-1-165	-	ELO-231 x 1/2	Brass	165°F/74°C	\$51.00
▶	50-210-1-212	-	ELO-231 x 1/2	Brass	212°F/100°C	\$51.00
▶	50-210-1-286	-	ELO-231 x 1/2	Brass	286°F/141°C	\$51.00

Sprinkler Wrench

56-895-1-001

W-Type 3 Wrench

\$56.75

Notes

ELO-231 = Strut
ELO-231B = 5mm Glass Bulb

Technical Data Sheet: TFP340 & TFP342

See latest Technical Data Sheets for specific Approvals, Listings, Design Parameters & available finishes. Sprinkler heads & escutcheons are priced separately unless otherwise noted.

Items marked "C.O." are made to order and may require longer delivery times. Please contact customer service for availability.

Price Book - Section 3 Storage Sprinklers

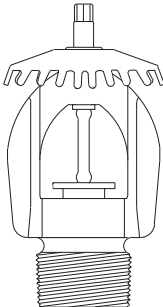
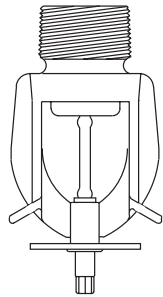
ELO-231 FRB, Quick Response, Upright, Pendent Sprinklers K=11.2, 3/4" N.P.T.							
100 Box Quantity (32 lbs/box) (SIN Upright TY5131) (SIN Pendent TY5231)							
	C.O.	Upright	Pendent	Model	Finis	Temperature	List Price
 		50-500-1-155	50-502-1-155	ELO-231FRB	Brass	155°F/68°C	\$47.75
		50-500-1-200	50-502-1-200	ELO-231FRB	Brass	200°F/93°C	\$47.75
		50-500-1-286	50-502-1-286	ELO-231FRB	Brass	286°F/141°C	\$47.75
	Sprinkler Wrench						
		56-895-1-001		W-Type 3 Wrench			\$56.75
Technical Data Sheet: TFP344							

Section 1
Standard Spray Sprinklers

Section 2
Extended Coverage Sprinklers

Section 3
Storage Sprinklers

Section 4
Residential Sprinklers

Section 5
Dry Sprinklers

Section 6
Special Sprinklers

Section 7
Nozzles and Sprinkler Accessories

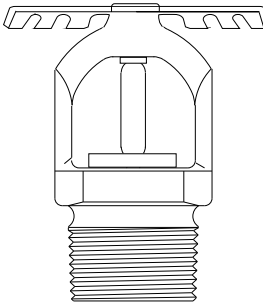
LD Large Drop Upright Sprinklers K=11.2, 3/4" N.P.T.						
100 Box Quantity (32 lbs/box) (SIN TY5153)						
	C.O.	Upright	Model	Finis	Temperature	List Price
		50-400-2-155	LD Large Drop	Brass	155°F/68°C	\$51.00
		50-400-2-200	LD Large Drop	Brass	200°F/93°C	\$51.00
		50-400-2-286	LD Large Drop	Brass	286°F/141°C	\$51.00
	Sprinkler Wrench					
		56-895-1-001	W-Type 3 Wrench			\$56.75
Technical Data Sheet: TFP335						

See latest Technical Data Sheets for specific Approvals, Listings, Design Parameters & available finishes. Sprinkler heads & escutcheons are priced separately unless otherwise noted.

Items marked "C.O." are made to order and may require longer delivery times. Please contact customer service for availability.

**TY-B, 5mm Bulb, K=5.6, 1/2" NPT, Standard Response,
Intermediate Level Upright and Pendent Sprinklers w/Shield**

50 Box Quantity (28 lbs/box) (Upright - SIN TY3153), (Pendent - SIN TY3251)

Section 1
Standard Spray Sprinklers

Section 2
Extended Coverage Sprinklers

Section 3
Storage Sprinklers

Section 4
Residential Sprinklers

Section 5
Dry Sprinklers

Section 6
Special Sprinklers

Section 7
Nozzles and Sprinkler Accessories

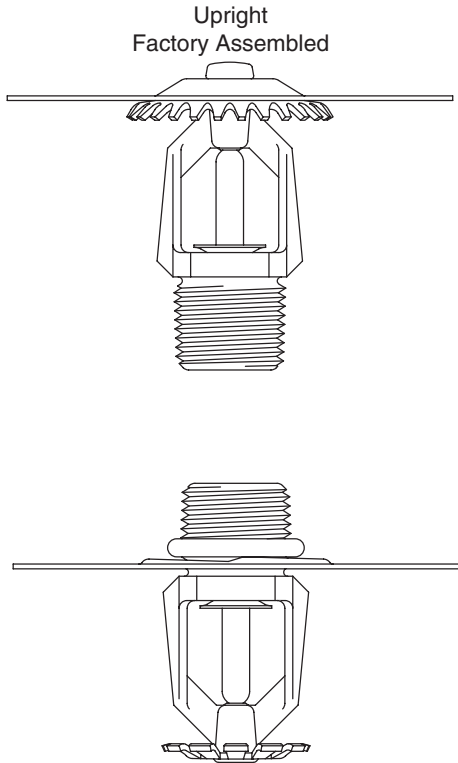

*Pendent Shown Field Assembled
(Order 57-571-X-XXX Sprinkler
and Shield Assembly Separately)

C.O.	Upright w/Shield	Description	Temperature	List Price
▶	57-533-1-135	Brass	135°F/57°C	\$22.75
	57-533-1-155	Brass	155°F/68°C	\$22.75
▶	57-533-1-175	Brass	175°F/79°C	\$22.75
	57-533-1-200	Brass	200°F/93°C	\$22.75
	57-533-1-286	Brass	286°F/141°C	\$22.75
▶	57-533-1-360	Brass	360°F/182°C	\$25.25
▶	57-533-7-135	Lead Coated	135°F/57°C	\$59.00
▶	57-533-7-155	Lead Coated	155°F/68°C	\$59.00
▶	57-533-7-175	Lead Coated	175°F/79°C	\$59.00
▶	57-533-7-200	Lead Coated	200°F/93°C	\$59.00
▶	57-533-7-286	Lead Coated	286°F/141°C	\$59.00
▶	57-533-6-155	Wax Coated	155°F/68°C	\$55.50
▶	57-533-6-175	Wax Coated	175°F/79°C	\$55.50
▶	57-533-6-200	Wax Coated	200°F/93°C	\$55.50
▶	57-533-6-286	Wax Coated	286°F/141°C	\$55.50
▶	57-533-8-135	Wax over Lead Coated	135°F/57°C	\$73.25
▶	57-533-8-155	Wax over Lead Coated	155°F/68°C	\$73.25
▶	57-533-8-175	Wax over Lead Coated	175°F/79°C	\$73.25
▶	57-533-8-200	Wax over Lead Coated	200°F/93°C	\$73.25
▶	57-533-8-286	Wax over Lead Coated	286°F/141°C	\$73.25

Sprinkler Accessories for Pendent Version

For pendent TY-B with S2 Shield, order the pendent TY-B sprinkler (57-571-X-XXX) and the S2 deflector shield and O-Ring assembly separately

56-070-9-332	1/2" NPT, S2 Pendent Shield and O-Ring Assembly	\$6.20
Sprinkler Wrench		
56-000-6-387	W-Type 6 Wrench	\$40.75

Technical Data Sheet: TFP351

See latest Technical Data Sheets for specific Approvals, Listings, Design Parameters & available finishes. Sprinkler heads & escutcheons are priced separately unless otherwise noted.

Items marked "C.O." are made to order and may require longer delivery times. Please contact customer service for availability.

Price Book - Section 3 Storage Sprinklers

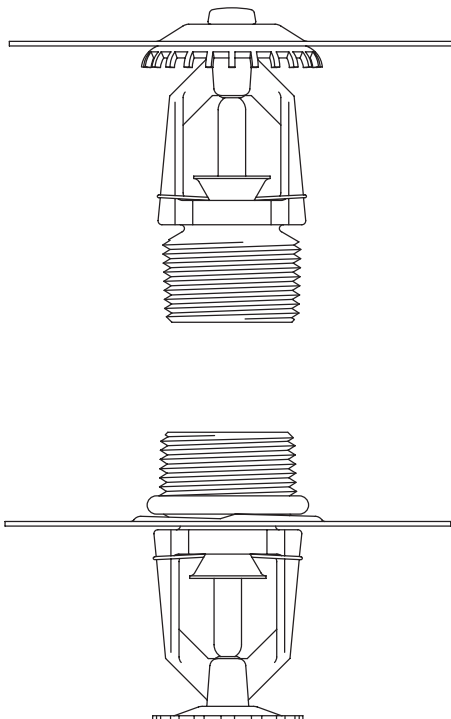
TY-B, 5mm Bulb, K=8.0, 3/4" NPT, Standard Response, Intermediate Level Upright and Pendent Sprinkler w/Shield					
50 Box Quantity (30 lbs/box) (Upright - SIN TY4153), (Pendent TY4251)					
	C.O.	Upright w/Shield	Finish	Temperature	List Price
 <p style="text-align: center;">*Pendent Shown Field Assembled (Order 57-591-X-XXX Sprinkler and Shield Assembly Separately)</p>	D	57-543-1-135	Brass	135°F/57°C	\$25.25
		57-543-1-155	Brass	155°F/68°C	\$25.25
	D	57-543-1-175	Brass	175°F/79°C	\$25.25
		57-543-1-200	Brass	200°F/93°C	\$25.25
		57-543-1-286	Brass	286°F/141°C	\$25.25
	D	57-543-1-360	Brass	360°F/182°C	\$27.50
	D	57-543-7-135	Lead Coated	135°F/57°C	\$62.25
	D	57-543-7-155	Lead Coated	155°F/68°C	\$62.25
	D	57-543-7-175	Lead Coated	175°F/79°C	\$62.25
	D	57-543-7-200	Lead Coated	200°F/93°C	\$62.25
	D	57-543-7-286	Lead Coated	286°F/141°C	\$62.25
	D	57-543-6-155	Wax Coated	155°F/68°C	\$59.00
	D	57-543-6-175	Wax Coated	175°F/79°C	\$59.00
	D	57-543-6-200	Wax Coated	200°F/93°C	\$59.00
	D	57-543-6-286	Wax Coated	286°F/141°C	\$59.00
	D	57-543-8-135	Wax over Lead Coated	135°F/57°C	\$77.25
	D	57-543-8-155	Wax over Lead Coated	155°F/68°C	\$77.25
	D	57-543-8-175	Wax over Lead Coated	175°F/79°C	\$77.25
	D	57-543-8-200	Wax over Lead Coated	200°F/93°C	\$77.25
	D	57-543-8-286	Wax over Lead Coated	286°F/141°C	\$77.25
Sprinkler Accessories for Pendent Version					
For pendent TY-B with S2 Shield, order the pendent TY-B sprinkler (57-591-X-XXX) and the S2 deflector shield and O-Ring Assembly separately					
	56-070-9-342	3/4" NPT, S2 Pendent Shield & O-Ring Assembly			\$6.20
Sprinkler Wrench					
	56-000-6-387	W-Type 6 Wrench			\$40.75
Technical Data Sheet: TFP351					

Section 1 Standard Spray Sprinklers
 Section 2 Extended Coverage Sprinklers
 Section 3 Storage Sprinklers
 Section 4 Residential Sprinklers
 Section 5 Dry Sprinklers
 Section 6 Special Sprinklers
 Section 7 Nozzles and Sprinkler Accessories

See latest Technical Data Sheets for specific Approvals, Listings, Design Parameters & available finishes. Sprinkler heads & escutcheons are priced separately unless otherwise noted.

Items marked "C.O." are made to order and may require longer delivery times. Please contact customer service for availability.

**TY-FRB, 3mm Bulb, K=5.6, 1/2" NPT, Quick Response,
Intermediate Level Upright and Pendent Sprinklers w/Shield**

50 Box Quantity (28 lbs/box) - (Upright - SIN TY3133), (Pendent - SIN TY3231)

Section 1
Standard Spray Sprinklers

Section 2
Extended Coverage Sprinklers

Section 3
Storage Sprinklers

Section 4
Residential Sprinklers

Section 5
Dry Sprinklers

Section 6
Special Sprinklers

Section 7
Nozzles and Sprinkler Accessories

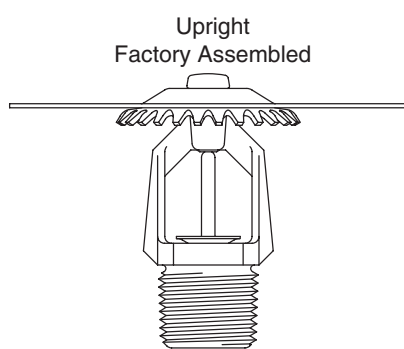
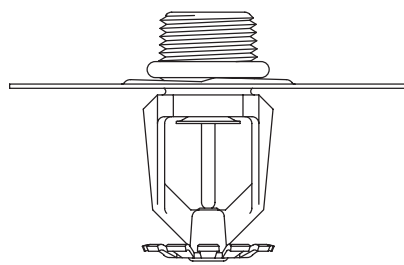
	C.O.	Upright w/Shield	Description	Temperature	Price
 <p>Upright Factory Assembled</p>	▶	57-333-1-135	Brass	135°F/57°C	\$34.50
		57-333-1-155	Brass	155°F/68°C	\$34.50
	▶	57-333-1-175	Brass	175°F/79°C	\$34.50
		57-333-1-200	Brass	200°F/93°C	\$34.50
		57-333-1-286	Brass	286°F/141°C	\$34.50
	▶	57-333-7-135	Lead Coated	135°F/57°C	\$79.25
	▶	57-333-7-155	Lead Coated	155°F/68°C	\$79.25
	▶	57-333-7-175	Lead Coated	175°F/79°C	\$79.25
	▶	57-333-7-200	Lead Coated	200°F/93°C	\$79.25
	▶	57-333-7-286	Lead Coated	286°F/141°C	\$79.25
 <p>*Pendent Shown Field Assembled (Order 57-371-X-XXX Sprinkler and Shield Assembly Separately)</p>	Sprinkler Accessories for Pendent Version				
	For pendent TY-FRB with Shield, order the pendent TY-FRB sprinkler (57-371-X-XXX) and the deflector shield and O-Ring Assembly separately				
		56-070-9-332	1/2" NPT, S2 Pendent Shield and O-Ring Assembly		\$6.20
Sprinkler Wrench					
	56-000-6-387	W-Type 6 Wrench		\$40.75	

Technical Data Sheet: TFP356

See latest Technical Data Sheets for specific Approvals, Listings, Design Parameters & available finishes. Sprinkler heads & escutcheons are priced separately unless otherwise noted.

Items marked "C.O." are made to order and may require longer delivery times. Please contact customer service for availability.

Price Book - Section 3 Storage Sprinklers

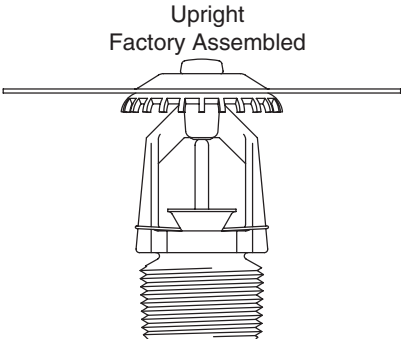
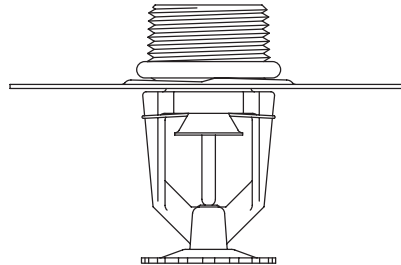
TY-FRB, 3mm Bulb, K=8.0, 3/4" NPT Quick Response, Intermediate Level Upright and Pendent Sprinklers w/Shield					
50 Box Quantity (30 lbs/box) - (Upright - SIN TY4133), (Pendent - SIN TY4231)					
	C.O.	Upright w/Shield	Description	Temperature	Price
 <p style="text-align: center;">Upright Factory Assembled</p>	▶	57-343-1-135	Brass	135°F/57°C	\$37.50
		57-343-1-155	Brass	155°F/68°C	\$37.50
	▶	57-343-1-175	Brass	175°F/79°C	\$37.50
		57-343-1-200	Brass	200°F/93°C	\$37.50
		57-343-1-286	Brass	286°F/141°C	\$37.50
	▶	57-343-7-135	Lead Coated	135°F/57°C	\$87.75
	▶	57-343-7-155	Lead Coated	155°F/68°C	\$87.75
	▶	57-343-7-175	Lead Coated	175°F/79°C	\$87.75
	▶	57-343-7-200	Lead Coated	200°F/93°C	\$87.75
	▶	57-343-7-286	Lead Coated	286°F/141°C	\$87.75
Sprinkler Accessories for Pendent Version For pendent TY-FRB with Shield, order the pendent TY-FRB sprinkler (57-391-X-XXX) and the deflector shield and O-Ring Assembly separately					
	56-070-9-342	3/4" NPT Pendent Shield & O-Ring Assembly			\$6.20
Sprinkler Wrench					
	56-000-6-387	W-Type 6 Wrench			\$40.75
 <p style="text-align: center;">*Pendent Shown Field Assembled (Order 57-391-X-XXX Sprinkler and Shield Assembly Separately)</p>					
Technical Data Sheet: TFP356					

Section 1
Standard Spray Sprinklers

Section 2
Extended Coverage Sprinklers

Section 3
Storage Sprinklers

Section 4
Residential Sprinklers

Section 5
Dry Sprinklers

Section 6
Special Sprinklers

Section 7
Nozzles and Sprinkler Accessories

See latest Technical Data Sheets for specific Approvals, Listings, Design Parameters & available finishes. Sprinkler heads & escutcheons are priced separately unless otherwise noted.

Items marked "C.O." are made to order and may require longer delivery times. Please contact customer service for availability.

**TY-L, K=5.6, 1/2" NPT, Standard Response
Intermediate Level Upright and Pendent Sprinklers w/Shield**

(Upright - SIN TY3113), (Pendent - SIN TY3211)

Section 1
Standard Spray Sprinklers

Section 2
Extended Coverage Sprinklers

Section 3
Storage Sprinklers

Section 4
Residential Sprinklers

Section 5
Dry Sprinklers

Section 6
Special Sprinklers

Section 7
Nozzles and Sprinkler Accessories

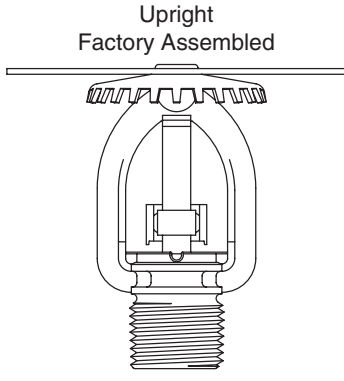
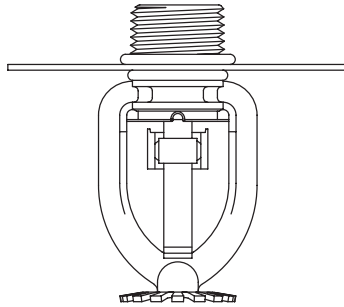
	<i>C.O.</i>	<i>Upright w/Shield</i>	<i>Description</i>	<i>Temperature</i>	<i>Price</i>
 <p>Upright Factory Assembled</p>	▶	53-253-1-135	Brass	135°F/57°C	\$24.75
		53-253-1-165	Brass	165°F (74°C)	\$24.75
	▶	53-253-1-212	Brass	212°F/100°C	\$24.75
		53-253-1-280	Brass	280°F/138°C	\$24.75
Sprinkler Accessories for Pendent Version					
For pendent TY-L with Shield, order the pendent TY-L sprinkler (53-112-X-XXX) and the deflector shield and O-Ring Assembly separately					
		56-015-6-802	1/2" TY-L Shield Package (Shield/O-Ring)		\$6.20
Sprinkler Wrench					
		56-000-1-849	W-Type 9 Wrench		\$36.50
 <p>*Pendent Shown Field Assembled (Order 53-112-X-XXX Sprinkler and Shield Assembly Separately)</p>					

Technical Data Sheet: TFP350

See latest Technical Data Sheets for specific Approvals, Listings, Design Parameters & available finishes. Sprinkler heads & escutcheons are priced separately unless otherwise noted.

Items marked "C.O." are made to order and may require longer delivery times. Please contact customer service for availability.

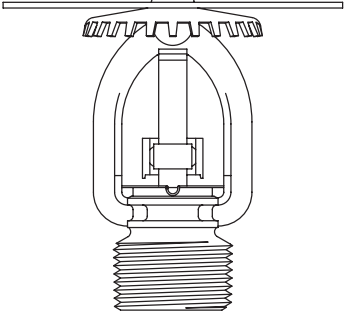
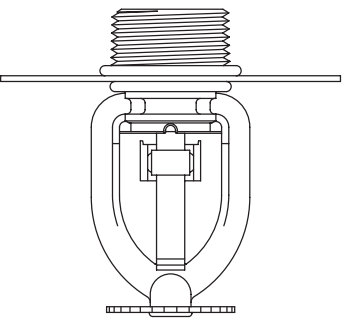
TY-L, K=8.0, 3/4" NPT, Standard Response Intermediate Level Upright and Pendent Sprinklers w/Shield (Upright - SIN TY4113), (Pendent - SIN TY4211)					
	<i>C.O.</i>	<i>Upright w/Shield</i>	<i>Description</i>	<i>Temperature</i>	<i>Price</i>
 <p>Upright Factory Assembled</p>	▶	53-153-1-135	Brass	135°F/57°C	\$34.25
		53-153-1-165	Brass	165°F (74°C)	\$34.25
	▶	53-153-1-212	Brass	212°F/100°C	\$34.25
		53-153-1-280	Brass	280°F/138°C	\$34.25
 <p>Pendent Field Assembled (order separately) 53-102-X-XXX Sprinkler Shield</p>	Sprinkler Accessories for Pendent Version For pendent TY-L with Shield, order the pendent TY-L sprinkler (53-102-X-XXX) and the deflector shield and O-Ring separately				
		56-015-6-803	3/4" TY-L Shield Package (Shield/(2)O-Ring)		\$6.20
	Sprinkler Wrench				
		56-000-1-849	W-Type 9 Wrench		\$36.50
Technical Data Sheet: TFP350					

Section 1
Standard Spray Sprinklers

Section 2
Extended Coverage Sprinklers

Section 3
Storage Sprinklers

Section 4
Residential Sprinklers

Section 5
Dry Sprinklers

Section 6
Special Sprinklers

Section 7
Nozzles and Sprinkler Accessories

See latest Technical Data Sheets for specific Approvals, Listings, Design Parameters & available finishes. Sprinkler heads & escutcheons are priced separately unless otherwise noted.

Items marked "C.O." are made to order and may require longer delivery times. Please contact customer service for availability.

**TY-FRL, K=5.6, 1/2" Male NPT, Quick Response,
Intermediate Level Upright and Pendent Sprinkler w/Shield**

(Upright - SIN TY3123), (Pendent - SIN TY3221)

Section 1
Standard Spray Sprinklers

Section 2
Extended Coverage Sprinklers

Section 3
Storage Sprinklers

Section 4
Residential Sprinklers

Section 5
Dry Sprinklers

Section 6
Special Sprinklers

Section 7
Nozzles and Sprinkler Accessories

Upright
Factory Assembled

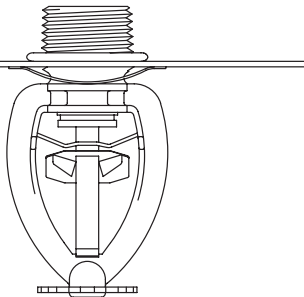
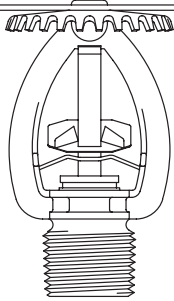

*Pendent Shown Field Assembled
(Order 57-972-X-XXX Sprinkler
and Shield Assembly Separately)

C.O.	Upright w/Shield	Description	Temperature	Price
	58-986-1-165	Brass	165°F (74°C)	\$53.25
Sprinkler Accessories for Pendent Version				
For pendent TY-FRL with Shield, order the pendent TY-FRL sprinkler (57-982-X-XXX) and the deflector shield and O-Ring Assembly separately				
	56-952-1-001	Brass 1/2" NPT, Pendent Shield /O-Ring/Speed Nut assembly		\$6.20
Sprinkler Wrench				
	56-000-1-849	W-Type 9 Wrench		\$36.50

Technical Data Sheet: TFP355

See latest Technical Data Sheets for specific Approvals, Listings, Design Parameters & available finishes. Sprinkler heads & escutcheons are priced separately unless otherwise noted.

Items marked "C.O." are made to order and may require longer delivery times. Please contact customer service for availability.

TY-FRL, K=8.0, 3/4" NPT, Quick Response, Intermediate Level Upright and Pendent Sprinkler w/Shield						
(Upright - SIN TY4123), (Pendent - SIN TY4221)						
	<i>C.O.</i>	<i>Upright w/Shield</i>	<i>Description</i>	<i>Temperature</i>	<i>Price</i>	
		58-153-1-165	Brass	165°F (74°C)	\$61.50	
	Sprinkler Accessories for Pendent Version					
	For pendent TY-FRL with Shield, order the pendent TY-FRL sprinkler (58-172-X-XXX) and the deflector shield and O-Ring Assembly separately					
			56-152-1-001	3/4" Shield Assy. Brass/O-Ring/Speed Nut		\$6.20
	Sprinkler Wrench					
		56-000-1-849	W-Type 9 Wrench		\$36.50	
Technical Data Sheet: TFP355						

Section 1
Standard Spray Sprinklers

Section 2
Extended Coverage Sprinklers

Section 3
Storage Sprinklers

Section 4
Residential Sprinklers

Section 5
Dry Sprinklers

Section 6
Special Sprinklers

Section 7
Nozzles and Sprinkler Accessories

See latest Technical Data Sheets for specific Approvals, Listings, Design Parameters & available finishes. Sprinkler heads & escutcheons are priced separately unless otherwise noted.

Items marked "C.O." are made to order and may require longer delivery times. Please contact customer service for availability.

Section 1
Standard Spray Sprinklers

Section 2
Extended Coverage Sprinklers

**Section 3
Storage Sprinklers**

Section 4
Residential Sprinklers

Section 5
Dry Sprinklers

Section 6
Special Sprinklers

Section 7
Nozzles and Sprinkler Accessories

See latest Technical Data Sheets for specific Approvals, Listings, Design Parameters & available finishes. Sprinkler heads & escutcheons are priced separately unless otherwise noted.

Items marked "C.O." are made to order and may require longer delivery times. Please contact customer service for availability.

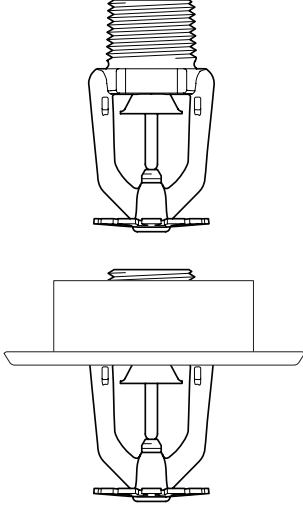
LF II - Low Flow Pendent, Fast Response, K=3.0 1/2" N.P.T.							
100 Box Quantity (Pendent 20 lbs/box (SIN TY1234))							
	<i>C.O.</i>	<i>Number</i>	<i>Model</i>	<i>Finish</i>	<i>Temperature</i>	<i>List Price</i>	
		51-010-1-155	LFII Pendent	Brass	155°F/68°C	\$29.75	
		51-010-1-175	LFII Pendent	Brass	175°F/79°C	\$29.75	
		51-010-9-155	LFII Pendent	Chrome	155°F/68°C	\$33.00	
		51-010-9-175	LFII Pendent	Chrome	175°F/79°C	\$33.00	
		51-010-4-155	LFII Pendent	White	155°F/68°C	\$33.00	
		51-010-4-175	LFII Pendent	White	175°F/79°C	\$33.00	
	Recessed Escutcheons (Order Separately)						
			56-705-2-010	1/2" Bright Brass (Style 20)			\$7.70
			56-705-9-010	1/2" Chrome Plated (Style 20)			\$5.30
			56-705-4-010	1/2" White (Style 20)			\$5.30
Sprinkler Wrench							
		56-000-6-387	W-Type 6 Wrench			\$40.75	
		56-850-4-001	W-Type 7 Wrench (Recessed Only)			\$68.25	
Notes:							
		92-000-0-412	Plastic Cap Protective Cover. (Net Price Each)			\$0.20	
Technical Data Sheet: Pendent TFP402, Design Guide: TFP490							

Section 1
Standard Spray Sprinklers

Section 2
Extended Coverage Sprinklers

Section 3
Storage Sprinklers

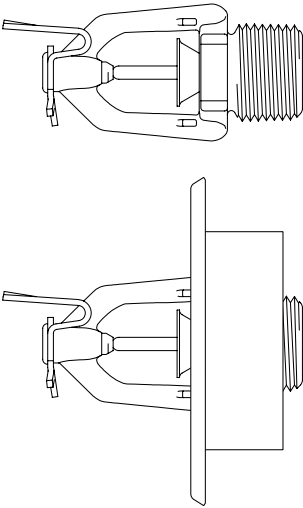
LF II - Low Flow Horizontal Sidewall, K=4.2(HSW), 1/2" N.P.T.							
100 Box Quantity HSW 19 lbs/box (SIN TY1334))							
	<i>C.O.</i>	<i>Number</i>	<i>Model</i>	<i>Finish</i>	<i>Temperature</i>	<i>List Price</i>	
		51-211-1-155	LFII Sidewall	Brass	155°F/68°C	\$31.50	
		51-211-1-175	LFII Sidewall	Brass	175°F/79°C	\$31.50	
		51-211-9-155	LFII Sidewall	Chrome	155°F/68°C	\$33.50	
		51-211-9-175	LFII Sidewall	Chrome	175°F/79°C	\$33.50	
		51-211-4-155	LFII Sidewall	White	155°F/68°C	\$33.50	
		51-211-4-175	LFII Sidewall	White	175°F/79°C	\$33.50	
	Recessed Escutcheons (Order Separately)						
			56-705-2-010	1/2" Bright Brass (Style 20)			\$7.70
			56-705-9-010	1/2" Chrome Plated (Style 20)			\$5.30
			56-705-4-010	1/2" White (Style 20)			\$5.30
Sprinkler Wrench							
		56-000-6-387	W-Type 6 Wrench			\$40.75	
		56-850-4-001	W-Type 7 Wrench (Recessed Only)			\$68.25	
Notes:							
		92-000-0-412	Plastic Cap Protective Cover. (Net Price Each)			\$0.20	
Technical Data Sheet: Pendent TFP400, HSW TFP410, Design Guide: TFP490							

Section 4
Residential Sprinklers

Section 5
Dry Sprinklers

Section 6
Special Sprinklers

Section 7
Nozzles and Sprinkler Accessories

See latest Technical Data Sheets for specific Approvals, Listings, Design Parameters & available finishes. Sprinkler heads & escutcheons are priced separately unless otherwise noted.

Items marked "C.O." are made to order and may require longer delivery times. Please contact customer service for availability.

LF II - Low Flow Horizontal Sidewall, K=4.4, 1/2" N.P.T.

SIN TY2334

Section 1
Standard Spray Sprinklers

Section 2
Extended Coverage Sprinklers

Section 3
Storage Sprinklers

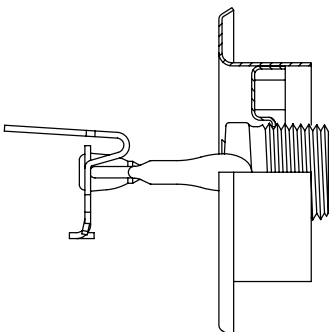
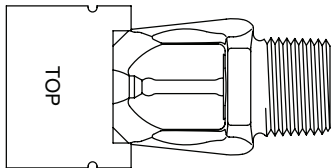

C.O.	Number	Model	Finish	Temperature	List Price
	51-215-1-155	LFII Sidewall	Brass	155°F/68°C	\$31.50
▶	51-215-1-175	LFII Sidewall	Brass	175°F/79°C	\$31.50
	51-215-9-155	LFII Sidewall	Chrome	155°F/68°C	\$33.50
▶	51-215-9-175	LFII Sidewall	Chrome	175°F/79°C	\$33.50
	51-215-4-155	LFII Sidewall	White	155°F/68°C	\$33.50
▶	51-215-4-175	LFII Sidewall	White	175°F/79°C	\$33.50

Recessed Escutcheons (Order Separately)

▶	56-705-2-010	1/2" Bright Brass (Style 20)	\$7.70
	56-705-9-010	1/2" Chrome Plated (Style 20)	\$5.30
	56-705-4-010	1/2" White (Style 20)	\$5.30

Sprinkler Wrench

	56-000-6-387	W-Type 6 Wrench	\$40.75
	56-850-4-001	W-Type 7 Wrench (Recessed Only)	\$68.25

Notes:

	92-000-0-412	Plastic Cap Protective Cover. (Net Price Each)	\$0.20
--	--------------	--	--------

Technical Data Sheet: TFP412, Design Guide: TFP490

LF II - Low Flow Pendent, K=4.9 (pendent), 1/2" N.P.T.

100 Box Quantity (Pendent 20 lbs/box (SIN TY2234))

Section 4
Residential Sprinklers

Section 5
Dry Sprinklers

Section 6
Special Sprinklers

Section 7
Nozzles and Sprinkler Accessories

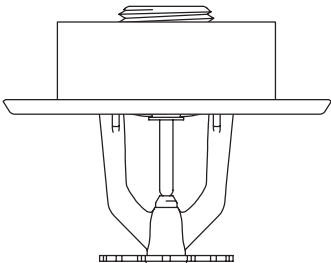
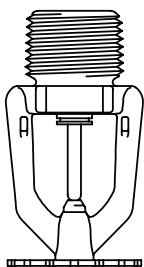

C.O.	Number	Model	Finish	Temperature	List Price
	51-201-1-155	LFII Pendent	Brass	155°F/68°C	\$29.75
▶	51-201-1-175	LFII Pendent	Brass	175°F/79°C	\$29.75
	51-201-9-155	LFII Pendent	Chrome	155°F/68°C	\$33.00
▶	51-201-9-175	LFII Pendent	Chrome	175°F/79°C	\$33.00
	51-201-4-155	LFII Pendent	White	155°F/68°C	\$33.00
▶	51-201-4-175	LFII Pendent	White	175°F/79°C	\$33.00

Recessed Escutcheons (Order Separately)

▶	56-705-2-010	1/2" Bright Brass (Style 20)	\$7.70
	56-705-9-010	1/2" Chrome Plated (Style 20)	\$5.30
	56-705-4-010	1/2" White (Style 20)	\$5.30

Sprinkler Wrench

	56-000-6-387	W-Type 6 Wrench	\$40.75
	56-850-4-001	W-Type 7 Wrench (Recessed Only)	\$68.25

Notes:

	92-000-0-412	Plastic Cap Protective Cover. (Net Price Each)	\$0.20
--	--------------	--	--------

**Technical Data Sheet: Pendent TFP400,
HSW TFP410, Design Guide: TFP490**

See latest Technical Data Sheets for specific Approvals, Listings, Design Parameters & available finishes. Sprinkler heads & escutcheons are priced separately unless otherwise noted.

Items marked "C.O." are made to order and may require longer delivery times. Please contact customer service for availability.

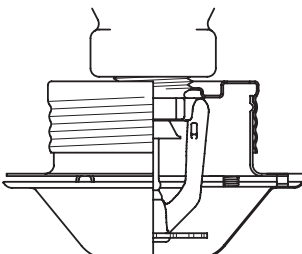
LFII - Residential Concealed Pendent Sprinkler, Domed Plate, K=4.9, 1/2" N.P.T.							
(SIN TY2234)							
	<i>C.O.</i>	<i>Number</i>	<i>Model</i>	<i>Finish</i>	<i>Temperature</i>	<i>List Price</i>	
 <p>Note: All "Special Order" cover plates are special ordered and are Non-Returnable. Please see "Terms & Conditions"</p>		51-873-1-155	LFII Pendent Sprinkler	Brass	155°F/68°C	\$42.75	
	Cover Plates (Order Separately)						
			56-873-9-135	LFII Cover Plate	Chrome	135°F/57°C	\$21.00
			56-873-4-135	LFII Cover Plate	Signal (Bright) White	135°F/57°C	\$21.00
			56-873-X-135	LFII Cover Plate	Special Order*	135°F/57°C	\$23.50
	Sprinkler Wrench						
			56-850-4-001	W-Type 7 Wrench			\$68.25
	Notes						
			6012	*Special Order paint match subject to set-up charge. (Net Price)			\$315.50
	Technical Data Sheet: TFP450 Design Guide: TFP490						

Section 1
Standard Spray Sprinklers

Section 2
Extended Coverage Sprinklers

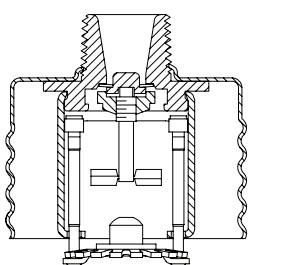
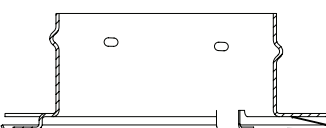
LFII - Residential Concealed Sprinkler, K=4.2, 1/2" N.P.T.							
(SIN TY2596)							
	<i>C.O.</i>	<i>Number</i>	<i>Model</i>	<i>Finish</i>	<i>Temperature</i>	<i>List Price</i>	
  <p>Note: While Inventory Lasts</p> <p>Note: All "Special Order" cover plates are special ordered and are Non-Returnable. Please see "Terms & Conditions"</p>		51-122-1-160	LFII Pendent Sprinkler	Brass	160°F/71°C	\$48.75	
	Cover Plates (Order Separately)						
			56-122-9-135	LFII Cover Plate	Chrome	135°F/57°C	\$19.50
			56-122-0-135	LFII Cover Plate	Grey White	135°F/57°C	\$19.50
			56-122-4-135	LFII Cover Plate	Signal (Bright) White	135°F/57°C	\$19.50
			56-122-X-135	LFII Cover Plate	Special Order*	135°F/57°C	\$19.50
	Sprinkler Wrench						
			56-000-1-265	W-Type 18 Wrench			\$68.25
	Notes						
			6012	*Special Order paint match subject to set-up charge. (Net Price)			\$315.50
Technical Data Sheet: TFP412 Design Guide: TFP490							

Section 3
Storage Sprinklers

Section 4
Residential Sprinklers

Section 5
Dry Sprinklers

Section 6
Special Sprinklers

See latest Technical Data Sheets for specific Approvals, Listings, Design Parameters & available finishes. Sprinkler heads & escutcheons are priced separately unless otherwise noted.

Items marked "C.O." are made to order and may require longer delivery times. Please contact customer service for availability.

LFII - Residential Concealed Sprinkler, K=4.9, 1/2" N.P.T.

(SIN TY3596)

Standard Spray Sprinklers
Section 1

Extended Coverage Sprinklers
Section 2

Storage Sprinklers
Section 3

Residential Sprinklers
Section 4

Dry Sprinklers
Section 5

Special Sprinklers
Section 6

Nozzles and Sprinkler Accessories
Section 7

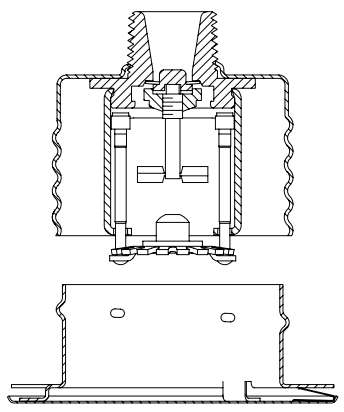

C.O.	Number	Model	Finish	Temperature	List Price
	51-112-1-160	LFII Pendent Sprinkler	Brass	160°F/71°C	\$48.75
Cover Plates (Order Separately)					
▶	56-122-9-135	LFII Cover Plate	Chrome	135°F/57°C	\$19.50
	56-122-0-135	LFII Cover Plate	Grey White	135°F/57°C	\$19.50
▶	56-122-4-135	LFII Cover Plate	Signal (Bright) White	135°F/57°C	\$19.50
▶	56-122-X-135	LFII Cover Plate	Special Order*	135°F/57°C	\$19.50
Sprinkler Wrench					
	56-000-1-265	W-Type 18 Wrench			\$68.25
Notes					
	6012	*Special Order paint match subject to set-up charge. (Net Price).			\$315.50

Note: All "Special Order" cover plates are special ordered and are Non-Returnable. Please see "Terms & Conditions"

Technical Data Sheet: TFP412
Design Guide: TFP490

Model LFII, K=4.2, Residential Flush Pendent

(SIN TY2284)

Residential Sprinklers
Section 4

Dry Sprinklers
Section 5

Special Sprinklers
Section 6

Nozzles and Sprinkler Accessories
Section 7

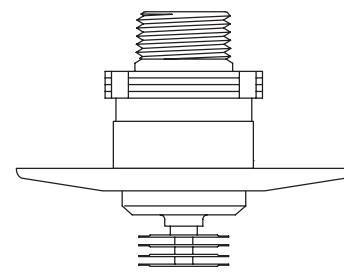

C.O.	Pendent	Finish	Temperature	List Price
	51-123-0-162	Chrome	162°F (72°C)	\$61.50
	51-123-4-162	White	162°F (72°C)	\$61.50
	51-123-6-162	Black	162°F (72°C)	\$73.25
	51-123-1-162	Antique Brass	162°F (72°C)	\$73.25
Trim Plates (Order Separately)				
	56-123-9-001	Chrome Escutcheon		\$6.10
	56-123-4-001	White Escutcheon		\$6.10
	56-123-6-001	Black Escutcheon		\$6.10
	56-123-1-001	Antique Brass Escutcheon		\$6.10
Sprinkler Wrench				
	56-000-4-947	Wrench (Socket Only)		\$73.00
	56-000-4-948	Socket/Ratchet Wrench		\$108.50
	56-000-4-300	Protective Cover Removal Tool		\$24.25

Technical Data Sheet: TFP420
Design Guide: TFP490

See latest Technical Data Sheets for specific Approvals, Listings, Design Parameters & available finishes. Sprinkler heads & escutcheons are priced separately unless otherwise noted.

Items marked "C.O." are made to order and may require longer delivery times. Please contact customer service for availability.

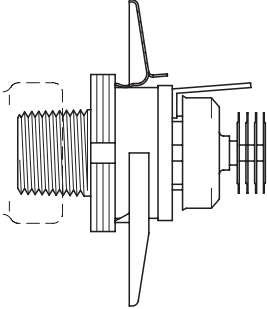
Model LFII, K=4.2, Residential Flush Horizontal Sidewall Sprinkler						
(SIN TY2384)						
	<i>C.O.</i>	<i>Horizontal Sidewall</i>	<i>Finish</i>	<i>Temperature</i>	<i>List Price</i>	
		51-124-9-162	Chrome	162°F (72°C)	\$61.50	
		51-124-4-162	White	162°F (72°C)	\$61.50	
		51-124-5-162	Black	162°F (72°C)	\$73.25	
	Trim Plates (Order Separately)					
		56-124-9-001	Chrome Escutcheon			\$6.10
		56-124-4-001	White Escutcheon			\$6.10
		56-124-5-001	Black Escutcheon			\$6.10
	Sprinkler Wrench					
		56-000-4-949	Wrench (Socket Only)			\$73.00
		56-000-4-950	Socket/Ratchet Wrench			\$108.50
	56-000-4-300	Protective Cover Removal Tool			\$24.25	
Technical Data Sheet: TFP425						
Design Guide: TFP490						

Section 1
Standard Spray Sprinklers

Section 2
Extended Coverage Sprinklers

Section 3
Storage Sprinklers

Section 4
Residential Sprinklers

Section 5
Dry Sprinklers

Section 6
Special Sprinklers

Section 7
Nozzles and Sprinkler Accessories

See latest Technical Data Sheets for specific Approvals, Listings, Design Parameters & available finishes. Sprinkler heads & escutcheons are priced separately unless otherwise noted.

Items marked "C.O." are made to order and may require longer delivery times. Please contact customer service for availability.

**Model LFII, K=5.8 & K=5.6, Residential,
NFPA 13 Optimized Horizontal Sidewall Sprinklers**

(K=5.8 SIN TY4334)(K=5.6 SIN TY3334)

Section 1
Standard Spray Sprinklers

Section 2
Extended Coverage Sprinklers

Section 3
Storage Sprinklers

Section 4
Residential Sprinklers

Section 5
Dry Sprinklers

Section 6
Special Sprinklers

Section 7
Nozzles and Sprinkler Accessories

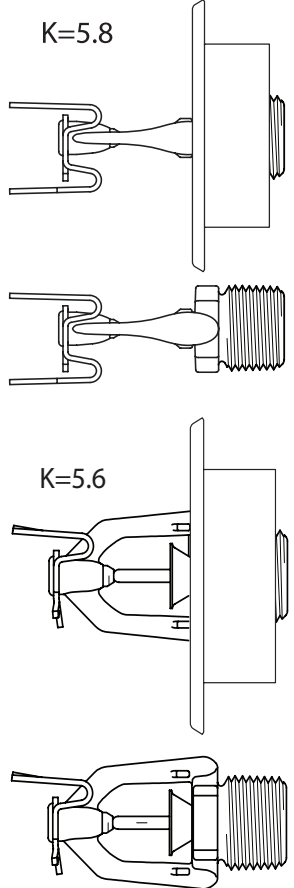

C.O.	K=5.8 Part Numbers	K=5.6 Part Numbers	Finish	Temperature	List Price
	51-534-1-155	51-524-1-155	Brass	155°F (68°C)	\$35.50
	51-534-1-175	51-524-1-175	Brass	175°F (79°C)	\$35.50
	51-534-9-155	51-524-9-155	Chrome	155°F (68°C)	\$35.50
	51-534-9-175	51-524-9-175	Chrome	175°F (79°C)	\$35.50
	51-534-4-155	51-524-4-155	White	155°F (68°C)	\$35.50
	51-534-4-175	51-524-4-175	White	175°F (79°C)	\$35.50
Recessed Escutcheons (Order Separately)					
	56-705-2-010	1/2" Brass Plated (Style 20)			\$7.70
	56-705-9-010	1/2" Chrome Plated (Style 20)			\$5.30
	56-705-4-010	1/2" White Color Plated (Style 20)			\$5.30
Sprinkler Wrench					
	56-000-6-387	W-Type 6 Sprinkler Wrench			\$40.75
	56-850-4-001	W-Type 7 Sprinkler Wrench			\$68.25

**Technical Data Sheet: K=5.8 - TFP417, K=5.6 - TFP415
Design Guide: TFP490**

See latest Technical Data Sheets for specific Approvals, Listings, Design Parameters & available finishes. Sprinkler heads & escutcheons are priced separately unless otherwise noted.

Items marked "C.O." are made to order and may require longer delivery times. Please contact customer service for availability.

Price Book - Section 4 Residential Sprinklers

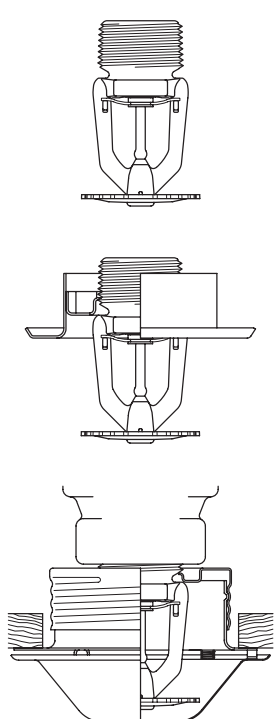
LFII - Residential NFPA 13 Optimized Pendent, Recessed and Concealed Sprinklers, K=6.9, 3/4" N.P.T.							
100 Box Quantity (SIN TY4234)							
	C.O.	Number	Model	Finish	Temperature	List Price	
		51-069-1-155	LFII Pendent Sprinkler	Brass	155°F/68°C	\$34.50	
		51-069-1-175	LFII Pendent Sprinkler	Brass	175°F/79°C	\$34.50	
		51-069-9-155	LFII Pendent Sprinkler	Chrome	155°F/68°C	\$36.75	
		51-069-9-175	LFII Pendent Sprinkler	Chrome	175°F/79°C	\$36.75	
		51-069-4-155	LFII Pendent Sprinkler	White	155°F/68°C	\$36.75	
		51-069-4-175	LFII Pendent Sprinkler	White	175°F/79°C	\$36.75	
		51-068-1-155	LFII Concealed Pendent Sprinkler			155°F/68°C	\$44.25
		51-068-1-175	LFII Concealed Pendent Sprinkler			175°F/79°C	\$44.25
		Cover Plates (Order Separately)					
			56-873-9-135	LFII Cover Plate	Chrome	135°F/57°C	\$21.00
			56-873-0-135	LFII Cover Plate	Grey White	135°F/57°C	\$21.00
			56-873-4-135	LFII Cover Plate	Signal (Bright) White	135°F/57°C	\$21.00
			56-873-X-135	LFII Cover Plate	Special Order*	135°F/57°C	\$23.50
		Recessed Escutcheons (Order Separately)					
			56-705-2-011	3/4" Bright Brass (Style 30)			\$7.70
		56-705-9-011	3/4" Chrome Plated (Style 30)			\$5.50	
		56-705-4-011	3/4" White (Style 30)			\$5.50	
	Sprinkler Wrench						
		56-000-6-387	W-Type 6 Wrench			\$40.75	
		56-850-4-001	W-Type 7 Wrench (Recessed & Concealed Only)			\$68.25	
	Notes						
		6012	*Special Order paint match subject to set-up charge. (Net Price)			\$315.50	
Technical Data Sheet: TFP408							

Note: All "Special Order" cover plates are special ordered and are Non-Returnable. Please see "Terms & Conditions"

Section 1 Standard Spray Sprinklers
 Section 2 Extended Coverage Sprinklers
 Section 3 Storage Sprinklers
 Section 4 Residential Sprinklers
 Section 5 Dry Sprinklers
 Section 6 Special Sprinklers
 Section 7 Nozzles and Sprinkler Accessories

See latest Technical Data Sheets for specific Approvals, Listings, Design Parameters & available finishes. Sprinkler heads & escutcheons are priced separately unless otherwise noted.

Items marked "C.O." are made to order and may require longer delivery times. Please contact customer service for availability.

Section 1
Standard Spray Sprinklers

Section 2
Extended Coverage Sprinklers

Section 3
Storage Sprinklers

**Section 4
Residential Sprinklers**

Section 5
Dry Sprinklers

Section 6
Special Sprinklers

Section 7
Nozzles and Sprinkler Accessories

See latest Technical Data Sheets for specific Approvals, Listings, Design Parameters & available finishes. Sprinkler heads & escutcheons are priced separately unless otherwise noted.

Items marked "C.O." are made to order and may require longer delivery times. Please contact customer service for availability.

Series DS-1, Dry, Standard Coverage, Pendent, Upright & Horizontal Sidewall, SR, K=5.6, 5mm Bulb

P/N 60 - XXX - X - XXX

96	Pendent w/Std. Escutcheon (1" NPT)	C.O. Temperature	2	Brass	Brass	060	6.00"
93	Pendent w/Deep Escutcheon (1" NPT)						
97	Pendent w/Std. Recessed Escutcheon (1" NPT)		1	155°F/68°C			
92	Pendent w/o Escutcheon (1" NPT)		2	175°F/79°C			
94	Sidewall w/Std. Escutcheon (1" NPT)		3	200°F/93°C			
53	Sidewall w/Deep Escutcheon (1" NPT)	4	286°F/141°C				
54	Sidewall w/o Escutcheon (1" NPT)	5	360°F/182°C				
98	Upright w/o Escutcheon (1" NPT)	Finish		Length (for example)			
		Sprinkler		Escutcheon			
		2	Brass	0	White	062	6.25"
		1	White	4	White	065	6.50"
		0	Chrome	9	Chrome	067	6.75"
		9	Chrome			372	37.25"
						480	48.00"

DS-1 Standard Coverage - Standard Response

SIN (Upright TY3155), (Pendent TY3255), (HSW TY3355)

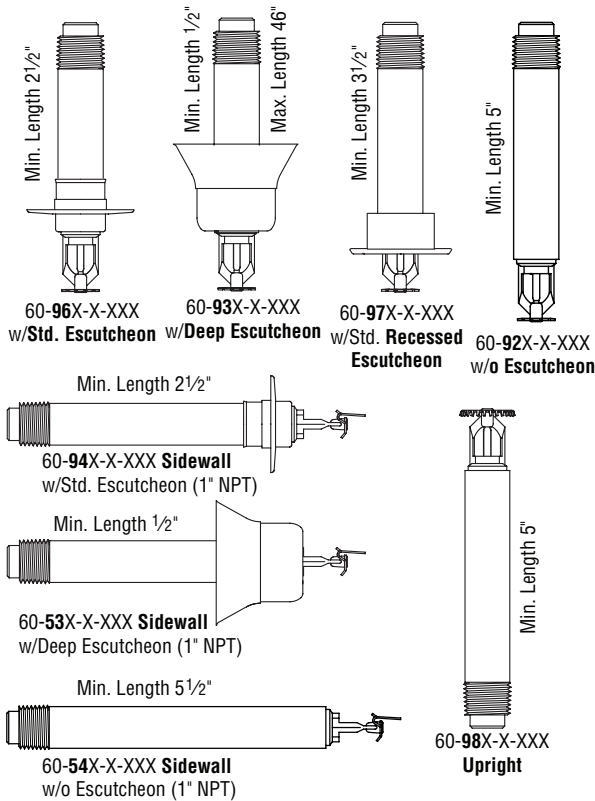

Length (48" Max)	60-98X-X-XXX Upright	60-96X-X-XXX 60-93X-X-XXX 60-97X-X-XXX 60-92X-X-XXX Pendent	60-53X-X-XXX 60-94X-X-XXX 60-54X-X-XXX Sidewall
1/2" to 5-3/4"	\$120.50	\$120.50	\$128.50
6"	\$115.00	\$115.00	\$120.50
6-1/4" to 7-3/4"	\$128.50	\$128.50	\$135.50
8"	\$122.50	\$122.50	\$128.50
8-1/4" to 11-3/4"	\$135.50	\$135.50	\$144.00
12"	\$129.50	\$129.50	\$135.50
12-1/4" to 15"	\$150.50	\$150.50	\$159.50
15-1/4" to 18"	\$159.50	\$159.50	\$166.50
18-1/4" to 21"	\$166.50	\$166.50	\$175.00
21 1/4" to 24"	\$175.00	\$175.00	\$182.50
24"-1/4" to 27"	\$184.00	\$184.00	\$189.50
27-1/4" to 30"	\$191.50	\$191.50	\$197.50
30-1/4" to 33"	\$198.00	\$198.00	\$206.50
33-1/4" to 36"	\$207.50	\$207.50	\$213.50
36-1/4" to 39"	\$214.00	\$214.00	\$221.50
39-1/4" to 42"	\$221.50	\$221.50	\$228.50
42-1/4" to 45"	\$228.50	\$228.50	\$235.50
45-1/4" to 48"	\$235.50	\$235.50	\$243.50

Replacement Escutcheons

56-701-2-010	1/2" Brass Plated (Style 10)	\$7.70
56-701-9-010	1/2" Chrome Plated (Style 10)	\$5.30
56-701-4-010	1/2" White Color Coated (Style 10)	\$5.30
91-106-2-007	Brass Plated (Push On)	\$5.30
91-106-9-007	Chrome Plated (Push On)	\$5.30
91-106-0-007	White Color (Push On)	\$5.30

Dry Sprinkler Rubber Boot Kit

63-000-0-002	DSB-2 Dry Sprinkler Boot Kit Includes: 1-EPDM Rubber Boot, 2-Nylon Ties, 1-1/3 oz tube of adhesive	\$36.00
--------------	---	---------

Sprinkler Wrench (Standard Pipe Wrench for pipe barrel)

56-850-4-001	W-Type 7 Wrench (Recessed Only)	\$68.25
--------------	---------------------------------	---------

Technical Data Sheet: TFP500, Sprinkler Boot-TFP591

Note: All Dry Sprinklers are special ordered and are Non-Returnable. Please see "Terms & Conditions"

See latest Technical Data Sheets for specific Approvals, Listings, Design Parameters & available finishes. Sprinkler heads & escutcheons are priced separately unless otherwise noted.

Items marked "C.O." are made to order and may require longer delivery times. Please contact customer service for availability.

Section 1
Standard Spray Sprinklers

Section 2
Extended Coverage Sprinklers

Section 3
Storage Sprinklers

Section 4
Residential Sprinklers

Section 5
Dry Sprinklers

Section 6
Special Sprinklers

Section 7
Nozzles and Sprinkler Accessories

Series DS-1, Dry, Standard Coverage, Pendent, Upright & Horizontal Sidewall, QR, K=5.6, 3mm Bulb

P/N 60 - XXX - X - XXX

36	Pendent w/Std. Escutcheon (1" NPT)
33	Pendent w/Deep Escutcheon (1" NPT)
37	Pendent w/Std. Recessed Escutcheon (1" NPT)
32	Pendent w/o Escutcheon (1" NPT)
34	Sidewall w/Std. Escutcheon (1" NPT)
43	Sidewall w/Deep Escutcheon (1" NPT)
44	Sidewall w/o Escutcheon (1" NPT)
38	Upright w/o Escutcheon (1" NPT)

C.O.	Temperature
0	135°F/57°C
1	155°F/68°C
2	175°F/79°C
3	200°F/93°C
4	286°F/141°C
5	360°F/182°C

	Finish	
	Sprinkler	Escutcheon
2	Brass	Brass
1	Brass	White
4	White	White
0	Chrome	White
9	Chrome	Chrome

Length (for example)	
060	6.00"
062	6.25"
065	6.50"
067	6.75"
372	37.25"
480	48.00"

DS-1 Standard Coverage - Quick Response
SIN (Upright TY3135), (Pendent TY3235), (HSW TY3335)

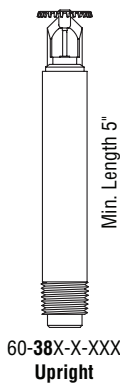
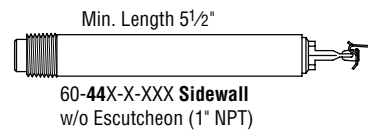
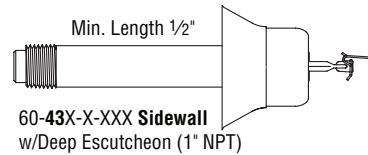
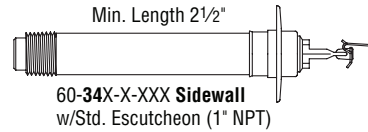
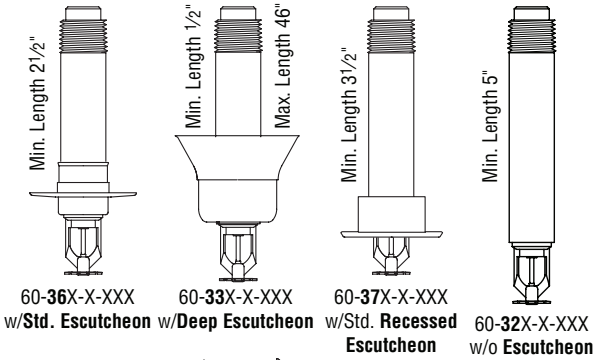

Length (48" Max)	60-38X-X-XXX Upright	60-36X-X-XXX 60-33X-X-XXX 60-37X-X-XXX 60-32X-X-XXX Pendent	60-43X-X-XXX 60-34X-X-XXX 60-44X-X-XXX Sidewall
1/2" to 5-3/4"	\$135.00	\$135.00	\$144.00
6"	\$128.50	\$128.50	\$135.50
6-1/4" to 7-3/4"	\$143.00	\$143.00	\$150.50
8"	\$135.00	\$135.00	\$144.00
8-1/4" to 11-3/4"	\$154.00	\$154.00	\$162.50
12"	\$143.00	\$143.00	\$150.50
12-1/4" to 15"	\$161.50	\$161.50	\$171.50
15-1/4" to 18"	\$169.50	\$169.50	\$178.50
18-1/4" to 21"	\$177.50	\$177.50	\$186.50
21-1/4" to 24"	\$185.50	\$185.50	\$195.00
24-1/4" to 27"	\$193.50	\$193.50	\$201.00
27-1/4" to 30"	\$200.50	\$200.50	\$208.50
30-1/4" to 33"	\$208.00	\$208.00	\$217.50
33-1/4" to 36"	\$217.00	\$217.00	\$224.00
36-1/4" to 39"	\$223.50	\$223.50	\$232.50
39-1/4" to 42"	\$232.00	\$232.00	\$240.50
42-1/4" to 45"	\$240.00	\$240.00	\$248.00
45-1/4" to 48"	\$247.50	\$247.50	\$255.00

Replacement Escutcheons

56-701-2-010	1/2" Brass Plated (Style 10)	\$7.70
56-701-9-010	1/2" Chrome Plated (Style 10)	\$5.30
56-701-4-010	1/2" White Color Coated (Style 10)	\$5.30
91-106-2-007	Brass Plated (Push On)	\$5.30
91-106-9-007	Chrome Plated (Push On)	\$5.30
91-106-0-007	White Color (Push On)	\$5.30

Dry Sprinkler Rubber Boot Kit

63-000-0-002	DSB-2 Dry Sprinkler Boot Kit Includes: 1-EPDM Rubber Boot, 2-Nylon Ties, 1-1/2 oz tube of adhesive	\$36.00
---------------------	---	---------

Sprinkler Wrench (Standard Pipe Wrench for pipe barrel)

56-850-4-001	W-Type 7 Wrench (Recessed Only)	\$68.25
---------------------	---------------------------------	---------

Technical Data Sheet: TFP510, Sprinkler Boot-TFP591

Note: All Dry Sprinklers are special ordered and are Non-Returnable. Please see "Terms & Conditions"

See latest Technical Data Sheets for specific Approvals, Listings, Design Parameters & available finishes. Sprinkler heads & escutcheons are priced separately unless otherwise noted.

Items marked "C.O." are made to order and may require longer delivery times. Please contact customer service for availability.

Series DS-1, Dry, Extended Coverage, Horizontal Sidewall, QR & SR, K=5.6, 3mm & 5mm Bulb

P/N 60 - XXX - X - XXX

C.O. EC Sidewall 3mm Bulb (QR)		Finish		Length (for example)	
350	135°F/57°C (1" NPT)	Sprinkler	Escutcheon	060	6.00"
351	155°F/68°C (1" NPT)	2	Brass	062	6.25"
		1	Brass	065	6.50"
		4	White	067	6.75"
		0	Chrome	372	37.25"
		9	Chrome	480	48.00"

C.O. EC Sidewall 5mm Bulb (SR)	
950	135°F/57°C (1" NPT)
951	155°F/68°C (1" NPT)

DS-1 Extended Coverage Sidewall SIN (SR TY3358), (QR TY3338)

Length
(48" Max)

(SR) EC S/W

(QR) EC S/W

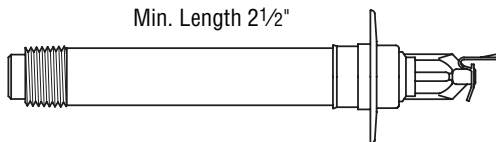

60-XXX-X-XXX Extended Coverage Sidewall
w/Std. Escutcheon (1" NPT)

Note: All Dry Sprinklers are special ordered and are Non-Returnable. Please see "Terms & Conditions"

2-1/2" to 6"	\$148.50	\$160.00
6-1/4" to 8"	\$156.50	\$168.00
8-1/4" to 12"	\$168.00	\$178.50
12-1/4" to 15"	\$175.00	\$186.50
15-1/4" to 18"	\$184.00	\$195.00
18-1/4" to 21"	\$191.50	\$201.00
21-1/4" to 24"	\$199.50	\$208.50
24-1/4" to 27"	\$208.00	\$217.50
27-1/4" to 30"	\$216.00	\$224.00
30-1/4" to 33"	\$224.00	\$232.50
33-1/4" to 36"	\$233.00	\$240.50
36-1/4" to 39"	\$240.00	\$248.00
39-1/4" to 42"	\$249.00	\$255.00
42-1/4" to 45"	\$256.00	\$268.50
45-1/4" to 48"	\$264.00	\$277.00

Replacement Escutcheons

91-106-2-007	Brass Plated (Push On)	\$5.30
91-106-9-007	Chrome Plated (Push On)	\$5.30
91-106-0-007	White Color (Push On)	\$5.30

Dry Sprinkler Rubber Boot Kit

63-000-0-002	DSB-2 Dry Sprinkler Boot Kit Includes: 1-EPDM Rubber Boot, 2-Nylon Ties, 1-1/2 oz tube of adhesive	\$36.00
--------------	---	---------

Sprinkler Wrench (Standard Pipe Wrench for pipe barrel)

56-850-4-001	W-Type 7 Wrench	\$68.25
--------------	-----------------	---------

Technical Data Sheet: TFP520, Sprinkler Boot-TFP591

See latest Technical Data Sheets for specific Approvals, Listings, Design Parameters & available finishes. Sprinkler heads & escutcheons are priced separately unless otherwise noted.

Items marked "C.O." are made to order and may require longer delivery times. Please contact customer service for availability.

Section 1
Standard Spray Sprinklers

Section 2
Extended Coverage Sprinklers

Section 3
Storage Sprinklers

Section 4
Residential Sprinklers

Section 5
Dry Sprinklers

Section 6
Special Sprinklers

Section 7
Nozzles and Sprinkler Accessories

Series DS-2, ELO Dry, Standard Coverage, Pendent, SR, K=11.2, 5mm Bulb

P/N 61 - XXX - X - XXX

Pendent	
10	w/Flush Escutcheon
11	w/Recessed Escutcheon
12	w/Extended Escutcheon
13	w/o Escutcheon

C.O. Temperature	
0	135°F/57°C
1	155°F/68°C
2	175°F/79°C
3	200°F/93°C
4	286°F/141°C

Finish		
	Sprinkler	Escutcheon
1	Brass	White
4	White	White
9	Chrome	Chrome
0	Chrome	White
5	Brass	Brass

Length (for example)	
060	6.00"
062	6.25"
065	6.50"
067	6.75"
372	37.25"
480	48.00"

**DS-2 Standard Response
SIN TY5255**

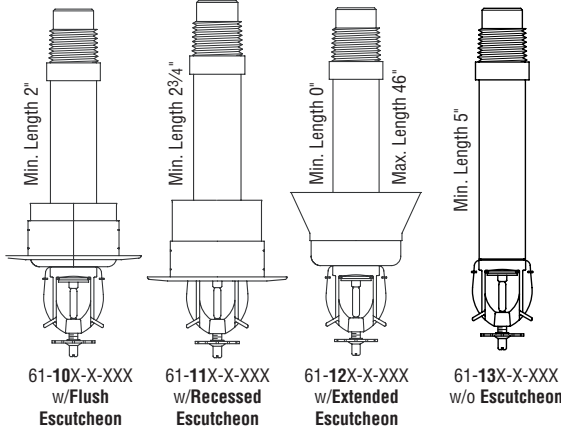

Length (48" Max)	List Price
0" to 6"	\$180.50
6-1/4" to 8"	\$188.50
8-1/4" to 12"	\$196.50
12-1/4" to 15"	\$204.50
15-1/4" to 18"	\$212.50
18-1/4" to 21"	\$220.00
21-1/4" to 24"	\$228.50
24-1/4" to 27"	\$237.00
27-1/4" to 30"	\$245.00
30-1/4" to 33"	\$253.00
33-1/4" to 36"	\$261.50
36-1/4" to 39"	\$270.00
39-1/4" to 42"	\$277.50
42-1/4" to 45"	\$285.50
45-1/4" to 48"	\$299.00
Replacement Escutcheons (Recessed Outer)	
8549-02	White DS2 Escutcheon \$5.30
8549-12	Chrome DS2 Escutcheon \$5.30
8549-22	Brass DS2 Escutcheon \$7.70
Dry Sprinkler Rubber Boot Kit	
63-000-0-002	DSB-2 Dry Sprinkler Boot Kit Includes: 1-EPDM Rubber Boot, 2-Nylon Ties, 1-1/3 oz tube of adhesive \$36.00
Sprinkler Pipe Wrench (Standard Pipe Wrench for pipe barrel)	
56-010-4-118	W-Type 17 Wrench (Recessed Only) \$59.00
Technical Data Sheet: TFP530, Sprinkler Boot-TFP591	

Note: All Dry Sprinklers are special ordered and are Non-Returnable. Please see "Terms & Conditions"

Section 1
Standard Spray Sprinklers

Section 2
Extended Coverage Sprinklers

Section 3
Storage Sprinklers

Section 4
Residential Sprinklers

Section 5
Dry Sprinklers

Section 6
Special Sprinklers

Section 7
Nozzles and Sprinkler Accessories

See latest Technical Data Sheets for specific Approvals, Listings, Design Parameters & available finishes. Sprinkler heads & escutcheons are priced separately unless otherwise noted.

Items marked "C.O." are made to order and may require longer delivery times. Please contact customer service for availability.

Series DS-2, ELO Dry, Standard Coverage, Pendent, QR, K=11.2, 3mm Bulb

P/N 61 - XXX - X - XXX

Pendent		C.O. Temperature		Finish		Length (for example)	
				Sprinkler	Escutcheon		
30	w/Flush Escutcheon	0	135F/57°C	1	Brass White	060	6.00"
31	w/Recessed Escutcheon	1	155F/68°C	4	White White	062	6.25"
32	w/Extended Escutcheon	2	175F/79°C	9	Chrome Chrome	065	6.50"
35	w/o Escutcheon	3	200F/93°C	0	Chrome White	067	6.75"
		4	286F/141°C	5	Brass Brass	372	37.25"
						480	48.00"

DS-2 Quick Response, Standard Coverage SIN TY5235

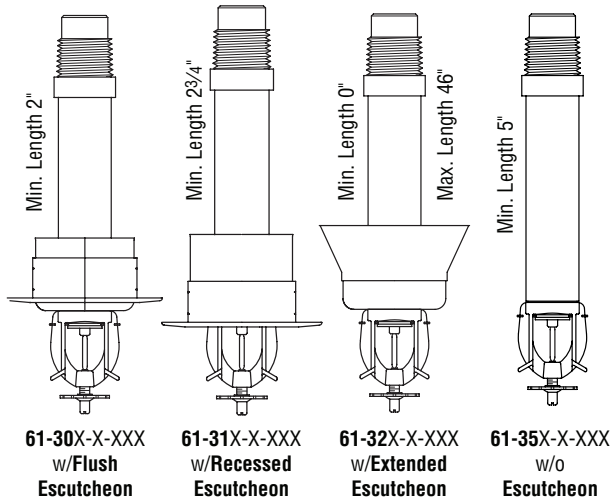

Length (48" Max)	List Price
0" to 6"	\$180.50
6-1/4" to 8"	\$188.50
8-1/4" to 12"	\$196.50
12-1/4" to 15"	\$204.50
15-1/4" to 18"	\$212.50
18-1/4" to 21"	\$220.00
21-1/4" to 24"	\$228.50
24-1/4" to 27"	\$237.00
27-1/4" to 30"	\$245.00
30-1/4" to 33"	\$253.00
33-1/4" to 36"	\$261.50
36-1/4" to 39"	\$270.00
39-1/4" to 42"	\$277.50
42-1/4" to 45"	\$285.50
45-1/4" to 48"	\$299.00

Replacement Escutcheons (Recessed Outer)

8549-02	White DS2 Escutcheon	\$5.30
8549-12	Chrome DS2 Escutcheon	\$5.30
8549-22	Brass DS2 Escutcheon	\$7.70

Dry Sprinkler Rubber Boot Kit

63-000-0-002	DSB-2 Dry Sprinkler Boot Kit Includes: 1-EPDM Rubber Boot, 2-Nylon Ties, 1-1/3 oz tube of adhesive	\$36.00
---------------------	---	---------

Sprinkler Wrench (Standard Pipe Wrench for pipe barrel)

56-010-4-118	W-Type 17 Wrench	\$59.00
---------------------	------------------	---------

Technical Data Sheet: TFP530, Sprinkler Boot-TFP591

Note: All Dry Sprinklers are special ordered and are Non-Returnable. Please see "Terms & Conditions"

Section 1
Standard Spray Sprinklers

Section 2
Extended Coverage Sprinklers

Section 3
Storage Sprinklers

Section 4
Residential Sprinklers

Section 5
Dry Sprinklers

Section 6
Special Sprinklers

Section 7
Nozzles and Sprinkler Accessories

See latest Technical Data Sheets for specific Approvals, Listings, Design Parameters & available finishes. Sprinkler heads & escutcheons are priced separately unless otherwise noted.

Items marked "C.O." are made to order and may require longer delivery times. Please contact customer service for availability.

Series DS-2, ELO Dry, Extended Coverage, Pendent, QR & SR, K=11.2, 3mm Bulb

P/N 61 - XXX - X - XXX

Pendent		C.O. Temperature		Finish		Length	
				Sprinkler	Escutcheon		(for example)
40	w/Flush Escutcheon	0	135°F/57°C	1	Brass White	060	6.00"
41	w/Recessed Escutcheon	1	155°F/68°C	4	White White	062	6.25"
42	w/Extended Escutcheon	2	175°F/79°C	9	Chrome Chrome	065	6.50"
43	w/o Escutcheon	3	200°F/93°C	0	Chrome White	067	6.75"
		4	286°F/141°C	5	Brass Brass	372	37.25"
						480	48.00"

**DS-2 Extended Coverage
SIN TY5238**

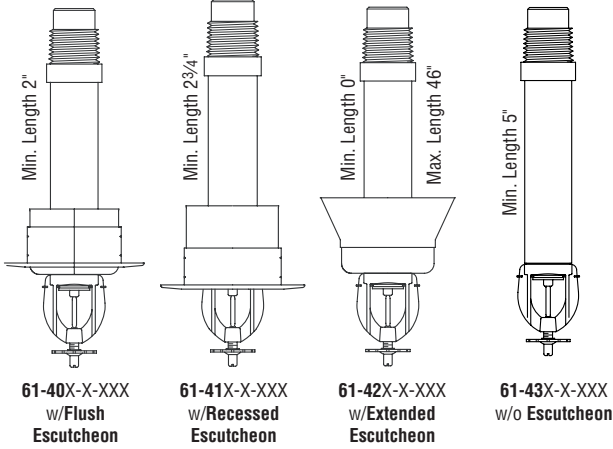

Length (48" Max)	List Price
0" to 6"	\$220.00
6-1/4" to 8"	\$228.50
8-1/4" to 12"	\$237.00
12-1/4" to 15"	\$245.00
15-1/4" to 18"	\$253.00
18-1/4" to 21"	\$261.50
21-1/4" to 24"	\$270.00
24-1/4" to 27"	\$277.50
27-1/4" to 30"	\$285.50
30-1/4" to 33"	\$293.50
33-1/4" to 36"	\$301.00
36-1/4" to 39"	\$309.50
39-1/4" to 42"	\$318.00
42-1/4" to 45"	\$327.50
45-1/4" to 48"	\$342.50

Replacement Escutcheons

8549-02	White DS2 Escutcheon	\$5.30
8549-12	Chrome DS2 Escutcheon	\$5.30
8549-22	Brass DS2 Escutcheon	\$7.70

Dry Sprinkler Rubber Boot Kit

63-000-0-002	DSB-2 Dry Sprinkler Boot Kit Includes: 1-EPDM Rubber Boot, 2-Nylon Ties, 1-1/3 oz tube of adhesive	\$36.00
---------------------	--	---------

Sprinkler Wrench (Standard Pipe Wrench for pipe barrel)

56-010-4-118	W-Type 17 Wrench	\$59.00
---------------------	------------------	---------

Notes

Quick response or standard response is dependent on hazard.
See technical data sheet for additional information.

Technical Data Sheet: TFP540, Sprinkler Boot-TFP591

Note: All Dry Sprinklers are special ordered and are Non-Returnable. Please see "Terms & Conditions"

Section 1
Standard Spray Sprinklers

Section 2
Extended Coverage Sprinklers

Section 3
Storage Sprinklers

Section 4
Residential Sprinklers

Section 5
Dry Sprinklers

Section 6
Special Sprinklers

Section 7
Nozzles and Sprinkler Accessories

See latest Technical Data Sheets for specific Approvals, Listings, Design Parameters & available finishes. Sprinkler heads & escutcheons are priced separately unless otherwise noted.

Items marked "C.O." are made to order and may require longer delivery times. Please contact customer service for availability.

Series DS-3, Dry, Extended Coverage Ordinary Hazard (ECOH), Horizontal Sidewall, 1" NPT, K=11.2, 3mm bulb

P/N 61 — XXX — X — XXX

		MODEL/SIN
161	Flush Escutcheon (1"NPT), 155F/68C	TY5339
163	Flush Escutcheon (1"NPT), 200F/93C	TY5339
171	Deep Escutcheon Skirt (1"NPT), 155F/68C	TY5339
173	Deep Escutcheon Skirt (1"NPT), 200F/93C	TY5339
151	Without Escutcheon (1"NPT), 155F/68C	TY5339
153	Without Escutcheon (1"NPT), 200F/93C	TY5339

	SPRINKLER FINISH	ESCUTCHEON FINISH (2)
1	NATURAL BRASS	BRASS PLATED
4	WHITE POLYESTER	WHITE COATED
9	CHROME PLATED	CHROME PLATED
0	CHROME PLATED	WHITE COATED

ORDER LENGTH (1) (EXAMPLES)	
055	5.50"
082	8.25"
180	18.00"
187	18.75"
372	37.25"
480	48.00"

DS-3 Extended Coverage Ordinary Hazard Sidewall SIN (TY5339)

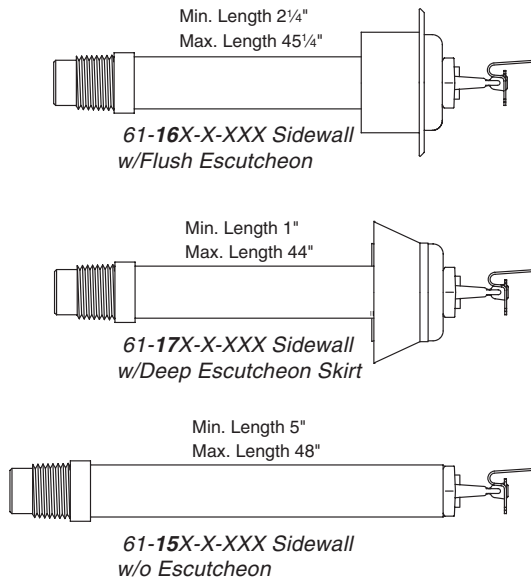

Note: All Dry Sprinklers are special ordered and are Non-Returnable. Please see "Terms & Conditions"

Length (48" Max)	ECOH S/W
1" to 6"	\$202.00
6-1/4" to 8"	\$207.50
8-1/4" to 12"	\$213.00
12-1/4" to 15"	\$218.50
15-1/4" to 18"	\$223.50
18-1/4" to 21"	\$229.00
21-1/4" to 24"	\$234.50
24-1/4" to 27"	\$240.00
27-1/4" to 30"	\$245.50
30-1/4" to 33"	\$251.00
33-1/4" to 36"	\$256.50
36-1/4" to 39"	\$262.00
39-1/4" to 42"	\$267.50
42-1/4" to 45"	\$273.00
45-1/4" to 48"	\$278.00

Replacement Escutcheons

8549-22	Brass Plated - Flush	\$7.70
8549-12	Chrome Plated - Flush	\$5.30
8549-02	Flush White Color - Flush	\$5.30
1199	Brass Plated - Deep	\$5.30
1198	Chrome Plated - Deep	\$5.30
1200	White Color - Deep	\$5.30

Dry Sprinkler Rubber Boot Kit

63-000-0-002	DSB-2 Dry Sprinkler Boot Kit Includes: 1-EPDM Rubber Boot, 2-Nylon Ties, 1-1/2 oz tube of adhesive	\$36.00
---------------------	---	---------

Sprinkler Wrench (Standard Pipe Wrench for pipe barrel)

56-892-1-001	W-Type 8 Wrench	\$68.25
---------------------	-----------------	---------

Technical Data Sheet: TFP550, Sprinkler Boot-TFP591

Series DS-C, Dry Concealed, Standard Response, K=5.6, 5mm Bulb

Section 1
Standard Spray Sprinklers

Section 2
Extended Coverage Sprinklers

Section 3
Storage Sprinklers

Section 4
Residential Sprinklers

Section 5
Dry Sprinklers

Section 6
Special Sprinklers

Section 7
Nozzles and Sprinkler Accessories

DS-C SR Concealed
SIN TY3555

P/N 60 - 86 X - 1 - XXX

C.O. Temperature		Length (for example)	
1	155°F/68°C	060	6.00"
3	200°F/93°C	062	6.25"
		065	6.50"
		067	6.75"
		372	37.25"
		480	48.00"

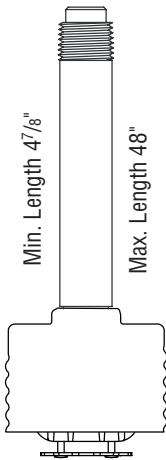

60-86X-1-XXX

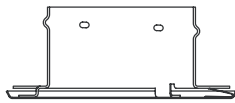

Cover Plate
(Order Separately)

Note: All Dry Sprinklers are special ordered and are Non-Returnable.

Please see "Terms & Conditions"

Note: All Dry Sprinklers are 4 7/8" Min. Length and 48" Max.

c.o.	Length (48" Max)	List Price
	4-7/8" to 8"	\$153.00
	8-1/4" to 12"	\$163.00
	12-1/4" to 15"	\$174.50
	15-1/4" to 18"	\$186.50
	18-1/4" to 21"	\$197.50
	21-1/4" to 27"	\$209.00
	27-1/4" to 30"	\$220.00
	30-1/4" to 33"	\$232.00
	33-1/4" to 36"	\$244.00
	36-1/4" to 39"	\$253.50
	39-1/4" to 42"	\$265.50
	42-1/4" to 45"	\$277.00
	45-1/4" to 48"	\$287.50

Cover Plates

80 Box Quantity (14.5 lbs/box)

Cover Plate (135° F for use with 155° F Sprinkler)

56-792-1-135	Brass	135°F/57°C	\$17.75
56-792-9-135	Chrome	135°F/57°C	\$17.75
56-792-0-135	Grey White	135°F/57°C	\$17.75
56-792-4-135	Signal (Bright) White	135°F/57°C	\$17.75
56-792-X-135	Special Order*	135°F/57°C	\$19.25

Cover Plate (165° F for use with 200° F Sprinkler)

56-792-1-165	Brass	165°F/74°C	\$17.75
56-792-9-165	Chrome	165°F/74°C	\$17.75
56-792-0-165	Grey White	165°F/74°C	\$17.75
56-792-4-165	Signal (Bright) White	165°F/74°C	\$17.75
56-792-X-165	Special Order*	165°F/74°C	\$19.25

Notes

6012	*Special order paint match subject to set-up charge. (Net Price)	\$315.50
-------------	--	----------

Dry Sprinkler Rubber Boot Kit

63-000-0-002	DSB-2 Dry Sprinkler Boot Kit Includes: 1-EPDM Rubber Boot, 2-Nylon Ties, 1-1/3 oz tube of adhesive	\$36.00
---------------------	---	---------

Sprinkler Wrench (Standard Pipe Wrench for pipe barrel)

56-000-1-075	RFII Wrench	\$68.25
---------------------	-------------	---------

**Technical Data Sheet: TFP515,
Sprinkler Boot-TFP591**

See latest Technical Data Sheets for specific Approvals, Listings, Design Parameters & available finishes. Sprinkler heads & escutcheons are priced separately unless otherwise noted.

Items marked "C.O." are made to order and may require longer delivery times. Please contact customer service for availability.

Series DS-C, Dry Concealed, Quick Response, K=5.6, 3mm Bulb

DS-C QR Concealed SIN TY3535		C.O.	Length (48" Max)	List Price																												
<p>P/N 60 - 46 X - 1 - XXX</p> <table border="1"> <tr> <th colspan="2">C.O. Temperature</th> <th colspan="2">Length (for example)</th> </tr> <tr> <td>1</td> <td>155°F/68°C</td> <td>060</td> <td>6.00"</td> </tr> <tr> <td>3</td> <td>200°F/93°C</td> <td>062</td> <td>6.25"</td> </tr> <tr> <td></td> <td></td> <td>065</td> <td>6.50"</td> </tr> <tr> <td></td> <td></td> <td>067</td> <td>6.75"</td> </tr> <tr> <td></td> <td></td> <td>372</td> <td>37.25"</td> </tr> <tr> <td></td> <td></td> <td>480</td> <td>48.00"</td> </tr> </table> <p>60-46X-1-XXX</p> <p>Cover Plate (Order Separately)</p> <p>Note: All Dry Sprinklers are special ordered and are Non-Returnable. Please see "Terms & Conditions"</p> <p>Note: All Dry Sprinklers are 4 7/8" Min. Length and 48" Max.</p>		C.O. Temperature		Length (for example)		1	155°F/68°C	060	6.00"	3	200°F/93°C	062	6.25"			065	6.50"			067	6.75"			372	37.25"			480	48.00"		4-7/8" to 8"	\$163.00
		C.O. Temperature		Length (for example)																												
		1	155°F/68°C	060	6.00"																											
		3	200°F/93°C	062	6.25"																											
				065	6.50"																											
				067	6.75"																											
				372	37.25"																											
				480	48.00"																											
			8-1/4" to 12"	\$174.50																												
			12-1/4" to 15"	\$186.50																												
			15-1/4" to 18"	\$197.50																												
			18-1/4" to 21"	\$209.00																												
			21-1/4" to 27"	\$220.00																												
			27-1/4" to 30"	\$232.00																												
			30-1/4" to 33"	\$244.00																												
			33-1/4" to 36"	\$253.50																												
			36-1/4" to 39"	\$265.50																												
	39-1/4" to 42"	\$277.00																														
	42-1/4" to 45"	\$287.50																														
	45-1/4" to 48"	\$300.00																														
Cover Plates																																
80 Box Quantity (14.5 lbs/box)																																
Cover Plate (135° F for use with 155° F Sprinkler)																																
	56-792-1-135	Brass	135°F/57°C	\$17.75																												
	56-792-9-135	Chrome	135°F/57°C	\$17.75																												
	56-792-0-135	Grey White	135°F/57°C	\$17.75																												
	56-792-4-135	Signal (Bright) White	135°F/57°C	\$17.75																												
	56-792-X-135	Special Order*	135°F/57°C	\$19.25																												
Cover Plate (165° F for use with 200° F Sprinkler)																																
	56-792-1-165	Brass	165°F/74°C	\$17.75																												
	56-792-9-165	Chrome	165°F/74°C	\$17.75																												
	56-792-0-165	Grey White	165°F/74°C	\$17.75																												
	56-792-4-165	Signal (Bright) White	165°F/74°C	\$17.75																												
	56-792-X-165	Special Order*	165°F/74°C	\$19.25																												
Notes																																
	6012	*Special order paint match subject to set-up charge. (Net Price)		\$315.50																												
Dry Sprinkler Rubber Boot Kit																																
	63-000-0-002	DSB-2 Dry Sprinkler Boot Kit Includes: 1-EPDM Rubber Boot, 2-Nylon Ties, 1-1/2 oz tube of adhesive		\$36.00																												
Sprinkler Wrench (Standard Pipe Wrench for pipe barrel)																																
	56-000-1-075	RFII Wrench		\$68.25																												
Technical Data Sheet: TFP515, Sprinkler Boot-TFP591																																

Section 1
Standard Spray Sprinklers

Section 2
Extended Coverage Sprinklers

Section 3
Storage Sprinklers

Section 4
Residential Sprinklers

Section 5
Dry Sprinklers

Section 6
Special Sprinklers

Section 7
Nozzles and Sprinkler Accessories

See latest Technical Data Sheets for specific Approvals, Listings, Design Parameters & available finishes. Sprinkler heads & escutcheons are priced separately unless otherwise noted.

Items marked "C.O." are made to order and may require longer delivery times. Please contact customer service for availability.

Series DS-ECC, Dry Extended Concealed Coverage, Quick Response, K=5.6, 3mm Bulb

DS-ECC Extended Concealed Coverage
SIN TY3539

P/N 60 - 45 X - 1 - XXX

C.O. Temperature		Length (for example)	
1	155°F/68°C	060	6.00"
3	200°F/93°C	062	6.25"
		065	6.50"
		067	6.75"
		372	37.25"
		480	48.00"

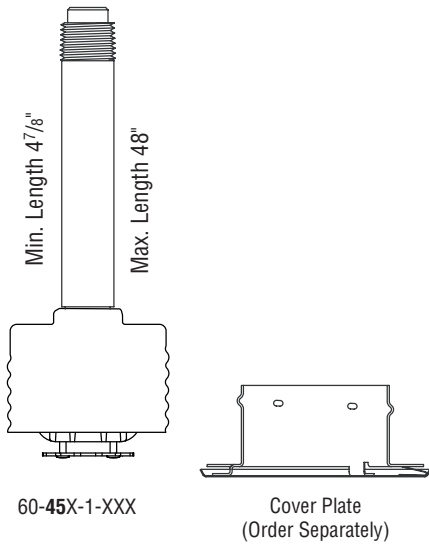

c.o.	Length (48" Max)	List Price
	4-7/8" to 8"	\$174.50
	8-1/4" to 12"	\$186.50
	12-1/4" to 15"	\$197.50
	15-1/4" to 18"	\$209.00
	18-1/4" to 21"	\$220.00
	21-1/4" to 27"	\$232.00
	27-1/4" to 30"	\$244.00
	30-1/4" to 33"	\$253.50
	33-1/4" to 36"	\$265.50
	36-1/4" to 39"	\$277.00
	39-1/4" to 42"	\$287.50
	42-1/4" to 45"	\$300.00
	45-1/4" to 48"	\$316.50

Cover Plates

80 Box Quantity (14.5 lbs/box)

Cover Plate (135° F for use with 155° F Sprinkler)

Part No.	Material	Temperature	List Price
56-792-1-135	Brass	135°F/57°C	\$17.75
56-792-9-135	Chrome	135°F/57°C	\$17.75
56-792-0-135	Grey White	135°F/57°C	\$17.75
56-792-4-135	Signal (Bright) White	135°F/57°C	\$17.75
56-792-X-135	Special Order*	135°F/57°C	\$19.25

Cover Plate (165° F for use with 200° F Sprinkler)

Part No.	Material	Temperature	List Price
56-792-1-165	Natural Brass	165°F/74°C	\$17.75
56-792-9-165	Bright Chrome	165°F/74°C	\$17.75
56-792-0-165	Grey White	165°F/74°C	\$17.75
56-792-4-165	Signal (Bright) White	165°F/74°C	\$17.75
56-792-X-165	Special Order*	165°F/74°C	\$19.25

Notes

6012	*Special order paint match subject to set-up charge. (Net Price)	\$315.50
------	--	----------

Dry Sprinkler Rubber Boot Kit

63-000-0-002	DSB-2 Dry Sprinkler Boot Kit Includes: 1-EPDM Rubber Boot, 2-Nylon Ties, 1-1/2 oz tube of adhesive	\$36.00
--------------	---	---------

Sprinkler Wrench (Standard Pipe Wrench for pipe barrel)

56-000-1-075	RFII Wrench	\$68.25
--------------	-------------	---------

**Technical Data Sheet: TFP518,
Sprinkler Boot-TFP591**

Note: All Dry Sprinklers are special ordered and are Non-Returnable. Please see "Terms & Conditions"

Note: All Dry Sprinklers are 4 7/8" Min. Length and 48" Max.

Section 1
Standard Spray Sprinklers

Section 2
Extended Coverage Sprinklers

Section 3
Storage Sprinklers

Section 4
Residential Sprinklers

Section 5
Dry Sprinklers

Section 6
Special Sprinklers

Section 7
Nozzles and Sprinkler Accessories

See latest Technical Data Sheets for specific Approvals, Listings, Design Parameters & available finishes. Sprinkler heads & escutcheons are priced separately unless otherwise noted.

Items marked "C.O." are made to order and may require longer delivery times. Please contact customer service for availability.

Illusion™ Casino Sprinkler ELO Extra Large Orifice, Concealed Pendent Sprinklers, Quick Response, Standard Coverage, K=11.2, 3/4" N.P.T. (SIN TY5521)

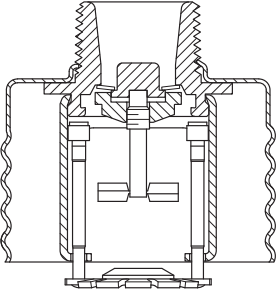
	C.O.	Part No.	Model	Finish	Temperature	List Price	
		50-711-1-160	Illusion Casino	Brass	160°F/71°C	\$34.50	
		50-711-1-212	Illusion Casino	Brass	212°F/100°C	\$34.50	
	Cover Plates (Order Separately)						
			56-892-1-135	Cover Plate	Brass	135°F/57°C	\$17.75
			56-892-1-165	Cover Plate	Brass	165°F/74°C	\$17.75
			56-892-9-135	Cover Plate	Chrome	135°F/57°C	\$17.75
			56-892-9-165	Cover Plate	Chrome	165°F/74°C	\$17.75
			56-892-4-135	Cover Plate	Signal White	135°F/57°C	\$17.75
			56-892-4-165	Cover Plate	Signal White	165°F/74°C	\$17.75
			56-892-0-135	Cover Plate	Grey White	135°F/57°C	\$17.75
			56-892-0-165	Cover Plate	Grey White	165°F/74°C	\$17.75
			56-892-X-135	Cover Plate	Special Order*	135°F/57°C	\$20.75
			56-892-X-165	Cover Plate	Special Order*	165°F/74°C	\$20.75
	Clean Room Seals (Order Separately)						
			56-908-1-001	Air and Dust Seal			\$9.80
Sprinkler Wrench							
		56-000-1-265	W-Type 18 Wrench			\$68.25	
Notes							
	6012	*Special Order paint match subject to set-up charge. (Net Price)				\$315.50	

Note: All "Special Order" cover plates are special ordered and are Non-Returnable. Please see "Terms & Conditions"



ILLUSION
We Cover All The Action

Technical Data Sheet: TFP184

CC2 Combustible Concealed Space Upright Sprinklers K=5.6, 1/2" N.P.T.

SIN TY3189

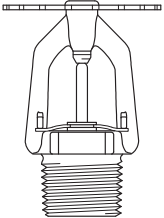
	C.O.	No.	Model	Finish	Temp.	List Price	
		51-301-1-175	CC2	Brass	175°F/79°C	\$37.50	
	Sprinkler Wrench						
			56-000-6-387	W-Type 6 Wrench			\$40.75

Technical Data Sheet: TFP632

See latest Technical Data Sheets for specific Approvals, Listings, Design Parameters & available finishes. Sprinkler heads & escutcheons are priced separately unless otherwise noted.

Items marked "C.O." are made to order and may require longer delivery times. Please contact customer service for availability.

Section 1 Standard Spray Sprinklers
Section 2 Extended Coverage Sprinklers
Section 3 Storage Sprinklers
Section 4 Residential Sprinklers
Section 5 Dry Sprinklers
Section 6 Special Sprinklers
Section 7 Nozzles and Sprinkler Accessories

CC2 Combustible Concealed Space Upright Sprinklers K=4.2, 1/2" N.P.T.

Standard Spray Sprinklers
Section 1

SIN TY2189

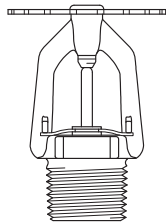

C.O.	No.	Model	Finish	Temp.	List Price
	51-311-1-175	CC2	Brass	175°F/79°C	\$34.50
Sprinkler Wrench					
	56-000-6-387	W-Type 6 Wrench			\$40.75

Technical Data Sheet: TFP632

Extended Coverage Sprinklers
Section 2

CC1 Combustible Concealed Upright Sprinklers K=3.0, 1/2" N.P.T.

Storage Sprinklers
Section 3

SIN TY1189

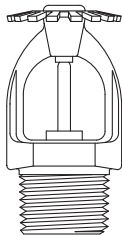

C.O.	No.	Model	Finish	Temp.	List Price
	50-300-1-175	CC1	Brass	175°F/79°C	\$35.50
Sprinkler Wrench					
	56-000-1-106	W-Type 20 Combination Wrench			\$68.25

Technical Data Sheet: TFP630

Residential Sprinklers
Section 4

WS Window Sprinklers K=5.6, 1/2" N.P.T.

Dry Sprinklers
Section 5

100 Box Quantity (VSW 20 lbs/box (SIN TY3488), HSW 17 lbs/box (SIN TY3388))

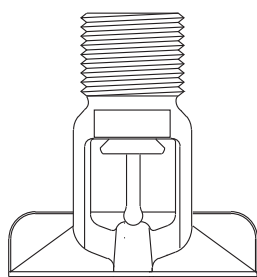

Vertical

C.O.	No.	Model	Finish	Temperature	List Price
	50-305-1-155	Horizontal Sidewall	Brass	155°F/68°C	\$300.50
	50-305-1-200	Horizontal Sidewall	Brass	200°F/93°C	\$300.50
	50-305-9-155	Horizontal Sidewall	Chrome	155°F/68°C	\$300.50
	50-305-9-200	Horizontal Sidewall	Chrome	200°F/93°C	\$300.50
	50-305-4-155	Horizontal Sidewall	White	155°F/68°C	\$300.50
	50-305-4-200	Horizontal Sidewall	White	200°F/93°C	\$300.50
	50-304-1-155	Vertical Sidewall	Brass	155°F/68°C	\$300.50
	50-304-1-200	Vertical Sidewall	Brass	200°F/93°C	\$300.50
	50-304-9-155	Vertical Sidewall	Chrome	155°F/68°C	\$300.50
	50-304-9-200	Vertical Sidewall	Chrome	200°F/93°C	\$300.50
	50-304-4-155	Vertical Sidewall	White	155°F/68°C	\$300.50
	50-304-4-200	Vertical Sidewall	White	200°F/93°C	\$300.50

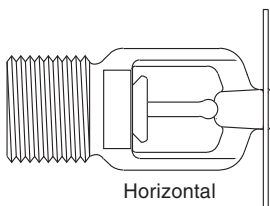

Horizontal

Sprinkler Wrench

	56-000-1-106	W-Type 20 Combination Wrench	\$68.25
--	--------------	------------------------------	---------

Technical Data Sheet: TFP620

Special Sprinklers
Section 6



Nozzles and Sprinkler Accessories
Section 7

See latest Technical Data Sheets for specific Approvals, Listings, Design Parameters & available finishes. Sprinkler heads & escutcheons are priced separately unless otherwise noted.

Items marked "C.O." are made to order and may require longer delivery times. Please contact customer service for availability.

Attic Sprinklers K=4.2, K=5.6 & K=8.0, 1/2" and 3/4" N.P.T.

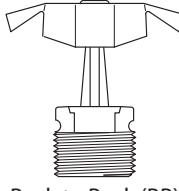
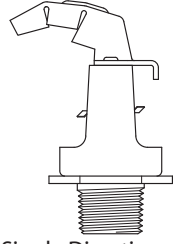
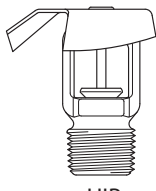
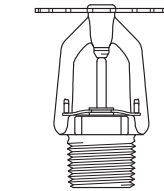
100 Box Quantity (BB/SD 31 lbs/box, HIP 22 lbs/box)

	C.O.	Part No.	Model	SIN Number	Pitch Rise over Run	Finish	K-Factor	Temperature	List Price
 Back to Back (BB)		51-623-1-200	ATTIC BB1, 17/32	TY4180	4/12 to < 7/12	Brass	8.0	200°F/93°C	\$165.00
		51-621-1-200	ATTIC BB2, 17/32	TY4181	7/12 to < 10/12	Brass	8.0	200°F/93°C	\$165.00
		51-622-1-200	ATTIC BB3, 17/32	TY4182	10/12 to 12/12	Brass	8.0	200°F/93°C	\$165.00
 Single Directional (SD)		50-601-1-212	ATTIC BB1, 1/2	TY3180	4/12 to < 7/12	Brass	5.6	212°F/100°C	\$128.50
		50-602-1-212	ATTIC BB2, 1/2	TY3181	7/12 to < 10/12	Brass	5.6	212°F/100°C	\$128.50
		50-603-1-212	ATTIC BB3, 1/2	TY3182	10/12 to 12/12	Brass	5.6	212°F/100°C	\$128.50
 HIP		50-620-1-200	ATTIC BB1, 1/2	TY2180	4/12 to < 7/12	Brass	4.2	200°F/93°C	\$62.25
		50-621-1-200	ATTIC BB2, 1/2	TY2181	7/12 to < 10/12	Brass	4.2	200°F/93°C	\$62.25
		50-622-1-200	ATTIC BB3, 1/2	TY2182	10/12 to 12/12	Brass	4.2	200°F/93°C	\$62.25
 Attic Plus (AP)		50-611-1-212	ATTIC SD1, 1/2	TY3183	4/12 to < 7/12	Brass	5.6	212°F/100°C	\$128.50
		50-612-1-212	ATTIC SD2, 1/2	TY3184	7/12 to < 10/12	Brass	5.6	212°F/100°C	\$128.50
		50-613-1-212	ATTIC SD3, 1/2	TY3185	10/12 to 12/12	Brass	5.6	212°F/100°C	\$128.50
	51-620-1-200	ATTIC HIP	TY3187	4/12 to 12/12	Brass	5.6	200°F/93°C	\$128.50	
	50-625-1-200	AP, 1/2, K=5.6	TY3190	3/12 to 12/12	Brass	5.6	200°F/93°C	\$23.00	
	50-624-1-200	AP, 1/2, K=4.2	TY2190	3/12 to 12/12	Brass	4.2	200°F/93°C	\$23.00	
Sprinkler Wrench									
	56-895-1-001	W-Type 3 Wrench							\$56.75
	56-000-6-387	W-Type 6 Wrench							\$40.75
	56-000-1-106	W-Type 20 Combination Wrench							\$68.25
 <p>PEAKTM PERFORMANCE</p> <p>ATTIC PROTECTION SPRINKLER SYSTEM</p> <p>Technical Data Sheet: TFP610</p>									

Section 1
Standard Spray Sprinklers

Section 2
Extended Coverage Sprinklers

Section 3
Storage Sprinklers

Section 4
Residential Sprinklers

Section 5
Dry Sprinklers

Section 6
Special Sprinklers

Section 7
Nozzles and Sprinkler Accessories

See latest Technical Data Sheets for specific Approvals, Listings, Design Parameters & available finishes. Sprinkler heads & escutcheons are priced separately unless otherwise noted.

Items marked "C.O." are made to order and may require longer delivery times. Please contact customer service for availability.

Series TY-B , K=5.6 & K=8.0 - Stainless Steel and Titanium, - Standard Response Upright, Pendent, and Conventional Sprinklers

P/N 57 — XXX — 0 — XXX — SUFFIX

Standard Response		TEMPERATURE RATING		MATERIAL	
570	TY-B 5.6K UPRIGHT	135	135°F/57°C	None	Stainless Steel
571	TY-B 5.6K PENDENT	155	155°F/68°C	T	Titanium (5.6 K Only)
573	TY-B 5.6K CONVENTIONAL	175	175°F/79°C		
590	TY-B 8.0K UPRIGHT	200	200°F/93°C		
591	TY-B 8.0K PENDENT	286	286°F/141°C		
593	TY-B 8.0K CONVENTIONAL	360	360°F/182°C		

Product Symbol Numbers can be developed by using the table show above. Refer to the Technical data sheet for Sprinkler Identification Numbers. All response, orifice sizes, materials and finishes as follows:

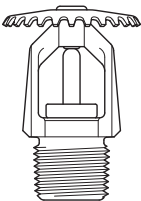
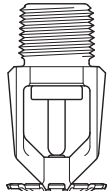
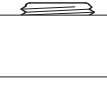
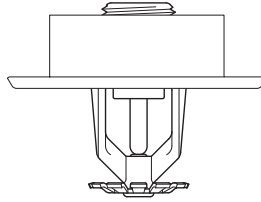
	Nozzle	Description	K-Factor	List Price
	57-570-0-XXX	TY-B Upright, Standard Response	5.6	\$226.50
	57-571-0-XXX	TY-B Pendent, Standard Response	5.6	\$226.50
	57-573-0-XXX	TY-B Conventional, Standard Response	5.6	\$226.50
	57-XXX-0-XXX T	Titanium Material - Add "T" Suffix (K=5.6 only)	5.6	POA
	57-590-0-XXX	TY-B Upright, Standard Response	8.0	\$249.00
	57-591-0-XXX	TY-B Pendent, Standard Response	8.0	\$249.00
	57-593-0-XXX	TY-B Conventional, Standard Response	8.0	\$249.00
Recessed Escutcheons (Order Separately)				
	56-701-0-010	1/2" Stainless Steel (Style 10), with White Paint Finish		\$13.75
	56-700-0-010	3/4" Stainless Steel (Style 40), with White Paint Finish		\$13.75
Sprinkler Wrench				
	56-000-6-387	W-Type 6 Wrench		\$40.75
	56-850-4-001	W-Type 7 Wrench		\$68.25
<p>Note: All Alternate Materials Sprinklers are special ordered and are Non-Returnable. Please see "Terms & Conditions"</p> <p>All Titanium Sprinklers are POA</p>				
Technical Data Sheet: TFP680				

Note: TY-B Standard Response 1/2" NPT K=5.6 Sprinklers is shown

See latest Technical Data Sheets for specific Approvals, Listings, Design Parameters & available finishes. Sprinkler heads & escutcheons are priced separately unless otherwise noted.

Items marked "C.O." are made to order and may require longer delivery times. Please contact customer service for availability.

Price Book - Section 6 Special Sprinklers

Series TY-B , K=5.6 & K=8.0 - Stainless Steel and Titanium, - Standard Response Vertical Sidewall, Horizontal Sidewall and Recessed Horizontal Sidewall Sprinklers

P/N 57 — XXX — 0 — XXX — SUFFIX

Standard Response		TEMPERATURE RATING		MATERIAL	
578	TY-B 5.6K HORIZONTAL SIDEWALL	135	135°F/57°C	None	Stainless Steel
575	TY-B 5.6K VERTICAL SIDEWALL	155	155°F/68°C	T	Titanium (5.6 K Only)
		175	175°F/79°C		
		200	200°F/93°C		
		286	286°F/141°C		
		360	360°F/182°C		

Product Symbol Numbers can be developed by using the table show above. Refer to the Technical data sheet for Sprinkler Identification Numbers. All response, orifice sizes, materials and finishes as follows:

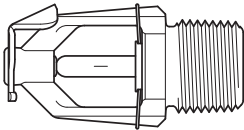
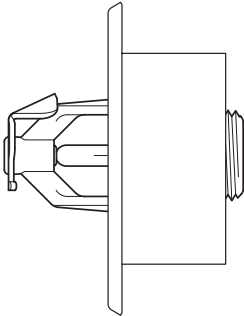
	Nozzle	Description ¹	K-Factor	List Price
	57-578-0-XXX	TY-B Horizontal Sidewall, Standard Response	5.6	\$226.50
	57-575-0-XXX	TY-B Vertical Sidewall, Standard Response	5.6	\$226.50
	57-XXX-0-XXX T	Titanium Material - Add "T" Suffix (K=5.6 only)	5.6	POA
Recessed Escutcheons (Order Separately)				
	56-701-0-010	½" Stainless Steel (Style 10), with White Paint Finish		\$13.75
	Sprinkler Wrench			
	56-000-6-387	W-Type 6 Wrench		\$40.75
	56-850-4-001	W-Type 7 Wrench		\$68.25

Note: TY-B Standard Response
1/2" NPT K=5.6 Sprinklers is shown

**Note: All Alternate Materials Sprinklers are special ordered and are
Non-Returnable. Please see "Terms & Conditions"**

All Titanium Sprinklers are POA

Technical Data Sheet: TFP680

See latest Technical Data Sheets for specific Approvals, Listings, Design Parameters & available finishes. Sprinkler heads & escutcheons are priced separately unless otherwise noted.

Items marked "C.O." are made to order and may require longer delivery times. Please contact customer service for availability.

Series TY-FRB , K=5.6 & K=8.0 - Stainless Steel and Titanium, - Quick Response Upright, Pendent, and Conventional Sprinklers

P/N 57 — XXX — 0 — XXX — SUFFIX

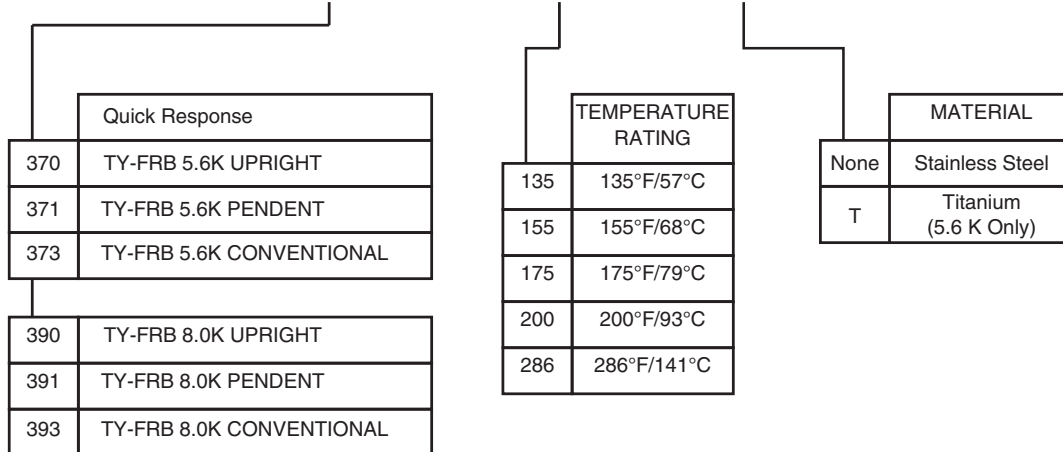

Product Symbol Numbers can be developed by using the table show above. Refer to the Technical data sheet for Sprinkler Identification Numbers. All response, orifice sizes, materials and finishes as follows:

	Nozzle	Description	K-Factor	List Price
	57-370-0-XXX	TY-FRB Upright, Quick Response	5.6	\$226.50
	57-371-0-XXX	TY-FRB Pendent, Quick Response	5.6	\$226.50
	57-373-0-XXX	TY-FRB Conventional, Quick Response	5.6	\$226.50
	57-XXX-0-XXX T	Titanium Material - Add "T" Suffix (K=5.6 only)	5.6	POA
	57-390-0-XXX	TY-FRB Upright, Quick Response	8.0	\$249.00
	57-391-0-XXX	TY-FRB Pendent, Quick Response	8.0	\$249.00
	57-393-0-XXX	TY-FRB Conventional, Quick Response	8.0	\$249.00
Recessed Escutcheons (Order Separately)				
	56-701-0-010	½" Stainless Steel (Style 10), with White Paint Finish		\$13.75
	56-700-0-010	¾" Stainless Steel (Style 40), with White Paint Finish		\$13.75
Sprinkler Wrench				
	56-000-6-387	W-Type 6 Wrench		\$40.75
	56-850-4-001	W-Type 7 Wrench		\$68.25
	<p>Note: All Alternate Materials Sprinklers are special ordered and are Non-Returnable. Please see "Terms & Conditions"</p> <p>All Titanium Sprinklers are POA</p>			
	<p>Technical Data Sheet: TFP680</p>			

Note: TY-FRB Standard Response 3/4" NPT K=8.0 Sprinklers is shown

See latest Technical Data Sheets for specific Approvals, Listings, Design Parameters & available finishes. Sprinkler heads & escutcheons are priced separately unless otherwise noted.

Items marked "C.O." are made to order and may require longer delivery times. Please contact customer service for availability.

Price Book - Section 6 Special Sprinklers

Series TY-FRB , K=5.6 & K=8.0 - Stainless Steel and Titanium, - Quick Response Vertical Sidewall, Horizontal Sidewall and Recessed Horizontal Sidewall Sprinklers

P/N 57 — XXX — 0 — XXX — SUFFIX

Quick Response		TEMPERATURE RATING		MATERIAL	
378	TY-FRB 5.6K HORIZONTAL SIDEWALL	135	135°F/57°C	None	Stainless Steel
375	TY-FRB 5.6K VERTICAL SIDEWALL	155	155°F/68°C	T	Titanium (5.6 K Only)
		175	175°F/79°C		
		200	200°F/93°C		
		286	286°F/141°C		

Product Symbol Numbers can be developed by using the table show above. Refer to the Technical data sheet for Sprinkler Identification Numbers. All response, orifice sizes, materials and finishes as follows:

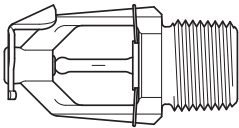
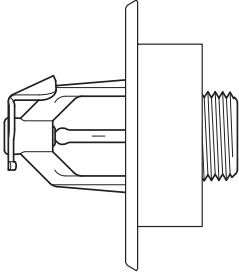
	Nozzle	Description	K-Factor	List Price
	57-578-0-XXX	TY-B Horizontal Sidewall, Quick Response	5.6	\$226.50
	57-575-0-XXX	TY-B Vertical Sidewall, Quick Response	5.6	\$226.50
	57-XXX-0-XXX T	Titanium Material - Add "T" Suffix (K=5.6 only)	5.6	POA
Recessed Escutcheons (Order Separately)				
	56-701-0-010	1/2" Stainless Steel (Style 10), with White Paint Finish		\$13.75
Sprinkler Wrench				
	56-000-6-387	W-Type 6 Wrench		\$40.75
	56-850-4-001	W-Type 7 Wrench		\$68.25

Note: TY-FRB Standard Response 1/2" NPT K=5.6 Sprinklers is shown

Note: All Alternate Materials Sprinklers are special ordered and are Non-Returnable. Please see "Terms & Conditions"
All Titanium Sprinklers are POA

Technical Data Sheet: TFP680

Section 1
Standard Spray Sprinklers

Section 2
Extended Coverage Sprinklers

Section 3
Storage Sprinklers

Section 4
Residential Sprinklers

Section 5
Dry Sprinklers

Section 6
Special Sprinklers

Section 7
Nozzles and Sprinkler Accessories

See latest Technical Data Sheets for specific Approvals, Listings, Design Parameters & available finishes. Sprinkler heads & escutcheons are priced separately unless otherwise noted.

Items marked "C.O." are made to order and may require longer delivery times. Please contact customer service for availability.

TFP MAX, K=5.6, Institutional Pendent, Quick Response Sprinkler

50 Box Quantity (33 lbs/box) (SIN TY3291)

Section 1
Standard Spray Sprinklers

Section 2
Extended Coverage Sprinklers

Section 3
Storage Sprinklers

Section 4
Residential Sprinklers

Section 5
Dry Sprinklers

**Section 6
Special Sprinklers**

Section 7
Nozzles and Sprinkler Accessories

C.O.	Pendent	Finish	Temperature	List Price
▶	51-103-9-135	Chrome	135°F/57°C	\$54.50
	51-103-9-155	Chrome	155°F/68°C	\$54.50
▶	51-103-9-175	Chrome	175°F/79°C	\$54.50
▶	51-103-9-200	Chrome	200°F/93°C	\$54.50

Order Escutcheon Separately

56-001-7-514	Type D	\$15.50
56-001-7-515	Type E	\$15.50

Accessories

56-000-1-781	Centering Grommet – Model 1781	\$2.40
56-000-1-780	Retaining Flange – Model 1780	\$29.50
56-000-1-752	Spacers	\$0.30

Sprinkler Wrench

56-001-5-093	Model 1509-3	\$119.50
--------------	--------------	----------

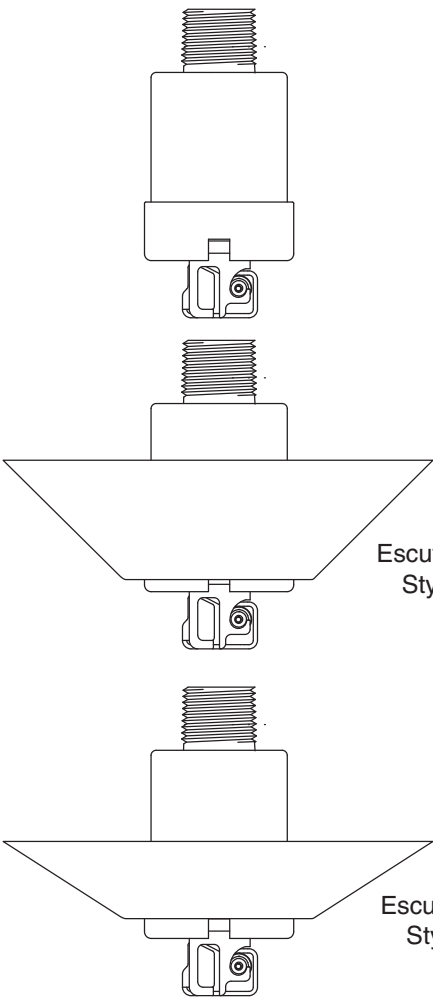

Escutcheon Style D

Escutcheon Style E

Technical Data Sheet: TFP652

See latest Technical Data Sheets for specific Approvals, Listings, Design Parameters & available finishes. Sprinkler heads & escutcheons are priced separately unless otherwise noted.

Items marked "C.O." are made to order and may require longer delivery times. Please contact customer service for availability.

Price Book - Section 6 Special Sprinklers

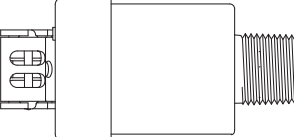
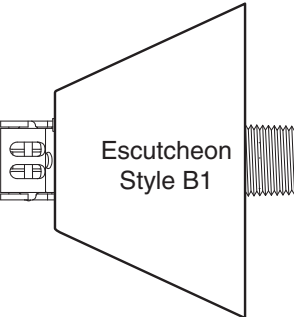
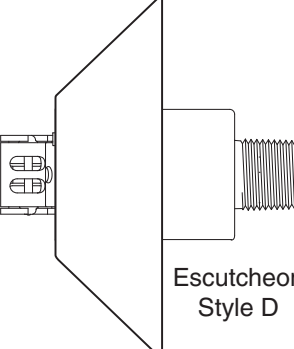
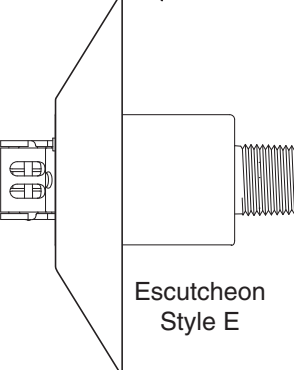
TFP MAX, K=5.6, Institutional Horizontal Sidewall, Quick Response Sprinkler					
50 Box Quantity (33 lbs/box) (SIN TY3391)					
	<i>C.O.</i>	<i>Horizontal Sidewall</i>	<i>Finish</i>	<i>Temperature</i>	<i>List Price</i>
	D	51-107-9-135	Chrome	135°F/57°C	\$71.75
		51-107-9-155	Chrome	155°F/68°C	\$71.75
	D	51-107-9-175	Chrome	175°F/79°C	\$71.75
	D	51-107-9-200	Chrome	200°F/93°C	\$71.75
Order Escutcheon Separately					
		56-001-7-511	Type B1		\$16.50
		56-001-7-514	Type D		\$15.50
		56-001-7-515	Type E		\$15.50
Accessories					
		56-000-1-781	Centering Grommet – Model 1781		\$2.40
		56-000-1-780	Retaining Flange – Model 1780		\$29.50
		56-000-1-752	Spacers		\$0.30
Sprinkler Wrench					
		56-001-5-093	Model 1509-3		\$119.50
 <p style="text-align: center;">Escutcheon Style B1</p>					
 <p style="text-align: center;">Escutcheon Style D</p>					
 <p style="text-align: center;">Escutcheon Style E</p>					
Technical Data Sheet: TFP656					

Section 1 Standard Spray Sprinklers
 Section 2 Extended Coverage Sprinklers
 Section 3 Storage Sprinklers
 Section 4 Residential Sprinklers
 Section 5 Dry Sprinklers
 Section 6 Special Sprinklers
 Section 7 Nozzles and Sprinkler Accessories

See latest Technical Data Sheets for specific Approvals, Listings, Design Parameters & available finishes. Sprinkler heads & escutcheons are priced separately unless otherwise noted.

Items marked "C.O." are made to order and may require longer delivery times. Please contact customer service for availability.

TY-B, 5mm Bulb, K=5.6, 1/2" NPT Conventional (Old Style) Sprinklers

100 Box Quantity (18 lbs/box) (SIN TY3651)

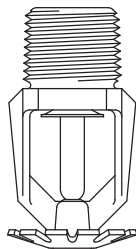
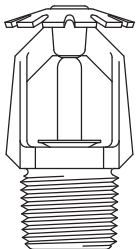

	<i>C.O.</i>	<i>Conventional</i>	<i>Finish</i>	<i>Temperature</i>	<i>List Price</i>
Section 1 Standard Spray Sprinklers	▶	57-573-1-135	Brass	135°F/57°C	\$16.25
		57-573-1-155	Brass	155°F/68°C	\$16.25
	▶	57-573-1-175	Brass	175°F/79°C	\$16.25
	▶	57-573-1-200	Brass	200°F/93°C	\$16.25
		57-573-1-286	Brass	286°F/141°C	\$16.25
	▶	57-573-1-360	Brass	360°F/182°C	\$18.75
Section 2 Extended Coverage Sprinklers	▶	57-573-9-135	Chrome	135°F/57°C	\$18.75
		57-573-9-155	Chrome	155°F/68°C	\$18.75
	▶	57-573-9-175	Chrome	175°F/79°C	\$18.75
	▶	57-573-9-200	Chrome	200°F/93°C	\$18.75
	▶	57-573-9-286	Chrome	286°F/141°C	\$18.75
	▶	57-573-9-360	Chrome	360°F/182°C	\$21.00
Section 3 Storage Sprinklers		57-573-4-135	White	135°F/57°C	\$18.75
		57-573-4-155	White	155°F/68°C	\$18.75
	▶	57-573-4-175	White	175°F/79°C	\$18.75
	▶	57-573-4-200	White	200°F/93°C	\$18.75
	▶	57-573-4-286	White	286°F/141°C	\$18.75
	▶	57-573-4-360	White	360°F/182°C	\$21.00
Section 4 Residential Sprinklers	▶	57-573-7-135	Lead Coated	135°F/57°C	\$46.75
	▶	57-573-7-155	Lead Coated	155°F/68°C	\$46.75
	▶	57-573-7-175	Lead Coated	175°F/79°C	\$46.75
	▶	57-573-7-200	Lead Coated	200°F/93°C	\$46.75
	▶	57-573-7-286	Lead Coated	286°F/141°C	\$46.75
	▶	57-573-7-360	Lead Coated	360°F/182°C	\$46.75
Section 5 Dry Sprinklers	▶	57-573-6-135	Wax Coated	135°F/57°C	\$43.75
	▶	57-573-6-155	Wax Coated	155°F/68°C	\$43.75
	▶	57-573-6-175	Wax Coated	175°F/79°C	\$43.75
	▶	57-573-6-200	Wax Coated	200°F/93°C	\$43.75
	▶	57-573-6-286	Wax Coated	286°F/141°C	\$43.75
Section 6 Special Sprinklers	▶	57-573-8-135	Wax over Lead Coated	135°F/57°C	\$62.00
	▶	57-573-8-155	Wax over Lead Coated	155°F/68°C	\$62.00
	▶	57-573-8-175	Wax over Lead Coated	175°F/79°C	\$62.00
	▶	57-573-8-200	Wax over Lead Coated	200°F/93°C	\$62.00
	▶	57-573-8-286	Wax over Lead Coated	286°F/141°C	\$62.00
Sprinkler Wrench					
		56-000-6-387	W-Type 6 Wrench		\$40.75
Technical Data Sheet: TFP661					
Section 7 Nozzles and Sprinkler Accessories					



See latest Technical Data Sheets for specific Approvals, Listings, Design Parameters & available finishes. Sprinkler heads & escutcheons are priced separately unless otherwise noted.

Items marked "C.O." are made to order and may require longer delivery times. Please contact customer service for availability.

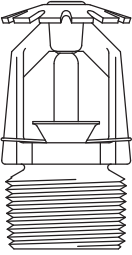
Price Book - Section 6 Special Sprinklers

TY-B, 5mm Bulb, K=8.0, 3/4" NPT Conventional (Old Style) Sprinklers					
100 Box Quantity (21 lbs/box) (SIN TY4651)					
	C.O.	Conventional	Finish	Temperature	List Price
 	▶	57-593-1-135	Brass	135°F/57°C	\$18.25
		57-593-1-155	Brass	155°F/68°C	\$18.25
	▶	57-593-1-175	Brass	175°F/79°C	\$18.25
	▶	57-593-1-200	Brass	200°F/93°C	\$18.25
		57-593-1-286	Brass	286°F/141°C	\$18.25
	▶	57-593-1-360	Brass	360°F/182°C	\$20.25
	▶	57-593-9-135	Chrome	135°F/57°C	\$21.00
		57-593-9-155	Chrome	155°F/68°C	\$21.00
	▶	57-593-9-175	Chrome	175°F/79°C	\$21.00
	▶	57-593-9-200	Chrome	200°F/93°C	\$21.00
	▶	57-593-9-286	Chrome	286°F/141°C	\$21.00
	▶	57-593-9-360	Chrome	360°F/182°C	\$23.75
	▶	57-593-4-135	White	135°F/57°C	\$21.00
		57-593-4-155	White	155°F/68°C	\$21.00
	▶	57-593-4-175	White	175°F/79°C	\$21.00
	▶	57-593-4-200	White	200°F/93°C	\$21.00
	▶	57-593-4-286	White	286°F/141°C	\$21.00
	▶	57-593-4-360	White	360°F/182°C	\$23.75
	▶	57-593-7-135	Lead Coated	135°F/57°C	\$50.00
	▶	57-593-7-155	Lead Coated	155°F/68°C	\$50.00
	▶	57-593-7-175	Lead Coated	175°F/79°C	\$50.00
	▶	57-593-7-200	Lead Coated	200°F/93°C	\$50.00
	▶	57-593-7-286	Lead Coated	286°F/141°C	\$50.00
	▶	57-593-7-360	Lead Coated	360°F/182°C	\$50.00
	▶	57-593-6-135	Wax Coated	135°F/57°C	\$46.75
	▶	57-593-6-155	Wax Coated	155°F/68°C	\$46.75
	▶	57-593-6-175	Wax Coated	175°F/79°C	\$46.75
	▶	57-593-6-200	Wax Coated	200°F/93°C	\$46.75
	▶	57-593-6-286	Wax Coated	286°F/141°C	\$46.75
	▶	57-593-8-135	Wax over Lead Coated	135°F/57°C	\$66.25
▶	57-593-8-155	Wax over Lead Coated	155°F/68°C	\$66.25	
▶	57-593-8-175	Wax over Lead Coated	175°F/79°C	\$66.25	
▶	57-593-8-200	Wax over Lead Coated	200°F/93°C	\$66.25	
▶	57-593-8-286	Wax over Lead Coated	286°F/141°C	\$66.25	
Sprinkler Wrench					
		56-000-6-387	W-Type 6 Wrench		\$40.75
Technical Data Sheet: TFP661					

Section 1
Standard Spray Sprinklers

Section 2
Extended Coverage Sprinklers

Section 3
Storage Sprinklers

Section 4
Residential Sprinklers

Section 5
Dry Sprinklers

Section 6
Special Sprinklers

Section 7
Nozzles and Sprinkler Accessories

See latest Technical Data Sheets for specific Approvals, Listings, Design Parameters & available finishes. Sprinkler heads & escutcheons are priced separately unless otherwise noted.

Items marked "C.O." are made to order and may require longer delivery times. Please contact customer service for availability.

TY-FRB, 3mm Bulb, Quick Response, K=5.6, 1/2" NPT Conventional (Old Style) Sprinklers					
100 Box Quantity (18 lbs/box) (SIN TY3631)					
	<i>C.O.</i>	<i>Conventional</i>	<i>Finish</i>	<i>Temperature</i>	<i>List Price</i>
Section 1 Standard Spray Sprinklers	▶	57-373-1-135	Brass	135°F/57°C	\$33.75
		57-373-1-155	Brass	155°F/68°C	\$33.75
	▶	57-373-1-175	Brass	175°F/79°C	\$33.75
	▶	57-373-1-200	Brass	200°F/93°C	\$33.75
		57-373-1-286	Brass	286°F/141°C	\$33.75
Section 2 Extended Coverage Sprinklers	▶	57-373-9-135	Chrome	135°F/57°C	\$35.25
		57-373-9-155	Chrome	155°F/68°C	\$35.25
	▶	57-373-9-175	Chrome	175°F/79°C	\$35.25
	▶	57-373-9-200	Chrome	200°F/93°C	\$35.25
	▶	57-373-9-286	Chrome	286°F/141°C	\$35.25
Section 3 Storage Sprinklers	▶	57-373-4-135	White	135°F/57°C	\$35.25
		57-373-4-155	White	155°F/68°C	\$35.25
	▶	57-373-4-175	White	175°F/79°C	\$35.25
	▶	57-373-4-200	White	200°F/93°C	\$35.25
	▶	57-373-4-286	White	286°F/141°C	\$35.25
Section 4 Residential Sprinklers	▶	57-373-7-135	Lead Coated	135°F/57°C	\$81.25
	▶	57-373-7-155	Lead Coated	155°F/68°C	\$81.25
	▶	57-373-7-175	Lead Coated	175°F/79°C	\$81.25
	▶	57-373-7-200	Lead Coated	200°F/93°C	\$81.25
	▶	57-373-7-286	Lead Coated	286°F/141°C	\$81.25
Sprinkler Wrench					
		56-000-6-387	W-Type 6 Wrench		\$40.75
Technical Data Sheet: TFP666					

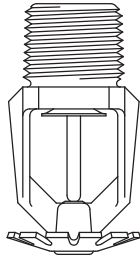
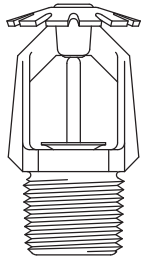

See latest Technical Data Sheets for specific Approvals, Listings, Design Parameters & available finishes. Sprinkler heads & escutcheons are priced separately unless otherwise noted.

Items marked "C.O." are made to order and may require longer delivery times. Please contact customer service for availability.

Price Book - Section 6 Special Sprinklers

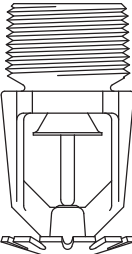
TY-FRB, 3mm Bulb, Quick Response, K=8.0, 3/4" NPT Conventional (Old Style) Sprinklers					
•100 Box Quantity (21 lbs/box) (SIN TY4631)					
	<i>C.O.</i>	<i>Conventional</i>	<i>Finish</i>	<i>Temperature</i>	<i>List Price</i>
 	D	57-393-1-135	Brass	135°F/57°C	\$37.75
		57-393-1-155	Brass	155°F/68°C	\$37.75
	D	57-393-1-175	Brass	175°F/79°C	\$37.75
	D	57-393-1-200	Brass	200°F/93°C	\$37.75
	D	57-393-1-286	Brass	286°F/141°C	\$37.75
	D	57-393-9-135	Chrome	135°F/57°C	\$40.75
		57-393-9-155	Chrome	155°F/68°C	\$40.75
	D	57-393-9-175	Chrome	175°F/79°C	\$40.75
	D	57-393-9-200	Chrome	200°F/93°C	\$40.75
	D	57-393-9-286	Chrome	286°F/141°C	\$40.75
	D	57-393-4-135	White	135°F/57°C	\$40.75
		57-393-4-155	White	155°F/68°C	\$40.75
	D	57-393-4-175	White	175°F/79°C	\$40.75
	D	57-393-4-200	White	200°F/93°C	\$40.75
	D	57-393-4-286	White	286°F/141°C	\$40.75
	D	57-393-7-135	Lead Coated	135°F/57°C	\$91.50
	D	57-393-7-155	Lead Coated	155°F/68°C	\$91.50
	D	57-393-7-175	Lead Coated	175°F/79°C	\$91.50
	D	57-393-7-200	Lead Coated	200°F/93°C	\$91.50
	D	57-393-7-286	Lead Coated	286°F/141°C	\$91.50
Sprinkler Wrench					
	56-000-6-387	W-Type 6 Wrench			\$40.75
Technical Data Sheet: TFP666					

Section 1
Standard Spray Sprinklers

Section 2
Extended Coverage Sprinklers

Section 3
Storage Sprinklers

Section 4
Residential Sprinklers



Section 5
Dry Sprinklers

Section 6
Special Sprinklers

Section 7
Nozzles and Sprinkler Accessories

See latest Technical Data Sheets for specific Approvals, Listings, Design Parameters & available finishes. Sprinkler heads & escutcheons are priced separately unless otherwise noted.

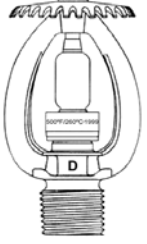
Items marked "C.O." are made to order and may require longer delivery times. Please contact customer service for availability.

Issue "D" Quartzoid® Series – High Temperature, K=5.6, 1/2" NPT, Special Sprinklers Issue D						
100 Box Quantity (Upright 27.5 lbs/box (SIN TY3191), Pendent 27.5 lbs/box (SIN TY3296))						
	C.O.	Upright	Pendent	Finish	Temperature	List Price
	▶	51-036-1-400	51-040-1-400	Brass	400°F/204°C	\$98.00
	▶	51-036-1-500	51-040-1-500	Brass	500°F/260°C	\$98.00
	▶	51-036-1-650	51-040-1-650	Brass	650°F/343°C	\$269.00
	▶	51-036-9-400	51-040-9-400	Chrome	500°F/260°C	\$130.00
	▶	51-036-9-500	51-040-9-500	Chrome	500°F/260°C	\$130.00
	▶	51-036-9-650	51-040-9-650	Chrome	650°F/343°C	\$355.00
	▶	51-036-7-400	51-040-7-400	Lead Coated	400°F/204°C	\$120.50
	▶	51-036-7-500	51-040-7-500	Lead Coated	500°F/260°C	\$120.50
	Sprinkler Wrench					
		56-452-1-001	W-Type 11 Wrench			\$24.75
<p>Note: All High Temperature Sprinklers are special ordered and are Non-Returnable. Please see "Terms & Conditions"</p> <p>Technical Data Sheet: TFP690</p>						

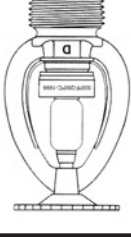
Issue "D" Quartzoid® Series – High Temperature, K=8.0, 3/4" NPT, Special Sprinklers Issue D						
100 Box Quantity (Upright 27.5 lbs/box (SIN TY4191), Pendent 27.5 lbs/box (SIN TY4291))						
	C.O.	Upright	Pendent	Finish	Temperature	List Price
	▶	51-136-1-400	51-140-1-400	Brass	400°F/204°C	\$130.00
	▶	51-136-1-500	51-140-1-500	Brass	500°F/260°C	\$130.00
	▶	51-136-9-400	51-140-9-400	Chrome	400°F/204°C	\$131.50
	▶	51-136-9-500	51-140-9-500	Chrome	500°F/260°C	\$131.50
	▶	51-136-7-400	51-140-7-400	Lead Coated	400°F/204°C	\$152.50
	▶	51-136-7-500	51-140-7-500	Lead Coated	500°F/260°C	\$152.50
	▶	51-136-8-400	51-140-8-400	Wax over Lead Coated	400°F/204°C	\$171.50
	▶	51-136-8-500	51-140-8-500	Wax over Lead Coated	500°F/260°C	\$171.50
	Sprinkler Wrench					
		56-452-1-001	W-Type 11 Wrench			\$24.75
<p>Note: All High Temperature Sprinklers are special ordered and are Non-Returnable. Please see "Terms & Conditions"</p> <p>Technical Data Sheet: TFP690</p>						

See latest Technical Data Sheets for specific Approvals, Listings, Design Parameters & available finishes. Sprinkler heads & escutcheons are priced separately unless otherwise noted.

Items marked "C.O." are made to order and may require longer delivery times. Please contact customer service for availability.

Tyco® RAVEN™, K=5.6, I-Series Institutional Pendant and Horizontal Sidewall, Quick Response, Standard and Extended Coverage Sprinklers

Pendent - (Standard Coverage SIN TY3281), (Extended Coverage SIN TY3282)
Horizontal Sidewall - (Standard Coverage SIN TY3381), (Extended Coverage SIN TY3382)

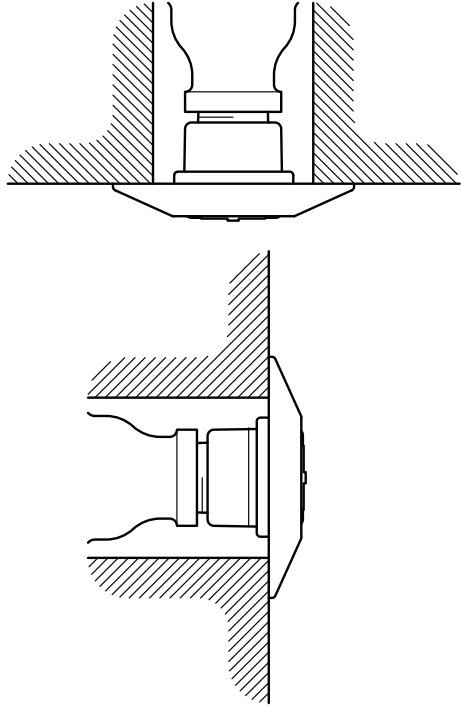
	C.O.	Part Number	Finish	Coverage	Temperature	List Price	
	Pendent						
		50-314-9-165	Chrome	Standard	165°F/74°C	\$50.50	
		50-314-4-165	White Color	Standard	165°F/74°C	\$50.50	
		50-315-9-165	Chrome	Extended	165°F/74°C	\$51.50	
		50-315-4-165	White Color	Extended	165°F/74°C	\$51.50	
	Horizontal Sidewall						
		50-316-9-165	Chrome	Standard	165°F/74°C	\$60.75	
		50-316-4-165	White Color	Standard	165°F/74°C	\$60.75	
		50-317-9-165	Chrome	Extended	165°F/74°C	\$61.75	
		50-317-4-165	White Color	Extended	165°F/74°C	\$61.75	
	Order Escutcheon Separately						
		56-314-9-010	Chrome	Style F (3" Dia.)		\$15.50	
		56-314-4-010	White Color	Style F (3" Dia.)		\$15.50	
		56-312-9-010	Chrome	Style G (4" Dia.)		\$15.50	
		56-312-4-010	White Color	Style G (4" Dia.)		\$15.50	
	Accessories						
		56-000-1-781	Centering Grommet – Model 1781				\$2.40
		56-000-1-780	Retaining Flange – Model 1780				\$29.50
		56-000-1-755	I-Series Adjustable Spacer Ring				\$0.30
	Sprinkler Wrench						
	56-314-1-001	W-Type 25				\$119.50	
Technical Data Sheet: TFP651							

Section 1
Standard Spray Sprinklers

Section 2
Extended Coverage Sprinklers

Section 3
Storage Sprinklers

Section 4
Residential Sprinklers

Section 5
Dry Sprinklers

Section 6
Special Sprinklers

Section 7
Nozzles and Sprinkler Accessories

See latest Technical Data Sheets for specific Approvals, Listings, Design Parameters & available finishes. Sprinkler heads & escutcheons are priced separately unless otherwise noted.

Items marked "C.O." are made to order and may require longer delivery times. Please contact customer service for availability.

Section 1
Standard Spray Sprinklers

Section 2
Extended Coverage Sprinklers

Section 3
Storage Sprinklers

Section 4
Residential Sprinklers

Section 5
Dry Sprinklers

**Section 6
Special Sprinklers**

Section 7
Nozzles and Sprinkler Accessories

See latest Technical Data Sheets for specific Approvals, Listings, Design Parameters & available finishes. Sprinkler heads & escutcheons are priced separately unless otherwise noted.

Items marked "C.O." are made to order and may require longer delivery times. Please contact customer service for availability.

Price Book - Section 7 Nozzles and Sprinkler Accessories

Protectospray Nozzles Model D-3 Orifice Size #16 to #34 Inclusive with 1/2" NPT Connection, Brass

Protectospray Nozzles

Protectospray Nozzles are available as open nozzles (D Series) or as a bulb type nozzle (EA-1 Series). Both types are available with deflectors designed to produce discharge patterns having included angles of : 65, 80, 95, 110, 125, 140, 160 and 180 degree

49 - 3XX - X - XXX

ORIFICE		FINISH & MATERIAL		ANGLE	
16	.206" (1/2" NPT)	1	PLAIN BRASS	065	65°
18	.250" (1/2" NPT)	7	LEADED COATED BRASS	080	80°
21	.281" (1/2" NPT)	4	TEFLON COATED BRASS	095	95°
24	.328" (1/2" NPT)	9	CHROME PLATED BRASS	110	110°
28	.375" (1/2" NPT)	0	PLAIN STAINLESS STEEL 1/2" NPT only.	125	125°
32	.438" (1/2" NPT)			140	140°
34	.500" (1/2" NPT)			160	160°
				180	180°

Orifice size of "D" Series nozzles is by numerical designations with decimal inch equivalents. Product Symbol Numbers for D Series nozzles can be developed by using the table show above. All discharge spray pattern, orifice sizes, materials and finishes as follows:

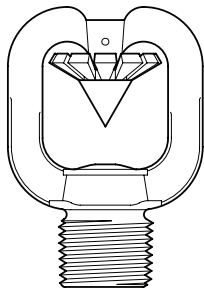

Nozzle	Finish	List Price
49-3XX-1-XXX	Plain	\$87.25
49-3XX-7-XXX	Lead Coated	\$108.00
49-3XX-4-XXX	Teflon Coated	\$210.00
49-3XX-9-XXX	Chrome Plated	\$105.00
49-3XX-0-XXX	Stainless	\$382.00

Note: All Protectospray Nozzles are special ordered and are Non-Returnable. Please see "Terms & Conditions"

Technical Data Sheet: TFP 802

Protectospray Nozzles, Model EA-1

Product Symbol Numbers for Model EA-1 Protectospray Nozzles can be determined by using the following table.

49 - XXX - X - XXX

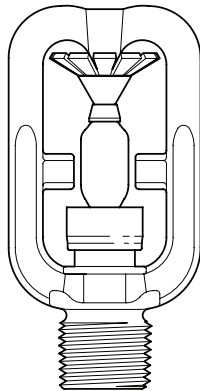
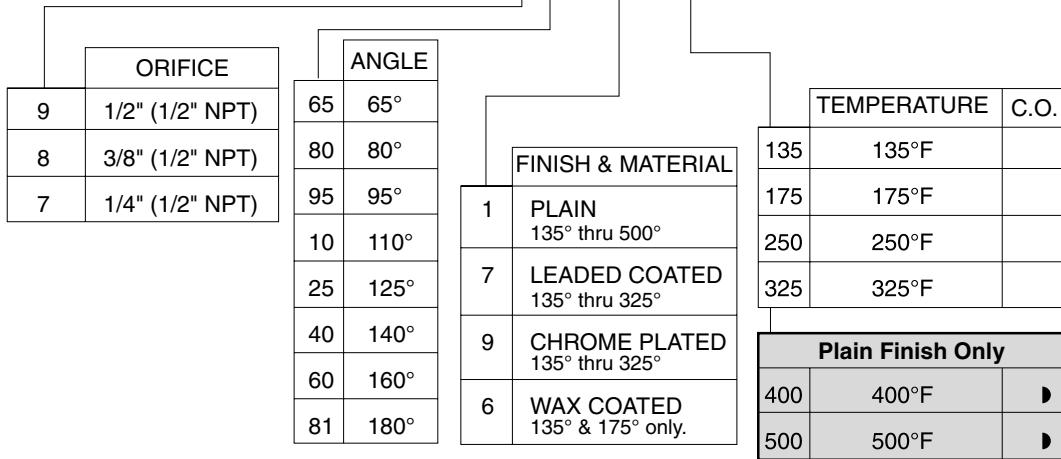

Note: All Protectospray Nozzles are special ordered and are Non-Returnable. Please see "Terms & Conditions"

Nozzle	Finish	List Price
1/2" Protectospray Nozzles Model EA-1		
49-9XX-1-XXX	Plain (135° - 325°)	\$189.00
49-9XX-1-400	Plain (Only)	\$338.00
49-9XX-1-500	Plain (Only)	\$339.00
49-9XX-7-XXX	Lead Coated	\$243.00
49-9XX-9-XXX	Chrome Plated	\$259.00
49-9XX-6-XXX	Wax Coated	\$236.00
1/4" Protectospray Nozzles Model EA-1		
49-7XX-1-XXX	Plain (135° - 325°)	\$246.50
49-7XX-1-400	Plain (Only)	\$442.00
49-7XX-1-500	Plain (Only)	\$442.00
49-7XX-7-XXX	Lead Coated	\$305.50
49-7XX-9-XXX	Chrome Plated	\$340.00
49-7XX-6-XXX	Wax Coated	\$291.50
3/8" Protectospray Nozzles Model EA-1		
49-8XX-1-XXX	Plain (135° - 325°)	\$238.50
49-8XX-1-400	Plain (Only)	\$426.00
49-8XX-1-500	Plain (Only)	\$426.00
49-8XX-7-XXX	Lead Coated	\$291.50
49-8XX-9-XXX	Chrome Plated	\$323.50
49-8XX-6-XXX	Wax Coated	\$282.50

Notes

Temperatures of 400° F & 500° F Available in Plain Finish Only

Technical Data Sheet: TFP 800

See latest Technical Data Sheets for specific Approvals, Listings, Design Parameters & available finishes. Sprinkler heads & escutcheons are priced separately unless otherwise noted.

Items marked "C.O." are made to order and may require longer delivery times. Please contact customer service for availability.

Price Book - Section 7 Nozzles and Sprinkler Accessories

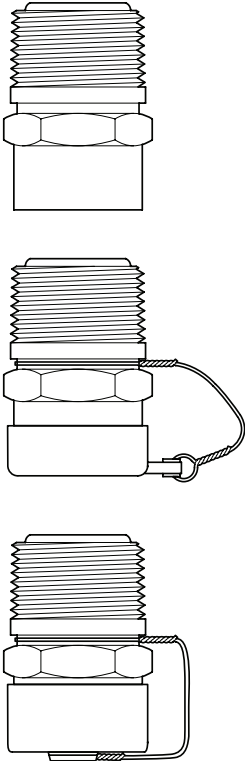
Mulsifyre Nozzles, 800 Series, 3/4" NPT Connection				
	Nozzle	Description	List Price	
 <p style="font-size: small; margin-top: 10px;">Note: All Mulsifyre Nozzles are special ordered and are Non-Returnable. Please see "Terms & Conditions"</p>	Without Blow-Off Cap			
	49-800-1-822	Model F822	\$108.00	Section 1 Standard Spray Sprinklers
	49-800-1-824	Model F824	\$108.00	
	49-800-1-826	Model F826	\$108.00	
	49-800-1-828	Model F828	\$108.00	
	49-800-1-832	Model F832	\$108.00	
	49-800-1-834	Model F834	\$108.00	
	With Dust Cap			
	49-801-1-822	Model F822	\$146.50	Section 2 Extended Coverage Sprinklers
	49-801-1-824	Model F824	\$146.50	
	49-801-1-826	Model F826	\$146.50	
	49-801-1-828	Model F828	\$146.50	
	49-801-1-832	Model F832	\$146.50	
	49-801-1-834	Model F834	\$146.50	
	With Blow-Off Cap			
	49-802-1-822	Model F822B	\$376.50	Section 3 Storage Sprinklers
	49-802-1-824	Model F824B	\$376.50	
	49-802-1-826	Model F826B	\$376.50	
49-802-1-828	Model F828B	\$376.50		
49-802-1-832	Model F832B	\$376.50		
49-802-1-834	Model F834B	\$376.50		
Technical Data Sheet: TFP810				Section 4 Residential Sprinklers

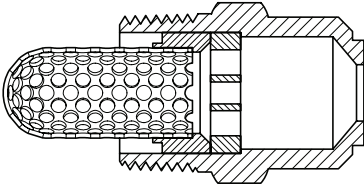
High Velocity Spray Nozzles Type HV					
	Nozzle	Description	Finish	List Price	
 <p style="font-size: small; margin-top: 10px;">Note: All High Velocity Spray Nozzles are special ordered and are Non-Returnable. Please see "Terms & Conditions"</p>	49-014-1-001	HV 14	Brass	\$150.50	
	49-017-1-001	HV 17	Brass	\$186.00	
	49-026-1-001	HV 26	Brass	\$186.00	
	49-037-1-001	HV 37	Brass	\$186.00	
	49-045-1-001	HV 45	Brass	\$186.00	
	49-060-1-001	HV 60	Brass	\$176.50	
	49-014-0-001	HV 14	Stainless Steel	\$432.50	
	49-017-0-001	HV 17	Stainless Steel	\$432.50	
	49-026-0-001	HV 26	Stainless Steel	\$432.50	
	49-037-0-001	HV 37	Stainless Steel	\$432.50	
	49-045-0-001	HV 45	Stainless Steel	\$432.50	
	49-060-0-001	HV 60	Stainless Steel	\$432.50	
	Technical Data Sheet: TFP 815				Section 5 Dry Sprinklers

See latest Technical Data Sheets for specific Approvals, Listings, Design Parameters & available finishes. Sprinkler heads & escutcheons are priced separately unless otherwise noted.

Items marked "C.O." are made to order and may require longer delivery times. Please contact customer service for availability.

Section 1
Standard Spray Sprinklers

Section 2
Extended Coverage Sprinklers

Section 3
Storage Sprinklers

Section 4
Residential Sprinklers

Section 5
Dry Sprinklers

Section 6
Special Sprinklers

Section 7
Nozzles and Sprinkler Accessories

3/4" NPT, K=2.90, Open Nozzle for Cooling Towers, Type 1 and Type 2

Standard Spray Sprinklers
Section 1

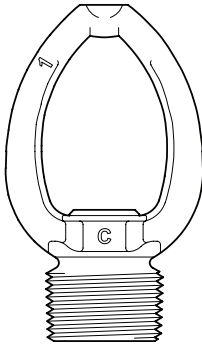

Extended Coverage Sprinklers
Section 2

Nozzle	Type, Finish	List Price
50-081-1-000	Type 1, Brass	\$70.75
50-081-0-001	Type 1, Stainless Steel	\$99.00
50-082-1-001	Type 2, Brass	\$85.25
50-082-0-001	Type 2, Stainless Steel	\$120.00
Sprinkler Wrench		
56-452-1-001	W-Type 11 Wrench	\$24.75
Technical Data Sheet: TFP830		

Model A and Model B, 1/2" NPT, Exposure Nozzles

Storage Sprinklers
Section 3

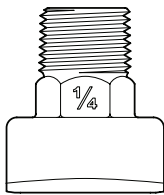

Issue A

Residential Sprinklers
Section 4

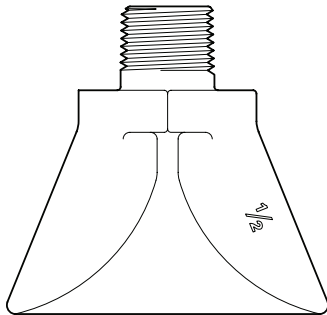

Issue B

Dry Sprinklers
Section 5

Special Sprinklers
Section 6

Nozzles and Sprinkler Accessories
Section 7

49 - XXX - X - XXX

ISSUE		FINISH & MATERIAL		ORIFICE SIZE	
200	A	1	Natural Finish Bronze	001	1/4"
201	B			002	5/16"
				003	3/8"
				004	1/2"
				005	5/8"
				006	3/4"

Exposure Sprinkler	Orifice, Finish	List Price
49-200-1-XXX	Issue A, Natural Bronze	\$120.50
49-201-1-XXX	Issue B, Natural Bronze	\$160.00

Technical Data Sheet: TFP 835

See latest Technical Data Sheets for specific Approvals, Listings, Design Parameters & available finishes. Sprinkler heads & escutcheons are priced separately unless otherwise noted.

Items marked "C.O." are made to order and may require longer delivery times. Please contact customer service for availability.

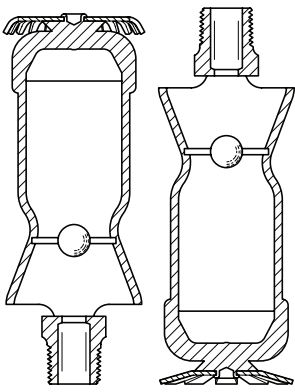
Model B-1, 1/2" Foam Water Sprinkler, 1/2" Male NPT			
	<i>Upright Deflector</i>	<i>Pendent Deflector</i>	<i>List Price</i>
	49-210-1-001	49-211-1-001	\$259.00
	<p>Technical Data Sheet: TFP 840</p>		

Section 1
Standard Spray Sprinklers

Section 2
Extended Coverage Sprinklers

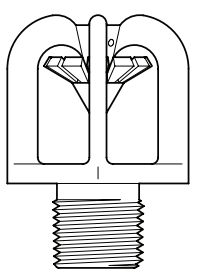
U.S. Navy Nozzle Type G , 1/2" NPT			
	<i>Nozzle</i>	<i>Finish</i>	<i>List Price</i>
	49-554-1-328	Bronze, Type G	\$322.50
	<p>Note: All Nozzles are special ordered and are Non-Returnable. Please see "Terms & Conditions"</p> <p>Technical Data Sheet: TFP 820</p>		

Section 3
Storage Sprinklers

Section 4
Residential Sprinklers

Section 5
Dry Sprinklers

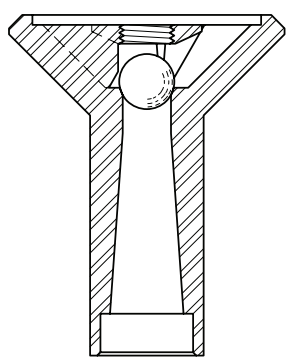
U.S. Navy Nozzle Type SB, 1/2" NPT			
	<i>Nozzle</i>	<i>Finish</i>	<i>List Price</i>
	49-556-1-012	Stainless Steel, Type SB	\$584.50
	Type SB Replacement Kits:		
	91-556-1-001	Stainless Steel Kit	\$275.50
	91-556-1-004	Threaded Insert Installation Tool	\$114.50
<p>Note: All Nozzles are special ordered and are Non-Returnable. Please see "Terms & Conditions"</p> <p>Technical Data Sheet: TFP 825</p>			

Section 6
Special Sprinklers

Section 7
Nozzles and Sprinkler Accessories

See latest Technical Data Sheets for specific Approvals, Listings, Design Parameters & available finishes. Sprinkler heads & escutcheons are priced separately unless otherwise noted.

Items marked "C.O." are made to order and may require longer delivery times. Please contact customer service for availability.

Protectospray Nozzle, Type D4-a, 1/2" NPT

49 - 4XX - X - XXX

ORIFICE		SPRAY ANGLE	
16	No. 16	065	65°
18	No. 18	080	80°
21	No. 21	095	95°
24	No. 24	110	110°
28	No. 28	125	125°
32	No. 32	140	140°
34	No. 34	160	160°
		180	180°

FINISH & MATERIAL	
1	Natural Finish Bronze
4	Teflon Coated Bronze

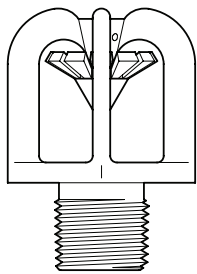

Nozzle	Finish	List Price
49-4XX-1-XXX	Natural Bronze	\$322.50
49-4XX-4-XXX	Teflon Coated Bronze	\$460.00

**Note: All Nozzles are special ordered and are Non-Returnable.
Please see "Terms & Conditions"**

Technical Data Sheet: TFP 806

Type AM4 WaterMist Nozzles, Open Bulb Type, 1/2" NPT

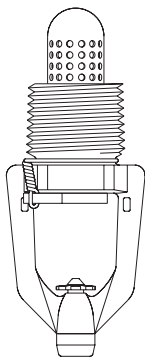

Nozzle	Finish	List Price
49-204-0-001	Stainless Steel	\$262.00
49-204-0-011	Stainless Steel W/Dust Cap	\$274.00

Replacement Parts

56-885-0-001	Replacement Model F885 Dust Cap	\$55.50
--------------	---------------------------------	---------

**Note: All Nozzles are special ordered and are Non-Returnable.
Please see "Terms & Conditions"**

Technical Data Sheet: GEM TD 1173

See latest Technical Data Sheets for specific Approvals, Listings, Design Parameters & available finishes. Sprinkler heads & escutcheons are priced separately unless otherwise noted.

Items marked "C.O." are made to order and may require longer delivery times. Please contact customer service for availability.

Price Book - Section 7 Nozzles and Sprinkler Accessories

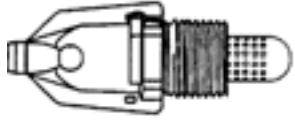
Type AM6, WaterMist Nozzles, Bulb Type, 1/2" NPT				
	Nozzle	Finish	Temperature	List Price
 <p>Note: All Nozzles are special ordered and are Non-Returnable. Please see "Terms & Conditions"</p>	49-206-1-135	Brass	135°F/57°C	\$241.50
	49-206-4-135	White	135°F/57°C	\$241.50
	49-206-9-135	Chrome	135°F/57°C	\$241.50
	49-206-0-135	Stainless Steel	135°F/57°C	\$275.50
	49-206-1-155	Brass	155°F/68°C	\$241.50
	49-206-4-155	White	155°F/68°C	\$241.50
	49-206-9-155	Chrome	155°F/68°C	\$241.50
	49-206-0-155	Stainless Steel	155°F/68°C	\$275.50
	49-206-1-175	Brass	175°F/79°C	\$241.50
	49-206-4-175	White	175°F/79°C	\$241.50
	49-206-9-175	Chrome	175°F/79°C	\$241.50
	49-206-0-175	Stainless Steel	175°F/79°C	\$275.50
	49-206-1-200	Brass	200°F/93°C	\$241.50
	49-206-4-200	White	200°F/93°C	\$241.50
	49-206-9-200	Chrome	200°F/93°C	\$241.50
	49-206-0-200	Stainless Steel	200°F/93°C	\$275.50
Technical Data Sheet: GEM TD 1170				

Section 1
Standard Spray Sprinklers

Section 2
Extended Coverage Sprinklers

Section 3
Storage Sprinklers

Type AM10 WaterMist Nozzles, Open Type, 1/2" NPT				
	Nozzle	Finish	List Price	
 <p>Note: All Nozzles are special ordered and are Non-Returnable. Please see "Terms & Conditions"</p>	49-207-0-001	Stainless Steel	\$262.00	
	49-207-0-011	Stainless Steel w/Dust Cap	\$274.00	
	Replacement Parts			
	56-885-0-001	Replacement Model F885 Dust Cap	\$55.50	
	Technical Data Sheet: GEM TD1174			

Section 4
Residential Sprinklers

Section 5
Dry Sprinklers

Section 6
Special Sprinklers

Section 7
Nozzles and Sprinkler Accessories

See latest Technical Data Sheets for specific Approvals, Listings, Design Parameters & available finishes. Sprinkler heads & escutcheons are priced separately unless otherwise noted.

Items marked "C.O." are made to order and may require longer delivery times. Please contact customer service for availability.

Type AM11 WaterMist Nozzles, Bulb Type, 1/2" NPT

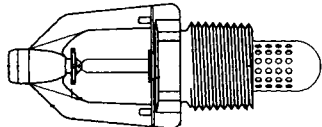

Note: All Nozzles are special ordered and are Non-Returnable. Please see "Terms & Conditions"

Nozzle	Finish	Temperature	List Price
49-208-1-135	Brass	135°F/57°C	\$241.50
49-208-4-135	White	135°F/57°C	\$241.50
49-208-9-135	Chrome	135°F/57°C	\$241.50
49-208-1-155	Brass	155°F/68°C	\$241.50
49-208-4-155	White	155°F/68°C	\$241.50
49-208-9-155	Chrome	155°F/68°C	\$241.50
49-208-1-175	Brass	175°F/79°C	\$241.50
49-208-4-175	White	175°F/79°C	\$241.50
49-208-9-175	Chrome	175°F/79°C	\$241.50
49-208-1-200	Brass	200°F/93°C	\$241.50
49-208-4-200	White	200°F/93°C	\$241.50
49-208-9-200	Chrome	200°F/93°C	\$241.50

Type AM22 WaterMist Nozzles, Bulb Type, 1/2" NPT

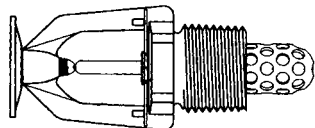

Note: All Nozzles are special ordered and are Non-Returnable. Please see "Terms & Conditions"

Nozzle	Finish	Temperature	List Price
49-209-1-135	Brass	135°F/57°C	\$241.50
49-209-4-135	White	135°F/57°C	\$241.50
49-209-9-135	Chrome	135°F/57°C	\$241.50
49-209-1-155	Brass	155°F/68°C	\$241.50
49-209-4-155	White	155°F/68°C	\$241.50
49-209-9-155	Chrome	155°F/68°C	\$241.50
49-209-1-175	Brass	175°F/79°C	\$241.50
49-209-4-175	White	175°F/79°C	\$241.50
49-209-9-175	Chrome	175°F/79°C	\$241.50
49-209-1-200	Brass	200°F/93°C	\$241.50
49-209-4-200	White	200°F/93°C	\$241.50
49-209-9-200	Chrome	200°F/93°C	\$241.50

Standard Spray Sprinklers

Section 1

Extended Coverage Sprinklers

Section 2

Storage Sprinklers

Section 3

Residential Sprinklers

Section 4

Dry Sprinklers

Section 5

Special Sprinklers

Section 6

Nozzles and Sprinkler Accessories

Section 7

See latest Technical Data Sheets for specific Approvals, Listings, Design Parameters & available finishes. Sprinkler heads & escutcheons are priced separately unless otherwise noted.

Items marked "C.O." are made to order and may require longer delivery times. Please contact customer service for availability.

Price Book - Section 7 Nozzles and Sprinkler Accessories

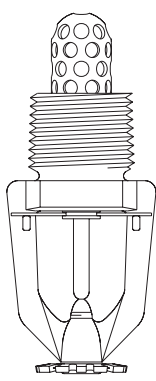
Type AM24 WaterMist Nozzles, Bulb Type, 1/2" NPT			
	Nozzle	Finish	List Price
	49-210-1-135	Brass	\$241.50
	49-210-4-135	White	\$241.50
	49-210-9-135	Chrome	\$241.50
	49-210-1-155	Brass	\$241.50
	49-210-4-155	White	\$241.50
	49-210-9-155	Chrome	\$241.50
	49-210-1-175	Brass	\$241.50
	49-210-4-175	White	\$241.50
	49-210-9-175	Chrome	\$241.50
	49-210-1-200	Brass	\$241.50
	49-210-4-200	White	\$241.50
	49-210-9-200	Chrome	\$241.50
Technical Data Sheet: GEM TD 1172			
Note: For ISO Connection, Replace (210) In Order Sequence With (220)			

Note: All Nozzles are special ordered and are Non-Returnable. Please see "Terms & Conditions"

Section 1
Standard Spray Sprinklers

Section 2
Extended Coverage Sprinklers

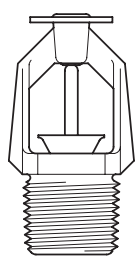
Pilot Sprinkler Model FTR-1 Fixed Temperature Release, 1/2" NPT For Deluge and Preaction Systems Wet or Dry Pilot Release Service (SIN TY3030)				
	Nozzle	Finish	Temperature	List Price
	51-041-1-135	Brass	135°F/57°C	\$21.75
	51-041-4-135	White	135°F/57°C	\$24.50
	51-041-3-135	Gray Teflon	135°F/57°C	\$43.50
	51-041-1-155	Brass	155°F/68°C	\$21.75
	51-041-4-155	White	155°F/68°C	\$24.50
	51-041-3-155	Gray Teflon	155°F/68°C	\$43.50
	51-041-1-175	Brass	175°F/79°C	\$21.75
	51-041-4-175	White	175°F/79°C	\$24.50
	51-041-3-175	Gray Teflon	175°F/79°C	\$43.50
	51-041-1-200	Brass	200°F/93°C	\$21.75
	51-041-4-200	White	200°F/93°C	\$24.50
	51-041-3-200	Gray Teflon	200°F/93°C	\$43.50
Sprinkler Wrench				
56-000-6-387	W-Type 6 Wrench			\$40.75
Technical Data Sheet: TFP1388				

Section 3
Storage Sprinklers

Section 4
Residential Sprinklers

Section 5
Dry Sprinklers

Section 6
Special Sprinklers

Section 7
Nozzles and Sprinkler Accessories

See latest Technical Data Sheets for specific Approvals, Listings, Design Parameters & available finishes. Sprinkler heads & escutcheons are priced separately unless otherwise noted.

Items marked "C.O." are made to order and may require longer delivery times. Please contact customer service for availability.

Standard Spray Sprinklers
Section 1

Nozzle Accessories - Blow-Off Caps and Dust Caps for Mulsifyre Projectors and Nozzles		
<i>Part No.</i>	<i>Description</i>	<i>List Price</i>
56-802-1-001	Blow-Off Caps for Models F822B through F834B	\$30.00
56-880-1-001	Dust Caps for Models F822 through F834	\$18.50
56-885-0-001	Blow-Off Dust Caps with Wire	\$55.50
Technical Data Sheet: GEM TD 675, GEM TD 850		

Extended Coverage Sprinklers
Section 2

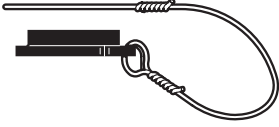
Blow-Off Plugs for Protectospray Nozzles Model D-3					
	<i>C.O.</i>	<i>Part Number</i>	<i>Description</i>	<i>List Price</i>	
		56-320-1-001	Blow Off Plug/Wire D-3 "A" (16)	\$24.25	
		56-320-1-004	Blow Off Plug/Wire D-3 "D" (34)	\$24.25	
		56-320-1-005	Blow Off Plug/Wire D-3 "E" (32) (1/2" for TY-B Sprinklers)	\$24.25	
		56-320-1-006	Blow Off Plug/Wire D-3 "H" (28)	\$24.25	
		56-320-1-007	Blow Off Plug/Wire D-3 "I" (24)	\$24.25	
		56-320-1-008	Blow Off Plug/Wire D-3 "J" (21)	\$24.25	
		56-320-1-009	Blow Off Plug/Wire D-3 "K" (18)	\$24.25	
		56-320-1-010	Blow Off Plug/Wire "N" (1 1/32")	\$24.25	
	Technical Data Sheet: TFP890				

Storage Sprinklers
Section 3

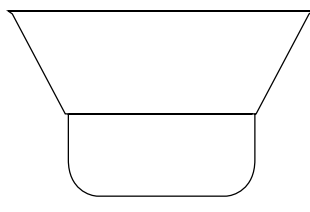
Miscellaneous Flush Escutcheons				
	<i>C.O.</i>	<i>Part Number</i>	<i>Description</i>	<i>List Price</i>
	Model 65 Flat Escutcheons			
		1150	1/2" Flat Escutcheon-Brass	\$4.40
		1184	3/4" Flat Escutcheon-Brass	\$4.40
		1153	1/2" Flat Escutcheon-Chrome	\$1.60
		1152	3/4" Flat Escutcheon-Chrome	\$1.60
		1174	1/2" Flat Escutcheon-White	\$3.70
		1175	3/4" Flat Escutcheon-White	\$3.70
		Model 401 2-Piece Adjustable Extended Escutcheons		
		1192	1/2" Cup for 2 pc. Escutcheon-Chrome	\$2.10
		1193	3/4" Cup for 2 pc. Escutcheon-Chrome	\$2.10
		1198	Skirt for 2 pc. Escutcheon-Chrome	\$2.10
		1194	1/2" Cup for 2 pc. Escutcheon-Brass	\$2.40
		1195	3/4" Cup for 2 pc. Escutcheon-Brass	\$2.40
		1199	Skirt for 2 pc. Escutcheon-Brass	\$2.40
		1196	1/2" Cup for 2 pc. Escutcheon-White	\$2.40
		1197	3/4" Cup for 2 pc. Escutcheon-White	\$2.40
		1200	Skirt for 2 pc. Escutcheon-White	\$2.40
Technical Data Sheet: TFP777				

Residential Sprinklers
Section 4

Dry Sprinklers
Section 5

Special Sprinklers
Section 6

Nozzles and Sprinkler Accessories
Section 7

See latest Technical Data Sheets for specific Approvals, Listings, Design Parameters & available finishes. Sprinkler heads & escutcheons are priced separately unless otherwise noted.

Items marked "C.O." are made to order and may require longer delivery times. Please contact customer service for availability.

Price Book - Section 7

Nozzles and Sprinkler Accessories

Typical Escutcheons				Section 1 Standard Spray Sprinklers
C.O.	Part Number	Description	List Price	
Recessed Escutcheons Style 10, 1/2" NPT (Order Separately)				Section 1 Standard Spray Sprinklers
	56-701-2-010	1/2" Brass Plated (Style 10)	\$7.70	
	56-701-9-010	1/2" Chrome Plated (Style 10)	\$5.30	
	56-701-4-010	1/2" White Color Coated (Style 10)	\$5.30	
	56-701-0-010	1/2" Stainless Steel (Style 10) with White Paint Finish	\$13.75	
Recessed Escutcheons Style 20, 1/2" NPT (Order Separately)				Section 2 Extended Coverage Sprinklers
	56-705-2-010	1/2" Brass Plated (Style 20)	\$7.70	
	56-705-9-010	1/2" Chrome Plated (Style 20)	\$5.30	
	56-705-4-010	1/2" White Color Coated (Style 20)	\$5.30	
	56-705-0-010	1/2" Stainless Steel (Style 20) with White Paint Finish	\$13.75	
Recessed Escutcheons Style 30, 3/4" NPT (Order Separately)				Section 3 Storage Sprinklers
	56-705-2-011	3/4" Brass Plated (Style 30)	\$7.70	
	56-705-9-011	3/4" Chrome Plated (Style 30)	\$5.50	
	56-705-4-011	3/4" White Color Coated (Style 30)	\$5.50	
	56-705-0-011	3/4" Stainless Steel (Style 30) with White Paint Finish	\$13.75	
Recessed Escutcheons Style 40, 3/4" NPT (Order Separately)				Section 4 Residential Sprinklers
	56-700-2-010	3/4" Brass Plated (Style 40)	\$7.70	
	56-700-9-010	3/4" Chrome Plated (Style 40)	\$5.50	
	56-700-4-010	3/4" White Color Coated (Style 40)	\$5.50	
	56-700-0-010	3/4" Stainless Steel (Style 40) with White Paint Finish	\$13.75	
Recessed Escutcheons Style 50, 1/2" NPT (Order Separately)				Section 5 Dry Sprinklers
	56-711-2-010	1/2" Brass Plated (Style 50)	\$7.70	
	56-711-9-010	1/2" Chrome Plated (Style 50)	\$5.30	
	56-711-4-010	1/2" White Color Coated (Style 50)	\$5.30	
	56-711-0-010	1/2" Stainless Steel (Style 50) with White Paint Finish	\$13.75	
Two-Piece Flush Escutcheons Style 60, 3/4" NPT (Order Separately)				Section 6 Special Sprinklers
	208107	3/4" Brass Plated (Style 60)	\$7.70	
	208102	3/4" Chrome Plated (Style 60)	\$5.50	
	208104	3/4" White Color Coated (Style 60)	\$5.50	
Protective Cover (Order Separately)				
	100-25-700	Plastic Cap Protective Cover for FR II Disposable Cover	\$2.20	
Technical Data Sheet: Style 10 thru 50 TFP 770, Style 60 TFP778				

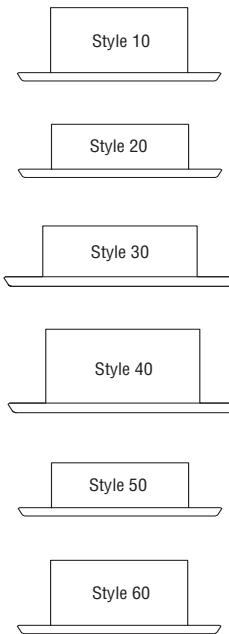

See latest Technical Data Sheets for specific Approvals, Listings, Design Parameters & available finishes. Sprinkler heads & escutcheons are priced separately unless otherwise noted.

Items marked "C.O." are made to order and may require longer delivery times. Please contact customer service for availability.

Sprinkler Head Cabinets		
<i>Part Number</i>	<i>Description</i>	<i>List Price</i>
1177	3 - Head Cabinet	\$20.75
1119	6 - Head Cabinet	\$35.25
1124	12 - Head Cabinet	\$35.25
1111	6 - ESFR Head Cabinet	\$53.25
Technical Data Sheet: TFP785		

G1 and G4 Sprinkler Guards G1/S1 and G4/S3 Guards and Shields (For Series TY-B, TY-FRB, TY-L and TY-FRL Sprinklers)		
<i>Description</i>	<i>Part Number</i>	<i>List Price</i>
G1 Guard, Red	56-938-1-001	\$7.00
G1 Guard, Zinc	56-938-9-001	\$7.00
G4 Guard, Red	56-937-1-001	\$8.30
G4 Guard, Zinc	56-937-9-001	\$8.30
G1/S1 Guard and Shield, Red	56-938-1-066	\$8.50
G1/S1 Guard and Shield, Zinc	56-938-9-066	\$8.50
G4/S3 Guard and Shield, Red	56-937-1-066	\$9.80
G4/S3 Guard and Shield, Zinc	56-937-9-066	\$9.80
Guard Installation Tool	56-000-8-597	\$1.60

G2 Guard, WS-2 Shield and WSG-2 Guard & Shield for ELO-231 Series		
<i>Description</i>	<i>Part Number</i>	<i>List Price</i>
G-2 Guard, Red	56-000-1-087	\$5.50
G-2 Guard, Zinc	56-000-1-086	\$5.50
WS-2 Shield (1/2), Red	56-000-1-081	\$6.10
WS-2 Shield (1/2), Zinc	56-000-1-080	\$6.10
WS-2 Shield (3/4), Red	56-000-1-083	\$6.10
WS-2 Shield (3/4), Zinc	56-000-1-082	\$6.10
WSG-2 Guard & Shield, Red	56-000-1-098	\$8.50
WSG-2 Guard & Shield, Zinc	56-000-1-097	\$8.50

Special Services		
Clean Room Seal / Air, Dust Seal		
<i>Description</i>	<i>Part Number</i>	<i>List Price</i>
ELOC Concealed Clean Room Seal	10908100	\$10.25
RFII Air and Dust Seal	56-908-1-001	\$9.80
Plastic Cap Protective Cover - LFII (Net Price Each)	92-000-0-412	\$0.20
All Special Finishes and Coatings are special ordered and are Non-Returnable. Please see "Terms & Conditions"		

See latest Technical Data Sheets for specific Approvals, Listings, Design Parameters & available finishes. Sprinkler heads & escutcheons are priced separately unless otherwise noted.

Items marked "C.O." are made to order and may require longer delivery times. Please contact customer service for availability.

Price Book - Section 7 Nozzles and Sprinkler Accessories

Sprinkler Wrench List

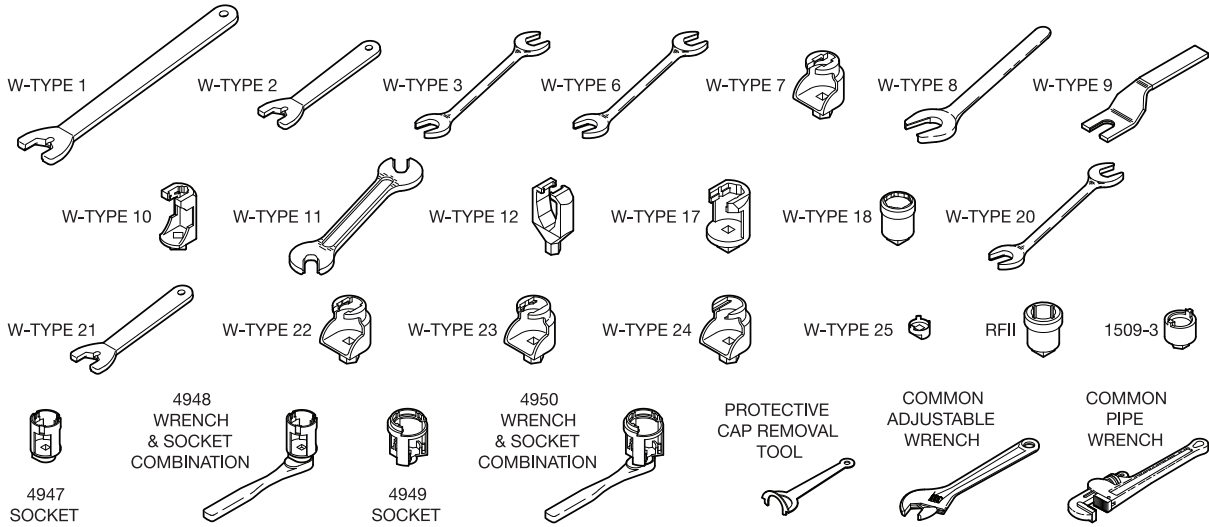

Wrench Type	Wrench used with the following Sprinkler Models:	Part No.	List Price
W-Type 1	EC-25, ESFR-25	56-872-1-025	\$52.00
W-Type 2	ESFR Pendent	56-872-1-001	\$40.75
W-Type 3	BB1 17/32, EPEC, EC-8, EC-11, EC-14, EC-17, ELO SW-20, ELO SW-24, ELO-231, ELO-231 B, ELO-231 FRB, LD	56-895-1-001	\$56.75
W-Type 6	CC2, EC-5, LFII, TY-B, TY-FRB	56-000-6-387	\$40.75
W-Type 7	CHEC, DS-1, EC-5, LFII, TY-B, TY-FRB, TY-FRFS, TY-FS, TY-FS Special	56-850-4-001	\$68.25
W-Type 8	DS-3, K17-231, Ultra K17	56-892-1-001	\$68.25
W-Type 9	TY-FRL, TY-L	56-000-1-849	\$36.50
W-Type 10	TY-FRFS, TY-FS, TY-FS Special, TY-L	56-000-1-948	\$56.75
W-Type 11	Issue D Quartzoid, Type EA-1, D3, D3S, Type 1 & 2	56-452-1-001	\$24.75
W-Type 12	TY-FRL	56-798-1-001	\$52.00
W-Type 17	DS-2	56-010-4-118	\$59.00
W-Type 18	ELOC, LFII	56-000-1-265	\$68.25
W-Type 20	CC1, HIP, WS	56-000-1-106	\$68.25
W-Type 21	ESFR-17	56-001-0-686	\$40.75
W-Type 22	EC-11, EC-14	56-665-7-001	\$68.25
W-Type 23	EC-8	56-000-6-838	\$68.25
W-Type 24	EC-17	56-000-6-856	\$68.25
W-Type 25	Tyco Raven Institutional	56-314-1-001	\$119.50
RFII	DS-C, DS-ECC, RFII	56-000-1-075	\$68.25
1509-3	TFP MAX, TFP PH2, TFP PH5	56-001-5-093	\$119.50
4947 Socket	LFII, TY-QRF	56-000-4-947	\$73.00
4948 Wrench & Socket Combo	LFII, TY-QRF	56-000-4-948	\$108.50
4949 Socket	LFII	56-000-4-949	\$73.00
4950 Wrench & Socket Combo	LFII	56-000-4-950	\$108.50
Protective Cap Removal Tool	LFII	56-000-4-300	\$24.25
Pipe Wrench	DS-1, DS-2, DS-C, DS-ECC	N/A	N/A
Adjustable Wrench	BB1, BB2, BB3, SD1, SD2, SD3, Type D4a, F822 thru F834, HV-14 thru HV-60, Issue A & B, B-1	N/A	N/A

See latest Technical Data Sheets for specific Approvals, Listings, Design Parameters & available finishes. Sprinkler heads & escutcheons are priced separately unless otherwise noted.

Items marked "C.O." are made to order and may require longer delivery times. Please contact customer service for availability.

Section 1
Standard Spray Sprinklers

Section 2
Extended Coverage Sprinklers

Section 3
Storage Sprinklers

Section 4
Residential Sprinklers

Section 5
Dry Sprinklers

Section 6
Special Sprinklers

Section 7
Nozzles and Sprinkler Accessories

Section 1
Standard Spray Sprinklers

Section 2
Extended Coverage Sprinklers

Section 3
Storage Sprinklers

Section 4
Residential Sprinklers

Section 5
Dry Sprinklers

Section 6
Special Sprinklers

Section 7
Nozzles and Sprinkler Accessories

See latest Technical Data Sheets for specific Approvals, Listings,
Design Parameters & available finishes. Sprinkler heads & escutcheons
are priced separately unless otherwise noted.

Items marked "C.O." are made to order and may require longer delivery times.
Please contact customer service for availability.

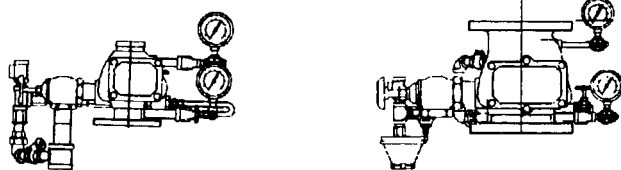
Model AV-1-300 Alarm Check Valve, 300 psi 2½" thru 8"		
		
Description	Part No.	List Price
2½" Model AV-1-300 G x G Vertical	52-203-1-110	\$1,106.00
4" Model AV-1-300 G x G Vertical/Horizontal	52-203-1-113	\$1,106.00
6" Model AV-1-300 G x G Vertical/Horizontal	52-203-1-115	\$1,361.00
8" Model AV-1-300 G x G Vertical/Horizontal	52-203-1-916	\$1,955.00
2½" Model AV-1-300, F x G Vertical	52-203-1-210	\$1,106.00
4" Model AV-1-300F x G, Vertical/Horizontal	52-203-1-413	\$1,106.00
6" Model AV-1-300F x G, Vertical/Horizontal	52-203-1-615	\$1,361.00
8" Model AV-1-300F x G, Vertical/Horizontal	52-203-1-816	\$1,955.00
4" Model AV-1-300 F x F, Vertical/Horizontal	52-203-1-013	\$1,106.00
6" Model AV-1-300 F x F, Vertical/Horizontal	52-203-1-015	\$1,361.00
8" Model AV-1-300 F x F, Vertical/Horizontal	52-203-1-016	\$1,955.00
Preassembled Alarm Check Valves		
2½" Model AV-1-300 G x G Pre-Trimmed	52-203-2-110	\$2,555.00
4" Model AV-1-300 Alarm F x G Pre-Trimmed	52-203-2-414	\$2,486.00
6" Model AV-1-300 Alarm G x G Pre-Trimmed	52-203-2-115	\$3,111.00
6" Model AV-1-300 Alarm F x G Pre-Trimmed	52-203-2-615	\$2,729.00
8" Model AV-1-300 Alarm F x G Pre-Trimmed	52-203-2-816	\$3,698.00
Trim Assemblies for 2½", 4", 6" & 8" Alarm Check Valves Model AV-1-300		
2½" Vertical Closed Drain, Basic Trim (Galvanized) AV-1-300	52-204-2-950	\$772.50
4" & 6" Vertical Closed Drain, Basic Trim (Galvanized) AV-1-300	52-204-2-951	\$951.50
4" & 6" Vertical Open Drain, Basic Trim (Galvanized) AV-1-300	52-204-2-954	\$837.00
4" & 6" Horizontal Closed Drain, Basic Trim (Galvanized) AV-1-300	52-204-2-057	\$1,015.00
8" Vertical Closed Drain, Basic Trim (Galvanized) AV-1-300	52-204-2-952	\$951.50
8" Vertical Open Drain, Basic Trim (Galvanized) AV-1-300	52-204-2-955	\$837.00
8" Horizontal Closed Drain, Basic Trim (Galvanized) AV-1-300	52-204-2-058	\$1,015.00
Pressure Relief Trim, 175 PSI	52-201-2-047	\$199.00
Pressure Relief Trim, 185 PSI	52-201-2-048	\$199.00
175 PSI Pressure Relief Valve	92-343-1-025	\$93.00
185 PSI Pressure Relief Valve	92-343-1-026	\$93.00
Main Drain	52-201-1-011	\$248.00
Trim, Alarm Vent	52-201-2-012	\$70.00
RC-1 Retard Chamber with Trim	52-211-1-002	\$435.50
Notes		
Other Options per TFP910; Pressure switch must be ordered separately, if required.		
(Replacement Parts are on the next page)		

Section 8
Wet System Valves

Section 9
Water Motor Alarms

Section 10
Dry Pipe Valves

Section 11
Quick Opening Devices

Section 12
Air Maintenance Devices

Section 13
Deluge Valves & Accessories

Section 14
Preaction Systems

Section 15
General Purpose Valves

Model AV-1-300 Alarm Check Valve, 300 psi 2½" thru 8"

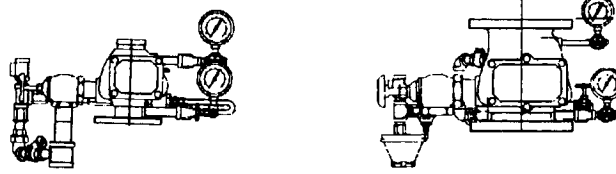

Replacement Parts for 2½" Model AV-1-300 Alarm Check Valves

Repair Parts Kit Includes: 1-Handhole Cover Gasket & 1-Clapper Facing	92-200-1-216	\$76.00
Clapper Assembly Kit Includes: 1-Clapper, 1-Clapper Facing, 1-Clapper Washer, 1-Clapper Lock Nut, 1-Clapper Hinge Pin, 2-Clapper Hinge Pin Bushings & 1-Clapper Spring	92-200-1-218	\$269.00

Replacement Parts for 4" Model AV-1-300 Alarm Check Valves

Repair Parts Kit Includes: 1-Handhole Cover Gasket & 1-Clapper Facing	92-200-1-416	\$88.00
Clapper Assembly Kit Includes: 1-Clapper, 1-Clapper Facing, 1-Clapper Washer, 1-Hex Self-Locking Cap Screw, 1-Clapper Hinge Pin Bushing & 1-Clapper Spring	92-200-1-423	\$409.50

Replacement Parts for 6" Model AV-1-300 Alarm Check Valves

Repair Parts Kit Includes: 1-Handhole Cover Gasket & 1-Clapper Facing	92-200-1-620	\$102.00
Clapper Assembly Kit Includes: 1-Clapper, 1-Clapper Facing, 1-Clapper Washer, 1-Hex Self-Locking Cap Screw, 1-Clapper Hinge Pin Bushing & 1-Clapper Spring	92-200-1-623	\$517.00

Replacement Parts for 8" Model AV-1-300 Alarm Check Valves

Repair Parts Kit Includes: 1-Handhole Cover Gasket & 1-Clapper Facing	92-200-1-816	\$143.00
Clapper Assembly Kit Includes: 1-Clapper, 1-Clapper Facing, 1-Clapper Washer, 1-Hex Self-Locking Cap Screw, 1-Clapper Hinge Pin Bushing & 1-Clapper Spring	92-200-1-823	\$817.00

Technical Data Sheet - TFP910

Shotgun CV-1FR Riser Check Valve

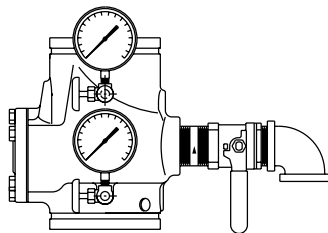

Part Numbers	Description	List Price
52-590-1-020	2" Shotgun Riser Check Valve	\$504.50
59-590-1-025	2½" Shotgun Riser Check Valve	\$495.00
59-590-1-030	3" Shotgun Riser Check Valve	\$504.50
59-590-1-040	4" Shotgun Riser Check Valve	\$504.50
59-590-1-050	5" Shotgun Riser Check Valve	\$921.00
59-590-1-060	6" Shotgun Riser Check Valve	\$937.50
59-590-1-080	8" Shotgun Riser Check Valve	\$1,696.00
Trim Assemblies for 2" thru 8" CV-1FR Riser Check Valve		
59-591-1-020	2" Shotgun Check Trim (w/ gauges)	\$342.00
59-591-1-030	2½" - 3" Shotgun Check Trim (w/ gauges)	\$342.00
59-591-1-080	4" - 8" Shotgun Check Trim (w/ gauges)	\$342.00

Technical Data Sheet: TFP950

See latest Technical Data Sheets for specific Approvals, Listings, Design Parameters & available finishes on www.tyco-fire.com.

Price Book - Section 8 Wet System Valves

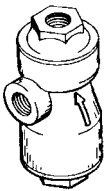
Residential Domestic Shutoff Valve			
	Description	Part No.	List Price
	1" Model RSV-1	52-540-1-001	\$824.50
	Technical Data Sheet - TFP980		

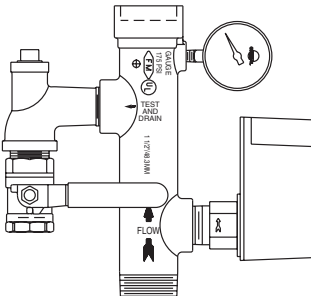
Riser Manifolds – Commercial & Residential							
	Size	Description	Type	Part No.	Part No. Canada	List Price	
	1"	Residential	Threaded F x F	4067	4085	\$591.00	
	1½"	Residential	Threaded M x F	4057	4088	\$591.00	
	1½"	Residential	Threaded M x M	4058	4089	\$591.00	
	2"	Residential	Groove x Groove	4059	4093	\$608.50	
	2"	Residential	Threaded M x Groove	4064	4094	\$660.00	
	1½"	Commercial	Threaded M x F	4055	4086	\$660.00	
	1½"	Commercial	Threaded M x M	4056	4087	\$660.00	
	2"	Commercial	Groove x Groove	4060	4090	\$660.00	
	2½"	Commercial	Groove x Groove	4061	4091	\$737.00	
	3"	Commercial	Groove x Groove	4062	4092	\$772.00	
	4"	Commercial	Groove x Groove	4065	4095	\$946.50	
	6"	Commercial	Groove x Groove	4066	4096	\$1,049.00	
		1½" - 2"	Manifold Accessory Kit		4063		\$187.50
		2½" - 3"	Manifold Accessory Kit		4072		\$187.50
		4" - 6"	Manifold Accessory Kit		4073		\$187.50
Technical Data Sheet - Central 28-1.0							

Model RC-1 Retard Chamber		
Description	Part No.	List Price
Retard Chamber, Model RC-1 w/trim	52-211-1-002	\$435.50
Replacement Parts for Model RC-1 Retard Chamber		
Restriction Assembly	92-210-2-005	\$387.50

See latest Technical Data Sheets for specific Approvals, Listings, Design Parameters & available finishes on www.tyco-fire.com.

Section 8 Wet System Valves
 Section 9 Water Motor Alarms
 Section 10 Dry Pipe Valves
 Section 11 Quick Opening Devices
 Section 12 Air Maintenance Devices
 Section 13 Deluge Valves & Accessories
 Section 14 Preaction Systems
 Section 15 General Purpose Valves

Resi-Risers		
Resi-Risers w/Retard Feature on Flow Switch and Without Pressure Relief Valve		
	<i>Description</i>	<i>Part No.</i>
Section 8 Wet System Valves	1" Resi-Riser	54-360-1-011
	1¼" Resi-Riser	54-360-1-012
Section 9 Water Motor Alarms	1½" Resi-Riser	54-360-1-013
	2" Resi-Riser	54-360-1-014
Resi-Risers w/Pressure Relief Valve and Retard Feature		
Section 10 Dry Pipe Valves	1" Resi-Riser	54-360-1-111
	1¼" Resi-Riser	54-360-1-112
Section 11 Quick Opening Devices	1½" Resi-Riser	54-360-1-113
	2" Resi-Riser	54-360-1-114
Section 12 Air Maintenance Devices		
Section 13 Deluge Valves & Accessories		
Section 14 Preaction Systems		
Section 15 General Purpose Valves		

See latest Technical Data Sheets for specific Approvals, Listings, Design Parameters & available finishes on www.tyco-fire.com.

Price Book - Section 9 Water Motor Alarms

Water Motor Alarm Model WMA-1			
	<i>Description</i>	<i>Part No.</i>	<i>List Price</i>
	WMA-1, (Aluminum), Complete with Trim	52-630-2-001	\$608.50
	WMA-1, (Red), Complete with Trim	52-630-1-001	\$608.50
	Optional Drain Trim	52-630-2-002	\$121.00
	Replacement Components for Water Motor Alarms		
	Water Motor	92-630-1-012	\$338.50
	Repair Kit: Striker, Gong (Red) and Cap Nut	92-630-1-025	\$338.50
	Repair Kit: Striker, Gong (Aluminum) and Cap Nut	92-630-2-025	\$338.50
	Replacement Trim Components		
	3/4" Strainer	52-271-1-001	\$173.00
	3/4" Check Valve	52-403-1-005	\$140.00
Technical Data Sheet - TFP 921			

Section 8
Wet System Valves

Section 9
Water Motor Alarms

Section 10
Dry Pipe Valves

Section 11
Quick Opening Devices

Section 12
Air Maintenance Devices

Section 13
Deluge Valves & Accessories

Section 14
Preaction Systems

Section 15
General Purpose Valves

See latest Technical Data Sheets for specific Approvals, Listings, Design Parameters & available finishes on www.tyco-fire.com.

Section 8
Wet System Valves

Section 9
Water Motor Alarms

Section 10
Dry Pipe Valves

Section 11
Quick Opening Devices

Section 12
Air Maintenance Devices

Section 13
Deluge Valves & Accessories

Section 14
Preaction Systems

Section 15
General Purpose Valves

See latest Technical Data Sheets for specific Approvals, Listings, Design Parameters & available finishes on www.tyco-fire.com.

Supersedes 3/18/2008

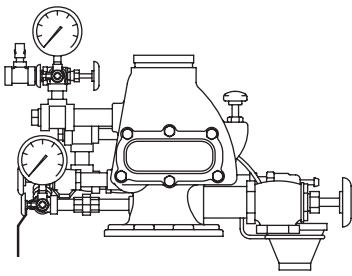
DPV-1 Dry Pipe Valve			
	<i>Description</i>	<i>Part No.</i>	<i>List Price</i>
	2½" Model DPV-1 Grooved x Grooved	52-310-1-925	\$2,340.00
	3" Model DPV-1 Grooved x Grooved	52-310-1-930	\$2,600.00
	4" Model DPV-1 Grooved x Grooved	52-310-1-940	\$2,772.00
	6" Model DPV-1 Grooved x Grooved	52-310-1-960	\$3,517.00
	4" Model DPV-1 Flange x Grooved	52-310-1-440	\$2,772.00
	6" Model DPV-1 Flange x Grooved	52-310-1-460	\$3,517.00
	4" Model DPV-1 Flange x Flange	52-310-1-040	\$2,772.00
	6" Model DPV-1 Flange x Flange	52-310-1-060	\$3,517.00
DPV-1 Dry Pipe Valve Trim			
	2½" and 3" DPV-1 Semi-Preassembled Trim (Galvanized)	52-309-2-005	\$936.50
	4" DPV-1 Semi-Preassembled Trim (Galvanized)	52-309-2-001	\$1,006.00
	6" DPV-1 Semi-Preassembled Trim (Galvanized)	52-309-2-002	\$1,006.00
DPV-1 Preassembled Valve & Trim			
	2½" DPV-1 Grooved x Grooved Pre-Trimmed (Galvanized)	52-310-2-925	\$4,093.00
	3" DPV-1 Grooved x Grooved Pre-Trimmed (Galvanized)	52-310-2-930	\$4,093.00
	4" DPV-1 Grooved x Grooved Pre-Trimmed (Galvanized)	52-310-2-940	\$4,461.00
	6" DPV-1 Grooved x Grooved Pre-Trimmed (Galvanized)	52-310-2-960	\$5,205.00
	4" DPV-1 Flange x Grooved Pre-Trimmed (Galvanized)	52-310-2-440	\$4,461.00
	6" DPV-1 Flange x Grooved Pre-Trimmed (Galvanized)	52-310-2-460	\$5,205.00
	4" DPV-1 Flange x Flange Pre-Trimmed (Galvanized)	52-310-2-040	\$4,461.00
	6" DPV-1 Flange x Flange Pre-Trimmed (Galvanized)	52-310-2-060	\$5,205.00
Notes			
Specify size and dry valve when ordering trim. Trim include alarm test valve and connections for gauges, priming, air supply and drains but does not include pressure supervisory or alarm devices.			
Replacement Parts for Model "DPV-1" Dry Pipe Valve			
	2½" and 3" Clapper Assembly	92-309-2-203	\$900.00
	2½" and 3" Repair Parts Kit	92-309-1-204	\$154.00
	4" Clapper Assembly	92-309-2-403	\$900.00
	4" Repair Parts Kit	92-309-1-404	\$154.00
	Reset Plunger Parts Kit	92-309-1-405	\$664.00
	6" Clapper Assembly	92-309-2-603	\$1,639.00
	6" Repair Parts Kit	92-309-1-604	\$235.00
Technical Data Sheet - TFP1020			

Section 8
Wet System Valves

Section 9
Water Motor Alarms

Section 10
Dry Pipe Valves

Section 11
Quick Opening Devices

Section 12
Air Maintenance Devices

Section 13
Deluge Valves & Accessories

Section 14
Preaction Systems

Section 15
General Purpose Valves

See latest Technical Data Sheets for specific Approvals, Listings, Design Parameters & available finishes on www.tyco-fire.com.

Section 8
Wet System Valves

Section 9
Water Motor Alarms

**Section 10
Dry Pipe Valves**

Section 11
Quick Opening Devices

Section 12
Air Maintenance Devices

Section 13
Deluge Valves & Accessories

Section 14
Preaction Systems

Section 15
General Purpose Valves

See latest Technical Data Sheets for specific Approvals, Listings, Design Parameters & available finishes on www.tyco-fire.com.

Supersedes 3/18/2008

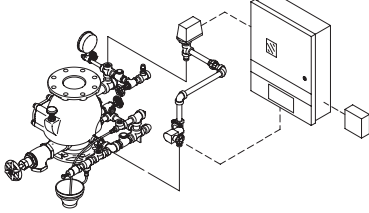
QRS Electronic Accelerator		
<i>Description</i>	<i>Part No.</i>	<i>List Price</i>
 <p>QRS Electronic Dry Pipe Valve Accelerator Package for Double Interlock Systems Includes: 1-QRS Accelerator Trim, 1-24 VDC Solenoid Valve 1-PFC-4410 RC Releasing Panel, 2-BT-80 8.0 AH Battery</p>	52-312-2-102	\$4,714.00
	QRS Electronic Dry Pipe Valve Accelerator Package for Dry Pipe Systems. (no Releasing Panel) Includes: 1-QRS Accelerator Trim, 1-24 VDC Solenoid Valve	52-312-2-001
QRS Switch Only	92-312-1-001	\$1,199.00
Replacement Battery (BT-80 8.0 AH Battery)	2656	\$58.75
Technical Data Sheet - TFP1100		

Dry Pipe Valve Accelerator, Model ACC-1		
<i>Description</i>	<i>Part No.</i>	<i>List Price</i>
 <p>Accelerator Only Accelerator Trim (Galvanized) Accelerator "Package"</p>	52-311-1-001P	\$1,351.00
	52-311-2-010	\$522.50
	52-311-2-002	\$1,941.00
Repair Parts for Dry Pipe Valve Accelerator, Model ACC-1		
Replacement Kit A (See Datasheet for Additional Information) Includes: 1-Plunger, 1-Exhaust Valve, 1-Cover Gasket, 1-O-Ring, 1-Restriction, 1-Latch, 1-O-Ring & 1.5 grams of FS3452 Fluorosilicone Grease	92-311-1-116P	\$535.50
Replacement Kit B (See Datasheet for Additional Information) Includes: 1-Pivot Plate Assembly, 4-Pan Head Machine Screws, 1-Cotter Pin, 1-Lever, 1-Retaining Ring, 1-Anti-Flood Valve, 1-Relief Valve, 1-Spring, 1-Relief Valve, 1-Spring, 1- Relief Valve Seat, 1-O-Ring, 1-Seal Washer, 1-Latch, 1-Anti-Flood Seat Assembly w/Ball Float & 1.5 grams of FS3452 Fluorosilicone Grease	92-311-1-117P	\$528.50
Replacement Kit C (See Datasheet for Additional Information) Includes: 1-Upper Diaphragm Plate, 6-Round Head Machine Screws, 1-Vent Plug, 1-Restriction Access Plate, 8-Fillerster Head Machine Screws, 1-Plug Seat, 1-O-Ring, 1-Reset Knob & 1.5 grams of FS3452 Fluorosilicone Grease	92-311-1-118	\$791.00
Technical Data Sheet - TFP1112		

See latest Technical Data Sheets for specific Approvals, Listings, Design Parameters & available finishes on www.tyco-fire.com.

Section 8 Wet System Valves
 Section 9 Water Motor Alarms
 Section 10 Dry Pipe Valves
 Section 11 Quick Opening Devices
 Section 12 Air Maintenance Devices
 Section 13 Deluge Valves & Accessories
 Section 14 Preaction Systems
 Section 15 General Purpose Valves

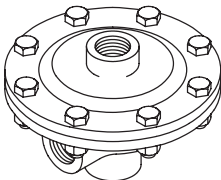
Model DP-1, Dry Pilot Actuator		
	<i>Description</i>	<i>Part Number</i>
Section 8 Wet System Valves		Dry Pilot Actuator Model DP-1 52-280-1-001 \$902.00
Section 9 Water Motor Alarms	Replacement Parts for DP-1 Dry Pilot Actuator	
Section 10 Dry Pipe Valves	Diaphragm	92-280-1-008 \$39.25
Section 11 Quick Opening Devices	Diaphragm, Plate, Sub Assembly	92-280-1-012 \$361.50
Section 12 Air Maintenance Devices	Spring	92-280-1-010 \$46.75
Section 13 Deluge Valves & Accessories	Technical Data Sheet: TFP1380	
Section 14 Preaction Systems		
Section 15 General Purpose Valves		

See latest Technical Data Sheets for specific Approvals, Listings, Design Parameters & available finishes on www.tyco-fire.com.

Air Maintenance Devices		
<i>Description</i>	<i>Part No.</i>	<i>List Price</i>
AMD-1 Air Maintenance Device	52-324-2-002	\$764.00
AMD-2 Air Maintenance Device	52-326-2-001	\$1,128.00
AMD-3 Nitrogen Maintenance Device	52-328-2-001	\$1,497.00
Replacement Parts for Air Supply Controls		
Pressure Regulator for Model AMD-1	92-324-1-012	\$573.50
Strainer 1/4", for Model AMD-1 and AMD-2	92-322-1-001	\$167.50
Pressure Switch for AMD-2 Device	92-326-1-001	\$1,082.00
Restrictor Check. Valve for AMD-1, AMD-2 and AMD-3 Device	92-326-1-003	\$144.50
Technical Data Sheet - TFP1221, TFP1231 and TFP1241		

Accessories for Air Maintenance Devices		
<i>Description</i>	<i>Part No.</i>	<i>List Price</i>
Low Pressure Alarm Switch PS40-1A	2572	\$156.50
Hi/Low Pressure Alarm Switch PS40-2A	2573	\$190.00

Section 8 Wet System Valves
 Section 9 Water Motor Alarms
 Section 10 Dry Pipe Valves
 Section 11 Quick Opening Devices
 Section 12 Air Maintenance Devices
 Section 13 Deluge Valves & Accessories
 Section 14 Preaction Systems
 Section 15 General Purpose Valves

See latest Technical Data Sheets for specific Approvals, Listings, Design Parameters & available finishes on www.tyco-fire.com.

Section 8
Wet System Valves

Section 9
Water Motor Alarms

Section 10
Dry Pipe Valves

Section 11
Quick Opening Devices

Section 12
Air Maintenance Devices

Section 13
Deluge Valves & Accessories

Section 14
Preaction Systems

Section 15
General Purpose Valves

See latest Technical Data Sheets for specific Approvals, Listings, Design Parameters & available finishes on www.tyco-fire.com.

Price Book - Section 13 Deluge Valves & Accessories

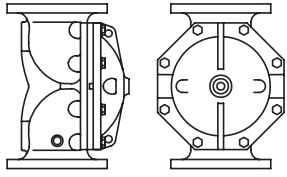
Model DV-5 Deluge Valves, Diaphragm Style					
	Description	Part No.	List Price		
	1½" Model DV-5 Grooved x Grooved, 250 PSI	52-477-1-919	\$1,729.00	Section 8 Wet System Valves	
	2" Model DV-5 Grooved x Grooved, 250 PSI	52-477-1-910	\$1,807.00		
	3" Model DV-5 Grooved x Grooved, 250 PSI	52-477-1-912	\$1,964.00		
	4" Model DV-5 Grooved x Grooved, 250 PSI	52-477-1-913	\$3,383.00	Section 9 Water Motor Alarms	
	6" Model DV-5 Grooved x Grooved, 250 PSI	52-477-1-915	\$4,125.00		
	8" Model DV-5 Grooved x Grooved, 250 PSI	52-477-1-916	\$11,805.00		
	1½" Model DV-5 Thread x Thread, 250 PSI	52-477-1-069	\$1,729.00	Section 10 Dry Pipe Valves	
	2" Model DV-5 Thread x Thread, 250 PSI	52-477-1-060	\$1,807.00		
	3" Model DV-5 Flanged x Grooved, 250 PSI	52-477-1-412	\$1,964.00		
	4" Model DV-5 Flanged x Grooved, 250 PSI	52-477-4-613	\$3,383.00	Section 11 Quick Opening Devices	
	6" Model DV-5 Flanged x Grooved, 250 PSI	52-477-4-615	\$4,125.00		
	8" Model DV-5 Flanged x Grooved, 250 PSI	52-477-1-416	\$11,805.00		
	3" Model DV-5 Flange x Flange, 250 PSI	52-477-1-012	\$1,964.00	Section 12 Air Maintenance Devices	
	4" Model DV-5 Flange x Flange, 250 PSI	52-477-1-013	\$3,383.00		
	6" Model DV-5 Flange x Flange, 250 PSI	52-477-1-015	\$4,125.00		
	8" Model DV-5 Flange x Flange, 250 PSI	52-477-1-016	\$11,805.00		
	Trim Kits for Model DV-5 Deluge Valves - 1½" and 2"				Section 13 Deluge Valves & Accessories
	1½" and 2" Wet Pilot Actuation (Galvanized) (Standard Order)	52-477-2-107	\$2,358.00	Section 14 Preaction Systems	
1½" and 2" Wet Pilot Actuation (Black)	52-477-1-107	\$2,358.00			
1½" and 2" Wet Pilot Actuation (Brass)	52-477-3-107	POA			
1½" and 2" Dry Pilot Actuation (Galvanized) (Standard Order)	52-477-2-108	\$3,142.00	Section 15 General Purpose Valves		
1½" and 2" Dry Pilot Actuation (Black)	52-477-1-108	\$3,142.00			
1½" and 2" Dry Pilot Actuation (Brass)	52-477-3-108	POA			
1½" and 2" Electric Actuation (Galvanized) (Standard Order)(Solenoid Valve Not Included)	52-477-2-109	\$2,358.00			
1½" and 2" Electric Actuation (Black) (Solenoid Valve Not Included)	52-477-1-109	\$2,358.00			
1½" and 2" Electric Actuation (Brass) (Solenoid Valve Not Included)	52-477-3-109	POA			
Trim Kits for Model DV-5 Deluge Valves - 3"					
3" Wet Pilot Actuation (Galvanized) (Standard Order)	52-477-2-104	\$2,358.00			
3" Wet Pilot Actuation (Black)	52-477-1-104	\$2,358.00			
3" Wet Pilot Actuation (Brass)	52-477-3-104	POA			
3" Dry Pilot Actuation (Galvanized) (Standard Order)	52-477-2-105	\$3,142.00			
3" Dry Pilot Actuation (Black)	52-477-1-105	\$3,142.00			
3" Dry Pilot Actuation (Brass)	52-477-3-105	POA			
3" Electric Actuation (Galvanized) (Standard Order) (Solenoid Valve Not Included)	52-477-2-106	\$2,358.00			
3" Electric Actuation (Black) (Solenoid Valve Not Included)	52-477-1-106	\$2,358.00			
3" Electric Actuation (Brass) (Solenoid Valve Not Included)	52-477-3-106	POA			

See latest Technical Data Sheets for specific Approvals, Listings, Design Parameters & available finishes on www.tyco-fire.com.

Model DV-5 Deluge Valves, Diaphragm Style (cont.)

	<i>Description</i>	<i>Part No.</i>	<i>List Price</i>
Section 8 Wet System Valves	Trim Kits for Model DV-5 Deluge Valves - 4", 6" and 8"		
	4", 6" & 8" Wet Pilot Actuation (Galvanized) (Standard Order)	52-477-2-101	\$2,358.00
	4", 6" & 8" Wet Pilot Actuation (Black)	52-477-1-101	\$2,358.00
Section 9 Water Motor Alarms	4", 6" & 8" Wet Pilot Actuation (Brass)	52-477-3-101	P.O.A.
	4", 6" & 8" Dry Pilot Actuation (Galvanized) (Standard Order)	52-477-2-102	\$3,189.00
	4", 6" & 8" Dry Pilot Actuation (Black)	52-477-1-102	\$3,189.00
	4", 6" & 8" Dry Pilot Actuation (Brass)	52-477-3-102	P.O.A.
	4", 6" & 8" Electric Actuation (Galvanized) (Standard Order) (Solenoid Valve Not Included)	52-477-2-103	\$2,358.00
	4", 6" & 8" Electric Actuation (Black) (Solenoid Valve Not Included)	52-477-1-103	\$2,358.00
Section 10 Dry Pipe Valves	4", 6" & 8" Electric Actuation (Brass) (Solenoid Valve Not Included)	52-477-3-103	P.O.A.
	Replacement Diaphragm Kits for the Model DV-5 Deluge Valve		
Section 11 Quick Opening Devices	1½" DV-5 Deluge Valve Replacement Diaphragm	92-477-1-105	\$617.00
	2" DV-5 Deluge Valve Replacement Diaphragm	92-477-1-107	\$617.00
	3" DV-5 Deluge Valve Replacement Diaphragm	92-477-1-109	\$632.50
	4" DV-5 Deluge Valve Replacement Diaphragm	92-477-1-101	\$1,692.00
	6" DV-5 Deluge Valve Replacement Diaphragm	92-477-1-103	\$2,460.00
Section 12 Air Maintenance Devices	8" DV-5 Deluge Valve Replacement Diaphragm	92-477-1-111	\$4,999.00
	Technical Data Sheets: DV-5 Valve - TFP1305, Wet Pilot - TFP1310, Dry Pilot - TFP1315, Electric Actuation - TFP1320		
Section 13 Deluge Valves & Accessories			
Section 14 Preaction Systems			
Section 15 General Purpose Valves			

See latest Technical Data Sheets for specific Approvals, Listings, Design Parameters & available finishes on www.tyco-fire.com.

Price Book - Section 13 Deluge Valves & Accessories

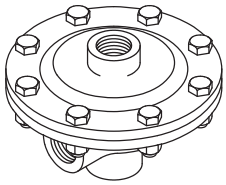
Model DP-1, Dry Pilot Actuator		
<i>Description</i>	<i>Part Number</i>	<i>List Price</i>
	Dry Pilot Actuator Model DP-1	52-280-1-001P \$902.00
Replacement Parts for DP-1 Dry Pilot Actuator		
Diaphragm	92-280-1-008	\$39.25
Diaphragm, Plate, Sub Assembly	92-280-1-012	\$361.50
Spring	92-280-1-010	\$46.75
Technical Data Sheet - TFP1380		

Deluge Valve Accessories		
<i>Description</i>	<i>Part No.</i>	<i>List Price</i>
24 VDC Solenoid Valve	52-287-1-024	\$862.50
DP-1 Dry Pilot Actuator	52-280-1-001	\$902.00
PSI Alarm Switch Model PS40-2A	2573	\$190.00
Automatic Ball Drip Valve, Plunger Type (AD-1)	51-793-1-004	\$128.50
Manual Control Station (MC-1)	52-289-1-001	\$391.00
Model PS 10 - 2A Pressure Alarm Switch	2571	\$190.00
Model OSYSU-2 Monitor Switch	2412	\$162.00
Model WMA-1 Water Motor Alarm	52-630-1-001	\$608.50
Model PFC 4410 Fire Control Panel.	20125	See Section 15
Model ASV-1 Automatic Shut-Off Valve	92-343-1-021	\$297.00
Batteries - Two Batteries are required for Stand-by power for each Control Panel. Consult TD Sheets for ratings		
<i>Description</i>	<i>Part No.</i>	<i>List Price (each)</i>
Model BT-80 (8 amp) Stand by Batteries, (2 REQ'D)	2656	\$58.75
Model BT-120 (12 amp) Stand by Batteries, (2 REQ'D)	20128	\$110.50
Notes		
Heat Detectors, Manual Control Stations, Alarm Bells, Trouble Horns, Spray Nozzles, or Open Sprinklers are ordered separately. Contact your local TFP Distributor.		

See latest Technical Data Sheets for specific Approvals, Listings, Design Parameters & available finishes on www.tyco-fire.com.

Section 8 Wet System Valves
 Section 9 Water Motor Alarms
 Section 10 Dry Pipe Valves
 Section 11 Quick Opening Devices
 Section 12 Air Maintenance Devices
 Section 13 Deluge Valves & Accessories
 Section 14 Preaction Systems
 Section 15 General Purpose Valves

Full Deluge Systems and Components

The following tables will provide information on equipment, required or optional, needed to complete various system packages. Please see the applicable Technical data pages for more information.

DV-5 Deluge, Wet Pilot Actuation, - 1½" thru 8"

Description	Part No.	List Price
-------------	----------	------------

Required Equipment for Deluge Valve (Select One)

1½ Inch DV-5 Deluge Valve, Grooved x Grooved	52-477-1-919	\$1,729.00
1½ Inch DV-5 Deluge Valve, Thread x Thread	52-477-1-069	\$1,729.00
2 Inch DV-5 Deluge Valve, Grooved x Grooved	52-477-1-910	\$1,807.00
2 Inch DV-5 Deluge Valve, Thread x Thread	52-477-1-060	\$1,807.00
3 Inch DV-5 Deluge Valve, Grooved x Grooved	52-477-1-912	\$1,964.00
3 Inch DV-5 Deluge Valve, Flanged x Flanged	52-477-1-012	\$1,964.00
3 Inch DV-5 Deluge Valve, Flanged x Grooved	52-477-1-412	\$1,964.00
4 Inch DV-5 Deluge Valve, Grooved x Grooved	52-477-1-913	\$3,383.00
4 Inch DV-5 Deluge Valve, Flanged x Flanged	52-477-1-013	\$3,383.00
4 Inch DV-5 Deluge Valve, Flanged x Grooved	52-477-4-613	\$3,383.00
6 Inch DV-5 Deluge Valve, Grooved x Grooved	52-477-1-915	\$4,125.00
6 Inch DV-5 Deluge Valve, Flanged x Flanged	52-477-1-015	\$4,125.00
6 Inch DV-5 Deluge Valve, Flanged x Grooved	52-477-4-615	\$4,125.00
8" Model DV-5 Grooved x Grooved, 250 PSI	52-477-1-916	\$11,805.00
8" Model DV-5 Flanged x Grooved, 250 PSI	52-477-1-416	\$11,805.00
8" Model DV-5 Flange x Flange, 250 PSI	52-477-1-016	\$11,805.00

Wet Pilot Deluge Trim (Select One) *Galvanized shown is standard

1½" & 2" Galvanized	52-477-2-107	\$2,358.00
3" Galvanized	52-477-2-104	\$2,358.00
4", 6" & 8" Galvanized	51-477-2-101	\$2,358.00

Water Flow Pressure Switch

Model PS10-2A	2571	\$190.00
---------------	------	----------

Optional Equipment for Deluge System, Wet Pilot Release

600 psi Water Pressure Gauge	92-343-1-004	\$158.50
Model WMA-1 Water Motor Alarm	52-630-1-001	\$608.50
Model OSYSU - 2 Monitor Switch	2412	\$162.00
Model MC-1 Manual Control Station (Galv. Ends) (TFP 1382)	52-289-2-001	\$391.00

Note

Note: Heat Detectors, Alarm Bells, Trouble Horns, Spray Nozzles, or, Open Sprinklers are ordered separately.

Technical Data Sheet - TFP1310

Full Deluge Systems and Components
The following tables will provide information on equipment, required or optional, needed to complete various system packages. Please see the applicable Technical data pages for more information.

DV-5 Deluge, Dry Pilot Actuation, - 1½" thru 8"		
<i>Description</i>	<i>Part No.</i>	<i>List Price</i>
Required Equipment for Deluge Valve (Select One)		
1-½ Inch DV-5 Deluge Valve, Grooved x Grooved	52-477-1-919	\$1,729.00
1-½ Inch DV-5 Deluge Valve, Thread x Thread	52-477-1-069	\$1,729.00
2 Inch DV-5 Deluge Valve, Grooved x Grooved	52-477-1-910	\$1,807.00
2 Inch DV-5 Deluge Valve, Thread x Thread	52-477-1-060	\$1,807.00
3 Inch DV-5 Deluge Valve, Grooved x Grooved	52-477-1-912	\$1,964.00
3 Inch DV-5 Deluge Valve, Flanged x Flanged	52-477-1-012	\$1,964.00
3 Inch DV-5 Deluge Valve, Flanged x Grooved	52-477-1-412	\$1,964.00
4 Inch DV-5 Deluge Valve, Grooved x Grooved	52-477-1-913	\$3,383.00
4 Inch DV-5 Deluge Valve, Flanged x Flanged	52-477-1-013	\$3,383.00
4 Inch DV-5 Deluge Valve, Flanged x Grooved	52-477-4-613	\$3,383.00
6 Inch DV-5 Deluge Valve, Grooved x Grooved	52-477-1-915	\$4,125.00
6 Inch DV-5 Deluge Valve, Flanged x Flanged	52-477-1-015	\$4,125.00
6 Inch DV-5 Deluge Valve, Flanged x Grooved	52-477-4-615	\$4,125.00
8" Model DV-5 Grooved x Grooved, 250 PSI	52-477-1-916	\$11,805.00
8" Model DV-5 Flanged x Grooved, 250 PSI	52-477-1-416	\$11,805.00
8" Model DV-5 Flange x Flange, 250 PSI	52-477-1-016	\$11,805.00
Dry Pilot Deluge Trim (Select One) *Galvanized shown is standard		
1½" & 2" Galvanized	52-477-2-108	\$3,142.00
3" Galvanized	52-477-2-105	\$3,142.00
4", 6" & 8" Galvanized	51-477-2-102	\$3,189.00
Water Flow Pressure Switch		
Model PS10-2A	2571	\$190.00
Dry Pilot Low Air Pressure Switch		
Model PS40-2A	2573	\$190.00
Automatic System Air Supply (Select One)		
Model AMD-1 Air Maintenance Device (TFP 1221)	52-324-2-002	\$764.00
Model AMD-2 Air Maintenance Device (TFP 1231)	52-326-2-001	\$1,128.00
Model AMD-3 Nitrogen Air Maintenance Device (TFP 1241)	52-328-2-001	\$1,497.00
Optional Equipment for Deluge System, Dry Pilot Release		
600 psi Water Pressure Gauge	92-343-1-004	\$158.50
Model WMA-1 Water Motor Alarm	52-630-1-001	\$608.50
Model OSYSU - 2 Monitor Switch	2412	\$162.00
Model MC-1 Manual Control Station (Galv. Ends) (TFP 1382)	52-289-2-001	\$391.00
Note		
Note: Heat Detectors, Alarm Bells, Trouble Horns, Spray Nozzles, or, Open Sprinklers are ordered separately.		
Technical Data Sheet - TFP1315		

Section 8
Wet System Valves

Section 9
Water Motor Alarms

Section 10
Dry Pipe Valves

Section 11
Quick Opening Devices

Section 12
Air Maintenance Devices

Section 13
Deluge Valves & Accessories

Section 14
Preaction Systems

Section 15
General Purpose Valves

See latest Technical Data Sheets for specific Approvals, Listings, Design Parameters & available finishes on www.tyco-fire.com.

Full Deluge Systems and Components

The following tables will provide information on equipment, required or optional, needed to complete various system packages. Please see the applicable Technical data pages for more information.

DV-5 Deluge, Electric Actuation, - 1½" thru 8"

Description	Part No.	List Price
-------------	----------	------------

Required Equipment for Deluge Valve (Select One)

1½ Inch DV-5 Deluge Valve, Grooved x Grooved	52-477-1-919	\$1,729.00
1½ Inch DV-5 Deluge Valve, Thread x Thread	52-477-1-069	\$1,729.00
2 Inch DV-5 Deluge Valve, Grooved x Grooved	52-477-1-910	\$1,807.00
2 Inch DV-5 Deluge Valve, Thread x Thread	52-477-1-060	\$1,807.00
3 Inch DV-5 Deluge Valve, Grooved x Grooved	52-477-1-912	\$1,964.00
3 Inch DV-5 Deluge Valve, Flanged x Flanged	52-477-1-012	\$1,964.00
3 Inch DV-5 Deluge Valve, Flanged x Grooved	52-477-1-412	\$1,964.00
4 Inch DV-5 Deluge Valve, Grooved x Grooved	52-477-1-913	\$3,383.00
4 Inch DV-5 Deluge Valve, Flanged x Flanged	52-477-1-013	\$3,383.00
4 Inch DV-5 Deluge Valve, Flanged x Grooved	52-477-4-613	\$3,383.00
6 Inch DV-5 Deluge Valve, Grooved x Grooved	52-477-1-915	\$4,125.00
6 Inch DV-5 Deluge Valve, Flanged x Flanged	52-477-1-015	\$4,125.00
6 Inch DV-5 Deluge Valve, Flanged x Grooved	52-477-4-615	\$4,125.00
8" Model DV-5 Grooved x Grooved, 250 PSI	52-477-1-916	\$11,805.00
8" Model DV-5 Flanged x Grooved, 250 PSI	52-477-1-416	\$11,805.00
8" Model DV-5 Flange x Flange, 250 PSI	52-477-1-016	\$11,805.00

Electric Actuation Deluge Trim (Select One) *Galvanized shown is standard

1½" & 2" Galvanized	52-477-2-109	\$2,358.00
3" Galvanized	52-477-2-106	\$2,358.00
4", 6" & 8" Galvanized	51-477-2-103	\$2,358.00

Water Flow Pressure Switch

Model PS10-2A	2571	\$190.00
---------------	------	----------

Solenoid Valve 24VDC (Select One)

175 psi 24VDC Solenoid Valve	52-287-1-024	\$862.50
250 psi 24VDC Solenoid Valve	52-287-1-124	POA

Optional Equipment for Deluge System, Electric Actuation

600 psi Water Pressure Gauge	92-343-1-004	\$158.50
Model WMA-1 Water Motor Alarm	52-630-1-001	\$608.50
Model OSYSU - 2 Monitor Switch	2412	\$162.00
Model MC-1 Manual Control Station (Galv. Ends) (TFP 1382)	52-289-2-001	\$391.00

Note

Note: Heat Detectors, Alarm Bells, Trouble Horns, Spray Nozzles, or, Open Sprinklers are ordered separately.

Technical Data Sheet - TFP1320

Price Book - Section 13 Deluge Valves & Accessories

Red-E-Cabinet With DV-5 Deluge Valve Preaction, Single Interlock, Double Interlock and Deluge Packages

P/N 5 2 - 8 X X - X - X X X

Valve	DV-5 Style	Size	Actuation Device	Air Maintenance Device	Trim Type	US / Canada	Compressor
52	8	1 1/2" = 1	Deluge / Wet = 1	None = 0	Galvanized = 1	None = 0	None = 0
52	8	2" = 2	Deluge / Dry = 2	Please Note: All cabinets ordered with a riser mounted compressor will automatically come with an air maintenance device. AMD-1 = 1 AMD-2 = 2 AMD-3 = 3	Black = 2	USA = A	1/6 hp 110 Gal = 1
52	8	3" = 3	Deluge / Elec = 3		Brass = 3	Canada = C	1/3 hp 215 Gal = 2
52	8	4" = 4	S/I Wet = 4		For Orders With No Control Panel, Deduct \$325 From The Price		1/2 hp 335 Gal = 3
52	8	6" = 6	S/I Dry = 5				3/4 hp 435 Gal = 4
52	8		S/I Elec = 6				1 hp 610 Gal = 5
52	8		D/I Elec / Pneu = 7				1 hp 900 Gal = 6
52	8		D/I Elec / Elec = 8				1 hp 1200 Gal = 7
52	8					S/I Compressor = 8	

S/I = Single Interlock • D/I = Double Interlock

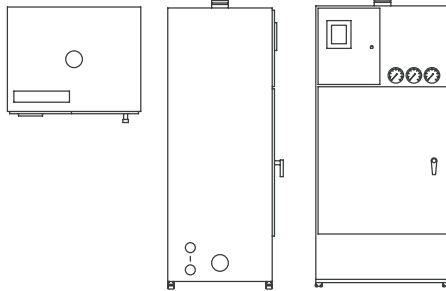

Note:
All quotes are FOB manufacturer and are considered "Special Order" and are Non-Returnable.

For orders with no Control Panel, deduct \$325 from the price

Please see "Terms & Conditions"

Deluge Valve

Description	Canadian Part No.	Canadian List Price	U.S. Part No.	U.S. List Price
Red-E DV-5 1 1/2" Deluge with Electric Actuation, Galvanized Trim, US or Canadian Control Panel	52-813-0-1C0	\$17,165.00	52-813-0-1A0	\$16,274.00
Red-E DV-5 2" Deluge with Electric Actuation, Galvanized Trim, US or Canadian Control Panel	52-823-0-1C0	\$17,368.00	52-823-0-1A0	\$16,469.00
Red-E DV-5 3" Deluge with Electric Actuation, Galvanized Trim, US or Canadian Control Panel	52-833-0-1C0	\$17,525.00	52-833-0-1A0	\$16,618.00
Red-E DV-5 4" Deluge with Electric Actuation, Galvanized Trim, US or Canadian Control Panel	52-843-0-1C0	\$19,423.00	52-843-0-1A0	\$18,449.00
Red-E DV-5 6" Deluge with Electric Actuation, Galvanized Trim, US or Canadian Control Panel	52-863-0-1C0	\$20,398.00	52-863-0-1A0	\$19,388.00

Single Interlock Preaction

Description	Canadian Part No.	Canadian List Price	U.S. Part No.	U.S. List Price
Red-E DV-5 1 1/2" Single Interlock Preaction with Electric Actuation, Galvanized Trim, US or Canadian Control Panel, Single Interlock Compressor	52-816-0-1C8	\$21,071.00	52-816-0-1A8	\$20,037.00
Red-E DV-5 2" Single Interlock Preaction with Electric Actuation, Galvanized Trim, US or Canadian Control Panel, Single Interlock Compressor	52-826-0-1C8	\$21,058.00	52-826-0-1A8	\$20,024.00
Red-E DV-5 3" Single Interlock Preaction with Electric Actuation, Galvanized Trim, US or Canadian Control Panel, Single Interlock Compressor	52-836-0-1C8	\$21,274.00	52-836-0-1A8	\$20,232.00
Red-E DV-5 4" Single Interlock Preaction with Electric Actuation, Galvanized Trim, US or Canadian Control Panel, Single Interlock Compressor	52-846-0-1C8	\$23,899.00	52-846-0-1A8	\$22,763.00
Red-E DV-5 6" Single Interlock Preaction with Electric Actuation, Galvanized Trim, US or Canadian Control Panel, Single Interlock Compressor	52-866-0-1C8	\$25,220.00	52-866-0-1A8	\$24,035.00

See latest Technical Data Sheets for specific Approvals, Listings, Design Parameters & available finishes on www.tyco-fire.com.

Section 8 Wet System Valves
Section 9 Water/Motor Alarms
Section 10 Dry Pipe Valves
Section 11 Quick Opening Devices
Section 12 Air Maintenance Devices
Section 13 Deluge Valves & Accessories
Section 14 Preaction Systems
Section 15 General Purpose Valves

**Red-E-Cabinet With DV-5 Deluge Valve
Praction, Single Interlock, Double Interlock and Deluge Packages**

Double Interlock Praction Electric/Electric Actuation

	<i>Description</i>	<i>Canadian Part No.</i>	<i>Canadian List Price</i>	<i>U.S. Part No.</i>	<i>U.S. List Price</i>
Section 8 Wet System Valves	Red-E DV-5 1½" Double Interlock Praction Electric-Electric Actuation, Galvanized Trim, US or Canadian Control Panel, 1/6 Hp OL110 Compressor	52-818-0-1C1	\$21,187.00	52-818-0-1A1	\$20,148.00
Section 9 Water Motor Alarms	Red-E DV-5 1½" Double Interlock Praction Electric-Electric Actuation, Galvanized Trim, US or Canadian Control Panel, 1/3 Hp OL215 Compressor	52-818-0-1C2	\$21,610.00	52-818-0-1A2	\$20,556.00
	Red-E DV-5 1½" Double Interlock Praction Electric-Electric Actuation, Galvanized Trim, US or Canadian Control Panel, 1/2 Hp OL335 Compressor	52-818-0-1C3	\$22,029.00	52-818-0-1A3	\$20,959.00
Section 10 Dry Pipe Valves	Red-E DV-5 2" Double Interlock Praction Electric-Electric Actuation, Galvanized Trim, US or Canadian Control Panel, 1/6 Hp OL110 Compressor	52-828-0-1C1	\$21,173.00	52-828-0-1A1	\$20,135.00
	Red-E DV-5 2" Double Interlock Praction Electric-Electric Actuation, Galvanized Trim, US or Canadian Control Panel, 1/3 Hp OL215 Compressor	52-828-0-1C2	\$21,596.00	52-828-0-1A2	\$20,543.00
	Red-E DV-5 2" Double Interlock Praction Electric-Electric Actuation, Galvanized Trim, US or Canadian Control Panel, 1/2 Hp OL335 Compressor	52-828-0-1C3	\$22,014.00	52-828-0-1A3	\$20,945.00
Section 11 Quick Opening Devices	Red-E DV-5 3" Double Interlock Praction Electric-Electric Actuation, Galvanized Trim, US or Canadian Control Panel, 1/6 Hp OL110 Compressor	52-838-0-1C1	\$21,349.00	52-838-0-1A1	\$20,305.00
	Red-E DV-5 3" Double Interlock Praction Electric-Electric Actuation, Galvanized Trim, US or Canadian Control Panel, 1/3 Hp OL215 Compressor	52-838-0-1C2	\$21,773.00	52-838-0-1A2	\$20,712.00
	Red-E DV-5 3" Double Interlock Praction Electric-Electric Actuation, Galvanized Trim, US or Canadian Control Panel, 1/2 Hp OL335 Compressor	52-838-0-1C3	\$22,183.00	52-838-0-1A3	\$21,109.00
Section 12 Air Maintenance Devices	Red-E DV-5 4" Double Interlock Praction Electric-Electric Actuation, Galvanized Trim, UUS or Canadian Control Panel, 1/6 Hp OL110 Compressor	52-848-0-1C1	\$23,975.00	52-848-0-1A1	\$22,834.00
	Red-E DV-5 4" Double Interlock Praction Electric-Electric Actuation, Galvanized Trim, US or Canadian Control Panel, 1/3 Hp OL215 Compressor	52-848-0-1C2	\$24,398.00	52-848-0-1A2	\$23,243.00
	Red-E DV-5 4" Double Interlock Praction Electric-Electric Actuation, Galvanized Trim, US or Canadian Control Panel, 1/2 Hp OL335 Compressor	52-848-0-1C3	\$24,816.00	52-848-0-1A3	\$23,646.00
	Red-E DV-5 4" Double Interlock Praction Electric-Electric Actuation, Galvanized Trim, US or Canadian Control Panel, 3/4 Hp OL435 Compressor	52-848-0-1C4	\$25,402.00	52-848-0-1A4	\$24,210.00
	Red-E DV-5 4" Double Interlock Praction Electric-Electric Actuation, Galvanized Trim, US or Canadian Control Panel, 1 Hp OL610 Compressor	52-848-0-1C5	\$25,463.00	52-848-0-1A5	\$24,268.00
Section 13 Deluge Valves & Accessories	Red-E DV-5 4" Double Interlock Praction Electric-Electric Actuation, Galvanized Trim, US or Canadian Control Panel, 1 Hp OL900 Compressor	52-848-0-1C6	\$26,970.00	52-848-0-1A6	\$25,722.00
	Red-E DV-5 4" Double Interlock Praction Electric-Electric Actuation, Galvanized Trim, US or Canadian Control Panel, 2 Hp OL1200 Compressor	52-848-0-1C7	\$27,375.00	52-848-0-1A7	\$26,111.00
	Red-E DV-5 6" Double Interlock Praction Electric-Electric Actuation, Galvanized Trim, US or Canadian Control Panel, 1/6 Hp OL110 Compressor	52-868-0-1C1	\$25,301.00	52-868-0-1A1	\$24,112.00
	Red-E DV-5 6" Double Interlock Praction Electric-Electric Actuation, Galvanized Trim, US or Canadian Control Panel, 1/3 Hp OL215 Compressor	52-868-0-1C2	\$25,718.00	52-868-0-1A2	\$24,515.00
	Red-E DV-5 6" Double Interlock Praction Electric-Electric Actuation, Galvanized Trim, US or Canadian Control Panel, 1/2 Hp OL335 Compressor	52-868-0-1C3	\$26,136.00	52-868-0-1A3	\$24,917.00
	Red-E DV-5 6" Double Interlock Praction Electric-Electric Actuation, Galvanized Trim, US or Canadian Control Panel, 3/4 Hp OL435 Compressor	52-868-0-1C4	\$26,723.00	52-868-0-1A4	\$25,482.00
	Red-E DV-5 6" Double Interlock Praction Electric-Electric Actuation, Galvanized Trim, US or Canadian Control Panel, 1 Hp OL610 Compressor	52-868-0-1C5	\$26,782.00	52-868-0-1A5	\$25,540.00
Section 14 Praction Systems	Red-E DV-5 6" Double Interlock Praction Electric-Electric Actuation, Galvanized Trim, US or Canadian Control Panel, 1 Hp OL900 Compressor	52-868-0-1C6	\$28,299.00	52-868-0-1A6	\$27,001.00
	Red-E DV-5 6" Double Interlock Praction Electric-Electric Actuation, Galvanized Trim, US or Canadian Control Panel, 2 Hp OL1200 Compressor	52-868-0-1C7	\$28,694.00	52-868-0-1A7	\$27,383.00
Section 15 General Purpose Valves					

See latest Technical Data Sheets for specific Approvals, Listings, Design Parameters & available finishes on www.tyco-fire.com.

Price Book - Section 13 Deluge Valves & Accessories

Red-E-Cabinet With DV-5 Deluge Valve Praction, Single Interlock, Double Interlock and Deluge Packages					Section 8 Wet System Valves
Double Interlock Praction Electric/Pneumatic Actuation					
<i>Description</i>	<i>Canadian Part No.</i>	<i>Canadian List Price</i>	<i>U.S. Part No.</i>	<i>U.S. List Price</i>	
Red-E DV-5 1-1/2" Double Interlock Praction Electric-Pneumatic Actuation, Galvanized Trim, US or Canadian Control Panel, 1/6 Hp OL110 Compressor	52-817-0-1C1	\$21,483.00	52-817-0-1A1	\$20,434.00	
Red-E DV-5 1-1/2" Double Interlock Praction Electric-Pneumatic Actuation, Galvanized Trim, US or Canadian Control Panel, 1/3 Hp OL215 Compressor	52-817-0-1C2	\$21,907.00	52-817-0-1A2	\$20,843.00	
Red-E DV-5 1-1/2" Double Interlock Praction Electric-Pneumatic Actuation, Galvanized Trim, US or Canadian Control Panel, 1/2 Hp OL335 Compressor	52-817-0-1C3	\$22,324.00	52-817-0-1A3	\$21,244.00	Section 9 Water/Motor Alarms
Red-E DV-5 2" Double Interlock Praction Electric-Pneumatic Actuation, Galvanized Trim, US or Canadian Control Panel, 1/6 Hp OL110 Compressor	52-827-0-1C1	\$21,476.00	52-827-0-1A1	\$20,427.00	
Red-E DV-5 2" Double Interlock Praction Electric-Pneumatic Actuation, Galvanized Trim, US or Canadian Control Panel, 1/3 Hp OL215 Compressor	52-827-0-1C2	\$21,894.00	52-827-0-1A2	\$20,829.00	Section 10 Dry Pipe Valves
Red-E DV-5 2" Double Interlock Praction Electric-Pneumatic Actuation, Galvanized Trim, US or Canadian Control Panel, 1/2 Hp OL335 Compressor	52-827-0-1C3	\$22,311.00	52-827-0-1A3	\$21,232.00	
Red-E DV-5 3" Double Interlock Praction Electric-Pneumatic Actuation, Galvanized Trim, US or Canadian Control Panel, 1/6 Hp OL110 Compressor	52-837-0-1C1	\$21,961.00	52-837-0-1A1	\$20,894.00	
Red-E DV-5 3" Double Interlock Praction Electric-Pneumatic Actuation, Galvanized Trim, US or Canadian Control Panel, 1/3 Hp OL215 Compressor	52-837-0-1C2	\$22,386.00	52-837-0-1A2	\$21,302.00	
Red-E DV-5 3" Double Interlock Praction Electric-Pneumatic Actuation, Galvanized Trim, US or Canadian Control Panel, 1/2 Hp OL335 Compressor	52-837-0-1C3	\$22,796.00	52-837-0-1A3	\$21,699.00	Section 11 Quick Opening Devices
Red-E DV-5 4" Double Interlock Praction Electric-Pneumatic Actuation, Galvanized Trim, US or Canadian Control Panel, 1/6 Hp OL110 Compressor	52-847-0-1C1	\$24,587.00	52-847-0-1A1	\$23,424.00	
Red-E DV-5 4" Double Interlock Praction Electric-Pneumatic Actuation, Galvanized Trim, US or Canadian Control Panel, 1/3 Hp OL215 Compressor	52-847-0-1C2	\$25,011.00	52-847-0-1A2	\$23,834.00	
Red-E DV-5 4" Double Interlock Praction Electric-Pneumatic Actuation, Galvanized Trim, US or Canadian Control Panel, 1/2 Hp OL335 Compressor	52-847-0-1C3	\$25,429.00	52-847-0-1A3	\$24,237.00	Section 12 Air Maintenance Devices
Red-E DV-5 4" Double Interlock Praction Electric-Pneumatic Actuation, Galvanized Trim, US or Canadian Control Panel, 3/4 Hp OL435 Compressor	52-847-0-1C4	\$26,014.00	52-847-0-1A4	\$24,800.00	
Red-E DV-5 4" Double Interlock Praction Electric-Pneumatic Actuation, Galvanized Trim, US or Canadian Control Panel, 1 Hp OL610 Compressor	52-847-0-1C5	\$26,076.00	52-847-0-1A5	\$24,859.00	
Red-E DV-5 4" Double Interlock Praction Electric-Pneumatic Actuation, Galvanized Trim, US or Canadian Control Panel, 1 Hp OL900 Compressor	52-847-0-1C6	\$27,584.00	52-847-0-1A6	\$26,312.00	
Red-E DV-5 4" Double Interlock Praction Electric-Pneumatic Actuation, Galvanized Trim, US or Canadian Control Panel, 2 Hp OL1200 Compressor	52-847-0-1C7	\$27,988.00	52-847-0-1A7	\$26,702.00	Section 13 Deluge Valves & Accessories
Red-E DV-5 6" Double Interlock Praction Electric-Pneumatic Actuation, Galvanized Trim, US or Canadian Control Panel, 1/6 Hp OL110 Compressor	52-867-0-1C1	\$25,098.00	52-867-0-1A1	\$23,917.00	
Red-E DV-5 6" Double Interlock Praction Electric-Pneumatic Actuation, Galvanized Trim, US or Canadian Control Panel, 1/3 Hp OL215 Compressor	52-867-0-1C2	\$25,516.00	52-867-0-1A2	\$24,320.00	
Red-E DV-5 6" Double Interlock Praction Electric-Pneumatic Actuation, Galvanized Trim, US or Canadian Control Panel, 1/2 Hp OL335 Compressor	52-867-0-1C3	\$25,934.00	52-867-0-1A3	\$24,722.00	
Red-E DV-5 6" Double Interlock Praction Electric-Pneumatic Actuation, Galvanized Trim, US or Canadian Control Panel, 3/4 Hp OL435 Compressor	52-867-0-1C4	\$26,102.00	52-867-0-1A4	\$24,886.00	Section 14 Praction Systems
Red-E DV-5 6" Double Interlock Praction Electric-Pneumatic Actuation, Galvanized Trim, US or Canadian Control Panel, 1 Hp OL610 Compressor	52-867-0-1C5	\$26,580.00	52-867-0-1A5	\$25,345.00	
Red-E DV-5 6" Double Interlock Praction Electric-Pneumatic Actuation, Galvanized Trim, US or Canadian Control Panel, 1 Hp OL900 Compressor	52-867-0-1C6	\$28,096.00	52-867-0-1A6	\$26,805.00	
Red-E DV-5 6" Double Interlock Praction Electric-Pneumatic Actuation, Galvanized Trim, US or Canadian Control Panel, 2 Hp OL1200 Compressor	52-867-0-1C7	\$28,493.00	52-867-0-1A7	\$27,189.00	Section 15 General Purpose Valves
Technical Data Sheet Deluge-TFP1300, Praction-TFP1400					

See latest Technical Data Sheets for specific Approvals, Listings, Design Parameters & available finishes on www.tyco-fire.com.

**Red-E-Cabinet with "MCC" Mist Control Center
Preassembled Fire Pump, Controller, Deluge Valve Cabinet & Releasing Panel**



Aquamist Control Center

<i>Description</i>	<i>Part No.</i>	<i>List Price</i>
MCC-1 Mist Control Center, Provides 4-60 GPM	52-811-1-111	POA
MCC-2 Mist Control Center, Provides 60-120 GPM	52-811-1-112	POA

Section 8
Wet System Valves

Section 9
Water Motor Alarms

Section 10
Dry Pipe Valves

Section 11
Quick Opening Devices

Section 12
Air Maintenance Devices

**Section 13
Deluge Valves & Accessories**

Section 14
Preaction Systems

Section 15
General Purpose Valves

See latest Technical Data Sheets for specific Approvals, Listings, Design Parameters & available finishes on www.tyco-fire.com.

Price Book - Section 13 Deluge Valves & Accessories

DV-5 Pre-Trimmed Deluge & Preaction Systems

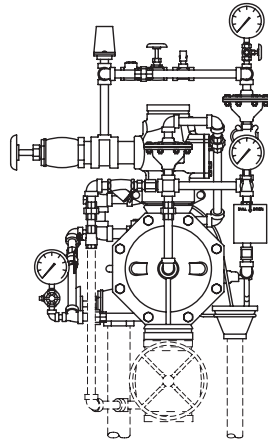

Each Pre-Trimmed Valve Contains:

- Deluge Valve
- Riser Check Valve
- Actuation Trim with Solenoid Valve
- Pneumatic Actuator (if Applicable)
- Pressure Switch
- All Connection Fittings and Devices

Each Pre-Trimmed Valve System Is Individually Palletized and Packaged

Description	Part No.	Average Wt. Ea.	List Price
Pre-Trimmed, Deluge Electric Actuation, US Model, Groove x Groove			
1½" Pre-Trimmed DV-5 Deluge Electric Actuation with Galvanized Trim	52-813-01A-P	75 Lbs	\$4,886.00
2" Pre-Trimmed DV-5 Deluge Electric with Galvanized Trim	52-823-01A-P	75 Lbs	\$4,954.00
3" Pre-Trimmed DV-5 Deluge Electric with Galvanized Trim	52-833-01A-P	120 Lbs	\$5,077.00
4" Pre-Trimmed DV-5 Deluge Electric with Galvanized Trim	52-843-01A-P	160 Lbs	\$6,203.00
6" Pre-Trimmed DV-5 Deluge Electric with Galvanized Trim	52-863-01A-P	220 Lbs	\$6,792.00
Note: For a Complete List of System Components, Please Refer to Page:13-6 Control Valve is Sold Separately, Please Refer to Pages 15-2 & 15-3			
Pre-Trimmed, Double Interlock Electric-Pneumatic Actuation, US Model, Groove x Groove			
1½" Pre-Trimmed DV-5 Double Interlock "Electric-Pneumatic" Actuation with Galvanized Trim	52-817-01A-P	75 Lbs	\$7,642.00
2" Pre-Trimmed DV-5 Double Interlock "Electric-Pneumatic" Actuation with Galvanized Trim	52-827-01A-P	75 Lbs	\$7,642.00
3" Pre-Trimmed DV-5 Double Interlock "Electric-Pneumatic" Actuation with Galvanized Trim	52-837-01A-P	120 Lbs	\$7,703.00
4" Pre-Trimmed DV-5 Double Interlock "Electric-Pneumatic" Actuation with Galvanized Trim	52-847-01A-P	160 Lbs	\$9,270.00
6" Pre-Trimmed DV-5 Double Interlock "Electric-Pneumatic" Actuation with Galvanized Trim	52-867-01A-P	220 Lbs	\$10,123.00
Note: For a Complete List of System Components, Please Refer to Page:14-4 Control Valve is Sold Separately, Please Refer to Pages 15-2 & 15-3			
Pre-Trimmed, Double Interlock Electric-Electric Actuation, US Model, Groove x Groove			
1½" Pre-Trimmed DV-5 Double Interlock "Electric-Electric" Actuation with Galvanized Trim	52-818-01A-P	75 Lbs	\$5,817.00
2" Pre-Trimmed DV-5 Double Interlock "Electric-Electric" Actuation with Galvanized Trim	52-828-01A-P	75 Lbs	\$5,817.00
3" Pre-Trimmed DV-5 Double Interlock "Electric-Electric" Actuation with Galvanized Trim	52-838-01A-P	120 Lbs	\$5,878.00
4" Pre-Trimmed DV-5 Double Interlock "Electric-Electric" Actuation with Galvanized Trim	52-848-01A-P	160 Lbs	\$7,336.00
6" Pre-Trimmed DV-5 Double Interlock "Electric-Electric" Actuation with Galvanized Trim	52-868-01A-P	220 Lbs	\$8,187.00
Note: For a Complete List of System Components, Please Refer to Page:14-5, Control Valve is Sold Separately, Please Refer to Pages 15-2 & 15-3			
Pre-Trimmed, Single Interlock Electric Actuation, US Model, Groove x Groove			
1½" Pre-Trimmed DV-5 Single Interlock Electric Actuation with Galvanized Trim	52-816-01A-P	75 Lbs	\$5,976.00
2" Pre-Trimmed DV-5 Single Interlock Electric Actuation with Galvanized Trim	52-826-01A-P	75 Lbs	\$5,976.00
3" Pre-Trimmed DV-5 Single Interlock Electric Actuation with Galvanized Trim	52-836-01A-P	120 Lbs	\$6,039.00
4" Pre-Trimmed DV-5 Single Interlock Electric Actuation with Galvanized Trim	52-846-01A-P	160 Lbs	\$8,009.00
6" Pre-Trimmed DV-5 Single Interlock Electric Actuation with Galvanized Trim	52-866-01A-P	220 Lbs	\$8,866.00
Note: For a Complete List of System Components, Please Refer to Page:14-3, Control Valve is Sold Separately, Please Refer to Pages 15-2 & 15-3			

Section 8 Wet System Valves
 Section 9 Water Motor Alarms
 Section 10 Dry Pipe Valves
 Section 11 Quick Opening Devices
 Section 12 Air Maintenance Devices
 Section 13 Deluge Valves & Accessories
 Section 14 Preaction Systems
 Section 15 General Purpose Valves

See latest Technical Data Sheets for specific Approvals, Listings, Design Parameters & available finishes on www.tyco-fire.com.

Section 8 Wet System Valves
Section 9 Water Motor Alarms
Section 10 Dry Pipe Valves
Section 11 Quick Opening Devices
Section 12 Air Maintenance Devices
Section 13 Deluge Valves & Accessories
Section 14 Preaction Systems
Section 15 General Purpose Valves

See latest Technical Data Sheets for specific Approvals, Listings, Design Parameters & available finishes on www.tyco-fire.com.

Full Preaction Systems and Components

The following tables will provide information on equipment, required or optional, needed to complete various system packages. Please see the applicable Technical data pages for more information.

DV-5 Single Interlock, Wet Pilot Actuation, - 1½" thru 8"		
<i>Description</i>	<i>Part No.</i>	<i>List Price</i>
Required Equipment for Deluge Valve (Select One) *P/N for GRXGR shown. (See data sheets for other end configurations)		
1½" DV-5 Deluge Valve, Grooved x Grooved	52-477-1-919	\$1,729.00
2" DV-5 Deluge Valve, Grooved x Grooved	52-477-1-910	\$1,807.00
3" DV-5 Deluge Valve, Grooved x Grooved	52-477-1-912	\$1,964.00
4" DV-5 Deluge Valve, Grooved x Grooved	52-477-1-913	\$3,383.00
6" DV-5 Deluge Valve, Grooved x Grooved	52-477-1-915	\$4,125.00
8" DV-5 Deluge Valve, Grooved x Grooved	52-477-1-916	\$11,805.00
Riser Check Valve (Select One) *For 1½" DV-5, use 2" Riser Check		
2" Model F517 Riser Check Valve	52-517-1-020	\$504.50
3" CV-1FR Riser Check Valve	59-590-1-030	\$504.50
4" CV-1FR Riser Check Valve	59-590-1-040	\$504.50
6" CV-1FR Riser Check Valve	59-590-1-060	\$937.50
8" CV-1FR Riser Check Valve	59-590-1-080	\$1,696.00
Coupling (Select One)		
2 x 1½" Figure 716 Reducing Coupling (for 1½" DV-5)	7162015ES	See Section 18 for current list prices
2" Figure 772 Rigid Coupling	77220ASC	
3" Figure 772 Rigid Coupling	77230ASC	
4" Figure 772 Rigid Coupling	77240ASC	
6" Figure 772 Rigid Coupling	77260ASC	
8" Figure 772 Rigid Coupling	77280ASC	
Single Interlock Wet Pilot Preaction Trim (Select One) *Galvanized shown is standard		
1½" & 2" Galvanized	52-478-2-117	\$3,260.00
3" Galvanized	52-478-2-114	\$3,380.00
4", 6" and 8" Galvanized	52-478-2-111	\$3,614.00
Automatic System Air Supply (Select One)		
Model AMD-1 Air Maintenance Device (TFP 1221)	52-324-2-002	\$764.00
Model AMD-2 Air Maintenance Device (TFP 1231)	52-326-2-001	\$1,128.00
Model G16AC812 Supervisory Air Supply (TD126)	52-150-1-001	\$2,252.00
Optional Equipment for S/I Preaction System, Wet Pilot Release		
600 psi Water Pressure Gauge	92-343-1-004	\$158.50
Model WMA-1 Water Motor Alarm	52-630-1-001	\$608.50
Model OSYSU - 2 Monitor Switch	2412	\$162.00
Model MC-1 Manual Control Station (Galv. Ends) (TFP 1382)	52-289-2-001	\$391.00
Note		
Note: Heat Detectors, Alarm Bells, Trouble Horns, Spray Nozzles, or, Open Sprinklers are ordered separately.		
Technical Data Sheet - TFP1410		

Section 8
Wet System Valves

Section 9
Water Motor Alarms

Section 10
Dry Pipe Valves

Section 11
Quick Opening Devices

Section 12
Air Maintenance Devices

Section 13
Deluge Valves & Accessories

Section 14
Preaction Systems

Section 15
General Purpose Valves

See latest Technical Data Sheets for specific Approvals, Listings, Design Parameters & available finishes on www.tyco-fire.com.

Full Praction Systems and Components

The following tables will provide information on equipment, required or optional, needed to complete various system packages. Please see the applicable Technical data pages for more information.

DV-5 Single Interlock, Dry Pilot Actuation, - 1½" thru 8"

**Required Equipment for Deluge Valve (Select One) *P/N for GRXGR shown.
See data sheets for other end configurations**

Description	Part No.	List Price
1½" DV-5 Deluge Valve, Grooved x Grooved	52-477-1-919	\$1,729.00
2" DV-5 Deluge Valve, Grooved x Grooved	52-477-1-910	\$1,807.00
3" DV-5 Deluge Valve, Grooved x Grooved	52-477-1-912	\$1,964.00
4" DV-5 Deluge Valve, Grooved x Grooved	52-477-1-913	\$3,383.00
6" DV-5 Deluge Valve, Grooved x Grooved	52-477-1-915	\$4,125.00
8" DV-5 Deluge Valve, Grooved x Grooved	52-477-1-916	\$11,805.00

Riser Check Valve (Select One) *For 1½" DV-5, use 2" Riser Check

2 Inch Model F517 Riser Check Valve	52-517-1-020	\$504.50
3" CV-1FR Riser Check Valve	59-590-1-030	\$504.50
4" CV-1FR Riser Check Valve	59-590-1-040	\$504.50
6" CV-1FR Riser Check Valve	59-590-1-060	\$937.50
8" CV-1FR Riser Check Valve	59-590-1-080	\$1,696.00

Coupling (Select One)

2" x 1½" Inch Figure 716 Reducing Coupling (for 1½" DV-5)	7162015ES	See Section 18 for current list prices
2" Figure 772 Rigid Coupling	77220ASC	
3" Figure 772 Rigid Coupling	77230ASC	
4" Figure 772 Rigid Coupling	77240ASC	
6" Figure 772 Rigid Coupling	77260ASC	
8" Figure 772 Rigid Coupling	77280ASC	

Single Interlock Dry Pilot Praction Trim (Select One) *Galvanized shown is standard

1½" & 2" Galvanized	52-478-2-118	\$4,282.00
3" Galvanized	52-478-2-115	\$4,401.00
4", 6" and 8" Galvanized	52-478-2-112	\$4,636.00

Automatic System Air Supply (Select One)

Model AMD-1 Air Maintenance Device (TFP 1221)	52-324-2-002	\$764.00
Model AMD-3 Nitrogen Air Maintenance Device (TFP 1241)	52-328-2-001	\$1,497.00
Model G16AC812 Supervisory Air Supply (TD126)	52-150-1-001	\$2,252.00

Dry Pilot Line Air Supply (Select One) *Must be ordered separately from Automatic System Air Supply

Model AMD-1 Air Maintenance Device (TFP 1221)	52-324-2-002	\$764.00
Model AMD-2 Air Maintenance Device (TFP 1231)	52-326-2-001	\$1,128.00
Model AMD-3 Nitrogen Air Maintenance Device (TFP 1241)	52-328-2-001	\$1,497.00

Optional Equipment for S/I Praction System, Dry Pilot Release

600 psi Water Pressure Gauge	92-343-1-004	\$158.50
Model WMA-1 Water Motor Alarm	52-630-1-001	\$608.50
Model OSYSU - 2 Monitor Switch	2412	\$162.00
Model MC-1 Manual Control Station (Galv. Ends) (TFP 1382)	52-289-2-001	\$391.00

Note

Note: Heat Detectors, Alarm Bells, Trouble Horns, Spray Nozzles, or, Open Sprinklers are ordered separately.

Technical Data Sheet - TFP1415

See latest Technical Data Sheets for specific Approvals, Listings, Design Parameters & available finishes on www.tyco-fire.com.

Full Preaction Systems and Components

The following tables will provide information on equipment, required or optional, needed to complete various system packages. Please see the applicable Technical data pages for more information.

DV-5 Single Interlock, Electric Actuation, - 1½" thru 8"		
<i>Description</i>	<i>Part No.</i>	<i>List Price</i>
Required Equipment for Deluge Valve (Select One) *P/N for GRXGR shown. See data sheets for other end configurations		
1½" DV-5 Deluge Valve, Grooved x Grooved	52-477-1-919	\$1,729.00
2" DV-5 Deluge Valve, Grooved x Grooved	52-477-1-910	\$1,807.00
3" DV-5 Deluge Valve, Grooved x Grooved	52-477-1-912	\$1,964.00
4" DV-5 Deluge Valve, Grooved x Grooved	52-477-1-913	\$3,383.00
6" DV-5 Deluge Valve, Grooved x Grooved	52-477-1-915	\$4,125.00
8" DV-5 Deluge Valve, Grooved x Grooved	52-477-1-916	\$11,805.00
Riser Check Valve (Select One) *For 1½" DV-5, use 2" Riser Check		
2" Model F517 Riser Check Valve	52-517-1-020	\$504.50
3" CV-1FR Riser Check Valve	59-590-1-030	\$504.50
4" CV-1FR Riser Check Valve	59-590-1-040	\$504.50
6" CV-1FR Riser Check Valve	59-590-1-060	\$937.50
8" CV-1FR Riser Check Valve	59-590-1-080	\$1,696.00
Coupling (Select One)		
2" x 1½" Figure 716 Reducing Coupling (for 1½" DV-5)	7162015ES	See Section 18 for current list prices
2" Figure 772 Rigid Coupling	77220ASC	
3" Figure 772 Rigid Coupling	77230ASC	
4" Figure 772 Rigid Coupling	77240ASC	
6" Figure 772 Rigid Coupling	77260ASC	
8" Figure 772 Rigid Coupling	77280ASC	
Single Interlock Electric Actuation Preaction Trim (Select One) *Galvanized shown is standard		
1½" & 2" Galvanized	52-478-2-119	\$3,340.00
3" Galvanized	52-478-2-116	\$3,457.00
4" , 6" and 8" Galvanized	52-478-2-113	\$3,693.00
Automatic System Air Supply (Select One)		
Model AMD-1 Air Maintenance Device (TFP 1221)	52-324-2-002	\$764.00
Model AMD-3 Nitrogen Air Maintenance Device (TFP 1241)	52-328-2-001	\$1,497.00
Model G16AC812 Supervisory Air Supply (TD126)	52-150-1-001	\$2,252.00
Solenoid Valve 24VDC (Select One)		
175 psi 24VDC Solenoid Valve	52-287-1-024	\$862.50
250 psi 24VDC Solenoid Valve	52-287-1-124	POA
Optional Equipment for S/I Preaction System, Electric Actuation		
600 psi Water Pressure Gauge	92-343-1-004	\$158.50
Model WMA-1 Water Motor Alarm	52-630-1-001	\$608.50
Model OSYSU - 2 Monitor Switch	2412	\$162.00
Model PFC 4410 Fire Control Panel	20125	\$2,092.00
Batteries - Two Batteries are required for Stand-by power for each Control Panel. Refer to TD sheets.		
Model BT - 80 Stand by Batteries, (2 Required, Price shown is Each)	2656	\$58.75
Model BT - 120 Stand by Batteries, (2 Required, Price shown is Each)	20128	\$110.50
Note		
Note: Heat Detectors, Manual Control Stations, Alarm Bells, Trouble Horns, Spray Nozzles, or, Open Sprinklers are ordered separately.		
Technical Data Sheet - TFP1420		

Section 8
Wet System Valves

Section 9
Water Motor Alarms

Section 10
Dry Pipe Valves

Section 11
Quick Opening Devices

Section 12
Air Maintenance Devices

Section 13
Deluge Valves & Accessories

Section 14
Preaction Systems

Section 15
General Purpose Valves

See latest Technical Data Sheets for specific Approvals, Listings, Design Parameters & available finishes on www.tyco-fire.com.

Full Preaction Systems and Components

The following tables will provide information on equipment, required or optional, needed to complete various system packages. Please see the applicable Technical data pages for more information.

DV-5 Double Interlock, Electric/Pneumatic Actuation, - 1½" thru 8"

Description	Part No.	List Price
-------------	----------	------------

Deluge Valve (Select One) *P/N for GRXGR shown. See data sheets for other end configurations

1-½ Inch DV-5 Deluge Valve, Grooved x Grooved	52-477-1-919	\$1,729.00
2 Inch DV-5 Deluge Valve, Grooved x Grooved	52-477-1-910	\$1,807.00
3 Inch DV-5 Deluge Valve, Grooved x Grooved	52-477-1-912	\$1,964.00
4 Inch DV-5 Deluge Valve, Grooved x Grooved	52-477-1-913	\$3,383.00
6 Inch DV-5 Deluge Valve, Grooved x Grooved	52-477-1-915	\$4,125.00
8" DV-5 Deluge Valve, Grooved x Grooved	52-477-1-916	\$11,805.00

Riser Check Valve (Select One) *For 1½" DV-5, use 2" Riser Check

2 Inch Model F517 Riser Check Valve	52-517-1-020	\$504.50
3" CV-1FR Riser Check Valve	59-590-1-030	\$504.50
4" CV-1FR Riser Check Valve	59-590-1-040	\$504.50
6" CV-1FR Riser Check Valve	59-590-1-060	\$937.50
8" CV-1FR Riser Check Valve	59-590-1-080	\$1,696.00

Coupling (Select One)

2" x 1½" Figure 716 Reducing Coupling (for 1½" DV-5)	7162015ES	See Section 18 for current list prices
2" Figure 772 Rigid Coupling	77220ASC	
3" Figure 772 Rigid Coupling	77230ASC	
4" Figure 772 Rigid Coupling	77240ASC	
6" Figure 772 Rigid Coupling	77260ASC	
8" Figure 772 Rigid Coupling	77280ASC	

Double Interlock E/P Preaction Trim (Select One) *Galvanized shown is standard

1½" & 2" Galvanized	52-478-2-127	\$4,335.00
3" Galvanized	52-478-2-124	\$4,540.00
4", 6" and 8" Galvanized	52-478-2-121	\$4,743.00

Automatic System Air Supply (Select One)

Model AMD-1 Air Maintenance Device (TFP 1221)	52-324-2-002	\$764.00
Model AMD-2 Air Maintenance Device (TFP 1231)	52-326-2-001	\$1,128.00
Model AMD-3 Nitrogen Air Maintenance Device (TFP 1241)	52-328-2-001	\$1,497.00

Solenoid Valve 24VDC (Select One)

175 psi 24VDC Solenoid Valve	52-287-1-024	\$862.50
250 psi 24VDC Solenoid Valve	52-287-1-124	POA

Optional Equipment for D/I Preaction System, Electric/Pneumatic Release

600 psi Water Pressure Gauge	92-343-1-004	\$158.50
Model WMA-1 Water Motor Alarm	52-630-1-001	\$608.50
Model OSYSU - 2 Monitor Switch	2412	\$162.00
Model PFC 4410 Fire Control Panel	20125	\$2,092.00

Batteries - Two Batteries are required for Stand-by power for each Control Panel. Refer to TD sheets.

Model BT - 80 Stand by Batteries, (2 Required, Price shown is Each)	2656	\$58.75
Model BT - 120 Stand by Batteries, (2 Required, Price shown is Each)	20128	\$110.50

Note

Note: Heat Detectors, Manual Control Stations, Alarm Bells, Trouble Horns, Spray Nozzles, or, Open Sprinklers are ordered separately.

Technical Data Sheet - TFP1460

See latest Technical Data Sheets for specific Approvals, Listings, Design Parameters & available finishes on www.tyco-fire.com.

Full Preaction Systems and Components

The following tables will provide information on equipment, required or optional, needed to complete various system packages. Please see the applicable Technical data pages for more information.

DV-5 Double Interlock, Electric/Electric Actuation, - 1½" thru 8"		
<i>Description</i>	<i>Part No.</i>	<i>List Price</i>
Required Equipment for Deluge Valve (Select One) *P/N for GRXGR shown. See data sheets for other end configurations		
1-½ Inch DV-5 Deluge Valve, Grooved x Grooved	52-477-1-919	\$1,729.00
2 Inch DV-5 Deluge Valve, Grooved x Grooved	52-477-1-910	\$1,807.00
3 Inch DV-5 Deluge Valve, Grooved x Grooved	52-477-1-912	\$1,964.00
4 Inch DV-5 Deluge Valve, Grooved x Grooved	52-477-1-913	\$3,383.00
6 Inch DV-5 Deluge Valve, Grooved x Grooved	52-477-1-915	\$4,125.00
8" DV-5 Deluge Valve, Grooved x Grooved	52-477-1-916	\$11,805.00
Riser Check Valve (Select One) *For 1½" DV-5, use 2" Riser Check		
2 Inch Model F517 Riser Check Valve	52-517-1-020	\$504.50
3" CV-1FR Riser Check Valve	59-590-1-030	\$504.50
4" CV-1FR Riser Check Valve	59-590-1-040	\$504.50
6" CV-1FR Riser Check Valve	59-590-1-060	\$937.50
8" CV-1FR Riser Check Valve	59-590-1-080	\$1,696.00
Coupling (Select One)		
2" x 1½" Figure 716 Reducing Coupling (for 1½" DV-5)	7162015ES	See Section 18 for current list prices
2" Figure 772 Rigid Coupling	77220ASC	
3" Figure 772 Rigid Coupling	77230ASC	
4" Figure 772 Rigid Coupling	77240ASC	
6" Figure 772 Rigid Coupling	77260ASC	
8" Figure 772 Rigid Coupling	77280ASC	
Double Interlock E/E Preaction Trim (Select One) *Galvanized shown is standard		
1½" & 2" Galvanized	52-478-2-128	\$3,142.00
3" Galvanized	52-478-2-125	\$3,221.00
4", 6" and 8" Galvanized	52-478-2-122	\$3,457.00
Automatic System Air Supply (Select One)		
Model AMD-1 Air Maintenance Device (TFP 1221)	52-324-2-002	\$764.00
Model AMD-3 Nitrogen Air Maintenance Device (TFP 1241)	52-328-2-001	\$1,497.00
Solenoid Valve 24VDC (Select One)		
175 psi 24VDC Solenoid Valve	52-287-1-024	\$862.50
250 psi 24VDC Solenoid Valve	52-287-1-124	POA
Optional Equipment for D/I Preaction System, Electric/Electric Release		
600 psi Water Pressure Gauge	92-343-1-004	\$158.50
Model WMA-1 Water Motor Alarm	52-630-1-001	\$608.50
Model OSYSU - 2 Monitor Switch	2412	\$162.00
Model PFC 4410 Fire Control Panel	20125	\$2,092.00
Batteries - Two Batteries are required for Stand-by power for each Control Panel. Refer to TD sheets.		
Model BT - 80 Stand by Batteries, (2 Required, Price shown is Each)	2656	\$58.75
Model BT - 120 Stand by Batteries, (2 Required, Price shown is Each)	20128	\$110.50
Note		
Note: Heat Detectors, Manual Control Stations, Alarm Bells, Trouble Horns, Spray Nozzles, or, Open Sprinklers are ordered separately.		
Technical Data Sheet - TFP1465		

Section 8
Wet System Valves

Section 9
Water Motor Alarms

Section 10
Dry Pipe Valves

Section 11
Quick Opening Devices

Section 12
Air Maintenance Devices

Section 13
Deluge Valves & Accessories

Section 14
Preaction Systems

Section 15
General Purpose Valves

See latest Technical Data Sheets for specific Approvals, Listings, Design Parameters & available finishes on www.tyco-fire.com.

Optional Equipment for Single Interlock, Praction Systems, Supervised

<i>Description</i>	<i>Part No.</i>	<i>List Price (Each)</i>
Desiccant Dryer for Supervisory Pressure and Dry Pilot Actuation	52-114-1-001	\$1,085.00
Low Pressure Alarm Switch for Dry Pilot Actuation (PS402A)	2573	\$190.00
Pressure Alarm Switch Model PS10 - 2A	2571	\$190.00
Model WMA-1 Water Motor Alarm	52-630-1-001	\$608.50
Model OSYSU - 2 Monitor Switch	2412	\$162.00
Model PFC 4410 Fire Control Panel	20125	\$2,092.00
Batteries - Two Batteries are required for Stand-by power for each Control Panel. Consult TD Sheets for ratings		
<i>Description</i>	<i>Part No.</i>	<i>List Price (Each)</i>
Model BT-80 (8 amp) Stand by Batteries, (2 REQ'D)	2656	\$58.75
Model BT-120 (12 amp) Stand by Batteries, (2 REQ'D)	20128	\$110.50
Notes		
Heat Detectors, Manual Control Stations, Alarm Bells, Trouble Horns, Compressors, Spray Nozzles, or, Open Sprinklers are ordered separately.		

Section 8
Wet System Valves

Section 9
Water Motor Alarms

Section 10
Dry Pipe Valves

Section 11
Quick Opening Devices

Section 12
Air Maintenance Devices

Section 13
Deluge Valves & Accessories

Section 14
Praction Systems

Section 15
General Purpose Valves

See latest Technical Data Sheets for specific Approvals, Listings, Design Parameters & available finishes on www.tyco-fire.com.

Price Book - Section 14 Praction Systems

Praction Trim for Model DV-5			
Description	Part No.	List Price	
Praction Trim Kits for Model DV-5 Deluge Valves - 1-1/2" and 2"			Section 8 Wet System Valves
1 1/2" and 2" Supervised Single Interlock Praction Trim with Wet Pilot Actuation (Galvanized) (Standard Order)	52-478-2-117	\$3,260.00	
1 1/2" and 2" Supervised Single Interlock Praction Trim with Wet Pilot Actuation (Black)	52-478-1-117	\$3,260.00	
1 1/2" and 2" Supervised Single Interlock Praction Trim with Wet Pilot Actuation (Brass)		POA	Section 9 Water Motor Alarms
1 1/2" and 2" Supervised Single Interlock Praction Trim with Dry Pilot Actuation (Galvanized) (Standard Order)	52-478-2-118	\$4,282.00	
1 1/2" and 2" Supervised Single Interlock Praction Trim with Dry Pilot Actuation (Black)	52-478-1-118	\$4,282.00	
1 1/2" and 2" Supervised Single Interlock Praction Trim with Dry Pilot Actuation (Brass)		POA	Section 10 Dry Pipe Valves
1 1/2" and 2" Supervised Single Interlock Praction Trim with Electric Actuation (Galvanized) (Standard Order) (Solenoid Valve Not Included)	52-478-2-119	\$3,340.00	
1 1/2" and 2" Supervised Single Interlock Praction Trim with Electric Actuation (Black) (Solenoid Valve Not Included)	52-478-1-119	\$3,340.00	
1 1/2" and 2" Supervised Single Interlock Praction Trim with Electric Actuation (Brass) (Solenoid Valve Not Included)		POA	Section 11 Quick Opening Devices
1 1/2" and 2" Double Interlock Praction Trim with Electric/Pneumatic Release (Galvanized) (Standard Order)	52-478-2-127	\$4,335.00	
1 1/2" and 2" Double Interlock Praction Trim with Electric/Pneumatic Release (Black)	52-478-1-127	\$5,264.00	
1 1/2" and 2" Double Interlock Praction Trim with Electric/Pneumatic Release (Brass)		POA	Section 12 Air Maintenance Devices
1 1/2" and 2" Double Interlock Praction Trim with Electric/Electric Release (Galvanized) (Standard Order)	52-478-2-128	\$3,142.00	
1 1/2" and 2" Double Interlock Praction Trim with Electric/Electric Release (Black)	52-478-1-128	\$3,142.00	
1 1/2" and 2" Double Interlock Praction Trim with Electric/Electric Release (Brass)		POA	Section 13 Deluge Valves & Accessories
Trim Kits for Model DV-5 Deluge Valves - 3"			
3" Supervised Single Interlock Praction Trim with Wet Pilot Actuation (Galvanized) (Standard Order)	52-478-2-114	\$3,380.00	
3" Supervised Single Interlock Praction Trim with Wet Pilot Actuation (Black)	52-478-1-114	\$3,380.00	Section 14 Praction Systems
3" Supervised Single Interlock Praction Trim with Wet Pilot Actuation (Brass)		POA	
3" Supervised Single Interlock Praction Trim with Dry Pilot Actuation (Galvanized) (Standard Order)	52-478-2-115	\$4,401.00	
3" Supervised Single Interlock Praction Trim with Dry Pilot Actuation (Black)	52-478-1-115	\$4,401.00	Section 15 General Purpose Valves
3" Supervised Single Interlock Praction Trim with Dry Pilot Actuation (Brass)		POA	
3" Supervised Single Interlock Praction Trim with Electric Actuation (Galvanized) (Standard Order) (Solenoid Valve Not Included)	52-478-2-116	\$3,457.00	
3" Supervised Single Interlock Praction Trim with Electric Actuation (Black) (Solenoid Valve Not Included)	52-478-1-116	\$3,457.00	
3" Supervised Single Interlock Praction Trim with Electric Actuation (Brass) (Solenoid Valve Not Included)		POA	
3" Double Interlock Praction Trim with Electric/Pneumatic Release (Galvanized) (Standard Order)	52-478-2-124	\$4,540.00	
3" Double Interlock Praction Trim with Electric/Pneumatic Release (Black)	52-478-1-124	\$5,657.00	
3" Double Interlock Praction Trim with Electric/Pneumatic Release (Brass)		POA	
3" Double Interlock Praction Trim with Electric/Electric Release (Galvanized) (Standard Order)	52-478-2-125	\$3,221.00	
3" Double Interlock Praction Trim with Electric/Electric Release (Black)	52-478-1-125	\$3,221.00	
3" Double Interlock Praction Trim with Electric/Electric Release (Brass)		POA	

See latest Technical Data Sheets for specific Approvals, Listings, Design Parameters & available finishes on www.tyco-fire.com.

Praction Trim for Model DV-5			
Trim Kits for Model DV-5 Deluge Valves - 4", 6" and 8"			
	<i>Description</i>	<i>Part No.</i>	<i>List Price</i>
Section 8 Wet System Valves	4", 6" and 8" Supervised Single Interlock Praction Trim with Wet Pilot Actuation (Galvanized) (Standard Order)	52-478-2-111	\$3,614.00
	4", 6" and 8" Supervised Single Interlock Praction Trim with Wet Pilot Actuation (Black)	52-478-1-111	\$3,614.00
	4" and 6" Supervised Single Interlock Praction Trim with Wet Pilot Actuation (Brass)		POA
Section 9 Water Motor Alarms	4", 6" and 8" Supervised Single Interlock Praction Trim with Dry Pilot Actuation (Galvanized) (Standard Order)	52-478-2-112	\$4,636.00
	4", 6" and 8" Supervised Single Interlock Praction Trim with Dry Pilot Actuation (Black)	52-478-1-112	\$4,636.00
	4", 6" and 8" Supervised Single Interlock Praction Trim with Dry Pilot Actuation (Brass)		POA
Section 10 Dry Pipe Valves	4", 6" and 8" Supervised Single Interlock Praction Trim with Electric Actuation (Galvanized) (Standard Order) (Solenoid Valve Not Included)	52-478-2-113	\$3,693.00
	4", 6" and 8" Supervised Single Interlock Praction Trim with Electric Actuation (Black) (Solenoid Valve Not Included)	52-478-1-113	\$3,693.00
	4", 6" and 8" Supervised Single Interlock Praction Trim with Electric Actuation (Brass) (Solenoid Valve Not Included)		POA
Section 11 Quick Opening Devices	4", 6" and 8" Double Interlock Praction Trim with Electric/Pneumatic Release (Galvanized) (Standard Order)	52-478-2-121	\$4,743.00
	4", 6" and 8" Double Interlock Praction Trim with Electric/Pneumatic Release (Black)	52-478-1-121	\$5,893.00
	4", 6" and 8" Double Interlock Praction Trim with Electric/Pneumatic Release (Brass)		POA
Section 12 Air Maintenance Devices	4", 6" and 8" Double Interlock Praction Trim with Electric/Electric Release (Galvanized) (Standard Order)	52-478-2-122	\$3,457.00
	4", 6" and 8" Double Interlock Praction Trim with Electric/Electric Release (Black)	52-478-1-122	\$3,457.00
	4", 6" and 8" Double Interlock Praction Trim with Electric/Electric Release (Brass)		POA
Technical Data Sheets: Single Interlock: Wet Pilot - TFP1410, Dry Pilot - TFP1415, Electric Actuation - TFP1420 Double Interlock: Electric/Pneumatic - TFP1460, Electric/Electric - TFP1465			
Section 13 Deluge Valves & Accessories			
Section 14 Praction Systems			
Section 15 General Purpose Valves			

See latest Technical Data Sheets for specific Approvals, Listings, Design Parameters & available finishes on www.tyco-fire.com.

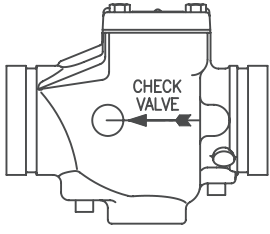
CV-1F Grooved Check Valve				
	<i>Part Numbers</i>	<i>Description</i>	<i>Price</i>	
	CV-1F			
	59-590-0-020	2" Grooved Check Valve	\$340.50	
	59-590-0-025	2½" Grooved Check Valve	\$340.50	
	59-590-0-030	3" Grooved Check Valve	\$340.50	
	59-590-0-040	4" Grooved Check Valve	\$340.50	
	59-590-0-050	5" Grooved Check Valve	\$704.00	
	59-590-0-060	6" Grooved Check Valve	\$816.00	
	59-590-0-080	8" Grooved Check Valve	\$1,645.00	
	59-590-0-100	10" Grooved Check Valve	\$1,791.00	
	Replacement Parts for Model CV-1F Check Valve, 2½" Grooved End			
	59-592-1-025	Maintenance Kit Includes: Cap, Gasket, Bolts, Warning Label and "Out of Service" Tag	\$617.00	
	59025EPDME	Clapper Gasket	\$107.00	
	Replacement Parts for Model CV-1F Check Valve, 3" Grooved End			
	59-592-1-030	Maintenance Kit Includes: Cap, Gasket, Bolts, Warning Label and "Out of Service" Tag	\$617.00	
	59030EPDME	Clapper Gasket	\$107.00	
	Replacement Parts for Model CV-1F Check Valve, 4" Grooved End			
	59-592-1-040	Maintenance Kit Includes: Cap, Gasket, Bolts, Warning Label and "Out of Service" Tag	\$617.00	
	59040EPDME	Clapper Gasket	\$85.25	
	Replacement Parts for Model CV-1F Check Valve, 5" Grooved End			
	59-592-1-050	Maintenance Kit Includes: Cap, Gasket, Bolts, Warning Label and "Out of Service" Tag	\$617.00	
	59050EPDME	Clapper Gasket	\$107.00	
Replacement Parts for Model CV-1F Check Valve, 6" Grooved End				
59-592-1-060	Maintenance Kit Includes: Cap, Gasket, Bolts, Warning Label and "Out of Service" Tag	\$617.00		
59060EPDME	Clapper Gasket	\$107.00		
Replacement Parts for Model CV-1F Check Valve, 8" Grooved End				
59-592-1-080	Maintenance Kit Includes: Cap, Gasket, Bolts, Warning Label and "Out of Service" Tag	\$617.00		
59080EPDME	Clapper Gasket	\$107.00		
Replacement Parts for Model CV-1F Check Valve, 10" Grooved End				
59-592-1-100	Maintenance Kit Includes: Cap, Gasket, Bolts, Warning Label and "Out of Service" Tag	\$617.00		
59100EPDME	Clapper Gasket	\$107.00		
Technical Data Sheet: Check Valve TFP1550 and Maintenance Kit TFP1555				

Section 8 Wet System Valves
 Section 9 Water/Motor Alarms
 Section 10 Dry Pipe Valves
 Section 11 Quick Opening Devices
 Section 12 Air Maintenance Devices
 Section 13 Deluge Valves & Accessories
 Section 14 Preaction Systems
 Section 15 General Purpose Valves

See latest Technical Data Sheets for specific Approvals, Listings, Design Parameters & available finishes on www.tyco-fire.com.

**Model BFV-N Butterfly Valves - Wafer Style
w/ Supervisory Switches - 250 psi
UL and C-UL Listed and FM Approved**

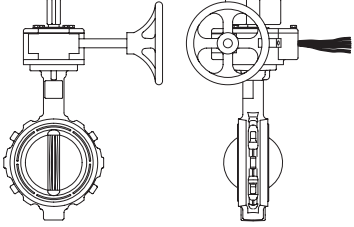
		<i>Nom. Size</i>	<i>Part Numbers</i>	<i>List Price</i>
		2" Model BFV-N Butterfly Valve - Wafer Style	59-801-1-020N	\$635.00
		2½" Model BFV-N Butterfly Valve - Wafer Style	59-801-1-025N	\$670.50
		3" Model BFV-N Butterfly Valve - Wafer Style	59-801-1-030N	\$750.50
		4" Model BFV-N Butterfly Valve - Wafer Style	59-801-1-040N	\$777.00
		5" Model BFV-N Butterfly Valve - Wafer Style	59-801-1-050N	\$1,006.00
		6" Model BFV-N Butterfly Valve - Wafer Style	59-801-1-060N	\$1,006.00
		8" Model BFV-N Butterfly Valve - Wafer Style	59-801-1-080N	\$1,490.00
		10" Model BFV-N Butterfly Valve - Wafer Style	59-801-1-100N	\$2,036.00
	12" Model BFV-N Butterfly Valve - Wafer Style	59-801-1-120N	\$2,473.00	
Technical Data Sheet - TFP1515				

**Model BFV-N Butterfly Valves - Lug Style
w/ Supervisory Switches - 250 psi
UL and C-UL Listed and FM Approved**

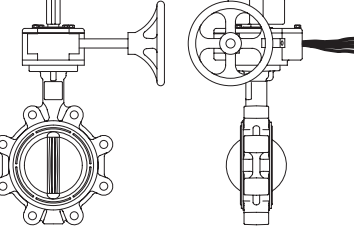
		<i>Nom. Size</i>	<i>Part Numbers</i>	<i>List Price</i>
		2" Model BFV-N Butterfly Valve - Lug Style	59-802-1-020N	\$731.50
		2½" Model BFV-N Butterfly Valve - Lug Style	59-802-1-025N	\$772.00
		3" Model BFV-N Butterfly Valve - Lug Style	59-802-1-030N	\$793.00
		4" Model BFV-N Butterfly Valve - Lug Style	59-802-1-040N	\$850.50
		5" Model BFV-N Butterfly Valve - Lug Style	59-802-1-050N	\$1,111.00
		6" Model BFV-N Butterfly Valve - Lug Style	59-802-1-060N	\$1,111.00
		8" Model BFV-N Butterfly Valve - Lug Style	59-802-1-080N	\$1,607.00
		10" Model BFV-N Butterfly Valve - Lug Style	59-802-1-100N	\$2,076.00
	12" Model BFV-N Butterfly Valve - Lug Style	59-802-1-120N	\$3,316.00	
Technical Data Sheet - TFP1520				

Additional Wafer and Lug Lengths, w/PIVA

Wafer 12" thru 36" Length, w/PIVA		Lug 12" thru 36" Length, w/PIVA	
<i>Nom. Size</i>	<i>List Price</i>	<i>Nom. Size</i>	<i>List Price</i>
2"	\$2,151.00	2"	\$2,236.00
2½"	\$2,181.00	2½"	\$2,274.00
3"	\$2,266.00	3"	\$2,312.00
4"	\$2,294.00	4"	\$2,450.00
5"	\$2,527.00	5"	\$2,711.00
6"	\$2,527.00	6"	\$2,711.00
8"	\$3,214.00	8"	\$3,427.00
10"	\$3,723.00	10"	\$3,975.00
12"	\$4,443.00	12"	\$4,870.00

Notes

Wafer and Lug Lengths add \$150.00 per foot increase in length after 36"

See latest Technical Data Sheets for specific Approvals, Listings, Design Parameters & available finishes on www.tyco-fire.com.

**Model BFV-N Butterfly Valves - G x G, Gear Operated
w/ Tamper Switches-300psi
UL and C-UL Listed and FM Approved**

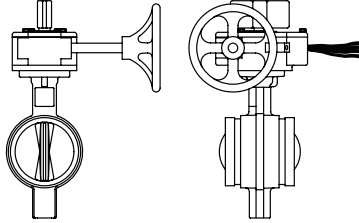
	<i>Nom. Size</i>	<i>Part Numbers</i>	<i>List Price</i>
	2" Butterfly Valve	Refer to page C-2 for 2" Valve Part Number and Pricing Information	
	2½" Model BFV-N Butterfly Valve	59-300-F-025N	\$607.00
	3" Model BFV-N Butterfly Valve	59-300-F-030N	\$653.00
	4" Model BFV-N Butterfly Valve	59-300-F-040N	\$683.00
	5" Model BFV-N Butterfly Valve	59-300-F-050N	\$1,466.00
	6" Model BFV-N Butterfly Valve	59-300-F-060N	\$909.50
	8" Model BFV-N Butterfly Valve	59-300-F-080N	\$1,469.00
	10" Model BFV-N Butterfly Valve	59-300-F-100N	\$2,201.00
Technical Data Sheet - TFP1510			

**Model PRV-1 Pressure Regulating Valve
2" thru 8", 250 psi, Pilot Operated**

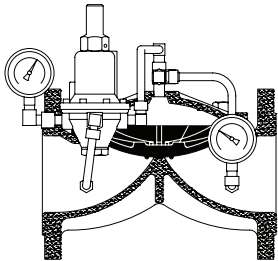
	<i>Nom. Size</i>	<i>UL & FM Part Numbers</i>	<i>List Price</i>
	2" Model PRV-1 Pressure Regulating Valve, Groove x Groove	52-570-8-920	\$1,438.00
	2" Model PRV-1 Pressure Regulating Valve, Thread x Thread	52-570-8-060	\$1,438.00
	3" Model PRV-1 Pressure Regulating Valve, Groove x Groove	52-570-8-922	\$2,225.00
	4" Model PRV-1 Pressure Regulating Valve, Groove x Groove	52-570-8-923	\$2,678.00
	4" Model PRV-1 Pressure Regulating Valve, Flange x Flange	52-570-8-023	\$2,678.00
	6" Model PRV-1 Pressure Regulating Valve, Groove x Groove	52-570-8-925	\$4,885.00
	6" Model PRV-1 Pressure Regulating Valve, Flange x Flange	52-570-8-025	\$4,885.00
	8" Model PRV-1 Pressure Regulating Valve, Flange x Flange	52-570-8-026	\$7,460.00
Technical Data Sheet - TFP1580			

Section 8 Wet System Valves
 Section 9 Water Motor Alarms
 Section 10 Dry Pipe Valves
 Section 11 Quick Opening Devices
 Section 12 Air Maintenance Devices
 Section 13 Deluge Valves & Accessories
 Section 14 Preaction Systems
 Section 15 General Purpose Valves

See latest Technical Data Sheets for specific Approvals, Listings, Design Parameters & available finishes on www.tyco-fire.com.

Section 8
Wet System Valves

Section 9
Water Motor Alarms

Section 10
Dry Pipe Valves

Section 11
Quick Opening Devices

Section 12
Air Maintenance Devices

Section 13
Deluge Valves & Accessories

Section 14
Preaction Systems

Section 15
General Purpose Valves

See latest Technical Data Sheets for specific Approvals, Listings, Design Parameters & available finishes on www.tyco-fire.com.

Supersedes 3/18/2008

Valve System Accessories		
<i>Description</i>	<i>Part No.</i>	<i>List Price</i>
1/2" Pressure Relief Valve	2283	\$152.00
1/4" Pressure Relief Valve - NFPA 135-1.3	2338	\$118.50
1/4" Air Pressure Regulator (Norgen)	12525000	\$219.00
1/4" Air Restrictor	2370	\$22.25
3/8" Furnas Pressure Switch	2433	\$399.00

Section 16
Specialty Items

Section 18
Grooved Product

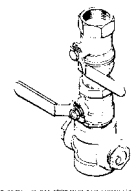
F350 Sectional Control Accessories			
	<i>Description</i>	<i>Part No.</i>	<i>List Price</i>
	1 1/4" Drain x 1/2" Test Orifice	54-350-1-001	\$538.50
	Technical Data Sheet - TFP1650		

Section 19
CPVC Pipe & Fittings

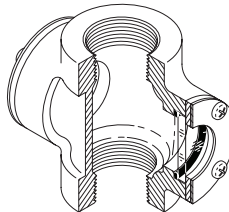
F1321 Sight Flow Connection			
	<i>Description</i>	<i>Part No.</i>	<i>List Price</i>
	1" F1321 Sight Flow Connection	52-069-1-006	\$104.50
	2" F1321 Sight Flow Connection	52-069-1-009	\$281.50
	Technical Data Sheet - TFP1635		

Section 20
Miscellaneous

Section 21
Electrical

Ball Drip Valves		
<i>Description</i>	<i>Part Number</i>	<i>List Price</i>
1/2" Ball Drip w/street ell	2282	\$41.25
1/2" AD-2 Automatic Drain Ball Drip (for FDC & Low Point Drains)	52-789-1-004	\$63.25
1/2" AD-1 Plunger Type, Automatic Drain Ball Drip	52-793-2-004	\$128.50
Technical Data Sheet - AD-1 TFP1630 & AD-2 TFP1632		

Fill or Drip Cups		
<i>Description</i>	<i>Part No.</i>	<i>List Price</i>
1/2" N.P.T.	2360	\$69.50
3/4" N.P.T.	2361	\$69.50

DD-1 (Drum Drip) Wiliag Drain		
<i>Description</i>	<i>Part No.</i>	<i>List Price</i>
DD-1 (Drum Drip) Wiliag Drain Includes: Condensation Barrel, 2- 1" Shutoff Valves & 1-1" Plug	52-380-1-001	\$159.50

See latest Technical Data Sheets for specific Approvals, Listings, Design Parameters & available finishes on www.tyco-fire.com.

Section 16
Specialty Items

Section 18
Grooved Product

Section 19
CPVC Pipe & Fittings

Section 20
Miscellaneous

Section 21
Electrical

Manual Control Stations

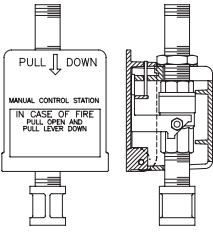
		<i>Description</i>	<i>Part No.</i>	<i>List Price</i>
		Hydraulic Break-Rod Station, Model MC-1	52-289-1-001	\$391.00
		Replacement Rod 1/8" x 1-3/16" Polystyrene	92-289-1-008	\$12.00
Technical Data Sheet - TFP1382				

Model G16AC812 Automatic Supervisory Air Supply

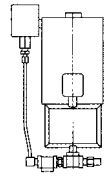
		<i>Description</i>	<i>Part No.</i>	<i>List Price</i>
		Automatic Air Supply Model G16AC812	52-150-1-001	\$2,252.00
		Universal Bracket Riser Mount	52-150-1-000	\$261.50
Technical Data Sheet - TFP1620				

Water and Air Gauges

<i>Description</i>	<i>Part No.</i>	<i>List Price</i>
Water Pressure Gauge.	92-343-1-005	\$69.50
Air Pressure Gauge.	92-343-1-012	\$69.50

Fusible Links/Fire Door Links, Type C

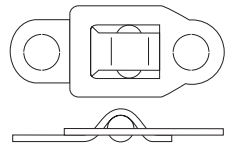
		<i>Description</i>	<i>Part Number</i>	<i>List Price</i>
		Fusible Link, Figure 1247B 135°F (57°C), Type C	56-125-9-135	\$17.25
		Fusible Link, Figure 1247B 165°F (74°C), Type C	56-125-9-165	\$17.25
		Fusible Link, Figure 1247B 212°F (100°C), Type C	56-125-9-212	\$17.25
		Fusible Link, Figure 1247B 286°F (141°C), Type C	56-125-9-286	\$17.25
		Fusible Link, Figure 1247B 360°F (182°C), Type C	56-125-9-360	\$18.50
		Fusible Link, Figure 1247B 500°F (260°C), Type C	56-125-9-500	\$23.75
Technical Data Sheet - TFP1610				

See latest Technical Data Sheets for specific Approvals, Listings, Design Parameters & available finishes on www.tyco-fire.com.

Price Book - Section 16 Specialty Items

Zonecheck - Flow Switch Tester			
	<i>Description</i>	<i>Part Number</i>	<i>List Price</i>
 <p>Note: For Left Hand Option, Please add a "-L" to the part number and add \$175 to the price. (example 4320-L)</p>	2" Zonecheck Flow Tester	4320	\$3,337.00
	2½" Zonecheck Flow Tester	4325	\$3,337.00
	3" Zonecheck Flow Tester	4330	\$3,337.00
	4" Zonecheck Flow Tester	4340	\$3,337.00
	6" Zonecheck Flow Tester	4360	\$3,337.00
	Retrofit Zonecheck Assembly	43RT	\$2,944.00
	2" Zonecheck Flow Tester - ULC	43200	\$3,337.00
	2½" Zonecheck Flow Tester - ULC	43250	\$3,337.00
	3" Zonecheck Flow Tester - ULC	43300	\$3,337.00
	4" Zonecheck Flow Tester - ULC	43400	\$3,337.00
	Retrofit Zonecheck Assembly - ULC	43RTC	\$2,944.00
	Zonecheck Keyswitch	43100 ZCK-1	\$203.50

Model "A" Strainers and SS Baskets		
<i>Description</i>	<i>Part No.</i>	<i>List Price</i>
3" Model "A" Strainer, Fig. 1260, Galvanized Finish and SS Baskets	52-270-1-011	\$8,234.00
4" Model "A" Strainer, Fig. 1260, Galvanized Finish and SS Baskets	52-270-1-013	\$9,999.00
6" Model "A" Strainer, Fig. 1260, Galvanized Finish and SS Baskets	52-270-1-015	\$16,499.00
8" Model "A" Strainer, Fig. 1260, Galvanized Finish and SS Baskets	52-270-1-016	\$21,613.00
10" Model "A" Strainer, Fig. 1260, Galvanized Finish and SS Baskets	52-270-1-017	\$33,452.00
Replacement Parts for Model "A" Strainers		
8" End Flange 19" Model A, Strainer	92-270-1-024	\$4,362.00
End Flange 10" Model A, Strainer	92-270-1-046	\$4,948.00
Stainless Steel Basket 4"	92-270-1-213	\$5,516.00
Stainless Steel Basket 6"	92-270-1-215	\$6,277.00
Stainless Steel Basket 8"	92-270-1-216	\$10,975.00
Stainless Steel Basket 10"	92-270-1-217	\$12,590.00
Notes		
All Model "A" Strainers are special order and require 10 weeks for delivery.		
Technical Data Sheet - TFP1640		

Model "B-1" Strainer, Painted Finish and SS Baskets

	<i>Description</i>	<i>Part No.</i>	<i>List Price</i>
Section 16 Specialty Items	3" No. 1	52-370-1-010	\$5,199.00
	3" No. 2*, No. 3	52-370-1-011	\$5,115.00
	3" Galvanized Finish and SS Baskets	-	POA
Section 18 Grooved Product	4" No. 6*	52-370-1-013	\$6,353.00
	4" No. 5, No. 7	52-370-1-014	\$6,600.00
	4" Galvanized Finish and SS Baskets		\$8,294.00
Section 19 CPVC Pipe & Fittings	6" No. 9*	52-370-1-015	\$9,736.00
	6" No. 8	52-370-1-019	\$10,643.00
	6" Galvanized Finish and SS Baskets	-	POA
	8" No. 14, No. 15, No. 19*, No. 20	52-370-1-016	\$16,993.00
	8" No. 16	52-370-1-017	\$17,886.00
Section 20 Miscellaneous	8" Galvanized Finish and SS Baskets	-	POA
	Replacement Parts for Model B-1, Strainer		
	3" Basket Assembly	92-370-1-102	\$1,721.00
	4" Basket Assembly	92-370-1-104	\$2,051.00
	6" Basket Assembly	92-370-1-106	\$3,596.00
	8" Basket Assembly	92-370-1-108	\$4,965.00
	8" End Flange Plain	92-370-1-007	\$3,596.00
	8" End Flange Galvanized	92-370-2-007	\$6,145.00
	6" End Flange Plain	92-370-1-005	\$3,239.00
	6" End Flange Galvanized	92-370-2-005	\$4,422.00
Section 21 Electrical	3" Ring Gasket	92-370-1-015	\$11.75
	4" Ring Gasket	92-370-1-016	\$17.75
	6" & 8" Ring Gasket	92-370-1-018	\$17.75
Notes			
* These Model "B1" Strainers are available from stock. All other "B1" Strainers require 5 weeks for delivery.			
1 - Model "B1" Galvanized Strainers are special order and required 10 weeks for delivery.			
2 - All extra heavy strainers both Model "A" and "B" are discontinued.			
3 - All strainers with monel or bronze baskets are special order and require 8 weeks for delivery P.O.A.			
Technical Data Sheet - TFP1642			

Model "C" Strainer, Heavy Duty, Welded Body		
<i>Description</i>	<i>Part No.</i>	<i>List Price</i>
6 x 6" Model "C" Strainer, Galvanized Finish and Stainless Steel Baskets	52-390-1-013	\$16,732.00
8" x 8" Model "C" Strainer, Galvanized Finish and Stainless Steel Baskets	52-390-1-016	\$21,878.00
8" with two 6" Outlets, Model "C" Strainer, Galvanized Finish and Stainless Steel Baskets	52-390-1-017	\$26,233.00
10" with two 8" Outlets, Model "C" Strainer, Galvanized Finish and Stainless Steel Baskets	52-390-1-019	\$33,876.00
Technical Data Sheet - TFP1644		

Sprinkler Identification Signs		
<i>Description</i>	<i>Part No.</i>	<i>List Price</i>
Sign A - General Purpose, 9" x 7"	2300A	\$7.10
Sign B "Alarm Test", 6" x 2"	2304A	\$3.60
Sign B "Auxiliary Drain", 6" x 2"	2307	\$3.60
Sign B "Control Valve", 6" x 2"	2310	\$3.60
Sign B "Inspectors Test", 6" x 2"	2313	\$3.60
Sign B "Main Control", 6" x 2"	2319	\$3.60
Sign B "Main Drain", 6" x 2"	2320	\$3.60
Sign B "Air Control", 6" x 2"	2328	\$3.60
Sign B "Air Line", 6" x 2"	2302	\$3.60
Sign B "Anti-Freeze System", 6" x 2"	2306	\$3.60
Sign B "Drain", 6" x 2"	2311	\$3.60
Sign B "Drain Valve", 6" x 2"	2327	\$3.60
Sign D "When Bell Rings", 9" x 7"	2329	\$8.50
Sign E - Hydraulic Calculations, 5" x 7"	2317	\$7.10
Technical Data Sheet - TFP1615		

Restriction Unions		
<i>Description</i>	<i>Part No.</i>	<i>List Price</i>
1/2" Brass Union 1/8" Orifice.	52-363-1-001	\$88.75
1/2" Brass Union 3/32" Orifice.	52-363-1-002	\$88.75
3/4" Brass Union K=5.6.	52-363-1-005	\$113.50
1" Brass Union K=5.6.	52-363-1-006	\$126.00
1" M.I. Union K=5.6.	52-363-1-106	\$72.50
1" Brass Union K=8.0.	52-363-1-256	\$126.00

See latest Technical Data Sheets for specific Approvals, Listings, Design Parameters & available finishes on www.tyco-fire.com.

Section 16
Specialty Items

Section 18
Grooved Product

Section 19
CPVC Pipe & Fittings

Section 20
Miscellaneous

Section 21
Electrical

See latest Technical Data Sheets for specific Approvals, Listings, Design Parameters & available finishes on www.tyco-fire.com.

Supersedes 3/18/2008

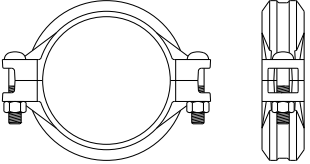
#772 Rigid Coupling					
w/Grade "A" EPDM Fire Protection Gasket Pre-Lubricated Gasket					
	<i>Nom. Size</i>	<i>Painted</i>		<i>Galvanized</i>	
		<i>Part Number</i>	<i>List Price</i>	<i>Part Number</i>	<i>List Price</i>
			1 1/4"	77213ASC	\$22.50
	1 1/2"	77215ASC	\$23.25	77215AGSC	\$31.50
	2"	77220ASC	\$25.25	77220AGSC	\$35.50
	2 1/2"	77225ASC	\$29.25	77225AGSC	\$41.00
	3" O.D.	77230AMSC	\$34.50	77230AMGSC	\$48.50
	3"	77230ASC	\$33.75	77230AGSC	\$48.50
	4"	77240ASC	\$45.00	77240AGSC	\$63.50
	5"	77250ESC	\$77.75	77250EGSC	\$109.50
	6"	77260ASC	\$77.75	77260AGSC	\$109.50
	6 1/2" O.D.	77260AMSC	\$79.25	77260AMGSC	\$109.50
	8"	77280ASC	\$129.25	77280AGSC	\$186.25
	10"	77210ESC	\$325.25	77210EGSC	\$414.75
	12"	77212ESC	\$398.75	77212EGSC	\$502.25
Technical Data Sheet: TFP1850					

Section 16
Specialty Items

Section 18
Grooved Product

Section 19
CPVC Pipe & Fittings

Section 20
Miscellaneous

Section 21
Electrical

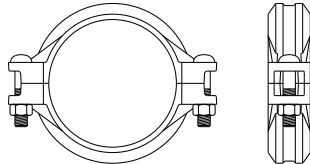
#772 Rigid Tri-Seal Coupling					
Recommended for dry pipe systems and freezer applications.					
Use Silicon Lubricant w/Grade "E" EPDM Tri-Seal Gasket					
	<i>Nom. Size</i>	<i>Painted</i>		<i>Galvanized</i>	
		<i>Part Number</i>	<i>List Price</i>	<i>Part Number</i>	<i>List Price</i>
			1 1/4"	77213E3S	\$29.25
	1 1/2"	77215E3S	\$29.25	77215E3GS	\$33.50
	2"	77220E3S	\$31.75	77220E3GS	\$37.75
	2 1/2"	77225E3S	\$37.25	77225E3GS	\$43.75
	3" OD	77230E3MS	\$39.00	77230E3GMS	\$43.75
	3"	77230E3S	\$41.00	77230E3GS	\$48.25
	4"	77240E3S	\$58.00	77240E3GS	\$67.00
	5"	77250E3S	\$107.25	77250E3GS	\$126.00
	6"	77260E3S	\$107.25	77260E3GS	\$126.00
	6 1/2" OD	77260E3MS	\$110.00	77260E3MGS	\$126.00
	8"	77280E3S	\$169.50	77280E3GS	\$197.00
	10"	77210E3S	\$340.00	77210E3GS	\$377.00
	12"	77212E3S	\$427.00	77212E3GS	\$486.75
Note:					
Items listed in shaded areas are non-cancelable and non-returnable					
Technical Data Sheet: TFP1850					

See latest Technical Data Sheets for specific Approvals, Listings, and Design Parameters. Prices subject to change without notice.

** Grooved Fittings are Full Flow manufactured from ASTM A536 Ductile Iron except those marked ** which are segmentally welded steel with roll-grooved ends..

#705 Flexible Coupling

w/Grade "A" EPDM Fire Protection Gasket Pre-Lubricated Gasket

Section 16
Specialty Items

Section 18
Grooved Product

Section 19
CPVC Pipe & Fittings

Section 20
Miscellaneous

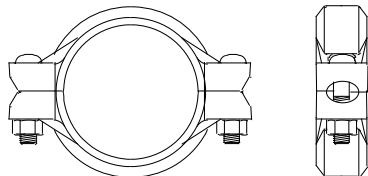

Nom. Size	Painted		Galvanized	
	Part Number	List Price	Part Number	List Price
1¼"	70513ASC	\$24.25	70513AGSC	\$34.25
1½"	70515ASC	\$24.25	70515AGSC	\$34.25
2"	70520ASC	\$27.00	70520AGSC	\$37.25
2½"	70525ASC	\$30.75	70525AGSC	\$43.00
3" O.D.	70530AMSC	\$37.75	70530AMGSC	\$51.00
3"	70530ASC	\$36.25	70530AGSC	\$51.00
4"	70540ASC	\$52.75	70540AGSC	\$74.50
5"	70550ESC	\$87.00	70550EGSC	\$122.50
6"	70560ASC	\$87.00	70560AGSC	\$122.50
6½" O.D.	70560AMSC	\$89.75	70560AMGSC	\$122.50
8"	70580ASC	\$143.75	70580AGSC	\$202.25
10"	70510ESC	\$331.00	70510EGSC	\$414.75
12"	70512ESC	\$398.75	70512EGSC	\$502.25

Note:

Items listed in shaded areas are non-cancelable and non-returnable

Technical Data Sheet: TFP1820

Section 21
Electrical

#705 Flexible Tri-Seal Coupling

**w/Grade "E" EPDM Tri-Seal Gasket recommended for
dry pipe systems and freezer applications Use Silicon Lubricant**

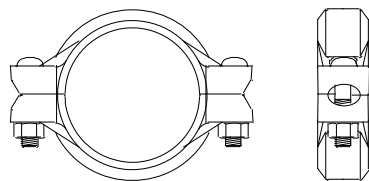

Nom. Size	Painted		Galvanized	
	Part Number	List Price	Part Number	List Price
1¼"	70513E3S	\$32.00	70513E3GS	\$36.00
1½"	70515E3S	\$32.00	70515E3GS	\$36.00
2"	70520E3S	\$33.75	70520E3GS	\$40.25
2½"	70525E3S	\$39.25	70525E3GS	\$45.50
3" O.D.	70530E3MS	\$41.25	70530E3MGS	\$45.50
3"	70530E3S	\$43.25	70530E3GS	\$50.50
4"	70540E3S	\$68.75	70540E3GS	\$78.75
5"	70550E3S	\$119.50	70550E3GS	\$138.50
6"	70560E3S	\$119.50	70560E3GS	\$138.50
6½" O.D.	70560E3MS	\$122.25	70560E3MGS	\$138.50
8"	70580E3S	\$184.00	70580E3GS	\$213.75
10"	70510E3S	\$364.50	70510E3GS	\$375.50
12"	70512E3S	\$427.00	70512E3GS	\$486.75

Note:

Items listed in shaded areas are non-cancelable and non-returnable

Technical Data Sheet: TFP1820

See latest Technical Data Sheets for specific Approvals, Listings, and Design Parameters. Prices subject to change without notice.

** Grooved Fittings are Full Flow manufactured from ASTM A536 Ductile Iron except those marked ** which are segmentally welded steel with roll-grooved ends..

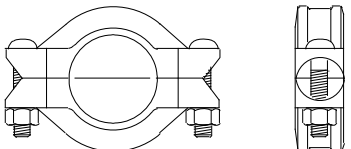
#716 Reducing Coupling w/Grade "E" EPDM Gasket Non-Lubricated					
	Nom. Size	Painted		Galvanized	
		Part Number	List Price	Part Number	List Price
			2" x 1½"	7162015ES	\$53.00
2½" x 2"	7162520ES		\$76.00	7162520EGS	\$105.50
3" x 2"	7163020ES		\$79.00	7163020EGS	\$130.50
3" x 2½"	7163025ES		\$79.00	7163025EGS	\$130.50
4" x 2"	7164020ES		\$102.50	7164020EGS	\$148.00
4" x 2½"	7164025ES		\$102.50	7164025EGS	\$148.00
4" x 3"	7164030ES		\$123.50	7164030EGS	\$179.25
5" x 4"	7165040ES		\$166.75	7165040EGS	\$240.75
6" x 4"	7166040ES		\$229.00	7166040EGS	\$299.00
6" x 5"	7166050ES		\$240.00	7166050EGS	\$332.75
8" x 6"	7168060ES		\$347.50	7168060EGS	\$501.00

Technical Data Sheet: TFP1830

#716 Reducing Coupling Plate		
Nom. Size	Plate Part No.	List Price
2" x 1½"	7162015W	\$32.00
2½" x 2"	7162520W	\$32.00
3" x 2"	7163020W	\$49.50
3" x 2½"	7163025W	\$49.50
4" x 2"	7164020W	\$52.50
4" x 2½"	7164025W	\$52.50
4" x 3"	7164030W	\$52.50
5" x 4"	7165040W	\$52.50
6" x 4"	7166040W	\$71.75
6" x 5"	7166050W	\$71.75
8" x 6"	7168060W	\$98.00

Section 16
Specialty Items
 Section 18
Grooved Product
 Section 19
CPVC Pipe & Fittings
 Section 20
Miscellaneous
 Section 21
Electrical

See latest Technical Data Sheets for specific Approvals, Listings, and Design Parameters. Prices subject to change without notice.

** Grooved Fittings are Full Flow manufactured from ASTM A536 Ductile Iron except those marked ** which are segmentally welded steel with roll-grooved ends..

**#71 Grooved Flange Adapter
with Grade "E" EPDM Gasket Non-Lubricated**

Section 16
Specialty Items

Section 18
Grooved Product

Section 19
CPVC Pipe & Fittings

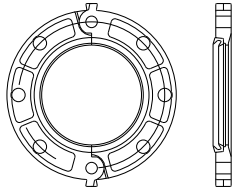

Nom. Size	Painted		Galvanized	
	Part Number	List Price	Part Number	List Price
2"	7120S	\$99.00	7120GS	\$114.25
2 1/2"	7125S	\$118.75	7125GS	\$137.25
3"	7130S	\$131.25	7130GS	\$157.25
4"	7140S	\$169.50	7140GS	\$207.25
5"	7150S	\$206.75	7150GS	\$248.50
6"	7160S	\$210.00	7160GS	\$275.75
8"	7180S	\$278.00	7180GS	\$350.50
10"	7110S	\$492.00	7110GS	\$711.50
12"	7112S	\$711.50	7112GS	\$1,023.00

Technical Data Sheet: TFP1880

Section 20
Miscellaneous

Section 21
Electrical

#71 Flange Adapter - Metal Washer

Nom. Size	Washer Part No.	List Price
2"	7120FWC	\$43.75
2 1/2"	7125FWC	\$53.00
3"	7130FWC	\$53.00
4"	7140FWC	\$64.25
5"	7150FWC	\$71.75
6"	7160FWC	\$83.00
8"	7180FWC	\$128.00
10"	7110FWC	\$165.50
12"	7112FWC	\$176.50

#71 Flange Adapter - Nut, Bolt and Gasket Kit

Nom. Size	NBG Kit	List Price
2"	50240	\$12.75
2 1/2"	50241	\$12.75
3"	50242	\$12.75
4"	50243	\$22.50
5"	50248	\$34.50
6"	50244	\$35.50
8"	50245	\$39.25
10"	50246	\$90.50
12"	50247	\$99.00

Replacement Gaskets

Nominal Size	Grade "A"-Pre-Lube Fire Protection Gasket (for #772, #705, #577)		Iri-Seal Grade "E" EPDM Gasket (for #772, #705)		Grade "E" EPDM Gasket (for #71)	
	Part No.	List Price	Part No.	List Price	Part No.	List Price
1 1/4"	13EPDMAC	\$18.25	13EPDME3	\$21.75	—	—
1 1/2"	15EPDMAC	\$18.25	15EPDME3	\$22.00	—	—
2"	20EPDMAC	\$18.25	20EPDME3	\$22.25	7120EPDME	\$33.00
2 1/2"	25EPDMAC	\$23.75	25EPDME3	\$27.25	7125EPDME	\$38.25
3" O.D.	30MEPDMAC	\$24.75	30MEPDME3	\$28.00	—	—
3"	30EPDMAC	\$24.75	30EPDME3	\$31.25	7130EPDME	\$41.25
4"	40EPDMAC	\$32.00	40EPDME3	\$38.25	7140EPDME	\$48.75
5"	50EPDMEC	\$49.00	50EPDME3	\$51.75	7150EPDME	\$57.75
6"	60EPDMAC	\$45.50	60EPDME3	\$57.25	7160EPDME	\$67.50
6 1/2" O.D.	60MEPDMAC	\$47.75	60MEPDME3	\$58.00	—	—
8"	80EPDMAC	\$63.75	80EPDME3	\$75.25	7180EPDME	\$86.25
10"	10EPDMEC	\$111.50	10EPDME3	\$123.00	7110EPDME	\$104.50
12"	12EPDMEC	\$116.25	12EPDME3	\$128.00	7112EPDME	\$123.25

Technical Data Sheet: TFP1895

See latest Technical Data Sheets for specific Approvals, Listings, and Design Parameters. Prices subject to change without notice.

** Grooved Fittings are Full Flow manufactured from ASTM A536 Ductile Iron except those marked ** which are segmentally welded steel with roll-grooved ends..

Price Book - Section 18 Grinnell Grooved Products

Coupling Nuts and Bolts					
<i>Nom. Size</i>	<i>Hex Nut</i>	<i>List Price</i>	<i>Nom. Size</i>	<i>Trak Bolt</i>	<i>List Price</i>
3/8"	NT38S	\$2.00	3/8" x 2 1/4"	BT38214S	\$4.00
1/2"	NT15S	\$2.75	1/2" x 3	BT1530S	\$6.50
5/8"	NT58S	\$3.00	5/8" x 3 1/4"	BT58314S	\$8.25
3/4"	NT34S	\$4.00	3/4" x 4 3/4"	BT34434S	\$11.50
7/8"	NT78S	\$8.25	7/8" x 6 1/2"	BT78615S	\$24.75
1"	NT10S	\$10.25	1" x 6 1/2"	BT10615S	\$37.25

Grinnell Gasket Lubricant		
<i>Size</i>	<i>Part Number</i>	<i>List Price</i>
1 Quart	32005	\$12.75
1 Gallon	32006	\$42.75
Grinnell Silicon Gasket Lubricant		
For use with Dry Pipe & Freezing Applications. Dow Corning #DC No. 7. Recommended for use with Tri-Seal Gaskets		
<i>Size</i>	<i>Part Number</i>	<i>List Price</i>
5.30 oz. Tube	32037	\$86.25
8 lb. Can	32038	\$1,580.00

Pipe Tape Chrome Plated w/Grinnell Logo		
<i>Size</i>	<i>Part Number</i>	<i>List Price</i>
1 Roll	PT1000	\$48.25

Section 16
Specialty Items

Section 18
Grooved Product

Section 19
CPVC Pipe & Fittings

Section 20
Miscellaneous

Section 21
Electrical

See latest Technical Data Sheets for specific Approvals, Listings, and Design Parameters. Prices subject to change without notice.

** Grooved Fittings are Full Flow manufactured from ASTM A536 Ductile Iron except those marked ** which are segmentally welded steel with roll-grooved ends..

#510 Fire Protection Grooved 90° Elbow

Section 16
Specialty Items

Section 18
Grooved Product

Section 19
CPVC Pipe & Fittings

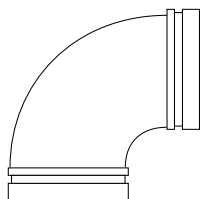

Nom. Size	Painted		Galvanized	
	Part Number	List Price	Part Number	List Price
1¼"	51013S	\$23.00	51013GS	\$30.75
1½"	51015S	\$23.00	51015GS	\$30.75
2"	51020S	\$25.00	51020GS	\$36.00
2½"	51025S	\$29.00	51025GS	\$45.50
3"	51030S	\$40.75	51030GS	\$64.00
4"	51040S	\$57.50	51040GS	\$90.00
5"	21050S	\$161.00	21050GS	\$252.00
6"	51060S	\$161.00	51060GS	\$252.00
8"	51080S	\$322.75	51080GS	\$505.25
10"	21010S	\$696.25	21010GS	\$1,021.50
12"	21012S	\$1,271.00	21012GS	\$1,632.00

Technical Data Sheet: TFP1810

#510S Fire Protection Short Pattern Grooved 90° Elbow - Domestic

Section 20
Miscellaneous

Section 21
Electrical

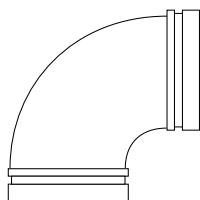

Nom. Size	Painted		Galvanized	
	Part Number	List Price	Part Number	List Price
2"	510S20S	\$21.75	510S20GS	\$30.25
2½"	510S25S	\$26.00	510S25GS	\$40.00
3"	510S30S	\$34.75	510S30GS	\$54.00
4"	510S40S	\$49.50	510S40GS	\$77.50
6"	510S60S	\$141.00	510S60GS	\$215.00
8"	510S80S	\$271.00	510S80GS	\$425.25

Technical Data Sheet: TFP1810

#326 Drain 90 w/1" Outlet* Schedule 10

Nom. Size	Part Number	List Price
2"	72570	\$103.25
2½"	72571	\$103.25
3"	72572	\$113.00
4"	72573	\$130.50
5"	72574	\$167.75
6"	72575	\$186.25
8"	72576	\$315.50

#510DE 90 w/1" Outlet

Nom. Size	Painted		Galvanized	
	Part Number	List Price	Part Number	List Price
2½"	51025DS	\$96.25	51025DGS	\$124.75
3"	51030DS	\$105.50	51030DGS	\$175.00
4"	51040DS	\$122.25	51040DGS	\$202.75
6"	51060DS	\$174.50	51060DGS	\$290.00
8"	51080DS	\$295.75	51080DGS	\$492.00

See latest Technical Data Sheets for specific Approvals, Listings, and Design Parameters. Prices subject to change without notice.

** Grooved Fittings are Full Flow manufactured from ASTM A536 Ductile Iron except those marked ** which are segmentally welded steel with roll-grooved ends..

Price Book - Section 18 Grinnell Grooved Products

#501 Fire Protection Grooved 45° Elbow					
	Nom. Size	Painted		Galvanized	
		Part Number	List Price	Part Number	List Price
		1¼"	50113S	\$23.00	50113GS
1½"	50115S	\$23.00	50115GS	\$30.75	
2"	50120S	\$25.00	50120GS	\$36.00	
2½"	50125S	\$29.00	50125GS	\$45.50	
3"	50130S	\$40.75	50130GS	\$64.00	
4"	50140S	\$57.50	50140GS	\$90.00	
5"	20150S	\$161.00	20150GS	\$252.00	
6"	50160S	\$161.00	50160GS	\$252.00	
8"	50180S	\$322.75	50180GS	\$505.25	
10"	20110S	\$696.25	20110GS	\$1,021.50	
12"	20112S	\$1,271.00	20112GS	\$1,632.00	
Technical Data Sheet: TFP1810					

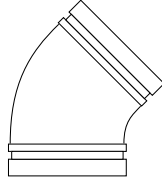

Section 16
Specialty Items
Section 18
Grooved Product
Section 19
CPVC Pipe & Fittings

#312 Grooved 22½° Elbow**					
	Nom. Size	Painted		Galvanized	
		Part Number	List Price	Part Number	List Price
		1¼"	75550	\$61.50	75570
1½"	75551	\$61.50	75571	\$99.00	
2"	75552	\$61.50	75572	\$99.00	
2½"	75553	\$61.50	75573	\$99.00	
3"	75554	\$96.75	75574	\$145.25	
4"	75555	\$120.00	75575	\$179.25	
5"	75556	\$321.00	75576	\$418.00	
6"	75557	\$344.25	75577	\$556.50	
8"	75558	\$708.25	75578	\$1,147.25	
10"	75559	\$971.50	75579	\$1,574.50	
12"	75560	\$982.75	75580	\$2,126.25	
Technical Data Sheet: TFP1810					

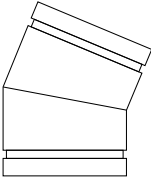

Section 20
Miscellaneous
Section 21
Electrical

#311 Grooved 11¼° Elbow**					
	Nom. Size	Painted		Galvanized	
		Part Number	List Price	Part Number	List Price
		1¼"	75300	\$61.50	75316
1½"	75301	\$61.50	75317	\$99.00	
2"	75302	\$103.25	75318	\$130.25	
2½"	75303	\$103.25	75319	\$130.25	
3"	75304	\$103.25	75313	\$145.25	
4"	75305	\$120.00	75314	\$177.25	
5"	75306	\$314.25	75320	\$352.00	
6"	75307	\$338.25	75321	\$556.50	
8"	75308	\$708.25	75322	\$1,113.00	
10"	75309	\$971.50	75315	\$1,574.50	
12"	75310	\$1,312.00	75323	\$2,126.25	
Technical Data Sheet: TFP1810					

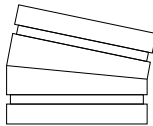

See latest Technical Data Sheets for specific Approvals, Listings, and Design Parameters. Prices subject to change without notice.

** Grooved Fittings are Full Flow manufactured from ASTM A536 Ductile Iron except those marked ** which are segmentally welded steel with roll-grooved ends..

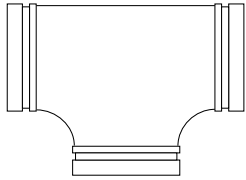
Section 16 Specialty Items	#519 Fire Protection Grooved Tee					
	Nom. Size	Painted		Galvanized		
		Part Number	List Price	Part Number	List Price	
Section 18 Grooved Product		1¼"	51913S	\$35.00	51913GS	\$41.00
		1½"	51915S	\$35.00	51915GS	\$41.00
		2"	51920S	\$37.25	51920GS	\$51.75
		2½"	51925S	\$47.00	51925GS	\$68.75
		3"	51930S	\$66.25	51930GS	\$96.25
		4"	51940S	\$101.25	51940GS	\$148.50
		5"	21950S	\$272.75	21950GS	\$399.50
		6"	51960S	\$272.75	51960GS	\$399.50
		8"	51980S	\$580.50	51980GS	\$850.50
		10"	21910S	\$1,566.25	21910GS	\$1,912.75
		12"	21912S	\$2,562.50	21912GS	\$2,681.50
		Section 19 CPVC Pipe & Fittings	Technical Data Sheet: TFP1810			

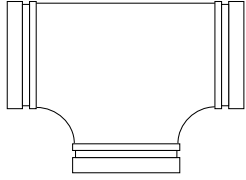
Section 20 Miscellaneous	#519S Fire Protection Short Pattern Grooved Tee - Domestic					
	Nom. Size	Painted		Galvanized		
		Part Number	List Price	Part Number	List Price	
Section 21 Electrical		2"	519S20S	\$31.50	519S20GS	\$43.50
		2½"	519S25S	\$39.50	519S25GS	\$57.75
		3"	519S30S	\$55.50	519S30GS	\$81.25
		4"	519S40S	\$85.25	519S40GS	\$124.75
		6"	519S60S	\$229.50	519S60GS	\$336.50
		8"	519S80S	\$488.50	519S80GS	\$715.75
Technical Data Sheet: TFP1810						

See latest Technical Data Sheets for specific Approvals, Listings, and Design Parameters. Prices subject to change without notice.

** Grooved Fittings are Full Flow manufactured from ASTM A536 Ductile Iron except those marked ** which are segmentally welded steel with roll-grooved ends..

Price Book - Section 18 Grinnell Grooved Products

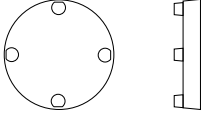
#260 Grooved Cap					
	Nom. Size	Painted		Galvanized	
		Part Number	List Price	Part Number	List Price
	1¼"	26013S	\$10.50	26013GS	\$16.00
	1½"	26015S	\$11.25	26015GS	\$17.75
	2"	26020S	\$13.25	26020GS	\$20.50
	2½"	26025S	\$16.00	26025GS	\$24.75
	3" O.D.	26030MS	\$19.25	26030MGS	\$30.75
	3"	26030S	\$19.75	26030GS	\$30.75
	4"	26040S	\$30.00	26040GS	\$46.50
	5"	26050S	\$64.25	26050GS	\$90.25
	6"	26060S	\$80.50	26060GS	\$125.25
	6½" O.D.	26060MS	\$86.75	26060MGS	\$125.25
	8"	26080S	\$131.75	26080GS	\$207.25
	10"	26010S	\$269.50	26010GS	\$440.50
	12"	26012S	\$452.50	26012GS	\$710.00

Technical Data Sheet: TFP1810

Section 16
Specialty Items
 Section 18
Grooved Product
 Section 19
CPVC Pipe & Fittings
 Section 20
Miscellaneous
 Section 21
Electrical

#260 Grooved Cap w/ ½" Tap		
Nom. Size	Painted	List Price
2"	26020TS	\$29.75
2½"	26025TS	\$31.50
3"	26030TS	\$36.25
4"	26040TS	\$47.25
5"	26050TS	\$75.25
6"	26060TS	\$85.00
8"	26080TS	\$159.25

#260 Grooved Cap w/ 1" Tap		
Nom. Size	Painted	List Price
2"	26020T1S	\$31.50
2½"	26025T1S	\$33.50
3"	26030T1S	\$38.00
4"	26040T1S	\$49.50
5"	26050T1S	\$76.75
6"	26060T1S	\$90.00
8"	26080T1S	\$169.25

See latest Technical Data Sheets for specific Approvals, Listings, and Design Parameters. Prices subject to change without notice.

** Grooved Fittings are Full Flow manufactured from ASTM A536 Ductile Iron except those marked ** which are segmentally welded steel with roll-grooved ends..

#321 Grooved Reducing Tee **

Section 16
Specialty Items

Section 18
Grooved Product

Section 19
CPVC Pipe & Fittings

Section 20
Miscellaneous

Section 21
Electrical

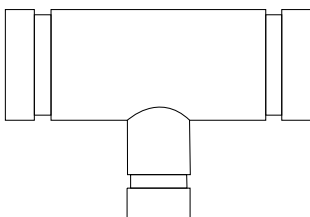

Nom. Size	Painted		Galvanized	
	Part Number	List Price	Part Number	List Price
2" x 1"	75410	\$165.50	75470	\$208.50
2" x 1½"	75411	\$165.50	75471	\$208.50
2½" x 1"	75412	\$165.50	—	POA
2½" x 1¼"	75413	\$165.50	73590	\$208.50
2½" x 1½"	75414	\$165.50	73591	\$208.50
2½" x 2"	75415	\$165.50	75472	\$208.50
3" x 1"	75416	\$165.50	—	POA
3" x 1½"	75417	\$165.50	73592	\$208.50
3" x 2"	75418	\$165.50	75473	\$208.50
3" x 2½"	75419	\$165.50	75474	\$208.50
4" x 1"	75420	\$197.00	—	POA
4" x 1½"	75421	\$197.00	73594	\$246.25
4" x 2"	75422	\$197.00	75475	\$246.25
4" x 2½"	75423	\$197.00	75476	\$246.25
4" x 3"	75424	\$197.00	75477	\$246.25
5" x 2"	75425	\$389.00	73595	\$486.75
5" x 2½"	75426	\$389.00	73596	\$486.75
5" x 3"	75427	\$389.00	75489	\$486.75
5" x 4"	75428	\$423.25	73597	\$529.00
6" x 2"	75429	\$465.50	75478	\$586.00
6" x 2½"	75430	\$465.50	75479	\$586.00
6" x 3"	75431	\$465.50	75480	\$586.00
6" x 4"	75432	\$465.50	75481	\$586.00
6" x 5"	75433	\$465.50	—	POA
6" x 8"	75434	POA	—	POA
8" x 3"	75435	\$672.50	75482	\$847.00
8" x 4"	75436	\$971.50	75483	\$1,221.00
8" x 5"	75437	\$971.50	75484	\$1,221.00
8" x 6"	75438	\$971.50	75485	\$1,221.00
10" x 3"	75439	\$1,092.75	73621	\$1,366.00
10" x 4"	75440	\$1,142.00	73622	\$1,427.50
10" x 5"	75441	\$1,167.75	73623	\$1,459.75
10" x 6"	75442	\$1,156.50	73624	\$1,445.75
10" x 8"	75443	\$1,188.75	73625	\$1,486.00
12" x 6"	75444	\$1,685.00	73629	\$2,106.25
12" x 8"	75445	\$1,734.25	73630	\$2,167.50
12" x 10"	75446	\$1,813.75	73631	\$2,267.25

Note:

All other galvanized sizes not noted are Priced On Availability.
Items listed in shaded areas are non-cancelable and non-returnable.

Technical Data Sheet: TFP1810

See latest Technical Data Sheets for specific Approvals, Listings, and Design Parameters. Prices subject to change without notice.

** Grooved Fittings are Full Flow manufactured from ASTM A536 Ductile Iron except those marked ** which are segmentally welded steel with roll-grooved ends..

Price Book - Section 18 Grinnell Grooved Products

#550 Cast Concentric Reducer , #350 Fabricated Concentric Reducer **					
	Nom. Size	Painted		Galvanized	
		Part Number	List Price	Part Number	List Price
	1½" x 1"	—	\$60.50	73400	\$72.75
	1½" x 1¼"	72918	\$60.50	—	POA
	2" x ½"	72850	\$60.50	73392	\$72.75
	2" x ¾"	72851	\$60.50	73401	\$72.75
	2" x 1"	72852	\$60.50	73402	\$72.75
	2" x 1¼"	72853	\$64.50	73403	\$77.00
	2" x 1½"	72854	\$64.50	73404	\$77.00
	2½" x 1"	72855	\$60.50	73393	\$77.00
	* 2½" x 1¼"	5502513S	\$60.50	5502513GS	\$77.00
	* 2½" x 1½"	5502515S	\$60.50	5502515GS	\$77.00
	* 2½" x 2"	5502520S	\$60.50	5502520GS	\$77.00
	3" x 1"	72860	\$66.75	73406	\$80.75
	3" x 1¼"	72861	\$66.75	73396	\$80.75
	* 3" x 1½"	5503015S	\$69.75	5503015GS	\$83.25
	* 3" x 2"	5503020S	\$73.25	5503020GS	\$87.75
	* 3" x 2½"	5503025S	\$73.25	5503025GS	\$87.75
	4" x 1"	72867	\$89.00	73409	\$106.50
	4" x 1¼"	72868	\$89.00	—	\$106.50
	4" x 1½"	72869	\$89.00	73410	\$106.50
	* 4" x 2"	5504020S	\$89.00	5504020GS	\$106.50
	* 4" x 2½"	5504025S	\$94.25	5504025GS	\$113.75
	* 4" x 3"	5504030S	\$94.25	5504030GS	\$113.75
	4" x 3½"	72875	\$94.25	73398	\$113.75
	5" x 2"	72876	\$123.00	73399	\$154.75
	5" x 2½"	72877	\$123.00	—	\$154.75
	* 5" x 3"	5505030S	\$123.00	5505030GS	\$154.75
	* 5" x 4"	5505040S	\$123.00	5505040GS	\$154.75
	* 6" x 2"	5506020S	\$164.00	5506020GS	\$197.50
	* 6" x 2½"	5506025S	\$164.00	5506025GS	\$197.50
	* 6" x 3"	5506030S	\$164.00	5506030GS	\$197.50
	* 6" x 4"	5506040S	\$164.00	5506040GS	\$197.50
	* 6" x 5"	5506050S	\$211.00	5506050GS	\$254.00
	* 8" x 3"	5508030S	\$291.50	5508030GS	\$351.25
	* 8" x 4"	5508040S	\$291.50	5508040GS	\$351.25
	* 8" x 5"	5508050S	\$291.50	5508050GS	\$351.25
	* 8" x 6"	5508060S	\$372.00	5508060GS	\$447.50
	10" x 4"	72889	\$638.75	—	\$714.00
	10" x 6"	72890	\$698.25	73425	\$838.00
	10" x 8"	72891	\$698.25	73422	\$875.75
	12" x 4"	72893	\$773.00	—	\$1,012.00
	12" x 6"	72894	\$830.00	—	\$1,086.25
	12" x 8"	72895	\$1,171.00	73423	\$1,530.25
	12" x 10"	72896	\$1,217.75	—	\$1,593.00
Notes:					
* Available as cast fitting.					
Items listed in shaded areas are non-cancelable and non-returnable.					
Technical Data Sheet: TFP1810					

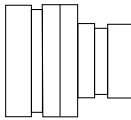

Section 16
Specialty Items

 Section 18
Grooved Product

 Section 19
CPVC Pipe & Fittings

 Section 20
Miscellaneous

 Section 21
Electrical

See latest Technical Data Sheets for specific Approvals, Listings, and Design Parameters. Prices subject to change without notice.

** Grooved Fittings are Full Flow manufactured from ASTM A536 Ductile Iron except those marked ** which are segmentally welded steel with roll-grooved ends..

Section 16
Specialty Items

Section 18
Grooved Product

Section 19
CPVC Pipe & Fittings

Section 20
Miscellaneous

Section 21
Electrical

#341 Grooved x Flanged Adapter ** 150# - Schedule 40

	Nom. Size	Painted		Galvanized	
		Part Number	List Price	Part Number	List Price
		2"	73230	\$208.00	73250
2½"	73231	\$246.25	73251	\$307.75	
3"	73232	\$281.00	73252	\$355.25	
4"	73233	\$433.25	73253	\$546.75	
5"	73234	\$580.00	73254	\$759.00	
6"	73235	\$580.00	73255	\$759.00	
8"	73236	\$803.25	73256	\$1,050.50	
10"	73237	\$1,316.50	74253	POA	
12"	73238	\$1,847.00	74254	POA	
Note:					
Items listed in shaded areas are non-cancelable and non-returnable.					
Technical Data Sheet: TFP1810					

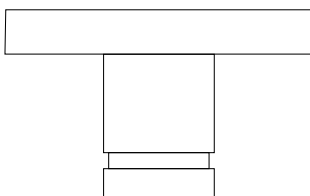

#342 Grooved x Flanged Adapter ** 300# - Schedule 40

	Nom. Size	Painted		Galvanized	
		Part Number	List Price	Part Number	List Price
		4"	73260	POA	73263
5"	73261	POA	73264	POA	
6"	73262	POA	74283	POA	
Note:					
Items listed in shaded areas are non-cancelable and non-returnable.					

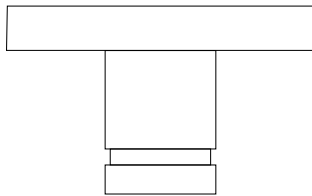

#320 Grooved x Thread Tee **

	Nom. Size	Painted	List Price
	1½"	75490	\$131.25
	2"	75491	\$131.25
	2½"	75492	\$131.25
	3"	75493	\$198.25
	4"	75494	\$281.75
	6"	75495	\$702.75

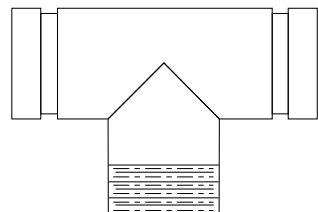

Standpipe Tee **

Nom. Size	Painted		Galvanized	
	Part Number	List Price	Part Number	List Price
4" x 4" x 2½"	76768	POA	76755	POA
6" x 6" x 2½"	76769	POA	76771	POA

#507/50L Bullhead Tee **

Nom. Size	Painted		Galvanized	
	Part Number	List Price	Part Number	List Price
5" x 5" x 8"	76772	POA	76774	POA
6" x 6" x 8"	76773	POA	76775	POA

See latest Technical Data Sheets for specific Approvals, Listings, and Design Parameters. Prices subject to change without notice.

** Grooved Fittings are Full Flow manufactured from ASTM A536 Ductile Iron except those marked ** which are segmentally welded steel with roll-grooved ends..

Price Book - Section 18 Grinnell Grooved Products

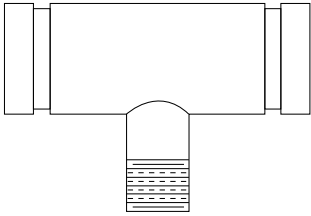
#323 Grooved x Thread Reducing Tee **					
	Nom. Size	Painted		Galvanized	
		Part Number	List Price	Part Number	List Price
	2" x 1	75500	\$172.00	75520	\$216.25
	2" x 1½"	75501	\$172.00	75522	\$216.25
	2½" x 1¼"	75502	\$172.00	73608	\$216.25
	2½" x 1½"	75503	\$172.00	73609	\$216.25
	2½" x 2	75504	\$172.00	73610	\$216.25
	3" x 1	75505	\$172.00	75521	\$216.25
	3" x 1½"	75506	\$172.00	75546	\$216.25
	3" x 2	75507	\$172.00	75523	\$216.25
	3" x 2½"	75508	\$199.50	73611	\$313.00
	4" x 1	75509	\$199.50	75524	\$312.25
	4" x 2	75510	\$199.50	75525	\$313.00
	4" x 2½"	75511	\$199.50	73691	\$313.00
	4" x 3	75512	\$199.50	75526	\$313.00
	5" x 2	75513	\$411.25	73692	POA
	6" x 2	75514	\$512.25	75527	\$600.00
	6" x 2½"	75590	\$512.25	75528	\$600.00
	6" x 3	75515	\$512.25	75529	\$600.00
	6" x 4	75516	\$512.25	73694	\$600.00
6" x 5	75517	\$512.25	73695	POA	
8" x 2	75518	\$662.00	73696	POA	
8" x 3	75519	\$662.00	73697	POA	
Note:					
Items listed in shaded areas are non-cancelable and non-returnable.					

Section 16
Specialty Items

 Section 18
Grooved Product

 Section 19
CPVC Pipe & Fittings

 Section 20
Miscellaneous

 Section 21
Electrical

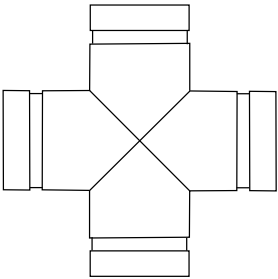
#327 Grooved Cross **					
	Nom. Size	Painted		Galvanized	
		Part Number	List Price	Part Number	List Price
	2"	75840	\$139.50	75849	\$167.25
	2½"	75841	\$139.50	75850	\$167.25
	3"	75842	\$250.50	75851	\$305.00
	4"	75843	\$416.75	75852	\$500.50
	6"	75845	\$1,060.50	75853	\$1,330.50
	8"	75846	\$1,433.75	76757	\$1,687.75
	10"	75847	\$2,186.25	76758	\$2,747.25
	12"	75848	\$3,153.50	76759	\$3,960.50
Notes:					
* Any sizes not listed as available are Priced On Availability.					
Grinnell Fittings listed are Segmentally-Welded Steel with Roll-Grooved Ends.					
Items listed in shaded areas are non-cancelable and non-returnable.					
Technical Data Sheet: TFP1810					

See latest Technical Data Sheets for specific Approvals, Listings, and Design Parameters. Prices subject to change without notice.

** Grooved Fittings are Full Flow manufactured from ASTM A536 Ductile Iron except those marked ** which are segmentally welded steel with roll-grooved ends..

Section 16
Specialty Items

Section 18
Grooved Product

Section 19
CPVC Pipe & Fittings

Section 20
Miscellaneous

Section 21
Electrical

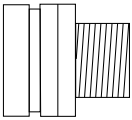
#372 Reducer - Small End Threaded **					
	Nom. Size	Painted		Galvanized	
		Part Number	List Price	Part Number	List Price
	1½" x 1"	76800	\$66.00	76825	\$81.50
	2" x ¾"	76801	\$66.00	76826	\$81.50
	2" x 1"	76802	\$66.00	76827	\$81.50
	2" x 1¼"	76815	\$66.00	73794	POA
	2" x 1½"	76803	\$66.00	76828	\$81.50
	2½" x 1¼"	76816	\$83.75	73795	POA
	2½" x 1½"	76817	\$83.75	73796	POA
	2½" x 2"	76804	\$83.75	76829	\$103.75
	3" x 1"	76805	\$73.00	76830	\$87.00
	3" x 1¼"	76818	\$82.00	—	POA
	3" x 1½"	76819	\$82.00	73797	POA
	3" x 2"	76806	\$82.00	76831	\$97.75
	3" x 2½"	76807	\$98.50	76832	\$116.50
	4" x 1"	76808	\$98.50	76833	\$119.50
	4" x 1¼"	76820	\$98.50	—	POA
	4" x 1½"	76821	\$98.50	73799	POA
	4" x 2"	76809	\$98.50	76834	\$119.50
	4" x 2½"	76810	\$98.50	76835	\$119.50
	4" x 3"	76811	\$107.25	76836	\$131.50
	6" x 1"	76812	\$191.00	76837	\$234.75
6" x 2"	76813	\$191.00	76838	\$234.75	
6" x 3"	76814	\$191.00	76839	\$234.75	

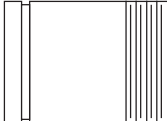
#391 Groove x Male Thread- Adapter Nipple					
	Nom. Size	Painted		Galvanized	
		Part Number	List Price	Part Number	List Price
	1¼ x 4	75121	\$37.25	74292	POA
	1½ x 4	75122	\$37.25	74293	POA
	2 x 4	75123	\$37.25	74294	POA
	2½ x 4	75124	\$44.00	74295	POA
	3 x 4	75125	\$54.00	74296	POA
	3 x 6	74335	\$87.50	—	POA
	4 x 6	75126	\$89.25	74297	POA
	5 x 6	75129	\$184.00	74298	POA
	6 x 6	75130	\$237.50	74299	POA
	8 x 6	75131	\$266.75	74300	POA
	10 x 8	75132	\$388.00	74301	POA
	12 x 8	75133	\$486.25	74302	POA

See latest Technical Data Sheets for specific Approvals, Listings, and Design Parameters. Prices subject to change without notice.

** Grooved Fittings are Full Flow manufactured from ASTM A536 Ductile Iron except those marked ** which are segmentally welded steel with roll-grooved ends..

Price Book - Section 18 Grinnell Grooved Products

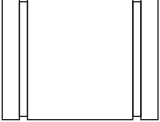
#392 Groove x Groove- Adapter Nipple					
	<i>Nom. Size</i>	<i>Painted</i>		<i>Galvanized</i>	
		<i>Part Number</i>	<i>List Price</i>	<i>Part Number</i>	<i>List Price</i>
			1 x 1¼	75098	\$37.25
	1½ x 4	75099	\$37.25	74405	POA
	2 x 4	75100	\$37.25	74406	POA
	2½ x 4	75101	\$44.00	74407	POA
	3 x 4	75102	\$54.00	74408	POA
	4 x 6	75103	\$89.25	74309	POA
	5 x 6	75104	\$184.00	74310	POA
	6 x 6	75105	\$237.50	74311	POA
	8 x 6	75106	\$266.75	74312	POA
	10 x 8	75107	\$388.00	74313	POA
	12 x 8	75108	\$486.25	74314	POA

Section 16
Specialty Items
Section 18
Grooved Product
Section 19
CPVC Pipe & Fittings

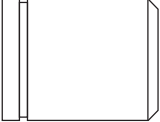
#393 Groove x Plain- Adapter Nipple					
	<i>Nom. Size</i>	<i>Painted</i>		<i>Galvanized</i>	
		<i>Part Number</i>	<i>List Price</i>	<i>Part Number</i>	<i>List Price</i>
			1 x 1¼	75148	\$37.25
	1½ x 4	74315	\$37.25	74317	POA
	2 x 4	75150	\$37.25	74318	POA
	2½ x 4	75151	\$44.00	74319	POA
	3 x 4	75152	\$54.00	74330	POA
	4 x 6	75153	\$89.25	74331	POA
	5 x 6	75158	\$184.00	74322	POA
	6 x 6	75154	\$237.50	74323	POA
	8 x 6	75155	\$266.75	74324	POA
	10 x 8	75156	\$388.00	74325	POA
	12 x 8	75157	\$486.25	74326	POA

Section 20
Miscellaneous
Section 21
Electrical

See latest Technical Data Sheets for specific Approvals, Listings, and Design Parameters. Prices subject to change without notice.

** Grooved Fittings are Full Flow manufactured from ASTM A536 Ductile Iron except those marked ** which are segmentally welded steel with roll-grooved ends..

**#730 Threaded Mechanical Tee with Domestic Grade "E" EPDM Gasket
Threaded Outlet**

Section 16
Specialty Items

Section 18
Grooved Product

Section 19
CPVC Pipe & Fittings

Section 20
Miscellaneous

Section 21
Electrical

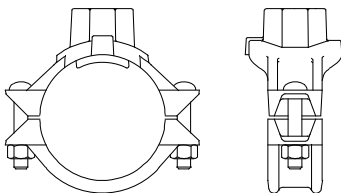

Nom. Size	Painted		Galvanized		Gasket Only	
	Part Number	List Price	Part Number	List Price	Part Number	List Price
2" x 1/2"	7302005ES	\$50.50	7302005EGS	\$66.75	730EGS-1	\$8.50
2" x 3/4"	73020075ES	\$50.50	73020075EGS	\$66.75	730EGS-1	\$8.50
2" x 1"	7302010ES	\$50.50	7302010EGS	\$66.75	730EGS-1	\$8.50
2" x 1 1/4"	7302013ES	\$50.50	7302013EGS	\$66.75	730EGS-2	\$11.00
2" x 1 1/2"	7302015ES	\$50.50	7302015EGS	\$66.75	730EGS-2	\$11.00
2 1/2" x 1/2"	7302505ES	\$50.50	7302505EGS	\$66.75	730EGS-1	\$8.50
2 1/2" x 3/4"	73025075ES	\$50.50	73025075EGS	\$66.75	730EGS-1	\$8.50
2 1/2" x 1"	7302510ES	\$50.50	7302510EGS	\$66.75	730EGS-1	\$8.50
2 1/2" x 1 1/4"	7302513ES	\$58.25	7302513EGS	\$85.00	730EGS-3	\$11.00
2 1/2" x 1 1/2"	7302515ES	\$53.00	7302515EGS	\$80.50	730EGS-3	\$11.00
2 1/2" x 2"	7302520EP	\$58.25	7302520EGP	\$85.00	-	-
3" x 1/2"	7303005ES	\$58.25	7303005EGS	\$76.25	730EGS-1	\$8.50
3" x 3/4"	73030075ES	\$58.25	73030075EGS	\$76.25	730EGS-1	\$8.50
3" x 1"	7303010ES	\$58.25	7303010EGS	\$76.25	730EGS-1	\$8.50
3" x 1 1/4"	7303013ES	\$69.00	7303013EGS	\$90.00	730EGS-2	\$11.00
3" x 1 1/2"	7303015ES	\$69.00	7303015EGS	\$90.00	730EGS-3	\$11.00
3" x 2"	7303020ES	\$72.25	7303020EGS	\$94.75	730EGS-4	\$11.50
4" x 1/2"	7304005ES	\$69.00	7304005EGS	\$90.00	730EGS-1	\$8.50
4" x 3/4"	73040075ES	\$69.00	73040075EGS	\$90.00	730EGS-1	\$8.50
4" x 1"	7304010ES	\$69.00	7304010EGS	\$90.00	730EGS-1	\$8.50
4" x 1 1/4"	7304013ES	\$80.50	7304013EGS	\$104.25	730EGS-2	\$11.00
4" x 1 1/2"	7304015ES	\$80.50	7304015EGS	\$104.25	730EGS-3	\$11.00
4" x 2"	7304020ES	\$80.50	7304020EGS	\$104.25	730EGS-4	\$11.50
4" x 2 1/2"	7304025ES	\$80.50	7304025EGS	\$110.50	730EGS-5	\$12.50
4" x 3"	7304030ES	\$87.25	7304030EGS	\$118.75	730EGS-7	\$13.25
5" x 1 1/2"	7305015EP	\$114.25	7305015EGP	\$150.00	730EGS-3	\$11.00
5" x 2"	7305020ES	\$114.25	7305020EGS	\$150.00	730EGS-4	\$11.50
5" x 2 1/2"	7305025ES	\$114.25	7305025EGS	\$150.00	730EGS-5	\$12.50
5" x 3"	7305030EP	\$122.50	7305030EGP	\$160.50	-	-
6" x 1 1/4"	7306013EP	\$122.50	7306013EGP	\$160.50	-	-
6" x 1 1/2"	7306015ES	\$122.50	7306015EGS	\$160.50	730EGS-3	\$11.00
6" x 2"	7306020ES	\$139.75	7306020EGS	\$182.75	730EGS-4	\$11.50
6" x 2 1/2"	7306025ES	\$170.00	7306025EGS	\$222.75	730EGS-6	\$12.50
6" x 3"	7306030ES	\$178.00	7306030EGS	\$232.25	730EGS-8	\$13.25
6" x 4"	7306040ES	\$190.50	7306040EGS	\$249.25	730EGS-9	\$13.75
8" x 2 1/2"	7308025ES	\$217.50	7308025EGS	\$285.00	730EGS-6	\$12.50
8" x 3"	7308030ES	\$229.50	7308030EGS	\$285.00	730EGS-8	\$13.25
8" x 4"	7308040ES	\$229.50	7308040EGS	\$285.00	730EGS-9	\$13.75

Technical Data Sheet: TFP1860

See latest Technical Data Sheets for specific Approvals, Listings, and Design Parameters. Prices subject to change without notice.

** Grooved Fittings are Full Flow manufactured from ASTM A536 Ductile Iron except those marked ** which are segmentally welded steel with roll-grooved ends..

Price Book - Section 18 Grinnell Grooved Products

#730 Grooved Mechanical Tee Domestic with Grade "E" EPDM Gasket Grooved Outlet

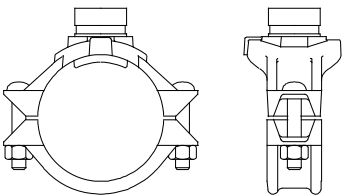
	Nom. Size	Painted		Galvanized		Gasket Only	
		Part Number	List Price	Part Number	List Price	Part Number	List Price
	2" x 1¼"	7302013ERS	\$57.00	7302013EGRS	\$72.25	730EGS-2	\$11.00
	2" x 1½"	7302015ERS	\$57.00	7302015EGRS	\$72.25	730EGS-2	\$11.00
	2½" x 1¼"	7302513ERS	\$57.00	7302513EGRS	\$76.25	730EGS-3	\$11.00
	2½" x 1½"	7302515ERS	\$61.50	7302515EGRS	\$80.50	730EGS-3	\$11.00
	2½" x 2"	7302520ERP	\$61.50	7302520EGRP	\$80.50	-	-
	3" x 1¼"	7303013ERS	\$68.75	7303013EGRS	\$90.00	730EGS-2	\$11.00
	3" x 1½"	7303015ERS	\$68.75	7303015EGRS	\$90.00	730EGS-3	\$11.00
	3" x 2"	7303020ERS	\$72.25	7303020EGRS	\$94.75	730EGS-4	\$11.50
	4" x 1¼"	7304013ERS	\$80.50	7304013EGRS	\$104.25	730EGS-2	\$11.00
	4" x 1½"	7304015ERS	\$80.50	7304015EGRS	\$104.25	730EGS-3	\$11.00
	4" x 2"	7304020ERS	\$80.50	7304020EGRS	\$104.25	730EGS-4	\$11.50
	4" x 2½"	7304025ERS	\$81.25	7304025EGRS	\$110.50	730EGS-5	\$12.50
	4" x 3"	7304030ERS	\$87.50	7304030EGRS	\$118.75	730EGS-7	\$13.25
	5" x 1½"	7305015EP	\$114.25	7305015EGS	\$150.00	730EGS-3	\$11.00
	5" x 2"	7305020ERS	\$114.25	7305020EGRS	\$150.00	730EGS-4	\$11.50
	5" x 2½"	7305025ERS	\$114.25	7305025EGRS	\$150.00	730EGS-5	\$12.50
	5" x 3"	7305030ERP	\$122.50	7305030EGRP	\$160.50	-	-
	6" x 1¼"	7306013ERP	\$122.50	7306013EGRP	\$160.50	-	-
	6" x 1½"	7306015ERS	\$122.50	7306015EGRS	\$160.00	730EGS-3	\$11.00
	6" x 2"	7306020ERS	\$139.75	7306020EGRS	\$182.75	730EGS-4	\$11.50
6" x 2½"	7306025ERS	\$170.00	7306025EGRS	\$222.75	730EGS-6	\$12.50	
6" x 3"	7306030ERS	\$178.00	7306030EGRS	\$232.25	730EGS-8	\$13.25	
6" x 4"	7306040ERS	\$190.50	7306040EGRS	\$249.25	730EGS-9	\$13.75	
8" x 2½"	7308025ERS	\$217.50	7308025EGRS	\$285.00	730EGS-6	\$12.50	
8" x 3"	7308030ERS	\$229.50	7308030EGRS	\$300.50	730EGS-8	\$13.25	
8" x 4"	7308040ERS	\$229.50	7308040EGRS	\$300.50	730EGS-9	\$13.75	

Technical Data Sheet: TFP1860

Section 16
Specialty Items

 Section 18
Grooved Product

 Section 19
CPVC Pipe & Fittings

 Section 20
Miscellaneous

 Section 21
Electrical

See latest Technical Data Sheets for specific Approvals, Listings, and Design Parameters. Prices subject to change without notice.

** Grooved Fittings are Full Flow manufactured from ASTM A536 Ductile Iron except those marked ** which are segmentally welded steel with roll-grooved ends..

Section 16
Specialty Items

Section 18
Grooved Product

Section 19
CPVC Pipe & Fittings

Section 20
Miscellaneous

Section 21
Electrical

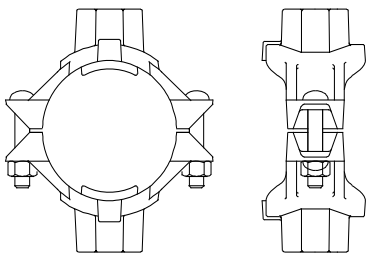
#730 Threaded Mechanical Cross with Domestic Grade "E" EPDM Gasket					
	Nom. Size	Painted		Galvanized	
		Part Number	List Price	Part Number	List Price
	2" x 1¼"	7302013ECS	\$87.75	7302013EGCS	\$115.00
	2" x 1½"	7302015ECS	\$87.75	7302015EGCS	\$115.00
	2½" x 1¼"	7302513ECS	\$91.50	7302513EGCS	\$119.75
	2½" x 1½"	7302515ECS	\$91.50	7302515EGCS	\$119.75
	3" x 1¼"	7303013ECS	\$107.25	7303013EGCS	\$141.00
	3" x 1½"	7303015ECS	\$107.25	7303015EGCS	\$141.00
	3" x 2"	7303020ECS	\$107.25	7303020EGCS	\$141.00
	4" x 1¼"	7304013ECS	\$125.50	7304013EGCS	\$164.25
	4" x 1½"	7304015ECS	\$125.50	7304015EGCS	\$164.25
	4" x 2"	7304020ECS	\$125.50	7304020EGCS	\$164.25
	4" x 2½"	7304025ECS	\$139.75	7304025EGCS	\$182.75
	4" x 3"	7304030ECS	\$145.25	7304030EGCS	\$190.00
	5" x 2"	7305020ECS	\$162.50	7305020EGCS	\$213.00
	5" x 2½"	7305025ECS	\$162.50	7305025EGCS	\$213.00
	6" x 1½"	7306015ECS	\$164.75	7306015EGCS	\$215.00
	6" x 2"	7306020ECS	\$170.75	7306020EGCS	\$223.75
	6" x 2½"	7306025ECS	\$178.00	7306025EGCS	\$232.25
	6" x 3"	7306030ECS	\$190.50	7306030EGCS	\$249.25
	6" x 4"	7306040ECS	\$203.00	7306040EGCS	\$265.25
	8" x 2½"	7308025ECS	\$226.25	7308025EGCS	\$295.25
8" x 3"	7308030ECS	\$246.25	7308030EGCS	\$321.75	
8" x 4"	7308040ECS	\$246.25	7308040EGCS	\$321.75	

Technical Data Sheet: TFP1860

See latest Technical Data Sheets for specific Approvals, Listings, and Design Parameters. Prices subject to change without notice.

** Grooved Fittings are Full Flow manufactured from ASTM A536 Ductile Iron except those marked ** which are segmentally welded steel with roll-grooved ends..

Price Book - Section 18 Grinnell Grooved Products

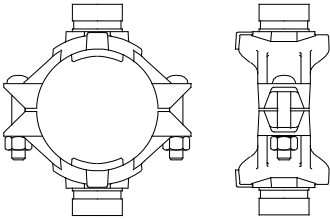
#730 Grooved Mechanical Cross with Grade "E" EPDM Gasket					
	Nom. Size	Painted		Galvanized	
		Part Number	List Price	Part Number	List Price
	2 x 1 1/4"	7302013ERCS	\$87.75	7302013EGRCS	\$115.00
	2 x 1 1/2"	7302015ERCS	\$87.75	7302015EGRCS	\$115.00
	2 1/2" X 1 1/4"	7302513ERCS	\$91.50	7302513EGRCS	\$119.75
	2 1/2" X 1 1/2"	7302515ERCS	\$91.50	7302515EGRCS	\$119.75
	3 X 1 1/4"	7303013ERCS	\$107.25	7303013EGRCS	\$141.00
	3 X 1 1/2"	7303015ERCS	\$107.25	7303015EGRCS	\$141.00
	3 X 2"	7303020ERCS	\$107.25	7303020EGRCS	\$141.00
	4 X 1 1/4"	7304013ERCS	\$125.50	7304013EGRCS	\$164.25
	4 X 1 1/2"	7304015ERCS	\$125.50	7304015EGRCS	\$164.25
	4 X 2"	7304020ERCS	\$125.50	7304020EGRCS	\$164.25
	4 X 2 1/2"	7304025ERCS	\$139.75	7304025EGRCS	\$182.75
	4 X 3"	7304030ERCS	\$145.25	7304030EGRCS	\$190.00
	5 X 2"	7305020ERCS	\$162.50	7305020EGRCS	\$213.00
	5 x 2 1/2"	7305025ERCS	\$162.50	7305025EGRCS	\$213.00
	6 X 1 1/2"	7306015ERCS	\$164.75	7306015EGRCS	\$215.00
	6 X 2"	7306020ERCS	\$170.75	7306020EGRCS	\$223.75
	6 X 2 1/2"	7306025ERCS	\$178.00	7306025EGRCS	\$232.25
	6 x 3"	7306030ERCS	\$190.50	7306030EGRCS	\$249.25
	6 x 4"	7306040ERCS	\$203.00	7306040EGRCS	\$265.25
	8 X 2 1/2"	7308025ERCS	\$226.25	7308025EGRCS	\$295.25
8 X 3"	7308030ERCS	\$246.25	7308030EGRCS	\$321.75	
8 X 4"	7308040ERCS	\$246.25	7308040EGRCS	\$321.75	

Technical Data Sheet: TFP1860

Section 16
Specialty Items

 Section 18
Grooved Product

 Section 19
CPVC Pipe & Fittings

 Section 20
Miscellaneous

 Section 21
Electrical

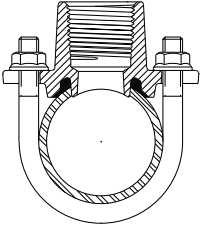
#40-5 Strap			
	Nom. Size	w/"E" Gasket	List Price
	1 1/4" x 1/2"	STP1305ES	\$14.00
	1 1/4" x 3/4"	STP13075ES	\$14.00
	1 1/4" x 1"	STP1310ES	\$15.25
	1 1/2" x 1/2"	STP1505ES	\$15.25
	1 1/2" x 3/4"	STP15075ES	\$15.25
	1 1/2" x 1"	STP1510ES	\$15.25
	2" x 1/2"	STP2005ES	\$16.25
	2" x 3/4"	STP20075ES	\$16.25
	2" x 1"	STP2010ES	\$16.25
	2 1/2" x 1/2"	STP2505ES	\$18.25
	2 1/2" x 3/4"	STP25075ES	\$18.25
	2 1/2" x 1"	STP2510ES	\$18.25

See latest Technical Data Sheets for specific Approvals, Listings, and Design Parameters. Prices subject to change without notice.

** Grooved Fittings are Full Flow manufactured from ASTM A536 Ductile Iron except those marked ** which are segmentally welded steel with roll-grooved ends.

Section 16
Specialty Items

Section 18
Grooved Product

Section 19
CPVC Pipe & Fittings

Section 20
Miscellaneous

Section 21
Electrical

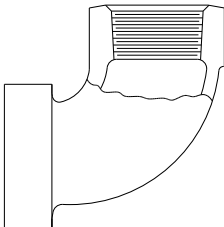
Ada-Cap®			
	<i>Nom. Size</i>	<i>Part Number</i>	<i>List Price</i>
	1½" x ½"	7501505S	\$24.75
	1½" x ¾"	75015075S	\$24.75
	1½" x 1"	7501510S	\$24.75
	2" x ½"	7502005S	\$26.25
	2" x ¾"	75020075S	\$26.25
	2" x 1"	7502010S	\$26.50
	2½" x ½"	7502505S	\$26.50
	2½" x ¾"	75025075S	\$26.50
	2½" x 1"	7502510S	\$28.50
Technical Data Sheet: TFP1810			

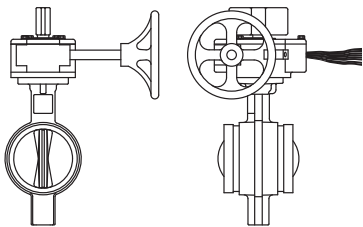
Grooved Butterfly Valves Fire Protection			
Model BFV-N Grv x Grv, Gear Operated w/ Tamper Switches - 300psi			
	<i>Nom. Size</i>	<i>UL, FM & ULC</i>	<i>List Price</i>
	2½"	59-300-F-025N	See Section 15 for Pricing
	3"	59-300-F-030N	
	4"	59-300-F-040N	
	5"	59-300-F-050N	
	6"	59-300-F-060N	
	8**	59-300-F-080N	
	10"	59-300-F-100N	

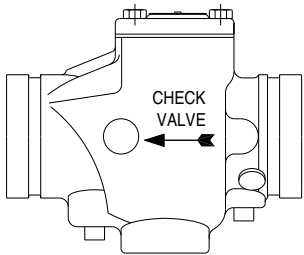
Model CV-1F Grooved Check Valve			
	<i>Nom. Size</i>	<i>Part Number</i>	<i>List Price</i>
	2"	59-590-0-020	See Section 15 for Pricing
	2½"	59-590-0-025	
	3"	59-590-0-030	
	4"	59-590-0-040	
	5"	59-590-0-050	
	6"	59-590-0-060	
	8**	59-590-0-080	

See latest Technical Data Sheets for specific Approvals, Listings, and Design Parameters. Prices subject to change without notice.

** Grooved Fittings are Full Flow manufactured from ASTM A536 Ductile Iron except those marked ** which are segmentally welded steel with roll-grooved ends..

Price Book - Section 18

Grinnell Imported Grooved Products

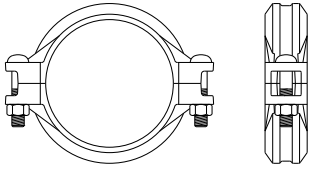

#577 Import Light Weight Rigid Coupling W/ Grade "A" Fire Protection Pre-Lubricated Gasket						
Import		Nom. Size	Painted		Galvanized	
			Part Number	List Price	Part Number	List Price
				1¼	57713ACP	\$18.85
		1½	57715ACP	\$19.55	57715AGCP	\$27.70
		2	57720ACP	\$21.00	57720AGCP	\$29.80
		2½	57725ACP	\$24.50	57725AGCP	\$34.80
		3	57730ACP	\$28.75	57730AGCP	\$40.75
		4	57740ACP	\$37.60	57740AGCP	\$53.15
		6	57760ACP	\$65.60	57760AGCP	\$92.80
		8	57780ACP	\$111.60	57780AGCP	\$158.00

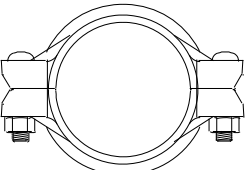
#705 Import Fire Protection Flexible Coupling W/ Grade "A" Fire Protection Pre-Lubricated Gasket						
Import		Nom. Size	Painted		Galvanized	
			Part Number	List Price	Part Number	List Price
				1¼	70513ACP	\$18.85
		1½	70515ACP	\$19.50	70515AGCP	\$27.70
		2	70520ACP	\$21.00	70520AGCP	\$29.80
		2½	70525ACP	\$24.50	70525AGCP	\$34.80
		3	70530ACP	\$28.75	70530AGCP	\$40.75
		4	70540ACP	\$37.60	70540AGCP	\$53.15
		6	70560ACP	\$65.60	70560AGCP	\$92.80
		8	70580ACP	\$111.60	70580AGCP	\$158.00

Section 16
Specialty Items

 Section 18
Grooved Product

 Section 19
CPVC Pipe & Fittings

 Section 20
Miscellaneous

 Section 21
Electrical

See latest Technical Data Sheets for specific Approvals, Listings, and Design Parameters. Prices subject to change without notice.

** Grooved Fittings are Full Flow manufactured from ASTM A536 Ductile Iron except those marked ** which are segmentally welded steel with roll-grooved ends..

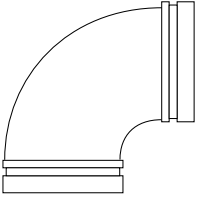
Section 16 Specialty Items	# 510 Import Full Pattern - Grooved 90° Elbow						
	Section 18 Grooved Product	Import	Nom. Size	Painted		Galvanized	
				Part Number	List Price	Part Number	List Price
Section 19 CPVC Pipe & Fittings		1¼	51013P	\$18.05	51013GP	\$28.25	
		1½	51015P	\$18.05	51015GP	\$28.65	
		2	51020P	\$19.10	51020GP	\$30.10	
		2½	51025P	\$27.15	51025GP	\$42.85	
		3	51030P	\$38.50	51030GP	\$60.05	
		4	51040P	\$54.25	51040GP	\$85.35	
		6	51060P	\$153.00	51060GP	\$240.10	
		8	51080P	\$306.60	51080GP	\$480.75	
		10	51010P	\$619.00	51010GP	\$842.15	
		12	51012P	\$1,131.05	51012GP	\$1,539.35	

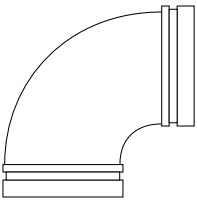
Section 20 Miscellaneous	# 510S Import Short Pattern - Grooved 90° Elbow						
	Section 21 Electrical	Import	Nom. Size	Painted		Galvanized	
				Part Number	List Price	Part Number	List Price
		2	510S20P	\$16.95	510S20GP	\$26.40	
		2½	510S25P	\$24.55	510S25GP	\$38.50	
		3	510S30P	\$33.75	510S30GP	\$52.80	
		4	510S40P	\$49.10	510S40GP	\$77.30	
		6	510S60P	\$138.75	510S60GP	\$218.15	
		8	510S80P	\$273.75	510S80GP	\$429.55	

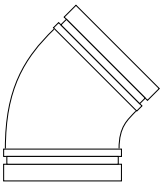
# 501 Import Full Pattern - Grooved 45° Elbow						
	Import	Nom. Size	Painted		Galvanized	
			Part Number	List Price	Part Number	List Price
		1¼	50113P	\$17.25	50113GP	\$27.50
		1½	50115P	\$18.05	50115GP	\$28.25
		2	50120P	\$19.85	50120GP	\$31.90
		2½	50125P	\$27.15	50125GP	\$42.60
		3	50130P	\$37.40	50130GP	\$58.65
		4	50140P	\$53.10	50140GP	\$83.50
		6	50160P	\$148.65	50160GP	\$233.50
		8	50180P	\$297.10	50180GP	\$466.10
		10	50110P	\$619.00	50110GP	\$842.15
		12	50112P	\$1,131.05	50112GP	\$1,539.35

See latest Technical Data Sheets for specific Approvals, Listings, and Design Parameters. Prices subject to change without notice.

** Grooved Fittings are Full Flow manufactured from ASTM A536 Ductile Iron except those marked ** which are segmentally welded steel with roll-grooved ends..

Price Book - Section 18

Grinnell Imported Grooved Products



# 519 Import Full Pattern - Grooved Tee					
 Import	Nom. Size	Painted		Galvanized	
		Part Number	List Price	Part Number	List Price
		1¼	51913P	\$22.40	51913GP
1½	51915P	\$22.40	51915GP	\$32.95	
2	51920P	\$33.40	51920GP	\$48.80	
2½	51925P	\$44.40	51925GP	\$63.00	
3	51930P	\$62.30	51930GP	\$91.45	
4	51940P	\$95.95	51940GP	\$140.55	
6	51960P	\$259.75	51960GP	\$379.80	
8	51980P	\$552.40	51980GP	\$809.20	
10	51910P	\$1,394.40	51910GP	\$1,896.35	
12	51912P	\$1,900.70	51912GP	\$2,586.90	

# 519S Import Short Pattern - Grooved Tee					
 Import	Nom. Size	Painted		Galvanized	
		Part Number	List Price	Part Number	List Price
		2	519S20P	\$26.40	519S20GP
2½	519S25P	\$38.90	519S25GP	\$60.85	
3	519S30P	\$54.60	519S30GP	\$85.70	
4	519S40P	\$83.50	519S40GP	\$131.05	
6	519S60P	\$204.85	519S60GP	\$321.95	
8	519S80P	\$482.25	519S80GP	\$757.25	

# 260 Import Cap					
 Import	Nom. Size	Painted		Galvanized	
		Part Number	List Price	Part Number	List Price
		1¼	26013P	\$8.75	26013GP
1½	26015P	\$10.55	26015GP	\$16.55	
2	26020P	\$12.30	26020GP	\$19.50	
2½	26025P	\$14.60	26025GP	\$23.20	
3	26030P	\$18.40	26030GP	\$28.65	
4	26040P	\$27.90	26040GP	\$43.95	
6	26060P	\$75.80	26060GP	\$118.95	
8	26080P	\$125.20	26080GP	\$196.90	
10	26010P	\$267.10	26010GP	\$590.50	
12	26012P	\$430.25	26012GP	\$675.40	

Section 16
Specialty Items

 Section 18
Grooved Product

 Section 19
CPVC Pipe & Fittings

 Section 20
Miscellaneous

 Section 21
Electrical

See latest Technical Data Sheets for specific Approvals, Listings, and Design Parameters. Prices subject to change without notice.

** Grooved Fittings are Full Flow manufactured from ASTM A536 Ductile Iron except those marked ** which are segmentally welded steel with roll-grooved ends..

Section 16
Specialty Items

Section 18
Grooved Product

Section 19
CPVC Pipe & Fittings

Section 20
Miscellaneous

Section 21
Electrical

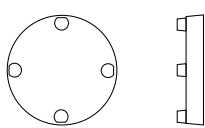
# 260 Import Cap Tapped 1/2", 1" Painted					
	Nom. Size	with 1/2" Tap		with 1" Tap	
		Part Number	List Price	Part Number	List Price
		2	26020TP	\$26.90	26020T1P
2 1/2	26025TP	\$28.65	26025T1P	\$31.90	
3	26030TP	\$32.65	26030T1P	\$37.05	
4	26040TP	\$43.25	26040T1P	\$48.35	
6	26060TP	\$79.45	26060T1P	\$89.00	
8	26080TP	\$149.40	26080T1P	\$167.65	

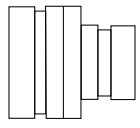
#150 Import Grooved Concentric Reducers - Cast					
	Nom. Size	Painted		Galvanized	
		Part Number	List Price	Part Number	List Price
		2 1/2" x 2"	72858C	\$55.45	73405C
3" x 2"	72863 C	\$55.45	73407C		
3" x 2 1/2"	72865C	\$65.80	73408C	\$79.55	
4" x 2"	72870C	\$79.80	73411C	\$100.25	
4" x 2 1/2"	72872C	\$79.80	73412C		
4" x 3"	72873C	\$85.70	73413C	\$107.25	
5" x 4"	72879C	\$111.45	73414C		
6" x 3"	72926C	\$147.85	73417C	\$174.20	
6" x 4"	72883C		73418C	\$173.60	
6" x 5"	72884C	\$191.55	-	-	
8" x 4"	72886C		73420C	\$318.95	
8" x 6"	72888C		73421C		
10" x 6"	72890C		73425C	\$709.00	
10" x 8"	72891C		73422C	\$709.00	
12" x 8"	72895C	\$832.45	73423C		
12" x 10"	72896C		73424C		

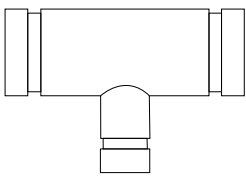
#121 Import Grooved Reducing Tee - Cast					
	Nom. Size	Painted		Galvanized	
		Part Number	List Price	Part Number	List Price
		2" x 1"	75410C		-
2" x 1 1/2"	75411C	\$146.45	75471C		
2 1/2" x 2"	75415C		75472C		
3" x 2"	75418C	\$148.40	75473C		
3" x 2 1/2"	75419C	\$148.40	75474C	\$185.10	
4" x 2"	75422C	\$173.90	75475C		
4" x 2 1/2"	75423C	\$173.90	75476C	\$218.70	
4" X 3"	75424C	\$173.90	75477C		
6" x 3"	75431C	\$411.60	75480C	\$516.90	
6" x 4"	75432C	\$411.60	75481C		

See latest Technical Data Sheets for specific Approvals, Listings, and Design Parameters. Prices subject to change without notice.

** Grooved Fittings are Full Flow manufactured from ASTM A536 Ductile Iron except those marked ** which are segmentally welded steel with roll-grooved ends..

Price Book - Section 18 Grinnell Grooved Products

Roll Grooving Machine Selection Chart											
Machine Type	Pace Model	Size Range				Drive	Rolls Supplied			Part Number	List Price **
		Sch. 40	Sch 10	Std. Wall	Copper		Size	Steel	Copper		
Portable w/Electric Motor	1112	1" - 12"	-	-	2" - 8"	1½ HP, 110V	1" - 12"	■		41048	\$6,741.00
	1010	1½" - 6"	1½" - 12"	-	-	½ HP, 110V	1½" - 12"	■		41030	\$6,726.00
	1023	1¼" - 12"	-	12" - 24"	2" - 8"	1½ HP, 110V	1¼" - 12"	■		41029	\$9,969.00
							2" - 12"	■		41250	\$9,487.00
							1¼" - 24"	■		41251	\$11,106.00
							2" - 24"	■		41256	\$10,620.00
	1021	1¼" - 12"	-	12" - 24"	2" - 8"	2 HP, 220V	1¼" - 12"	■		41253	\$9,969.00
							2" - 12"	■		41254	\$9,487.00
							1¼" - 24"	■		41255	\$11,106.00
							2" - 24"	■		41256	\$10,620.00
Portable for Rigid 300	1012	1" - 12"	-	-	2" - 8"	Rigid 300	1" - 12"	■		41041	\$3,741.00
	1022	1¼" - 12"	-	12" - 16"	2" - 8"	Rigid 300	1¼" - 16"	■		41027	\$8,421.00
	1041	1" - 6"	1" - 12"	-	2" - 8"	Rigid 300	1" - 12"	■		41018	\$2,620.00
Mini-Mites	1039-66	1¼" - 6"	-	-	2" - 8"	Rigid 300, Hand Crank	2" - 8" CTS		■	41047	\$767.00
	1034	1¼" - 6"	-	-	-	Rigid 300	1¼" - 6" IPS	■		41015	\$571.00
	1041	-	-	-	2" - 8"	Rigid 300	2" - 8" CTS		■	41014	\$571.00
Automated	2021	1¼" - 12"	-	12" - 24"	2" - 8"	3 HP, 220V	1¼" - 12"	■		41257	\$17,520.00
							2" - 12"	■		41258	\$17,039.00
							1¼" - 24"	■		41032	\$18,658.00
							2" - 24"	■		41259	\$18,127.00
	2010	1½" - 6"	1½" - 12"	-	-	1½ HP, 110V	1½" - 12"	■		41031	\$10,998.00
Portable Cut Groover	1000	2" - 8"	-	-	-	1 HP, 115V	2" - 8"			41260	\$7,848.00
		2" - 12"	-	-	-		2" - 12"			41261	\$8,585.00

Notes:

** Accessories not included, refer to Accessory Table Below

Accessories						
	Pace Model	Size Range	Capacity	Part Number	List Price	
Pipe Stands	4031	1" - 4"	600 Lbs.	41037	\$400.00	
	4000	2" - 8"	900 Lbs.	41038	\$494.00	
	4033	2" - 14"	1,200 Lbs.	41039	\$619.00	
	4040	12" - 24"	4,000 Lbs.	41040	\$1,571.00	
Nipple Bracket	4037	Fits Model 1021 / 22 // 23 / 2021		-	41035	\$500.00
	4045	4" -12" Fits Model 1012 / 1112		-	41512	\$416.00
Mounting Feet	4039	Fits Portable Roll Groovers and Model 1000		-	41034	\$126.00
Porta-Bore	3013	Up to 4¼" Holes in pipe 1¼" - 12"		-	41049	\$2,066.00

See latest Technical Data Sheets for specific Approvals, Listings, and Design Parameters. Prices subject to change without notice.

** Grooved Fittings are Full Flow manufactured from ASTM A536 Ductile Iron except those marked *** which are segmentally welded steel with roll-grooved ends..

Roll Selection Chart										
Machine	Pipe	Size	Top		Size	Bottom		Parts	Part Number	List Price
			Part No.	List Price		Part No.	List Price			
1021, 1023, 2021	Sch. 40	1¼" - 1½"	41262	\$280.00	1¼" - 1½"	41281	\$203.00			
		2" - 3½"	41263	\$244.00	2" - 3½"	41282	\$188.00			
		4" - 6"	41264	\$217.00	4" - 6"	41283	\$285.00			
		8" - 12"	41265	\$217.00	8" - 12"	41284	\$340.00			
	Std. Wall	14" - 16"	41266	\$204.00	14" - 16"	41285	\$374.00			
		18" - 24"	41267	\$204.00	18" - 24"	41286	\$374.00			
	Copper Tube	2" - 8"	41268	\$244.00	2" - 8"	41287	\$188.00	Depth Gauge 4043	41509	\$27.75
1010, 2010	Sch. 10, Sch. 40	1½" - 6"	41269	\$204.00	1½"	41288	\$188.00			
			-	-	2" - 3½"	41289	\$188.00			
			-	-	4" - 6"	41290	\$274.00			
	Sch. 10	8" - 12"	41270	\$204.00	8" - 12"	41291	\$274.00			
1040, 2040	Sch. 40	1" - 1½"	41271	\$167.00	1" - 1½"	41292	\$167.00			
		1" - 6"	41272	\$148.00	1" - 6"	41293	\$140.00			
		2" - 6"	41273	\$167.00	-	-	-			
	Sch. 10	8" - 12"	41274	\$148.00	8" - 12"	41294	\$231.00			
	Copper Tube	2" - 8"	41275	\$149.00	2" - 8"	41295	\$143.00	Depth Gauge 4021	41510	\$27.75
1012, 1112, 2112	Sch. 40	1" - 1½"	41276	\$167.00	1" - 1½"	41296	\$167.00			
		2" - 6"	41277	\$167.00	2" - 6"	41297	\$140.00			
		8" - 12"	41278	\$167.00	8" - 12"	41298	\$233.00			
	Copper Tube	2" - 8"	41506	\$167.00	2" - 8"	41507	\$143.00	Depth Gauge 4021	41510	\$27.75
1021, 1022, 1023, 2021	SS 10 Ga.				2" - 3½"	41299	\$206.00			
					4" - 6"	41500	\$314.00			
					8" - 12"	41501	\$374.00			
					14" - 16"	41504	\$411.00			
					18" - 24"	41505	\$411.00			
1040, 1041, 1112, 2112	SS 10 Ga.				2" - 6"	41502	\$155.00			
					8" - 12"	41503	\$277.00			
1034, 1039	Sch. 40	1¼" - 6", w/brg.	41279	\$39.00				1034 Drive Shaft 1¼" - 6"	41511	\$61.25
								1039 Drive Shaft 1¼" - 6"	41513	\$78.00
								Depth Gauge 4021	41510	\$27.75
1039	Copper Tube	2" - 8", w/brg.	41280	\$52.00				Depth Gauge 4021	41510	\$27.75
1066	Copper Tube	2" - 8", w/brg.	41508	\$52.00				Drive Shaft 2" - 8"	41514	\$61.25
								Depth Gauge 4021	41510	\$27.75

See latest Technical Data Sheets for specific Approvals, Listings, and Design Parameters. Prices subject to change without notice.

** Grooved Fittings are Full Flow manufactured from ASTM A536 Ductile Iron except those marked ** which are segmentally welded steel with roll-grooved ends..

Price Book - Section 18 Grinnell Grooved Products

Domestic Grooved Couplings - Packaging Quantity (Including Std. and Pre-Lubricated Gaskets)													
Nom. Size	#772 Painted		#772 Galvanized & Tri-Seal		#705 Painted		#705 Galvanized & Tri-Seal		#71 Flange Adapter		Size Range	#716 Reducing Coupling	
	Pieces / Carton	Pieces / Crate	Pieces / Carton	Pieces / Crate	Pieces / Carton	Pieces / Crate	Pieces / Carton	Pieces / Crate	Pieces / Carton	Pieces / Crate		Pieces / Carton	Pieces / Crate
1 1/4"	32	-	32	-	32	-	32	-	-	-	2" x 1 1/2"	20	-
1 1/2"	28	-	28	-	32	-	32	-	-	-	2 1/2" x 2"	36	-
2"	-	385	24	-	-	480	28	-	-	210	3" x 2"	12	-
2 1/2"	-	350	20	-	-	350	20	-	-	210	3" x 2 1/2"	9	-
3"	-	240	28	-	-	270	35	-	-	124	4" x 2"	6	-
4"	-	150	20	-	-	175	20	-	-	124	4" x 2 1/2"	6	-
5"	-	100	-	100	-	96	-	96	-	30	4" x 3"	6	-
6"	-	80	-	80	-	80	-	80	-	30	5" x 4"	-	80
8"	-	44	-	44	-	48	-	48	-	30	6" x 4"	-	64
10"	-	24	-	24	-	24	-	24	-	24	6" x 5"	-	64
12"	-	20	-	20	-	20	-	20	-	24	8" x 6"	-	36

Domestic Grooved Fittings - Packaging Quantity													
Nom. Size	#510 90° Elbow		#501 45° Elbow		#519 Tee		#260 Cap		Nom. Size Range	Adacaps		#40-5 Strap	
	Pieces / Carton	Pieces / Crate	Pieces / Carton	Pieces / Crate	Pieces / Carton	Pieces / Crate	Pieces / Carton	Pieces / Crate		Pieces / Carton	Pieces / Crate	Pieces / Carton	Pieces / Crate
1 1/4"	40	-	45	-	28	-	287	-	1 1/4" x 1 1/2"	-	-	45	-
1 1/2"	27	-	39	-	28	-	210	-	1 1/4" x 3/4"	-	-	45	-
2"	18	-	24	-	24	-	140	-	1 1/4" x 1"	-	-	45	-
2 1/2"	8	-	15	-	10	-	84	-	1 1/2" x 1 1/2"	50	-	45	-
3"	12	-	18	-	12	-	56	-	1 1/2" x 3/4"	50	-	45	-
4"	-	168	-	96	-	46	30	-	1 1/2" x 1"	50	-	45	-
5"	-	105	-	140	-	75	-	392	2" x 1 1/2"	50	-	45	-
6"	-	63	-	90	-	48	-	288	2" x 3/4"	50	-	45	-
8"	-	28	-	48	-	24	-	160	2" x 1"	50	-	45	-
10"	-	15	-	-	-	-	-	96	2 1/2" x 1 1/2"	40	-	40	-
12"	-	8	-	-	-	-	-	63	2 1/2" x 3/4"	40	-	40	-
-	-	-	-	-	-	-	-	-	2 1/2" x 1"	40	-	40	-

See latest Technical Data Sheets for specific Approvals, Listings, and Design Parameters. Prices subject to change without notice.

** Grooved Fittings are Full Flow manufactured from ASTM A536 Ductile Iron except those marked ** which are segmentally welded steel with roll-grooved ends..

Domestic Grooved Fittings - Packaging Quantity					
Section 16 Specialty Items	Nom. Size	#510S	#519S	Nom. Size Range	#550
		Short Pattern 90° Elbow	Short Pattern Tee		Concentric Reducer
		Pieces /Carton	Pieces /Crate		Pieces /Carton
	2"	18	30	2½" x 1¼"	36
	2½"	8	20	2½" x 1½"	36
Section 18 Grooved Product	3"	12	12	2½" x 2"	36
	4"	210	46	3" x 1½"	45
	6"	78	48	3" x 2"	60
	8"	28	24	3" x 2½"	30
Section 19 CPVC Pipe & Fittings	-	-	-	4" x 2"	243
	-	-	-	4" x 2½"	243
	-	-	-	4" x 3"	243
	-	-	-	5" x 3"	147
	-	-	-	5" x 4"	147
Section 20 Miscellaneous	-	-	-	6" x 2"	72
	-	-	-	6" x 2½"	72
	-	-	-	6" x 3"	72
	-	-	-	6" x 4"	216
	-	-	-	6" x 5"	216
Section 21 Electrical	-	-	-	8" x 3"	80
	-	-	-	8" x 4"	80
	-	-	-	8" x 5"	1
	-	-	-	8" x 6"	1

Grooved Fittings - Pieces Per Carton/Case			
Nom Size	#730 Mechanical Tee	Nom Size	#730 Mechanical Tee (cont.)
2 x ½	15	4 x ½	12
2 x ¾	15	4 x ¾	12
2 x 1	15	4 x 1	12
2 x 1¼	26	4 x 1¼	12
2 x 1½	12	4 x 1½	12
2½ x ½	14	4 x 2	10
2½ x ¾	14	4 x 2½	10
2½ x 1	14	4 x 3	8
2½ x 1¼	32	5 x 2	8
2½ x 1½	20	5 x 2½	8
3 x ½	16	6 x 1½	8
3 x ¾	16	6 x 2	7
3 x 1	16	6 x 2½	7
3 x 1¼	18	6 x 3	6
3 x 1½	16	6 x 4	6
3 x 2	12	8 x 2½	4
-	-	8 x 3	4
-	-	8 x 4	4

See latest Technical Data Sheets for specific Approvals, Listings, and Design Parameters. Prices subject to change without notice.

** Grooved Fittings are Full Flow manufactured from ASTM A536 Ductile Iron except those marked ** which are segmentally welded steel with roll-grooved ends..

Price Book - Section 18 Grinnell Grooved Products



Import Grooved Couplings - Packaging Quantity								
Nom. Size	#577				#705			
	Pieces / Carton	Cartons / Pallet	Pieces / Pallet	Crate Qty	Pieces / Carton	Pieces / Crate	Pieces / Carton	Pieces / Crate
1¼"	24	48	1,152	—	24	48	1,152	—
1½"	20	48	960	—	20	48	960	—
2"	16	48	768	—	16	48	768	—
2½"	12	48	576	—	12	48	576	—
3"	—	—	—	819	—	—	—	520
4"	—	—	—	546	—	—	—	324
6"	—	—	—	252	—	—	—	165
8"	—	—	—	108	—	—	—	80

Section 16
Specialty Items
Section 18
Grooved Product
Section 19
CPVC Pipe & Fittings

Import Grooved Fittings - Packaging Quantity																
Nom. Size	#510 90° Elbow				#501 45° Elbow				#519 Tee				#260 Cap			
	Pieces / Carton	Cartons / Pallet	Pieces / Pallet	Crate Qty	Pieces / Carton	Cartons / Pallet	Pieces / Pallet	Crate Qty	Pieces / Carton	Cartons / Pallet	Pieces / Pallet	Crate Qty	Pieces / Carton	Cartons / Pallet	Pieces / Pallet	Crate Qty
1¼"	28	48	1,344	—	54	48	2,592	—	22	48	1,056	—	132	48	6,336	—
1½"	24	48	1,152	—	40	48	1,920	—	18	48	864	—	100	48	4,800	—
2"	13	48	624	—	18	48	864	—	12	48	576	—	64	48	3,072	—
2½"	6	48	288	—	12	48	576	—	4	48	192	—	42	48	2,016	—
3"	4	48	192	—	8	48	384	—	3	48	144	—	24	48	1,152	—
4"	—	—	—	195	—	—	—	315	—	—	—	120	12	48	576	—
6"	—	—	—	68	—	—	—	100	—	—	—	42	3	48	144	—
8"	—	—	—	32	—	—	—	44	—	—	—	18	3	48	144	—
10"	—	—	—	16	—	—	—	18	—	—	—	10	—	—	—	—
12"	—	—	—	8	—	—	—	15	—	—	—	—	—	—	—	—

Section 20
Miscellaneous
Section 21
Electrical

Import Grooved Fittings - Packaging Quantity												
Nom. Size	#510S Short Pattern 90° Elbow				#501 45° Elbow				#519S Short Pattern Tee			
	Pieces / Carton	Cartons / Pallet	Pieces / Pallet	Crate Qty	Pieces / Carton	Cartons / Pallet	Pieces / Pallet	Crate Qty	Pieces / Carton	Cartons / Pallet	Pieces / Pallet	Crate Qty
2"	15	48	720	—	12	48	576	—	33	48	1,584	—
2½"	10	48	480	—	6	48	288	—	30	48	1,440	—
3"	8	48	288	—	4	48	192	—	24	48	1,152	—
4"	—	—	—	234	—	—	—	150	10	48	480	—
6"	—	—	—	72	—	—	—	56	3	48	144	—
8"	—	—	—	33	—	—	—	21	2	48	96	—

See latest Technical Data Sheets for specific Approvals, Listings, and Design Parameters. Prices subject to change without notice.

** Grooved Fittings are Full Flow manufactured from ASTM A536 Ductile Iron except those marked *** which are segmentally welded steel with roll-grooved ends..

Section 16
Specialty Items

Section 18
Grooved Product

Section 19
CPVC Pipe & Fittings

Section 20
Miscellaneous

Section 21
Electrical

See latest Technical Data Sheets for specific Approvals, Listings, and Design Parameters. Prices subject to change without notice.

** Grooved Fittings are Full Flow manufactured from ASTM A536 Ductile Iron except those marked ** which are segmentally welded steel with roll-grooved ends..

CPVC Pipe						
ft./bundle	size	part no.	length	lift qty. (ft.)	lift wt. (lbs.)	list price/ft.
375	3/4"	80300	15'	7875	1418	\$1.90
250	3/4"	80300T	10'*	5250	945	\$1.90
200	3/4"	80307	8'*	4200	756	\$1.90
240	1"	80301	15'	5040	1320	\$2.95
160	1"	80301T	10'*	3360	880	\$2.95
128	1"	80308	8'*	2688	705	\$2.95
135	1 1/4"	80302	15'	2835	1191	\$4.60
90	1 1/4"	80302T	10'*	1890	794	\$4.60
105	1 1/2"	80303	15'	2205	1186	\$6.40
70	1 1/2"	80303T	10'*	1470	791	\$6.40
60	2"	80304	15'	1260	1063	\$9.40
40	2"	80304T	10'*	840	709	\$9.40
45	2 1/2"	80305	15'	1215	1531	\$14.60
30	3"	80306	15'	720	1344	\$22.30
Technical Data Sheet - TFP1915 Installation Instructions IH-1900						

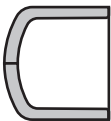
Cap (Slip)				
	box/bag	size	part no.	list price
	600/25	3/4"	80100	\$4.00
	300/20	1"	80101	\$5.60
	200/10	1 1/4"	80102	\$8.95
	120/10	1 1/2"	80103	\$12.60
	70/5	2"	80104	\$19.10
	40/5	2 1/2"	80105	\$26.70
	24/4	3"	80106	\$43.70

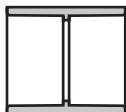
Coupling (Slip x Slip)				
	box/bag	size	part no.	list price
	300/25	3/4"	80075	\$6.55
	160/20	1"	80076	\$8.35
	150/10	1 1/4"	80077	\$12.60
	70/10	1 1/2"	80078	\$17.80
	40/5	2"	80079	\$24.30
	24/4	2 1/2"	80080	\$36.80
	14/2	3"	80081	\$47.40

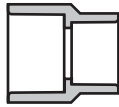
Reducing Coupling (Slip x Slip)				
	box/bag	size	part no.	list price
	280/20	1" x 3/4"	80220	\$7.65

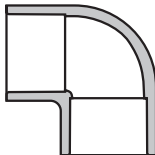
90° Elbow (Slip x Slip)				
	box/bag	size	part no.	list price
	250/25	3/4"	80025	\$6.75
	140/20	1"	80026	\$15.10
	90/10	1 1/4"	80027	\$19.10
	45/5	1 1/2"	80028	\$26.30
	24/4	2"	80029	\$38.50
	15/na	2 1/2"	80030	\$85.70
	9/na	3"	80031	\$95.60
	140/20	1" x 3/4"	80032	\$14.80

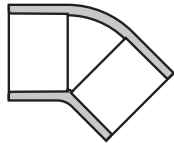
45° Elbow (Slip x Slip)				
	box/bag	size	part no.	list price
	300/25	3/4"	80050	\$9.10
	180/20	1"	80051	\$12.80
	90/15	1 1/4"	80052	\$15.90
	56/7	1 1/2"	80053	\$21.80
	28/4	2"	80054	\$49.50
		2 1/2"	90055	\$59.90
		3"	90056	\$70.00

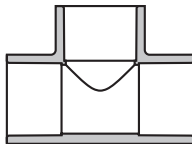
Tee (Slip x Slip x Slip)				
	box/bag	size	part no.	list price
	180/20	3/4"	80000	\$9.10
	100/10	1"	80001	\$18.30
	60/5	1 1/4"	80002	\$29.00
	30/5	1 1/2"	80003	\$40.20
	18/3	2"	80004	\$59.60
	12/na	2 1/2"	80005	\$96.60
	8/na	3"	80006	\$114.00

Items shown on this sheet may not be stocked at all Tyco Fire & Building Products warehouses. Please ask your local TFBP location for availability. Freight terms may vary for non commonly stocked items. See latest Technical Data Sheets for specific Approvals, Listings, Design Parameters & available finishes. Prices subject to change without notice.

Section 16
Specialty Items

Section 18
Grooved Product

Section 19
CPVC Pipe & Fittings

Section 20
Miscellaneous

Section 21
Electrical

Section 16
Specialty Items

Section 18
Grooved Product

Section 19
CPVC Pipe & Fittings

Section 20
Miscellaneous

Section 21
Electrical

Reducing Tee (Slip x Slip x Slip)

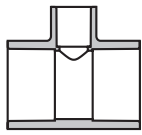

box/bag	size	part no.	list price
140/10	3/4" x 3/4" x 1"	80132	\$15.70
140/10	1 x 3/4" x 3/4"	80133	\$15.70
120/10	1 x 3/4" x 1"	80134	\$15.70
110/10	1" x 1" x 3/4"	80260	\$15.70
80/8	1 1/4" x 1" x 3/4"	80135	\$28.70
80/10	1 1/4" x 1" x 1"	80136	\$28.70
64/8	1 1/4" x 1" x 1 1/4"	80137	\$28.70
75/5	1 1/4" x 1 1/4" x 3/4"	80261	\$28.70
60/10	1 1/4" x 1 1/4" x 1"	80262	\$28.70
48/6	1 1/4" x 1 1/4" x 1 1/2"	80138	\$34.50
49/7	1 1/2" x 1 1/2" x 3/4"	80263	\$34.50
45/5	1 1/2" x 1 1/2" x 1"	80264	\$34.50
30/6	1 1/2" x 1 1/2" x 1 1/4"	80275	\$34.50
49/7	1 1/2" x 1 1/4" x 3/4"	80140	\$34.50
42/7	1 1/2" x 1 1/4" x 1"	80141	\$34.50
24/3	2" x 2" x 3/4"	80265	\$54.70
24/3	2" x 2" x 1"	80266	\$54.70
24/3	2" x 2" x 1 1/4"	80274	\$54.70
21/3	2" x 2" x 1 1/2"	80267	\$54.70
13/na	2 1/2" x 2 1/2" x 1"	80271	\$78.40
13/na	2 1/2" x 2 1/2" x 1 1/4"	80272	\$78.40
13/na	2 1/2" x 2 1/2" x 1 1/2"	80273	\$78.40
13/na	2 1/2" x 2 1/2" x 2"	80276	\$78.40
8/na	3" x 3" x 1 1/2"	80270	\$86.80
8/na	3" x 3" x 2"	80268	\$86.80
8/na	3" x 3" x 2 1/2"	80269	\$86.80

Cross (Slip x Slip x Slip x Slip)

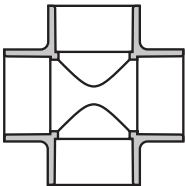

box/bag	size	part no.	list price
140/10	3/4"	80009	\$14.30
70/10	1"	80010	\$18.00
40/4	1 1/4"	80011	\$25.00
20/4	1 1/2"	80012	\$33.90
12/3	2"	80013	\$55.30
8/na	2 1/2"	80014	\$68.70
5/na	3"	80008	\$82.40
70/10	1" x 1" x 3/4" x 3/4"	80015	\$19.40

Reducer Bushing (Slip x Slip)

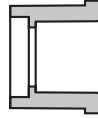

box/bag	size	part no.	list price
450/25	1" x 3/4"	80200	\$5.10
260/10	1 1/4" x 3/4"	80201	\$7.90
200/20	1 1/4" x 1"	80202	\$7.90
190/10	1 1/2" x 3/4"	80203	\$8.95
180/20	1 1/2" x 1"	80204	\$8.95
180/10	1 1/2" x 1 1/4"	80205	\$8.95
100/10	2" x 3/4"	80206	\$13.10
100/10	2" x 1"	80207	\$13.10
100/10	2" x 1 1/4"	80208	\$13.10
100/10	2" x 1 1/2"	80209	\$13.10
56/4	2 1/2" x 1"	80215	\$22.60
60/5	2 1/2" x 1 1/4"	80214	\$22.60
60/5	2 1/2" x 1 1/2"	80213	\$22.60
60/5	2 1/2" x 2"	80211	\$22.60
36/4	3" x 2"	80210	\$33.90
36/6	3" x 2 1/2"	80212	\$33.90

**Female Sprinkler Head Adapter (Slip x Fipt)
with Brass Threaded Insert**

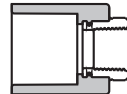

East

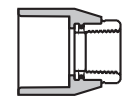

West

box/bag	size	part no.	list price
120/10	3/4" x 1/2" EAST	80175E	\$17.10
150/10	3/4" x 1/2" WEST	80175W	\$17.10
150/10	3/4" x 1/2" WEST LITE	80175WL	\$17.10
100/10	1" x 1/2" EAST	80176E	\$17.10
120/10	1" x 1/2" WEST	80176W	\$17.10
40/8	1" x 3/4"	80179	\$32.80

Items shown on this sheet may not be stocked at all Tyco Fire & Building Products warehouses. Please ask your local TFBP location for availability. Freight terms may vary for non commonly stocked items. See latest Technical Data Sheets for specific Approvals, Listings, Design Parameters & available finishes. Prices subject to change without notice.

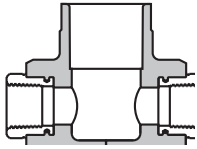
Back-to-Back Tee, Sprinkler Head Adapter (Fipt x Fipt x Slip) with Brass Threaded Inserts				
	box/bag	size	part no.	list price
	48/6	Back-to-back, Tee, 1/2" x 1/2" x 1" 3-3/8" Takeout	80460	\$72.30
	48/6	Back-to-back, Tee, 1/2" x 1/2" x 1" 3-5/8" Takeout	80459	\$72.30

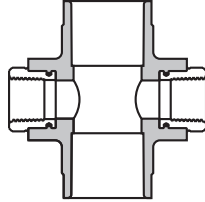
Back-to-Back Cross Sprinkler Head Adapter (Slip x Fipt) with Brass Threaded Inserts				
	box/bag	size	part no.	list price
	40/5	Back-to-back, Cross, 1" Slip x 1/2" Fipt 3-3/8" Takeout	80462	\$72.30
	40/5	Back-to-back, Cross, 1" Slip x 1/2" Fipt 3-5/8" Takeout	80463	\$72.30

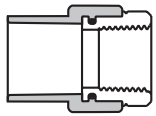
Spigot Sprinkler Head Adapter (Slip x Fipt) with Brass Threaded Insert				
	box/bag	size	part no.	list price
	220/10	3/4" x 1/2" LITE	80177L	\$16.60
	120/10	1" x 1/2"	80178	\$16.60
		1" x 3/4"	80180	\$33.30

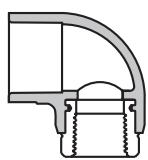
Sprinkler Head 90° Elbow (Slip x Fipt) with Brass Threaded Insert				
	box/bag	size	part no.	list price
	120/10	3/4" x 1/2"	80199	\$15.40
	80/10	1" x 1/2"	80198	\$21.10
	50/10	1" x 3/4"	80196	\$51.20

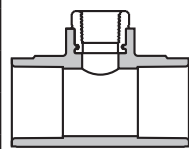
Sprinkler Head Tee (Slip x Female) with Brass Threaded Insert				
	box/bag	size	part no.	list price
	90/10	3/4" x 3/4" x 1/2"	80250	\$21.10
	40/10	1" x 1" x 1/2"	80251	\$25.00
	42/7	1 1/4" x 1 1/4" x 1/2"	80252	\$37.00
	42/7	1 1/4" x 1" x 1/2"	80256	\$40.20
	30/3	1" x 1" x 1"	80249	\$62.40
	25/5	1 1/2" x 1 1/4" x 1/2"	80257	\$53.80
	25/5	1 1/2" x 1 1/2" x 1/2"	80254	\$53.80
	20/4	2" x 1 1/2" x 1/2"	80258	\$73.20
	16/4	2" x 2" x 1/2"	80253	\$73.20

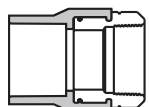
CPVC to Female Adapter (slip x female) with Brass Threaded Insert				
	box/bag	size	part no.	list price
	840/8	3/4"	80142	\$30.50
	30/6	1"	80145	\$51.40
	18/3	1 1/4"	80146	\$85.90
	12/3	1 1/2"	80147	\$115.50
	6/2	2"	80148	POA

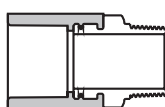
Male Adapter (Slip x Male) with Brass Threaded Insert				
	box/bag	size	part no.	list price
	60/10	3/4"	80157	\$29.50
	30/10	1"	80158	\$47.70

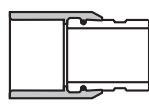
Grooved Coupling Adapter (Groove x Slip)				
	box/bag	size	part no.	list price
	40/4	1 1/4"	80160	\$118.00
	30/3	1 1/2"	80161	\$125.00
	15/3	2"	80162	\$144.50
	9/NA	2 1/2"	80163	POA
	8/NA	3"	80164	POA

Section 16
Specialty Items

Section 18
Grooved Product

Section 19
CPVC Pipe & Fittings

Section 20
Miscellaneous

Section 21
Electrical

Items shown on this sheet may not be stocked at all Tyco Fire & Building Products warehouses. Please ask your local TFBP location for availability. Freight terms may vary for non commonly stocked items. See latest Technical Data Sheets for specific Approvals, Listings, Design Parameters & available finishes. Prices subject to change without notice.

Section 16
Specialty Items

Section 18
Grooved Product

Section 19
CPVC Pipe & Fittings

Section 20
Miscellaneous

Section 21
Electrical

Primers & Cements

<i>description</i>	<i>part no.</i>	<i>list price</i>
TFP-500 Cement Pt. (one-step)	90740	\$18.00
TFP-500 Cement Qt. (one-step)	90741	\$35.00
TFP-401 Cement Pt. (one-step)	90760	\$18.00
TFP-401 Cement Qt. (one-step)	90761	\$35.00

Accessories

<i>description</i>	<i>part no.</i>	<i>list price</i>
CPVC Dauber 3/4"	90401	\$1.20
CPVC Dauber 1 1/2"	90400	\$1.30

Fire Stop

<i>description</i>	<i>part no.</i>	<i>list price</i>
BlazeMaster™ Caulk & Walk (10.5 oz. tube)	61126	\$27.58

Rothenberger Tools

<i>description</i>	<i>size</i>	<i>part no.</i>	<i>list price</i>
Plastic Wheel Cutter	1/4" - 2 ⁵ / ₈ "	52040	\$200.00
Plastic Wheel Cutter	2" - 5"	52041	\$320.00
Replacement Cutter Wheel	1/2" - 2 ⁵ / ₈ "	52042	\$23.00
Replacement Cutter Wheel	2" - 5"	52043	\$40.00
Ratchet Hand Cutter	1/2" - 2"	52045	\$414.00
Replacement Blade	1/8" - 1"	52046	\$50.00
Replacement Blade	1/2" - 2"	52047	\$100.00

Tyco Fire Products CPVC Tools

<i>description</i>	<i>part no.</i>	<i>list price</i>
Sprinkler Head Adapter Hold-Back Wrench (with two additional chains)	3002	\$171.00
Chain Kit for SHA Hold-Back Wrench (5 chains in Kit)	3011	\$78.00

McNulty Tools

<i>description</i>	<i>part no.</i>	<i>list price</i>
CPVC Retrofit Pipe Cutting Tool	2667	\$657.00
CPVC Retrofit Deburring Tool	2665	\$154.00
CPVC Retrofit Deburring Tool	2666	\$154.00
CPVC Retrofit Cutting Head	19071100	\$268.00

Reed Tool Manufacturing

<i>description</i>	<i>part no.</i>	<i>list price</i>
CPVC Tube Cutter, Up to 2" - Model #TC2QPVC	90355	\$254.00
Replacement Blades for CPVC Tube Cutter #TC2QPVC - Model #04184	90356	\$31.00
Deburring Tool, Up to 4" - Model #DEB4	90357	\$166.00
Deburring Tool, Up to 2" - Model #DEB2	91346	\$53.00

Items shown on this sheet may not be stocked at all Tyco Fire & Building Products warehouses. Please ask your local TFBP location for availability. Freight terms may vary for non commonly stocked items. See latest Technical Data Sheets for specific Approvals, Listings, Design Parameters & available finishes. Prices subject to change without notice.

Discontinued Valve Replacement Parts

The following repair parts are applicable to items that have been discontinued and are no longer available. Although the parts are shown in this catalog, TFBP does not guarantee the availability of the items. The parts shown in this section will be sold as long as they are available. TFBP does not have any plans to continue the production of these discontinued parts.

Note: All Items Are Non-Returnable

Central - 4" Dry Pipe Valve Model "AF" or "AG" (2002)

<i>Description</i>	<i>Part No.</i>	<i>List Price (each)</i>
Valve Cover	40002000	\$460.00
Cover Bolts (Purchase 6 Units Each)	60003000	\$12.50
Cover Gasket	40004000	\$112.50
Clapper Assembly	40018600	\$1,692.00
Clapper	40018200	\$782.50
Clapper Bushings (Purchase 2 Units Each)	80100800	\$31.25
Clapper Gasket	97602401	\$184.00
Latch	30010000	\$203.00
Latch Spring	30021000	\$35.25
Latch Pin	30023000	\$42.00
Retaining Rings (Purchase 2 Units Each)	30022000	\$31.25
Hex Head Clapper Bolts (Purchase 5 Units Each)	60080000	\$76.00
Hinge Pin	80101020	\$69.25
Clapper Bushings (Purchase 2 Units Each)	81808000	\$31.25
Retaining Plate	97602501	\$140.00

Central - 6" Dry Pipe Valves Model "AF" or "AG" (2002)

<i>Description</i>	<i>Part No.</i>	<i>List Price (each)</i>
Valve Cover	60002000	\$506.50
Cover Bolts (Purchase 8 Units Each)	60003000	\$12.50
Cover Gasket	60004000	\$112.50
Clapper	60018200	\$919.50
Clapper Bushings (Purchase 2 Units Each)	80100800	\$31.25
Clapper Gasket	60018000	\$203.00
Latch	30010000	\$203.00
Latch Spring	30021000	\$35.25
Latch Pin	30023000	\$42.00
Retaining Rings (Purchase 2 Units Each)	30022000	\$31.25
Hex Head Clapper Bolts (Purchase 6 Units Each)	60080000	\$76.00
Hinge Pin	80101010	\$69.25
Clapper Bushings (Purchase 2 Units Each)	81808000	\$31.25
Retaining Plate	60018100	\$253.50

Central - 4" Dry Pipe Valve, Model "H & K" (1988)

<i>Description</i>	<i>Part No.</i>	<i>List Price</i>
Clapper Gasket	40058000	\$213.00
Cover Gasket	40004000	\$112.50

Central - 6" Dry Pipe Valve, Model "H & K" (1988)

<i>Description</i>	<i>Part No.</i>	<i>List Price</i>
Clapper Gasket	60058000	\$213.00
Cover Gasket	60004000	\$112.50

Section 16
Specialty Items

Section 18
Grooved Product

Section 19
CPVC Pipe & Fittings

Section 20
Miscellaneous

Section 21
Electrical

Discontinued Valve Replacement Parts

The following repair parts are applicable to items that have been discontinued and are no longer available. Although the parts are shown in this catalog, TFBP does not guarantee the availability of the items. The parts shown in this section will be sold as long as they are available. TFBP does not have any plans to continue the production of these discontinued parts.

Note: All Items Are Non-Returnable

Central - 2" & 2½" Dry Pipe Valve, Model "D" (1988)

Description	Part No.	List Price
Clapper Gasket	25058000	\$213.00
Cover Gasket	25004000	\$88.75

Central - 3" Dry Pipe Valve, Model "D" (1988)

Description	Part No.	List Price
Clapper Gasket	30058000	\$213.00
Cover Gasket	30004000	\$88.75

Central - 4" Dry Pipe Valve, Model "D" (1988)

Description	Part No.	List Price
Clapper Gasket	40058000	\$213.00
Cover Gasket	40004000	\$112.50

Central - 4" Deluge Valve Model "A" (2001)

Description	Part No.	List Price
Diaphragm	82401500	\$69.25
Clapper Seal	82402600	\$74.25
Cover Gasket	82400300	\$35.25
Clapper Pin	82402700	\$32.25
Nose Pin	82401200	\$32.25
Clapper Spring	82602400	\$23.25
Lever Spring	82403100	\$23.25
Cap Screw	81611000	\$21.00
Diaphragm Cover	82401600	\$178.00
Diaphragm Piston	82401400	\$167.00
Water Restrictor	82403300	\$513.00

Central - 6" Deluge Valve Model "A" (2001)

Description	Part No.	List Price
Diaphragm	82601200	\$69.25
Clapper Seal	82601500	\$74.25
Cover Gasket	82600300	\$35.25
Nose Pin	82600900	\$32.25
Clapper Spring	82602400	\$23.25
Cap Screw	81611000	\$21.00
Diaphragm Cover	82601300	\$178.00
Retaining Ring	82602500	\$104.00
Clapper	82600700	\$758.50
Diaphragm Piston	82601100	\$167.00

Section 16
Specialty Items

Section 18
Grooved Product

Section 19
CPVC Pipe & Fittings

Section 20
Miscellaneous

Section 21
Electrical

Discontinued Valve Replacement Parts

The following repair parts are applicable to items that have been discontinued and are no longer available. Although the parts are shown in this catalog, TFBP does not guarantee the availability of the items. The parts shown in this section will be sold as long as they are available. TFBP does not have any plans to continue the production of these discontinued parts.

Note: All Items Are Non-Returnable

Model DV-3 Deluge Valve (2007)

<i>Description</i>	<i>Part No.</i>	<i>List Price</i>
Replacement Parts for Model DV-3		
Repair Parts Kit Includes: 1-Diaphragm & 1-Facing	92-445-1-020	\$97.25
Center Valve Assembly Includes: 1-Diaphragm, 1-Diaphragm Ring, 4-Hex Cap Screws, 1-Center Valve, 1-Facing, 1-Facing Retainer & 1-Retainer Screw	92-445-1-021	\$1,127.00
Technical Data Sheet - TFP1350		

Central - Model F & G Alarm Valve (2003)

<i>Description</i>	<i>Flanged x Flanged</i>	<i>Flanged x Grooved</i>	<i>List Price (each)</i>
Replacement Parts for Model "F" & "G" 2½" and 3" Alarm Valves			
Cover Gasket	81303000		\$35.25
Hinge Pin	81610200		\$69.25
Clapper Assembly	81304001		\$529.50
Clapper	81304000		\$347.00
Clapper Bushings (Purchase 2 Units Each)	81608000		\$27.00
Clapper Gasket	81305000		\$127.00
Inner Retaining Washer	25059000		\$51.25
Replacement Parts for Model "F" & "G" 6" Alarm Valves			
<i>Description</i>	<i>Flanged x Flanged</i>	<i>Flanged x Grooved</i>	<i>List Price (each)</i>
Valve Cover	81602000		\$266.00
Cover Gasket	81603000		\$35.25
Clapper Assembly	81604001		\$804.50
Clapper	81604000		\$529.50
Clapper Bushings (Purchase 2 Units Each)	81608000		\$27.00
Clapper Gasket	81605000		\$151.00
Retaining Ring	81606000		\$116.50
Hex Head Cap Screw	81611000		\$21.00
Replacement Parts for Model "F" & "G" 8" Alarm Valves			
Cover Gasket	81803000		\$35.25
Clapper	81804000		\$655.50
Clapper Bushings (Purchase 2 Units Each)	81808000		\$31.25
Clapper Gasket	81805000		\$151.00
Retaining Ring	81806000		\$116.50
Hex Head Cap Screws (Purchase 5 Units Each)	81811000		\$94.00
Technical Data Sheet: Central 7-2.0 (2½", 3"), Central 7-3.0 (4", 6", 8")			

Section 16
Specialty Items

Section 18
Grooved Product

Section 19
CPVC Pipe & Fittings

Section 20
Miscellaneous

Section 21
Electrical

Section 16
Specialty Items

Section 18
Grooved Product

Section 19
CPVC Pipe & Fittings

Section 20
Miscellaneous

Section 21
Electrical

Discontinued Valve Replacement Parts

The following repair parts are applicable to items that have been discontinued and are no longer available. Although the parts are shown in this catalog, TFBP does not guarantee the availability of the items. The parts shown in this section will be sold as long as they are available. TFBP does not have any plans to continue the production of these discontinued parts.

Note: All Items Are Non-Returnable

Model "AF" 2", 2½" and 3" Dry Pipe Valves/Trim (2007)

Part Number	Size/Model	List Price
Replacement Parts for Model "AF" Dry Pipe Valve		
30002000	Valve Cover	\$603.50
60003000	Cover Bolts (Purchase 6 Units Each)	\$12.50
30004000	Cover Gasket	\$88.75
81812000	¾" Pipe Plugs (Purchase 2 Units Each)	\$27.00
81810000	Hinge Pin	\$69.25
20018600	2" & 2½" Clapper Assembly Replacement Kit Including: Clapper, Clapper Bushings (4 Units), Rubber Seal, Retaining Plate, Hex Head Clapper Bolts (4 Units), Latch, Latch Pin, Retaining Rings (2 Units), Latch Spring	\$1,602.00
30018600	3" Clapper Assembly Replacement Kit Including: Clapper, Clapper Bushings (4 Units), Rubber Seal, Retaining Plate, Hex Head Clapper Bolts (5 Units), Latch, Latch Pin, Retaining Rings (2 Units), Latch Spring	\$1,657.00
Technical Data Sheet - Central 10-2.0 (2", 2½"), Central 10-3.2 (3")		

Gem - Model F-302 & F-3021, 4" Dry Pipe Valve Replacement Parts (2002)

Description	Part Number	List Price
Auxiliary Clapper Assembly	52-302-1-103	\$642.50
Repair Parts Kit, Including: Clapper Facing, O-Ring #016, O-Ring #111, Auxiliary Clapper Facing, Auxiliary Clapper Spring, Auxiliary Clapper, Chamber Gasket, Handhole Cover Gasket, 1.5 gms of FS3452	92-302-1-416	\$316.00

Gem - Model F-302 & F-3021, 6" Dry Pipe Valve Replacement Parts (2002)

Description	Part Number	List Price
Auxiliary Clapper Assembly	52-302-1-103	\$642.50
Repair Parts Kit, Including Clapper Facing, O-Ring #016, O-Ring #111, Auxiliary Clapper Facing, Auxiliary Clapper Spring, Auxiliary Clapper Chamber Gasket, Handhole Cover Gasket, 1.5 gms of FS3452	92-302-1-617	\$337.50

Gem - Model A-2, 2" Dry Pipe Valve Replacement Parts (1999)

Description	Part Number	List Price
2" Center Valve Assembly	92-414-1-218	\$2,211.00
Cover O-Ring and Diaphragm Kit	92-414-1-216	\$112.50

See latest Technical Data Sheets for specific Approvals, Listings, Design Parameters & available finishes.

Discontinued Valve Replacement Parts

The following repair parts are applicable to items that have been discontinued and are no longer available. Although the parts are shown in this catalog, TFBP does not guarantee the availability of the items. The parts shown in this section will be sold as long as they are available. TFBP does not have any plans to continue the production of these discontinued parts.

Note: All Items Are Non-Returnable

Model B Deluge Valve (2004)

<i>Description</i>	<i>Part No.</i>	<i>List Price</i>
Replacement Parts for Model "B" Deluge Valve		
Cover	92-020-1-002	\$946.50
Center Valve Assembly	92-020-1-014	\$1,123.00
Guide Rod	92-020-1-005	\$134.50
Priming Supply Res. 1/2" w/.125	92-020-1-009	\$174.50
Repair Parts Kit Includes: 1-Body Gasket, 1-Diaphragm & 1-Facing	92-020-1-116	\$142.50
Technical Data Sheet - Gem TD 117A		

Model DV-1 Deluge Valves (2007)

<i>Description</i>	<i>Part No.</i>	<i>List Price</i>
Replacement Part Kits for the 4" Model DV-1 Deluge Valve		
(a) Repair Parts Kit Includes: 1-Clapper Facing, 1-Diaphragm, 1-Handhole Cover Gasket	92-470-1-101	\$94.00
(b) Clapper Assembly Includes: 1-Clapper, 1-Clapper Facing, 1-Clapper Facing Retainer, 1-Clapper Hex Bolt, 1-Clapper Hinge Pin	92-470-1-103	\$571.00
(c) Reset Plunger Parts Includes: 1-Reset Bushing O-Ring, 1-Reset Bushing, 1-Reset Plunger O-Ring, 1-Reset Plunger, 1-Reset Knob & 1.5 grams Dow Corning FS3452 Fluorosilicone Grease	92-470-1-105	\$161.50
(d) Diaphragm & Latch Parts Kit Includes: 1-Clapper Latch, 1-Diaphragm Housing Hex Bolt, 1-Diaphragm Retainer, 1-Flange/Push Rod Assembly, 1-Diaphragm, 1-Diaphragm Housing & 1-Latch Hinge Pin	92-470-1-106	\$1,134.00
Replacement Part Kits for the 6" Model DV-1 Deluge Valve		
(a) Repair Parts Kit Includes: 1-Clapper Facing, 1-Diaphragm, 1-Handhole Cover Gasket	92-470-1-102	\$101.00
(b) Clapper Assembly Includes: 1-Clapper, 1-Clapper Facing, 1-Clapper Facing Retainer, 1-Clapper Hex Bolt, 1-Clapper Hinge Pin	92-470-1-104	\$634.00
(c) Reset Plunger Parts Includes: 1-Reset Bushing O-Ring, 1-Reset Bushing, 1-Reset Plunger O-Ring, 1-Reset Plunger, 1-Reset Knob & 1.5 grams Dow Corning FS3452 Fluorosilicone Grease	92-470-1-105	\$161.50
(d) Diaphragm & Latch Parts Kit Includes: 1-Clapper Latch, 1-Diaphragm Housing Hex Bolt, 1-Diaphragm Retainer, 1-Flange/Push Rod Assembly, 1-Diaphragm, 1-Diaphragm Housing & 1-Latch Hinge Pin	92-470-1-107	\$1,170.00
Technical Data Sheet - TFP1330		

Section 16
Specialty Items

Section 18
Grooved Product

Section 19
CPVC Pipe & Fittings

Section 20
Miscellaneous

Section 21
Electrical

Discontinued Valve Replacement Parts

The following repair parts are applicable to items that have been discontinued and are no longer available. Although the parts are shown in this catalog, TFBP does not guarantee the availability of the items. The parts shown in this section will be sold as long as they are available. TFBP does not have any plans to continue the production of these discontinued parts.

Note: All Items Are Non-Returnable

Star - Model E Alarm Check Valve - (1999)

Description	Part Number	List Price
Star 8" Model E Check Valve Replacement Parts		
Complete Gasket Kit: Including: Cover Gasket (Face Plate Gasket), Rubber Facing (Diaphragm Gasket)	5809	\$191.00

Star - Model F Alarm Check Valves - (1999)

Description	Part Number	List Price
Star 4" Model F Check Valve Replacement Parts		
Complete Gasket Kit: Including: Cover Gasket (Face Plate Gasket), Rubber Facing (Diaphragm Gasket), Seal Disc	5807	\$76.00
Star 6" Model F Check Valve Replacement Parts		
Complete Gasket Kit: Including: Cover Gasket (Face Plate Gasket), Rubber Facing (Diaphragm Gasket), Seal Disc	5808	\$191.00

Star - Model A-1, Flange x Flange Dry Pipe Valves (2002)

Description	Part Number	List Price
4" Model A-1 Dry Pipe Valve Replacement Parts		
Complete Gasket Kit: Including: Cover Gasket, Clapper Diaphragm, Seat Ring Gasket	1667-4	\$367.00
6" Model A Dry Pipe Valve Replacement Parts		
Complete Gasket Kit: Including: Cover Gasket, Clapper Diaphragm, Seat Ring Gasket	1667-6	\$543.00

Star - Model A-1 Dry Pipe Valves, Flange x Groove (2002)

Description	Part Number	List Price
Star 4" Model A-1 Dry Pipe Valve Replacement Parts		
Complete Kit: Including: Cover Gasket, Clapper Diaphragm, Seat O-Ring (Inner), Seat O-Ring (Outer)	1667-41	\$367.00
Star 6" Model A Dry Pipe Valve Replacement Parts		
Complete Kit: Including: Cover Gasket, Clapper Diaphragm, Seat O-Ring (Inner), Seat O-Ring (Outer)	1667-61	\$543.00

See latest Technical Data Sheets for specific Approvals, Listings, Design Parameters & available finishes.

Discontinued Valve Replacement Parts

The following repair parts are applicable to items that have been discontinued and are no longer available. Although the parts are shown in this catalog, TFBP does not guarantee the availability of the items. The parts shown in this section will be sold as long as they are available. TFBP does not have any plans to continue the production of these discontinued parts.

Note: All Items Are Non-Returnable

Star - Model F and Model G Dry Pipe Valves -(1985)

<i>Description</i>	<i>Part Number</i>	<i>List Price</i>
Star 3" Model F and Model G Dry Pipe Valve Replacement Parts		
Complete Gasket Kit: Including: Cover Gasket, Air Seat Disc, Water Seat Disc, Differential Valve Spring, Housing Gaskets (2 Required), Disc Retaining Ring, Differential Valve Disc, O Ring Seal	5801	\$343.00
Star 4" Model F and Model G Dry Pipe Valve Replacement Parts		
Complete Gasket Kit: Including: Cover Gasket, Air Seat Disc, Water Seat Disc, Differential Valve Spring, Housing Gaskets (2 Required), Disc Retaining Ring, Differential Valve Disc, O Ring Seal	5802	\$405.00
Star 6" Model F and Model G Dry Pipe Valve Replacement Parts		
Complete Gasket Kit: Including: Cover Gasket, Air Seat Disc, Water Seat Disc, Differential Valve Spring, Housing Gaskets (2 Required), Disc Retaining Ring, Differential Valve Disc, O-Ring Seal	5803	\$517.50

Star - Model "A-1" Preaction Valve (2003)

<i>Description</i>	<i>Part Number</i>	<i>List Price</i>
Replacement Parts - (3" Model "A-1" Preaction/ Water Control Valve)		
Complete Gasket Kit: Including: Cover Gasket, Air Seat Disc, Water Seat Disc, Housing Gasket, Disc Retaining Ring, Differential Valve Disc, O Ring Seal	5971	\$292.00
Differential Plunger Spring	5576	\$24.50
Replacement Parts - (4" Model "A-1" Preaction/ Water Control Valve)		
Complete Gasket Kit: Including: Cover Gasket, Air Seat Disc, Water Seat Disc, Housing Gasket, Disc Retaining Ring, Differential Valve Disc, O Ring Seal	5839	\$375.00
Differential Plunger Spring	5576	\$24.50
Replacement Parts - (6" Model "A-1" Preaction/ Water Control Valve)		
Complete Gasket Kit: Including: Cover Gasket, Air Seat Disc, Water Seat Disc, Housing Gasket, Disc Retaining Ring, Differential Valve Disc, O Ring Seal	5972	\$450.50
Differential Plunger Spring	5576	\$24.50

Section 16
Specialty Items
Section 18
Grooved Product
Section 19
CPVC Pipe & Fittings
Section 20
Miscellaneous
Section 21
Electrical

See latest Technical Data Sheets for specific Approvals, Listings, Design Parameters & available finishes.

Discontinued Valve Replacement Parts

The following repair parts are applicable to items that have been discontinued and are no longer available. Although the parts are shown in this catalog, TFBP does not guarantee the availability of the items. The parts shown in this section will be sold as long as they are available. TFBP does not have any plans to continue the production of these discontinued parts.

Note: All Items Are Non-Returnable

Star - Deluge Valve - (Electromatic Model "D") (2002)

Description	Part Number	List Price
Replacement Parts - (3" Electromatic Model D Deluge Valve)		
Complete Gasket Kit: Including: Water Seat Disc, Cover Plate Gasket	5785	\$112.50
Replacement Parts - (6" Electromatic Model D Deluge Valve)		
Complete Gasket Kit: Including: Water Seat Disc, Cover Plate Gasket	5786	\$266.00
Coils - (Electromatic Model D Deluge Valves)		
24 VDC Coil (700 turns, 18 ga. Wire)	5550	\$757.50
125 VDC Coil (2250 turns, 24 ga. Wire)	5550-04	\$757.50
250 VDC Coil (3650 turns, 26 ga. Wire)	5550-05	\$757.50

Exhauster - Model BB (2006)

Description	Part Number	List Price
Replacement Parts - Model BB Exhauster		
Complete Gasket Kit Including: Cover Plate Gasket, Clean-Out Plate Gasket, Upper Valve O Ring, Auxiliary Valve Nozzle Gasket, Auxiliary Valve Clapper Disc, Restriction Tube Holder, O Ring, Restriction Tube Diaphragm, Exhauster Valve Disc, Restriction Tube O Ring	5792-01	\$1,080.00

Technical Data Sheet: Star 2-5.2.10

Model TCV-1, Thermal Control Valves (2006)

Description	Part No.	List Price
1" 165° Model TCV-1	52-010-1-005	\$900.50
1" 212° Model TCV-1	52-010-1-006	\$900.50
1.5" 165° Model TCV-1	52-010-1-001	\$900.50
1.5" 212° Model TCV-1	52-010-1-002	\$900.50

Technical Data Sheet - TFP1345

See latest Technical Data Sheets for specific Approvals, Listings, Design Parameters & available finishes.

Discontinued Sprinkler Accessories

The following repair parts are applicable to items that have been discontinued and are no longer available. Although the parts are shown in this catalog, TFBP does not guarantee the availability of the items. The parts shown in this section will be sold as long as they are available. TFBP does not have any plans to continue the production of these discontinued parts.

Note: All Items Are Non-Returnable

Central - A Royal Flush Concealed Ceiling Plate Assembly (2002)

Description	Part No.	Finish	List Price
135°F or 165°F	833	Brass	\$44.50
135°F or 165°F	831	Chrome	\$44.50
135°F or 165°F	832	White	\$44.50
135°F or 165°F	836	Bright White	\$44.50

Central - Model A Metal Screw-On Escutcheon Assemblies (2002)
A Recessed Escutcheon Assembly - 1/2" NPT

C.O.	Description	Finish	List Price
▶	White	1274	\$16.50

Central - Sprinkler Head Guards and Shields (2002)

Description	Part Number	List Price
Strut		
WSG-2 Upright Water Shield/Guard, Chr 1/2" or 3/4"	1097A	\$15.50
WSG-2 Upright Water Shield/Guard, Red 1/2" or 3/4"	1098A	\$15.50
WS-2 Pendent Water Shield, Red 1/2"	1081A	\$15.50
Bulb		
G-3 Standard Guard, Chr	1480	\$15.50
G-3 Standard Guard, Red	1481	\$15.50
WSG-3 Upright Water Shield/Guard, Red	1484	\$15.50
WS-3 Pendent Water Shield, Red	1487A	\$15.50

Replacement Cover Plate for Gem - F690/F692 & Star Stealth S110/S112 (2002)

Description	Part Number	List Price
White	3101-08	\$42.00

Note: Order 135°F/57°C for 155°F/68°C Sprinklers. Order 165°F/74°C for 200°F/93°C Sprinklers

Gem - Aquarius Escutcheon Plates (2001)

Description	Part Number	List Price
WH-ESC Plate Push-On F991	56-991-0-003	\$10.50
CP-ESC Plate Push-On F991	56-991-9-003	\$10.50

Discontinued Sprinkler Accessories

The following repair parts are applicable to items that have been discontinued and are no longer available. Although the parts are shown in this catalog, TFBP does not guarantee the availability of the items. The parts shown in this section will be sold as long as they are available. TFBP does not have any plans to continue the production of these discontinued parts.

Note: All Items Are Non-Returnable

Star - Starmist Escutcheons (2002)

Part Number	Description	List Price
Recessed Starmist Escutcheons, 3/4" NPT (Order Separately)		
1954-02	Chrome	\$7.50
1954-04	White	\$7.50
Recessed Starmist Escutcheons, 1/2" NPT (Order Separately)		
2954-02	Chrome	\$7.50

TFP PH2, K=5.6, Institutional Pendent, Standard Response Sprinkler (2005)

50 Box Quantity (33 lbs/box) (SIN TY3290)

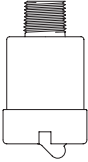
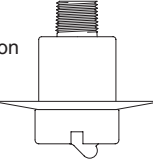
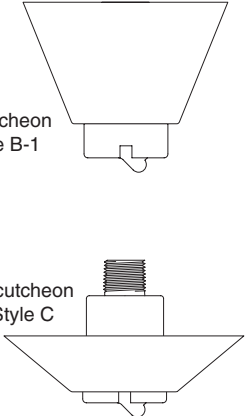
	C.O.	Pendent	Finish	Temperature	Price
	▶	51-104-9-135	Chrome	140°F/60°C	\$47.25
		51-104-9-165	Chrome	165°F/74°C	\$47.25
		51-104-9-212	Chrome	212°F/100°C	\$47.25
Order Escutcheon Separately					
		56-012-7-622	Type A, Chrome		\$16.50
		56-001-7-511	Type B-1, Chrome		\$16.50
		56-001-7-513	Type C, Chrome		\$16.50
Accessories					
		56-000-1-781	Centering Grommet – Model 1781		\$2.40
		56-000-1-780	Retaining Flange – Model 1780		\$29.50
		56-000-1-752	Spacers		\$0.30
Sprinkler Wrench					
		56-001-5-093	Model 1509-3		\$119.50
					
					

Technical Data Sheet: TFP650

See latest Technical Data Sheets for specific Approvals, Listings, Design Parameters & available finishes.

Discontinued Sprinkler Accessories

The following repair parts are applicable to items that have been discontinued and are no longer available. Although the parts are shown in this catalog, TFBP does not guarantee the availability of the items. The parts shown in this section will be sold as long as they are available. TFBP does not have any plans to continue the production of these discontinued parts.

Note: All Items Are Non-Returnable

TFP PH5, K=5.6, Institutional Horizontal Sidewall, Standard Response Sprinkler (2005)

50 Box Quantity (33 lbs/box) (SIN TY3390)

	<i>C.O.</i>	<i>Horizontal Sidewall</i>	<i>Finish</i>	<i>Temperature</i>	<i>Price</i>
		51-106-9-135	Chrome	140°F/60°C	\$52.00
Order Escutcheon Separately					
		56-001-7-512	Type B-2		\$16.50
		56-001-7-513	Type C, Chrome		\$16.50
Accessories					
		56-000-1-781	Centering Grommet – Model 1781		\$2.40
		56-000-1-780	Retaining Flange – Model 1780		\$29.50
		56-000-1-752	Spacers		\$0.30
Sprinkler Wrench					
		56-001-5-093	Model 1509-3		\$119.50

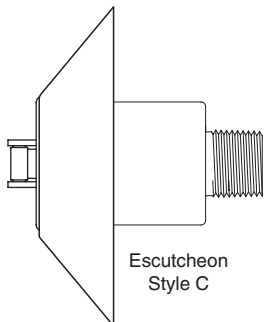
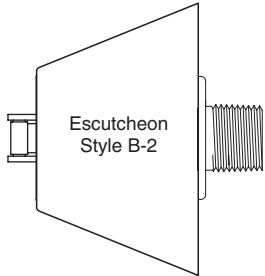
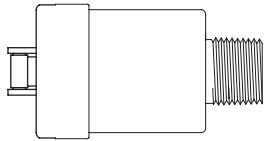

Technical Data Sheet: TFP654

Section 16
Specialty Items

Section 18
Grooved Product

Section 19
CPVC Pipe & Fittings

Section 20
Miscellaneous

Section 21
Electrical

Discontinued Sprinklers

The following repair parts are applicable to items that have been discontinued and are no longer available. Although the parts are shown in this catalog, TFBP does not guarantee the availability of the items. The parts shown in this section will be sold as long as they are available. TFBP does not have any plans to continue the production of these discontinued parts.

Note: All Items Are Non-Returnable

Section 16
Specialty Items

Section 18
Grooved Product

Section 19
CPVC Pipe & Fittings

Section 20
Miscellaneous

Section 21
Electrical

Potter Electric		
<i>Description</i>	<i>Part Number</i>	<i>List Price</i>
Waterflow Switches		
VS-SP 1"-1½" WFD(without retard)	2447	\$190.50
VSR-S 1"-2" WFS	24148	\$215.00
VSR-SG	26144	\$252.00
VSR-ST	26145	\$252.00
VSR-F 2" WFD	24110	\$225.00
VSR-F 2½" WFD	24111	\$225.00
VSR-F 3" WFD	24112	\$225.00
VSR-F 3 ½" WFD	24113	\$225.00
VSR-F 4" WFD	24114	\$225.00
VSR-F 5" WFD	24115	\$225.00
VSR-F 6" WFD	24116	\$225.00
VSR-F 8" WFD	24117	\$254.00
Tamper Switches - OS&Y		
OSYSU-1	2414	\$140.00
OSYSU-2	2412	\$162.00
PTS-C (Plug type)	24100	\$281.00
RBVS Retrofit Ball Valve Switch less Tamper	24882	\$260.00
RBVS Retrofit Ball Valve Switch with Tamper	24883	\$281.00
Tamper Switches - Butterfly/PIV		
PCVS-2 Sets DPDT	2419	\$141.00
Pressure Switches		
PS10-1	25700	\$167.00
PS10-2	25710	\$175.00
PS40-1	25720	\$167.00
PS40-2	25730	\$175.00
Explosion Proof Switches		
VSRF-EX 2"	2489	\$2,875.00
VSRF-EX 2½"	2426	\$2,875.00
VSRF-EX 3"	2396	\$2,875.00
VSRF-EX 4"	2472	\$2,875.00
VSRF-EX 6"	2477	\$2,875.00
VSRF-EX 8"	2478	\$3,111.00
PS10-2A-EX	2471	\$856.00
PS40-2A-EX	2473	\$856.00
OSYSU-EX	2486	\$1,005.00
PIVSU-EX	2487	\$1,005.00
Switches for Copper Systems		
2" VSR-CF	2458	\$362.00
2½" VSR-CF	2459	\$362.00
3" VSR-CF	2394	\$362.00
4" VSR-CF	2484	\$362.00
Electric Bells - 120 Volts A.C.		
6" 120 Volts A.C.	2440	\$56.00
8" 120 Volts A.C.	2441	\$73.50
10" 120 Volts A.C.	2442	\$84.00
Electric Bells - 24 Volts A.C.		
6" 24 Volts A.C.	2387	\$56.00
10" 24 Volts A.C.	2382	\$84.00

Potter Electric		
<i>Description</i>	<i>Part Number</i>	<i>List Price</i>
Weatherproof Back Box		
Weather-proof Back Box	2443	\$30.00
Electric Bells - 12 Volts D.C.		
6" 12 Volts D.C.	2428	\$56.00
10" 12 Volts D.C.	2445	\$84.00
Electric Bells - 24 Volts D.C.		
6" 24 Volts D.C.	2446	\$56.00
10" 24 Volts D.C.	2444	\$84.00
Horns		
120 VAC Strobe Horn, 6117-L	2373	\$185.00
120 VAC, 60 Hz Horn 31T-115-R	2587	\$78.75
Outdoor Back (Box WBB-R); 4	2374	\$26.00
MH-120R 120VAC Mini-Horn Red	25870	\$60.00
MH-120W 120VAC Mini-Horn White	25880	\$60.00
Release Panel		
PFC 4410RC Red	20135	\$1,552.50
PFC 4410RC White	21126	\$1,552.50
Batteries for Release Panel		
8.0 Amp Hour Batteries BT-80	2656	\$58.75
12.0 Amp Hour Batteries BT-120	20128	\$110.50
Corrosion Inhibiting Device		
PAAR (Potter Automatic Air Release)	25100	\$1,799.00
Corrosion Monitoring Station		
PCMS-2510 2½ Schedule 10 Pipe	29500	\$1,824.00
PCMS-2540 2½ Schedule 40 Pipe	29505	\$1,896.00
PCMS-3010 3" Schedule 10 Pipe	29510	\$1,867.00
PCMS-3040 3" Schedule 40 Pipe	29515	\$1,981.00
PCMS-4010 4" Schedule 10 Pipe	29520	\$1,981.00
PCMS-4040 4" Schedule 40 Pipe	29525	\$2,121.00

Solenoid Valves		
<i>Description</i>	<i>Part Number</i>	<i>List Price</i>
Ordinary Location		
½" Solenoid Valve 110 VAC	52-287-1-110	\$646.00
½" Solenoid Valve 24 VDC	52-287-1-024	\$862.50
½" Solenoid Valve 125 VDC	52-287-1-125	\$640.00
Hazardous Location		
½" Explosion-proof Solenoid Valve 110 VAC	52-287-1-210	\$772.00
½" Explosion-proof Solenoid Valve 24 VDC	52-287-1-224	\$772.00

Section 16
Specialty Items

Section 18
Grooved Product

Section 19
CPVC Pipe & Fittings

Section 20
Miscellaneous

Section 21
Electrical

See latest Technical Data Sheets for specific Approvals, Listings, Design Parameters & available finishes.

Section 16
Specialty Items

Section 18
Grooved Product

Section 19
CPVC Pipe & Fittings

Section 20
Miscellaneous

Section 21
Electrical

Potter Heat Detectors		
Description	Part Number	List Price
CR-135W Heat Detector	26580	\$26.75
CR-200W Heat Detector	26590	\$26.75
CF-135W Heat Detector	26600	\$26.75
CF-200W Heat Detector	26610	\$26.75

Horn Strobes		
Description	Part Number	List Price
12V/DC Horn Strobe	2344	\$166.00
120V/AC Horn Strobe	2373	\$185.00
120V/AC Red Mini-Horn Strobe	25870	\$60.00
24V/DC White Mini-Horn Strobe	25880	\$60.00

General Air Products		
Description	Part Number	List Price
Air Compressors: Base Mount – Single Phase		
L200-33-A	50024	\$1,322.00
L290-50-A	50232	\$1,370.00
L365-75-A	50233	\$1,474.00
L425-100-A	50027	\$1,513.00
L620-100-A	50234	\$1,776.00
L900-150-A	50235	\$1,837.00
L1300-300-A	60232	\$2,125.00
L1600-300-A	60234	\$3,345.00
L2000-500-A	60027	\$3,743.00
L2500-500-A	50238	\$4,019.00
Air Compressors: Base Mount – Three Phase		
L200-33-B	50034	\$1,309.00
L290-50-B	50237	\$1,360.00
L365-75-B	50036	\$1,409.00
L425-100-B	50037	\$1,430.00
L620-100-B	50038	\$1,665.00
L900-150-B	50239	\$1,717.00
L1300-300-B	60233	\$1,958.00
L1600-300-B	60235	\$3,195.00
L2000-500-B	60028	\$3,444.00
L2500-500-B	50043	\$3,564.00
Air Compressors: Riser Mounted Oil-Less (Includes Stop - Start)		
OL110-16AC (110 Gallon)	60001	\$1,066.00
OL215-33AC (215 Gallon)	60002	\$1,364.00
OL335-50AC (335 Gallon)	60003	\$1,676.00
OL425V-75AC (425 Gallon)	60004	\$1,869.00
OL610V-100AC (610 Gallon)	60281	\$2,098.00
OL900-150AC (900 Gallon)	60282	\$3,301.00
OL1200V-200AC (1,200 Gallon)	60283	\$3,604.00
Air Compressors: Tank Mounted Oil-Less (Includes Stop - Start)		
OL110-16ACT	60236	\$1,920.00
OL215-33ACT	60237	\$2,220.00
OL335-50ACT	60238	\$2,596.00
OL425V-75ACT	60239	\$2,803.00
OL610V-100ACT	60285	\$3,160.00
OL900-150ACT	60287	\$4,442.00
OL-1200V-200ACT	60288	\$4,788.00
Air Compressors: Tank Mounted Single Phase (Includes Stop - Start)		
LT200-33-A	50047	\$2,238.00
LT290-50-A	50251	\$2,265.00
LT365-75-A	50252	\$2,316.00
LT425-100-A	50050	\$2,347.00
LT620-100-A	50253	\$2,690.00
LT900-150-A	50254	\$2,799.00
LT1300-300-A	60251	\$3,045.00
LT1600-300-A	60253	\$4,747.00
LT2000-500-A	60029	\$4,934.00
LT-2500-500-A	50056	\$5,164.00

See latest Technical Data Sheets for specific Approvals, Listings, Design Parameters & available finishes.

General Air Products		
Description	Part Number	List Price
Air Compressors: Tank Mounted Three Phase (Includes Stop - Start)		
LT200-33-B	50057	\$2,305.00
LT290-50-B	50258	\$2,316.00
LT365-75-B	50059	\$2,329.00
LT425-100-B	50060	\$2,336.00
LT620-100-B	50259	\$2,651.00
LT900-150-B	50260	\$2,728.00
LT1300-300-B	60252	\$2,811.00
LT1600-300-B	60254	\$4,561.00
LT2000-500-B	60038	\$4,624.00
LT2500-500-B	50261	\$4,821.00
Magnetic Line Starter - Single Phase (Need HP and Voltage to Order)		
MG00A	50084	\$460.00
MGX0A	50086	\$516.00
MG01A	50085	\$587.00
MG15A	50092	\$754.00
Magnetic Line Starter - Three Phase (Need HP and Voltage to Order)		
MG00B	50075	\$511.00
MGX0B	50093	\$615.00
MG01B	50094	\$691.00
Riser Mount Kits - Universal Bracket		
RMK 16150	50082	\$84.00
Dry Air Pacs - F.O.B. Factory Direct (Need Voltage to Order)		
DAP500A	50264	\$16,100.00
DAP500B	50265	\$15,900.00

General Air Products		
DAP1000B	50267	\$17,300.00
DAP2000B	50269	\$18,600.00
Dry Air Pacs - Maintenance Kits F.O.B. Factory Direct (Need Voltage to Order)		
KSMB01	60243	\$305.00
KAMA01	60244	\$823.00
Accessories		
AD3400 Desiccant Dryer	50076	\$518.00
34006 Desiccant Replacement	60010	\$140.00
F3500 Coalescing Filter	50077	\$326.00
Vibration Pad (4 Pack)	50078	\$117.00
SWP60302 Pressure Switch	60245	\$175.00
DVA-2T Electric Drain Valve	60246	\$379.00
P1202MP Flex Hose	60247	\$132.00
VR3P25080 Relief Valve	60248	\$80.00
APC01Q Air Comp. Oil	60249	\$9.80



Section 16
Specialty Items

Section 18
Grooved Product

Section 19
CPVC Pipe & Fittings

Section 20
Miscellaneous

Section 21
Electrical

Thermocable LHD - Linear Heat Detection Wire PVC Jacket (Vinyl)					
Description	Part Number	List Price			
		100 -499 ft	500-4,999 ft	5,000-9,999	10,000
155°F / 68°C Red	TC155	\$3.12/ft	\$3.00/ft	\$2.88/ft	\$2.64/ft
155°F / 68°C Red with GuideWire*	TC155G	\$3.48/ft	\$3.36/ft	\$3.24/ft	\$3.00/ft
172°F / 78°C Red	TC172	\$3.12/ft	\$3.00/ft	\$2.88/ft	\$2.64/ft
172°F / 78°C Red with GuideWire*	TC172G	\$3.48/ft	\$3.36/ft	\$3.24/ft	\$3.00/ft
Notes:					
*GuideWire should be installed using eyebolts for support every 15 feet (4.5m) to 20 feet (6.0m). ThermoCable with GuideWire is only available in 500' spool lengths.					

Mounting Straps Temperatures -40°F to 185°F (-40°C to 85°C)			
Description	Part Number	List Price	Qty.
Single Loop	TC1018C	\$120.00	pack (100)
For use with Surface Mount TC1017C	TC1018M	\$840.00	pack (1000)

See latest Technical Data Sheets for specific Approvals, Listings, Design Parameters & available finishes.

Section 16
Specialty Items

Section 18
Grooved Product

Section 19
CPVC Pipe & Fittings

Section 20
Miscellaneous

Section 21
Electrical

Mounting Straps Temperatures -40°F to 185°F (-40°C to 85°C)			
Single Loop , Fits 4" to 6" (10cm to 15cm) Sprinkler Pipe	TC1029L	\$150.00	pack (50)
Double Loop , Fits 3/4" to 2" (2cm to 5cm) Sprinkler Pipe	TC1027C	\$144.00	pack (100)
	TC1027M	\$900.00	pack (1000)
Double Loop , Fits 2-1/2" to 3-1/2" (6cm to 8.9cm) Sprinkler Pipe	TC1028M	\$1,200.00	pack (1000)
Notes:			
ThermoCable must be secured every 3 to 5 feet (1 to 1.5m), or 15 to 20 feet (4.5 to 6m) for installations using GuideWire			

Mounting Clips and Clamps Temperatures -40°F to 185°F (-40°C to 85°C)			
<i>Description</i>	<i>Part Number</i>	<i>List Price</i>	<i>Qty.</i>
Cable Clip, Nylon 6.6 -3/16" (4.8mm) mounting hole	TC1012C	\$96.00	pack(100)
	TC1012M	\$720.00	pack(1000)
Push Pin -Secures through 3/16" (4.8mm) mounting hole Secures Cable Clip TC1012 to Beam Clamps and Cable Tray Mounting Clips	TC1034Q	\$30.00	pack(25)
Cable Clip, Zinc Plated , 1/4"± (6.4mm) mounting hole	TC1013C	\$30.00	pack(100)
Beam Clamp, Spring Steel Designed for material thickness up to 1/2" (12.7mm) TC1012 Cable Clip and TC1030 Push Pin required for installation	TC1014C	\$300.00	pack(100)
Beam Clamp, Zinc Plated Steel Designed for material thickness up to 7/8" (22mm) TC1012 Cable Clip and TC1030 Push Pin required for installation	TC1015L	\$180.00	pack(50)
L-Bracket Designed for floating roof tank applications TC1012 Cable Clip and TC1030 Push Pin required for installation	TC1016	\$8.40	each
Cable Tray Mounting Clip , For mounting to 3/16" (4.8mm) thick material	TC1020C	\$228.00	pack(100)
Cable Tray Mounting Clip For material thickness of 1/16" to 5/32" (1.6mm to 4mm) For material thickness of 5/32" to 1/4" (4mm to 6.4mm) TC1012 Cable Clip and TC1030 Push Pin required for installation	TC1021C	\$240.00	pack(100)
	TC1022C	\$240.00	pack(100)
Universal Mounting Clip For material thickness 1/8" to 1/4" thick (3.2mm to 6.4mm) For material thickness 5/16" to 1/2" thick (7.9mm to 12.7mm) TC1012 Cable Clip and TC1030 Push Pin required for installation	TC1023C	\$300.00	pack(100)
	TC1024C	\$300.00	pack(100)

GuideWire Mounting Accessories			
<i>Description</i>	<i>Part Number</i>	<i>List Price</i>	<i>Qty.</i>
Threaded Eyebolt - Zinc Plated Steel , 1/4"-20, with one nut (6.4mm) Use to support ThermoCable every 15 to 20 feet (4.5m to 6m) -250 ft. maximum TC1031ZC Lock Nut and TC1032C Insulated Grommet required for installation	TC1030ZX	\$24.00	pack(10)
Zinc Plated Lock Nut	TC1031ZC	\$18.00	pack(100)
Threaded Eyebolt - Stainless Steel , 1/4" -20 with one nut (6.4mm) Use to support ThermoCable every 15 to 20 feet (4.5m to 6m) -250 ft. maximum TC1031SSC Lock Nut and TC1032C Insulated Grommet required for installation	TC1030SS	\$6.00	each

See latest Technical Data Sheets for specific Approvals, Listings, Design Parameters & available finishes.

GuideWire Mounting Accessories			
Stainless Steel Lock Nut	TC1031SSC	\$48.00	pack(100)
Insulating Grommet , Black Rubber	TC1032C	\$38.40	pack(100)
Turnbuckle - Zinc For GuideWire installations	TC1033Z	\$6.60	each
Turnbuckle - Stainless Steel (Aluminum Body) For GuideWire installations	TC1033SS	\$14.40	each

Surface Mounting			
<i>DESCRIPTION</i>	<i>Part Number</i>	<i>List Price</i>	<i>Qty.</i>
Surface Mount For use with TC1018 Cable Tie and TC1019 Adhesive	TC1017C	\$120.00	pack(100)
Surface Mount Adhesive For use with Surface Mount TC1017C	TC1019	\$24.00	each

Installation			
<i>DESCRIPTION</i>	<i>Part Number</i>	<i>List Price</i>	<i>Qty.</i>
Spare Installation Spool, 500' (150m)	TC1100S	\$14.40	each
Spare Installation Spool, 1500' (450m)	TC1100L	\$18.00	each
Cable Dispensing Reel	TC1011	\$240.00	each

Cable Connecting Accessories			
<i>DESCRIPTION</i>	<i>Part Number</i>	<i>List Price</i>	<i>Qty.</i>
J -Box / ELR -Box , Dim. 4" x 4" x 2" (10cm x 10cm x 5cm) NEMA 4X Moisture Proof Standard Junction Box End of line resistor supplied with panel by manufacturer Requires Screw Terminal (TC1005X)	TC1000	\$36.00	each
HDJ -Box / HDELR -Box , Dim. 6" x 6" x 4" (15cm x 15cm x 10cm) NEMA 4X Moisture Proof Heavy Duty Junction Box End of line resistor supplied with panel by manufacturer Requires Screw Terminal (TC1005X)	TC1002	\$168.00	each
Screw Terminal , 2 Point, Must be used for all connections in TC1000 and TC1002	TC1005X	\$14.40	pack (10)
Backplate -Fits HDJ-Box / HDELR-Box For mounting Test Switch and Screw Terminal.	TC1003	\$24.00	each
Test Switch -Attaches to Backplate (TC1003) in HDJ-Box/HDELR-Box (TC1002) For end of line testing of linear heat detection systems.	TC1004	\$18.00	each
Cable Strain Relief Connector Required for securing ThermoCable penetrations through wall of J-Box/ELR-Box and HDJ-Box/HDELR-Box.	TC100	\$12.00	each

Section 16
Specialty Items

Section 18
Grooved Product

Section 19
CPVC Pipe & Fittings

Section 20
Miscellaneous

Section 21
Electrical

Cable Splicing Accessories

DESCRIPTION	Part Number	List Price	Qty.
Screw Terminal, 2 Point, Must be used for all splices	TC1005X	\$14.40	pack (10)
Sealant Tape, Must be used for all splices	TC1006	\$21.60	Roll
Splicing Tape, White	TC1007	\$12.00	Roll
Splicing Tape, Red	TC1008	\$12.00	Roll
Splicing Tape, Blue	TC1009	\$12.00	Roll
Low Temperature Splicing Tape, Black	TC1010	\$12.00	Roll

Fire Alarm Control / Releasing Panel - Modules

DESCRIPTION	Part Number	List Price	Qty.
Class A Initiating Device Module	TC4402	\$60.00	each
Converts 2 Class B Initiating Circuits to 2 Class A Initiating Circuits			
Class A Indicating Appliance Circuit Module	TC4401	\$132.00	each
Converts 1 Class B Annunciating Circuit to 1 Class A Annunciating Circuits			
Auxiliary Relay Module (24 VDC, DPST)	TC4403	\$162.00	each
Auxiliary Relay Module (24 VDC, DPDT)	TC4404	\$216.00	each
Intrinsic Safety Barrier , Special Hazard Applications 1 per Zone, 35mm DIN Rail Mounting	TC4406	\$696.00	each

Section 16
Specialty Items

Section 18
Grooved Product

Section 19
CPVC Pipe & Fittings

Section 20
Miscellaneous

Section 21
Electrical

See latest Technical Data Sheets for specific Approvals, Listings, Design Parameters & available finishes.

Price Book - Section C Valves and Hose Equipment

Kennedy Valves		
Description	Part Number	List Price
O.S.&Y. Gate Valve UL/FM Resilient Wedge w/ 3/4" Tap and Plug - Model #4068A		
2 1/2"	2265	\$637.00
3"	2266	\$736.00
4"	2267	\$854.00
6"	2269	\$1,243.00
8"	2268	\$2,040.00
10"	2264	\$3,338.00
12"	2259	\$4,321.00
O.S.&Y. Valve Flanged x Grooved - Model #7092A		
2 1/2"	22650	\$637.00
3"	22660	\$736.00
4"	22670	\$854.00
6"	22690	\$1,243.00
8"	22680	\$2,040.00
Grooved Check Valve - Model #426		
2 1/2"	21215	\$570.00
3"	21216	\$626.00
4"	21218	\$763.00
6"	21217	\$1,116.00
8"	20592	\$1,541.00
Iron Body Swing Check Valves UL/FM Flanged 175 PSI - Model 126A		
2 1/2"	21221	\$962.00
3"	21223	\$1,085.00
4"	21224	\$1,441.00
6"	21226	\$2,303.00
8"	21227	\$3,837.00
10"	21228	\$6,328.00
12"	21229	\$9,081.00
Wafer Check Valves UL/FM 300 PSI - Model 706		
4"	21000	\$553.00
6"	21020	\$954.00
8"	21040	\$1,599.00
Flanged PIV Non Rising Stem Gate Valve Resilient Wedge - Model 4701		
4"	20504	\$714.00
6"	20506	\$1,113.00
8"	20508	\$1,808.00
10"	20509	\$3,075.00
#01G - Grooved BFV		
2 1/2"	322260	\$602.00
3"	322310	\$645.00
4"	322410	\$688.00
6"	322610	\$1,032.00
8"	322810	\$1,504.00
#01G - Wafer BFV		
2 1/2"	322110	\$565.00
3"	322130	\$625.00
4"	322140	\$695.00
6"	322160	\$914.00
8"	322180	\$1,347.00

Kennedy Valves		
Description	Part Number	List Price
PIV, NRS Gate Valve UL/FM Mechanical Joint w/Accessories Resilient Wedge - Model 4071		
4"	20514	\$782.00
6"	20516	\$1,151.00
8"	20518	\$1,934.00
10"	20520	\$3,128.00
12"	20521	\$5,154.00
Wall Post Indicator Model 641-13 Includes Stem and Coupling		
Wall Post Indicator	20810	\$890.00
Wall Post Handwheel	20809	\$386.00
Vertical Post Indicator (Formerly Model #741)		
Model #2945B	20811	\$1,379.00
Model #2945C	20820	\$1,379.00
P.I. Wrench	20510	\$167.00

Babbitt Valve Chainwheels				
Cast Iron Standard Chainwheel				
Item No.	Size	Part Number	List Price	
0	2" to 4"	5036	\$146.00	
1	4 1/4" to 5 3/4"	5037	\$213.00	
1.5	6" to 7 1/2"	5031	\$258.00	
2	7 3/4" to 9"	5038	\$342.00	
2.5	9 1/4" to 12 1/2"	5039	\$492.00	
3	12 3/4" to 15 1/2"	5040	\$568.00	
3.5	15 3/4" to 19"	5041A	\$862.00	
4	19 1/4" to 22"	5042	\$1,160.00	
4.5	22 1/2" to 26"	5043	\$1,685.00	
5	26 1/4" to 30"	5044	\$1,983.00	
Epoxy Coated Corrosion Resistant Chainwheel				
0	2" to 4"	5025	\$311.00	
1	4 1/4" to 5 3/4"	5026	\$507.00	
1.5	6" to 7 1/2"	5027	\$653.00	
2	7 3/4" to 9"	5028	\$800.00	
2.5	9 1/4" to 12 1/2"	5033	\$1,035.00	
3	12 3/4" to 15 1/2"	5034	\$1,276.00	
3.5	15 3/4" to 19"	5035	\$1,571.00	
Hot Dipped Galvanized Standard Chain				
Item No.	Chain Trade Size	Chain Operator Number	Part Number	List Price
0	#2	#0	5029	\$2.78
1 to 2	#1/0	#1, 1 1/2, 2	5030	\$3.99
2.5 to 3.5	#4/0	#2 1/2, 3, 3 1/2	5032	\$5.30

Section C
Valves and Hose Equipment

Section D
Backflow

Section F
Pipe & Accessories

Section H
Hangers

Section J
Lubricants

Section K
Misc.

See latest Technical Data Sheets for specific Approvals, Listings, Design Parameters & available finishes. Sprinkler heads & escutcheons are priced separately unless otherwise noted. Items marked "C.O." are made to order and may require longer delivery times.

Section C Valves and Hose Equipment	United Brass Bronze Valves		
	Description	Part Number	List Price
Section C Valves and Hose Equipment	Globe Valves		
	3-Way 1/4"	2228	\$18.00
	1/2" Globe	2222	\$26.85
	3/4" Globe	2223	\$33.65
	1" Globe	2224	\$45.05
	1 1/4" Globe	2225	\$71.85
	1 1/2" Globe	2226	\$103.00
Section D Backflow	2" Globe	2227	\$148.00
	Swing Checks		
Section F Pipe & Accessories	1/2"	2240	\$29.95
	3/4"	2241	\$33.75
	1"	2242	\$46.45
	1 1/4"	2243	\$65.90
	1 1/2"	2244	\$95.70
	2"	2245	\$112.35
Section H Hangers	Ball Valves		
	1/2"	2280	\$30.85
	3/4"	2281	\$46.70
	1"	2284	\$59.75
	1 1/4"	2296	\$96.75
Section J Lubricants	1 1/2"	2276	\$122.35
	2"	2262	\$161.70
	Angle Valves		
Section K Misc.	1/2"	2202	\$27.55
	3/4"	2203A	\$31.45
	1"	2204A	\$47.05
	1 1/4"	2205A	\$77.05
	1 1/2"	2206A	\$104.60
	2"	2207	\$125.75
OS&Y Valves			
1"	2272	\$202.20	
1 1/4"	2273	\$231.10	
1 1/2"	2274	\$299.60	
2"	2275	\$391.60	

Milwaukee Butterball Valves		
Description	Part Number	List Price
Valve with two (2) tamper switches		
1" BBSCS02	51009	\$303.00
1 1/4" BBSCS02	51010	\$320.00
1 1/2" BBSCS02	51011	\$385.00
2" BBSCS02	51012	\$463.00
2" BBVSCS02 Grooved	51021	\$497.00
2 1/2" BBSCS02	51013	\$618.00
2 1/2" BBVSCS02 Grooved	51018	\$635.00
Supervisory Switch Kit (2) Circuits	51015	\$162.00
Valve only		
1" BBSC100	51008	\$249.00
1 1/4" BBSC100	51006	\$269.00
1 1/2" BBSC100	51004	\$342.00
2" BBSC100	51002	\$430.00
2" BBVSC100 Grooved	51019	\$465.00
2 1/2" BBSC100	50999	\$592.00
2 1/2" BBVSC100 Grooved	51016	\$617.00

Trim Valves		
Description	Part Number	List Price
Globe Valves		
3-Way 1/4"	41320	\$12.60
1/2" Globe	41321	\$16.80
3/4" Globe	41322	\$20.75
1" Globe	41323	\$27.85
1 1/4" Globe	41324	\$48.90
1 1/2" Globe	41325	\$67.95
2" Globe	41326	\$103.00
Swing Checks		
1/2"	41333	\$20.70
3/4"	41334	\$28.35
1"	41335	\$44.55
1 1/4"	41336	\$59.40
1 1/2"	41337	\$85.35
2"	41338	\$105.25
Ball Valves		
1/2"	41302	\$10.50
3/4"	41303	\$16.15
1"	41304	\$24.15
1 1/4"	41305	\$42.40
1 1/2"	41306	\$56.20
2"	41307	\$79.10
Angle Valves		
1/2"	41327	\$21.00
3/4"	41328	\$25.20
1"	41329	\$43.80
1 1/4"	41330	\$63.15
1 1/2"	41331	\$80.85
2"	41332	\$113.10

*See latest Technical Data Sheets for specific Approvals, Listings, Design Parameters & available finishes. Sprinkler heads & escutcheons are priced separately unless otherwise noted. Items marked "C.O." are made to order and may require longer delivery times.

Price Book - Section C Valves and Hose Equipment

Hose Valves & FDC's		
Description	Part Number	List Price
Hose Valves		
1½" FT X FT Angle	22450	\$101.00
1½" FT X MT Angle	22460	\$101.00
2½" FT X FT Angle	22451	\$196.00
2½" FT X MT Angle	22461	\$196.00
1½" Cap with Brass Chain	41205	\$17.30
2½" Cap with Brass Chain	41204	\$26.45
2½"x1½" Brass Reducing Adapter	41206	\$31.00
STORZ Equipment		
STORZ 4" x 4" Straight FDC (import)	61232	\$165.30
STORZ 4" x 5" Straight FDC (import)	61242	\$293.00
STORZ 4" x 4" w/ 30-degree Elbow (import)	61233	\$293.00
STORZ 4" x 5" w/ 30-degree Elbow (import)	61243	\$338.00
STORZ 4" Cap with Chain (import)	61234	\$167.00
STORZ 5" Cap with Chain (import)	61244	\$232.00
STORZ 4"-6" Wrench (import)	61262	\$95.70
STORZ 4" x 4" Straight Connection Kit (import)	61231	\$466.00
STORZ 4" x 5" Straight Connection Kit (import)	61241	\$551.00
STORZ 4" x 4" 30-degree Connection Kit (import)	61251	\$563.00
STORZ 4" x 5" 30-degree Connection Kit (import)	61261	\$627.00
Fire Department Connections		
Fire Dept (Alum.) Sign Round	2503	\$13.75
Fire Dept (Alum.) Sign Rect. 8" x 4" (straight) 4" x 2½"	22441	\$15.75
(90° Angle) 4" x 2½"	2501	\$178.25
Red Plastic Caps w/ Bolt & Nut (pair)	2505	\$194.25
Aluminum Caps w/ Bolt & Nut (pair)	2502A	\$4.60
	2504	\$9.35
Residential Fire Dept Connections		
1½" Residential Fire Dept Connection	2509	\$75.90
Crocker Standpipe and Hose Equipment		
Description	Part Number	List Price
Hose Rack Units		
#3007 1½" x 75' Less Nozzle	51280	\$433.00
#3010 1½" x 100' Less Nozzle	51290	\$483.00
#3207 2½" x 75' Less Nozzle	51300	\$795.00
#3210 2½" x 100' Less Nozzle	51310	\$872.00
Adjustable Fog Nozzles		
#3478 1½" Polycarbonate	2746	\$29.40
#3460 1½" Brass	2745	\$69.00
#3464 2½" Brass	27450	\$236.00

Crocker Standpipe and Hose Equipment		
Description	Part Number	List Price
Fire Hose		
#3401, 1½" 500 PSI Rack Hose Coupled		
50'	27611	\$163.00
75'	2761	\$205.00
100'	2760	\$252.00
#3405, 1½" 300 PSI Single Jacket Coupled		
50'	27600	\$215.00
75'	27610	\$299.00
100'	27620	\$388.00
#3406, 2½" 300 PSI Single Jacket Coupled		
50'	27630	\$388.00
75'	27640	\$577.00
100'	27650	\$724.00
#3420, 1½" 400 PSI Double Jacket Coupled		
50'	27660	\$362.00
75'	27670	\$519.00
100'	27680	\$674.00
#3421, 2½" 400 PSI Double Jacket Coupled		
50'	27690	\$573.00
75'	27700	\$859.00
100'	27710	\$1,117.00
Fire Hose Reel		P.O.A.
Hose Valves		
#5290 1" x 1½" Angle Valve, Male x Male	27900	\$162.75
#5020 1½" Angle Valve, Female x Female	27910	\$100.00
#5010 1½" Angle Valve, Female x Male	27920	\$100.00
#5025 2½" Angle Valve, Female x Female	27930	\$176.00
#5015 2½" Angle Valve, Female x Male	27940	\$323.00
#5709 1½" Cap & Chain	27550	\$15.75
#5713 2½" Cap & Chain	27560	\$21.00
#7245 2½" Female x 1½" Male Reducer	2755	\$33.60
Pressure Restricting Hose Valves		
#5060 1½" Angle, Female x Female	27950	\$173.00
#5050 1½" Angle, Female x Male	27960	\$173.00
#5062 2½" Angle, Female x Female	27970	\$367.00
#5055 2½" Angle, Female x Male	27980	\$367.00
Pressure Regulating Hose Valves (Factory Set)		
#5550 1½" Angle, Female x Female	28000	\$756.00
#5560 1½" Angle, Female x Male	28010	\$756.00
#5570 2½" Angle, Female x Female	28020	\$892.00
#5580 2½" Angle, Female x Male	28030	\$892.00
#5590 2½" In-l22ine, Female x Female	28040	\$892.00
Tampor Switch Bracket Available		
Field Adjustable Pressure Regulating Valves		P.O.A.
Note: All valves listed with rough brass finish. Other finishes available.		

Section C
Valves and Hose Equipment

 Section D
Backflow

 Section F
Pipe & Accessories

 Section H
Hangers

 Section J
Lubricants

 Section K
Misc.

See latest Technical Data Sheets for specific Approvals, Listings, Design Parameters & available finishes. Sprinkler heads & escutcheons are priced separately unless otherwise noted. Items marked "C.O." are made to order and may require longer delivery times.

Section C Valves and Hose Equipment	Crocker Standpipe and Hose Equipment		
	Description	Part Number	List Price
Section D Backflow	Fire Department Inlet Connections – Single Inlet		
	#6345 1½" w/Plate & Plug		
	Rough Brass	28140	\$65.00
	Polished Brass	28145	\$94.50
	Polished Chrome	28150	\$115.50
	#6341 2½" w/Plate & Plug		
	Rough Brass	28155	\$163.00
	Polished Brass	28160	\$294.00
	Polished Chrome	28165	\$367.00
	#6342 3" x 2½" w/Plate & Plug		
Section F Pipe & Accessories	Rough Brass	28170	\$262.00
	Polished Brass	28175	\$283.00
	Polished Chrome	28180	\$399.00
	Fire Department Inlet Connections – Free Standing Type		
(Complete with 18" sleeve, Plate & Plugs)			
#6510 4" x 2½" x 2½"			
Section H Hangers	Rough Brass	28330	\$934.00
	Polished Brass	28335	\$1,207.00
	Polished Chrome	28340	\$1,417.00
Section J Lubricants	#6512 6" x 2½" x 2½"		
	Rough Brass	28345	\$1,785.00
	Polished Brass	28350	\$2,100.00
Section K Misc.	Polished Chrome	28355	\$2,310.00

Crocker Standpipe and Hose Equipment		
Description	Part Number	List Price
Fire Department Inlet Connections – Projecting Type		
#6405, 4"x 2½"x 2½" Single Clapper, Straight		
Rough Brass	28185	\$173.00
#6407, 4"x 2½"x 2½",Single Clapper,Angle		
Rough Brass	28190	\$199.50
#6410, 4"x 2½"x 2½" Double Clapper,Straight		
Rough Brass	28195	\$472.00
Polished Brass	28200	\$735.00
Polished Chrome	28205	\$766.00
#6412, 6"x 2½"x 2½" Double Clapper,Straight		
Rough Brass	28210	\$997.00
Polished Brass	28215	\$1,312.00
Polished Chrome	28220	\$1,417.00
#6420 4"x 2½"x 2½" Double Clapper,Angle		
Rough Brass	28225	\$499.00
Polished Brass	28230	\$735.00
Polished Chrome	28235	\$840.00
#6422 6"x 2½"x 2½" Double Clapper,Angle		
Rough Brass	28240	\$1,102.00
Polished Brass	28245	\$1,365.00
Polished Chrome	28250	\$1,470.00
#6760 4" Round Wall Plate		
Rough Brass	28255	\$115.50
Polished Brass	28260	\$126.00
Polished Chrome	28265	\$163.00
#6764 6" Round Wall Plate,		
Rough Brass	28270	\$147.00
Polished Brass	28275	\$231.00
Polished Chrome	28280	\$252.00
#6766 4" Round Wall Plate, Aluminum	28285	\$26.25
#6767 4" Round Wall Plate, Plastic	28290	\$10.50
Note: Plates lettered Automatic Sprinkler, Standpipe, or Automatic Sprinkler and Standpipe.		
#6747 2½" Plug & Chain,		
Rough Brass	28295	\$47.25
Polished Brass	28300	\$63.00
Polished Chrome	28305	\$73.50
#6752 2½" Breakable Cap, Alum.	28310	\$11.55
#6753 2½" Breakable Cap, Plastic	28315	\$4.45
#6780 ½" Auto Ball Drip, Straight	28320	\$26.00
#678 2½" Auto Ball Drip, Angle	28325	\$84.00

*See latest Technical Data Sheets for specific Approvals, Listings, Design Parameters & available finishes. Sprinkler heads & escutcheons are priced separately unless otherwise noted. Items marked "C.O." are made to order and may require longer delivery times.

Price Book - Section C Valves and Hose Equipment

Crocker Standpipe and Hose Equipment		
Description	Part Number	List Price
Fire Department Inlet Connections – Flush Wall Type		
#6010 4"x 2½" x 2½", Straight Body		
Rough Brass	28050	\$997.00
Polished Brass	28055	\$1,050.00
Polished Chrome	28060	\$1,207.00
#6011 4"x 2½" x 2½", Angle Body		
Rough Brass	28065	\$1,050.00
Polished Brass	28070	\$1,102.00
Polished Chrome	28075	\$1,260.00
#6012 4"x 2½" x 2½", Top Feed		
Rough Brass	28080	\$1,102.00
Polished Brass	28085	\$1,102.00
Polished Chrome	28090	\$1,260.00
#6020 6"x 2½" x 2½", Straight body		
Rough Brass	28095	\$1,286.00
Polished Brass	28100	\$1,365.00
Polished Chrome	28105	\$1,575.00
#6021 6"x 2½" x 2½", Angle Body		
Rough Brass	28110	\$1,785.00
Polished Brass	28115	\$1,795.00
Polished Chrome	28120	\$1,995.00
#6022 6" x 2½" x 2½", Top Feed,		
Rough Brass	28125	\$1,785.00
Polished Brass	28130	\$1,795.00
Polished Chrome	28135	\$1,995.00
Check Valves		
#8470-G 4" Groove x Groove, Brass	28360	\$375.00
#8470-GT 4" Groove x Thread, Brass	28365	\$375.00
#8470-T 4" Thread x Thread, Brass	28370	\$375.00
Storz Connections (with Plate & Cap)		
#6360 4" x 4" Aluminum, Straight	28375	\$253.00
#6360 4" x 4" Aluminum, 30°	28380	\$347.00
#6362 4" x 5" Aluminum, Straight	28385	\$399.00
#6362 4" x 5" Aluminum, 30°	28390	\$440.00
#6363 6" x 4" Aluminum, Straight	28395	\$1,008.00
#6363 6" x 4" Aluminum, 30°	28400	\$1,290.00
#6364 6" x 5" Aluminum, Straight	28405	\$1,300.00
#6364 6" x 5" Aluminum, 30°	28410	\$1,453.00

Crocker Standpipe and Hose Equipment		
Description	Part Number	List Price
Roof Manifolds (Body Only)		
#6840 4" x 2½" x 2½" Straight Rough Brass	2770	\$210.00
#6860 4" x 2½" x 2½" Angle Rough Brass	2771	\$262.00
#6841 6" x 2½" x 2½" Straight Rough Brass	2772	\$551.00
#6861 6" x 2½" x 2½" Angle Rough Brass	27711	\$577.00
Note: Refer to page C-4 for appropriate valves, caps and chains		
Cabinets		
#2700-A Fire department valve cabinet, Recessed, 18X18X8, Steel, Full glass door	28415	\$257.00
#2708-A Fire department valve cabinet, Surface Mounted, Steel, Full Glass Door	28420	\$286.00
Complete line of cabinets available. Specify size, mounting style, finish, and door style. All hose threads shown are NST. Special threads available upon request.		

Section C
Valves and Hose Equipment

Section D
Backflow

Section F
Pipe & Accessories

Section H
Hangers

Section J
Lubricants

Section K
Misc.

See latest Technical Data Sheets for specific Approvals, Listings, Design Parameters & available finishes. Sprinkler heads & escutcheons are priced separately unless otherwise noted. Items marked "C.O." are made to order and may require longer delivery times.

Section C Valves and Hose Equipment	Guardian Standpipe and Hose Equipment		
	Description	Part Number	List Price
Section D Backflow	Hose Rack Units		
	#3007-LN 1½" x 75' Fire Hose less Nozzle	6128	\$470.00
	#3010-LN 1½" x 100' Fire Hose less Nozzle	6129	\$520.00
	#3107-LN 2½" x 75' Fire Hose less Nozzle	61280	\$695.00
	#3110-LN 2½" x 100' Fire Hose less Nozzle	61290	\$755.00
Section F Pipe & Accessories	Adjustable Fog Nozzles		
	#3714 1½" Polycarbonate Fog Nozzle	61320	\$28.35
	#3704 1½" Brass Fog Nozzle	6132	\$69.00
	#3726 2½" Brass Fog Nozzle	61325	\$221.00
	Fire Hose		
Section H Hangers	500 PSI Rack Hose Coupled		
	#3402-50 1½" x 50' Coupled Fire Hose	61330	\$163.00
	#3402-75 1½" x 75' Coupled Fire Hose	6134	\$223.00
Section J Lubricants	#3402-100 1½" x 100' Coupled Fire Hose	6133	\$282.00
	300 PSI Single Jacket Coupled		
	#3412-50 1½" x 50' Coupled Fire Hose	61335	\$200.00
Section K Misc.	#3412-75 1½" x 75' Coupled Fire Hose	61340	\$281.00
	#3412-100 1½" x 100' Coupled Fire Hose	61345	\$360.00
	300 PSI Single Jacket Coupled		
Section K Misc.	#3414-50 2½" x 50' Coupled Fire Hose	61350	\$380.00
	#3414-75 2½" x 75' Coupled Fire Hose	61355	\$496.00
	#3414-100 2½" x 100' Coupled Fire Hose	61360	\$636.00
	600 PSI Double Jacket Coupled		
	#3442-50 1½" x 50' Coupled Fire Hose	61365	\$307.00
	#3442-75 1½" x 75' Coupled Fire Hose	61370	\$433.00
	#3442-100 1½" x 100' Coupled Fire Hose	61375	\$558.00
	600 PSI Double Jacket Coupled		
	#3444-50 2½" x 50' Coupled Fire Hose	61380	\$502.00
	#3444-75 2½" x 75' Coupled Fire Hose	61385	\$708.00
	#3444-100 2½" x 100' Coupled Fire Hose	61390	\$919.00
	Fire Hose Reels		
Hose Valves			
#5020 1½" FxF Angle Hose Valve	6109	\$102.50	
#5010 1½" FxM Angle Hose Valve	6106	\$102.50	
#5025 2½" FxF Angle Hose Valve	6110	\$191.00	
#5015 2½" FxM Angle Hose Valve	6107	\$164.00	
#5515 1½" Cap & Chain	6111	\$16.50	
#5525 2½" Cap & Chain	6112	\$27.30	
Reducer			
#3315 2½" Female x 1½" Male Reducer	6163	\$31.50	

Guardian Standpipe and Hose Equipment		
Description	Part Number	List Price
Pressure Restricting Hose Valves		
#5040 1½" FxF Angle Press Restrict Valve	61395	\$167.00
#5030 1½" FxM Angle Press Restrict Valve	61405	\$167.00
#5045 2½" FxF Angle Press Restrict Valve	61400	\$358.00
#5035 2½" FxM Angle Press Restrict Valve	61410	\$347.00
Pressure Regulating Hose Valves (Factory Set)		
#5250 1½" FxF Angle Press Regul. Valve	61415	POA
#5240 1½" FxM Angle Press Regul. Valve	61425	POA
#5255 2½" FxF Angle Press Regul. Valve	61420	POA
#5245 2½" FxM Angle Press Regul. Valve	61430	POA
#5260 2½" FxF Inline Press Regul. Valve	61435	POA
Tamper Switch Bracket Available		
Field Adjustable Pressure Regulating Valves		POA
Note: All valves listed with rough brass finish. Other finishes available.		
Fire Department Inlet Connections – Single Inlet		
#6002 1½" RB FDC w/ Plate & Plug	61535	\$75.60
#6002-B 1½" PB FDC w/ Plate & Plug	61540	\$114.00
#6002-D 1½" PC FDC w/ Plate & Plug	61545	\$146.00
#6014 2½" RB FDC w/ Plate & Plug	61550	\$188.00
#6014-B 2½" PB FDC w/ Plate & Plug	61555	\$296.00
#6014-D 2½" PC FDC w/ Plate & Plug	61560	\$365.00
#6015 3" x 2½" RB FDC w/ Plate & Plug	61565	\$262.00
#6015-B 3" x 2½" PB FDC w/ Plate & Plug	61570	\$320.00
#6015-D 3" x 2½" PC FDC w/ Plate & Plug	61575	\$389.00
Fire Department Inlet Connections – Projecting Type		
#6314 4" x 2½" x 2½" SC FDC Straight	6153	\$184.00
#6315 4" x 2½" x 2½" SC FDC Angle	6154	\$291.00
#6324 4" x 2½" x 2½" RB DC FDC Straight	6155	\$466.00
#6324-B 4" x 2½" x 2½" PB DC FDC Straight	6157	\$562.00
#6324-D 4" x 2½" x 2½" PC DC FDC Straight	6158	\$669.00
#6326 6" x 2½" x 2½" RB DC FDC Straight	61580	\$812.00
#6326-B 6" x 2½" x 2½" PB DC FDC Straight	61585	\$944.00
#6326-D 6" x 2½" x 2½" PC DC FDC Straight	61590	\$1,087.00

*See latest Technical Data Sheets for specific Approvals, Listings, Design Parameters & available finishes. Sprinkler heads & escutcheons are priced separately unless otherwise noted. Items marked "C.O." are made to order and may require longer delivery times.

Price Book - Section C Valves and Hose Equipment

Guardian Standpipe and Hose Equipment		
Description	Part Number	List Price
#6325 4" x 2½" x 2½" RB DC FDC Angle	6156	\$502.00
#6325-B 4" x 2½" x 2½" PB DC FDC Angle	6170	\$597.00
#6325-D 4" x 2½" x 2½" PC DC FDC Angle	6171	\$704.00
#6327 6" x 2½" x 2½" RB DC FDC Angle	61595	\$854.00
#6327-B 6" x 2½" x 2½" PB DC FDC Angle	61600	\$1,027.00
#6327-D 6" x 2½" x 2½" PC DC FDC Angle	61605	\$1,171.00
#6464 RB 4" Round Wall Plate	6137	\$143.00
#6464-B PB 4" Round Wall Plate	6138	\$172.00
#6464-D PC 4" Round Wall Plate	6150	\$206.00
#6466 RB 6" Round Wall Plate	61610	\$167.00
#6466-B PB 6" Round Wall Plate	61615	\$221.00
#6466-D PC 6" Round Wall Plate	61620	\$281.00
#6454 Aluminum 4" Round Wall Plate	61625	\$30.00
Note: Plates lettered Automatic Sprinkler, Standpipe, or Automatic Sprinkler and Standpipe.		
#6404 2½" RB Plug & Chain	6115	\$35.70
#6404-B 2½" PB Plug & Chain	6116	\$54.60
#6404-D 2½" PC Plug & Chain	6117	\$71.00
#6406-PR 2½" Aluminum Breakable Cap	61635	\$9.40 / Pair
#6407-PR 2½" Plastic Breakable Cap	61636	\$3.15 / Pair
#6430 ½" Straight Auto Ball Drip	6104	\$24.15
#6431 ½" Angle Auto Ball Drip	61640	\$31.50
Fire Department Inlet Connections – Free Standing Type (Complete with 18" sleeve, Plate & Plugs)		
#6224 4" x 2½" x 2½" RB FDC w/Plt, Plug, Slv	61645	\$996.00
#6224-B 4" x 2½" x 2½" PB FDC w/Plt, Plug, Slv	61650	\$1,156.00
#6224-D 4" x 2½" x 2½" PC FDC w/Plt, Plug, Slv	61655	\$1,388.00
#6226 6" x 2½" x 2½" RB FDC w/Plt, Plug, Slv	61660	\$1,600.00
#6226-B 6" x 2½" x 2½" PB FDC w/Plt, Plug, Slv	61665	\$1,817.00
#6226-D 6" x 2½" x 2½" PC FDC w/Plt, Plug, Slv	61670	\$2,130.00

Guardian Standpipe and Hose Equipment		
Description	Part Number	List Price
Fire Department Inlet Connections – Flush Wall Type		
#6024 4" x 2½" x 2½" RB FDC FL Straight	61445	\$1,218.00
#6024-B 4" x 2½" x 2½" PB FDC FL Straight	61450	\$1,338.00
#6024-D 4" x 2½" x 2½" PC FDC FL Straight	61455	\$1,504.00
#6025 4" x 2½" x 2½" RB FDC FL Angle	61475	\$1,242.00
#6025-B 4" x 2½" x 2½" PB FDC FL Angle	61480	\$1,362.00
#6025-D 4" x 2½" x 2½" PC FDC FL Angle	61485	\$1,529.00
#6026 4" x 2½" x 2½" RB FDC Top Feed	61505	\$1,672.00
#6026-B 4" x 2½" x 2½" PB FDC Top Feed	61510	\$1,791.00
#6026-D 4" x 2½" x 2½" PC FDC Top Feed	61515	\$1,958.00
#6027 6" x 2½" x 2½" RB FDC FL Straight	61460	\$1,480.00
#6027-B 6" x 2½" x 2½" PB FDC FL Straight	61465	\$1,600.00
#6027-D 6" x 2½" x 2½" PC FDC FL Straight	61470	\$1,767.00
#6028 6" x 2½" x 2½" RB FDC FL Angle	61490	\$2,126.00
#6028-B 6" x 2½" x 2½" PB FDC FL Angle	61495	\$1,908.00
#6028-D 6" x 2½" x 2½" PC FDC FL Angle	61500	\$2,413.00
#6029 6" x 2½" x 2½" RB FDC Top Feed	61520	\$2,365.00
#6029-B 6" x 2½" x 2½" PB FDC Top Feed	61525	\$2,484.00
#6029-D 6" x 2½" x 2½" PC FDC Top Feed	61530	\$2,651.00
Check Valves		
#6420 GxG Check Valve 4" Brass	61675	\$320.00
#6421 GxT Check Valve 4" Brass	61680	\$320.00
#6422 TxT Check Valve 4" Brass	61685	\$320.00
Storz Connections (with Plate & Cap)		
#6614-KIT 4"x4" Straight Aluminum Storz Conn.	6123	\$507.00
#6624-KIT 4"x4" 30-degree Aluminum Storz Conn.	6125	\$675.00
#6615-KIT 4"x5" Straight Aluminum Storz Conn.	6124	\$645.00
#6625-KIT 4"x5" 30-degree Aluminum Storz Conn.	6126	\$760.00
#6617-KIT 6"x4" Straight Aluminum Storz Conn.	61230	\$655.00
#6627-KIT 6"x4" 30-degree Aluminum Storz Conn.	61250	\$896.00
#6618-KIT 6"x5" Straight Aluminum Storz Conn.	61240	\$794.00
#6628-KIT 6"x5" 30-degree Aluminum Storz Conn.	61260	\$980.00

Section C
Valves and Hose Equipment

Section D
Backflow

Section F
Pipe & Accessories

Section H
Hangers

Section J
Lubricants

Section K
Misc.

See latest Technical Data Sheets for specific Approvals, Listings, Design Parameters & available finishes. Sprinkler heads & escutcheons are priced separately unless otherwise noted. Items marked "C.O." are made to order and may require longer delivery times.

Guardian Standpipe and Hose Equipment			
<i>Description</i>			
		<i>Part Number</i>	<i>List Price</i>
Section C Valves and Hose Equipment	Roof Manifolds (Body Only)		
	#6924 4" x 2½" x 2½" Straight Manifold Body	6143	\$177.00
	#6925 4" x 2½" x 2½" Angle Manifold Body	6145	\$211.00
Section D Backflow	#6926 6" x 2½" x 2½" Straight Manifold Body	6144	\$429.00
	#6927 6" x 2½" x 2½" Angle Manifold Body	6146	\$597.00
Note: Refer to page C-6 for appropriate valves, caps and chains			
Section F Pipe & Accessories	Cabinets		
	#2020-A Recessed Valve Cabinet Full Glass	61690	\$225.00
	#2050-A Flush Valve Cabinet Full Glass	61695	\$265.00
Section H Hangers	Complete line of cabinets available.		
	Specify size, mounting style, finish, and door style.		
Section J Lubricants	All hose threads shown are NST. Special threads available upon request.		
Section K Misc.			

**See latest Technical Data Sheets for specific Approvals, Listings, Design Parameters & available finishes. Sprinkler heads & escutcheons are priced separately unless otherwise noted. Items marked "C.O." are made to order and may require longer delivery times.*

Price Book - Section D Backflow

Ames		
Description	Part Number	List Price
Model Maxim M200 With FxG OS&Y Valve		
2½"	205500	\$2,611.00
3"	205510	\$2,512.00
4"	205520	\$3,241.00
6"	205530	\$5,211.00
8"	207190	\$8,876.00
Model Maxim M200 With Grooved Butterfly Valve		
2½"	205501	\$3,026.00
3"	205511	\$2,960.00
4"	205521	\$3,821.00
6"	205531	\$6,159.00
8"	207191	\$10,484.00
Model Maxim M300 DCDA With FxG OS&Y Valve (GPM Meter)		
2½"	205490	\$3,349.00
3"	205480	\$3,557.00
4"	205580	\$3,865.00
6"	205590	\$6,045.00
8"	205390	\$10,897.00
Model Maxim M300 DCDA With FxG OS&Y Valve (CFM Meter)		
2½"	205495	\$3,349.00
3"	205485	\$3,557.00
4"	205585	\$3,865.00
6"	205595	\$6,045.00
8"	205395	\$10,897.00
Model Maxim M300 DCDA With Grooved Butterfly Valve (GPM Meter)		
2½"	205491	\$3,928.00
3"	205481	\$4,192.00
4"	205581	\$4,541.00
6"	205591	\$7,129.00
8"	205391	\$12,838.00
Model Maxim M300 DCDA With Grooved Butterfly Valve (CFM Meter)		
2½"	205496	\$3,928.00
3"	205486	\$4,192.00
4"	205586	\$4,541.00
6"	205596	\$7,129.00
8"	205396	\$12,838.00
Model Maxim M400 With FxG OS&Y Valve		
2½"	207670	\$2,974.00
3"	207680	\$3,289.00
4"	207690	\$4,185.00
6"	207700	\$6,641.00
8"	207710	\$12,656.00
Model Maxim M400N With Grooved Butterfly Valve		
2½"	207671	\$3,783.00
3"	207681	\$4,118.00
4"	207691	\$5,216.00
6"	207701	\$8,208.00

Ames			Section C Valves and Hose Equipment
Description	Part Number	List Price	
Model Maxim M500 RPDA With FxG OS&Y Valve (GPM Meter)			Section D Backflow
2½"	208320	\$4,924.00	
3"	208330	\$5,065.00	
4"	208340	\$5,144.00	
6"	208360	\$8,115.00	
8"	208380	\$14,372.00	
Model Maxim M500 RPDA With FxG OS&Y Valve (CFM Meter)			Section F Pipe & Accessories
2½"	208325	\$4,924.00	
3"	208335	\$5,065.00	
4"	208345	\$5,144.00	
6"	208365	\$8,115.00	
8"	208385	\$14,372.00	
Model Maxim M500 RPDA With Grooved BFV's Valve (GPM Meter)			Section H Hangers
2½"	208321	\$5,981.00	
3"	208331	\$6,149.00	
4"	208341	\$6,316.00	
6"	208361	\$9,900.00	Section J Lubricants
Model Maxim M500 RPDA With Grooved BFV's Valve (CFM Meter)			
2½"	208326	\$5,981.00	
3"	208336	\$6,149.00	
4"	208346	\$6,316.00	Section K Misc.
6"	208366	\$9,900.00	
Model 1000 DCV Detector Check F x F (Less By-Pass)			Section L Misc.
4"	20849	\$1,430.00	
6"	20851	\$2,043.00	
8"	20853	\$3,422.00	
10"	20855	\$6,253.00	
Model 1005 DCV Detector Check F x G (Less By-Pass)			Section M Misc.
4"	20858	\$1,499.00	
6"	20854	\$2,140.00	Section N Misc.
Model 2000B Brass Double Check Assembly (With Ball Valve)			
½"	21010	\$265.00	
¾"	21011	\$253.50	
1"	21012	\$296.50	
1¼"	21013	\$513.50	
1½"	21014	\$530.00	
2"	21015	\$626.00	
Model 2000B Brass Double Check Assembly (Less Ball Valve)			
½"	21023	\$234.00	
¾"	21024	\$316.00	
1"	21025	\$413.00	
1¼"	21026	\$455.00	
1½"	21027	\$474.00	
2"	21028A	\$500.00	

Items shown on this sheet may not be stocked at all Tyco Fire Products warehouses. Please ask your local Tyco Fire Products location for availability. Freight terms may vary for non commonly stocked items. See latest Technical Data Sheets for specific Approvals, Listings, Design Parameters & available finishes. Prices subject to change without notice.

Section	Ames		
	Description	Part Number	List Price
Section C Valves and Hose Equipment	Model 3000B Brass Assembly (w/O.S.&Y. Valve)		
	2"	21549	\$4,660.00
Section D Backflow	Model 4000B Brass Reduced Pressure Backflow Assembly (With Ball Valve)		
	1/2"	21016	\$428.00
	3/4"	21017	\$456.00
	1"	21018	\$482.00
	1 1/4"	21019	\$793.00
	1 1/2"	21021	\$890.00
	2"	21022	\$990.00
	Model 4000B Brass Reduced Pressure Backflow Assembly (Less Ball Valve)		
	1/2"	21029	\$414.00
	3/4"	21030	\$399.00
Section F Pipe & Accessories	1"	21031	\$417.00
	1 1/4"	21032	\$680.00
	1 1/2"	21033	\$715.00
	2"	21034	\$739.00
Section H Hangers	Model 2000 SS Double Check Backflow Assembly (Less Gate Valves)		
	2 1/2"	20700	\$1,493.00
Section J Lubricants	3"	20701	\$1,628.00
	4"	20702	\$2,061.00
	6"	20703	\$3,396.00
	8"	20897	\$7,786.00
Section K Misc.	10"	20705	\$8,792.00
	Model 2000 SS Double Check Backflow Assembly (w/O.S.&Y. Valves)		
	2 1/2"	20550	\$2,513.00
	3"	20551	\$2,465.00
	4"	20552	\$3,150.00
	6"	20553	\$5,067.00
	8"	20719	\$8,629.00
	10"	20555	\$12,664.00
	Model 3000 SS Double Check Detector Backflow Assembly (Less Gate Valves)		
	2 1/2"	20729	\$2,660.00
3"	20730	\$2,793.00	
4"	20731	\$2,915.00	
6"	20732	\$4,915.00	
8"	20898	\$9,108.00	
10"	20734	\$10,492.00	

Ames		
Description	Part Number	List Price
Model 3000 SS Double Check Detector Backflow Assembly (w/O.S.&Y. Valves)		
2 1/2"	20549	\$3,255.00
3"	20548	\$3,491.00
4"	20558	\$3,756.00
6"	20559	\$5,875.00
8"	20539	\$10,695.00
10"	20561	\$14,614.00
Model 4000 SS Reduced Pressure Backflow Prevention Assembly (Less Gate Valves)		
2 1/2"	20757	\$2,243.00
3"	20758	\$2,329.00
4"	20759	\$3,348.00
6"	20760	\$4,916.00
8"	20761	\$9,422.00
10"	20762	\$14,067.00
Model 4000 SS Reduced Pressure Backflow Prevention Assembly (w/ O.S.&Y. Valves)		
2 1/2"	20767	\$2,885.00
3"	20768	\$3,224.00
4"	20769	\$4,063.00
6"	20770	\$6,448.00
8"	20771	\$12,287.00
10"	20772	\$17,684.00
Model 5000 SS Reduced Pressure Detector Assembly (Less Gate Valves)		
2 1/2"	20822	\$3,184.00
3"	20823	\$3,258.00
4"	20824	\$3,971.00
6"	20826	\$5,720.00
Model 5000 SS Reduced Pressure Detector Assembly (w/O.S.&Y. Valves)		
2 1/2"	20832	\$4,782.00
3"	20833	\$4,917.00
4"	20834	\$4,944.00
6"	20836	\$7,804.00
Air Gap Drains		
Horiz. Air Gap Drain (A113-960)	20788	\$254.00
Silver Bullet Vertical (A113-963)	20839	\$1,001.00
Old Style (Non S.S) (3-1039)	20787	\$766.00
Maxim/Colt Air Gap Drain		
2 1/2" - 10"	207880	\$328.00

Items shown on this sheet may not be stocked at all Tyco Fire Products warehouses. Please ask your local Tyco Fire Products location for availability. Freight terms may vary for non commonly stocked items. See latest Technical Data Sheets for specific Approvals, Listings, Design Parameters & available finishes. Prices subject to change without notice.

Price Book - Section D Backflow

Colt		
Description	Part Number	List Price
Model C200 Double Check Assembly (w/ FxG O.S.&Y. Valves)		
2½"	205502	\$2,275.00
3"	205512	\$2,467.00
4"	205522	\$2,969.00
6"	205532	\$4,775.00
8"	207192	\$8,649.00
Model C200 Double Check Assembly (w/ Grooved Butterfly Valves)		
2½"	205503	\$2,863.00
3"	205513	\$3,022.00
4"	205523	\$3,574.00
6"	205533	\$5,756.00
8"	207193	\$10,451.00
Model C300 Double Check Detector Assembly (w/ FxG O.S.&Y. Valves)		
2½"	205492	\$3,227.00
3"	205482	\$3,292.00
4"	205582	\$3,549.00
6"	205592	\$5,318.00
8"	205392	\$10,404.00
Model C300 Double Check Detector Assembly (w/ Grooved Butterfly Valves)		
2½"	205493	\$3,947.00
3"	205483	\$4,059.00
4"	205583	\$4,399.00
6"	205593	\$6,678.00
8"	205393	\$12,934.00
Model C400 Reduced Pressure Assembly (w/ FxG O.S.&Y. Valves)		
2½"	207672	\$2,759.00
3"	207682	\$2,925.00
4"	207692	\$3,656.00
6"	207702	\$5,916.00
8"	207712	\$11,168.00
Model C500 Reduced Pressure Detector Assembly (w/ FxG O.S.&Y. Valves)		
2½"	208322	\$4,123.00
3"	208332	\$4,387.00
4"	208342	\$4,520.00
6"	208362	\$7,046.00
8"	208382	\$12,697.00

Febco		
Description	Part Number	List Price
Model 850 Double Check Assembly (w/ O.S.&Y. Valves)		
2½"	90610	\$2,691.00
3"	90611	\$2,764.00
4"	90612	\$3,422.00
6"	90613	\$5,090.00
8"	90614	\$9,584.00
Model 870V (Vertical) Double Check Assembly (w/ O.S.&Y. Valves)		
2½"	90620	\$3,087.00
3"	90621	\$3,177.00
4"	90622	\$4,161.00
6"	90623	\$5,928.00
8"	90624	\$10,657.00
10"	90625	\$15,802.00
Model 856 Double Check Detector Assembly (w/ O.S.&Y. Valves)		
2½"	90641	\$3,628.00
3"	90642	\$3,775.00
4"	90643	\$3,956.00
6"	90644	\$5,887.00
8"	90645	\$10,050.00

Section C
Valves and Hose Equipment

 Section D
Backflow

 Section F
Pipe & Accessories

 Section H
Hangers

 Section J
Lubricants

 Section K
Misc.

Items shown on this sheet may not be stocked at all Tyco Fire Products warehouses. Please ask your local Tyco Fire Products location for availability. Freight terms may vary for non commonly stocked items. See latest Technical Data Sheets for specific Approvals, Listings, Design Parameters & available finishes. Prices subject to change without notice.

Febco		
<i>Description</i>	<i>Part Number</i>	<i>List Price</i>
Model 876V (Vertical) Double Check Detector Assembly (w/ O.S.&Y. Valves)		
2½"	90650	\$4,168.00
3"	90651	\$4,336.00
4"	90652	\$4,607.00
6"	90653	\$6,864.00
8"	90654	\$12,301.00
10"	90655	\$17,279.00
Model 860 Reduced Pressure Assembly (w/ O.S.&Y. Valves)		
2½"	90671	\$3,153.00
3"	90672	\$3,335.00
4"	90673	\$4,335.00
6"	90674	\$6,572.00
8"	90675	\$12,201.00
Model 880V Reduced Pressure Assembly (w/ O.S.&Y. Valves)		
2½"	90680	\$3,536.00
3"	90681	\$3,755.00
4"	90682	\$4,955.00
6"	90683	\$7,574.00
8"	90684	\$13,946.00
10"	90685	\$19,439.00
Model 826 Reduced Pressure Detector Assembly (w/ O.S.&Y. Valves)		
2½"	90695	\$4,454.00
3"	90696	\$4,719.00
4"	90697	\$5,537.00
6"	90698	\$7,827.00
8"	90699	\$13,712.00
10"	90701	\$18,284.00
Model 850U Double Check Assembly (w/ Union End - Ball Valves)		
1"	90733	\$296.00
1¼"	90734	\$592.00
1½"	90735	\$622.00
2"	90736	\$714.00

Febco		
<i>Description</i>	<i>Part Number</i>	<i>List Price</i>
Model 850 Double Check Assembly (w/ Ball Valves)		
1"	92733	\$248.00
1¼"	92734	\$484.00
1½"	92735	\$509.00
2"	92736	\$608.00
Model 860 Reduced Pressure Assembly (w/ Union End - Ball Valves)		
1"	91733	\$565.00
1¼"	91734	\$918.00
1½"	91735	\$1,042.00
2"	91736	\$1,110.00
Model 825Y Reduced Pressure Assembly		
2"	90765	\$959.00
Air Gap Drains		
M 2½"-10"	90725	\$149.00
AGD 2½"-10"	90726	\$149.00
601 1¼"-2"	91725	\$39.00

Items shown on this sheet may not be stocked at all Tyco Fire Products warehouses. Please ask your local Tyco Fire Products location for availability. Freight terms may vary for non commonly stocked items. See latest Technical Data Sheets for specific Approvals, Listings, Design Parameters & available finishes. Prices subject to change without notice.

Price Book - Section D Backflow

Watts Regulator		
Description	Part Number	List Price
Small Backflow Preventors		
Model 007 LF Double Check Backflow (Less Ball Valve)		
¾"	20610	\$314.00
1"	20611	\$412.00
1¼"	206115	\$455.00
1½"	20612	\$470.00
2"	20613	\$489.00
Model 007 QT Double Check Backflow (w/Ball Valve)		
¾"	20614	\$271.00
1"	20615	\$305.00
1¼"	206155	\$514.00
1½"	20616	\$528.00
2"	20617	\$623.00
Model 009 LF Reduced Pressure Backflow (Less Ball Valve)		
¾"	20618	\$399.00
1"	20619	\$415.00
1¼"	206195	\$669.00
1½"	20485	\$701.00
2"	20620	\$721.00
Model 009 QT Reduced Pressure Backflow (w/Ball Valve)		
¾"	20621	\$449.00
1"	20449	\$482.00
1¼"	20450	\$776.00
1½"	20451	\$877.00
2"	20452	\$969.00
Air Gap Drains		
909AGC	20473	\$99.00
909AGF	20438	\$178.00
Backflow Repair Kits		
RK009RT, ¾" - 1	20478	\$103.00
RK009RT, 1¼" - 2"	20479	\$152.00
RK709RT, ¾" - 1	20480	\$30.00
RK709RT, 1½" - 3	20481	\$67.00
RK709RT, 2½" - 3	20457	\$229.00
RK709RT, 6"	20430	\$352.00
RK709RT, 8"	20459	\$416.00
RK909RT, 2½" - 3"	20460	\$513.00
RK909RT, 4"	20461	\$659.00
RK909RT, 6"	20813	\$694.00
RK909RT, 8"	20462	\$868.00

Watts Regulator		
Description	Part Number	List Price
Model 709 Double Check Valve Backflow Assembly (Less Gates)		
2½"	20412	\$2,103.00
3"	20472	\$2,225.00
4"	20405	\$2,460.00
6"	20407	\$2,757.00
8"	20409	\$9,217.00
10"	20411A	\$10,575.00
Model 709 Double Check Valve Backflow Assembly (w/ OS&Y's)		
2½"	20427	\$3,654.00
3"	20428	\$3,938.00
4"	20404	\$3,680.00
6"	20406	\$5,889.00
8"	20408	\$10,987.00
10"	20410	\$15,186.00
Model 007/709 Double Check Detector Assembly Backflow Preventor (Less Gates)		
2½"	20698	\$3,020.00
3"	20634	\$3,844.00
3"	20636	\$3,127.00
4"	20490	\$3,661.00
6"	20491	\$5,464.00
8"	20492	\$10,186.00
10"	20635	\$12,196.00
Model 007/709 Double Check Detector Assembly Backflow Preventor (w/ OS&Y's)		
2½"	20663	\$4,401.00
3"	20661	\$5,003.00
3"	20664	\$4,434.00
4"	20431	\$4,406.00
6"	20444	\$6,599.00
8"	20445	\$12,916.00
10"	20662	\$15,937.00
Model 009/909 Reduced Pressure Zone Backflow Preventor (Less Gates)		
2½"	20641	\$2,791.00
2½"	20471	\$3,473.00
3"	20642	\$2,921.00
3"	20470	\$3,810.00
4"	20415	\$4,155.00
6"	20417	\$5,801.00
8"	20419	\$10,233.00
10"	20422	\$15,485.00

Section C
Valves and Hose Equipment

 Section D
Backflow

 Section F
Pipe & Accessories

 Section H
Hangers

 Section J
Lubricants

 Section K
Misc.

Items shown on this sheet may not be stocked at all Tyco Fire Products warehouses. Please ask your local Tyco Fire Products location for availability. Freight terms may vary for non commonly stocked items. See latest Technical Data Sheets for specific Approvals, Listings, Design Parameters & available finishes. Prices subject to change without notice.

Watts Regulator		
<i>Description</i>	<i>Part Number</i>	<i>List Price</i>
Model 009/909 Reduced Pressure Zone Backflow Preventor (w/ OS&Y's)		
2½"	20670	\$3,480.00
2½"	20669	\$4,482.00
3"	20671	\$3,646.00
3"	20432	\$4,919.00
4"	20414	\$4,386.00
6"	20416	\$7,057.00
8"	20418	\$13,449.00
10"	20420	\$19,021.00
Model 909 Reduced Pressure Zone Backflow Detector Assembly (Less Gates)		
2½"	206761	\$3,595.00
3"	20647	\$4,006.00
4"	20475	\$4,327.00
6"	20476	\$6,273.00
8"	20477	\$11,743.00
10"	20648	\$14,971.00
Model 909 Reduced Pressure Zone Backflow Detector Assembly (w/ OS&Y's)		
3"	20676	\$5,230.00
4"	20677	\$5,474.00
6"	20678	\$8,407.00
8"	20679	\$14,811.00
10"	20680	\$20,312.00

Section C
Valves and Hose Equipment

Section D
Backflow

Section F
Pipe & Accessories

Section H
Hangers

Section J
Lubricants

Section K
Misc.

Items shown on this sheet may not be stocked at all Tyco Fire Products warehouses. Please ask your local Tyco Fire Products location for availability. Freight terms may vary for non commonly stocked items. See latest Technical Data Sheets for specific Approvals, Listings, Design Parameters & available finishes. Prices subject to change without notice.

Price Book - Section F Pipe & Accessories

SCI Coop-Let F.T.		
Part No.	Size / Description	List Price
251100	SCI Coop-Let F.T. 1/2" x 1"-1 1/2"	\$5.25
251120	SCI Coop-Let F.T. 1/2" x 2"-2 1/2"	\$5.25
251130	SCI Coop-Let F.T. 1/2" x 3" - 8	\$5.25
251140	SCI Coop-Let F.T. 3/4" x 1"-1 1/2"	\$5.25
251150	SCI Coop-Let F.T. 3/4" x 2"-2 1/2"	\$5.25
251160	SCI Coop-Let F.T. 3/4" x 2 1/2"	\$5.25
251170	SCI Coop-Let F.T. 3/4" x 3" - 8	\$5.25
251180	SCI Coop-Let F.T. 1" x 1 1/4"-1 1/2"	\$7.45
251190	SCI Coop-Let F.T. 1" x 2"-2 1/2"	\$7.45
251200	SCI Coop-Let F.T. 1" x 2 1/2"	\$7.45
251210	SCI Coop-Let F.T. 1" x 3" - 4	\$7.45
251220	SCI Coop-Let F.T. 1" x 5" - 8	\$7.45
251230	SCI Coop-Let F.T. 1 1/4" x 1 1/2"	\$11.50
251240	SCI Coop-Let F.T. 1 1/4" x 2	\$11.50
251250	SCI Coop-Let F.T. 1 1/4" x 2 1/2"	\$11.50
251260	SCI Coop-Let F.T. 1 1/4" x 3" - 4	\$11.50
251270	SCI Coop-Let F.T. 1 1/4" x 5" - 8	\$11.50
251280	SCI Coop-Let F.T. 1 1/2" x 2	\$14.70
251290	SCI Coop-Let F.T. 1 1/2" x 2 1/2"	\$14.70
251300	SCI Coop-Let F.T. 1 1/2" x 3	\$14.70
251310	SCI Coop-Let F.T. 1 1/2" x 4"- 5	\$14.70
251320	SCI Coop-Let F.T. 1 1/2" x 6"- 8	\$14.70
251330	SCI Coop-Let F.T. 2" x 2 1/2"	\$19.95
251340	SCI Coop-Let F.T. 2" x 3	\$19.95
251350	SCI Coop-Let F.T. 2" x 4"- 5	\$19.95
251360	SCI Coop-Let F.T. 2" x 6"- 8	\$19.95
251370	SCI Coop-Let F.T. 2 1/2" x 3	\$33.60
251380	SCI Coop-Let F.T. 2 1/2" x 4	\$33.60
251390	SCI Coop-Let F.T. 2 1/2" x 6	\$33.60
251400	SCI Coop-Let F.T. 2 1/2" x 8	\$33.60
251410	SCI Coop-Let F.T. 3" x 4	\$78.75
251420	SCI Coop-Let F.T. 3" x 6	\$78.75
251430	SCI Coop-Let F.T. 3" x 8	\$78.75
251440	SCI Coop-Let F.T. 4" x 6	\$123.90
251450	SCI Coop-Let F.T. 4" x 8	\$123.90

SCI Coop-Let Grooved		
Part No.	Size / Description	List Price
251460	SCI Coop-Let Grvd 1 1/4" x 1 1/2"	\$11.00
251470	SCI Coop-Let Grvd 1 1/4" x 2	\$11.00
251480	SCI Coop-Let Grvd 1 1/4" x 2 1/2"	\$11.00
251490	SCI Coop-Let Grvd 1 1/4" x 3	\$11.00
251500	SCI Coop-Let Grvd 1 1/4" x 4"- 5	\$11.00
251510	SCI Coop-Let Grvd 1 1/4" x 6	\$11.00
251530	SCI Coop-Let Grvd 1 1/2" x 2	\$12.60
251540	SCI Coop-Let Grvd 1 1/2" x 2 1/2"	\$12.60
251550	SCI Coop-Let Grvd 1 1/2" x 3	\$12.60
251560	SCI Coop-Let Grvd 1 1/2" x 4"- 5	\$12.60
251570	SCI Coop-Let Grvd 1 1/2" x 6	\$12.60
251580	SCI Coop-Let Grvd 1 1/2" x 8	\$12.60
251590	SCI Coop-Let Grvd 2" x 2 1/2"	\$13.65
251600	SCI Coop-Let Grvd 2" x 3	\$13.65
251610	SCI Coop-Let Grvd 2" x 4"- 5	\$13.65
251620	SCI Coop-Let Grvd 2" x 6	\$13.65
251630	SCI Coop-Let Grvd 2" x 8	\$13.65
251640	SCI Coop-Let Grvd 2 1/2" x 3	\$15.75
251650	SCI Coop-Let Grvd 2 1/2" x 4	\$15.75
251660	SCI Coop-Let Grvd 2 1/2" x 6	\$15.75
251670	SCI Coop-Let Grvd 2 1/2" x 8	\$15.75
251680	SCI Coop-Let Grvd 3" x 4	\$21.00
251690	SCI Coop-Let Grvd 3" x 6	\$21.00
251700	SCI Coop-Let Grvd 3" x 8	\$21.00
251710	SCI Coop-Let Grvd 4" x 6	\$31.50
251720	SCI Coop-Let Grvd 4" x 8	\$31.50
251730	SCI Coop-Let Grvd 6" x 8	\$65.00

Section C	Valves and Hose Equipment
Section D	Backflow
Section F	Pipe & Accessories
Section H	Hangers
Section J	Lubricants
Section K	Misc.

Items shown on this sheet may not be stocked at all Tyco Fire Products warehouses. Please ask your local Tyco Fire Products location for availability. Freight terms may vary for non commonly stocked items. See latest Technical Data Sheets for specific Approvals, Listings, Design Parameters & available finishes. Prices subject to change without notice.

Section C
Valves and Hose Equipment

Section D
Backflow

Section F
Pipe & Accessories

Section H
Hangers

Section J
Lubricants

Section K
Misc.

Merit		
<i>Size/Description</i>	<i>Part No.</i>	<i>Net Price</i>
Grooved Outlets – Sch. 40		
Tee-Let 1¼" x 1¼"	15250	\$16.75
Tee-Let 1½" x 1½"	15500	\$18.15
Tee-Let 2" x 2"	15750	\$19.85
Tee-Let 2½" x 2½"	16100	\$28.15
Tee-Let 3" x 3"	16400	\$36.60
Tee-Let 4" x 4"	16700	\$57.35
Tee-Let 6" x 6"	16900	\$115.75
Tee-Let 8" x 8"	17000	\$146.30
Grooved Outlets – Sch. 10		
Tee-Let 2½" x 2½", Sch. 10	17025	\$23.10
Tee-Let 3" x 3", Sch. 10	17031	\$30.90
Tee-Let 4" x 4", Sch. 10	17037	\$46.00
Tee-Let 6" x 6", Sch. 10	17044	\$91.70
Adjustable Drop Nipples		
<i>Size/Description</i>	<i>Part No.</i>	<i>List Price</i>
1" x ½", 4.1" – 5.1", Model #M1.150	3201	\$23.35
1" x ½", 6.1" – 9.1", Model #M3.150	3202	\$23.35
1" x ½", 3.5" – 4.5", Model #F1.150	3204	\$18.90
1" x ½", 4.5" – 6.5", Model #F2.150	3205	\$18.90
1" x ½", 5.5" – 8.5", Model #F3.150	3206	\$18.90
1" x ¾", 6.82" – 10", Model #F3.175	3207	\$22.70
Flexhead - Flexible Drop Nipples		
<i>Size/Description</i>	<i>Part No.</i>	<i>Net Price</i>
#2024 ½" x 24"	88100	\$26.75
#2024 ¾" x 24"	88105	\$26.75
#2036 ½" x 36"	88101	\$30.85
#2036 ¾" x 36"	88106	\$30.85
#2048 ½" x 48"	88102	\$34.85
#2048 ¾" x 48"	88107	\$34.85
#2060 ½" x 60"	88103	\$38.85
#2060 ¾" x 60"	88108	\$38.85
#2072 ½" x 72"	88104	\$43.00
#2072 ¾" x 72"	88109	\$43.00
Welded Flange		
<i>Size</i>	<i>Part No.</i>	<i>List Price</i>
2"	41001	\$74.00
2½"	41002	\$99.00
3"	41003	\$124.00
4"	41004	\$145.00
6"	41006	\$224.00
8"	41008	\$345.00
10"	41010	\$587.00
12"	41011	\$804.00

Test/Drain Assemblies		
<i>Size/Description</i>	<i>Part No.</i>	<i>List Price</i>
1" "Sure Test"	2391	\$246.00
1¼" "Sure Test"	2399	\$286.00
1" #132 Inspection Test w/ Prv	21232	\$146.00

Sight Drains		
<i>Size/Description</i>	<i>Part No.</i>	<i>List Price</i>
1" Sight Drain	2285	\$59.85
1¼" Sight Drain	2286	\$67.20
1½" Sight Drain	2287	\$51.50
2" Sight Drain	2288	\$99.00
1" Sight Drain w/ ½" orifice	2292	\$42.00
1" x ½" Orifice Union	2293	\$36.75

Bolt, Nut, Gasket Kits		
<i>Size</i>	<i>Part No.</i>	<i>List Price</i>
2"	50240	See Section 18 for current list prices
2½"	50241	
3"	50242	
4"	50243	
5"	50248	
6"	50244	
8"	50245	
10"	50246	
12"	50247	

Items shown on this sheet may not be stocked at all Tyco Fire Products warehouses. Please ask your local Tyco Fire Products location for availability. Freight terms may vary for non commonly stocked items. See latest Technical Data Sheets for specific Approvals, Listings, Design Parameters & available finishes. Prices subject to change without notice.

Price Book - Section F Pipe & Accessories

Red Rubber Gaskets		
Size	Part No.	List Price
2"	50220	\$0.79
2½"	50208	\$1.05
3"	50209	\$1.25
4"	50210	\$1.79
5"	50225	\$2.10
6"	50211	\$2.63
8"	50212	\$3.89
10"	50217	\$5.78
12"	50219	\$8.40

Split One			
Split Rings Plastic Floor and Ceiling Plates Chrome (Plastic)			
box qty.	Size	Part No.	List Price
12	½"	1430	\$0.93
12	¾"	1431	\$0.98
12	1"	1432	\$1.05
12	1¼"	1433	\$1.63
12	1½"	1434	\$1.68
12	2"	1435	\$1.74
12	2½"	1436	\$5.10
12	3"	1437	\$5.25
12	4"	1438A	\$5.50
6	5"	1439	\$8.93
6	6"	1440	\$11.30
6	8"	1441	\$15.60
Split Rings Plastic Floor and Ceiling Plates White (Plastic)			
box qty.	Size	Part No.	List Price
12	1"	1420	\$0.80
12	1¼"	1421	\$0.85
12	1½"	1422	\$0.88
12	2"	1423	\$0.90
12	2½"	1424	\$1.99
12	3"	1425	\$2.10
12	4"	1426A	\$2.20
6	5"	1427	\$3.80
6	6"	1428	\$6.95
Split Rings Plastic Floor and Ceiling Plates Chrome (Light Gauge Steel)			
box qty.	Size	Part No.	List Price
-	½"	21136	\$1.49
-	¾"	21137	\$1.54
-	1"	21138	\$1.61
-	1¼"	21139	\$1.88
-	1½"	21141	\$2.26
-	2"	21142	\$2.43

Flanged Fittings		
Flanged 90° Elbow		
Size	Part No.	List Price
2½"	500000	\$237.00
3"	500001A	\$237.00
4"	500002A	\$313.00
6"	500003A	\$500.00
8"	500004A	\$705.00
10"	500005A	\$1,331.00
12"	500006	\$1,915.00
Flanged 45° Elbow		
Size	Part No.	List Price
2½"	500007	\$284.00
3"	500008	\$284.00
4"	500009	\$360.00
6"	500010A	\$503.00
8"	500011A	\$722.00
10"	500012A	\$1,331.00
12"	500013A	\$1,941.00
Flanged Straight Tee		
Size	Part No.	List Price
2½"	500014A	\$350.00
3"	500015A	\$371.00
4"	500016A	\$572.00
6"	500017	\$721.00
8"	500018	\$1,114.00
10"	500019	\$1,941.00
12"	500020	\$2,725.00
Flanged Reducing Tee		
Size	Part No.	List Price
4" x 2½"	500083	\$542.00
4" x 3"	500036	\$610.00
6" x 3"	500037	\$834.00
6" x 4"	500038	\$834.00
8" x 4"	500041	\$1,306.00
8" x 6"	500042A	\$1,306.00
6" x 4" x 4"	500039	\$1,333.00
6" x 4" x 6"	500040	\$1,333.00
8" x 6" x 6"	500043A	\$2,112.00
8" x 6" x 8"	500044	\$2,112.00
10" x 4"	500045	\$1,844.00
10" x 6"	500046	\$2,012.00
10" x 8"	500047	\$2,012.00
12" x 4"	500048	\$3,074.00
12" x 6"	500049	\$3,074.00
12" x 8"	500050	\$3,074.00
12" x 10"	500051	\$3,074.00

Section C
Valves and Hose Equipment

 Section D
Backflow

 Section F
Pipe & Accessories

 Section H
Hangers

 Section J
Lubricants

 Section K
Misc.

Items shown on this sheet may not be stocked at all Tyco Fire Products warehouses. Please ask your local Tyco Fire Products location for availability. Freight terms may vary for non commonly stocked items. See latest Technical Data Sheets for specific Approvals, Listings, Design Parameters & available finishes. Prices subject to change without notice.

Section C
Valves and Hose Equipment

Section D
Backflow

Section F
Pipe & Accessories

Section H
Hangers

Section J
Lubricants

Section K
Misc.

Flanged Fittings		
Cast Iron Companion Flange		
Size	Part No.	List Price
2" x 6"	86710	\$35.00
2½" x 7"	86711	\$51.00
3" x 7½"	86712	\$65.00
4" x 9"	86713	\$96.00
6" x 11"	86714	\$138.00
8" x 13½"	86715	\$218.00
Flanged Concentric Reducer		
Size	Part No.	List Price
4" x 2½"	500086	\$487.00
4" x 2"	500126	\$487.00
4" x 3"	500052	\$493.00
6" x 3"	500053	\$663.00
6" x 4"	500054	\$696.00
8" x 4"	500055	\$818.00
8" x 6"	500056	\$818.00
10" x 4"	500057	\$1,111.00
10" x 6"	500058	\$1,258.00
10" x 8"	500059	\$1,462.00
12" x 4"	500060	\$1,960.00
12" x 6"	500061	\$2,037.00
12" x 8"	500062	\$2,264.00
12" x 10"	500063	\$2,437.00
Blind Flange		
Size	Part No.	List Price
2½"	500021	\$63.00
3"	500022A	\$65.00
4"	500023A	\$96.00
6"	500024A	\$174.00
8"	500025A	\$280.00
10"	500026A	\$413.00
12"	500027A	\$577.00
Long Radius Flanged 90° Elbow		
Size	Part No.	List Price
4"	500028	\$430.00
6"	500029	\$721.00
8"	500030	\$1,261.00
10"	500031	\$1,779.00
12"	500032A	\$2,848.00
Floor Flange		
Size	Part No.	List Price
1"	500110	\$34.00
1¼"	500111A	\$41.00
1½"	500112A	\$41.00
2"	500113A	\$42.00

Flanged Fittings		
Flanged Reducing 90° Elbow		
Size	Part No.	List Price
4" x 2½"	500125A	\$712.00
4" x 3"	500064	\$712.00
6" x 4"	500065	\$821.00
8" x 6"	500066	\$1,099.00
Flanged Bull Tee		
4" x 4" x 6"	500067	\$1,331.00
Flanged Eccentric Reducer		
6" x 4"	500069	\$738.00
6" x 5"	500090	\$769.00
8" x 4"	500091	\$870.00
8" x 5"	500092	\$922.00
8" x 6"	500070	\$870.00

Ductile Iron Fittings			
#811 Ductile Iron 90° Elbows			
Size	Part No.	List Price	Box Qty.
½"	86206	\$3.44	240
¾"	86205	\$3.59	120
1"	86200	\$4.40	70
1¼"	86201	\$6.30	40
1½"	86202	\$9.51	30
2"	86203	\$15.47	20
2½"	86204	\$31.15	10
#813 Ductile Iron 45° Elbows			
½"	86780	\$5.15	250
¾"	86781	\$5.18	150
1"	86280	\$6.20	90
1¼"	86281	\$8.34	50
1½"	86282	\$13.80	35
2"	86283	\$15.93	18
2½"	86782	\$39.66	12
#814 Ductile Iron Tees			
½"	86340	\$5.22	150
¾"	86341	\$6.29	90
1"	86230	\$5.79	60
1¼"	86231	\$10.60	35
1½"	86232	\$13.80	24
2"	86233	\$19.00	12
2½"	86234	\$46.74	8

Items shown on this sheet may not be stocked at all Tyco Fire Products warehouses. Please ask your local Tyco Fire Products location for availability. Freight terms may vary for non commonly stocked items. See latest Technical Data Sheets for specific Approvals, Listings, Design Parameters & available finishes. Prices subject to change without notice.

Price Book - Section F Pipe & Accessories

Ductile Iron Fittings			
#818 Ductile Iron Couplings			
Size	Part No.	List Price	Box Qty.
1/2"	72779	\$2.34	360
3/4"	72778	\$2.81	200
1"	72755	\$3.76	110
1 1/4"	72754	\$5.62	75
1 1/2"	72753	\$7.88	60
2"	72752	\$11.70	30
2 1/2"	72758	\$22.72	18
#820 Ductile Iron Caps			
1/2"	72776	\$2.60	500
3/4"	72777	\$3.08	300
1"	72824	\$4.69	180
1 1/4"	72756	\$6.00	110
1 1/2"	72822	\$8.02	80
2"	72823	\$11.67	45
2 1/2"	72825	\$31.91	25
#817 Ductile Iron Crosses			
1"	86284	\$16.99	45
1 1/4"	86285	\$23.93	25
1 1/2"	86286	\$31.29	20
2"	86287	\$43.88	10
#719 Ductile Iron Plugs			
1/2"	86292	\$1.37	500
3/4"	86293	\$1.67	300
1"	86294	\$2.35	200
1 1/4"	86295	\$3.23	110
1 1/2"	86296	\$4.19	80
2"	86297	\$5.38	45
#825 Ductile Iron Extension Pieces			
1/2" x 1 1/2"	72751	\$5.65	300
1/2" x 2"	72980	\$5.65	250
3/4" x 1 1/2"	72981	\$8.30	250
3/4" x 2"	72982	\$8.30	200
#817 Ductile Iron Reducing Crosses			
1 1/4" x 1 1/4" x 1" x 1"	86289	\$23.93	30
1 1/2" x 1 1/2" x 1" x 1"	86322	\$31.29	24
2" x 2" x 1" x 1"	86291	\$45.16	10
#827 Ductile Iron Hex Bushings			
1" x 1/2"	72726	\$4.18	280
1" x 3/4"	72762	\$4.18	280
1 1/4" x 1"	72763	\$4.66	150
1 1/2" x 1"	72757	\$5.42	100
1 1/2" x 1 1/4"	72764	\$5.39	100
2" x 1"	72759	\$6.75	80
2" x 1 1/4"	72761	\$6.75	80
2" x 1 1/2"	72775	\$6.79	80

Ductile Iron Fittings			
#816 Ductile Iron Reducing Couplings			
Size	Part No.	List Price	Box Qty.
3/4" x 1/2"	86772	\$3.30	150
1" x 1/2"	86228	\$4.89	140
1" x 3/4"	86229	\$6.52	120
#830 Ductile Iron Unions			
1/2"	86207	\$16.45	110
3/4"	86275	\$18.69	80
1"	86276	\$24.15	50
1 1/4"	86277	\$33.24	35
1 1/2"	86278	\$40.65	25
2"	86279	\$56.35	18
#812 Ductile Iron Reducing 90° Elbows			
3/4" x 1/2"	86342	\$3.66	160
1" x 1/2"	86210	\$4.98	110
1" x 3/4"	86211	\$4.78	90
1 1/4" x 1/2"	86212	\$10.10	75
1 1/4" x 3/4"	86213	\$8.65	60
1 1/4" x 1"	86214	\$7.90	55
1 1/2" x 3/4"	86221	\$12.56	45
1 1/2" x 1"	86215	\$10.95	40
1 1/2" x 1 1/4"	86216	\$10.90	35
2" x 3/4"	86217	\$18.45	30
2" x 1"	86218	\$18.08	25
2" x 1 1/2"	86220	\$18.26	20
2 1/2" x 2"	86762	\$43.68	15
Malleable Iron Plug			
1/4"	500114A	\$1.40	

Section C	Valves and Hose Equipment
Section D	Backflow
Section F	Pipe & Accessories
Section H	Hangers
Section J	Lubricants
Section K	Misc.

Items shown on this sheet may not be stocked at all Tyco Fire Products warehouses. Please ask your local Tyco Fire Products location for availability. Freight terms may vary for non commonly stocked items. See latest Technical Data Sheets for specific Approvals, Listings, Design Parameters & available finishes. Prices subject to change without notice.

Valves and Hose Equipment
Section C
Backflow
Section D
Pipe & Accessories
Section F
Hangers
Section H
Lubricants
Section J
Misc.
Section K

Ductile Iron Fittings			
#815 Ductile Iron Reducing Tees			
<i>Size</i>	<i>Part No.</i>	<i>List Price</i>	<i>Box Qty.</i>
3/4" x 3/4" x 1/2"	86235	\$8.50	95
3/4" x 3/4" x 1"	86755	\$10.05	65
1" x 1/2" x 1"	86236	\$6.99	55
1" x 3/4" x 1/2"	86756	\$10.49	80
1" x 3/4" x 3/4"	86757	\$10.05	65
1" x 3/4" x 1"	86237	\$8.20	55
1" x 1" x 1/2"	86238	\$6.50	65
1" x 1" x 3/4"	86239	\$7.81	60
1" x 1" x 1 1/4"	86240	\$10.40	45
1" x 1" x 1 1/2"	86241	\$18.55	35
1 1/4" x 1" x 1/2"	86242	\$10.40	50
1 1/4" x 1" x 3/4"	86243	\$11.88	50
1 1/4" x 1" x 1"	86244	\$10.40	45
1 1/4" x 1" x 1 1/4"	86245	\$10.40	40
1 1/4" x 1" x 1 1/2"	86246	\$13.52	30
1 1/4" x 1 1/4" x 1/2"	86247	\$10.40	45
1 1/4" x 1 1/4" x 3/4"	86248	\$11.29	45
1 1/4" x 1 1/4" x 1"	86249	\$10.40	40
1 1/4" x 1 1/4" x 1 1/2"	86250	\$18.55	30
1 1/4" x 1 1/4" x 2"	86251	\$28.43	24
1 1/2" x 1" x 1/2"	86252	\$21.08	40
1 1/2" x 1" x 3/4"	86253	\$19.90	40
1 1/2" x 1" x 1"	86254	\$18.55	30
1 1/2" x 1" x 1 1/2"	86256	\$13.52	30
1 1/2" x 1 1/4" x 1/2"	86257	\$14.64	40
1 1/2" x 1 1/4" x 3/4"	86258	\$15.47	40
1 1/2" x 1 1/4" x 1"	86259	\$13.52	30
1 1/2" x 1 1/4" x 2"	86260	\$28.43	20
1 1/2" x 1 1/2" x 1/2"	86261	\$13.52	35
1 1/2" x 1 1/2" x 3/4"	86262	\$14.64	35
1 1/2" x 1 1/2" x 1"	86263	\$13.52	30
1 1/2" x 1 1/2" x 1 1/4"	86264	\$18.55	30
1 1/2" x 1 1/2" x 2"	86265	\$27.90	20
2" x 1" x 2"	86266	\$19.18	15
2" x 1 1/4" x 2"	86267	\$20.75	15
2" x 1 1/2" x 1/2"	86268	\$21.97	30
2" x 1 1/2" x 3/4"	86269	\$21.97	25
2" x 1 1/2" x 1"	86270	\$19.18	20
2" x 1 1/2" x 1 1/2"	86272	\$27.90	20
2" x 1 1/2" x 2"	86273	\$21.97	15
2" x 2" x 1/2"	86222	\$19.18	20
2" x 2" x 3/4"	86223	\$19.18	20
2" x 2" x 1"	86224	\$19.18	20
2" x 2" x 1 1/4"	86225	\$20.75	20
2" x 2" x 1 1/2"	86226	\$21.97	15
2" x 2" x 2 1/2"	86227	\$52.99	10
2 1/2" x 2" x 3/4"	86274	\$51.97	15

Ductile Iron Fittings			
Central Sprinkler California Fittings			
<i>Size</i>	<i>Part No.</i>	<i>List Price</i>	<i>Box Qty.</i>
Male Outlet Red. Tee			
1" x 1/2" x 1"	42000	\$10.67	50
Male Outlet Tee			
1" x 1" x 1"	42001	\$10.67	45
Male 90° Street Elbow			
1" x 1"	42002	\$10.67	80
1" x 1/2"	42003	\$10.67	60

Items shown on this sheet may not be stocked at all Tyco Fire Products warehouses. Please ask your local Tyco Fire Products location for availability. Freight terms may vary for non commonly stocked items. See latest Technical Data Sheets for specific Approvals, Listings, Design Parameters & available finishes. Prices subject to change without notice.

Price Book - Section F Pipe & Accessories

Standard Black Nipple		
Size	Part No.	List Price
1/4" x Close	60103	\$1.59
1/4" x 2"	60271	\$1.65
1/4" x 2 1/2"	60272	\$2.15
1/4" x 3"	60270	\$2.15
1/4" x 3 1/2"	60267	\$2.48
1/4" x 4"	60143	\$2.48
1/4" x 4 1/2"	60268	\$3.81
1/4" x 5"	60266	\$3.81
1/4" x 5 1/2"	60265	\$4.50
1/4" x 6"	60144	\$4.50
1/2" x Close	60145	\$1.38
1/2" x 1 1/2"	60146	\$1.38
1/2" x 2"	60147	\$1.38
1/2" x 2 1/2"	60148	\$1.66
1/2" x 3"	60175	\$1.66
1/2" x 3 1/2"	60176	\$2.00
1/2" x 4"	60149	\$2.00
1/2" x 4 1/2"	60177	\$2.29
1/2" x 5"	60178	\$2.29
1/2" x 5 1/2"	60179	\$2.55
1/2" x 6"	60180	\$2.55
3/4" x Close	60181	\$1.59
3/4" x 2"	60150	\$1.63
3/4" x 2 1/2"	60151	\$1.91
3/4" x 3"	60152	\$1.91
3/4" x 3 1/2"	60182	\$2.36
3/4" x 4"	60183	\$2.36
3/4" x 4 1/2"	60184	\$2.93
3/4" x 5"	60185	\$2.93
3/4" x 5 1/2"	60186	\$3.38
3/4" x 6"	60187	\$3.38
1" x Close	60104	\$2.30
1" x 2"	60105	\$2.48
1" x 2 1/2"	60106	\$2.63
1" x 3"	60107	\$2.63
1" x 3 1/2"	60108	\$3.32
1" x 4"	60109	\$3.32
1" x 4 1/2"	60110	\$3.91
1" x 5"	60111	\$3.91
1" x 5 1/2"	60112	\$4.64
1" x 6"	60113	\$4.64
1" x 7"	60196	\$7.50
1" x 8"	60198	\$7.50
1" x 9"	60200	\$8.88
1" x 10"	60202	\$8.88
1" x 11"	60204	\$10.20
1" x 12"	60206	\$10.20
1 1/4" x Close	60114	\$2.93
1 1/4" x 2"	60115	\$3.22
1 1/4" x 2 1/2"	60116	\$3.51
1 1/4" x 3"	60117	\$3.51

Standard Black Nipple		
Size	Part No.	List Price
1 1/4" x 3 1/2"	60118	\$4.06
1 1/4" x 4"	60119	\$4.06
1 1/4" x 4 1/2"	60120	\$4.98
1 1/4" x 5"	60121	\$4.98
1 1/4" x 5 1/2"	60122	\$5.91
1 1/4" x 6"	60123	\$5.91
1 1/4" x 7"	60216	\$9.47
1 1/4" x 8"	60291	\$9.47
1 1/4" x 9"	60293	\$11.40
1 1/4" x 10"	60294	\$11.40
1 1/4" x 11"	60295	\$12.93
1 1/4" x 12"	60296	\$12.93
1 1/2" x Close	60124	\$3.62
1 1/2" x 2"	60125	\$3.96
1 1/2" x 2 1/2"	60126	\$4.37
1 1/2" x 3"	60127	\$4.37
1 1/2" x 3 1/2"	60128	\$4.92
1 1/2" x 4"	60129	\$4.92
1 1/2" x 4 1/2"	60130	\$6.02
1 1/2" x 5"	60131	\$6.02
1 1/2" x 5 1/2"	60132	\$6.88
1 1/2" x 6"	60133	\$6.88
1 1/2" x 7"	60157	\$10.87
1 1/2" x 8"	60159	\$10.87
1 1/2" x 9"	60170	\$12.73
1 1/2" x 10"	60171	\$12.73
2" x Close	60134	\$4.95
2" x 2 1/2"	60135	\$5.67
2" x 3"	60136	\$5.67
2" x 3 1/2"	60137	\$6.77
2" x 4"	60138	\$6.77
2" x 4 1/2"	60160	\$7.89
2" x 5"	60139	\$7.89
2" x 5 1/2"	60140	\$9.21
2" x 6"	60141	\$9.21
2" x 7"	60173	\$15.48
2" x 8"	60207	\$15.48
2" x 9"	60208	\$18.25
2" x 10"	60209	\$18.25
2" x 11"	60210	\$21.00
2" x 12"	60168	\$21.00
2 1/2" x Close	60142	\$15.20
2 1/2" x 3"	60161	\$15.59
2 1/2" x 3 1/2"	60162	\$18.11
2 1/2" x 4"	60163	\$18.11
2 1/2" x 4 1/2"	60164	\$19.87
2 1/2" x 5"	60165	\$19.87
2 1/2" x 5 1/2"	60166	\$21.29
2 1/2" x 6"	60167	\$21.29
4" x Close	60299	\$27.92

Section C	Valves and Hose Equipment
Section D	Backflow
Section F	Pipe & Accessories
Section H	Hangers
Section J	Lubricants
Section K	Misc.

Items shown on this sheet may not be stocked at all Tyco Fire Products warehouses. Please ask your local Tyco Fire Products location for availability. Freight terms may vary for non commonly stocked items. See latest Technical Data Sheets for specific Approvals, Listings, Design Parameters & available finishes. Prices subject to change without notice.

Valves and Hose Equipment

Section C

Backflow

Section D

Pipe & Accessories

Section F

Hangers

Section H

Lubricants

Section J

Misc.

Section K

Extra Heavy Black Nipple		
Size	Part No.	List Price
1/2" x Close	60153	\$2.29
1/2" x 2"	60154	\$2.29
1/2" x 2 1/2"	60211	\$2.76
1/2" x 3"	60212	\$2.76
1/2" x 4"	60194	\$3.32
3/4" x Close	60213	\$2.63
3/4" x 1 1/2"	60192	\$2.63
3/4" x 2"	60286	\$2.63
3/4" x 2 1/2"	60190	\$3.19
3/4" x 3"	60191	\$3.19

Galvanized Nipple		
Size	Part No.	List Price
1/4" x 2 1/2"	60223	\$2.76
1/2" x Close	60226	\$1.60
1/2" x 2"	60227	\$1.66
1/2" x 3"	60228	\$2.00
1/2" x 4"	60229	\$2.45
1/2" x 5"	60230	\$2.91
1/2" x 6"	86323	\$3.32
3/4" x Close	86324	\$1.93
3/4" x 2"	60260	\$2.08
3/4" x 3"	60261	\$2.31
3/4" x 4"	86326	\$2.93
3/4" x 5"	60262	\$3.60
3/4" x 6"	60219	\$4.29
1" x Close	50142	\$2.66
1" x 2"	50143	\$3.11
1" x 2 1/2"	50144	\$3.38
1" x 3"	50145	\$3.38
1" x 4"	60221	\$4.08
1" x 5"	50149	\$4.98
1" x 6"	60222	\$5.59
1 1/2" x Close	50168	\$3.91
1 1/2" x 2"	50169	\$4.57
1 1/2" x 4"	50173	\$6.29
2" x 2 1/2"	50179	\$6.50
2" x 3"	50180	\$6.50
2 1/2" x 3"	50188	\$18.03

Items shown on this sheet may not be stocked at all Tyco Fire Products warehouses. Please ask your local Tyco Fire Products location for availability. Freight terms may vary for non commonly stocked items. See latest Technical Data Sheets for specific Approvals, Listings, Design Parameters & available finishes. Prices subject to change without notice.

Price Book - Section H Hangers

Erico Hangers			
CPVC Hanger - One Hole Strap - #107			
box qty.	Size	Part No.	List Price (ea.)
100	3/4"	90360	\$0.91
100	1"	90361	\$0.96
100	1 1/4"	90362	\$1.00
100	1 1/2"	90363	\$1.05
100	2"	90364	\$1.18
CPVC Hanger - Two Hole Strap - #108			
100	3/4"	90365	\$1.00
100	1"	90366	\$1.04
100	1 1/4"	90367	\$1.08
100	1 1/2"	90368	\$1.11
100	2"	90369	\$1.26
CPVC Hanger - Side Mount Strap - #109			
100	3/4"	90370	\$1.28
100	1"	90371	\$1.30
100	1 1/4"	90372	\$1.40
100	1 1/2"	90373	\$1.49
100	2"	90374	\$1.67
CPVC Hanger - No-Block Hangers			
100	3/4"	NB 75	\$1.65
100	1"	NB 1	\$1.68
100	1 1/4"	NB 125	\$1.78
100	1 1/2"	NB 15	\$1.96
100	2"	NB 2	\$2.07
CPVC Hanger - Head-Set Bracket			
100	SHB1		\$3.40
CPVC Surge Restraint			
100	90375		\$1.46
Heavy Duty Swivel Hanger - Model 115			
100	1"	150100	\$0.74
100	1 1/4"	150125	\$0.76
100	1 1/2"	150150	\$0.76
100	2"	150200	\$0.82
50	2 1/2"	150250	\$1.43
50	3"	115300	\$1.46
25	4"	115400	\$2.31
25	5"	115500	\$4.02
20	6"	115600	\$4.07
15	8"	115800	\$4.75

Erico Hangers			
Beam Clamps Universal/Reversible			
Double Rod Hole - Model 300			
box qty.	Size	Part No.	List Price (ea.)
100	3/8"	300038	\$1.93
50	1/2"	300050	\$3.20
Heavy Duty Beam Clamps			
- Model 547			
-	3/8"	494470	\$6.08
Beam Clamps Big Mouth			
Double Rod Hole - Model 310			
5"	3/8"	310038	\$3.40
50	1/2"	310050	\$4.04
Steel C-Clamp - Model 200			
100	3/8"	200038	\$2.48
Eye Sockets - Model 37			
500	3/8"	370038	\$1.40
100	1/2"	370050	\$1.91
300-C Retaining Strap (Bulk Units)			
Size	Part No.	List Price (ea.)	
3/8" or x 6"	302001	\$1.93	
3/8" or x 8"	302002	\$2.20	
3/8" x 10	302003	\$2.55	
1/2" x 6	302005	\$1.93	
1/2" x 8	302006	\$2.20	
1/2" x 10	302007	\$2.55	
Eye Socket Offset - Model 38			
box qty.	Size	Part No.	List Price (ea.)
250	3/8"	380038	\$1.59
Wide Flange Purlin Clamp - Model 315			
25	3/8"	315438	\$15.46
Steel Wood Drive Screw - Model 43			
100	16" x 2"	430162	\$2.92
100	14" x 2"	430142	\$2.51

Section C
Valves and Hose Equipment

 Section D
Backflow

 Section F
Pipe & Accessories

 Section H
Hangers

 Section J
Lubricants

 Section K
Misc.

Items shown on this sheet may not be stocked at all Tyco Fire Products warehouses. Please ask your local Tyco Fire Products location for availability. Freight terms may vary for non commonly stocked items. See latest Technical Data Sheets for specific Approvals, Listings, Design Parameters & available finishes. Prices subject to change without notice.

Section C
Valves and Hose Equipment

Section D
Backflow

Section F
Pipe & Accessories

Section H
Hangers

Section J
Lubricants

Section K
Misc.

Erico Hangers			
Steel Rod Coupling - Model 25			
box qty.	Size	Part No.	List Price (ea.)
100	3/8"	250038	\$1.43
100	1/2"	250050	\$1.79
100	5/8"	250055A	\$4.75
100	3/4"	250051A	\$8.87
50	7/8"	250060	\$26.65
Steel Short Rod Coupling - Model 25S			
	Size	Part No.	List Price (ea.)
	3/8"	250039	\$1.54
	1/2"	250049	\$1.56
Knurled Hanger Inserts - Model 100N			
box qty.	Size	Part No.	List Price (ea.)
Bulk	3/8"	200036	\$0.53
Bulk	1/2"	200037	\$1.41
Coach Screw Rod Machine Thread - Model 41			
100	3/8" x 4	414038	\$0.84
100	3/8" x 6	416038	\$0.88
100	3/8" x 8	418038	\$1.25
100	3/8" x 10	419038	\$1.91
100	1/2" x 6	414039	\$3.16
Lag Screw - Model 42			
100	3/8" x 1 1/2"	420050	\$0.44
100	3/8" x 2"	420020	\$0.49
100	3/8" x 2 1/2"	420025	\$0.53
50	1/2" x 2 1/2"	420027	\$0.88
50	1/2" x 3	420028	\$1.00
50	1/2" x 4	420029	\$1.10
Clevis Hanger Standard Model 400			
50	1"	450188	\$1.51
50	1 1/4"	450189	\$2.32
50	1 1/2"	450190	\$1.96
50	2"	450191	\$2.21
50	2 1/2"	450192	\$3.50
50	3"	450195	\$4.18
50	3 1/2"	450202	\$4.62
30	4"	450197	\$5.43
25	5"	450203	\$7.36
20	6"	450199	\$8.57
10"	8"	450196	\$14.15
Bulk	10"	450194	\$25.30
Bulk	12"	450204	\$31.40

Erico Hangers			
Steel Concrete Insert - Model 355			
box qty.	Size	Part No.	List Price (ea.)
150		355000	\$3.27
Concrete Insert Nut - Model 355N			
100	3/8"	355038	\$1.79
100	1/2"	355050	\$2.12
Nail Plate - Model 30482			
100		304001	\$0.94
Adjustable Bracket - Model TSGB16			
	16"	47616	\$4.69
Pipe Clamp - Model TPC238			
	5/8" x 2-3/8"	45866	\$3.96
Plastic Rod Button - Model 15			
	Size	Part No.	List Price (ea.)
	3/8"	492150	\$1.42
Toggle - Model 148			
	3/8"	492990	\$2.93
Pipe Clamp Standard - Model 450			
box qty.	Size	Part No.	List Price (ea.)
50	1"	450126	\$6.78
50	1 1/4"	450125	\$7.55
25	1 1/2"	450150	\$7.55
25	2"	450200	\$7.73
25	2 1/2"	450250	\$9.36
25	3"	450300	\$10.61
25	4"	450400	\$11.00
10"	5"	450500	\$21.36
Bulk	6"	450600	\$23.88
Bulk	8"	450800	\$28.27
Riser Clamp Galvanized - Model 510			
25	1"	510101	\$4.57
25	1 1/4"	510126	\$5.63
25	1 1/2"	510151	\$5.94
25	2"	510201	\$6.18
25	2 1/2"	510251	\$6.52
20	3"	510301	\$7.10
15	4"	510401	\$8.96
10"	5"	510501	\$12.56
Bulk	6"	510601	\$14.84
Bulk	8"	510801	\$28.88

Items shown on this sheet may not be stocked at all Tyco Fire Products warehouses. Please ask your local Tyco Fire Products location for availability. Freight terms may vary for non commonly stocked items. See latest Technical Data Sheets for specific Approvals, Listings, Design Parameters & available finishes. Prices subject to change without notice.

Price Book - Section H Hangers

Erico Hangers			
Steel Side Beam Attachment - Model 325			
box qty.	Size	Part No.	List Price (ea.)
100	3/8"	325038	\$2.80
	1/2"	325050	\$3.14
Tapped Side Beam Steel Connector - Model 328			
100	3/8"	327038	\$4.02
Steel Wall Plate - Model 365			
250	3/8"	365038	\$1.44
Yook U Type Hanger - Model 135 (Fits 1" & 1 1/4" Pipe)			
50	6"	13506A	\$2.92
50	8"	13508	\$3.83
50	10"	13510	\$4.02
Yook U Type Hanger - Model 135 (Fits 1 1/2" & 2" Pipe)			
50	6"	13514	\$3.60
50	8"	13516	\$3.68
50	10"	13518	\$3.72
50	12"	13520	\$3.83
Yook U Type Hanger - Model 135 (Fits 2 1/2" & 3" Pipe)			
Bulk	8"	13523	\$3.90
Bulk	10"	13524A	\$4.28
Yook U Type Hanger - Model 135 (Fits 3 1/2" & 4" Pipe)			
Bulk	8"	13528	\$4.69
Strut Clamp - Model RIGD			
100	1/2"	450172	\$1.55
100	3/4"	450173	\$1.63
100	1"	450174	\$1.86
50	1 1/4"	450151	\$2.16
50	1 1/2"	450152	\$2.48
50	2"	450153	\$2.74
25	2 1/2"	450154	\$3.09
25	3"	450155	\$3.32
25	4"	450156	\$4.39
25	5"	450175	\$6.27
25	6"	450176	\$8.40
25	8"	450177	\$12.05

Erico Hangers			
Multi-Flange Rod Hanger			
box qty.	Size	Part No.	List Price (ea.)
25	3/8" - PHSW6FP	327040	\$9.80
25	3/8" - PH6FP	327041	\$5.42
	3/8" - PHSW6	327042	\$9.70

Section C	Valves and Hose Equipment
Section D	Backflow
Section F	Pipe & Accessories
Section H	Hangers
Section J	Lubricants
Section K	Misc.

Items shown on this sheet may not be stocked at all Tyco Fire Products warehouses. Please ask your local Tyco Fire Products location for availability. Freight terms may vary for non commonly stocked items. See latest Technical Data Sheets for specific Approvals, Listings, Design Parameters & available finishes. Prices subject to change without notice.

Section C
Valves and Hose Equipment

Section D
Backflow

Section F
Pipe & Accessories

Section H
Hangers

Section J
Lubricants

Section K
Misc.

Tolco for CPVC			
Hangers for CPVC Plastic Pipe Single Fastener Strap Type - Model 22			
<i>box qty.</i>	<i>Size</i>	<i>Part No.</i>	<i>List Price (ea.)</i>
100	3/4"	90180	\$1.07
100	1"	90181	\$1.12
100	1 1/4"	90182	\$1.17
100	1 1/2"	90183	\$1.23
100	2"	90184	\$1.38
Hangers for CPVC Plastic Pipe Double Fastener Strap Type - Model 23			
100	3/4"	90185	\$1.17
100	1"	90186	\$1.22
100	1 1/4"	90187	\$1.25
100	1 1/2"	90188	\$1.33
100	2"	90189	\$1.50
100	2-1/2"	91189	\$4.43
Hangers for CPVC Plastic Pipe Double Fastener Strap Type Side Mount - Model 24			
100	3/4"	90191	\$1.56
100	1"	90192	\$1.68
100	1 1/4"	90193	\$1.74
100	1 1/2"	90194	\$2.01
100	2"	90195	\$2.22
Ring Hangers - Model 200			
100	3/4"	80190	\$0.78
100	1"	80191	\$0.79
100	1 1/4"	80192	\$0.79
100	1 1/2"	80193	\$0.81
100	2"	80194	\$0.85
100	2 1/2"	80195	\$1.73
75	3"	81300	\$1.86

Tolco Earthquake Bracing			
Fast Clamp Sway Brace Attachment - #1000			
<i>box qty.</i>	<i>Size</i>	<i>Part No.</i>	<i>List Price (ea.)</i>
25	1 x 1"	200100	\$14.08
25	1 x 1 1/4"	200101	\$16.88
25	1 1/4 x 1"	200102	\$14.08
25	1 1/4 x 1 1/4"	200103	\$16.88
25	1 1/2 x 1"	200104	\$14.08
25	1 1/2 x 1 1/4"	200105	\$16.88
25	2 x 1"	200106	\$14.08
25	2 x 1 1/4"	200107	\$16.88
20	2 1/2 x 1"	200108	\$14.63
25	2 1/2 x 1 1/4"	200109	\$17.62
20	3 x 1"	200110	\$14.94
20	3 x 1 1/4"	200111	\$17.62
20	4 x 1"	200112	\$17.92
20	4 x 1 1/4"	200113	\$21.70
20	6 x 1"	200114	\$23.90
20	6 x 1 1/4"	200115	\$37.36
20	8 x 1"	200116	\$26.69
Fast Clamp Sway Brace Attachment - #1001			
10"	8 x 1 1/4"	201117	\$50.22
Longitudinal 4-way Brace Attachment - #907			
	<i>Size</i>	<i>Part No.</i>	<i>List Price (ea.)</i>
	1 x 1"	200120	\$16.09
	1 1/4 x 1"	200121	\$16.58
	1 1/4 x 1 1/4"	200122	\$16.65
Non-Threaded Structural Attachment - #909			
1"		200126	\$15.79
Threaded Structural Attachment - #910			
1"		200128	\$14.87
1 1/4"		200129	\$16.83
Threaded Straight Fittings - #975			
1"		200130	\$9.88
Pipe Clamp for Sway Bracing - #4A			
4"		200135	\$9.38
6"		200136	\$23.83
8"		200137	\$28.35
Beam Clamp Retaining Straps - #69			
3/8 x 4		200140	\$1.56
3/8 x 6		200141	\$1.56
3/8 x 8		200142	\$1.56
3/8 x 10		200143	\$1.74
3/8 x 12"		200144	\$1.93
1/2 x 4		200150	\$1.56
1/2 x 6		200151	\$1.56
1/2 x 8		200152	\$1.56
1/2 x 10		200153	\$1.74

Items shown on this sheet may not be stocked at all Tyco Fire Products warehouses. Please ask your local Tyco Fire Products location for availability. Freight terms may vary for non commonly stocked items. See latest Technical Data Sheets for specific Approvals, Listings, Design Parameters & available finishes. Prices subject to change without notice.

Price Book - Section H Hangers

Threaded Rod Company		
Black All Thread Rod		
<i>Size</i>	<i>Part No.</i>	<i>List Price/Foot</i>
3/8" x 6'	41050	\$0.73
3/8" x 10'	41052	\$0.73
3/8" x 12'	41053	\$0.73
1/2" x 6'	41060	\$1.36
1/2" x 10'	41061	\$1.36
1/2" x 12'	41062	\$1.36
5/8" x 6'	41064	\$2.31
5/8" x 10'	41063	\$2.31
3/4" x 10'	41065	\$3.50
7/8" x 10'	41066	\$5.08
Galv All Thread Rod		
3/8" x 6'	41058	\$0.90
3/8" x 10'	41056	\$0.90
1/2" x 6'	41059	\$1.67
1/2" x 10'	41057	\$1.67
All Thread Stud		
3/8" x 2"	41080	\$0.31
3/8" x 3"	41081	\$0.32
3/8" x 4"	41082	\$0.35
3/8" x 5"	41083	\$0.43
3/8" x 6"	41084	\$0.52
3/8" x 7"	41085	\$0.62
3/8" x 8"	41086	\$0.66
3/8" x 9"	41087	\$0.73
3/8" x 10"	41088	\$0.87
3/8" x 11"	41089	\$0.92
3/8" x 12"	41090	\$0.99
3/8" x 13"	41091	\$1.08
3/8" x 14"	41092	\$1.16
3/8" x 15"	41093	\$1.26
3/8" x 16"	41094	\$1.37
3/8" x 17"	41095	\$1.44
3/8" x 18"	41096	\$1.51
3/8" x 20"	41099	\$1.65
3/8" x 21"	41124	\$1.72
3/8" x 23"	41098	\$1.92
3/8" x 24"	41097	\$1.95

Elco Ind. - Hanger Mate		
Wood Screw		
<i>Size</i>	<i>Part No.</i>	<i>List Price (ea.)</i>
ZG650	21112	\$1.65
EZH665	21145	\$1.82
Screw		
ZG315	21111	\$1.55
Steel Screw		
EZG550	21113	\$1.40
EZG510	21148	\$1.90
Steel Screw w/Nuts		
EZH476	21149	\$1.93
EZG471	21140	\$1.65
Concrete Screw		
EZG730	21114	\$1.40
Drill Bit Adapter		
EZE240	21116	\$24.40
Masonry Bit		
EZE340	21117	\$6.50
Drive Sockets		
Wood/Metal	20113	\$40.60
Concrete	20114	\$48.60

Section C
Valves and Hose Equipment

Section D
Backflow

Section F
Pipe & Accessories

Section H
Hangers

Section J
Lubricants

Section K
Misc.

Items shown on this sheet may not be stocked at all Tyco Fire Products warehouses. Please ask your local Tyco Fire Products location for availability. Freight terms may vary for non commonly stocked items. See latest Technical Data Sheets for specific Approvals, Listings, Design Parameters & available finishes. Prices subject to change without notice.

Section C
Valves and Hose Equipment

Section D
Backflow

Section F
Pipe & Accessories

Section H
Hangers

Section J
Lubricants

Section K
Misc.

Sammy Super Screw		
Steel		
<i>Size</i>	<i>Part No.</i>	<i>List Price (ea.)</i>
DST 10 Sam Screw 3/8" x 1"	20081	\$1.78
DST 15 Sam Screw 3/8" x 1 1/2"	20082	\$1.83
DST 20 Sam Screw 3/8" x 2	20083	\$1.89
DST 25 Sam Screw 3/8" x 2 1/2"	20084	\$1.89
DST 30 Sam Screw 3/8" x 3	20085	\$1.95
DSTR 1 Sam Screw 1 1/4" X 1"	21189	\$1.78
DSTR 516 Sam Screw 5/16" x 1 1/4"	21190	\$2.06
Concrete		
SWC 20 Sam Screw 3/8" x 2	21192	\$2.62
Wood		
GST .75 Sam Screw 3/8" x 1"	20193	\$1.70
GST 10 Sam Screw 3/8" x 1"	20089	\$1.80
GST 20 Sam Screw 3/8" x 2	20090	\$1.70
GST 30 Sam Screw 3/8" x 3	20091	\$1.80
SST 30 Sam Screw 3/8" x 3	20092	\$1.86
Sammy Screw 1/4" x 1 1/2"	21191	\$2.34
Sidewinder Screw 1/4" x 1"	21181	\$2.18
Sidewinder Screw 5/16" x 1 1/4"	21182	\$2.57
Sidewinder Screw 1/4" x 1"	21183	\$2.69
Sidewinder Screw 1/4" x 1 1/2"	21184	\$2.52
Sidewinder Screw 5/16" x 1 1/4"	21185	\$2.69
Sidewinder Screw 1/4" x 1 1/2"	21186	\$2.69
Sidewinder Screw 1/4" x 1"	21187	\$2.64
Sidewinder Screw 1/4" x 2	21188	\$2.41
Sidewinder Screw 3/8" x 2 1/2"	21195	\$2.41
Nut Drivers		
<i>Description</i>	<i>Part No.</i>	<i>List Price (ea.)</i>
Sammy Screw Nut Driver	20086	\$25.20
Sammy Screw Sidewinder		
Nut Driver 16mm	20087	\$25.20
Sammy Screw X-Press Anchor		
XP-20 X-Press Anchor 20	21196	\$8.52
XP-35 X-Press Anchor 35	21197	\$8.52
Sammy Screw X-Press Install Tool		
XPIT X-Press Install tool	21198	\$303.00
X-Press Drill Bit		
X-Press Drill bit	21199	\$26.45

Sammy Super Screw		
Swivel-Head Wood Sammy Screw		
<i>Description</i>	<i>Part No.</i>	<i>List Price (ea.)</i>
SH-GST 20	20190	\$1.98
SH-GST 30	20191	\$2.16
Swivel-Head Steel Sammy Screw		
SH-DSTR1	21289	\$2.98

Items shown on this sheet may not be stocked at all Tyco Fire Products warehouses. Please ask your local Tyco Fire Products location for availability. Freight terms may vary for non commonly stocked items. See latest Technical Data Sheets for specific Approvals, Listings, Design Parameters & available finishes. Prices subject to change without notice.

Price Book - Section H Hangers

Afcon for CPVC		
Description	Part No.	List Price (ea.)
Model #509 CPVC Nail Plate Protector [Stud Guards]	81301	\$0.97

Afcon			
Sway Brace Clamp Model E-001			
box qty.	Size	Part No.	List Price (ea.)
25	1"	150014	\$15.64
25	1¼"	150018	\$15.64
25	1½"	150013	\$15.64
25	2"	150001	\$15.64
10"	2½"	150002	\$16.19
10"	3"	150003	\$16.42
10"	4"	150004	\$19.87
10"	6"	150005	\$28.50
5"	8"	150006	\$31.84
Sway Brace Clamp Model 410			
10"	4"	150174	\$12.75
	6"	150175	\$28.33
1¼" Pipe Sway Brace Clamp Model E-020			
25	1¼"	150020	\$18.75
25	1½"	150121	\$18.75
25	2"	150007	\$18.75
10"	2 ½"	150008	\$19.53
10"	3"	150009	\$19.70
10"	4"	150010	\$21.32
10"	6"	150011	\$33.39
5"	8"	150012	\$38.06
Threaded Attachment End - Model-070			
50	1"	150015	\$23.10
50	1¼"	150019	\$18.59
Locking Attachment - Model 077			
50	1"	150021	\$14.35
50	1¼"	150022	\$17.37

Afcon			
Surge Restrainer - Model 310			
box qty.	Size	Part No.	List Price (ea.)
	1" - 2"	302026	\$1.50
CPVC Offset Hanger - Model 514			
	¾"	90235	\$1.82
	1"	90236	\$1.87
	1¼"	90237	\$1.94
	1½"	90238	\$2.13
	2"	90239	\$2.33
Double Offset CPVC Hanger - Model 515			
	¾"	90245	\$3.04
	1"	90246	\$3.04

Section C	Valves and Hose Equipment
Section D	Backflow
Section F	Pipe & Accessories
Section H	Hangers
Section J	Lubricants
Section K	Misc.

Items shown on this sheet may not be stocked at all Tyco Fire Products warehouses. Please ask your local Tyco Fire Products location for availability. Freight terms may vary for non commonly stocked items. See latest Technical Data Sheets for specific Approvals, Listings, Design Parameters & available finishes. Prices subject to change without notice.

Section C
Valves and Hose Equipment

Section D
Backflow

Section F
Pipe & Accessories

**Section H
Hangers**

Section J
Lubricants

Section K
Misc.

Items shown on this sheet may not be stocked at all Tyco Fire Products warehouses. Please ask your local Tyco Fire Products location for availability. Freight terms may vary for non commonly stocked items. See latest Technical Data Sheets for specific Approvals, Listings, Design Parameters & available finishes. Prices subject to change without notice.

Price Book - Section J Lubricants

LA-CO Industries		
Thread Sealant Paste		
Description	Part No.	List Price
Slic-Tite Qt	32004	\$46.80
Slic-Tite Qt BIC*	32025	\$54.60
* BIC - Brush In Can		
Gasket Lubricant		
Lubri-Joint Qt	32005	See Section 18 for list prices
Lubri-Joint Gal	32006	
Tape		
Tefl-Tape 1/2 x 520	32014	\$0.84
Tefl-Tape 3/4 x 520	32015	\$1.50
Acid Brush 1/2"	32016	\$0.55
Pipe Markers (Valve Action)		
White	32017	\$4.00
Yellow	32018	\$4.00
Red	32019	\$4.00
Blue	32020	\$4.00

Noble Company "Fire Fighter"		
Anti-Freeze - Glycol for Steel Pipe (pre-mix)		
Description	Part No.	List Price
1 Gallon	54010	\$25.00
5 Gallon	54011	\$125.50
55 Gallon	54012	\$1,324.00
Anti-Freeze - Glycol for Steel Pipe (concentrate)		
5 Gallon	54014	\$256.00
55 Gallon	54015	\$2,800.00

Gasket Lubricant		
Silicon Gasket Lubricant (for use with Dry Pipe & Freezer Applications) Dow Corning #DC No. 7 Recommended for Tri-Seal Gaskets		
Description	Part No.	List Price
5.30 oz. Tube	32037	See Section 18 for current list prices
8 lb Can	32038	

Section C
Valves and Hose Equipment

 Section D
Backflow

 Section F
Pipe & Accessories

 Section H
Hangers

 Section J
Lubricants

 Section K
Misc.

Items shown on this sheet may not be stocked at all Tyco Fire Products warehouses. Please ask your local Tyco Fire Products location for availability. Freight terms may vary for non commonly stocked items. See latest Technical Data Sheets for specific Approvals, Listings, Design Parameters & available finishes. Prices subject to change without notice.

Sealant			
FPPI Thread-Fit Cutting Oil			
	<i>Description</i>	<i>Part No.</i>	<i>List Price</i>
Section C Valves and Hose Equipment	1-gallon	320040	\$39.70
	5-gallon	320041	\$186.00
	55-gallon	320042	\$1,880.00
FPPI PipeFit Thread Sealant			
Section D Backflow	1-pint Can BIC	320030	\$14.00
	1-quart Can	320031	\$22.55
	1-gallon Can	320032	\$85.40
	5-gallon Can	320033	\$353.00
Oatey Great White Thread Sealant			
Section F Pipe & Accessories	4-ounce	31230	\$5.55
	8-ounce	31231	\$8.85
	1-pint	31232	\$15.75
	1-quart	31233	\$28.35
FPPI LubeFit Gasket Lubricant			
Section H Hangers	2-Lb	320043	\$10.25
	55-gallon	320044	\$1,469.00
Section J Lubricants			
Section K Misc.			

Items shown on this sheet may not be stocked at all Tyco Fire Products warehouses. Please ask your local Tyco Fire Products location for availability. Freight terms may vary for non commonly stocked items. See latest Technical Data Sheets for specific Approvals, Listings, Design Parameters & available finishes. Prices subject to change without notice.

MIFAB / PMR		
Access Doors		
<i>Description</i>	<i>Part No.</i>	<i>List Price</i>
VA, 12" x 24" - Drywall	21070	\$90.00
VA, 14" x 14" - Drywall	21071	\$44.00
VA, 16" x 16" - Drywall	21072	\$48.00
UA, 12" x 12" - Drywall	21075	\$66.00
UA, 24" x 24" - Drywall	21076	\$139.00
UA 8" x 8" Drywall	21078	\$37.00
UA 16" x 20" Drywall	21083	\$65.00
UA 16" x 24" Drywall	21084	\$72.00
UA 18" x 18" Drywall	21085	\$95.00

Acudor Products		
Access Door, Flush, Prime coated steel, UF5000		
<i>Description</i>	<i>Part No.</i>	<i>List Price</i>
6" x 6"	22100	\$48.00
8" x 8"	22101	\$49.00
12" x 12"	22102	\$57.00
12" x 18"	22103	\$81.00
16" x 16"	22104	\$82.00
18" x 18"	22105	\$91.00
18" x 24"	22106	\$120.00
18" x 24" with drip edge	22107	\$170.00
24" x 36"	22108	\$202.00

CENTRAL CASTINGS	
Boxes	
<i>Description</i>	<i>List Price</i>
CCC Coupling Box (Box 10)	\$30.00
CCC Gaylord Box (Box 27)	\$53.00

Section C	Valves and Hose Equipment
Section D	Backflow
Section F	Pipe & Accessories
Section H	Hangers
Section J	Lubricants
Section K	Misc.

Items shown on this sheet may not be stocked at all Tyco Fire Products warehouses. Please ask your local Tyco Fire Products location for availability. Freight terms may vary for non commonly stocked items. See latest Technical Data Sheets for specific Approvals, Listings, Design Parameters & available finishes. Prices subject to change without notice.

Section C
Valves and Hose Equipment

Section D
Backflow

Section F
Pipe & Accessories

Section H
Hangers

Section J
Lubricants

Section K
Misc.

Items shown on this sheet may not be stocked at all Tyco Fire Products warehouses. Please ask your local Tyco Fire Products location for availability. Freight terms may vary for non commonly stocked items. See latest Technical Data Sheets for specific Approvals, Listings, Design Parameters & available finishes. Prices subject to change without notice.

Price Book Part Number Index

49-014 thru 49-060.....	7-3	51-396.....	2-9	52-813.....	13-11,13-7
49-200 thru 49-201.....	7-4	51-477.....	13-4,13-5,13-6	52-816.....	13-11,13-7
49-204.....	7-6	51-524 thru 51-534.....	4-6	52-817.....	13-11,13-9
49-206 thru 49-207.....	7-7	51-620 thru 51-623.....	6-3	52-818.....	13-11,13-8
49-208 thru 49-209.....	7-8	51-790.....	1-16	52-823.....	13-11,13-7
49-210.....	7-5,7-9	51-792.....	1-17	52-826.....	13-11,13-7
49-211.....	7-5	51-793.....	13-3	52-827.....	13-11,13-9
49-3XX.....	7-1	51-794.....	2-8	52-828.....	13-11,13-8
49-4XX.....	7-6	51-873.....	4-3	52-833.....	13-11,13-7
49-554 thru 49-556.....	7-5	51-887.....	3-2	52-836.....	13-11,13-7
49-7XX.....	7-2	51-888 thru 51-889.....	3-3	52-837.....	13-11,13-9
49-800 thru 49-802.....	7-3	51-893 thru 51-894.....	2-4	52-838.....	13-11,13-8
49-8XX thru 49-9XX.....	7-2	51-895.....	2-3	52-843.....	13-11,13-7
50-081 thru 50-082.....	7-4	51-896.....	2-2	52-846.....	13-11,13-7
50-110 thru 50-210.....	3-4	52-010.....	20-8	52-847.....	13-11,13-9
50-300 thru 50-305.....	6-2	52-069.....	16-1	52-848.....	13-11,13-8
50-400 thru 50-500.....	3-5	52-114.....	14-6	52-863.....	13-11,13-7
50-501.....	3-4	52-150.....	16-2	52-866.....	13-11,13-7
50-502.....	3-5	52-201 thru 52-204.....	8-1	52-867.....	13-11,13-9
50-510 thru 50-512.....	3-4	52-211.....	8-3	52-868.....	13-11,13-8
50-601 thru 50-625.....	6-3	52-270.....	16-3	53-101 thru 53-102.....	1-2
50-701.....	2-7	52-271.....	9-1	53-106 thru 53-107.....	1-3
50-711.....	6-1	52-280.....	13-3	53-111 thru 53-112.....	1-1
50-801.....	2-10	52-287.....	14-5,21-1	53-113.....	1-3
51-010.....	4-1	52-289.....	14-2,16-2	53-153.....	3-11
51-036 thru 51-040.....	6-14	52-302.....	20-4	53-253.....	3-10
51-041.....	7-9	52-309 thru 52-310.....	10-1	53-261.....	1-18
51-051 thru 51-053.....	2-10	52-311 thru 52-312.....	11-1	54-350.....	16-1
51-068 thru 51-069.....	4-7	52-324.....	14-5	54-360.....	8-4
51-072 thru 51-073.....	2-7	52-326.....	14-4	56-000.....	20-11,7-12,7-13
51-103.....	6-8	52-328.....	14-5	56-001.....	20-10,20-11,6-9
51-104.....	20-10	52-363.....	16-5	56-001 thru 56-010.....	7-13
51-106.....	20-11	52-370.....	16-4	56-012.....	20-10
51-107.....	6-9	52-380.....	16-1	56-015.....	3-10,3-11
51-112.....	4-4	52-390.....	16-5	56-070.....	3-8,3-9
51-122.....	4-3	52-403.....	9-	56-122 thru 56-123.....	4-4
51-123.....	4-4	52-477.....	13-1,13-2,13-4,13-5,13-6,14-5	56-124.....	4-5
51-124.....	4-5	52-478.....	14-7,14-8	56-125.....	16-2
51-136 thru 51-140.....	6-14	52-517.....	14-5	56-152.....	3-13
51-201.....	4-2	52-540.....	8-3	56-320.....	7-10
51-211.....	4-1	52-570.....	15-3	56-396.....	2-9
51-215.....	4-2	52-590.....	8-2	56-452 thru 56-665.....	7-13
51-301.....	6-1	52-630.....	14-6,9-1	56-700.....	2-4,7-11
51-310.....	2-1	52-789 thru 52-793.....	16-1	56-701.....	1-13,7-11
51-311.....	6-2	52-811.....	13-10	56-705.....	1-13,2-4

56-705 thru 56-711	7-11	58-973	1-4	1954-02 thru 1954-04.....	20-10
56-792	5-10	58-974	1-5	2202 thru 2245	C-2
56-798	7-13	58-981	1-4	2259.....	C-1
56-802	7-10	58-982	1-5	2262.....	C-2
56-850 thru 56-872	7-13	58-986	3-12	2264 thru 2269	C-1
56-873	4-7	59-300	15-3	2272 thru 2281	C-2
56-880 thru 56-885	7-10	59-590	14-5,15-1	2282 thru 2283	16-1
56-892	6-1	59-590 thru 59-591.....	8-2	2284.....	C-2
56-892 thru 56-895	7-13	59-592	15-1	2285 thru 2293	F-2
56-908 thru 56-938	7-12	59-801 thru 59-802.....	15-2	2296.....	C-2
56-952	3-12	63-000	5-10	2302 thru 2329	16-5
56-991-0-003 thru 56-991-9-003.....	20-9	91-106-0-007 thru 91-106-9-007	5-3	2338.....	16-1
57-330 thru 57-331	1-11	91-556	7-5	2344.....	21-2
57-333	3-8	92-000	7-12	2360 thru 2370	16-1
57-340 thru 57-341	1-12	92-020	20-5	2373.....	21-2
57-343	3-9	92-200	8-2	2374 thru 2387	21-1
57-370	1-13,6-6	92-210	8-3	2391.....	F-2
57-371	1-13,6-6	92-270	16-3	2394 thru 2396	21-1
57-373	6-12,6-6	92-280	13-3	2399.....	F-2
57-375	1-15	92-289	16-2	2412 thru 2428	21-1
57-376	2-5	92-302	20-4	2433.....	16-1
57-378	1-15	92-309	10-1	2440 thru 2489	21-1
57-390	1-14,6-6	92-311 thru 92-312.....	11-1	2501 thru 2509	C-3
57-391	1-14,6-6	92-322 thru 92-326.....	12-1	2571.....	14-6
57-393	6-13,6-6	92-343	14-5,16-2,8-1	2572.....	12-1
57-396	2-6	92-370	16-4	2573.....	14-6
57-533	3-6	92-414	20-4	2587 thru 2656	21-1
57-543	3-7	92-445	20-3	2665 thru 2667	19-4
57-560 thru 57-561	1-8	92-470	20-5	2745 thru 2761	C-3
57-570	1-7,6-4	92-477	13-2	2770 thru 2772	C-5
57-571	1-7,6-4	92-630	9-1	2954-02	20-10
57-573	6-10,6-4	100-25-700.....	7-11	3002 thru 3011	19-4
57-575	1-10,6-7	831 thru 836	20-9	3101-08	20-9
57-578	1-10,6-7	1111 thru 1124	7-12	3201 thru 3207	F-2
57-590	1-9,6-4	1150.....	7-10,7-11	4055 thru 4096	8-3
57-591	1-9,6-4	1152 thru 1153	7-10	4320 thru 4360	16-3
57-593	6-11,6-4	1153.....	7-11	5025 thru 5044	C-1
58-153	3-13	1174 thru 1175	7-10	5550 thru 5550-05.....	20-8
58-170	2-9	1177.....	7-12	5576.....	20-7
58-172 thru 58-174	1-6	1184.....	7-10,7-11	5785 thru 5792-01	20-8
58-440	3-2	1192 thru 1200	7-10	5801 thru 5803	20-7
58-441 thru 58-447	3-1	1274.....	20-9	5807 thru 5809	20-6
58-450	2-1	1420 thru 1441	F-3	5839 thru 5972	20-7
58-946	1-6	1480 thru 1484	20-9	6012.....	6-1
58-970	2-9	1667-4 thru 1667-61.....	20-6	6104.....	C-7

Price Book Part Number Index

6106 thru 6112.....	C-6	20897 thru 20898.....	D-2	41262 thru 41299.....	18-26
6115 thru 6126.....	C-7	21000.....	C-1	41302 thru 41338.....	C-2
6128 thru 6134.....	C-6	21010 thru 21015.....	D-1	41500 thru 41511.....	18-26
6137 thru 6138.....	C-7	21016 thru 21019.....	D-2	41512.....	18-25
6143 thru 6146.....	C-8	21020.....	C-1	41513 thru 41514.....	18-26
6150.....	C-7	21021 thru 21022.....	D-2	42000 thru 42003.....	F-6
6153 thru 6155.....	C-6	21023 thru 21027.....	D-1	43200 thru 43400.....	16-3
6156.....	C-7	21029 thru 21034.....	D-2	45866 thru 47616.....	H-2
6157 thru 6163.....	C-6	21040.....	C-1	50024 thru 50056.....	21-2
6170 thru 6171.....	C-7	21070 thru 21085.....	K-1	50057 thru 50094.....	21-3
8545-02 thru 8549-22.....	5-7	21111 thru 21117.....	H-5	50142 thru 50188.....	F-8
13508 thru 13528.....	H-3	21126.....	21-1	50208 thru 50225.....	F-3
15250 thru 17044.....	F-2	21136 thru 21139.....	F-3	50232 thru 50239.....	21-2
20081 thru 20092.....	H-6	21140.....	H-5	50240 thru 50248.....	18-4
20113 thru 20114.....	H-5	21141 thru 21142.....	F-3	50251 thru 50254.....	21-2
20125.....	14-6	21145 thru 21149.....	H-5	50258 thru 50269.....	21-3
20128 thru 20135.....	21-1	21181 thru 21199.....	H-6	50999 thru 51021.....	C-2
20190 thru 20193.....	H-6	21215 thru 21229.....	C-1	51280 thru 51310.....	C-3
20404 thru 20412.....	D-5	21232.....	F-2	52040 thru 52047.....	19-4
20414.....	D-6	21289.....	H-6	54010 thru 54015.....	J-1
20415.....	D-5	21549.....	D-2	60001 thru 60004.....	21-2
20416.....	D-6	22100 thru 22108.....	K-1	60010.....	21-3
20417.....	D-5	22441 thru 22461.....	C-3	60027 thru 60029.....	21-2
20418.....	D-6	22650 thru 22690.....	C-1	60038.....	21-3
20419.....	D-5	24100 thru 25730.....	21-1	60103 thru 60152.....	F-7
20420.....	D-6	25870 thru 25880.....	21-2	60153 thru 60154.....	F-8
20422 thru 20431.....	D-5	26144 thru 26145.....	21-1	60157 thru 60187.....	F-7
20432.....	D-6	26580 thru 26610.....	21-2	60190 thru 60194.....	F-8
20438 thru 20473.....	D-5	27450 thru 27710.....	C-3	60196 thru 60210.....	F-7
20475 thru 20477.....	D-6	27711.....	C-5	60211 thru 60213.....	F-8
20478 thru 20492.....	D-5	27900 thru 28040.....	C-3	60216.....	F-7
20504 thru 20521.....	C-1	28050 thru 28135.....	C-5	60219 thru 60230.....	F-8
20539 thru 20561.....	D-2	28140 thru 28355.....	C-4	60232 thru 60239.....	21-2
20592.....	C-1	28360 thru 28420.....	C-5	60243 thru 60249.....	21-3
20610 thru 20642.....	D-5	29500 thru 29525.....	21-1	60251.....	21-2
20647 thru 20648.....	D-6	31230 thru 31233.....	J-2	60252.....	21-3
20661 thru 20664.....	D-5	32004.....	J-1	60253.....	21-2
20669 thru 20680.....	D-6	32005 thru 32006.....	18-5	60254.....	21-3
20698.....	D-5	32014 thru 32025.....	J-1	60260 thru 60262.....	F-8
20700 thru 20788.....	D-2	32037 thru 32038.....	18-5	60265 thru 60272.....	F-7
20809 thru 20811.....	C-1	41001 thru 41011.....	F-2	60281 thru 60285.....	21-2
20813.....	D-5	41014 thru 41049.....	18-25	60286.....	F-8
20820.....	C-1	41050 thru 41124.....	H-5	60287 thru 60288.....	21-2
20822 thru 20839.....	D-2	41204 thru 41206.....	C-3	60291 thru 60299.....	F-7
20849 thru 20858.....	D-1	41250 thru 41261.....	18-25	61126.....	19-4

61230.....	C-7	80142 thru 80178	19-3	150121.....	H-7
61231 thru 61234	C-3	80179.....	19-2	150125 thru 150150	H-1
61240.....	C-7	80180.....	19-3	150174 thru 150175	H-7
61241 thru 61244	C-3	80190 thru 80195	H-4	150200 thru 150250	H-1
61250.....	C-7	80196 thru 80199	19-3	200036 thru 200037	H-2
61251.....	C-3	80200 thru 80215	19-2	200038.....	H-1
61260.....	C-7	80220.....	19-1	200100 thru 201117	H-4
61261 thru 61262	C-3	80249 thru 80258	19-3	205390 thru 205391	D-1
61280 thru 61435	C-6	80260 thru 80276	19-2	205392 thru 205393	D-3
61445 thru 61530	C-7	80300 thru 80308	19-1	205395 thru 205481	D-1
61535 thru 61590	C-6	80459 thru 80463	19-3	205482 thru 205483	D-3
61595 thru 61685	C-7	81300.....	H-4	205485 thru 205491	D-1
61690 thru 61695	C-8	81301.....	H-7	205492 thru 205493	D-3
72570 thru 72576	18-6	86200 thru 86206	F-4	205495 thru 205501	D-1
72726 thru 72825	F-5	86207 thru 86221	F-5	205502 thru 205503	D-3
72850 thru 72918	18-11	86222 thru 86227	F-6	205510 thru 205511	D-1
72980 thru 72982	F-5	86228 thru 86229	F-5	205512 thru 205513	D-3
73230 thru 73264	18-12	86230 thru 86234	F-4	205520 thru 205521	D-1
73392 thru 73425	18-11	86235 thru 86274	F-6	205522 thru 205523	D-3
73590 thru 73597	18-10	86275 thru 86279	F-5	205530 thru 205531	D-1
73608 thru 73611	18-13	86280 thru 86283	F-4	205532 thru 205533	D-3
73621 thru 73631	18-10	86284 thru 86322	F-5	205580 thru 205581	D-1
73691 thru 73697	18-13	86323 thru 86326	F-8	205582 thru 205583	D-3
73794 thru 73799	18-14	86340 thru 86341	F-4	205585 thru 205591	D-1
74253 thru 74283	18-12	86342.....	F-5	205592 thru 205593	D-3
74292 thru 74302	18-14	86710 thru 86715	F-4	205595 thru 205596	D-1
74304 thru 74331	18-15	86755 thru 86757	F-6	206115 thru 206195	D-5
74335.....	18-14	86762 thru 86772	F-5	206761.....	D-6
74405 thru 75108	18-15	86780 thru 86782	F-4	207190 thru 207191	D-1
75121 thru 75133	18-14	88100 thru 88109	F-2	207192 thru 207193	D-3
75148 thru 75158	18-15	90180 thru 90195	H-4	207670 thru 207671	D-1
75300 thru 75323	18-7	90235 thru 90246	H-7	207672.....	D-3
75410 thru 75489	18-10	90355 thru 90357	19-4	207680 thru 207681	D-1
75490 thru 75495	18-12	90360 thru 90375	H-1	207682.....	D-3
75500 thru 75546	18-13	90400 thru 90401	19-4	207690 thru 207691	D-1
75550 thru 75580	18-7	90610 thru 90645	D-3	207692.....	D-3
75590 thru 75853	18-13	90650 thru 90736	D-4	207700 thru 207701	D-1
76755.....	18-12	90740 thru 90761	19-4	207702.....	D-3
76757 thru 76759	18-13	90765.....	D-4	207710.....	D-1
76768 thru 76775	18-12	91189.....	H-4	207712.....	D-3
76800 thru 76839	18-14	91346.....	19-4	207880.....	D-2
80000 thru 80006	19-1	91725 thru 92736	D-4	208320 thru 208321	D-1
80008 thru 80015	19-2	115300 thru 115800	H-1	208322.....	D-3
80025 thru 80106	19-1	150001 thru 150022	H-7	208325 thru 208331	D-1
80132 thru 80141	19-2	150100.....	H-1	208332.....	D-3

Price Book Part Number Index

208335 thru 208341.....D-1	40018200 thru 40018600.....20-1	26015P.....18-23
208342.....D-3	40058000.....20-2	26015S.....18-9
208345 thru 208361.....D-1	60002000.....20-1	26020GP.....18-23
208362.....D-3	60003000.....20-4	26020GS.....18-9
208365 thru 208380.....D-1	60004000 thru 80101020.....20-1	26020P.....18-23
208382.....D-3	81303000 thru 81808000.....20-3	26020S.....18-9
208385.....D-1	81810000.....20-4	26020T1P.....18-24
250038 thru 250060.....H-2	81811000.....20-3	26020T1S.....18-9
251100 thru 251730.....F-1	81812000.....20-4	26020TP.....18-24
300038 thru 302007.....H-1	82400300 thru 82602500.....20-2	26020TS.....18-9
302026.....H-7	97602401 thru 97602501.....20-1	26025GP.....18-23
304001.....H-2	5502520S.....18-11	26025GS.....18-9
310038 thru 315438.....H-1	1081A thru 1098A.....20-9	26025P.....18-23
320030 thru 320044.....J-2	10EPDME3 thru 12EPDMEC.....18-4	26025S.....18-9
322110 thru 322810.....C-1	13506A thru 13524A.....H-3	26025T1P.....18-24
325038 thru 327042.....H-3	13EPDMAC thru 13EPDME3.....18-4	26025T1S.....18-9
355000 thru 355050.....H-2	1426A thru 1438A.....F-3	26025TP.....18-24
365038.....H-3	1487A.....20-9	26025TS.....18-9
370038 thru 380038.....H-1	15EPDMAC thru 15EPDME3.....18-4	26030GP.....18-23
414038 thru 420050.....H-2	20110GS thru 20150S.....18-7	26030GS thru 26030MS.....18-9
430142 thru 430162.....H-1	20411A.....D-5	26030P.....18-23
450125 thru 450150.....H-2	20EPDMAC thru 20EPDME3.....18-4	26030S.....18-9
450151 thru 450177.....H-3	21010GS thru 21012S.....18-6	26030T1P.....18-24
450188 thru 492990.....H-2	21028A.....D-1	26030T1S.....18-9
494470.....H-1	21050GS thru 21050S.....18-6	26030TP.....18-24
500000 thru 500020.....F-3	21910GS thru 21950S.....18-8	26030TS.....18-9
500021 thru 500031.....F-4	2203A thru 2206A.....C-2	26040GP.....18-23
500036 thru 500051.....F-3	2300A thru 2304A.....16-5	26040GS.....18-9
500052 thru 500070.....F-4	250051A thru 250055A.....H-2	26040P.....18-23
500083.....F-3	2502A.....C-3	26040S.....18-9
500086 thru 500126.....F-4	25EPDMAC thru 25EPDME3.....18-4	26040T1P.....18-24
510101 thru 510801.....H-2	26010GP.....18-23	26040T1S.....18-9
10908100.....7-12	26010GS.....18-9	26040TP.....18-24
12525000.....16-1	26010P.....18-23	26040TS thru 26050TS.....18-9
19071100.....19-4	26010S.....18-9	26060GP.....18-23
20018600.....20-4	26012GP.....18-23	26060GS thru 26060MS.....18-9
25004000 thru 25058000.....20-2	26012GS.....18-9	26060P.....18-23
25059000.....20-3	26012P.....18-23	26060S.....18-9
30002000 thru 30004000.....20-4	26012S.....18-9	26060T1P.....18-24
30010000.....20-1	26013GP.....18-23	26060T1S.....18-9
30018600.....20-4	26013GS.....18-9	26060TP.....18-24
30021000 thru 30023000.....20-1	26013P.....18-23	26060TS.....18-9
30058000.....20-2	26013S.....18-9	26080GP.....18-23
40002000.....20-1	26015GP.....18-23	26080GS.....18-9
40004000.....20-2	26015GS.....18-9	26080P.....18-23

26080S18-9	5041A C-1	510S30S 18-6
26080T1P18-24	50EPDME3 thru 50EPDMEC 18-4	510S40GP 18-22
26080T1S18-9	51010GP thru 51013GP 18-22	510S40GS 18-6
26080TP18-24	51013GS 18-6	510S40P 18-22
26080TS18-9	51013P 18-22	510S40S 18-6
30EPDMAC thru 40EPDME318-4	51013S 18-6	510S60GP 18-22
43100 ZCK-1 thru 43RTC16-3	51015GP 18-22	510S60GS 18-6
500001A thru 500016A F-3	51015GS 18-6	510S60P 18-22
500022A thru 500032A F-4	51015P 18-22	510S60S 18-6
500042A thru 500043A F-3	51015S 18-6	510S80GP 18-22
500111A thru 500113A F-4	51020GP 18-22	510S80GS 18-6
500114A F-5	51020GS 18-6	510S80P 18-22
500125A F-4	51020P 18-22	510S80S 18-6
50110GP thru 50113GP18-22	51020S thru 51025DS 18-6	51910GP thru 51913GP 18-23
50113GS18-7	51025GP 18-22	51913GS 18-8
50113P18-22	51025GS 18-6	51913P 18-23
50113S18-7	51025P 18-22	51913S 18-8
50115GP18-22	51025S thru 51030DS 18-6	51915GP 18-23
50115GS18-7	51030GP 18-22	51915GS 18-8
50115P18-22	51030GS 18-6	51915P 18-23
50115S18-7	51030P 18-22	51915S 18-8
50120GP18-22	51030S thru 51040DS 18-6	51920GP 18-23
50120GS18-7	51040GP 18-22	51920GS 18-8
50120P18-22	51040GS 18-6	51920P 18-23
50120S18-7	51040P 18-22	51920S 18-8
50125GP18-22	51040S thru 51060DS 18-6	51925GP 18-23
50125GS18-7	51060GP 18-22	51925GS 18-8
50125P18-22	51060GS 18-6	51925P 18-23
50125S18-7	51060P 18-22	51925S 18-8
50130GP18-22	51060S thru 51080DS 18-6	51930GP 18-23
50130GS18-7	51080GP 18-22	51930GS 18-8
50130P18-22	51080GS 18-6	51930P 18-23
50130S18-7	51080P 18-22	51930S 18-8
50140GP18-22	51080S 18-6	51940GP 18-23
50140GS18-7	510S20GP 18-22	51940GS 18-8
50140P18-22	510S20GS 18-6	51940P 18-23
50140S18-7	510S20P 18-22	51940S 18-8
50160GP18-22	510S20S 18-6	51960GP 18-23
50160GS18-7	510S25GP 18-22	51960GS 18-8
50160P18-22	510S25GS 18-6	51960P 18-23
50160S18-7	510S25P 18-22	51960S 18-8
50180GP18-22	510S25S 18-6	51980GP 18-23
50180GS18-7	510S30GP 18-22	51980GS 18-8
50180P18-22	510S30GS 18-6	51980P 18-23
50180S18-7	510S30P 18-22	51980S 18-8

Price Book Part Number Index

519S20GP 18-23	7110EPDME thru 7160S..... 18-4	7303015EGRCS 18-19
519S20GS 18-8	7162015EGS thru 7168060W..... 18-3	7303015EGRS 18-17
519S20P..... 18-23	7180EPDME thru 7180S..... 18-4	7303015EGS..... 18-16
519S20S..... 18-8	72858C thru 72926C 18-24	7303015ERCS 18-19
519S25GP 18-23	7302005EGS thru 7302010ES..... 18-16	7303015ERS..... 18-17
519S25GS 18-8	7302013ECS thru 7302013EGCS 18-18	7303015ES 18-16
519S25P..... 18-23	7302013EGRCS 18-19	7303020ECS thru 7303020EGCS..... 18-18
519S25S..... 18-8	7302013EGRS 18-17	7303020EGRCS 18-19
519S30GP 18-23	7302013EGS..... 18-16	7303020EGRS 18-17
519S30GS 18-8	7302013ERCS 18-19	7303020EGS..... 18-16
519S30P..... 18-23	7302013ERS..... 18-17	7303020ERCS 18-19
519S30S..... 18-8	7302013ES 18-16	7303020ERS..... 18-17
519S40GP 18-23	7302015ECS thru 7302015EGCS 18-18	7303020ES thru 7304010ES 18-16
519S40GS 18-8	7302015EGRCS 18-19	7304013ECS thru 7304013EGCS..... 18-18
519S40P..... 18-23	7302015EGRS 18-17	7304013EGRCS 18-19
519S40S..... 18-8	7302015EGS..... 18-16	7304013EGRS 18-17
519S60GP 18-23	7302015ERCS 18-19	7304013EGS..... 18-16
519S60GS 18-8	7302015ERS..... 18-17	7304013ERCS 18-19
519S60P..... 18-23	7302015ES thru 7302510ES 18-16	7304013ERS..... 18-17
519S60S..... 18-8	7302513ECS thru 7302513EGCS 18-18	7304013ES 18-16
519S80GP 18-23	7302513EGRCS..... 18-19	7304015ECS thru 7304015EGCS..... 18-18
519S80GS 18-8	7302513EGRS 18-17	7304015EGRCS 18-19
519S80P..... 18-23	7302513EGS..... 18-16	7304015EGRS 18-17
519S80S..... 18-8	7302513ERCS 18-19	7304015EGS..... 18-16
5502513GS thru 5508060S..... 18-11	7302513ERS..... 18-17	7304015ERCS 18-19
57713ACP thru 57780AGCP 18-21	7302513ES 18-16	7304015ERS..... 18-17
59025EPDME thru 59100EPDME 15-1	7302515ECS thru 7302515EGCS 18-18	7304015ES 18-16
60EPDMAC thru 60MEPDME3 18-4	7302515EGRCS 18-19	7304020ECS thru 7304020EGCS..... 18-18
70510E3GS thru 70512ESC 18-2	7302515EGRS 18-17	7304020EGRCS 18-19
70513ACP thru 70513AGCP 18-21	7302515EGS..... 18-16	7304020EGRS 18-17
70513AGSC thru 70513E3S 18-2	7302515ERCS 18-19	7304020EGS..... 18-16
70515ACP thru 70515AGCP 18-21	7302515ERS..... 18-17	7304020ERCS 18-19
70515AGSC thru 70515E3S 18-2	7302515ES thru 7302520EGP..... 18-16	7304020ERS..... 18-17
70520ACP thru 70520AGCP 18-21	7302520EGRP 18-17	7304020ES 18-16
70520AGSC thru 70520E3S 18-2	7302520EP 18-16	7304025ECS thru 7304025EGCS..... 18-18
70525ACP thru 70525AGCP 18-21	7302520ERP..... 18-17	7304025EGRCS 18-19
70525AGSC thru 70525E3S 18-2	7303005EGS thru 7303010ES..... 18-16	7304025EGRS 18-17
70530ACP thru 70530AGCP 18-21	7303013ECS thru 7303013EGCS 18-18	7304025EGS..... 18-16
70530AGSC thru 70530E3S 18-2	7303013EGRCS..... 18-19	7304025ERCS 18-19
70540ACP thru 70540AGCP 18-21	7303013EGRS 18-17	7304025ERS..... 18-17
70540AGSC thru 70550ESC 18-2	7303013EGS..... 18-16	7304025ES 18-16
70560ACP thru 70560AGCP 18-21	7303013ERCS 18-19	7304030ECS thru 7304030EGCS..... 18-18
70560AGSC thru 70560E3S 18-2	7303013ERS..... 18-17	7304030EGRCS 18-19
70580ACP thru 70580AGCP 18-21	7303013ES 18-16	7304030EGRS 18-17
70580AGSC thru 70580E3S 18-2	7303015ECS thru 7303015EGCS 18-18	7304030EGS..... 18-16

7304030ERCS.....	18-19	7306025ES	18-16	BT10615S thru BT78615S	18-5
7304030ERS.....	18-17	7306030ECS thru 7306030EGCS.....	18-18	HS1 thru NB 75.....	H-1
7304030ES thru 7305015EGP	18-16	7306030EGRCS	18-19	NT10S thru PT1000	18-5
7305015EGS thru 7305015EP	18-17	7306030EGRS.....	18-17	STP1305ES thru STP2510ES	18-19
7305020ECS thru 7305020EGCS.....	18-18	7306030EGS.....	18-16	TC100 thru TC1004.....	21-5
7305020EGRCS	18-19	7306030ERCS.....	18-19	TC1005X thru TC1010.....	21-6
7305020EGRS	18-17	7306030ERS	18-17	TC1011.....	21-5
7305020EGS.....	18-16	7306030ES	18-16	TC1012C thru TC1016.....	21-4
7305020ERCS.....	18-19	7306040ECS thru 7306040EGCS.....	18-18	TC1017C	21-5
7305020ERS.....	18-17	7306040EGRCS	18-19	TC1018C thru TC1018M.....	21-3
7305020ES	18-16	7306040EGRS.....	18-17	TC1019.....	21-5
7305025ECS thru 7305025EGCS.....	18-18	7306040EGS	18-16	TC1020C thru TC1030ZX	21-4
7305025EGRCS	18-19	7306040ERCS.....	18-19	TC1031SSC.....	21-5
7305025EGRS	18-17	7306040ERS.....	18-17	TC1031ZC	21-4
7305025EGS.....	18-16	7306040ES	18-16	TC1032C thru TC1033Z.....	21-5
7305025ERCS.....	18-19	7308025ECS thru 7308025EGCS.....	18-18	TC1034Q	21-4
7305025ERS.....	18-17	7308025EGRCS	18-19	TC1100L thru TC1100S.....	21-5
7305025ES thru 7305030EGP	18-16	7308025EGRS.....	18-17	TC155 thru TC172G	21-3
7305030EGRP	18-17	7308025EGS	18-16	TC4401 thru TC4406.....	21-6
7305030EP	18-16	7308025ERCS.....	18-19		
7305030ERP.....	18-17	7308025ERS.....	18-17		
7306013EGP.....	18-16	7308025ES	18-16		
7306013EGRP	18-17	7308030ECS thru 7308030EGCS.....	18-18		
7306013EP	18-16	7308030EGRCS	18-19		
7306013ERP.....	18-17	7308030EGRS.....	18-17		
7306015ECS thru 7306015EGCS.....	18-18	7308030EGS.....	18-16		
7306015EGRCS	18-19	7308030ERCS.....	18-19		
7306015EGRS	18-17	7308030ERS	18-17		
7306015EGS.....	18-16	7308030ES	18-16		
7306015ERCS.....	18-19	7308040ECS thru 7308040EGCS.....	18-18		
7306015ERS.....	18-17	7308040EGRCS	18-19		
7306015ES	18-16	7308040EGRS.....	18-17		
7306020ECS thru 7306020EGCS.....	18-18	7308040EGS.....	18-16		
7306020EGRCS	18-19	7308040ERCS.....	18-19		
7306020EGRS	18-17	7308040ERS.....	18-17		
7306020EGS.....	18-16	7308040ES thru 730EGS-1	18-16		
7306020ERCS.....	18-19	730EGS-2 thru 730EGS-9	18-17		
7306020ERS.....	18-17	73408C thru 73425C.....	18-24		
7306020ES	18-16	7501505S thru 7502510S.....	18-20		
7306025ECS thru 7306025EGCS.....	18-18	75411C thru 75480C.....	18-24		
7306025EGRCS	18-19	77210E3GS thru 77280E3S	18-1		
7306025EGRS	18-17	80175E thru 80176W.....	19-2		
7306025EGS.....	18-16	80177L.....	19-3		
7306025ERCS.....	18-19	80300T thru 80304T	19-1		
7306025ERS.....	18-17	80EPDMAC thru 80EPDME3	18-4		

tyco / Fire & Building Products



WORLDWIDE HEADQUARTERS

Tyco Fire & Building Products
451 N. Cannon Avenue
Lansdale, PA 19446
Tel: 215-362-0700, 800-523-6512
Fax: 215-362-5385
www.Tyco-Fire.com

UNITED STATES

Central Sprinkler Company
451 N. Cannon Avenue
Lansdale, PA 19446
Tel: 215-362-0700, Fax: 215-362-5385

Brea, CA:

Tel: 714-993-6111, Fax 714-993-6043

Decatur, GA:

Tel: 404-243-7336, Fax 404-244-7375

Norristown, PA:

Tel: 610-239-9925, Fax 610-239-9936

Jessup, MD:

Tel: 301-604-7133, Fax 301-604-7138

Carol Stream, IL:

Tel: 630-871-7700, Fax 630-871-7464

Coppell, TX:

Tel: 972-745-0043, Fax 972-745-8594

Kent, WA:

Tel: 253-872-6030, Fax 253-872-6547

Avon, MA:

Tel: 508-583-8447, Fax 508-583-0034

Pompano Beach, FL:

Tel: 954-781-0866, Fax 954-781-1475

Murray UT:

Tel: 801-269-0688, Fax 801-269-0733

Tigard, OR:

Tel: 503-620-4203, Fax 503-620-3817

Parma, OH:

Tel: 216-265-0505, Fax 216-265-8354

Kansas City, MO:

Tel: 816-842-2424, Fax 816-842-4433

National Distribution Facility
PO Box 2806
Lubbock, TX 79408-2806

UNITED STATES (cont.)

Gem Sprinkler & Star Sprinkler
7071 S. 13th Street, Ste. 103
Oak Creek, WI 53154
Tel: 877-436-8926, Fax: 877-866-9250

CANADA

Regional Headquarters
12-16715 Yonge Street, Suite 316
Newmarket, Ontario L3X 1X4
Tel: 866-688-9707, 705-422-0010
Fax 705-422-1396

EUROPE & MIDDLE EAST

Regional Headquarters
Kopersteden 1, NL-7547 TJ Enschede
P.O. Box 198, 7500 AD
Enschede, The Netherlands
Tel: 31-53-428-4444, Fax: 31-53-428-3377

Stockport, UK:

Tel: 44-161-477-1886, Fax 44-161-477-6729

Paris Nord II, France:

Tel: 33-1-48-178-727, Fax 33-1-48-178-720

Rodgau Germany:

Tel: 49-6106-84455, Fax 49-6106-18177

Coslada Madrid, Spain:

Tel: 34-1-669-3906, Fax 34-1-669-2018

Lørenskog, Norway:

Tel: 47-67-91-77-00, Fax 47-67-91-77-15

Lammhult, Sweden:

Tel: 46-472-269-980, Fax 46-472-269-989

Dublin, Ireland:

Tel: 353-166-839-82, Fax 353-166-822-54

Bolzano, Italy:

Tel: 39-0471-252-091, Fax 39-0471-254-058

Milano, Italy:

Tel: 39-0293-548-736, Fax 39-0293-548-690

Dubai, United Arab Emirates:

Tel: 971-488-38689, Fax 971-488-38674

Budapest, Hungary:

Tel: 36-148-11-383, Fax 36-120-34-427

Wels/Thalheim, Austria:

Tel: 43-072-42-65-054, Fax 43-072-42-74-393

LATIN AMERICA

Regional Headquarters
South America, Central America & Caribbean
1802 S.W. 2nd St.
Pompano Beach, FL 33069
Tel: 954-781-0866, Fax 954-781-9330

Regional Headquarters - Mexico

Hamburgo 231A Piso 2
Colonia Juarez
Mexico, D.F. 06600 Mexico
Tel: 525-55-2075766, Fax: 525-55-2077566

ASIA

Regional Headquarters
No.45 Tuas Avenue 9,
Singapore 639189

Central Sprinkler Company Singapore:

Tel: 65- 6743-3212, Fax 65-6743-9181

Shanghai, China:

Tel: 86-21-5868-3300, Fax 86-21-5868-1160

Beijing, China:

Tel: 86-10-6515-6191, Fax 86-10-6515-6157

Chengdu, China:

Tel: 86-28-689-9440, Fax 86-28-666-2538

Gem Sprinkler Company & Star Sprinkler Inc. Singapore:

Tel: 65-6861-1655, Fax 65-6861-1312

Kuala Lumpur, Malaysia:

Tel: 60-3-8024-6773, Fax 60-3-8024-2180

Hong Kong:

Tel: 852-2595-0686, Fax 852-2505-5826

www.tyco-fire.com

Distributed by: