

This unit offers anti-siphon protection.

The freezeless Model 17 is designed and intended for year-round residential irrigation purposes regardless of outside temperature. This faucet will not rupture from freezing when the valve is shut off and the hose is removed. The Model 17 contains an integral backflow protection device which protects up to 125 psi of backpressure and therefore does not require and add-on vacuum breaker.

SPECIFICATIONS:

- Manufactured under one or more of the following patents: 3,208,715; 3,278,201; 5,590,679; 5,632,303
- ASSE 1019 - Type C Listed
- CSA, cUPC Approved



FEATURES:

- 3/4" male hose thread nozzle
- Stainless steel seat - eliminates wire draw
- EPDM packing to prevent leaking
- Full circle operating threads on valve body and retainer
- No-lead solder
- Standard "O" size seat washer
- Powder-coated, die cast aluminum handle
 - Optional Tee Key available (extra charge)
- Adjustable polycarbonate wall flange
- **MAX PRESSURE** - 125 p.s.i.
- **MAX TEMPERATURE** - 120° F

WARNING - Faucet must be installed with downward pitch toward nozzle and hose must be removed in freezing weather or faucet may freeze and burst.
Not intended for continuous use applications.

Rough-In Dimensions

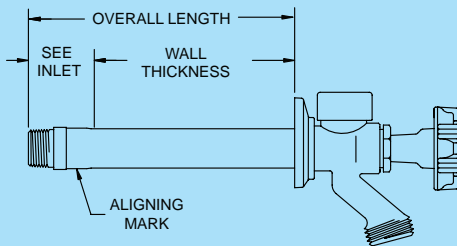

| Wall Thickness (inches) | | | | | | | | | | |
|-------------------------|-----|-----|-----|-----|-----|-----|-----|-----|-----|-----|
| 4 | 6 | 8 | 10 | 12 | 14 | 16 | 18 | 20 | 22 | 24 |
| 1.2 | 1.3 | 1.4 | 1.5 | 1.6 | 1.7 | 1.8 | 1.9 | 2.0 | 2.1 | 2.2 |

Shipping Wt. Ea. (lbs)
 *Overall Length Dimension: Add wall thickness and inlet option length shown in chart above.

For Installation / Troubleshooting Instructions go to www.woodfordmfg.com or call 1-800-621-6032

Freezeless Anti-Siphon Wall Faucet Model 17



Inlet Descriptions

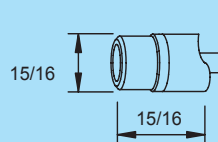

C Inlet COMBINATION
 Copper Sweat Fitting
 1/2" K, L or M Inside
 3/4" M Only Outside

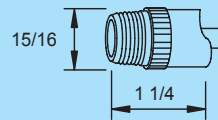

CP Inlet COMBINATION
 1/2" Male Pipe Thread
 1/2" Female Sweat

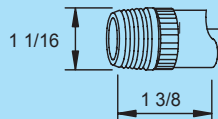

CP3 Inlet COMBINATION
 3/4" Male Pipe Thread
 3/4" Female Sweat

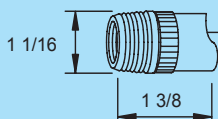

P Inlet COMBINATION
 1/2" Female Pipe Thread
 3/4" Male Pipe Thread

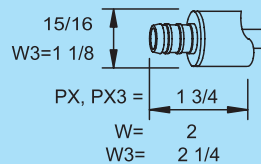

PX Inlet
 1/2" PEX Tube Fitting
PX3 INLET
 3/4" PEX Tube Fitting
W Inlet
 1/2" Wirsbo Tube Fitting
W3 INLET
 3/4" Wirsbo PEX Tube Fitting
R Inlet
 1/2" Rehau Tube Fitting

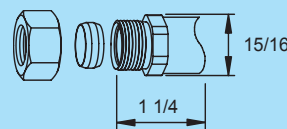

CM Inlet COMBINATION
 1/2" Compression Fitting
 1/2" Copper Sweat Fitting

When ordering, specify model , inlet and wall thickness.

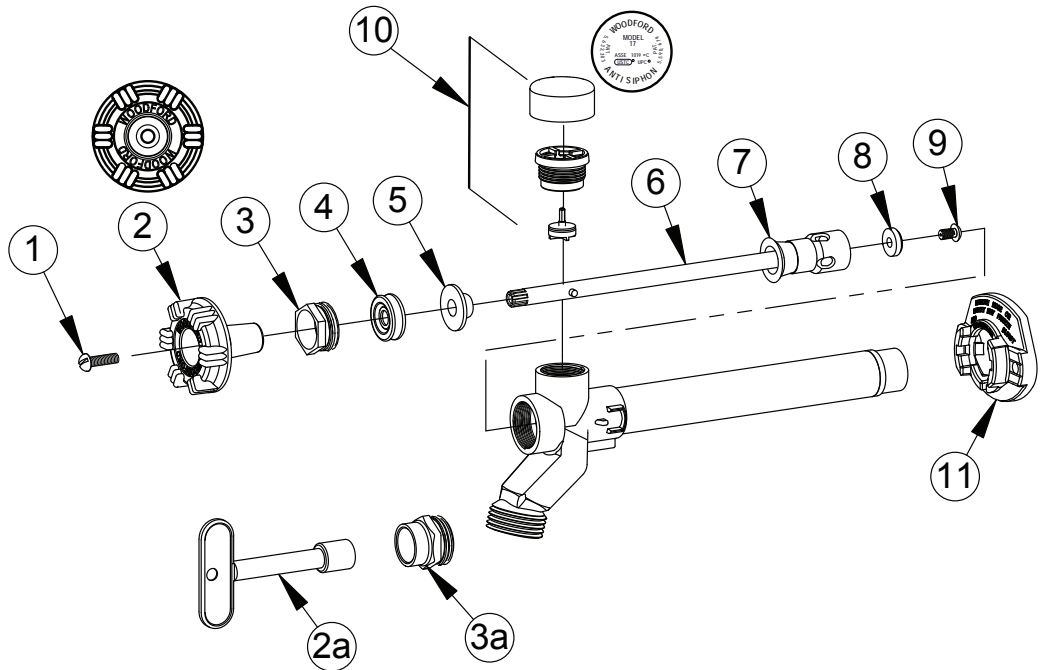

MODEL 17 PARTS LIST

| ITEM | PART# | DESCRIPTION |
|------|---------|---|
| 1 | 30002 | Handle Screw |
| 2 | 30096 | Wheel Handle - Round Powder Coated Die Cast Aluminum |
| 2a | 50012 | Tee Key (Optional) |
| 3 | 30059 | Packing Nut |
| 3a | 30512 | Packing Nut w/deep stem guard (Optional) |
| 4 | 30560 | EPDM Packing |
| 5 | 30421 | Packing Support Washer |
| 6 | 35XXX | Valve Stem Assembly (See chart at right) Includes Items 6, 7, 8 & 9 |
| 7 | 30459 | Check Valve |
| 8 | 30008 | Valve Seat Rubber |
| 9 | 30009 | Retainer Screw |
| 10 | RK-17VB | Vacuum Breaker Float Kit |
| 11 | 30098 | Adjustable Flange |
| | RK-17 | Repair Kit (Includes items 1-5, & 7-10) |

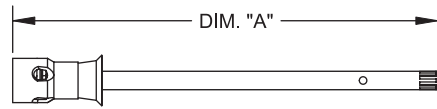

| VALVE STEM ASSEMBLY DIM "A" | | |
|-----------------------------|----------------|----------|
| Wall Thickness | Overall Length | Part No. |
| 4 | 5 7/8" | 35720 |
| 6 | 7 7/8" | 35721 |
| 8 | 9 7/8" | 35722 |
| 10 | 11 7/8" | 35723 |
| 12 | 13 7/8" | 35724 |
| 14 | 15 7/8" | 35725 |
| 16 | 17 7/8" | 35736 |
| 18 | 19 7/8" | 35726 |
| 20 | 21 7/8" | 35737 |
| 22 | 23 7/8" | 35738 |
| 24 | 25 7/8" | 35727 |



For more information contact...

WOODFORD MANUFACTURING COMPANY

2121 Waynoka Road, Colorado Springs, Colorado 80915 • Phone: (800) 621-6032 • Fax: (800) 765-4115
 To view our complete product line visit: www.woodfordmfg.com or email: sales@woodfordmfg.com
 A Division Of WCM Industries, Inc.