

# *Slant/Fin* Fine/Line® 30

MADE WITH  
COMMERCIAL GRADE,  
**RUST-RESISTANT**  
GALVANIZED STEEL!

America's favorite hot water baseboard radiation

## ***The science of better heating!***

Our hot water boiler-baseboard perimeter system *surrounds* you and your family with heating comfort. It is the most efficient, most comfortable heating system of all. Here's why it's better than forced air, electric heat or heat pumps:

- **Cleaner, healthier heat**
- **Gentle, draft-free heating**
- **Room by room comfort**
- **Quieter**
- **Better fuel economy**
- **Quicker response**
- **Slim profile**
- **Rugged and durable**



Since 1949  
**Slant/Fin**  
BOILERS & BASEBOARD  
*The Only Name You Want Heating Your Home*

*Fine/Line 30 harmonizes with any decor!*

# Leading the way in design and engineering

## Why Slant/Fin is preferred by heating experts—

Slant/Fin leads the industry with baseboard heating innovations. Fingertip control dampers, hinged telescopic accessories, plastic expansion cradles and Zip-strip cartons are all Slant/Fin firsts. From die formed steel brackets to durable baked enamel finish, the quality you see in Slant/Fin baseboard reflects our commitment to excellence. Experts agree that Slant/Fin leads the way in variety, quality and ease of installation.

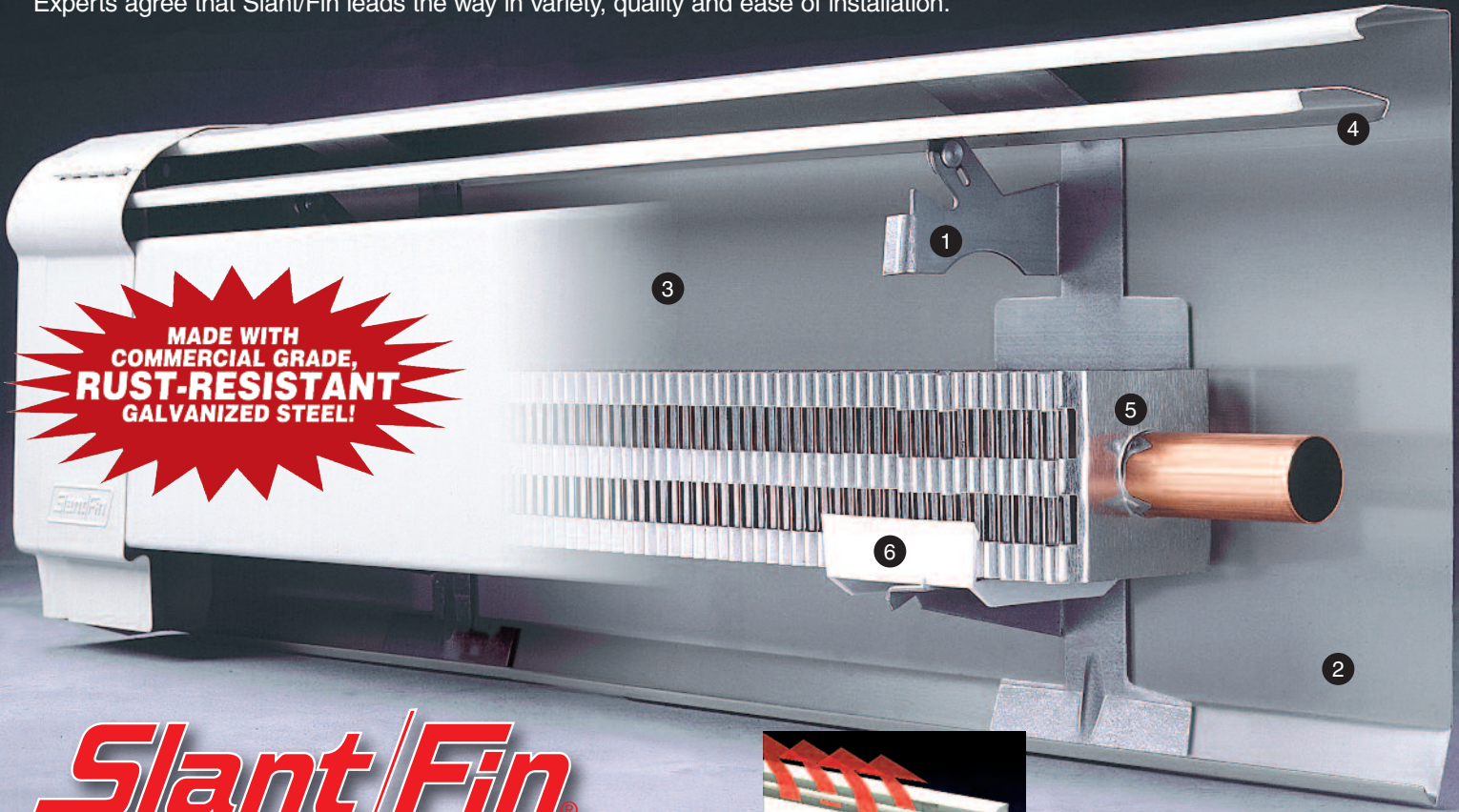

# Slant/Fin®

## Engineered for excellence.

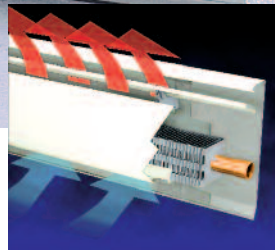

**Wall streakage eliminated.** Top panel and damper form a shield to keep dust from settling into baseboard interior, and to deflect heated air away from the wall, into the room. Back panel has no holes or slits to leak air behind the back of the baseboard causing wall streakage.



**1. High strength support brackets.** Slant/Fin's heavy gauge steel support bracket is shaped by a series of progressive die strikes which multiply the strength of the metal alone. The bracket becomes a powerful "spine" for the entire unit, holding cover, element and damper vane securely in place. Brackets can't pop out of place, yet may be slid laterally for installation convenience. Support wedge at top of bracket reinforces top panel against damage. Half-moon cutout provides room for return line.



**2. Super-strong enclosure** won't go out of shape under rough abuse or even when used as a step by children. The super strong Slant/Fin enclosure holds its shape through installation and years of use. Prime, cold-rolled, rephosphorized, heavy-gauge, galvanized steel is formed into rigid front panel and one-piece bottom, back and top panel. Channels formed along top and bottom edge of front panel add extra structural strength.



**3. Rust resistant galvanized steel** is standard on all Fine/Line 30 baseboard. The special alloys and rust inhibitor finish used in making Fine/Line 30 ensure that the enclosures will maintain their like-new beauty, even in high moisture areas such as bathrooms, basements and laundry rooms. No other residential baseboard offers this long lasting protection.



**4. Room control damper** helps control individual room temperature. Slant/Fin's unique pivot and damper mounting assembly provide the straightest, most responsive damper available. Factory assembled. Holds any setting from fully open to fully closed or any setting in-between. Ordinary baseboard dampers may leave large spaces even when closed. The Slant/Fin damper, when closed, effectively reduces convection air flow.

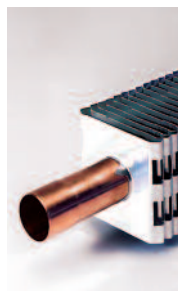

**5. High performance heating element. Maximum heat output. Fins won't loosen.** Double bent aluminum fins pack extra heating surface in a slimmer enclosure. Interlocking tongue-and-groove collars permanently bond fins to each other and to the tubing. Stops "pings and clicks". Tight bond assures maximum heat-transfer efficiency. End fins are of plated steel for extra ruggedness.



**6. No-noise expansion cradles.** Self-adjusting velvet smooth expansion cradles eliminate noisy metal-to-metal contact with bracket and enclosure. Cradle slides silently over support bracket as heating element expands and contracts.

# Heating contractor: Complete your baseboard installations with less effort and less time.

Fine/Line 30 is designed for fast, simple, economical installation from the minute you zip open the first carton to the second you snap on the last accessory. You make the best looking, most cost-effective baseboard installation possible. Without cutting corners. Without unexpected labor costs. Take advantage of these Slant/Fin features for a better installation.

Slant/Fin's selection of pre-cut lengths and telescopic accessories lets you fit "standard" Slant/Fin products to virtually any field condition, for easy, neat wall to wall fit without cutting. With the 3½' baseboard length, you can figure your runs in half-foot increments. No one offers greater selection, versatility and quality for baseboard accessories than Slant/Fin. Telescoping accessories make up the odd inches. 7" and 14" filler sleeves also fill gaps up to a foot.



**Zip-Strip carton** zips open in seconds. Baseboard comes out of the carton fully assembled, ready to nail. No jigsaw puzzle of parts. No cutting to fit.



**Slant/Fin's T-shot nailer** reaches through the damper opening to drive a nail high up on the back panel where it offers the most support. You don't even have to remove the front panel to nail up the baseboard. Or use power drill with self-tapping screws.



**Riser hole template**, included free in every baseboard package, lets you quickly mark the correct location for floor riser holes or wall holes for straight-through runs. Recommended hole diameter allows room for lateral expansion movement of the riser.

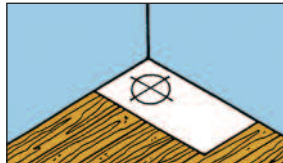

**Flared element tube** — facilitates joining of baseboard sections. Right end of each element tube is flared to accept tubing from adjacent baseboard or ¾" system tubing.

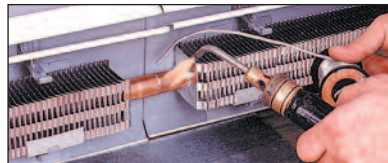

**Vented return bend.** Special 180° bend aligns return line perfectly with half-moon cutouts in support brackets. A ½" threaded tapping permits easy installation of air vent, can also serve as a drain

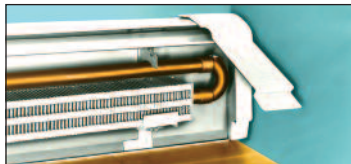

**Wire hangers** — provide support for bare tube in dummy enclosures or for return tubing above heating element.

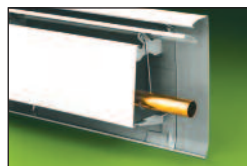

**Riser rings** — provide a neat, clean, sanitary seal where risers come up through floor. Wax loaded neoprene acts to cushion expansion squeaks and vibration noises. Split collar allows easy installation at any time, even after connections are made.



**Fast/Flex connectors** can be hand formed around obstructions, go through tight spots and make up for any misalignment between baseboard and piping. Here, one Fast/Flex replaces three elbows and three lengths of tubing, eliminating much measuring and fitting. (See Pub. No. EC-FF-10 for additional data.)

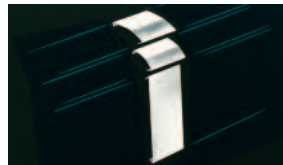

**2" splice plate** included free with lengths 5' and longer, provides continuity between close fitting baseboard sections.



**Turn corners easily.** It's easy to shape your own inside corner when the standard 90° or 135° corners won't fit. Our field adaptable inside corner is easily shaped on the job for a perfect fit at bay windows or any other place with unusually angled corners.



Slant/Fin baseboard can be installed flush to the wall or recessed for a more concealed look.



**Snap-on, hinged accessories** swing up for easy access to air vents and heating element or for removal of the front panel— even when wall material covers the accessory top. Precision piano hinges last for years.



**Drawn steel end caps and wall trim** have elegant rounded edges (instead of welded seams) to give your installation a more distinctive look. Wall trim conceals top, front and side for a more finished look than ordinary wall trim that has no side contour. Has the same appearance as a hinged end cap, except the side is slotted for passage of the tubing.



**Quality enamel finish** perfectly matches the baseboard color to give a harmonious look to your finished job. Every accessory has thick, even paint coverage. No streaks. No splotches. Even the inside is thoroughly protected with paint for years of rust-free beauty. Full back panel on end caps, wall trim etc.

## ORDERING DATA

### No. 30-75 COMPLETE BASEBOARD PACKAGE

Contains heating element and enclosure. Following items included: expansion cradles, support brackets, damper vane, 2" wide splice plate with 5' lengths and longer.

LENGTHS: 2', 3', 3½', 4', 5', 6', 7', 8', 10', 12'

### No. 30-DW ENCLOSURE ONLY PACKAGE

(All parts and lengths as No. 30-75 WITHOUT heating element or expansion cradles.)

### NO. E-75 ¾" ELEMENT ONLY PACKAGE

Heating element with expansion cradles; NO enclosure.

LENGTHS: 2', 3', 3½', 4', 5', 6', 7', 8'

### PACKAGING

Each baseboard or enclosure only unit is individually packed—completely assembled—in its own Zip-strip carton, with end flaps clearly marked and color-coded. See R-01 price list for packaging of accessories.

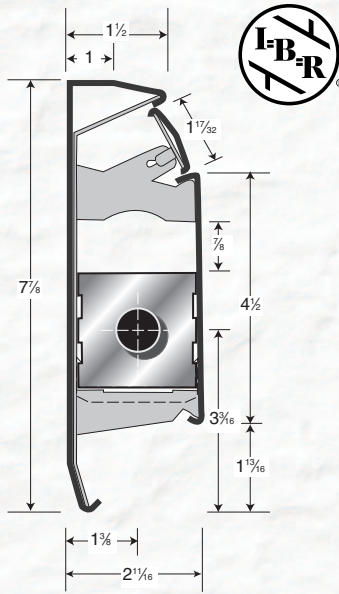

### HEATING ELEMENT SPECIFICATIONS:

Furnish and install E-75 baseboard heating element as manufactured by Slant/Fin Corporation, consisting of ¾" nominal copper tubing, with 2 3/8" x 2 3/8" x .009" aluminum fins, bent to 2 3/8" x 2 3/8", spaced 55 per linear foot. A flange with four teeth shall be formed on each fin to increase thermal contact and to space and lock the fins uniformly in place. One end of each element tube shall be expanded to receive the unexpanded end of another, without couplings.

## I=B=R APPROVED HOT WATER RATINGS

Fine/Line 30 – No. 30-75 baseboard with ¾" E-75 element.

WATER FLOW	PRESSURE DROP†	140°F	150°F	160°F	170°F	180°F	190°F	200°F	210°F	215°F	220°F
1 GPM	47	320*	380	450	510	580	640	710	770	810	840
4 GPM	525	340*	400	480	540	610	680	750	810	860	890

BTU/hr./ft. with 65° entering air † Millinches per foot. \*Ratings at 140°F and lower temperatures determined by multiplying 150°F rating by the applicable factor specified in Table E in the I=B=R Testing and Rating Standard for Baseboard radiation.

NOTE: Ratings are for element installed as per drawing shown here, with damper open, with expansion cradles. Ratings are based on active finned length (5' to 6' less than overall length) and include 15% heating effect factor. Use 4 gpm ratings only when flow is known to be equal to or greater than 4 gpm; otherwise 1 gpm ratings must be used.

## BRACKETS PER LENGTH

Complete assembly and enclosure only

Length, ft.	2 - 3½'	4 - 5'	6 - 8'	10'	12 - 14'
Brackets	2	3	4	6	8

### COVER ASSEMBLY SPECIFICATIONS:

Furnish and install Fine/Line 30-75 baseboard cover assembly as manufactured by Slant/Fin Corp. The cover consists of a one-piece bottom, back and top panel, one-piece front panel and one piece damper vane that are formed out of galvanized cold rolled steel. Cold rolled steel that is not galvanized is not acceptable. The galvanized steel makes the cover rust resistant. Bottom and top of back panel shall have channels along entire length to receive full-height support brackets. Brackets shall add support to the top of the rear panel. The factory installed damper vane shall modulate fully and freely, while retaining any setting through its arc. Damper shall swing in position on damper pivots inserted in die-formed slots towards top of support bracket. Roll formed pivot point is not acceptable. All cover components shall be painted in a Nu-White, thermosetting polyester enamel.

Brackets shall be die-formed of re-phosphorized cold rolled steel, for rigid bracing and spring locking. Each length of baseboard shall have a minimum quantity of factory installed brackets per length of baseboard cover as follows: 2, 3 and 3½' have 2 brackets; 4 and 5' have 3 brackets; 6, 7 and 8' have 4 brackets; 10' has 6 brackets; 12 and 14' have 8 brackets. Fewer brackets are not acceptable.

Slide-action polypropylene expansion cradles shall protect element bottom and sides from contact with support brackets and cover, allowing free lateral element expansion for noiseless operation. Cradles shall be installed on heating elements at location of brackets.

## Fine/Line 30 Hinged Accessories

### END CAP

3½" wide, with piano-hinged front panel, closed end. For use at doorways.

### Left end cap

No. 30-LEC  
Right end cap  
No. 30-REC



### FILLER SLEEVE

Cover gaps from 1" to 6" or 1" to 12" Includes back, top and front panels and damper vane.

7" filler sleeve  
No. 30-FS-7

14" filler sleeve  
No. 30-FS-14

### WALL TRIM

3½" wide, with piano-hinged front panel, slotted end. For use at wall partitions.

### Left wall trim

No. 30-LWT  
Right wall trim  
No. 30-RWT

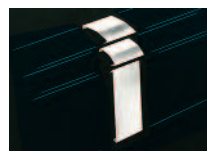

### SPLICE PLATE SET

2" wide. Free with lengths 5' and longer.

Splice plate set  
No. 30-SP

### INSIDE CORNER

3½" wide at top, with piano-hinged, contoured front panel.

### 90° inside corner

No. 30-IC-90  
135° inside corner  
No. 30-IC-135  
91° to 179° field adaptable inside corner  
No. IC-FA



### OUTSIDE CORNER

One-piece unit without hinged panels.

90° outside corner  
No. 30-OC-90  
135° outside corner  
No. 30-OC-135

### VALVE COVER

8" wide, with extra wide piano-hinged front panel, closed end. (30-CVC has open ends.)

### Left valve cover

No. 30-LVC  
Right valve cover  
No. 30-RVC  
Center valve cover  
No. 30-CVC



### SOLID WALL TRIM

2" or 4" solid (non-hinged), with open ends. For use at left or right wall partitions or as one-piece filler sleeve.

2" solid wall trim  
No. 30-WT-2  
4" solid wall trim  
No. 30-WT-4

### ZONE VALVE BOX

9½" wide, 9" high, 3½" deep, with piano-hinged front panel. Houses most motorized valves.

### Left zone valve box

No. 30-LZC  
Right zone valve box  
No. 30-RZC

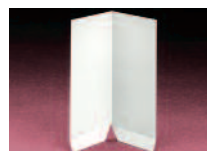
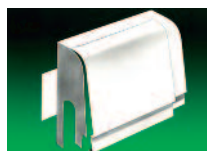

### BACK PANEL

for inside corner. For neat finish of baseboard interior at corners.

90° back panel  
No. 30-ICBP-90  
135° back panel  
No. 30-ICBP-135



SLANT/FIN CORPORATION, Greenvale, N.Y. 11548 • Phone: (516) 484-2600  
FAX: (516) 484-5921 • Canada: Slant/Fin LTD/LTEE, Mississauga, Ontario

© Slant/Fin Corp. 2012. Printed in U.S.A.412. Publication No. 30-10cv

www.slantfin.com

