

Grooved End Fittings



Victaulic offers a broad line of fittings in sizes through 48"/1200mm in a variety of straight and reducing styles. Most standard fittings are cast of durable ductile iron to precise tolerances. Victaulic standard fittings pressure ratings conform to the ratings of Victaulic Style 77 couplings. All fittings are supplied with grooves or shoulders to permit fast installation without field preparation. The grooved design permits flexibility for easy alignment. *These fittings are not intended for use with Victaulic couplings for plain end pipe (refer to Section 14.04 for fittings available for plain end applications).*

Fittings are provided in various materials including ductile iron, steel or segmentally welded steel depending on styles and size. Fittings are painted orange enamel with a galvanized finish available as an option, contact Victaulic for details.

Victaulic fittings are designed specifically for use in grooved piping systems. Fittings are provided grooved or with shoulders conforming to standard steel pipe outside diameters. When connecting wafer or lug-type butterfly valves directly to Victaulic fittings with 741 or 743 Vic-Flange® adapters, check disc clearance dimensions with I.D. dimension of fitting.

Note: The following Victaulic fittings are VdS approved: NO.10 90° Elbow, NO.11 45° Elbow, NO.20 Tee and NO.60 Cap.

Note: The following Victaulic fittings are LPCB approved: NO.10 90° Elbow, NO.11 45° Elbow, NO.12 22 1/2° Elbow, NO.13 11 1/4° Elbow, NO.30 45° Lateral, NO.30-R Reducing Lateral, NO.100 Long Radius Elbow, NO.110 Long Radius Elbow, NO.20 Tee, NO.35 Cross, NO.60 Cap, NO.25 Reducing Tee, NO.33 True Wye, NO.50 Concentric Reducer, NO.51 Eccentric Reducer, NO.29M Tee with Threaded Branch, NO.27 Standpipe Tee, and NO.32 Tee Wye.



NO. 20 TEE



NO. 10 ELBOW



AGS – ADVANCED GROOVE SYSTEM

Advanced Groove System – For 14 – 24"/350 – 600mm piping systems, Victaulic now offers the Advanced Groove System (AGS). Refer to Section 20.05 for AGS fitting details.

Stainless Steel – Grooved end fittings are available in Schedule 10 Type 316 stainless steel (Schedule 5, 40 and Type 304 available as an option) in various sizes. Fitting center-to-end dimensions will vary depending upon type and schedule. Refer to Section 17.04 and 17.16 for details.

Aluminum – Grooved end fittings are available in aluminum alloy 356 T6, in sizes from 1 – 8"/25 – 200mm. Refer to Section 21.03 or contact Victaulic for details.

ALTERNATE STYLES



Extra Heavy EndSeal® "ES" Fittings – EndSeal fittings are available in 2 – 12"/50 – 300mm for use with "ES" grooved pipe and HP-70ES EndSeal couplings. "ES" fittings are painted black for easy identification. EndSeal (and standard) fittings may be easily internally coated (by others) for severe service requirements. Always specify "ES EndSeal fittings" when ordering. See Section 07.03 for information on EndSeal fittings.

Fittings Machined for Rubber or Urethane Lining (MRL) – For severe abrasive services, Victaulic fittings may be rubber or urethane lined (by others). Lining may be inside diameter/end (abrasion resistance) or wrap-around (corrosion and/or abrasion) machined. Refer to Section 25.03 or contact Victaulic for specific details.

Note: Fittings are available with a variety of coatings upon request such as hot dip galvanized, epoxy, glass lined and others.

JOB/OWNER

System No. _____
Location _____

CONTRACTOR

Submitted By _____
Date _____

ENGINEER

Spec Sect _____ Para _____
Approved _____
Date _____

Grooved End Fittings

MATERIAL SPECIFICATIONS

Fitting: Ductile iron conforming to ASTM A-536, grade 65-45-12. Ductile iron conforming to ASTM A-395, grade 65-45-15, is available upon special request.

- **Or:** Segmentally welded steel as shown under nipples

Nipples: (adapter, swaged & hose)

- ¾ – 4"/20 – 100mm: Carbon steel, Schedule 40, conforming to ASTM A-53, Type F
- 5 – 6"/125 – 150mm: Carbon steel, Schedule 40, conforming to ASTM A-53, Type E or S, Gr. B
- 8 – 12"/200 – 300mm: Carbon steel, Schedule 30 or 40, conforming to ASTM A-53, Type E or S, Gr. B

Flanged Adapter Nipples: (Nipple – see above)

- Class 125 Flange: Cast iron conforming to ANSI B-16.1
- Class 150 Flange: Carbon steel conforming to ANSI B-16.5, raised or flat face
- Class 300 Flange: Carbon steel conforming to ANSI B-16.5, raised or flat face

Fitting Coatings: Orange enamel

- **Optional:** Hot dip galvanized and others. Some fittings supplied electroplated as standard – see product specifications.

Flanged Adapter Nipple Coating: None (Unfinished)

- **Optional:** Orange enamel, hot dip galvanized and others.

Grooved End Fittings

FLOW DATA

(Frictional Resistance)

The chart expresses the frictional resistance of various Victaulic fittings as equivalent feet of straight pipe. Fittings not listed can be estimated from the data given, for example, a 22½° elbow is approximately one-half the resistance of a 45° elbow. Values of mid-sizes can be interpolated.

Size		Dimension – Feet/meters					
Nominal Size In./mm	Actual Outside Dia. In./mm	Elbows				Tees	
		90° Elbows		45° Elbows		Branch	Run
		No. 10 Std. Radius	No. 100 1 ½ D Long Radius	No. 11 Std. Radius	No. 110 1 ½ D Long Radius		
1	1.315	1.7	—	0.8	—	4.2	1.7
25	33.7	0.5	—	0.2	—	1.3	0.5
2	2.375	3.5	2.5	1.8	1.1	8.5	3.5
50	60.3	1.1	0.8	0.5	0.3	2.6	1.1
76.1 mm	3.000	4.3	—	2.1	—	10.8	4.3
	76.1	1.3	—	0.7	—	3.3	1.3
3	3.500	5.0	3.8	2.6	1.6	13.0	5.0
80	88.9	1.5	1.2	0.8	0.5	4.0	1.5
108.0 mm	4.250	6.4	—	3.2	—	15.3	6.4
	108.0	2.0	—	0.9	—	4.7	2.0
4	4.500	6.8	5.0	3.4	2.1	16.0	6.8
100	114.3	2.1	1.5	1.0	0.6	4.9	2.1
133.0 mm	5.250	8.1	—	4.1	—	20.0	8.1
	133.0	2.5	—	1.2	—	6.2	2.5
139.7 mm	5.500	8.5	—	4.2	—	21.0	8.5
	139.7	2.6	—	1.3	—	6.4	2.6
5	5.563	8.5	—	4.2	—	21.0	8.5
125	141.3	2.6	—	1.3	—	6.4	2.6
159.0 mm	6.250	9.4	—	4.9	—	25.0	9.6
	159.0	2.9	—	1.5	—	7.6	2.9
165.1 mm	6.500	9.6	—	5.0	—	25.0	10.0
	165.1	2.9	—	1.5	—	7.6	3.0
6	6.625	10.0	7.5	5.0	3.0	25.0	10.0
150	168.3	3.0	2.3	1.5	0.9	7.6	3.0
8	8.625	13.0	9.8	6.5	4.0	33.0	13.0
200	219.1	4.0	3.0	2.0	1.2	10.1	4.0
10	10.750	17.0	12.0	8.3	5.0	41.0	17.0
250	273.0	5.2	3.7	2.5	1.5	12.5	5.2
12	12.750	20.0	14.5	10.0	6.0	50.0	20.0
300	323.9	6.1	4.4	3.0	1.8	15.2	6.1
14	14.000	24.5 § 7.5	15.8	18.5 § 5.6	11.0	70.0	23.0
350	355.6	8.5	4.8	3.4	2.1	21.3	7.0
16	16.000	28.0 § 8.5	18.0	21.0 § 6.4	13.0	80.0	27.0
400	406.4	9.5	5.5	4.0	2.4	24.4	8.2
18	18.000	31.0 § 9.5	20.0	23.5 § 7.2	14.0	90.0	30.0
450	457.0	10.4	6.1	4.3	2.7	27.4	9.1
20	20.000	34.0 § 10.4	22.5	25.5 § 7.8	16.0	100.0	33.0
800	508.0	12.8	6.9	4.9	3.0	30.5	10.1
24	24.000	42.0 § 12.8	27.0	29.5 § 9.0	19.0	120.0	40.0
600	610.0	—	8.2	5.8	3.6	36.6	12.2
26	26.000	—	28.0	—	20.5	130.0	43.0
650	660.4	—	8.5	—	6.3	39.6	13.1
30	30.000	—	34.0	—	24.0	150.0	50.0
750	762.0	—	10.4	—	7.3	45.7	15.2
36	36.000	—	40.5	—	28.5	180.0	60.0
900	914.0	—	12.3	—	8.7	54.9	18.3
42	42.000	—	47.0	—	33.0	210.0	70.0
1050	1067.0	—	14.3	—	10.1	64.0	21.3

Contact Victaulic for details.

For roll grooved systems, Victaulic offers the Advanced Groove System (AGS). For pricing and availability of cut groove fittings in this size, contact your nearest Victaulic sales office.

§ Fitting flow data for 14-24"/350-600 mm size NO. 10 and NO. 11 Elbows is based on fittings for Style 07 and 77 couplings. For flow data on AGS fittings (NO. W10 and NO. W11 Elbows), refer to submittal 20.05.

Note: All fittings are ductile iron unless otherwise noted with an "sw" or "s". SW= Segmentally Welded. S= Carbon Steel

Grooved End Fittings

DIMENSIONS

Elbows

NO. 10 90° Elbow

NO. 11 45° Elbow

NO. 12 22½° Elbow

NO. 13 11¼° Elbow

NO. 100 90° Long Radius

NO. 110 45° Long Radius

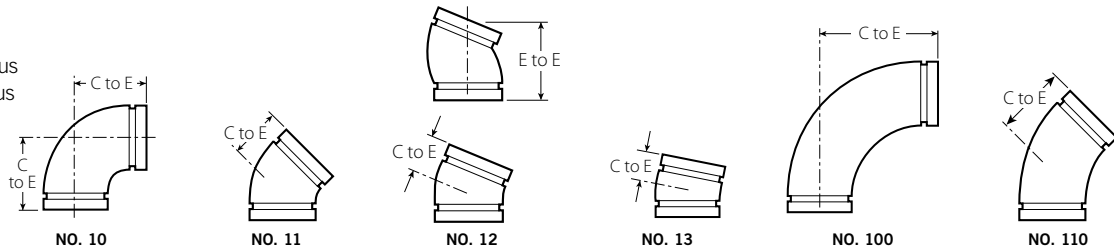

Size		No. 10 90° Elbow		No. 11 45° Elbow		No. 12 22½° Elbow		No. 13 11¼° Elbow		No. 100† 90° Long Radius Elbow (S)		No. 110† 45° Long Radius Elbow (S)	
Nominal Size Inches mm	Actual Outside Dia. Inches mm	C to E Inches mm	Approx. Wgt. Each Lbs. kg	C to E Inches mm	Approx. Wgt. Each Lbs. kg	C to E Inches mm	Approx. Wgt. Each Lbs. kg	C to E Inches mm	Approx. Wgt. Each Lbs. kg	C to E Inches mm	Approx. Wgt. Each Lbs. kg	C to E Inches mm	Approx. Wgt. Each Lbs. kg
¾ 20	1.050 26.9	2.25 57	0.5 0.2	1.50 38	0.5 0.2	1.63sw 41	—	1.38sw 35	—	—	—	—	—
1 25	1.315 33.7	2.25 57	0.6 0.3	1.75 44	0.6 0.3	3.25 @ 83	0.6 0.3	1.38sw 35	0.3 0.1	—	—	—	—
1¼ 32	1.660 42.4	2.75 70	1.0 0.5	1.75 44	0.9 0.4	1.75 44	0.8 0.4	1.38sw 35	0.5 0.2	—	—	—	—
1½ 40	1.900 48.3	2.75 70	1.2 0.5	1.75 44	0.9 0.4	1.75 44	0.8 0.4	1.38sw 35	0.5 0.2	—	—	—	—
2 50	2.375 60.3	3.25 83	1.8 0.8	2.00 51	1.3 0.6	3.75 @ 95	1.4 0.6	1.38 35	1.0 0.5	4.38 111	2.5 1.1	2.75 70	1.8 0.8
2½ 65	2.875 73.0	3.75 95	3.2 1.5	2.25 57	2.2 1.0	4.00 @ 102	2.3 1.0	1.50 38	1.1 0.5	5.13 130	3.4 1.5	3.00 76	2.8 1.3
76.1 mm	3.000 76.1	3.75 95	3.7 1.7	2.25 57	3.4 1.5	2.24 57	—	1.50 38	—	—	—	—	—
3 80	3.500 88.9	4.25 108	4.5 2.0	2.50 64	3.1 1.4	4.50 @ 114	3.1 1.4	1.50 38	2.1 1.0	5.88 149	6.0 2.7	3.38 86	4.9 2.2
3½ 90	4.000 101.6	4.50 114	5.6 2.5	2.75 70	4.3 2.0	2.50sw 64	4.0 1.8	1.75sw 44	2.7 1.2	—	—	—	—
4 100	4.500 114.3	5.00 127	7.1 3.2	3.00 76	5.6 2.5	2.88 73	5.6 2.5	1.75 44	3.6 1.6	7.50 191	12.3 5.6	4.00 102	7.3 3.3
108.0 mm	4.250 108.0	5.00 127	11.0 5.0	3.00 76	5.6 2.5	—	—	—	—	—	—	—	—
4½ 120	5.000 127.0	5.25 sw 133	10.0 4.5	3.13 sw 79	6.0 2.7	3.50 89	6.6 3.0	1.88sw 48	4.2 1.9	—	—	—	—
5 125	5.563 141.3	5.50 140	11.7 5.3	3.25 83	8.3 3.8	2.88sw 73	7.8 3.5	2.00sw 51	5.0 2.2	+	18.2 8.3	+	14.8 6.7
133.0 mm	5.250 133.0	5.50 140	11.7 5.3	3.25 83	8.3 3.8	—	—	—	—	—	—	—	—
139.7 mm	5.500 139.7	5.50 140	11.7 5.3	3.25 83	8.3 3.8	2.87 73	—	2.00 51	—	—	—	—	—
6 150	6.625 168.3	6.50 165	17.2 7.8	3.50 89	10.8 4.9	6.25 @ 159	12.2 5.5	2.00 51	7.0 3.2	10.75 273	30.4 13.8	5.50 140	17.4 7.9
159.0 mm	6.250 159.0	6.50 165	18.6 8.4	3.50 89	10.8 4.9	—	—	—	—	—	—	—	—
165.1 mm	6.500 165.1	6.50 165	15.5 7.0	3.50 89	9.8 4.4	3.13 79	11.4 5.2	2.00 51	7.4 3.4	10.75 273	29.0 13.2	5.50 140	19.0 8.6

@ Gooseneck design- end-to-end dimension fittings in this size- contact your nearest Victaulic sales office

† Chinese standard sizes

Note: All fittings are ductile iron unless otherwise noted with an "sw" or "s". SW= Segmentally Welded- S= Carbon Steel

Grooved End Fittings

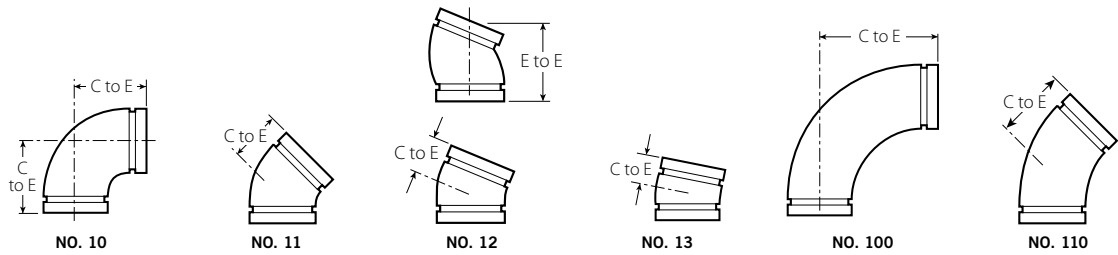

Size		No. 10 90° Elbow		No. 11 45° Elbow		No. 12 22½° Elbow		No. 13 11¼° Elbow		No. 100† 90° Long Radius Elbow (S)		No. 110† 45° Long Radius Elbow (S)	
Nominal Size Inches mm	Actual Outside Dia. Inches mm	C to E Inches mm	Approx. Wgt. Each Lbs. kg	C to E Inches mm	Approx. Wgt. Each Lbs. kg	C to E Inches mm	Approx. Wgt. Each Lbs. kg	C to E Inches mm	Approx. Wgt. Each Lbs. kg	C to E Inches mm	Approx. Wgt. Each Lbs. kg	C to E Inches mm	Approx. Wgt. Each Lbs. kg
8 200	8.625 219.1	7.75 197	29.9 13.6	4.25 108	20.4 9.3	7.75 @ 197	20.0 9.1	2.00 51	10.1 4.6	14.25 362	66.0 30.0	7.25 184	36.0 16.3
10 250	10.750 273.0	9.00 229	63.3 28.7	4.75 121	37.5 17.0	4.38 111	30.0 13.6	2.13 54	11.8 5.3	15.00 381	107.0 48.5	6.25 159	57.0 25.9
12 300	12.750 323.9	10.00 254	74.0 33.6	5.25 133	66.7 30.3	4.88 124	40.0 18.1	2.25 57	29.3 13.3	18.00 457	156.0 70.8	7.50 191	90.0 40.8
14 # 350	14.000 355.6	14.00 355.6	136.0 61.7	5.75 146	65.0 29.5	5.00sw 127	46.0 20.9	3.50sw 89	32.0 14.5	21.00 s 533	164.0 74.4	8.75 s 222	82.0 37.2
377.0mm †	14.843 377.0	14.84 376.9	149.3 67.7	6.15 156.2	82.0 37.2	—	—	—	—	—	—	—	—
16 # 400	16.000 406.4	16.00 406.4	171.0 77.6	6.63 168	88.0 39.9	5.00sw 127	58.0 26.3	4.00sw 102	42.0 19.1	24.00 s 610	210.0 95.3	10.00 s 254	100.0 45.4
426.0mm †	16.772 426.0	16.77 426.0	198.6 90.1	6.95 176.5	101.3 45.9	—	—	—	—	—	—	—	—
18 # 450	18.000 457.0	18.00 457.2	228.0 103.4	7.46 189	108.0 50.0	5.50sw 140	65.0 29.5	4.50sw 114	53.2 24.1	27.00 s 686	273.0 123.8	11.25 s 286	135.0 61.2
480.0mm †	18.898 480.0	18.90 480.0	291.0 132.0	7.83 198.8	141.7 64.3	—	—	—	—	—	—	—	—
20 # 500	20.000 508.0	20.00 508.0	298.0 135.2	8.28 210	138.0 62.6	6.00sw 152	78.6 36.0	5.00sw 127	65.0 29.5	30.00 s 762	343.0 155.6	12.50 s 318	174.0 78.9
530.0mm †	20.866 530.0	20.87 530.0	355.0 161.0	8.64 219.4	179.0 81.2	—	—	—	—	—	—	—	—
24 # 600	24.000 610.0	24.00 609.6	438.0 198.7	9.94 252	221.0 100.2	7.00sw 178	140.0 63.5	6.00sw 152	60.0 27.2	36.00 s 914	516.0 234.1	15.00 s 381	251.0 113.9
630.0mm †	24.803 630.0	24.80 630.0	545.0 247.2	10.27 261.0	255.2 115.7	—	—	—	—	—	—	—	—
14 – 24 350 – 600	For AGS fitting information, see publication 20.05												

@ Gooseneck design, end-to-end dimension

For roll grooved systems, Victaulic offers the Advanced Groove System (AGS). For pricing and availability of cut groove fittings in this size, contact your nearest Victaulic sales office.

† Chinese standard sizes

Note: All fittings are ductile iron unless otherwise noted with an "sw" or "s" SW= Segmentally Welded; S= Carbon Steel

Grooved End Fittings

Long Radius Elbow 3D

With added wall thickness at bend for abrasive services.

- NO. 100-3D** 90° Long Radius Elbow 3D
- NO. 110-3D** 45° Long Radius Elbow 3D

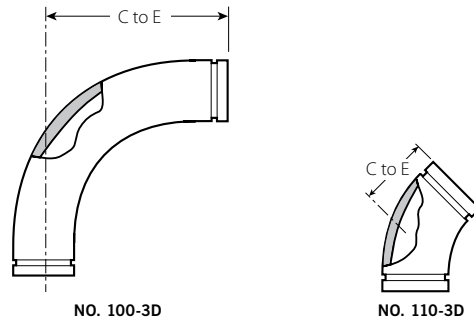

Size		Wall Thickness – Inches/mm			No. 100-3D 90° Long Radius Elbow		No. 110-3D 45° Long Radius Elbow	
Nominal Size Inches mm	Actual Outside Diameter Inches mm	In Non-critical Area	At Back Wear Area	Extra	C to E Inches mm	Approx. Weight Each Lbs. kg	C to E Inches mm	Approx. Weight Each Lbs. kg
2 50	2.375 60.3	0.184 4.67	0.309 7.85	0.125 3.18	10.00 254	5.0 2.3	6.50 165	4.7 2.1
3 80	3.500 88.9	0.246 6.25	0.371 9.42	0.125 3.18	13.00 330	16.0 7.3	7.75 197	10.4 4.7
4 100	4.500 114.3	0.267 6.78	0.455 11.56	0.188 4.78	16.00 406	25.5 11.6	9.00 229	17.2 7.8
6 150	6.625 168.3	0.310 7.87	0.560 14.22	0.250 6.35	24.00 610	70.0 31.8	13.50 343	45.0 20.4

Note: All fittings are ductile iron unless otherwise noted with an "sw" or "s". SW= Segmentally Welded S= Carbon Steel

Reducing Base Support Elbow

- NO. R-10G** Grv. x Grv.
- NO. R-10F** Grv. x Flange

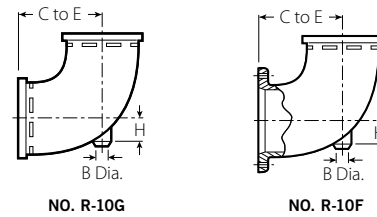

Size		No. R-10 Reducing Base Support Elbow			Approx. Weight Each	
Nominal Size Inches mm		C to E Inches mm	H Inches mm	B Diameter Inches mm	Grv. x Grv. Lbs. kg	Grv. x Flange Lbs. kg
6 150	4 100	9.00 229	1.25 32	1.50 38	19.0 8.6	33.0 15.0
	5 125	9.00 229	1.50 38	1.50 38	23.0 10.4	38.0 17.2
8 200	6 150	10.50 267	2.13 54	1.50 38	33.0 15.0	52.0 23.6
10 250	8 200	12.00 305	2.40 61	1.50 38	61.0 27.7	88.0 39.9

Note: All fittings are ductile iron unless otherwise noted with an "sw" or "s". SW= Segmentally Welded S= Carbon Steel

Grooved End Fittings

Adapter Elbow

NO. 18 90° Adapter Elbow

NO. 19 45° Adapter Elbow

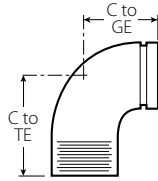

NO. 18

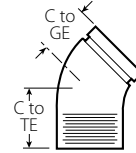

NO. 19

Size		No. 18 90° Adapter Elbow @			No. 19 45° Adapter Elbow @		
Nominal Size Inches mm	Actual Outside Diameter Inches mm	C to GE Inches mm	C to TE Inches mm	Approx. Weight Each Lbs. kg	C to GE Inches mm	C to TE Inches mm	Approx. Weight Each Lbs. kg
¾ 20	1.050 26.9	2.25 57	2.25 57	0.5 0.2	1.50 38	1.50 38	0.5 0.2
1 25	1.315 33.7	2.25 57	2.25 57	0.5 0.2	—	—	—
1¼ 32	1.660 42.4	2.75 70	2.75 70	0.9 0.4	—	—	—
1½ 40	1.900 48.3	2.75 70	2.75 70	1.1 0.5	1.75 44	1.75 44	0.9 0.4
2 50	2.375 60.3	3.25 83	4.25 108	2.5 1.1	—	—	—
2½ 65	2.875 73.0	3.75 95	3.75 95	3.0 1.4	2.25 57	2.25 57	2.3 1.0
3 80	3.500 88.9	4.25 108	6.00 152	5.8 2.6	2.50 64	4.25 108	5.0 2.3
3½ 90	4.000 101.6	4.50 114	6.25 159	8.0 3.6	5.25 133	5.25 133	8.8 4.0
6 150	6.625 168.3	6.50 165	6.50 165	17.6 8.0	3.50 89	3.50 89	12.7 5.8

@ Available with British Standard Pipe Threads- specify "BSP" clearly on order

Note: All fittings are ductile iron unless otherwise noted with an "sw" or "s" SW= Segmentally Welded- S= Carbon Steel

Grooved End Fittings

Tees, Crosses and True Wyes

NO. 20 Tee

NO. 35 Cross

NO. 33 True Wye

NO. 29M Tee with Threaded Branch

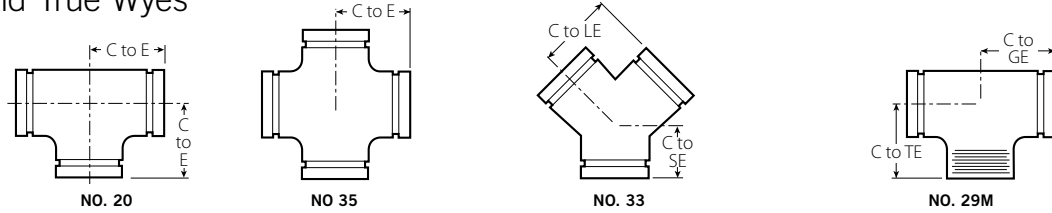

Size		No. 20 Tee		No. 35 Cross (sw)		No. 33 True Wye (sw)			No. 29M Tee with Threaded Branch		
Nominal Size Inches mm	Actual Outside Dia. Inches mm	C to E Inches mm	Approx. Weight Each Lbs. kg	C to E Inches mm	Approx. Weight Each Lbs. kg	C to LE Inches mm	C to SE Inches mm	Approx. Weight Each Lbs. kg	C to GE Inches mm	C to TE Inches mm	Approx. Weight Each Lbs. kg
3/4 20	1.050 26.9	2.25 57	0.6 0.3	2.25 57	0.9 0.4	—	—	—	2.25 57	2.25 57	0.6 0.3
1 25	1.315 33.7	2.25 57	1.0 0.5	2.25 57	1.3 0.6	2.25 57	2.25 57	1.1 0.5	2.25 57	2.25 57	1.0 0.5
1 1/4 32	1.660 42.4	2.75 70	1.5 0.7	2.75 70	2.1 1.0	2.75 70	2.50 64	1.5 0.7	2.75 70	2.75 70	1.5 0.7
1 1/2 40	1.900 48.3	2.75 70	2.0 0.9	2.75 70	2.5 1.1	2.75 70	2.75 70	1.8 0.8	2.75 70	2.75 70	2.0 0.9
2 50	2.375 60.3	3.25 83	3.0 1.4	3.25 83	3.8 1.7	3.25 83	2.75 70	2.5 1.1	3.25 83	4.25 108	3.00 1.4
2 1/2 65	2.875 73.0	3.75 95	4.3 2.0	3.75 95	6.1 2.8	3.75 95	3.00 76	4.3 2.0	3.75 95	3.75 95	4.3 2.0
76.1 mm	3.000 76.1	3.75 95	5.2 2.4	—	—	—	—	—	3.75 95	3.75 95	5.2 (sw) 2.4
3 80	3.500 88.9	4.25 108	6.8 3.0	4.25 108	10.5 4.8	4.25 108	3.25 83	6.1 2.8	4.25 108	6.00 152	6.8 3.1
3 1/2 90	4.000 101.6	4.50 (sw) 114	7.9 3.6	4.50 114	11.5 5.2	4.50 114	3.50 89	9.6 4.4	4.50 114	4.50 114	7.9 (sw) 3.6
108.0 mm	4.250 108.0	5.00 127	15.5 7.0	—	—	—	—	—	5.00 127	5.00 127	15.5 7.0
4 100	4.500 114.3	5.00 127	11.9 5.4	5.00 127	15.8 7.2	5.00 127	3.75 95	10.0 4.5	5.00 127	7.25 184	11.9 5.4
4 1/2 120	5.000 127.0	5.25 (sw) 133	15.0 6.8	5.25 133	18.5 8.4	—	—	—	5.25 133	5.25 133	15.0 (sw) 6.8
133.0 mm	5.250 133.0	5.50 140	17.8 8.1	—	—	—	—	—	5.50 140	5.50 140	17.8 8.1
139.7 mm	5.500 139.7	5.50 140	17.8 8.1	—	—	—	—	—	5.50 140	5.50 140	17.8 8.1
5 125	5.563 141.3	5.50 140	17.8 8.1	5.50 140	20.0 9.1	5.50 140	4.00 102	15.0 6.8	5.50 140	5.50 140	17.8 (sw) 8.1
159.0 mm	6.250 159.0	6.50 165	27.1 12.3	—	—	—	—	—	6.50 165	6.50 165	27.1 12.3
165.1 mm	6.500 165.1	6.50 165	22.0 10.0	6.50 165	28.0 12.7	—	—	—	6.50 165	6.50 165	22.0 10.0
6 150	6.625 168.3	6.50 165	25.7 11.7	6.50 165	28.0 12.7	6.50 165	4.50 114	22.3 10.1	6.50 165	6.50 165	25.7 (sw) 11.7
8 200	8.625 219.1	7.75 197	47.6 21.6	7.75 197	48.0 21.8	7.75 197	6.00 152	36.0 16.3	7.75 197	7.75 197	47.6 (sw) 21.6
10 250	10.750 273.0	9.00 229	99.0 44.9	9.00 229	121.5 55.1	9.00 229	6.50 155	69.9 31.7	9.00 229	9.00 229	73.0 33.1
12 300	12.750 323.9	10.00 254	133.0 60.3	10.00 254	110.0 49.9	10.00 254	7.00 178	80.0 36.3	10.00 254	10.00 254	99.0 44.9

Note: All fittings are ductile iron unless otherwise noted with an "sw" or "s". SW= Segmentally Welded S= Carbon Steel

Grooved End Fittings

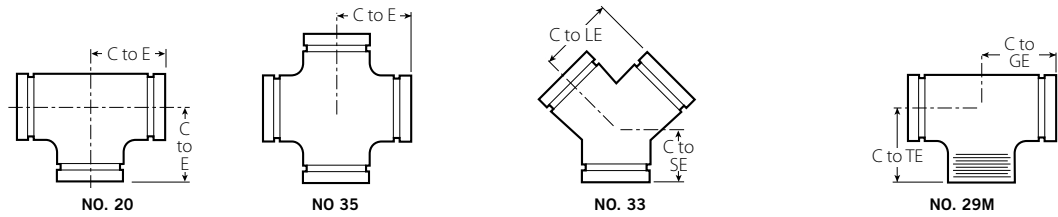

Size		No. 20 Tee		No. 35 Cross (sw)		No. 33 True Wye (sw)			No. 29M Tee with Threaded Branch		
Nominal Size Inches mm	Actual Outside Dia. Inches mm	C to E Inches mm	Approx. Weight Each Lbs. kg	C to E Inches mm	Approx. Weight Each Lbs. kg	C to LE Inches mm	C to SE Inches mm	Approx. Weight Each Lbs. kg	C to GE Inches mm	C to TE Inches mm	Approx. Weight Each Lbs. kg
14 # 350	14.000 355.6	11.00 279	145.0 65.8	11.00 279	198.0 89.8	11.00 279	7.50 191	134.2 60.8	—	—	—
377.0mm	14.000 355.6	11.00 279	145.0 65.8	—	—	—	—	—	—	—	—
16 # 400	16.000 406.4	12.00 305	186.0 84.4	12.00 305	250.0 113.4	12.00 305	8.00 203	167.0 75.7	—	—	—
426.0mm †	16.000 406.4	12.00 305	186.0 84.4	—	—	—	—	—	—	—	—
18 # 450	18.000 457.0	14.00 356	256.0 116.1	15.50 394	350.0 158.8	15.50 394	8.50 216	234.0 106.1	—	—	—
480.0mm †	18.000 457.0	14.00 356	256.0 116.1	—	—	—	—	—	—	—	—
20 # 500	20.000 508.0	15.00 381	339.0 153.8	17.25 438	452.0 205.0	17.25 438	9.00 229	281.0 127.5	—	—	—
530.0mm †	20.000 508.0	15.00 381	339.0 153.8	—	—	—	—	—	—	—	—
24 # 600	24.000 610.0	17.00 432	473.0 214.5	20.00 508	795.0 360.6	20.00 508	10.00 254	523.0 237.2	—	—	—
630.0mm †	24.000 610.0	17.00 432	473.0 214.5	—	—	—	—	—	—	—	—
14 – 24 350 – 600	 For AGS fitting information, see publication 20.05										

For roll grooved systems, Victaulic offers the Advanced Groove System (AGS). For pricing and availability of cut groove fittings in this size, contact your nearest Victaulic sales office.

† Chinese standard sizes

Note: All fittings are ductile iron unless otherwise noted with an "sw" or "s" SW= Segmentally Welded S= Carbon Steel

IMPORTANT NOTE:

Fittings size 26 – 48"/650 – 1050mm are available roll grooved for installation with Style 770 large diameter pipe couplings, Contact Victaulic for details.

Grooved End Fittings

Reducing Tee

NO. 25 Grooved Branch
NO. 29T Threaded Branch

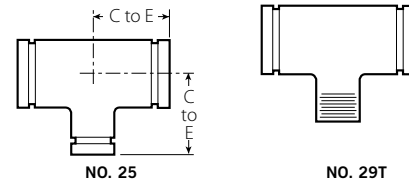

Size	No. 25 Std.	No. 29T w/ Thd. Branch	Approx. Weight Each
Nominal Size Inches mm	C to E Inches mm	C to E Inches mm	Lbs. kg
1 25 × 1 × 3/4 20	+	+	1.0 0.5
1 1/4 32 × 1 1/4 32 × 1 25	+	+	1.3 0.6
1 1/2 40 × 1 1/2 40 × 3/4 20	+	+	1.5 0.7
	+	+	1.5 0.7
	+	+	1.7 0.8
2 50 × 2 50 × 3/4 20	3.25 83	3.25 83	2.5 1.1
	+	+	2.7 1.2
	+	+	1.8 0.8
	3.25 83	3.25 (sw) 83	3.0 1.4
2 1/2 65 × 2 1/2 65 × 3/4 20	+	+	3.9 1.8
	3.75 95	3.75 (sw) 95	3.8 1.7
	+	+	4.2 1.7
	3.75 95	3.75 95	3.9 1.8
	3.75 95	3.75 (sw) 95	4.5 2.0
3 80 × 3 80 × 3/4 20	+	+	5.7 2.6
	4.25 108	4.25 108	6.1 2.8
	+	+	8.0 3.6
	4.25 108	4.25 (sw) 108	6.5 2.9
	4.25 108	4.25 (sw) 108	6.2 2.8
	4.25 108	4.25 (sw) 108	6.4 2.9
4 100 × 4 100 × 3/4 20	+	+	8.0 3.6
	5.00 127	5.00 127	7.8 3.5

Size	No. 25 Std.	No. 29T w/ Thd. Branch	Approx. Weight Each
Nominal Size Inches mm	C to E Inches mm	C to E Inches mm	Lbs. kg
4 100 × 4 100 × 1 1/4 32	+	+	9.6 4.4
	5.00 127	5.00 127	10.2 4.6
	5.00 127	5.00 127	11.2 5.1
	5.00 127	5.00 127	11.4 5.2
	5.00 127	5.00 127	11.6 5.3
5 125 × 5 125 × 1 25	+	+	14.0 6.4
	+	+	14.3 6.5
	5.50 (sw) 140	5.50 (sw) 140	14.5 6.6
	5.50 140	5.50 (sw) 140	15.2 6.9
	5.50 140	5.50 (sw) 140	16.6 7.5
	5.50 140	5.50 (sw) 140	16.7 7.6
	5.50 140	5.50 (sw) 140	16.7 7.6
6 150 × 6 150 × 1 1/2 40	+	+	23.0 10.4
	+	+	24.0 10.9
	6.50 165	6.50 165	21.6 9.8
	6.50 165	6.50 165	21.4 11.7
	6.50 165	6.50 165	21.4 11.7
14 - 24 350 - 600	AGS For AGS fitting information, see publication 20.05		

+ Contact Victaulic for details.

Note: All fittings are ductile iron unless otherwise noted with an "sw" or "s".
 SW= Segmentally Welded; S= Carbon Steel

IMPORTANT NOTE:

No. 29T Threaded Outlet Reducing Tees are supplied NPT and are available with British Standard threads. For British Standard specify "BSP" clearly on order.

Grooved End Fittings

Reducing Tee

NO. 25 Grooved Branch
NO. 29T Threaded Branch

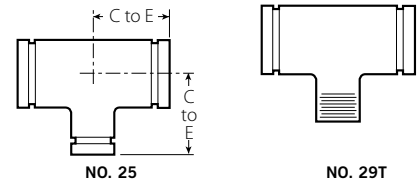

Size	No. 25 Std.	No. 29T w/ Thd. Branch	Approx. Weight Each
Nominal Size Inches mm	C to E Inches mm	C to E Inches mm	Lbs. kg
6 150 × 6 150 × 3 80	6.50 165	6.50 165	26.5 12.0
	6.50 165	6.50 165	25.0 11.3
	6.50 165	6.50 165	23.2 10.5
6½ 165.1 × 6½ 165.1 × 3 80	6.50 165	6.50 (sw) 165	24.0 10.9
	6.50 165	6.50 (sw) 165	25.0 11.3
8 200 × 8 200 × 1½ 40	+	+	33.0 15.0
	7.75 (sw) 197	7.75 (sw) 197	33.5 15.2
	+	+	39.0 17.7
	7.75 (sw) 197	7.75 (sw) 197	33.6 15.2
	7.75 197	7.75 197	41.8 19.0
	7.75 (sw) 197	7.75 (sw) 197	34.0 15.4
	7.75 197	7.75 197	42.3 19.2
	7.75 (sw) 197	7.75 (sw) 197	48.0 21.8
10 250 × 10 250 × 1½ 40	+	+	62.0 28.1
	9.00 (sw) 229	9.00 (sw) 229	62.0 28.1
	+	+	62.4 28.3
	9.00 (sw) 229	9.00 (sw) 229	60.0 27.2
	9.00 (sw) 229	9.00 (sw) 229	61.0 27.7
	9.00 (sw) 229	9.00 (sw) 229	52.0 23.6
	9.00 (sw) 229	9.00 (sw) 229	59.0 26.8
	9.00 (sw) 229	9.00 (sw) 229	64.7 29.3

Size	No. 25 Std.	No. 29T w/ Thd. Branch	Approx. Weight Each
Nominal Size Inches mm	C to E Inches mm	C to E Inches mm	Lbs. kg
12 300 × 12 300 × 1 25	+	+	77.0 34.9
	+	+	80.0 36.3
	+	+	78.0 35.4
	10.00 (sw) 254	10.00 (sw) 254	82.0 37.2
	10.00 (sw) 254	10.00 (sw) 254	80.0 36.3
	10.00 (sw) 254	10.00 (sw) 254	75.0 34.0
	10.00 (sw) 254	10.00 (sw) 254	75.0 34.0
	10.00 (sw) 254	10.00 (sw) 254	80.0 36.3
	10.00 (sw) 254	10.00 (sw) 254	84.0 38.1
	# 14 350 × 14 350 × 4 100	+	+
+		+	108.2 49.1
11.00 279		11.00 279	112.0 50.8
11.00 279		11.00 279	120.0 54.4
11.00 279		11.00 279	129.1 58.6
# 16 400 × 16 400 × 4 100	+	+	130.0 59.0
	AGS For AGS fitting information, see publication 20.05		

+ Contact Victaulic for details.

Note: All fittings are ductile iron unless otherwise noted with an "sw" or "s".
 SW= Segmentally Welded S= Carbon Steel

IMPORTANT NOTE:

No. 29T Threaded Outlet Reducing Tees are supplied NPT and are available with British Standard threads. For British Standard specify "BSP" clearly on order.

For roll grooved systems, Victaulic offers the Advanced Groove System (AGS). For pricing and availability of cut groove fittings in this size, contact your nearest Victaulic sales office.

Grooved End Fittings

Reducing Tee

NO. 25 Grooved Branch
NO. 29T Threaded Branch

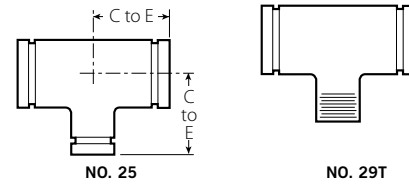

Size	No. 25 Std.	No. 29T w/ Thd. Branch	Approx. Weight Each
Nominal Size Inches mm	C to E Inches mm	C to E Inches mm	Lbs. kg
# 16 400 × 16 400 × 6 150	+	+	133.5 60.6
	8 200	12.00 305	145.0 65.8
	10 250	12.00 305	149.5 67.8
	12 300	12.00 305	154.0 69.9
	14 350	+	167.0 75.8
	# 18 450 × 18 450 × 4 100	+	+
6 150		+	200.0 90.7
8 200		+	202.0 91.6
10 250		15.50 394	212.0 96.2
12 300		15.50 394	222.6 101.0
14 350		15.50 394	230.1 104.4
16 400		15.50 394	247.6 112.3
# 20 500 × 20 500 × 6 150		+	+
	8 200	+	244.0 110.7
	10 250	+	256.0 116.1
	12 300	+	264.0 119.8
	14 350	17.25 438	—

Size	No. 25 Std.	No. 29T w/ Thd. Branch	Approx. Weight Each	
Nominal Size Inches mm	C to E Inches mm	C to E Inches mm	Lbs. kg	
# 20 500 × 20 500 × 16 400	17.25 438	—	288.6 130.9	
	18 450	—	297.0 134.7	
	20.00 508	20.00 508	340.0 154.2	
# 24 600 × 24 600 × 8 200	10 250	20.00 508	343.9 156.0	
	12 300	20.00 508	352.8 160.0	
	14 § 350	20.00 508	360.0 163.3	
	16 400	20.00 508	378.0 171.5	
	18 § 450	20.00 508	380.0 172.4	
	20 500	20.00 508	373.0 169.2	
	14 – 24 350 – 600		AGS For AGS fitting information, see publication 20.05	

+ Contact Victaulic for details.

Note: All fittings are ductile iron unless otherwise noted with an "sw" or "s".
 SW= Segmentally Welded- S= Carbon Steel

IMPORTANT NOTE:

No. 29T Threaded Outlet Reducing Tees are supplied NPT and are available with British Standard threads. For British Standard specify "BSP" clearly on order.

For roll grooved systems, Victaulic offers the Advanced Groove System (AGS). For pricing and availability of cut groove fittings in this size, contact your nearest Victaulic sales office.

§ Cast fitting available. Contact Victaulic for details.

Grooved End Fittings

Bullhead Tee

NO. 21

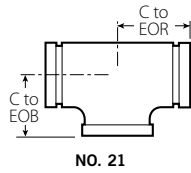

No. 21 Bullhead Tee				
Size		C to EOR Inches mm	C to EOB Inches mm	Approx. Weight Each Lbs. kg
5 125	5 125 × 8 200	7.75 197	5.50 140	28.7 13.0
6 150	6 150 × 8 200	7.75 197	6.50 165	37.5 17.0

Note: All fittings are ductile iron unless otherwise noted with an "sw" or "s".
SW= Segmentally Welded S= Carbon Steel

Bull Plug

NO. 61

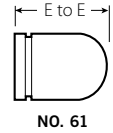

Size		No. 61 Bull Plug (S)	
Nominal Size Inches mm	Actual Outside Diameter Inches mm	E to E Inches mm	Approx. Weight Each Lbs. kg
2 50	2.375 60.3	4.00 102	2.5 1.1
2½ 65	2.875 73.0	5.00 127	3.0 1.4
3 80	3.500 88.9	6.00 152	4.5 2.0
4 100	4.500 114.3	7.00 178	7.5 3.4
5 125	5.563 141.3	8.00 203	12.0 5.4
6 150	6.625 168.3	10.00 254	17.0 7.7

IMPORTANT NOTES:

Steel dish caps available through 24"/600mm, contact Victaulic.

No. 61 Bull Plugs should be used in vacuum service with Style 72 or 750 couplings

Note: All fittings are ductile iron unless otherwise noted with an "sw" or "s".
SW= Segmentally Welded S= Carbon Steel

Grooved End Fittings

45° Lateral

NO. 30

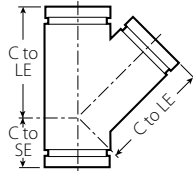

NO. 30

Size		No. 30 45° Lateral (SW)		
Nominal Size Inches mm	Actual Outside Diameter Inches mm	C to LE Inches mm	C to SE Inches mm	Approx. Weight Each Lbs. kg
¾ 20	1.050 26.9	4.50 114	2.00 51	1.0 0.5
1 25	1.315 33.7	5.00 127	2.25 57	1.7 0.8
1¼ 32	1.660 42.4	5.75 146	2.50 64	2.5 (d) 1.1
1½ 40	1.900 48.3	6.25 159	2.75 70	3.5 1.6
2 50	2.375 60.3	7.00 178	2.75 70	4.6 (d) 2.1
2½ 65	2.875 73.0	7.75 197	3.00 76	9.0 94.1
76.1 mm	3.000 76.1	8.50 216	3.25 83	11.0 5.0
3 80	3.500 88.9	8.50 216	3.25 83	11.7 (d) 5.4
3½ 90	4.000 101.6	10.00 254	3.50 89	17.8 8.1
4 100	4.500 114.3	10.50 267	3.75 95	22.2 (d) 10.1
5 125	5.563 141.3	12.50 318	4.00 102	21.8 9.9
165.1 mm	6.500 165.1	14.00 356	4.50 114	43.6 19.8

Size		No. 30 45° Lateral (SW)		
Nominal Size Inches mm	Actual Outside Diameter Inches mm	C to LE Inches mm	C to SE Inches mm	Approx. Weight Each Lbs. kg
6 150	6.625 168.3	14.00 356	4.50 114	43.6 19.8
8 200	8.625 219.1	18.00 457	6.00 152	72.0 32.7
10 250	10.750 273.0	20.50 521	6.50 165	105.0 47.6
12 300	12.750 323.9	23.00 584	7.00 178	165.0 74.8
14 # 350	14.000 355.6	26.50 673	7.50 191	276.0 125.2
16 # 400	16.000 406.4	29.00 737	8.00 203	344.2 156.1
18 # 450	18.000 457.0	32.00 813	8.50 216	429.0 194.6
20 # 500	20.000 508.0	35.00 889	9.00 229	500.0 226.8
24 # 600	24.000 610.0	40.00 1016	10.00 254	715.0 324.3
14 – 24 350 – 600	AGS For AGS fitting information, see publication 20.05			

For roll grooved systems, Victaulic offers the Advanced Groove System (AGS). For pricing and availability of cut groove fittings in this size, contact your nearest Victaulic sales office.

Note: All fittings are ductile iron unless otherwise noted with an "sw" or "s".
SW= Segmentally Welded; S= Carbon Steel

Grooved End Fittings

45° Reducing Lateral

NO. 30-R

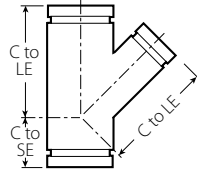

NO. 30-R

Size			No. 30-R 45° Reducing Lateral (SW)				
Nominal Size Inches mm			C to LE Inches mm	C to SE Inches mm	Approx. Weight Each Lbs. kg		
3 80	x	3 80	x	2 50	8.50 216	3.25 83	9.8 4.4
					2½ 65	8.50 216	3.25 83
4 100	x	4 100	x	2 50	10.50 267	3.75 95	10.0 4.5
					2½ 65	10.50 267	3.75 95
				3 80	10.50 267	3.75 95	18.3 8.3
					4 100	12.50 318	4.00 102
5 125	x	5 125	x	3 80	12.50 318	4.00 102	27.0 12.2
					4 100	12.50 318	4.00 102
				5 125	14.00 356	4.50 114	37.0 16.8
6 150	x	6 150	x	4 100	14.00 356	4.50 114	36.0 16.3
					5 125	14.00 356	4.50 114
				6 150	18.00 457	6.00 152	62.0 28.1
					5 125	18.00 457	6.00 152
8 200	x	8 200	x	4 100	18.00 457	6.00 152	75.5 34.2
					6 150	18.00 457	6.00 152
				5 125	20.50 521	6.50 165	104.8 47.5
					6 150	20.50 521	6.50 165
10 250	x	10 250	x	4 100	20.50 521	6.50 165	105.8 48.0
					8 200	20.50 521	6.50 165
				5 125	23.00 584	7.00 178	122.0 55.3
					6 150	23.00 584	7.00 178
12 300	x	12 300	x	5 125	23.00 584	7.00 178	147.0 66.7
					8 200	23.00 584	7.00 178
				6 150	23.00 584	7.00 178	172.0 77.5
					10 250	23.00 584	7.00 178

Size			No. 30-R 45° Reducing Lateral (SW)				
Nominal Size Inches mm			C to LE Inches mm	C to SE Inches mm	Approx. Weight Each Lbs. kg		
# 14 350	x	14 350	x	4 100	26.50 673	7.50 191	172.0 78.0
				6 150	26.50 673	7.50 191	187.0 84.8
				8 200	26.50 673	7.50 191	205.8 93.4
				10 250	26.50 673	7.50 191	235.0 106.6
				12 300	26.50 673	7.50 191	250.0 113.4
				16 400	26.50 673	7.50 191	250.0 113.4
# 16 400	x	16 400	x	6 150	29.00 737	8.00 203	215.0 97.5
				8 200	29.00 737	8.00 203	252.5 114.5
				10 250	29.00 737	8.00 203	265.0 120.2
				12 300	29.00 737	8.00 203	295.0 133.8
				14 350	29.00 737	8.00 203	305.0 138.3
				18 450	29.00 737	8.00 203	305.0 138.3
# 18 450	x	18 450	x	6 150	32.00 813	8.50 216	274.0 124.3
				8 200	32.00 813	8.50 216	275.0 124.7
				12 300	32.00 813	8.50 216	347.0 157.4
				14 350	32.00 813	8.50 216	350.0 158.8
				16 400	32.00 813	8.50 216	362.0 164.2
				20 500	32.00 813	8.50 216	362.0 164.2
# 20 500	x	20 500	x	12 300	35.00 889	9.00 229	415.0 188.2
				14 350	35.00 889	9.00 229	420.0 190.5
				16 400	35.00 889	9.00 229	425.0 192.8
				24 600	35.00 889	9.00 229	425.0 192.8
# 24 600	x	24 600	x	16 400	40.00 1016	10.00 254	425.0 192.8
				20 600	40.00 1016	10.00 254	570.0 258.6
				24 600	40.00 1016	10.00 254	570.0 258.6
14 – 24 350 – 600			AGS For AGS fitting information, see publication 20.05				

For roll grooved systems, Victaulic offers the Advanced Groove System (AGS). For pricing and availability of cut groove fittings in this size, contact your nearest Victaulic sales office.

Note: All fittings are ductile iron unless otherwise noted with an "sw" or "s". SW= Segmentally Welded; S= Carbon Steel

Grooved End Fittings

Tee Wye

NO. 32

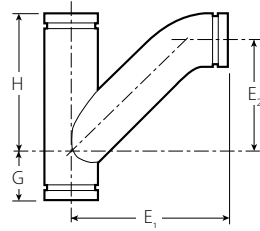

NO. 32

Size			No. 32 Tee Wye (SW)				Approx. Wgt. Each Lbs. kg
Nominal Size Inches mm	G Inches mm	H Inches mm	E ₁ Inches mm	E ₂ Inches mm			
2 50 × 2 50 × 2 50	2.75 70	7.00 178	9.00 229	4.63 118	6.4 2.9		
2½ 65 × 2½ 65 × 2½ 65	3.00 76	7.75 197	10.50 267	5.75 146	11.5 5.2		
3 80 × 3 80 × 3 80	3.25 83	8.50 216	11.50 292	6.50 165	14.3 6.5		
3½ 90 × 3½ 90 × 3½ 90	3.25 89	10.00 254	13.00 330	7.75 197	22.9 10.4		
4 100 × 4 100 × 4 100	3.75 95	10.50 267	13.63 346	8.13 207	26.0 11.8		

Size			No. 32 Tee Wye (SW)				Approx. Wgt. Each Lbs. kg
Nominal Size Inches mm	G Inches mm	H Inches mm	E ₁ Inches mm	E ₂ Inches mm			
5 125 × 5 125 × 5 125	4.00 102	12.50 318	16.13 410	10.00 254	48.0 21.8		
6 150 × 6 150 × 6 150	4.50 114	14.00 356	18.25 464	11.50 292	60.5 27.4		
8 200 × 8 200 × 8 200	6.00 152	18.00 457	23.25 591	15.25 387	127.1 57.7		
10 250 × 10 250 × 10 250	6.50 165	20.50 521	27.25 692	18.00 457	190.0 86.2		
12 300 × 12 300 × 12 300	7.00 178	23.00 584	31.00 787	20.50 521	240.0 108.9		

Note: All fittings are ductile iron unless otherwise noted with an "sw" or "s".
SW= Segmentally Welded S= Carbon Steel

Grooved End Fittings

Reducing Tee Wye

NO. 32-R

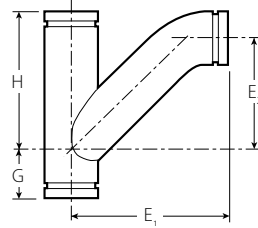

NO. 32-R

Size		No. 32-R Reducing Tee Wye (SW)					
Nominal Size Inches mm		G Inches mm	H Inches mm	E ₁ Inches mm	E ₂ Inches mm	Approx. Wgt. Each Lbs. kg	
4 100	3 80	3 80	3.50 89	9.50 241	10.75 273	5.75 146	16.0 7.3
			4 100	3.75 95	10.50 267	13.63 346	8.13 206
4 100	4 100	3 80	3.75 95	10.50 267	12.88 327	7.88 200	23.0 10.4
			5 125	1.25 32	9.75 248	11.50 292	7.63 194
5 125	3 80	3 80	4.00 102	12.50 318	16.13 410	11.13 283	43.4 19.5
			5 125	1.25 32	9.75 248	11.50 292	7.63 194
5 125	4 100	3 80	1.88 48	9.13 232	11.88 302	6.88 175	21.0 9.5
			4 100	1.88 48	9.13 232	12.75 324	7.25 184
5 125	5 125	3 80	4.00 102	12.50 318	14.25 362	9.25 235	29.0 13.2
			4 100	4.00 102	12.50 318	15.13 384	9.63 245
6 150	4 100	6 150	4.50 114	14.00 356	18.25 464	11.50 292	61.0 27.7
			6 150	1.25 32	10.75 273	13.00 330	8.00 203
6 150	5 125	3 80	1.25 32	10.75 273	13.88 352	8.38 213	31.0 14.1
			4 100	1.25 32	10.75 273	13.88 352	8.38 213
6 150	6 150	3 80	4.50 114	14.00 356	15.31 389	10.31 262	37.3 16.9
			4 100	4.50 114	14.00 356	16.25 413	10.75 273
6 150	6 150	5 125	4.50 114	14.00 356	17.25 438	11.13 283	55.0 24.9
			5 125	4.50 114	14.00 356	17.25 438	11.13 283

Size		No. 32-R Reducing Tee Wye (SW)						
Nominal Size Inches mm		G Inches mm	H Inches mm	E ₁ Inches mm	E ₂ Inches mm	Approx. Wgt. Each Lbs. kg		
8 200	6 150	4 100	1.00 25	12.00 304	14.75 375	9.25 235	45.0 20.4	
			8 200	6.00 152	18.00 457	23.25 591	15.25 387	112.0 50.8
8 200	8 200	3 80	6.00 152	18.00 457	18.19 462	13.19 335	76.0 34.5	
			4 100	6.00 152	18.00 457	19.00 483	13.50 343	76.4 34.7
			5 125	6.00 152	18.00 457	20.00 508	13.88 352	85.6 38.8
			6 150	6.00 152	18.00 457	21.13 537	14.38 365	112.0 50.8
10 250	10 250	3 80	6.50 165	20.50 521	19.88 505	14.88 378	96.0 43.5	
			4 100	6.50 165	20.50 521	20.75 527	15.25 387	97.4 44.2
			5 125	6.50 165	20.50 521	21.88 556	15.75 400	115.0 52.2
10 250	10 250	6 150	6.50 165	20.50 521	22.88 581	16.13 410	133.1 60.4	
			8 200	6.50 165	20.50 521	27.25 692	19.25 489	156.0 70.8

Note: All fittings are ductile iron unless otherwise noted with an "sw" or "s".
SW= Segmentally Welded S= Carbon Steel

Grooved End Fittings

Adapter Nipple

- NO. 40 Grv. x Thd.
- NO. 42 Grv. x Bev.
- NO. 43 Grv. x Grv.

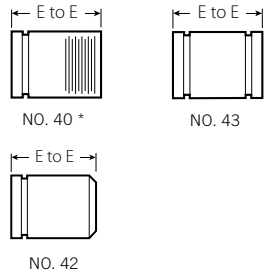

Size		No. 40, 42, 43 Adapter Nipple (s)	
Nominal Size Inches mm	Actual Outside Diameter Inches mm	E to E Inches mm	Approx. Weight Each Lbs. kg
3/4 20	1.050 26.9	3.00 76	0.3 0.1
1 25	1.315 33.7	3.00 76	0.4 0.2
1 1/4 32	1.660 42.4	4.00 102	0.8 0.4
1 1/2 40	1.900 48.3	4.00 102	0.9 0.4
2 50	2.375 60.3	4.00 102	1.2 0.5
2 1/2 65	2.875 73.0	4.00 102	1.9 0.9
3 80	3.500 88.9	4.00 102	2.5 1.1
3 1/2 90	4.000 101.6	4.00 102	2.1 0.9
4 100	4.500 114.3	6.00 152	5.5 2.5
5 125	5.563 141.3	6.00 152	7.4 3.4

Size		No. 40, 42, 43 Adapter Nipple (s)	
Nominal Size Inches mm	Actual Outside Diameter Inches mm	E to E Inches mm	Approx. Weight Each Lbs. kg
6 150	6.625 168.3	6.00 152	9.5 4.3
8 200	8.625 219.1	6.00 152	14.2 6.4
10 250	10.750 273.0	8.00 203	27.0 12.2
12 300	12.750 323.9	8.00 203	33.0 15.0

* Available with British Standard Pipe Threads, specify "BSP" clearly on order.

IMPORTANT NOTES:

For pump package nipples with 1 1/2"/40mm hole cut to receive Style 923 Vic-Let or Style 924 Vic-O-Well request special No. 40, 42 or 43 nipples and specify No. 40-H, 42-H or 43-H on order. NOTE: 4 - 12"/100 - 300mm diameter - 8"/200mm minimum length required.

For roll grooved systems, Victaulic offers the Advanced Groove System (AGS). For pricing and availability of cut groove fittings in this size, contact your nearest Victaulic sales office.

Note: All fittings are ductile iron unless otherwise noted with an "sw" or "s". SW= Segmentally Welded; S= Carbon Steel

Grooved End Fittings

Cap

NO. 60



NO. 60

Size		No. 60 Cap	
Nominal Size Inches mm	Actual Outside Diameter Inches mm	T Thickness Inches mm	Approx. Weight Each Lbs. kg
3/4 20	1.050 26.9	0.88 22	0.2 0.1
1 25	1.315 33.7	0.88 22	0.3 0.1
1 1/4 32	1.660 42.4	0.88 22	0.3 0.1
1 1/2 40	1.900 48.3	0.88 22	0.5 0.2
2 50	2.375 60.3	0.88 22	0.6 0.3
2 1/2 65	2.875 73.0	0.88 22	1.0 0.5
76.1 mm	3.000 76.1	0.88 22	1.2 0.5
3 80	3.500 88.9	0.88 22	1.2 0.5
3 1/2 90	4.000 101.6	0.88 22	2.5 1.1
108.0 mm	4.250 108.0	1.00 25	2.3 1.0
4 100	4.500 114.3	1.00 25	2.5 1.1
133.0 mm	5.250 133.0	1.00 25	4.5 2.0
139.7 mm	5.500 139.7	1.00 25	4.5 2.0
5 125	5.563 141.3	1.00 25	4.6 2.1
159.0 mm	6.250 159.0	1.00 25	6.8 3.1
165.1 mm	6.500 165.1	1.00 25	7.3 3.3

Size		No. 60 Cap	
Nominal Size Inches mm	Actual Outside Diameter Inches mm	T Thickness Inches mm	Approx. Weight Each Lbs. kg
6 150	6.625 168.3	1.00 25	6.1 2.8
8 200	8.625 219.1	1.19 30	13.1 5.9
10 250	10.750 273.0	1.25 32	21.0 9.5
12 300	12.750 323.9	1.25 32	35.6 16.2
14 # (s) 350	14.000 355.6	9.50 241	*
16 # (s) 400	16.000 406.4	10.00 254	*
18 # (s) 450	18.000 457.0	11.00 279	*
20 # (s) 500	20.000 508.0	12.00 305	*
24 # (s) 600	24.000 610.0	13.50 343	*
14 - 24 350 - 600	AGS For AGS fitting information, see publication 20.05		

IMPORTANT NOTES:

* Steel dish caps available through 24"/600mm, contact Victaulic.

No. 60 cap is not suitable for use in vacuum service with Style 72 or 750 couplings. No. 61 bull plugs should be used, see pg. 35.

For roll grooved systems, Victaulic offers the Advanced Groove System (AGS). For pricing and availability of cut groove fittings in this size, contact your nearest Victaulic sales office.

Note: All fittings are ductile iron unless otherwise noted with an "sw" or "s". SW= Segmentally Welded S= Carbon Steel

Grooved End Fittings

Flanged Adapter Nipple

- NO. 41** ANSI Class 125 (Cast Iron)
- NO. 45F** ANSI Class 150 Flat Face
- NO. 45R** ANSI Class 150 Raised Face
- NO. 46F** ANSI Class 300 Flat Face
- NO. 46R** ANSI Class 300 Raised Face

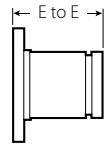

NO. 41

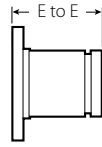

NO. 45F

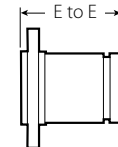

NO. 45R

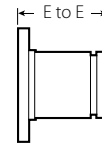

NO. 46F

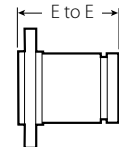

NO. 46R

Size		No. 41 ANSI 125 Flange Adapter Nipple		No. 45F and No. 45R ANSI 150 Flange Adapter Nipple (S)		No. 46F and No. 46R ANSI 300 Flange Adapter Nipple (S)	
Nominal Size Inches mm	Actual Outside Diameter Inches mm	E to E Inches mm	Approx. Weight Each Lbs. kg	E to E Inches mm	Approx. Weight Each Lbs. kg	E to E Inches mm	Approx. Weight Each Lbs. kg
3/4	1.050	3	—	3	2.3	3	3.3
20	26.9	76	—	76	1.0	76	1.5
1	1.315	3	2.5	3	2.7	3	3.9
25	33.7	76	1.1	76	1.2	76	1.8
1 1/4	1.660	4	3.0	4	3.3	4	4.8
32	42.4	102	1.4	102	1.5	102	2.2
1 1/2	1.900	4	3.5	4	3.9	4	6.9
40	48.3	102	1.6	102	1.8	102	3.1
2	2.375	4	5.5	4	6.2	4	8.2
50	60.3	102	2.5	102	2.8	102	3.7
2 1/2	2.875	4	8.0	4	9.9	4	11.9
65	73.0	102	3.6	102	4.5	102	5.4
3	3.500	4	9.5	4	11.4	4	16.5
80	88.9	102	4.3	102	5.2	102	7.5
3 1/2	4.00	4	12.0	4	15.1	4	20.1
90	101.6	102	5.4	102	6.8	102	9.1
4	4.500	6	16.7	6	18.4	6	27.4
100	114.3	152	7.6	152	8.3	152	12.4
5	5.563	6	21.5	6	21.3	6	35.3
125	141.3	152	9.8	152	9.7	152	16.0
6	6.625	6	26.5	6	27.5	6	47.5
150	168.3	152	12.0	152	12.5	152	21.5
8	8.625	6	39.0	6	41.3	6	70.3
200	219.1	152	17.7	152	18.8	152	31.9
10	10.750	8	57.0	8	59.8	8	100.8
250	273.0	203	25.9	203	27.1	203	45.7
12	12.750	8	41.0	8	88.2	8	146.2
300	323.9	203	18.6	203	40.0	203	66.3
14 #	14.000	8	—	8	—	8	—
350	355.6	203	—	203	+	203	+
16 #	16.000	8	—	8	—	8	—
400	406.4	203	—	203	+	203	+
18 #	18.000	8	—	8	—	8	—
450	457.0	203	—	203	+	203	+
20 #	20.000	8	—	8	—	8	—
500	508.0	203	—	203	+	203	+
24 #	24.000	8	—	8	—	8	—
600	610.0	203	—	203	+	203	+
14 – 24 350 – 600	For AGS fitting information, see publication 20.05						

IMPORTANT NOTES:

+ Contact Victaulic for details.

Flanged adapter nipples are supplied with standard rolled grooves.

Standard cut grooves or machining for rubber lining are optionally available. Contact Victaulic for details.

For roll grooved systems, Victaulic offers the Advanced Groove System (AGS). For pricing and availability of cut groove fittings in this size, contact your nearest Victaulic sales office.

Note: All fittings are ductile iron unless otherwise noted with an "sw" or "s". SW= Segmentally Welded S= Carbon Steel

Grooved End Fittings

Swaged Nipple

NO. 53 Grv. x Grv.
NO. 54 Grv. x Thd.
NO. 55 Thd. x Grv.

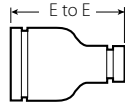

NO. 53

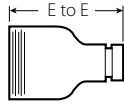

NO. 55

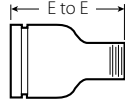

NO. 54

Size		No. 53, 54 and 55 Swaged Nipples (S)	
Nominal Size Inches		E to E Inches	Approx. Weight Each Lbs.
mm		mm	kg
2 50	x 1 25	6.50	2.0
		165	0.9
		1 1/4 32	2.0 0.9
1 1/2 40	x 1 1/2 40	6.50	2.0
		165	0.9
		2 1/2 65	3.0 1.4
1 1/4 32	x 1 1/4 32	7.00	3.0
		178	1.4
		1 1/2 40	3.0 1.4
2 50	x 2 50	7.00	3.0
		178	1.4
		3 80	4.5 2.0
1 1/4 32	x 1 1/4 32	8.00	4.5
		203	2.0
		1 1/2 40	4.4 2.0
2 50	x 2 50	8.00	4.5
		203	2.0
		2 1/2 65	4.5 2.0
3 1/2 90	x 3 80	8.00	6.8
		203	3.1
		4 100	7.5 3.4
1 1/4 32	x 1 1/4 32	9.00	7.5
		229	3.4
		1 1/2 40	7.5 3.4
2 50	x 2 50	9.00	7.5
		229	3.4
		4 100	7.5 3.4
4 100	x 2 1/2 65	9.00	7.5
		229	3.4

Size		No. 53, 54 and 55 Swaged Nipples (S)	
Nominal Size Inches		E to E Inches	Approx. Weight Each Lbs.
mm		mm	kg
4 100	x 3 80	9.00	7.5
		229	3.4
		3 1/2 90	9.00 3.4
5 125	x 2 50	11.00	11.5
		279	5.2
		3 80	11.00 5.1
4 100	x 4 100	11.00	11.5
		279	5.2
		6 150	12.00 7.7
1 1/4 32	x 1 1/4 32	12.00	17.0
		305	7.7
		1 1/2 40	12.00 7.8
2 50	x 2 50	12.00	17.4
		305	7.9
		2 1/2 65	12.00 7.9
3 80	x 3 80	12.00	17.4
		305	7.9
		3 1/2 90	12.00 7.9
4 100	x 4 100	12.00	17.5
		305	7.9
		4 1/2 120	12.00 7.9
5 125	x 5 125	12.00	17.5
		305	7.9
		8 200	20.0 9.1
8 200	x 6 150	+	

+ Contact Victaulic for details.

Note: All fittings are ductile iron unless otherwise noted with an "sw" or "s".
 SW= Segmentally Welded S= Carbon Steel

Grooved End Fittings

Female Threaded Adapter

NO. 80

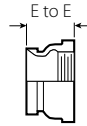

NO. 80

Size		No. 80 Female Threaded Adapter	
Nominal Size Inches mm	Actual Outside Diameter Inches mm	E to E Inches mm	Approx. Weight Each Lbs. kg
¾ 20	1.050 26.9	2.00 51	1.0 0.5
1 25	1.315 33.7	2.06 52	1.0 0.5
1 ¼ 32	1.660 42.4	2.31 (sw) 59	1.5 0.7
1 ½ 40	1.900 48.3	2.31 (sw) 59	1.5 0.7
2 50	2.375 60.3	2.50 64	1.4 0.6
2 ½ 65	2.875 73.0	2.75 70	1.5 0.7
3 80	3.500 88.9	2.75 70	2.9 1.3
4 100	4.500 114.3	3.25 83	4.5 2.0

Note: All fittings are ductile iron unless otherwise noted with an "sw" or "s".
SW= Segmentally Welded; S= Carbon Steel

IMPORTANT NOTE:

Available with British Standard Pipe threads, specify "BSP" clearly on order.

Hose Nipple

NO. 48

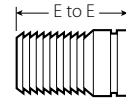

NO. 48

Size		No. 48 Hose Nipple (s)	
Nominal Size Inches mm	Actual Outside Diameter Inches mm	E to E Inches mm	Approx. Weight Each Lbs. kg
¾ 20	1.050 26.9	3.12 79	0.3 0.1
1 25	1.315 33.7	3.38 86	0.4 0.2
1 ¼ 32	1.660 42.4	3.88 98	0.6 0.3
1 ½ 40	1.900 48.3	3.88 98	0.8 0.4
2 50	2.375 60.3	4.50 114	1.1 0.5
2 ½ 65	2.875 73.0	5.38 137	2.0 0.9
3 80	3.500 88.9	5.75 146	3.2 1.5
4 100	4.500 114.3	7.00 178	4.9 2.2
5 125	5.563 141.3	8.75 222	8.0 3.6
6 150	6.625 168.3	10.12 257	14.3 6.5
8 200	8.625 219.1	11.88 302	24.7 11.2
10 250	10.750 273.0	12.50 318	40.1 18.2
12 300	12.750 323.9	14.50 368	62.0 28.1

Note: All fittings are ductile iron unless otherwise noted with an "sw" or "s".
SW= Segmentally Welded; S= Carbon Steel

Grooved End Fittings

Concentric/Eccentric Reducer

NO. 50 Concentric
NO. 51 Eccentric



NO. 50

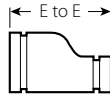

NO. 51

Size	No. 50 Concentric Reducer		No. 51 Eccentric Reducer		
	Nominal Size Inches mm	E to E Inches mm	Approx. Weight Each Lbs. kg	E to E Inches mm	Approx. Weight Each Lbs. kg
1 1/4 × 3/4	20	+	1.9 0.9	—	—
	25	+	1.9 0.9	—	—
1 1/2 × 1	20	+	1.4 0.6	—	—
	25	2.50 64	0.8 0.4	8.50 (SW) 216	4.5 2.0
	32	2.50 64	1.0 0.5	—	—
2 × 1 1/4	20	2.50 64	0.9 0.3	9.00 (SW) 229	2.0 0.9
	25	2.50 64	0.7 0.3	9.00 (SW) 229	2.3 1.0
	32	2.50 64	1.2 0.5	9.00 (SW) 229	4.6 2.1
	40	3.50 89	1.0 0.5	3.50 89	1.1 0.5
	50	2.50 64	3.9 1.8	9.50 (SW) 241	4.3 2.0
2 1/2 × 1 1/2	20	+	1.3 0.6	+	3.3 1.5
	25	2.50 64	1.1 0.5	9.50 (SW) 241	3.5 1.6
	32	3.50 89	3.3 1.5	3.50 89	1.4 0.6
	40	2.50 64	3.6 1.6	9.50 (SW) 241	3.7 1.7
	50	2.50 64	3.9 1.8	9.50 (SW) 241	4.3 2.0
	76.1	2.50 64	2.1 1.0	—	—

Size	No. 50 Concentric Reducer		No. 51 Eccentric Reducer			
	Nominal Size Inches mm	E to E Inches mm	Approx. Weight Each Lbs. kg	E to E Inches mm	Approx. Weight Each Lbs. kg	
3 1/2 × 3	80	2.50 64	2.0 0.9	9.50 (SW) 241	7.0 3.2	
	100	3.00 76	3.0 1.4	13.00 (SW) 330	6.5 2.9	
4 × 1 1/2	25	+	4.6 2.1	—	—	
	32	+	4.6 2.1	—	—	
	40	3.00 (SW) 76	2.6 1.2	10.00 (SW) 254	8.1 3.7	
	50	3.00 76	2.4 1.1	4.00 102	3.3 1.5	
	65	3.00 76	2.7 1.2	4.00 102	3.4 1.5	
	80	3.00 76	3.2 1.4	4.00 102	3.5 1.6	
5 × 3 1/2	90	3.00 76	2.9 1.3	10.00 (SW) 254	8.0 3.6	
	125	2 × 50	11.00 (SW) 279	9.0 4.1	11.00 (SW) 279	5.2 2.4
	65	2 1/2 × 65	4.00 102	4.3 2.0	11.00 (SW) 279	10.8 4.9
	80	3 × 80	4.00 102	5.5 2.5	11.00 (SW) 279	11.1 5.0
	100	4 × 100	3.50 89	4.3 1.9	5.00 127	12.0 5.4
6 × 1 1/2	25	4.00 102	5.0 2.3	11.50 (SW) 292	14.5 6.6	
	40	+	5.5 2.5	+	+	
	50	2 × 50	4.00 102	6.6 3.0	11.50 (SW) 292	14.5 6.6
	65	2 1/2 × 65	4.00 102	6.4 2.9	11.50 (SW) 292	14.2 6.4
	80	3 × 80	4.00 102	6.4 2.9	5.50 140	15.0 6.8
	100	4 × 100	4.00 102	6.5 2.9	5.50 140	17.0 7.7
8 × 2 1/2	125	5 × 125	4.00 102	6.4 2.9	5.50 140	17.0 7.7
	200	2 1/2 × 65	16.00 406	7.9 3.6	12.00 (SW) 305	26.1 11.8
	80	3 × 80	5.00 127	9.3 4.2	12.00 (SW) 305	22.0 10.0

Note: All fittings are ductile iron unless otherwise noted with an "sw" or "s".
SW= Segmentally Welded S= Carbon Steel

Grooved End Fittings

Concentric/Eccentric Reducer

NO. 50 Concentric
NO. 51 Eccentric



NO. 50

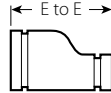

NO. 51

Size		No. 50 Concentric Reducer		No. 51 Eccentric Reducer		
Nominal Size Inches mm		E to E Inches mm	Approx. Weight Each Lbs. kg	E to E Inches mm	Approx. Weight Each Lbs. kg	
8 200	x	4 100	5.00 127	10.4 4.8	12.00 (SW) 305	23.0 10.4
		5 125	5.00 127	11.6 5.2	12.00 (SW) 305	23.0 10.4
		6 150	5.00 127	11.9 5.4	6.00 152	24.0 10.9
10 250	x	4 100	6.00 152	19.7 8.9	13.00 (SW) 330	32.0 14.5
		5 125	+	34.3 15.6	+	34.6 15.7
		6 150	6.00 152	20.0 9.1	13.00 (SW) 330	36.9 16.7
		8 200	6.00 152	22.0 10.0	7.00 178	21.6 9.8
12 300	x	4 100	+	44.0 20.0	14.00 (SW) 356	48.0 21.8
		6 150	7.00 178	24.6 11.2	14.00 (SW) 356	50.0 22.7
		8 200	7.00 178	52.0 23.6	14.00 (SW) 356	53.5 24.3
		10 250	7.00 178	39.0 17.7	14.00 (SW) 356	57.0 25.9
# 14 350	x	6 150	13.00 330	65.0 29.5	13.00 330	60.0 27.2
		8 200	13.00 330	65.0 29.5	13.00 330	60.0 27.2
		10 250	13.00 330	66.0 29.9	13.00 330	65.0 29.5
		12 300	13.00 330	68.0 30.8	13.00 330	66.0 29.9
# 16 400	x	8 200	14.00 356	73.0 33.1	14.00 355	73.0 33.1
		10 § 250	14.00 356	73.0 33.1	14.00 355	73.0 33.1
		12 300	14.00 356	73.0 33.1	14.00 355	73.0 33.1
		14 350	14.00 356	73.0 33.1	14.00 355	73.0 33.1
# 18 450	x	10 250	15.00 381	91.0 41.3	15.00 381	91.0 41.3

Size		No. 50 Concentric Reducer		No. 51 Eccentric Reducer		
Nominal Size Inches mm		E to E Inches mm	Approx. Weight Each Lbs. kg	E to E Inches mm	Approx. Weight Each Lbs. kg	
# 18 450	x	12 300	15.00 381	91.0 41.3	15.00 381	91.0 41.3
		14 350	15.00 381	91.0 41.3	15.00 381	91.0 41.3
		16 400	15.00 381	91.0 41.3	15.00 381	91.0 41.3
# 20 500	x	10 250	20.00 508	110.0 49.9	20.00 508	177.0 80.3
		12 300	20.00 508	120.0 54.4	20.00 508	120.0 54.4
		14 350	20.00 508	149.0 67.9	20.00 508	149.0 67.9
		16 400	20.00 508	120.0 54.4	20.00 508	120.0 54.4
		18 450	20.00 508	136.0 61.7	20.00 508	136.0 61.7
# 24 600	x	10 250	20.00 508	142.0 64.4	20.00 508	142.0 64.4
		12 300	20.00 508	150.0 68.0	20.00 508	150.0 68.0
		14 350	20.00 508	162.0 73.5	20.00 508	162.0 73.5
		16 400	20.00 508	162.0 73.5	20.00 508	162.0 73.5
		18 450	20.00 508	162.0 73.5	20.00 508	162.0 73.5
		20 500	20.00 508	151.0 68.5	20.00 508	190.0 86.2
14 - 24 350 - 600		AGS For AGS fitting information, see publication 20.05				

+ Contact Victaulic for details.

* Available with male threaded small end No. 52.

Note: All fittings are ductile iron unless otherwise noted with an "sw" or "s".
SW= Segmentally Welded- S= Carbon Steel

IMPORTANT NOTE:

Steel eccentric reducers available through 30"/750mm, contact Victaulic for dimensions.

For roll grooved systems, Victaulic offers the Advanced Groove System (AGS). For pricing and availability of cut groove fittings in this size, contact your nearest Victaulic sales office.

§ Cast fitting available for JIS size. Contact Victaulic for details.

Grooved End Fittings

Small Threaded Reducer

NO. 52



NO. 52



NO. 52F

Size	No. 52 Small Threaded Reducer		No. 52F Concentric Reducer with BSPT Female Threaded End		
	Nominal Size Inches mm	E to E Inches mm	Approx. Weight Each Lbs. kg	E to E Inches mm	Approx. Weight Each Lbs. kg
1½ 40	×	1 25	2.50 64	0.8 0.4	—
		1¼ 32	2.50 64	0.9 0.4	—
2 50	×	¾ 20	2.50 64	0.9 0.4	—
		1 25	2.50 64	0.7 0.3	—
		1¼ 32	2.50 64	1.2 0.5	—
		1½ 40	2.50 64	1.0 0.5	—
2½ 65	×	1 25	2.50 64	1.1 0.5	—
		1¼ 32	2.50 (sw) 64	1.2 0.5	—
		1½ 40	2.50 (sw) 64	1.3 0.6	—
		2 50	3.00 76	1.4 0.6	—
76.1	×	48.3	63.5	0.8	63.5
		60	—	—	63.5
3 80	×	¾ 20	+(sw)	1.5 0.7	—
		1 25	2.50 64	1.3 0.6	—
		1¼ 32	2.50 64	1.5 0.7	—
		1½ 40	2.50 (sw) 64	1.5 0.7	—
		2 50	2.50 64	1.5 0.7	—
		2½ 65	2.50 64	2.4 1.1	—
		88.9	×	42.4 48.3 60	63.5 63.5 —
4 100	×	1 25	3.00 76	2.3 1.0	—
		1½ 40	3.00 76	2.7 1.2	—
		2 50	3.00 76	2.6 1.2	—

Size	No. 52 Small Threaded Reducer		No. 52F Concentric Reducer with BSPT Female Threaded End			
	Nominal Size Inches mm	E to E Inches mm	Approx. Weight Each Lbs. kg	E to E Inches mm	Approx. Weight Each Lbs. kg	
4 100	×	2½ 65	3.00 76	2.6 1.2	—	
		3 80	3.00 76	2.5 1.1	—	
108	×	42.4	76.2	1.3	76.2	
		48.3	76.2	1.3	76.2	
114.3	×	60	—	—	76.2	
		42.4	76.2	1.3	76.2	
		48.3	76.2	1.3	76.2	
5 125	×	4	+	4.5 2.0	—	
		100	+	—	—	
		133	×	60	—	114.3
139	×	60	—	—	114.3	2.26
6 150	×	1	4.00	5.5	—	
		25	102	2.5	—	
		2	4.00	5.7	—	
		50	102	2.6	—	
		2½	4.00	5.8	—	
		65	102	2.6	—	
		3	4.00	5.8	—	
159	×	80	102	2.6	—	
		4	+(sw)	6.5	—	
		100	+(sw)	2.9	—	
		5	+(sw)	2.0	—	
		125	+(sw)	0.9	—	
165.1	×	42.4	114.3	2.2	114.3	
		48.3	114.3	2.2	114.3	
		60	—	—	114.3	
8 200	×	42.4	101.6	2.4	101.6	
		48.3	101.6	2.6	101.6	
		60	—	—	101.6	
200	×	2	16.00	1.5	—	
		50	406	0.7	—	
		2½	16.00	1.7	—	
65	406	0.8	—			

+ Contact Victaulic for details.

Note: All fittings are ductile iron unless otherwise noted with an "sw" or "s".
SW= Segmentally Welded S= Carbon Steel

IMPORTANT NOTE:

Available with British Standard Pipe Threads, specify "BSP" clearly on order

Grooved End Fittings

INSTALLATION

Reference should always be made to the I-100 Victaulic Field Installation Handbook for the product you are installing. Handbooks are included with each shipment of Victaulic products for complete installation and assembly data, and are available in PDF format on our website at www.victaulic.com.

WARRANTY

Refer to the Warranty section of the current Price List or contact Victaulic for details.

NOTE

This product shall be manufactured by Victaulic or to Victaulic specifications. All products to be installed in accordance with current Victaulic installation/assembly instructions. Victaulic reserves the right to change product specifications, designs and standard equipment without notice and without incurring obligations.