

Snap-Rite *Manufacturing, Inc.*

A Gray Co.

IRON HORSE



AS STRONG AS
THE NAME IMPLIES

Snap-Rite Manufacturing, Inc.

®

Coats, NC



Cleveland, OH



Lake Park, GA

Product Return Policy

Please apply the following guidelines to any products requested to be returned for credit:

- 1. Specialty products made (non-stock items) will not be accepted for return under any circumstances.**
- 2. Standard products will be considered for return if they are returned within 90 days in the original carton. Management will take into consideration the number of inventory turns the product has in deciding whether they will accept the product back. If cartons are damaged from the outside after remaining in the customer warehouse for any length of time, it will be assumed the damage occurred at the customer location and not as a result of shipping or vendor negligence and therefore considered not valid.**
- 3. Product authorized for return must have our written return form attached to product being returned and copy given to driver.**
- 4. A 15% restocking charge will be applied to all returns resulting from excess inventory or customer error in ordering. When Snap-Rite has made the error, the return will be handled automatically and the customer will be given the option of the correct product being shipped out prepaid, regardless of minimums being met.**
- 5. Product shipped that was damaged in transit will be able to be returned and exchanged when reported within 24 hours of receipt.**

Shortage/Overage Policy

Snap-Rite requires any shortages or overages to be reported within 24 hours of delivery

©2010 SNAP-RITE MANUFACTURING, INC. THIS CATALOG AND ALL CONTENTS ARE THE PROPERTY OF SNAP-RITE MANUFACTURING AND ANY REPRODUCTION IN WHOLE OR IN PART IS PROHIBITED WITHOUT WRITTEN PERMISSION.

GRAY "Snap-Rite"

STANDARDIZED FITTINGS ARE YOUR



KEY

TO CONSISTENTLY DEPENDABLE, UNIFORMLY

HIGH QUALITY!

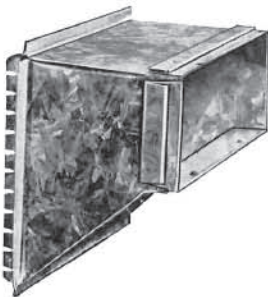
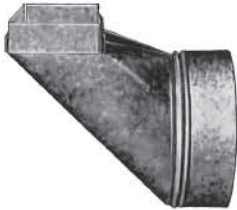
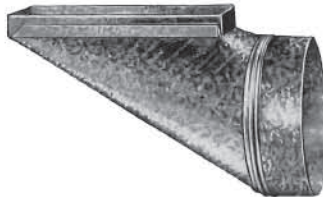

"Snap-Rite" Standardized Fittings save you money in many other important ways, too. Take quality, for instance.

Designed with you in mind by installation-experienced engineers and manufactured by modern methods from prime material to exacting standards of accuracy, these pre-engineered precision products are far less subject to quality variation than hand-made fittings. In fact, because they are made to uniformly close tolerances, accuracy and interchangeability are **automatically** assured.

What does this consistently dependable, repetitively uniform quality mean to busy contractors? It spells such additional savings as easier installation, making every minute on the job count to meet rigid completion-time schedules, lower labor costs, and complete customer satisfaction.

That's because **"Snap-Rite"** duct, stack, fittings, elbows and angles, besides their in-built quality, incorporate fast-locking, snap-into-place devices that assure easy, rapid assembly. With magical simplicity and speed, you have the completed, leak-proof assembly you want, ready for installation. What's more, you always get the perfect fit that meets the most critical inspection.

FOUR MORE SHORT STUDIES AND STORIES ON SAVING

Just how much do these die-cut, easier-to-install fittings simplify and speed warm air heating and air conditioning jobs as a result of these and other time-trimming, cost-cutting features?

On most installations, one contractor reports he saves an average of 15%, often more.

Another dealer who formerly made his own fittings now makes a 25% saving in labor on most installations by using **"Snap-Rite" Standardized Fittings**.

Other contractors say they save up to **eight** installation hours **per job!** And on one municipal multiple-housing project recently, use of **"Snap-Rite" Standardized Fittings** effected a saving of 1,950 man-hours on 325 installations—**six** hours **per job!**

And as you know from past experience, during the busy heating season, when the peak load presents your biggest problem by putting a premium on your time, every minute must count! **"Snap-Rite" Standardized Fittings** can save you shop time, giving you that much **more** time to handle **more** jobs!

Remember, it's in **sales** and **service**—not working at the bench—where **you** make the most money!

Manufacturing History of the Gray Family

The Gray family came into the United States after a brief stay in Ontario Canada, emigrating originally from Scotland.

William Gray moved most of his family from Ontario, Canada in 1893 relocating to Rochester, New York. William's oldest son Malcolm remained in Ontario as an owner/operator of a hardware store until 1898 when he sold the hardware store and moved to Rochester, N.Y.

Three sons of William Gray – Malcolm E.Gray, William H. Gray and Daniel D. Gray eventually having each secured jobs at the Rochester Stamping Company between mid 1894 and through approx.August 1903 learned the stamping/tinware trade to a point that they were ready to start their own stamping house.

September **1903** Atlantic Stamping Co. founded by the three brothers - Malcolm E.Gray,William H.Gray and Daniel D.Gray collectively secured a small room and purchased two or three second hand machines. Each of the brothers being knowledgeable mechanics began manufacturing household items starting first with making oil and gas cans. Eventually due to the high quality of their offering their customers encouraged them to expand their product offering which they did to include wash boilers and dairy pails. The rapid success of the Atlantic Stamping Company attracted the interest of several affluent Rochester business people most notably Mr.W.J.McKelvey a man well known in the Masonic circles of the city and state. A partnership was formed between the Gray brothers and Mr.McKelvey and soon thereafter they recognized as the business was rapidly growing they needed to expand with a larger building and more equipment to grow the product offering to include cups,dippers,dishpans,cream pails, cream seperators,galvanized wash tubs and other related goods. The company was incorporated and Mr. McKelvey being connected with many affluent Rochester businessmen attracted several investors to put capital in secured with company stock. After the infusion of investment capital it was decided to construct a state of the art manufacturing facility of 52,804 sq.ft. which was constructed on Ames St.Rochester, New York. During the period between March 1905 and September 1908 Malcolm and brother William file several patent applications for various metalware items resulting in 2 jointly issued patents and 5 individually issued patents.(Patent#'s 796,717 ;893,321 ;890,640 ;893,484 ;880,522 ;876,633 ;884,485)

In **1908**, The Gray brothers decide to sell their interest in the Atlantic Stamping Company sending the three brothers on different career paths. That same year (**1908**), Malcolm E. Gray founds Rochester Can Company.Brother; Daniel D. Gray decides to work with Malcolm as superintendant at Rochester Can Company. Rochester Can Company is founded to produce items under the IRON HORSE trade name that are in direct competition with Atlantic Stamping Co. The Rochester Can Company achieves recognition for the founding and implementation of the Five Day Work Week. This plan was first implemented by Malcolm Gray at Rochester Can Company in January 1922.The plan was studied by Henry Ford on a visit to Malcolm Gray's home and Ford liked the plan so much after observance at Rochester Can Company that Ford went back to Michigan and implemented the plan in his own factories. Due to Ford's national exposure it has been erroneously assumed that Ford was the originator of the plan.(See factual references for validation facts at end of this brief history contained herein).Rochester Can Company was known as the manufacturer of more hardware items than any other manufacturer of its kind at the time. Daniel D.Gray, superintendent of Rochester Can Company dies 8/29/30 after long illness. Malcolm E. Gray, founder of Rochester Can Company dies of pneumonia 11/7/32. Prior to his death, Malcolm turned over control of Rochester Can Company to his two sons in law, Rodney S.Hatch and William Easton, on April 25,1930.Rochester Can Company was eventually sold to outside investors in 1951 and within 8 years of being sold was declared bankrupt and liquidated by September 1959.This ended the entrepreneurial involvement of descendants of Malcolm E. Gray and Daniel D. Gray in the metal goods industry. This however is not the case of the descendants of William H.Gray.

In **1908**, after selling his interest in Atlantic Stamping Co, William H. Gray pursues a career path which leads him into another metal related trade. William H. Gray starts a contracting business dealing with the public as a sheet metal tradesman. William offers "Tin, Copper and Sheet Iron Work" specializing in "Furnace Heating a specialty". He offers service in general jobbing and repair, furnaces and stoves cleaned and repaired, conductor pipes painted and advertizes "all kinds of specialty work". William advertizes as an agent for underground garbage cans manufactured by

Manufacturing History of the Gray Family

Rochester Can Company. William buys out a competitor and continues as a contractor for approx. 18 years. William expands during this time into gutter related items and applies for patents related to stove pipe and gutter end cap. In 1921 and again in 1922 William is issued patents for his ideas. (Pat #'s 1,373,883 ;1,437,937). During the period beginning in the mid 1920's William operates his business under the name of William H.Gray & Son's along with his two son's William J.Gray(my grandfather) and Donald E.Gray. William H. Gray & Son's was manufacturing items at their 20 Beacon St. Rochester, New York location. Items manufactured include furnace elbows, nestable furnace tees, gutter hangers, gutter caps, gutter outlets, and sheet metal ductwork.

In May **1932**, Gray Metal Products, Inc. is incorporated. William H.Gray and wife Emma are majority stockholders with son's William J. and Donald E. as minority stockholders. William H.Gray sells the assets of William H.Gray & Son's to Gray Metal Products, Inc.for the price of \$1894.16 in order to start the company. The asset list includes 14 punch and forming presses, 1 new elbow machine, and 54 dies for gutter and furnace pipe items among other shop related items. Within the first year William H. and son William J.Gray apply for two patents resulting in one jointly issued patent and one individually issued patent (Pat#'s 1,848,947 ;1,903,861).

During **1941**, William H.Gray applies for and is issued two more patents, one for eave trough hanger and one for duct joint construction (Pat#'s 2,233,049 ;2,260,221).

During **1942**, William J.Gray applies for and is issued a patent for duct joint (Pat# 2,274,785).

During **1953**, William J.Gray applies for and is issued a patent for a snap lock for pipe (Pat# 2,264,761).

June **1953**, Donald E. Gray, essentially acting as a silent partner, sold his interest in Gray Metal Products, Inc. to the remaining stockholders.

Gray Metal Products, Inc.evolves as a full line pre-fabricated sheet metal air duct manufacturer. Gray Metal establishes a reputation for providing high quality air duct products throughout the New York, Pennsylvania, and New England regions.

William H.Gray dies **1955** leaving complete control of Gray Metal Products to son William J.Gray.

William J.Gray operates Gray Metal Products as a thriving duct manufacturer operating two locations, one in Rochester, N.Y. and one in Webster, New York.

In **1958**,Gray Metal Purchases the first Welty Way"Colatch Machine" for attaching collars to fittings automatically. This machine was delivered by Mr. Welty to Gray Metal in his pick-up truck and was the first machine sold by the Welty's whose company is now more commonly known as Iowa Precision.

Richard E. Gray Sr., son of William J.Gray, enters Gray Metal after receiving dual degree's from University of Rochester in **1966**. Richard first works at Gray Metal Products in sales capacity working the New York, Pennsylvania and New England markets.

In between road trips Richard Sr. develops his skills operating various machinery throughout the factory.

In **1969** Richard Gray Sr.realizing the need to expand and automate the factory, through much debate and persuasion, convinces his father William J. Gray to put a 10,000 sq. ft. addition onto the Rochester location and purchases a 60"Welty Way Slear to process steel. This innovation transforms Gray Metal Products from a sheet fed plant to a coil fed plant, thereby reducing the material cost and positioning Gray Metal Products to compete with the larger manufacturers. This 1969 Slear is still in use today at Gray Metal's Avon, New York location.

Manufacturing History of the Gray Family

December **1974** William J. Gray dies leaving Richard E.Gray Sr. with complete operational control of Gray Metal Products, Inc. Ownership is split between Richard Sr. and his mother Marguerite S.Gray.Richard was driven by his unrelenting commitment to continue his father's life work in a fashion that would make his father proud, and he did.

In **1974**, when Richard assumed control of Gray Metal Products the country was in a recession, especially the home building industry. Richard diversified Gray Metal's product offering and grew the business in spite of the recession in sectors other than new home construction.

Richard's wife Carole worked by his side in the business beginning primarily in **1974**. There was nothing that Richard and Carole didn't do relative the various jobs at Gray Metal Products, Inc.Including running pipe, duct, loading and cutting coils, sweeping the floor, machine maintenance, running boot and fitting orders, customer sales calls and any and everything it took to run and grow that business. Richard had Carole's never ending support and they grew Gray Metal products, Inc.together, side by side.

In **1979**, Marguerite S.Gray dies leaving her stock to son Richard Sr. in recognition of his dedication to Gray Metal Products, Inc.

In **1983**, Gray Metal Products, Inc. purchases a facility that increased their manufacturing/warehouse space from 45,000 sq. ft. total to over 90,000 sq. ft. total. The business is relocated to the new location from Carlton St. to Norman St. Richard Sr. continues to invest significantly in automation to make Gray Metal Products into one of the most automated factories in the industry.

Gray Metal Products,Inc continues to grow significantly during the 1980's. Richard and Carole's children William,Marguerite,Richard Jr.,Martin and Joseph all enter the business performing various jobs beginning mid to late 70's and all are active in the family business's currently.

Every one of Richard and Carole's children learn the different jobs in the factory the same way that Richard and Carole did themselves, by doing it.

August **1989**, William R.Gray founds Gray Flex Systems, Inc., a flexible air duct manufacturer, in a 3600 sq. ft. room of Gray Metal Products, Inc's. Norman St. location. Richard and Carole, having confidence in son William, cosign a capital investment loan to help William start up. William's wife Carrie works with William from start up and is currently active in the business as Sec. /Treasurer.

1992, William R.Gray applies for and is issued his first patent for reinforced flexible duct core (Pat#5,526,849)

1991,The Gray Family acquires a small competitor by the name of Nova Industries of West Point, Virginia which occupies a 43,000 sq. ft. facility at the time. Marguerite and Joseph Gray relocate to run this factory. The company is renamed Gray Metal South, Inc.

1992, Gray Flex Systems, Inc.relocates to North Carolina and enjoys rapid growth currently operating in a 190,000 sq. ft. facility in Coats, North Carolina.

1997, Gray Metal South sells their Virginia based location and relocates to Dunn, North Carolina enjoys rapid growth and currently operates in a 235,000 sq. ft. facility.

1997, Gray Metal Products,Inc.relocates primary operations to Avon, New York while maintaining auxiliary warehouse location on Norman St.,combined footage of 280,000 sq. ft.

Manufacturing History of the Gray Family

1998, William R.Gray founds Snap-Rite Manufacturing in Coats, North Carolina with brother Richard Jr. to manufacture insulated sheet metal duct items.

1998, William R.Gray applies for and is issued two patent's,one for vent screen and one for motorcycle warning device(Pat#'s 6,361,433 ;6,034,594)

2000, Snap-Rite Manufacturing, Inc. purchase a competitor named Automated Ductwork Manufacturing of Cleveland, Ohio, currently operating in a 110,000 sq. ft. manufacturing facility.

2001, Snap-Rite Manufacturing ,Inc. relocates from Coats, North Carolina to Lake Park, Georgia to better serve the Florida, Georgia and Alabama market place, currently occupiea a 155,000 sq. ft. manufacturing facility.

2002, William R.Gray applies for and is issued patent for flexible duct packaging (Pat# 6,913,142)

2002, Richard Jr. leaves Snap-Rite Manufacturing to return to Rochester, New York working for Gray Metal Products,Inc . Richard Jr. joins brother Martin to assist Richard Sr. and Carole in the day to day operations so that Richard Sr. and Carole can spend time away from Gray Metal Products, Inc.

2006, Richard E.Gray Sr., dies unexpectedly leaving controlling interest in Gray Metal Products, Inc.to wife Carole where she remains active in the day to day operations of Gray Metal Products, Inc. Sons Richard Jr. and Martin active here as well. At the time of Richard Sr.'s death Gray Metal Products, Inc has grown by approximately 10 times the size it was when Richard Sr. and wife Carole took over in 1974.

2007, Joseph E.Gray, founds Gray Metal South Central,Inc.,a start up sheet metal air duct manufacturer located in Humbolt,Tenn. Currently operating in a 138,000 sq. ft. facility.

2008, William R.Gray applies for several other patents relating to the air duct industry, all are currently pending.

2008 The Gray family acquires the assets of Air Fab of New Jersey AKA Cheney Co. and absorbs equipment within multiple plant locations.

2008 Snap-Rite acquires the assets of Nu Era of Michigan and relocates the assets between Cleveland, Ohio and Lake Park, Georgia locations.

2010 William R. Gray applies for and is issued patent for Flex Metering Device (Pat# 7,681,729)

All Gray Family Manufacturing locations have in house tool&die capabilities along with machine building and design facilities. This capability enables the Gray Companies to respond quickly to market changes that require constant improvement in manufacturing techniques. This capability also assists in the development of new product ideas.

Factual references; The Utica Observer 11/8/1932;Encyclopedia of Biography;Gray,Malcolm Edward;Rochester Democrat&Chronicle Nov.8,1932;Special to The New York Times Nov.7,1932;Patent References-U.S.Patent and Trademark Office;Rochester Democrat&Chronicle Mar.22,1930;Rochester Democrat&Chronicle Nov.19,1904;Rochester Democrat&Chronicle Feb.21,1951;Rochester Democrat&Chronicle Nov. 2,1956;Rochester Democrat&Chronicle June 4,1930;Oswego Daily Palladium Apr.24,1915;Rochester City Directory Collection,1914,1915,1916;City of Rochester,N.Y. Proclamation Jan.2,1992

Galvanized Warm Air System

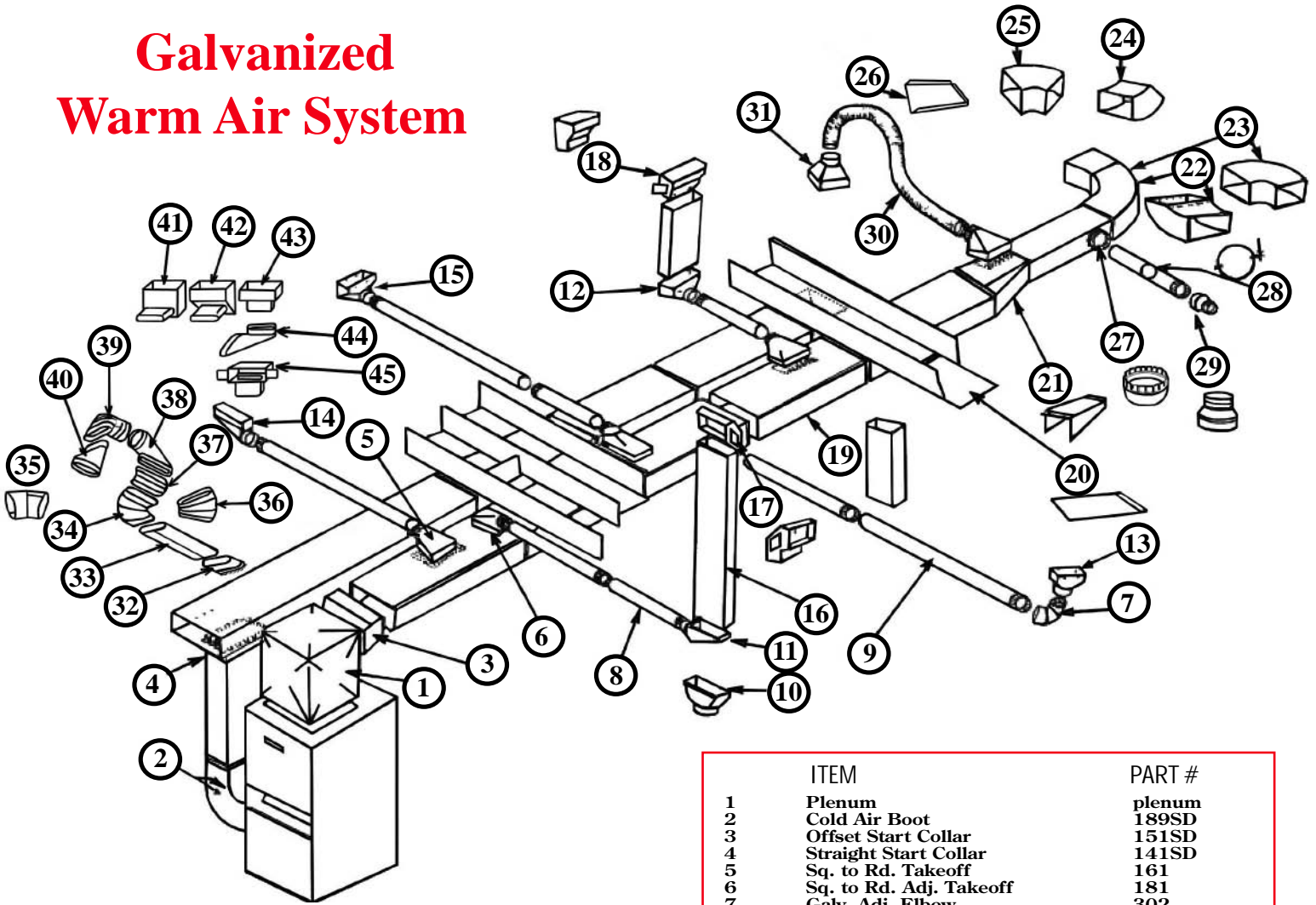

Flue Pipe System

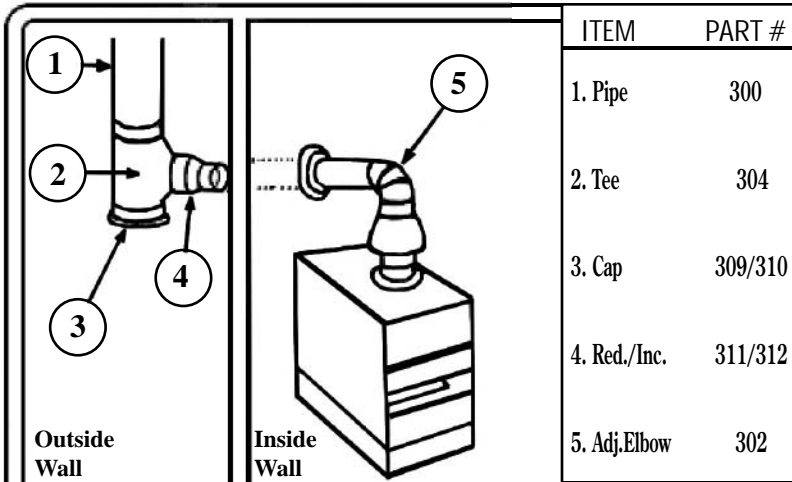

ITEM	PART #
1. Pipe	300
2. Tee	304
3. Cap	309/310
4. Red./Inc.	311/312
5. Adj.Elbow	302

ITEM	PART #	
1	Plenum	plenum
2	Cold Air Boot	189SD
3	Offset Start Collar	151SD
4	Straight Start Collar	141SD
5	Sq. to Rd. Takeoff	161
6	Sq. to Rd. Adj. Takeoff	181
7	Galv. Adj. Elbow	302
8	Galv. 2' Pipe	300
9	Galv. 5' Pipe	301
10	Straight Stack Boot	110S
11	Center End Stack Boot	112S
12	90° Stack Boot	113S
13	Straight Register Boot	110R
14	Center End Register Boot	112R
15	90° Register Boot	113R
16	Wallstack	124BL
17	Stackhead	104E
18	Horizontal Stackhead	103
19	Rectangular Duct	125SD
20	Joist Panning	323
21	Duct Reducer	210SD
22	Shortway Elbow	120SD
23	Longway Elbow	122SD
24	Shortway Angle	121SD
25	Longway Angle	123SD
26	Duct End Cap	187SETSD
27	Round Start Collar	313
28	Damper	314
29	Reducer/Incraser	311/312
30	Insulated Flex Duct	Buyers Choice
31	Top Ceiling Box	320
32	Oval Start Collar	513SE
33	Oval Pipe	500/501
34	Oval Horizontal Elbow	502-OF
35	Oval Horizontal Angle	503-OF
36	Oval Vertical Angle	503-O
37	Oval Vertical Elbow	502-O
38	Oval End Boot	504-O
39	Oval Register 90° Boot	505-O
40	Oval Straight Boot	506-O
41	Sq. to Oval Horz. Boot	510-O
42	Sq. to Oval Angle Boot	509-O
43	Sq. to Oval Straight Boot	508-O
44	Oval to Oval Boot	514-O
45	Oval Stackhead	507-O

NEVER use single wall pipe in areas that will remain non-conditioned space -- i.e. unheated attic/outside of the exterior wall -- **always** check codes.

PRODUCT INDEX

Snap-Rite
Manufacturing, Inc.
A Gray Co.

ADHESIVE/GASKET SPIN FITTING - RD. TO RD.....	39	PANNING.....	19
AIRTITE TAKEOFFS SQ. TO RD.....	27	PIPE.....	11
ALUMINUM – COMPRESSED FLEXIBLE DUCT.....	43	PLASTER FRAME.....	29
ANGLE – ROUND.....	13	PLASTER FRAME ANGLE.....	19
BLACK PRODUCTS.....	44	PLENUMS – TOPS - PANELS.....	18
BOOT RAIL/CLIP.....	31	RAIN CAP.....	22
CAN STOCK.....	19	REDUCERS.....	23
CEILING BOXES/OUTLETS.....	29	REGISTER BOOTS.....	28-30
CLEATS.....	15	REGISTER OUTLETS.....	29
COLD AIR GROUND.....	19	RETURN AIR BOXES/BOOTS.....	18
DAMPER.....	22	RD. TO RD. - SQ. TO RD TAKEOFFS.....	26
DRAIN PAN.....	20	SADDLES – ADHESIVE.....	39
DRAWBAND.....	22	SADDLES – ROUND 45° & 90°.....	22
DUCT.....	14	SLEEVE CONNECTOR COLLAR FOR FLEX.....	22
DUCT FITTINGS.....	16-17	SPECIALTY PRODUCTS.....	44
DUCTBOARD PRODUCTS.....	41-42	SPIN-INS/ADHESIVES FOR METAL.....	39
ELBOW – ROUND.....	13	SPIN-INS FOR DUCTBOARD.....	42
FATBOY-CONDENSING UNIT TIEDOWN.....	18	STACKBOOT/FITTINGS.....	35-36
FILTER FRAMES.....	21	START COLLARS FOR DUCTBOARD.....	41
GASKET MATERIAL	20	START COLLARS FOR METAL.....	40
GRAY SEAL PIPE.....	12	TAKEOFFS – DUCTBOARD.....	42
HANGERS.....	15	TAKEOFFS – METAL.....	26-27
HEAT SHIELD.....	20	TEE COVER/CAP.....	22
INSULATED FIRE DAMPER BOXES/PLENUMS.....	34	TEES.....	24-25
INSULATED REGISTER BOXES.....	31-32	U CHANNEL.....	20
JOIST BLOCK	19	VENTING PRODUCTS.....	43
LINE COVER/CAP.....	19	WALLSTACK BOOTS.....	36
MOBILE HOME BOX.....	29	WALLSTACK FITTINGS.....	35-36
OVAL PIPE/FITTINGS.....	37-38	WYES.....	24-25

PART NUMBER INDEX

ITEM	DESCRIPTION	PG.	ITEM	DESCRIPTION	PG.
201/H-L	RD TO RD ADJ T/O	26	184	VOLUME DAMPER	16
8-185-DH	DUCT HANGER	15	187SET/SD	DUCT END CAP	16
10CS	CAN STOCK	19	189SB/SD/K	R/A SUPPORT BOX/KIT	18
80LSD	DUCT TRANS.	16	189FR-	FILTER FRAME	21
81CSD	DUCT TRANS.	16	190SD	DUCT REDUCER	16
82RSD	DUCT TRANS.	16	201	RD TO RD ADJ T/O	26
103	HORIZ. STACKHEAD	35	210SD/211SD	TRUNK ADPT/RDCR	17
104E	WALL STACKHEAD	36	300/300B	24" RD PIPE/36" RD PIPE	11
110R	STRAIGHT BOOT	28	301	60" RD PIPE	11
110RCP/RF	FRAMED/FLG'D BOOT	30	301120/P	120" RD PIPE	11
110S	WALL STACK BOOT	36	302	90° ELBOW	13
112R/RR/RL	END BOOT CTR./RT./LEFT	28	302DB	RD TO RD DB T/O	42
112RCP/RF	FRAMED/FLG'D BOOT	30	302E	ELBOW T/O	26
112S/R/L	WS BOOT CTR./RT./LEFT	36	303	45° ANGLE	13
113R	90° ELBOW BOOT	28	304/304L	STRT AIRFLOW/LAT TEE	24
113RCP/RF	FRAMED/FLG'D BOOT	30	305/305L	LATERAL TEE RDCR.	24
113S	WALL STACK BOOT	36	306/306L	AIRFLOW LAT WYE	24
117SET	WALL STACK END CAP	35	307/A/ECC	WYE-STD & ADJ	24
120	VERT. ELBOW/WS	35	309/310	TEE COVER/CAP	22
120SD	VERT. ELBOW	17	311/312/P/F/PF	TAPERED/PLAIN/FLAT RDCR	23
121	VERT. ANGLE/WS	35	313 ALL ITEMS	START COLLAR	40
121SD	VERT. ANGLE	17	314/314DQ	ROUND DAMPER	22
122	HORIZ. ELBOW/WS	35	316	DRAWBAND	22
122SD	HORIZ. ELBOW	17	317	RECT BLIND BOX	29
123	HORIZ. ANGLE/WS	35	318	REG PAN STRT BOOT	30
123SD	HORIZ. ANGLE	17	BRB ALL ITEMS	BASEMENT HEAD BOOT	29
124BL	WALL STACK	35	319	SQUARE BLIND BOX	29
125SD	RECT. DUCT	14	320	TOP CEILING BX FLG'D	29
141	WS START COLLAR	35	320T	DIFFUSER TOP OUTLET	29
141SD	DUCT START COLLAR	17	320S	DIFFUSER SIDE OUTLET	29
151SD	DUCT ST COL/OFFSET	17	322	SIDE CEILING BX FLG'D	29
153/153D	STRAIGHT SIDE T/O/DPR.	26	323	JOIST PANNING	19
161/161-RISE	SQ/RD TAKEOFF	26	324/S/IS	S-CLEAT/STANDING	15
161D	DOUBLE TAKEOFF	26	325SO	DPR. SECTION S/O	22
161FG/RISE	DB SQ/RD TAKEOFF	42	327	RAIN CAP	22
163 ALL ITEMS	SQ TO RD TAKEOFF	27	328	GALV. DRYER VH/TAIL	43
163FGTOSO	DB SQ/RD TAKEOFF S/O	42	329	GALV. FRESH AIR INTAKE	43
181	SQ TO RD ADJ TAKEOFF	26	331/331F	SQ/RD TRANS.	16
181FG	ADJ. DB TAKEOFF	42	333	JOIST BLOCK	19

PART NUMBER INDEX

Snap-Rite
Manufacturing, Inc.
A Gray Co.

ITEM	DESCRIPTION	PG.	ITEM	DESCRIPTION	PG.
3500	R4.2 INS. REG BOX	31-33	ADR-DCL-F	ACCESS DOOR	16
3600	R6/R8 INS. REG BOX	31-33	BOOTRAIL	BOOTRAIL/CLEAT	31
3700	R4.2 INS. FT REG BOX	32-33	CAF	COLD AIR FRAME	20
3800-3900	R6/R8 INS. FT REG BOX	32	CAF/D	COLD AIR FRAME DPR	20
400A/AD/ADSO	ADH RD/RD T/O	39	CAG	COLD AIR GROUND	19
400CM	METAL CONICLE S/I	39	CORNER	60" CORNER CLEAT	15
400D	DB SPIN FITTING	42	CRDA/A-H	CEILING FD BOX	34
400M	METAL SPIN-IN PLAIN	39	10CS	10' CAN STOCK	19
401ACSO	ADH CONICLE DPR. S/O	42	DP	NESTABLE DRAIN PAN	20
401CMD	METAL CONICLE DPR. S/I	39	DP-RAIL	DRAIN PAN W/RAIL	20
401D	DB SPIN FTG W/DPR	42	DRIVE	DRIVE CLEAT	15
401M	METAL SPIN-IN W/DPR	39	DS	HANGING DUCT STRAP	15
402D	DB SPIN FTG W/SCOOP	42	FBT	FATBOY	18
402M	METAL S/I W/SCOOP	39	FBTD	FATBOY 4 PACK	18
403D	DB SPIN FTG W/SC & DPR	42	FBTDB	FATBOY BULK	18
403M	MTL SPIN FTG W/SC & DPR	39	FBTDC	FATBOY CABLE KIT	18
404-D/404-D8	DB START COLLAR	41	FDP	FIRE DAMPER PLENUM	34
404-DCCL	DB DBLE CLICK SL COL.	41	GASKET	GASKET MATERIAL	20
404-DCCSL	DB DC SL ST COLLAR	41	GRV	GALV. ROOF VENT	43
404-R/CR	DB ST COLLAR RING	41	GRVD	GALV. ROOF VENT DPR	43
405D	DB ST COLLAR	41	GRVT	GALV. ROOF VENT TALL	43
405-DCC	DB DC START COLLAR	41	GRVXT	GALV. ROOF VENT XTALL	43
406A/AD/ADSO	ADH SADDLE T/O	39	HOSE	VINYL HOSE	43
500-O	60" OVAL PIPE	37	HS	HEAT SHIELD	20
501-O	100" OVAL PIPE	37	JAVELIN-185	JAVELIN	15
502-O	90° OVAL VERT ELB	38	LC	LINE COVER	19
502-OF	90° OVAL HORIZ ELB	38	LCCAP	LINE COVER CAP	19
503-O	45° OVAL VERT ANGLE	38	LC-CAP-A	LC W/ANGLED CAP	19
503-OF	45° OVAL HORIZ ANGLE	38	LJ	LINE JACK	20
504/504M	OVAL END BOOT	37	MHB	MOBILE HOME BOX	29
505/505M	OVAL ANGLE BOOT	37	NP	NAIL PLATE	20
506-O	OVAL STRAIGHT BOOT	37	PANEL	PLENUM SIDES	18
507-O/507-OD	OVAL STACKHEAD/DBL.	38	PF	PLASTER FRAME	29
508-O	STRT SQ/OV BOOT	38	PFA	PLASTER FRAME ANGLE	19
509-O	45° ANGLE SQ/OV BOOT	38	PLENUM	CUST. PLENUM	18
510-O	90° HORIZ SQ/OV BOOT	38	SADDLE	SADDLE	22
513	OVAL ST COLLAR	38	SCC	SLEEVE CONN. COLLAR	22
514-O	OV/OV REVERSE BOOT	37	TOP	PLENUM TOP	18
801/C	COMPRSD. ALUM DUCT	43	UC	U-CHANNEL	20
807	ALUM DRYER VH	43	WHAB	WD MOUTH DRY'R VH/TL	43
AHS	AIR HANDLER STAND	19	WLAB	FLSH MT PL DRY'R VH/TL	43

Round Pipe

No. 300 24" Round Pipe																
Item	Bdl	Ctn	Lse	3"	4"	5"	6"	7"	8"	9"	10"	12"	14"	16"	18"	20"
30ga.	X			10	10	10	10	10	10	10	10	10	*	*	*	*
30ga.		X		25	25	25	25	10	10	*	*	*	*	*	*	*
28ga.	X			10	10	10	10	10	10	10	10	10	10	*	*	*
28ga.		X		25	25	10	10	10	10	*	*	*	*	*	*	*
26ga.	X			5	5	5	10	10	10	5	5	5	5	5	5	5
26ga.		X		10	10	10	10	10	10	*	*	*	*	*	*	*
24ga.	X			*	*	5	10	10	5	5	5	5	5	5	5	5

No. 300B 36" Round Pipe								
Item	Bdl	Ctn	Lse	12"	14"	16"	18"	20"
28ga.	X			10	10	10	10	10
26ga.	X			10	10	10	10	10

No. 300D 48" Round Pipe								
Item	Bdl	Ctn	Lse	12"	14"	16"	18"	20"
28ga.	X			*	*	5	5	5
26ga.	X			*	*	5	5	5
24ga.	X			*	*	5	5	5

No. 301 60" Round Pipe																
Item	Bdl	Ctn	Lse	3"	4"	5"	6"	7"	8"	9"	10"	12"	14"	16"	18"	20"
30ga.	X			10	10	10	10	10	10	10	10	10	*	*	*	*
30ga.		X		10	10	10	10	10	10	*	*	*	*	*	*	*
28ga.	X			10	10	10	10	10	10	10	5	5	5	*	*	*
28ga.		X		10	10	10	10	10	10	*	*	*	*	*	*	*
26ga.	X			5	5	5	10	10	10	5	5	5	5	5	5	5
26ga.		X		10	10	10	10	10	10	*	*	*	*	*	*	*
24ga.	X			*	*	5	5	5	5	5	5	5	5	5	5	5

No. 301120 120" Round Pipe									
Item	Bdl	Ctn	Lse	3"	4"	5"	6"	7"	8"
30ga.	X			5	5	5	5	5	5
26ga.	X			5	5	5	5	5	5

No. 301120P Rigid Vent Pipe					
Item	Bdl	Ctn	Lse	3"	4"
30ga.	X			100'	100'
28ga.	X			100'	100'
26ga.	X			100'	100'

900' per crate.



Round Pipe
 24" long-300
 36" long-300B
 48" long-300D
 60" long-301
 120" long-301120



No.301120P
Rigid Vent Pipe
 pre-snapped

* = Contact Customer Service for quantities and availability.

Other sizes available. Specify beaded or unbeaded

Elbows & Angles

No. 302 90° Elbow																
Item	Bdl	Ctn	Lse	3"	4"	5"	6"	7"	8"	9"	10"	12"	14"	16"	18"	20"
30ga.		X		12	12	12	12	12	12	*	*	*	*	*	*	*
28ga.		X		12	12	12	12	12	12	*	*	*	*	*	*	*
28ga.	X			*	*	*	*	*	*	4	4	4	4	*	*	*
26ga.		X		12	12	12	12	12	12	*	*	*	*	*	*	*
26ga.	X			*	*	*	*	*	*	4	4	4	4	4	*	*
26ga.			X	*	*	*	*	*	*	*	*	*	*	*	A/O	A/O
24ga.		X		*	*	12	12	12	12	*	*	*	*	*	*	*
24ga.	X			*	*	*	*	*	*	4	4	4	4	4	*	*
24ga.			X	*	*	*	*	*	*	*	*	*	*	*	A/O	A/O



**No.302
 90° Elbow**

No. 302ST Straight Elbow																
Item	Bdl	Ctn	Lse	3"	4"	5"	6"	7"	8"	9"	10"	12"	14"	16"	18"	20"
30ga.		X		12	12	12	12	12	12	*	*	*	*	*	*	*
28ga.		X		12	12	12	12	12	12	*	*	*	*	*	*	*
28ga.	X			*	*	*	*	*	*	4	4	4	4	*	*	*
26ga.		X		12	12	12	12	12	12	*	*	*	*	*	*	*
26ga.	X			*	*	*	*	*	*	4	4	4	4	4	*	*
26ga.			X	*	*	*	*	*	*	*	*	*	*	*	A/O	A/O
24ga.		X		*	*	12	12	12	12	*	*	*	*	*	*	*
24ga.	X			*	*	*	*	*	*	4	4	4	4	4	*	*
24ga.			X	*	*	*	*	*	*	*	*	*	*	*	A/O	A/O



**No.302ST
 Straight Elbow**

No. 303 45° Angle																
Item	Bdl	Ctn	Lse	3"	4"	5"	6"	7"	8"	9"	10"	12"	14"	16"	18"	20"
30ga.		X		12	12	12	12	12	12	*	*	*	*	*	*	*
28ga.		X		12	12	12	12	12	12	8	8	6	A/O	*	*	*
26ga.		X		12	12	12	12	12	12	8	8	6	A/O	*	*	*
26ga.			X	*	*	*	*	*	*	*	*	*	*	A/O	A/O	A/O
24ga.		X		*	*	12	12	12	12	8	8	6	A/O	*	*	*
24ga.			X	*	*	*	*	*	*	*	*	*	*	A/O	A/O	A/O



**No.303
 45° Angle**

* = Contact Customer Service for quantities and availability.

A/O=Amount Ordered

Rectangular Duct

Snap-Rite
Manufacturing, Inc.
A Gray Co.

* = Contact Customer Service for quantities and availability.



assembled

No.125SD 48" and 60" Rectangular Duct			
Size	Carton	TLS	Rack
8x8	5	50	150
10x8	5	50	150
12x8	5	50	150
14x8	5	50	130
16x8	5	50	100
18x8	5	30	100
20x8	5	30	100
22x8	5	30	90
24x8	5	30	90
26x8	*	30	90
28x8	*	30	80
30x8	*	30	80

No.125SD
Rectangular Duct
48", 60", 96" lengths

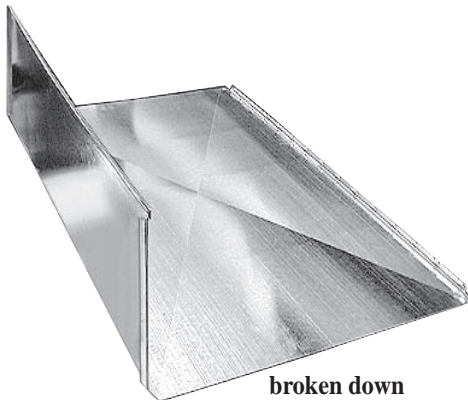

broken down

No.125SD 96" Rectangular Duct			
Size	Carton	TLS	Rack
8x8	*	50	150
10x8	*	50	150
12x8	*	50	150
14x8	*	50	130
16x8	*	50	100
18x8	*	30	100
20x8	*	30	100
22x8	*	30	90
24x8	*	30	90
26x8	*	30	90
28x8	*	30	80
30x8	*	30	80

Each joint includes 2 Drive Cleats and 2 S-Cleats

Crossbroken and Parallel Bead available. Other lengths and sizes available.



Drive Cleat



S-Cleat

Duct Accessories

No.324 S-Cleat																		
Item	Bdl	Ctn	Lse	8"	10"	12"	14"	16"	18"	20"	22"	24"	26"	28"	30"	60"	96"	120"
all		X		100	100	100	100	100	100	100	100	100	100	*	*	*	*	*
all	X			*	*	*	*	*	*	*	*	*	*	10	10	10	10	10

Other lengths available.

No.324S/1S Standing S-Cleat					
Item	Bdl	Ctn	Lse	60"	120"
1"	X			10	10
1/2"	X			10	10



No.324 S-Cleat

No.DRIVE Drive Cleat

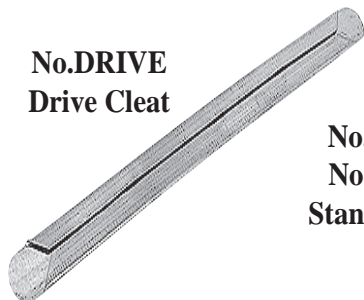

No.324-1S 1"
No.324S 1/2"
Standing S-Cleat

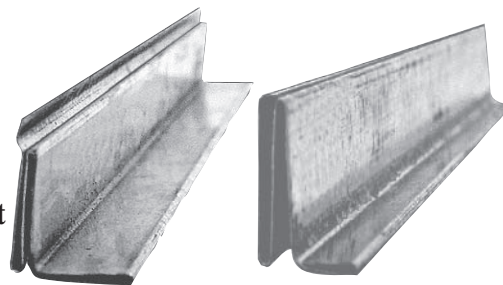

No.Corner 60" Corner Cleat

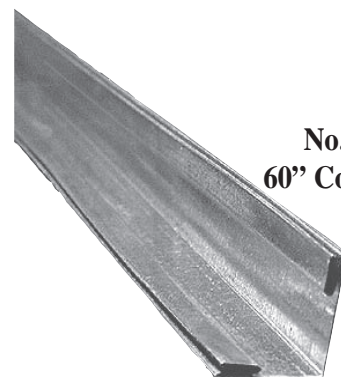

No.DRIVE Drive Cleat												
Item	Bdl	Ctn	Lse	8"	10"	12"	14"	24"	26"	60"	96"	120"
all		X		100	100	100	100	100	*	*	*	*
all	X			*	*	*	*	*	10	10	10	10

No.Corner- 60" Corner Cleat				
Item	Bdl	Ctn	Lse	Corner
all	X			10

No.DS Duct Hanging Strap						
Item	Bdl	Ctn	Lse	1"	1 1/2"	2"
22ga.	X			A/O	A/O	A/O
26ga.	X			A/O	A/O	A/O
30ga.	X			A/O	A/O	A/O

Specify 100' or 200'

No.8-185-DH Duct Hanger				
Item	Bdl	Ctn	Lse	8-185-DH
all		X		100

No.JAVELIN-185 Javelin				
Item	Bdl	Ctn	Lse	JAVELIN
all		X		250

* = Contact Customer Service for quantities and availability.

A/O=Amount Ordered

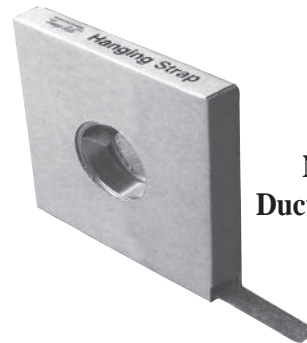

No.DS Duct Hanging Strap

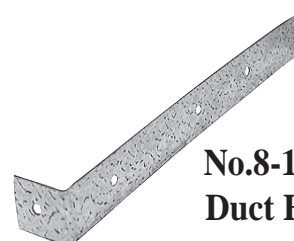

No.8-185-DH Duct Hanger



No.JAVELIN-185 Javelin

Duct Accessories

Snap-Rite
Manufacturing, Inc.
A Gray Co.

A/O=Amount Ordered



81CSD

No.82RSD right
No.81CSD center
No.80LSD left
Duct Transition

No.82RSD/81CSD/80LSD Duct Transition															
Item	Bdl	Ctn	Lse	8x8	10x8	12x8	14x8	16x8	18x8	20x8	22x8	24x8	26x8	28x8	30x8
all			X	A/O	A/O	A/O	A/O	A/O	A/O	A/O	A/O	A/O	A/O	A/O	A/O

No.184 Volume Damper															
Item	Bdl	Ctn	Lse	8x8	10x8	12x8	14x8	16x8	18x8	20x8	22x8	24x8	26x8	28x8	30x8
all			X	12	12	12	12	12	12	12	12	12	12	12	12

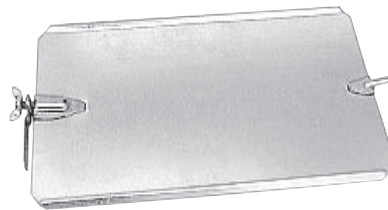

No.184
Volume Damper



No.187SETSD
Duct End Cap

No.187SETSD Duct End Cap															
Item	Bdl	Ctn	Lse	8x8	10x8	12x8	14x8	16x8	18x8	20x8	22x8	24x8	26x8	28x8	30x8
all			X	12	12	12	12	12	12	12	12	12	12	12	12

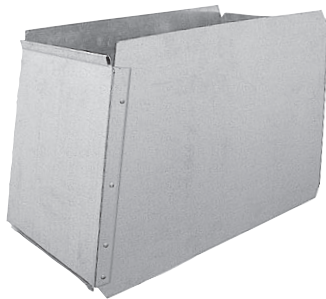

No.190SD
Duct Reducer

No.190SD Duct Reducer															
Item	Bdl	Ctn	Lse	8x8	10x8	12x8	14x8	16x8	18x8	20x8	22x8	24x8	26x8	28x8	30x8
all			X	A/O	A/O	A/O	A/O	A/O	A/O	A/O	A/O	A/O	A/O	A/O	A/O



331

No.331 plain
No.331F w/flange
Sq. to Rd. Transition



331F

No.331/331F Square to Round Transition															
Item	Bdl	Ctn	Lse	CUSTOM TRANSITION											
all			X	Transitions are a custom item and are sized to order											



No.ADR-DCL-F
Access Door

No.ADR-DCL-F Access Door															
Item	Bdl	Ctn	Lse	Description											
all			X	A/O											

Duct Accessories

No.141SD Duct Start Collar

Item	Bdl	Ctn	Lse	8x8	10x8	12x8	14x8	16x8	18x8	20x8	22x8	24x8	26x8	28x8	30x8
all			X	A/O	A/O	A/O	A/O	A/O	A/O	A/O	A/O	A/O	A/O	A/O	A/O



No.141SD
 Duct Start Collar

No.151SD Offset Duct Start Collar

Item	Bdl	Ctn	Lse	8x8	10x8	12x8	14x8	16x8	18x8	20x8	22x8	24x8	26x8	28x8	30x8
all			X	A/O	A/O	A/O	A/O	A/O	A/O	A/O	A/O	A/O	A/O	A/O	A/O

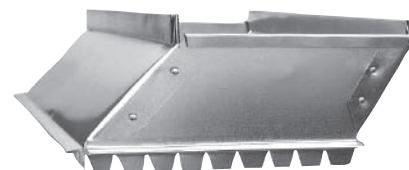

No.151SD
 Offset Duct
 Start Collar

No.210SD/211SD Trunk Adapter/Reducer

Item	Bdl	Ctn	Lse	2"	4"	6"	8"	10"	12"
all	X			12	12	12	12	12	12



No.123SD 45°
 No.122SD 90°
 Horizontal Angle/Elbow

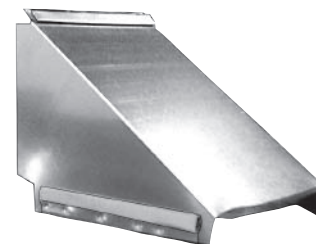
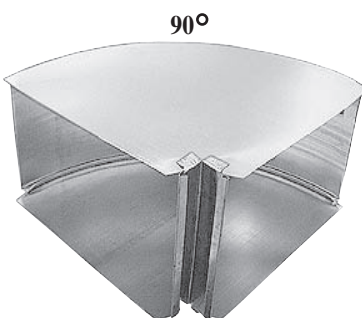

No.210SD
 Trunk Adapter

No.123SD/122SD Horizontal Angle/Elbow

Item	Bdl	Ctn	Lse	8x8	10x8	12x8	14x8	16x8	18x8	20x8	22x8	24x8	26x8	28x8	30x8
all			X	A/O	A/O	A/O	A/O	A/O	A/O	A/O	A/O	A/O	A/O	A/O	A/O



No.121SD 45°
 No.120SD 90°
 Vertical Angle/Elbow

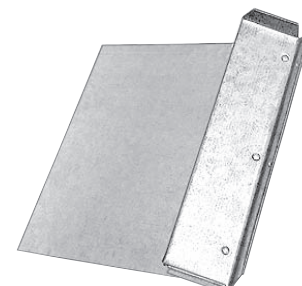
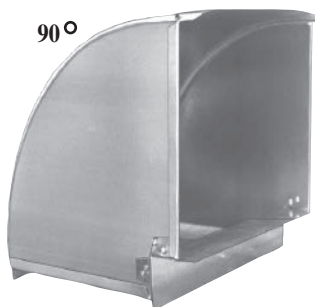

No.211SD
 Trunk Reducer

No.121SD/120SD Vertical Angle/Elbow

Item	Bdl	Ctn	Lse	8x8	10x8	12x8	14x8	16x8	18x8	20x8	22x8	24x8	26x8	28x8	30x8
all			X	A/O	A/O	A/O	A/O	A/O	A/O	A/O	A/O	A/O	A/O	A/O	A/O

Other sizes available. A/O=Amount Ordered

Accessories

Snap-Rite
Manufacturing, Inc.
A Gray Co.

A/O=Amount Ordered

				No.189SB/R/RD Return Air Support Box	
Item	Bdl	Ctn	Lse	30x28-8x24	38x28-10x25
all			X	A/O	A/O

No.189SD/SD1/SDR/SDK/SK1/SKR Return Air Boot/Kit									
Item	Bdl	Ctn	Lse	8x20-14x20	8x24-14x24	10x20-14x20	10x20-16x20	10x25-14x25	10x25-16x25
all			X	A/O	A/O	A/O	A/O	A/O	A/O

Kit Includes: 2-32" jts. of duct, boot, 6 slips, 6 drives, start collar.
Kits don't include filter.



SBRD



SB

No.189SB
No.189SB-R w/rack
No.189SB-RD w/rack & drawer
Return Air Support Box

No.189SD boot
No.189SD1 bt w/rack
No.189SDR dbl side load
No.189SDK kit
No.189SK1 kit w/rack
No.189SKR dbl side load kit
Return Air Boot & Kit
available w/wo tabs

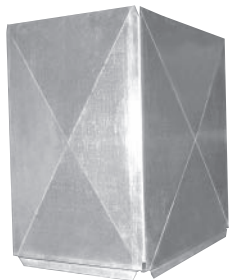
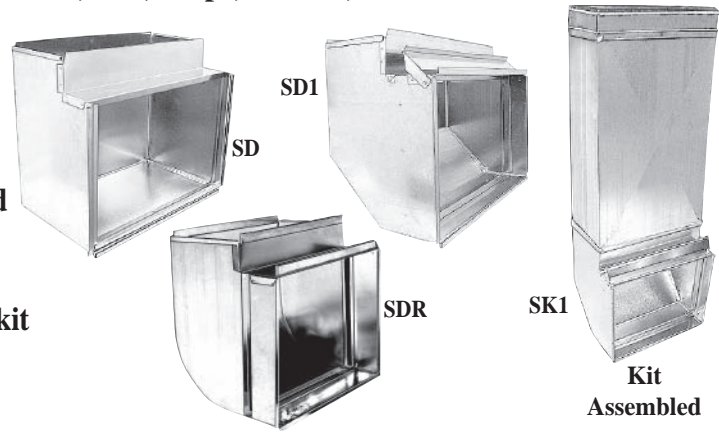

PLENUM

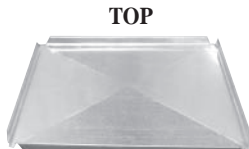

TOP

No.PLENUM
No.TOP top
No.PANEL side
Custom Plenum

				No.PLENUM Customized Plenum					
Item	Bdl	Ctn	Lse	CUSTOM PLENUM					
all				Plenums are a specialty item and are sized to order					

Available w/wo Liner(insulation). *Contact Customer Service for available sizes.

No.TOP Plenum Top										
Item	Bdl	Ctn	Lse	16x16	18x18	20x20	22x22	24x24	26x26	30x30
all	X			3	3	3	3	3	3	3

No.PANEL Plenum Side										
Item	Bdl	Ctn	Lse	16"	18"	20"	22"	24"	26"	30"
36"	X			4	4	4	4	4	4	4
48"	X			4	4	4	4	4	4	4

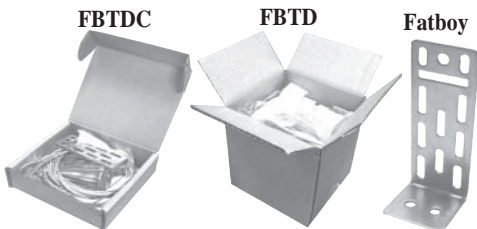

No.FBTD 4pack
No.FBTDB Bulk
No.FBTDC Cable Kit
Fatboy

				No.FBTD/FBTDB/FBTDC Fatboy/Cable Kit			
Item	Blk	Ctn	Lse	Description			
TD		X		4pcs/pack		25packs/box	
TDB	X			bulk packed by weight		100pcs. total	

(TDC)Kits include: Cable, 4 Fatboys, 4 tapcon screws, instructions.

Accessories

No.323 Joist Panning

Item	Bdl	Ctn	Lse	16½"x30"	16½"x36"	33"x30"	33"x36"
all	X			20	20	10	10
all		X		25	*	10	*

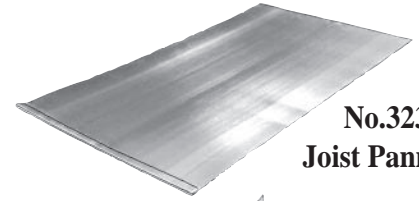

No.323
Joist Panning

No.PFA Plaster Frame Angle

Item	Bdl	Ctn	Lse	1x3x96"	1x3x120"	1½x1½x96"	1½x1½x96"	1½x1½x120"	1½x3x120"	2x2x60"	2x2x96"
all	X			50	50	50	50	50	50	20	20



No.PFA
Plaster Frame
Angle

No.333 Joist Block

Item	Bdl	Ctn	Lse	16"x10"	16"x12"	16"x14"
all	X			20	20	20

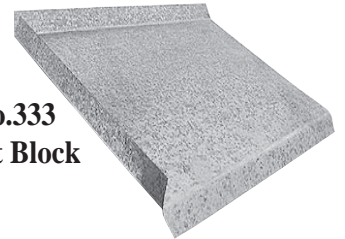

No.333
Joist Block

No.10CS Can Stock

Item	Bdl	Ctn	Lse	2 x 1½ x 10'	2x2x10'	2 x 2½ x 10'
all		X		25	25	25



No.10CS
Can Stock

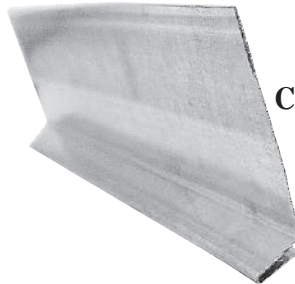

No.CAG
Cold Air Ground

No.CAG Cold Air Ground

Item	Bdl	Ctn	Lse	60"	96"
all	X			20	20



No.LC
Line Cover
No.LCCAP
Reg. Line Cover
Cap

No.LC Line Cover

Item	Bdl	Ctn	Lse	3x3x3	3x4x3	4x4x4	4x5x4	5x5x5	6x6x6
8ft.	X			10	10	10	10	10	10
10ft.	X			10	10	10	10	10	10

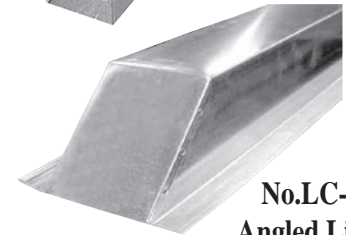

No.LC-CAP-A
Angled Line Cover
w/Cap
specify 8' or 10'

No.LCCAP Line Cover Cap

Item	Bdl	Ctn	Lse	3"	4"
all			X	A/O	A/O

No.LC-CAP-A Angled Line Cover w/Cap

Item	Bdl	Ctn	Lse	Sizes
8ft.	X			4"x 4"x 4"x 8'
10ft.	X			4"x 4"x 4"x 10'



No.AHS
18", 24", 36" adjustable
Air Handler Stand

No.AHS Air Handler Stand

Item	Bdl	Ctn	Lse	18", 24", 36" adjustable
all		X		1

* = Contact Customer Service for quantities and availability. A/O=Amount Ordered

Accessories

Snap-Rite
Manufacturing, Inc.
A Gray Co.

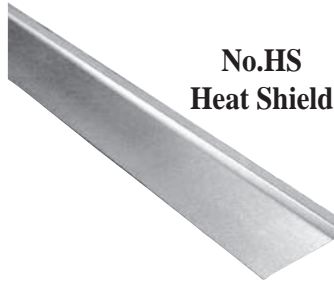

No.HS
Heat Shield

No.HS Heat Shield				
Item	Bdl	Ctn	Lse	
				6x1/2x96"
all	X			25
				6x3/4x96"
				25
				6x1 1/2x96"
				25



No.UC
U-Channel

No.UC U-Channel				
Item	Bdl	Ctn	Lse	
				1x1x1-60"
22ga.	X			50
26ga.	X			50
				1x2x1-120"
				50
				1x3x1-120"
				*
				10

No.Gasket				
Item	Bdl	Ctn	Lse	
				1/2"x 100'
all		X		A/O

No.GASKET
Adhesive Gasket
Material

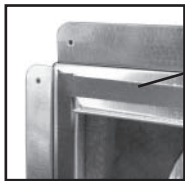

Gasket
shown
installed



No.CAF/D Cold Air Frame													
Item	Bdl	Ctn	Lse	6x10	6x12	6x14	6x24	6x30	8x10	8x12	8x14	8x24	8x30
all		X		25	25	25	*	*	25	25	25	*	*
all	X			*	*	*	25	25	*	*	*	25	25



No.CAF standard
No.CAFD w/damper
Cold Air Frame



No.DP
Nestable Drain Pan
(Patent# 7,523,854)

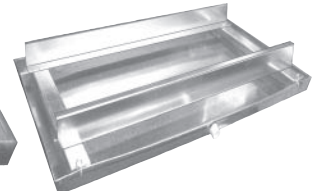

No.DP-RAIL
Drain Pan
w/Rails

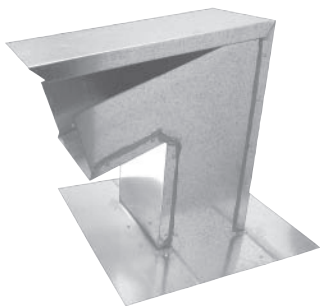

No.LJ
Line Jack

No.DP Nestable/DP-RAIL Drain Pan w/Rails				
Item	Bdl	Ctn	Lse	
				Drain Pan
all			X	Various sizes and gauges available

All pans come with drain outlet. Rails suspend Air Handler unit

No.LJ Line Jack					
Item	Bdl	Ctn	Lse	5"	6"
				7"	8"
				10"	
all			X	A/O	A/O
				A/O	A/O
				A/O	A/O

All 26 gauge. Size in inches represents the top opening



No.NP
Nail Plate

No.NP Nail Plate				
Item	Bdl	Ctn	Lse	Description
NP	X			Various sizes and gauges available

* = Contact Customer Service for quantities and availability. A/O=Amount Ordered

Accessories

No.189FR Filter Frame									
Item	Bdl	Ctn	Lse	14x20	14x25	16x20	16x25	20x20	20x25
FR		X		10	10	10	10	10	10
FRF		X		*	*	10	10	*	10
FRA		X		*	*	10	*	*	*
FROF		X		*	*	10	*	*	*
FRT		X		*	10	*	*	*	*
FRTAB		X		10	10	10	10	*	*
FRTABD		X		*	10	10	10	10	10
FRDTABD		X		10	*	10	10	*	*
FRC		X		*	10	*	10	*	10
FR-4W		X		*	*	*	10	*	10
FR-4WD		X		*	*	10	10	*	10
FR-4WT		X		*	*	*	10	*	10
FR-4TD		X		*	*	*	10	*	10

- = top load
- = side load dbl. flange
- = adjustable
- = open side w/flange
- = side load
- = w/tabs
- = w/tabs & door
- = dbl. tabs w/door
- = w/cover
- = 4" wide
- = 4" wide w/door
- = 4" wide w/tabs
- = 4" wide w/tabs & door

* = Contact Customer Service for quantities and availability.
 Custom Sizes Available.



No.189FRT
 Filter Frame
 Side Load



No.189FR
 Filter Frame
 Top Load

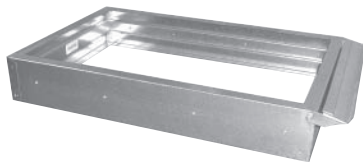

No.189FR-4WD
 4" wide Filter Frame
 w/door

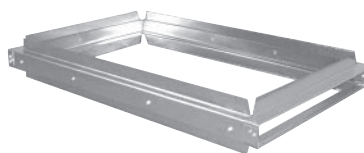

No.189FRF
 Filter Frame
 w/double flange

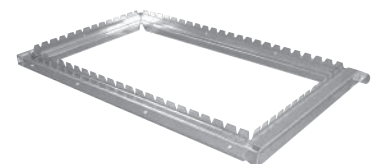

No.189FRTABD
 Filter Frame
 w/tabs & door

Dampers, Drawbands, Tee Covers, Rain Caps, Saddles, Sleeve Conn.

Snap-Rite
Manufacturing, Inc.
A Gray Co.



**No.314
No.314DQ
Round Damper
Single/Double Quad**

No.314/314DQ Round Damper																
Item	Bdl	Ctn	Lse	3"	4"	5"	6"	7"	8"	9"	10"	12"	14"	16"	18"	20"
sing.		X		50	50	50	50	50	50	*	*	*	*	*	*	*
dbl.		X		50	50	50	50	50	50	25	50	50	25	25	25	25



**No.325SO
Damper Section
w/standoff dpr.**

No.325SO Damper Section w/Standoff Dpr.															
Item	Bdl	Ctn	Lse	Description											
all		X		A/O											

No.SADDLE Saddle														
Item	Bdl	Ctn	Lse	3"	4"	5"	6"	7"	8"	9"	10"	12"	14"	16"
45°		X		12	12	12	12	12	10	10	8	8	4	1
90°		X		12	12	12	12	12	12	12	8	8	4	1

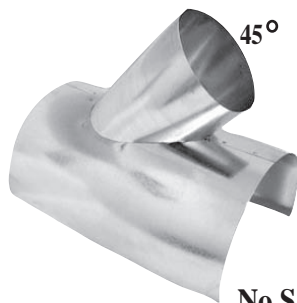

**No.SADDLE-45°
No.SADDLE-90°
Saddle**

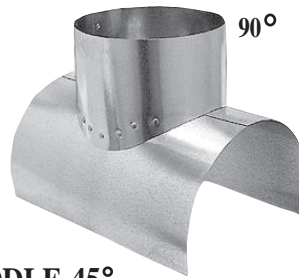

**No.316
Drawband**



**No.327
Rain Cap**

No.316 Drawband											
Item	Bdl	Ctn	Lse	4"	5"	6"	7"	8"	10"	12"	14"
all		X		12	12	12	12	12	12	12	12



**No.310 no crimp
No.309 crimp
Tee Cover/Cap**

No.327 Rain Cap																
Item	Bdl	Ctn	Lse	3"	4"	5"	6"	7"	8"	9"	10"	12"	14"	16"	18"	20"
all		X		12	12	12	12	12	12	6	6	6	A/O	A/O	A/O	A/O

No.310/309 Tee Cover/Cap																
Item	Bdl	Ctn	Lse	3"	4"	5"	6"	7"	8"	9"	10"	12"	14"	16"	18"	20"
all		X		12	12	12	12	12	12	12	12	12	12	10	10	10



**No.SCC
Sleeve Connector Collar**

No.SCC Sleeve Connector Collar															
Item	Bdl	Ctn	Lse	4"	5"	6"	7"	8"	9"	10"	12"	14"	16"	18"	20"
all		X		50	40	40	30	25	25	25	25	10	10	10	10

* = Contact Customer Service for quantities and availability. A/O=Amount Ordered

Reducers

Tapered and Shortway Reducers

Item	Bdl	Ctn	Lse	ALL
4x3		X		12
5x3		X		12
5x4		X		12
6x3		X		12
6x4		X		12
6x5		X		12
7x3		X		12
7x4		X		12
7x5		X		12
7x6		X		12
8x3		X		12
8x4		X		12
8x5		X		12
8x6		X		12
8x7		X		12
9x6		X		12
9x7		X		12
9x8		X		12
10x5		X		12
10x6		X		12
10x7		X		12
10x8		X		12
10x9		X		12
12x6		X		12
12x7		X		12
12x8		X		12
12x9		X		6
12x10		X		12
14x8		X		6
14x10		X		6
14x12		X		12
16x10		X		6
16x12		X		12
16x14		X		12
18x10		X		4
18x12		X		4
18x14		X		4
18x16		X		4
20x10		X		4
20x16		X		4
20x18		X		4



311



311P



312

No.311 crimp small
 No.311P no crimp
 No.312 crimp large
 Tapered Reducer



311F

No.311F crimp small
 No.311PF no crimp
 No.312F crimp large
 Shortway Reducer
 Flat

Wyes & Tees

Snap-Rite
Manufacturing, Inc.
A Gray Co.



No.304 straight
No.305 reducer
Air Flow Tee



No.304L straight
No.305L reducer
Lateral Tee



No.306L
Lateral Wye



No.306
Air Flow Wye

Please denote at end of part#: BC=crimp 2 small ends, NC=no crimp, blank=crimp large end

No.304/305/306/307 Wyes and Tees								
Item	Bdl	Ctn	Lse	304/305	304L/305L	306	306L	307/A
3x3x3		X		12	12	12	*	*
4x3x3		X		12	12	12	12	12
4x4x3		X		12	12	12	12	*
4x4x4		X		12	12	12	12	12
5x3x3		X		*	*	12	12	*
5x4x3		X		*	*	12	12	*
5x4x4		X		12	12	12	12	*
5x5x3		X		12	12	12	12	*
5x5x4		X		12	12	*	12	*
5x5x5		X		12	12	12	12	12
6x4x3		X		*	*	12	12	*
6x4x4		X		*	*	12	12	12
6x5x3		X		*	*	12	12	*
6x5x4		X		*	*	12	12	*
6x5x5		X		*	*	12	12	12
6x6x3		X		12	12	12	12	*
6x6x4		X		12	12	12	12	*
6x6x5		X		12	12	12	12	*
6x6x6		X		12	12	12	12	12
7x4x3		X		*	*	12	12	*
7x5x3		X		12	12	12	12	*
7x5x4		X		*	*	12	12	*
7x5x5		X		*	*	12	12	12
7x6x3		X		12	12	12	12	*
7x6x4		X		*	12	12	12	*
7x6x5		X		*	*	12	12	*
7x6x6		X		12	12	12	12	12
7x7x3		X		12	12	*	12	*
7x7x4		X		*	*	12	12	*
7x7x6		X		12	12	12	12	*
7x7x7		X		12	12	12	12	*

Other Sizes Available.

* = Contact Customer Service for quantities and availability.

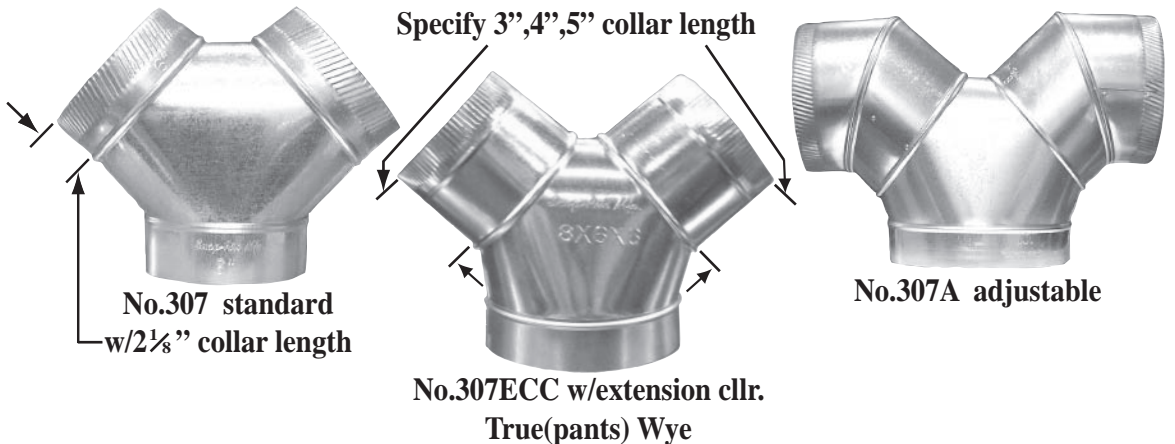

Wyes & Tees

Please denote at end of part#: BC=crimp 2 small ends, NC=no crimp, blank=crimp large end

No.304/305/306/307 Wyes and Tees								
Item	Bdl	Ctn	Lse	304/305	304L/305L	306	306L	307/A
8x6x5		X		*	*	12	*	*
8x6x6		X		12	12	10	10	12
8x7x4		X		*	*	10	10	*
8x7x6		X		*	*	8	10	*
8x7x7		X		*	*	8	10	*
8x8x6		X		12	12	8	8	*
8x8x8		X		10	10	*	10	*
9x7x7		X		*	*	6	6	6
9x8x6		X		*	*	8	*	*
9x9x9		X		4	4	*	*	*
10x8x8		X		*	*	5	5	6
10x10x6		X		5	5	5	*	*
10x10x8		X		5	5	*	*	*
10x10x10		X		5	5	3	*	6
12x8x8		X		*	*	2	2	6
12x10x10		X		*	*	2	2	2
12x12x8		X		3	2	*	*	*
12x12x10		X		3	2	*	*	2
12x12x12		X		3	2	*	*	2
14x14x8		X		2	2	*	*	*
14x12x12		X		*	*	*	*	2
14x14x12		X		2	2	*	*	*
14x14x14		X		2	2	*	*	*
16x10x10		X		*	*	*	*	*
16x16x8		X		A/O	A/O	*	*	*
16x16x16		X		A/O	A/O	*	*	*
18x18x18		X		A/O	A/O	*	*	*
20x20x20		X		A/O	A/O	*	*	*

Other Sizes Available.

* = Contact Customer Service for quantities and availability.
 A/O=Amount Ordered



No.304 straight
 No.305 reducer
 Air Flow Tee



No.304L straight
 No.305L reducer
 Lateral Tee



No.306L
 Lateral Wye

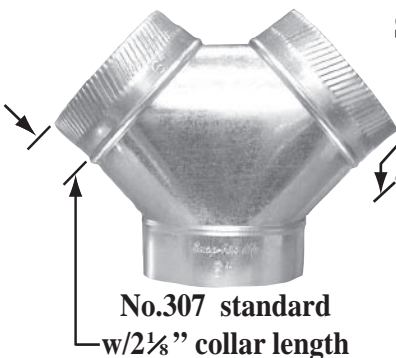

No.307 standard
 w/2 1/8" collar length



No.307ECC w/extension cllr.
 True(pants) Wye



No.307A adjustable



No.306
 Air Flow Wye

Takeoffs

Snap-Rite
Manufacturing, Inc.
A Gray Co.

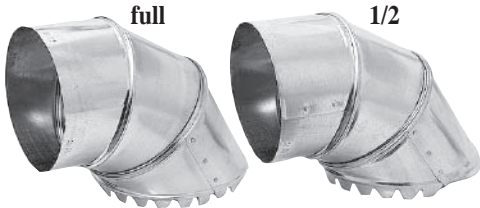

No.201H 1/2 tab
No.201 full tab
Rd to Rd Adj Takeoff

No.201/H Round to Round Adjustable Takeoff w/tabs							
Item	Bdl	Ctn	Lse	5"	6"	7"	8"
1/2		X		12	12	12	*
full		X		12	12	12	12



No.201L
Rd to Rd Adj
Takeoff Long

No.201L Round to Round Adjustable Takeoff Long							
Item	Bdl	Ctn	Lse	201L			
all		X		*			

No.302E Elbow Takeoff							
Item	Bdl	Ctn	Lse	4"	5"	6"	7"
all		X		12	12	12	12

No.153/153D Straight Side Takeoff													
Item	Bdl	Ctn	Lse	4"	5"	6"	7"	8"	9"	10"	12"	14"	16"
all		X		12	12	12	12	12	12	12	12	12	12



No.302E
Elbow Takeoff



No.153 plain
No.153D w/dpr.
Straight Side Takeoff



No.201A
Rd to Rd
Adhesive Takeoff

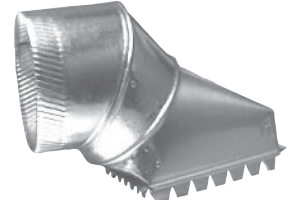

No.181
Sq to Rd Adj
Takeoff

No.181 Square to Round Adjustable Takeoff											
Item	Bdl	Ctn	Lse	4"	5"	6"	7"	8"	9"	10"	12"
all		X		12	12	12	12	12	12	12	6

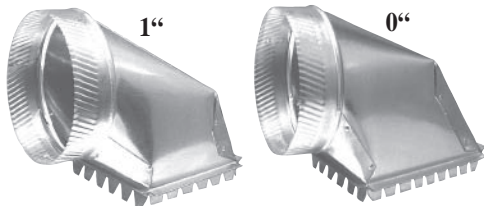

No.161 1"rise
No.161-RISE 0"rise
Sq to Rd Takeoff

No.201A Round to Round Adhesive Takeoff											
Item	Bdl	Ctn	Lse	4"	5"	6"	7"	8"	9"	10"	12"
all		X		12	12	12	12	12	12	12	6

No.161/161-RISE Square to Round Takeoff											
Item	Bdl	Ctn	Lse	4"	5"	6"	7"	8"	10"	12"	14"
0"		X		*	12	12	12	12	*	*	*
1"		X		12	12	12	12	12	6	3	2



No.161D
Double Takeoff

No.161D Double Takeoff							
Item	Bdl	Ctn	Lse	6"			
all		X		12			

* = Contact Customer Service for quantities and availability.

Takeoffs

No.163 Square to Round Takeoff

Item	Bdl	Ctn	Lse	5"	6"	7"	8"	9"	10"	12"	14"
all		X		*	*	*	*	*	*	*	*

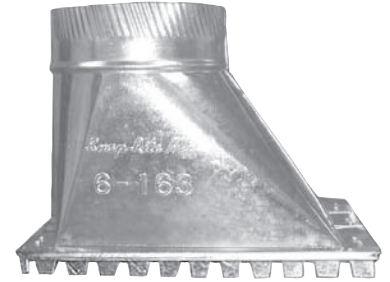

No.163
 Sq. to Rd. Takeoff

No.163TOSO Square to Round Takeoff-Standoff Dpr.

Item	Bdl	Ctn	Lse	5"	6"	7"	8"	9"	10"	12"	14"
all		X		*	*	*	*	*	*	*	*

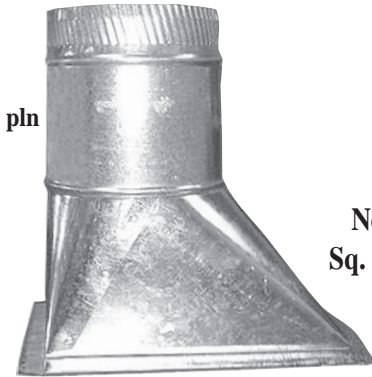

No.163A plain
No.163AD w/damper
 Sq. to Rd. Airtite Takeoff

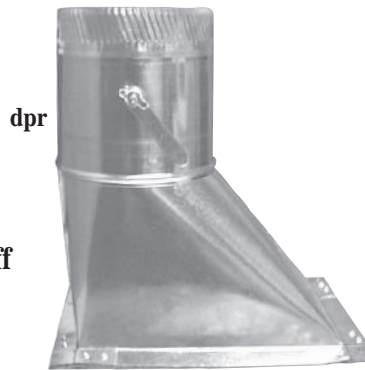

No.163TOSO
 Sq. to Rd. Takeoff
 w/standoff damper

No.163A/AD Square to Round Airtite Takeoff

Item	Bdl	Ctn	Lse	5"	6"	7"	8"	9"	10"	12"	14"
pln		X		*	*	*	*	*	*	*	*
AD		X		*	*	*	*	*	*	*	*

No.163ADSO Square to Round Airtite Takeoff

Item	Bdl	Ctn	Lse	5"	6"	7"	8"	9"	10"	12"	14"
all		X		*	*	*	*	*	*	*	*

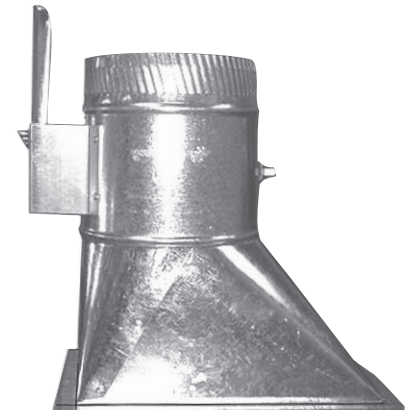

No.163ADSO
 Sq. to Rd. Airtite Takeoff
 w/standoff damper

* = Contact Customer Service for quantities and availability.

Register Boots

Snap-Rite
Manufacturing, Inc.
A Gray Co.



No.110R
Straight Boot

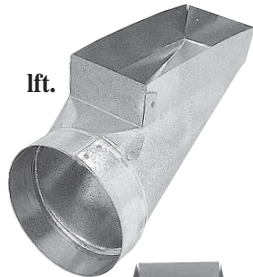

lft.



ctr.

No.112RR right
No.112R center
No.112RL left
End Boot

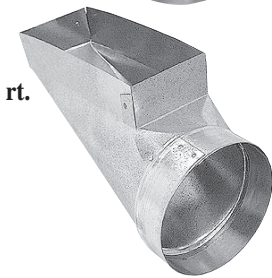

rt.

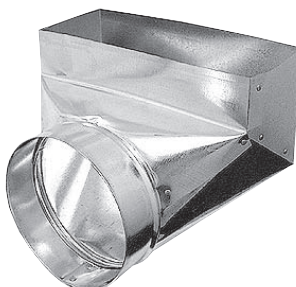

No.113R
Elbow Boot 90°

No.110R/112R/113R Boots								
Item	Bdl	Ctn	Lse	110R	112R	113R	112RR	112RL
10x2 1/2x4		X		12	12	12	*	*
10x2 1/2x5		X		12	12	12	*	*
10x2 1/2x6		X		12	12	12	12	12
12x2 1/2x4		X		12	12	12	*	*
12x2 1/2x5		X		12	12	12	12	12
12x2 1/2x6		X		12	12	12	12	12
12x2 1/2x7		X		12	12	12	*	*
14x2 1/2x6		X		12	12	12	*	*
14x2 1/2x7		X		12	12	12	12	12
14x2 1/2x8		X		12	12	12	*	*
10x4x4		X		12	12	12	*	*
10x4x5		X		12	12	12	*	*
10x4x6		X		12	12	12	12	12
10x4x7		X		12	12	12	*	*
10x4x8		X		12	12	12	*	*
12x4x4		X		12	12	12	*	*
12x4x5		X		12	12	12	*	*
12x4x6		X		12	12	12	12	12
12x4x7		X		12	12	12	*	*
12x4x8		X		12	12	12	*	*
14x4x6		X		12	12	12	*	*
14x4x7		X		12	12	12	*	*
14x4x8		X		12	12	12	12	12
10x6x5		X		12	12	12	12	12
10x6x6		X		12	12	12	12	12
10x6x7		X		12	12	12	12	12
10x6x8		X		12	12	12	12	12
12x6x6		X		12	12	12	12	12
12x6x7		X		12	12	12	12	12
12x6x8		X		12	12	12	12	12
12x8x7		X		10	*	*	*	*
12x8x8		X		10	*	*	*	*
14x6x6		X		12	*	*	*	*
14x6x7		X		12	*	*	*	*
14x6x8		X		12	*	*	*	*
14x8x7		X		10	*	*	*	*
14x8x8		X		10	*	*	*	*

* = Contact Customer Service for quantities and availability.

Register Boots/Outlets

No.318/110/112/113BRB Basement Head Boot							
Item	Bdl	Ctn	Lse	318BRB	110BRB	112BRB	113BRB
10x6x5		X		*	*	*	*
10x6x6		X		*	*	*	*
10x6x7		X		*	*	*	*
12x6x6		X		*	*	*	*
12x6x7		X		*	*	*	*
12x6x8		X		*	*	*	*
14x6x7		X		*	*	*	*
14x6x8		X		*	*	*	*

*Contact Customer Service for box quantities.

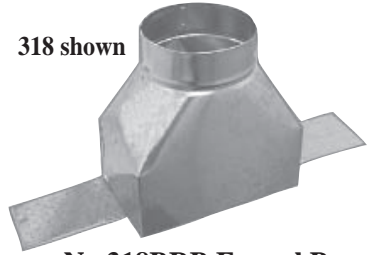

318 shown

No.318BRB Funnel Pan
No.110BRB straight
No.112BRB center
No.113BRB 90°
Basement Head Boot



No.320T
Diffuser Box
Top Outlet

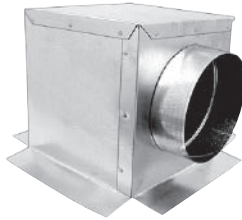

No.320S
Diffuser Box
Side Outlet



No.320
Top Ceiling Box
Flanged



317

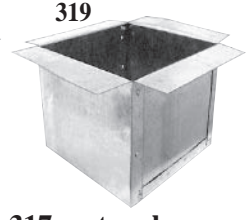

319

No.317 rectangle
No.319 square
Blind Box

No.317/319/320/320T/320S/322 Outlets												
Item	Bdl	Ctn	Lse	4"	5"	6"	7"	8"	9"	10"	12"	14"
317			X	A/O	A/O	A/O	A/O	A/O	A/O	A/O	A/O	A/O
319			X	A/O	A/O	A/O	A/O	A/O	A/O	A/O	A/O	A/O
320		X		*	A/O	A/O	A/O	A/O	A/O	A/O	A/O	A/O
320T		X		*	A/O	A/O	A/O	A/O	A/O	A/O	A/O	A/O
320S		X		*	A/O	A/O	A/O	A/O	A/O	A/O	A/O	A/O
322		X		*	A/O	A/O	A/O	A/O	A/O	A/O	A/O	A/O

A/O=Amount Ordered

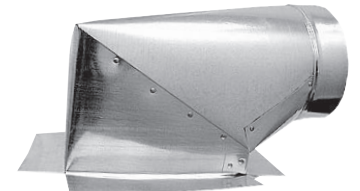

No.322
Side Ceiling Box
Flanged

No.PF Plaster Frame										
Item	Bdl	Ctn	Lse	8x4x24	10x4x24	12x4x24	14x4x24	10x6x24	12x6x24	14x6x24
all		X		25	25	25	25	25	25	25

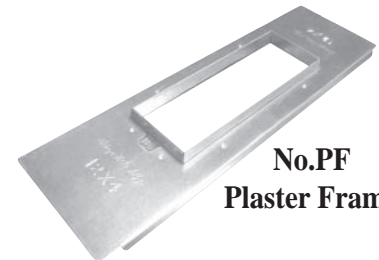

No.PF
Plaster Frame

No.MHB Mobile Home Box									
Item	Bdl	Ctn	Lse	12x20x12	14x14x10	14x20x12	14x20x14	20x14x12	20x14x14
all		X		5	5	5	5	5	5

Other sizes are available. Filter rack installed inside

* = Contact Customer Service for quantities and availability.



No.MHB
Mobile Home Box

Register Boots

Snap-Rite
Manufacturing, Inc.
A Gray Co.



No.318
Register Pan
Straight Boot

No.318 Register Pan Straight Boot			
Item	Ctn	Lse	318
6x10x5	X		12
6x10x6	X		12
6x10x7	X		12
6x12x6	X		12
6x12x7	X		12
6x12x8	X		12
6x14x6	X		12
6x14x8	X		12
8x10x6	X		6
8x10x8	X		6
8x12x6	X		6
8x12x8	X		6
8x14x8	X		4
11x14 ³ / ₄ x14	X		12
11x19 ³ / ₄ x14	X		6
11x19 ³ / ₄ x18	X		6
12 ¹ / ₄ x19 ¹ / ₂ x14	X		3
12 ¹ / ₄ x21 ¹ / ₂ x18	X		3
12 ¹ / ₄ x24x16	X		3
12 ¹ / ₂ x11x14	X		6
12 ³ / ₄ x11x16	X		6

RF

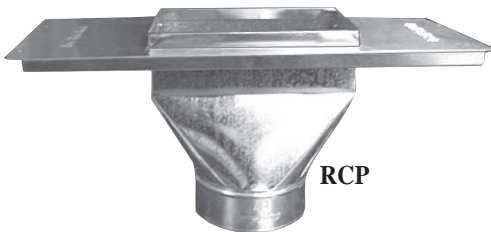

RCP

110 Items
Shown

No.110-113RCP-frame
No.110-113RF-flange
End Boot w/frame
or flange

No.110/112/113RCP and RF End Boots									
Item	Bdl	Ctn	Lse	110RCP	112RCP	113RCP	110RF	112RF	113RF
10x4x6		X		12	12	12	12	12	12
12x4x7		X		12	12	12	12	12	12
10x6x6		X		12	12	12	12	12	12
10x6x8		X		12	12	12	12	12	12
14x6x8		X		12	12	12	12	12	12

Specify Flange or Frame.

Insulated Register Boxes

No.3500/3600/F/FG/NF/F8 Insulated Register Box									
Item	Ctn	3500F	3600F	3500NF	3600NF	3600FG	3506F	3606F	3606F8
6x4x4	X	36	36	36	36	36	*	*	*
6x6x4	X	36	36	36	36	36	*	*	*
6x6x5	X	36	36	36	36	36	*	*	*
8x4x4	X	45	45	45	45	45	*	*	*
8x4x5	X	38	38	38	38	38	*	*	*
8x6x6	X	24	24	24	24	24	*	*	*
8x8x6	X	24	24	24	24	24	20	20	20
8x8x8	X	24	24	24	24	24	*	*	*
10x4x4	X	42	42	42	42	42	*	*	*
10x4x6	X	25	25	34	34	34	*	*	*
10x6x5	X	28	28	28	28	28	*	*	*
10x6x6	X	28	28	28	28	28	20	20	20
10x6x7	X	24	24	24	24	24	*	*	*
10x8x6	X	20	20	20	20	20	*	*	*
10x8x8	X	20	20	20	20	20	*	*	*
10x10x7	X	18	18	18	18	18	*	*	*
10x10x8	X	18	18	18	18	18	*	*	*
12x4x6	X	22	22	30	30	30	*	*	*
12x6x6	X	28	28	28	28	28	*	*	*
12x6x7	X	22	22	22	22	22	10	10	10
12x6x8	X	17	17	20	20	20	12	12	12
12x8x7	X	20	17	20	20	20	*	*	*
12x8x8	X	17	17	17	17	17	*	*	*
12x12x10	X	16	16	16	16	16	*	*	*
12x12x12	X	12	12	12	12	12	*	*	*
14x6x6	X	28	28	28	28	28	*	*	*
14x6x7	X	18	18	18	18	18	*	*	*
14x6x8	X	15	15	15	15	17	*	*	*
14x8x7	X	17	17	17	17	17	*	*	*
14x8x8	X	17	17	17	17	17	*	*	*
14x8x9	X	12	14	12	12	12	*	*	*
14x12x8	X	12	12	12	12	12	*	*	*
14x14x12	X	12	12	12	12	12	*	*	*

Other sizes available for insulated boxes. * = Contact Customer Service for quantities and availability. Specify Box Height.



BOOTRAIL



BOOTRAIL-L



BOOTCLEAT (BCL)

No.BOOTRAIL/L/BOOTCLEAT Bootrail/Clip				
Item	Bdl	Ctn	Lse	26 ga.x 26"
all		X		100

Other sizes available.



No.3506F R4.2 w/flange
No.3606F R6.0 w/flange
No.3606F8 R8.0 w/flange
No.3506NF R4.2 no flange
No.3606NF R6.0 no flange
No.3606NF8 R8.0 no flange
6" Deep Insulated Metal Top Register Box



R8.0
No.3500F R4.2 w/flange
No.3500NF R4.2 no flange
No.3600F R6.0 w/flange
No.3600NF R6.0 no flange
No.3600FG R6.0 w/gasket
No.3600F8 R8.0 w/flange
No.3600NF8 R8.0 no flange
Insulated Metal Top Register Box w/w/o flange



R6.0

Insulated Register Boxes

Snap-Rite
Manufacturing, Inc.
A Gray Co.



No.3700NF R4.2
No.3800NF R6.0
No.3800NF8 R8.0
Insulated Foil Top
Register Box no flange



No.3700FG R4.2 w/gasket
No.3800FG R6.0 w/gasket
Insulated Foil Top
Register Box w/gasket

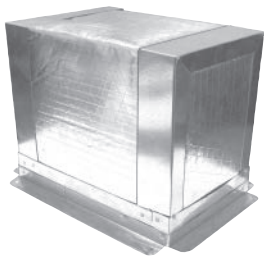

No.3900F R6.0 w/flange
No.3900NF R6.0 no flange
No.3900F8 R8.0 w/flange
Insulated Foil
Box w/wo flange
9" deep

No.3700/3800/F/FG/NF/F8 Insulated Foil Top Register Box								
Item	Ctn	3700F	3800F	3700NF	3800NF	3800FG	3900F	3800F8
6x4	X	76	76	84	100	76	*	76
6x6	X	56	56	84	64	56	*	56
8x4	X	66	66	80	80	66	25	66
8x6	X	45	45	54	60	45	*	45
8x8	X	36	36	48	48	36	*	36
10x4	X	55	55	60	60	55	16	55
10x6	X	37	37	46	46	37	16	37
10x8	X	33	33	37	37	33	*	33
10x10	X	24	24	26	26	24	*	24
12x4	X	36	48	44	44	36	*	48
12x6	X	32	32	40	40	32	16	32
12x8	X	30	30	34	34	30	*	30
12x10	X	14	24	18	24	14	*	24
12x12	X	22	22	22	22	22	*	22
14x6	X	30	30	34	34	30	12	30
14x8	X	25	25	30	30	25	*	25
14x10	X	12	12	12	12	12	*	12
14x14	X	16	16	16	16	16	*	16
14x20	X	10	10	10	10	10	*	10
16x6	X	22	22	32	32	22	*	22
16x8	X	20	20	20	20	20	*	20
16x10	X	12	12	12	12	12	*	12
16x16	X	10	10	10	10	10	*	10
16x20	X	9	9	9	9	9	*	9
18x18	X	8	8	8	8	8	*	8
18x24	X	7	9	7	7	7	*	9
18x30	X	5	5	5	8	5	*	5
18x32	X	5	5	5	5	5	*	5
20x20	X	5	5	6	6	5	*	5
20x24	X	6	6	6	6	6	*	6
20x25	X	6	5	6	6	6	*	5
20x30	X	5	5	5	5	5	*	5
24x24	X	5	5	5	5	5	*	5

Other sizes available for insulated boxes. Specify Box Height.

* = Contact Customer Service for quantities and availability.



No.3700F R4.2
No.3800F R6.0
No.3800F8 R8.0
Insulated Foil Top
Register Box w/flange



Insulated Register Boxes

No.3700/3800/FS/FSC/NFS			
Item	Ctn	3700FS	3800FS
6x4	X	*	*
6x6	X	*	*
8x4	X	36	36
8x6	X	*	*
8x8	X	40	40
10x4	X	*	*
10x6	X	18	18
10x8	X	24	24
10x10	X	24	24
12x4	X	*	*
12x6	X	18	18
12x8	X	22	22
12x10	X	*	*
12x12	X	20	20
14x6	X	18	12
14x8	X	16	16
14x10	X	*	*
14x14	X	*	*
14x20	X	*	*
16x6	X	*	*
16x8	X	*	*
16x10	X	*	*
16x16	X	*	*
16x20	X	*	*
18x18	X	*	*
18x24	X	*	*
18x30	X	*	*
18x32	X	*	*
20x20	X	*	*
20x24	X	*	*
20x25	X	*	*
20x30	X	*	*
24x24	X	*	*

No.3500/3600/FS/FSC/NFS			
Item	Ctn	3500FS	3600FS
6x4x4	X	*	*
6x6x4	X	*	*
6x6x5	X	*	*
8x4x4	X	*	*
8x4x5	X	*	*
8x6x6	X	*	*
8x8x6	X	*	*
8x8x8	X	*	*
10x4x4	X	*	*
10x4x6	X	20	20
10x6x5	X	16	16
10x6x6	X	16	13
10x6x7	X	16	16
10x8x6	X	*	*
10x8x8	X	*	*
10x10x7	X	*	*
10x10x8	X	*	*
12x4x6	X	*	*
12x6x6	X	*	*
12x6x7	X	*	*
12x6x8	X	16	16
12x8x7	X	*	*
12x8x8	X	*	*
12x12x10	X	*	*
12x12x12	X	*	*
14x6x6	X	*	*
14x6x7	X	*	*
14x6x8	X	*	*
14x8x7	X	*	*
14x8x8	X	*	*
14x8x9	X	*	*
14x12x8	X	*	*
14x14x12	X	*	*

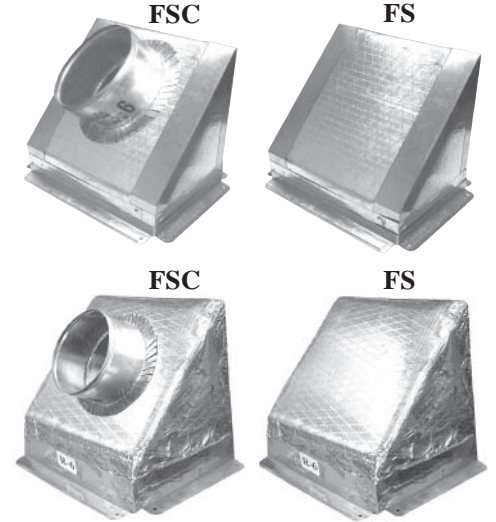

No.3700FS R4.2 w/flange
 No.3700NFS R4.2 no flange
 No.3700FSC R4.2 w/flg. & clr.
 No.3800FS R6.0 w/flange
 No.3800NFS R6.0 no flange
 No.3800FSC R6.0 w/flg. & clr.
 45° Slant Foil Top Register
 Box w/wo flange/collar

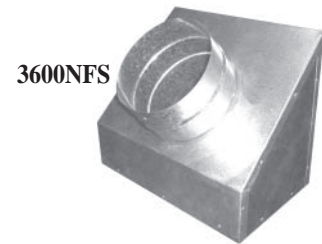

3600NFS
 No.3500FS R4.2 w/flange
 No.3500NFS R4.2 no flange
 No.3600FS R4.2 w/flange
 No.3600NFS R6.0 no flange
 45° Slant Metal Top Register
 Box w/wo flange/collar

Other sizes available for insulated boxes. Specify Box Height.
 * = Contact Customer Service for quantities and availability.

R6 Insulated Ceiling Rated Fire Damper Box

Snap-Rite
Manufacturing, Inc.
A Gray Co.

1 Hour Rated Assemblies For Use
In Floor/Ceiling, Roof/Ceiling,
Truss/Gypsum Construction
L-521, L-546, P-522, L-528



No. CRDA-A(R6) B(R4.2)
No. CRDA-C(R6) D(R4.2)
Insulated Ceiling Rated
Fire Damper Box
A,B Side Mount Metal Top
C,D Side Mount Foil Top

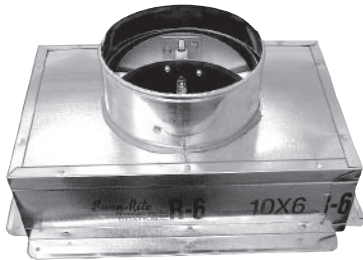

No. CRDA-E(R6) F(R4.2)
No. CRDA-G(R6) H(R4.2)
Foil Top Ins. Ceiling Rated
Fire Damper Box
E,F Top Mount Metal Top
G,H Top Mount Foil Top



No. FDP
Fire Damper Plenum
Specify 8", 9", 10", 12" sleeve

No. CRDA/A-H Ceiling Fire Damper Box

Item	Bdl	Ctn	Lse	CRDA/A-D	CRDA/E-H
6x4x4		X		36	36
6x4x5		X		36	36
6x6x4		X		36	36
6x6x5		X		36	36
8x4x4		X		42	42
8x4x5		X		30	30
8x6x6		X		24	24
8x8x6		X		24	24
8x8x7		X		24	24
8x8x8		X		24	24
10x4x4		X		30	30
10x4x5		X		34	34
10x4x6		X		24	24
10x6x4		X		28	28
10x6x5		X		28	28
10x6x6		X		28	28
10x6x7		X		19	19
10x6x8		X		15	15
10x8x6		X		20	20
10x8x7		X		20	20
10x8x8		X		20	20
10x10x7		X		18	18
10x10x8		X		18	18
10x10x9		X		16	16
12x4x6		X		30	30
12x6x6		X		26	26
12x6x7		X		16	16
12x6x8		X		12	12
12x8x6		X		17	17
12x8x7		X		19	19
12x8x8		X		18	18
12x12x6		X		16	16
12x12x8		X		12	12
12x12x9		X		16	16
12x12x10		X		12	12
14x6x6		X		28	28
14x6x7		X		15	15
14x6x8		X		11	11
14x8x7		X		17	17
14x8x8		X		17	17
14x8x9		X		12	12
14x12x8		X		12	12
14x14x12		X		8	8
				12x10	20
				12x12	18
				14x12	16

Fire Damper Plenum

Wall Stack/Fittings

No.124BL Wall Stack

Item	Bdl	Ctn	Lse	10x2¼	12x2¼	14x2¼	10x3¼	12x3¼	14x3¼
all	X			5	5	5	5	5	5

Other lengths available.

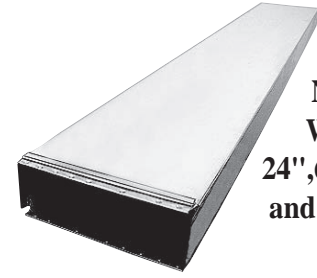

No.124BL
Wall Stack
24",60",96",100",
and 120" lengths

No.103 Horizontal Stackhead

Item	Bdl	Ctn	Lse	10x2¼	12x2¼	10x3¼	12x3¼
4x10		X		12	*	12	*
4x12		X		*	12	*	12

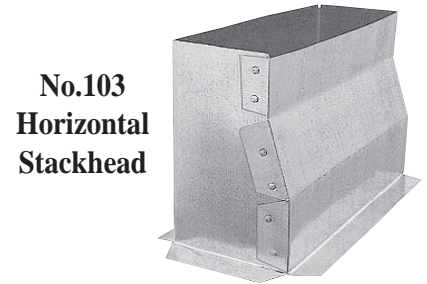

No.103
Horizontal
Stackhead

No.141 Wall Stack Start Collar

Item	Bdl	Ctn	Lse	10x2¼	12x2¼	14x2¼	10x3¼	12x3¼	14x3¼
all		X		12	12	12	12	12	12

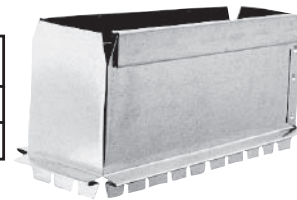

No.141
Wall Stack
Start Collar

No.117SET Wall Stack End Cap

Item	Bdl	Ctn	Lse	10x2¼	12x2¼	14x2¼	10x3¼	12x3¼	14x3¼
all	X			12	12	12	12	12	12

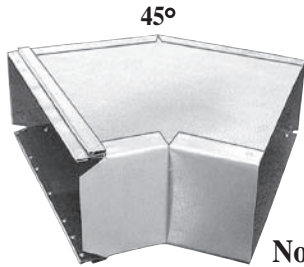

45°

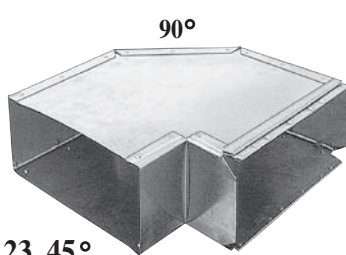

90°

No.123 45°
No.122 90°

Wallstack Horizontal Angle/Elbow

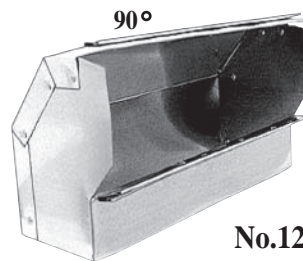

90°

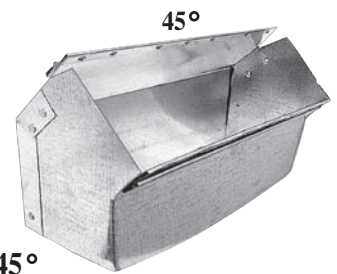

45°

No.121 45°
No.120 90°

Wallstack Vertical Angle/Elbow

No.121/120 Wallstack Vertical Angle/Elbow

Item	Bdl	Ctn	Lse	10x2¼	12x2¼	14x2¼	10x3¼	12x3¼	14x3¼
120		X		12	12	12	12	12	12
121		X		12	12	12	12	12	12

No.122/123 Wallstack Horizontal Angle/Elbow

Item	Bdl	Ctn	Lse	10x2¼	12x2¼	14x2¼	10x3¼	12x3¼	14x3¼
122	X			12	12	12	12	12	12
123	X			12	12	12	12	12	12



No.117SET
Wall Stack
End Cap

* = Contact Customer Service for quantities and availability.

Wall Stack/Fittings

Snap-Rite
Manufacturing, Inc.
A Gray Co.



No.113S
Wall Stack
Elbow Boot-90°



No.110S
Wall Stack
Straight Boot



No.104E
Wall Stackhead
w/ears
3" & 9" throat

No.113S/110S/112S Wall Stack Boots								
Item	Bdl	Ctn	Lse	113S	110S	112S	112SR	112SL
10x2 1/4x4		X		12	12	12	*	*
10x2 1/4x5		X		12	12	12	*	*
10x2 1/4x6		X		12	12	12	12	12
12x2 1/4x5		X		12	12	12	*	*
12x2 1/4x6		X		12	12	12	12	12
12x2 1/4x7		X		12	12	12	*	*
14x2 1/4x6		X		12	12	12	*	*
10x3 1/4x4		X		12	12	12	*	*
10x3 1/4x5		X		12	12	12	*	*
10x3 1/4x6		X		12	12	12	12	12
10x3 1/4x7		X		12	12	12	*	*
12x3 1/4x6		X		12	12	12	12	12
12x3 1/4x7		X		12	12	12	*	*
12x3 1/4x8		X		12	12	12	*	*
14x3 1/4x6		X		12	12	12	*	*
14x3 1/4x7		X		12	12	12	*	*
14x3 1/4x8		X		12	12	12	*	*

No.112SR right
No.112S center
No.112SL left
Wall Stack End Boot



lft



ctr



rt

No.104E Wall Stackhead w/ears								
Item	Bdl	Ctn	Lse	10x2 1/4x6	12x2 1/4x6	10x3 1/4x6	12x3 1/4x6	14x3 1/4x6
3"		X		12	12	12	12	12
9"		X		12	12	12	12	12

* = Contact Customer Service for quantities and availability.

Oval Pipe/Fittings

No.500/501-O Oval Pipe							
Item	Bdl	Ctn	Lse	5"	6"	7"	8"
60"	X			6	6	6	6
100"	X			6	6	6	6

Other lengths available.

No.500-O 60"
 No.501-O 100"
 Oval Pipe



No.504/M Oval End Boot									
Item	Bdl	Ctn	Lse	5"to 5"	6"to 6"	6"to 7"	6"to 8"	7"to 7"	7"to 8"
std.		X		12	12	12	12	12	12
man.		X		*	12	12	*	12	*

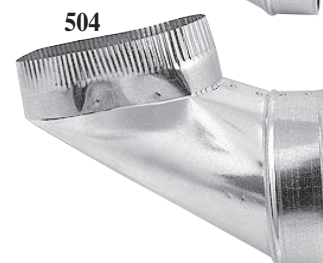
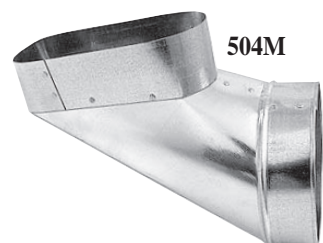

No.504 standard
 No.504M manual
 Oval End Boot



No.505 corrugated
 No.505M manual
 Oval Angle Boot



No.505/M Oval Angle Boot									
Item	Bdl	Ctn	Lse	5"to 5"	6"to 6"	6"to 7"	6"to 8"	7"to 7"	7"to 8"
all		X		12	12	12	12	12	12



No.506-O
 Oval
 Straight Boot

No.506-O Oval Straight Boot									
Item	Bdl	Ctn	Lse	5"to 5"	6"to 6"	6"to 7"	6"to 8"	7"to 7"	7"to 8"
all		X		12	12	12	12	12	12

No.514-O Oval to Oval (Reverse)Boot					
Item	Bdl	Ctn	Lse	6"to 6"	7"to 7"
all		X		12	12

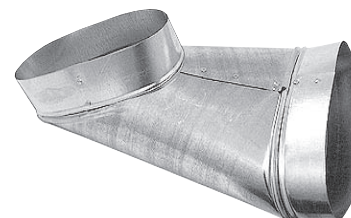

No.514-O
 Oval to Oval
 (Reverse)Boot

* = Contact Customer Service for quantities and availability.
 Specify w/wo crimp.

Oval Fittings

Snap-Rite
Manufacturing, Inc.
A Gray Co.

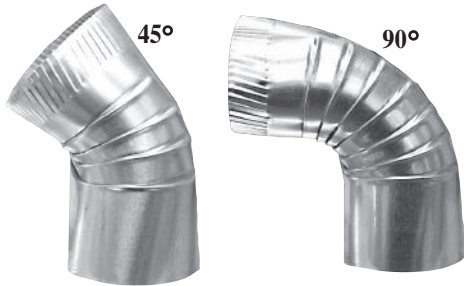

No.503-O 45°
No.502-O 90°
Vertical Oval
Angle/Elbow

No.503/502-O Vertical Oval Angle/Elbow							
Item	Bdl	Ctn	Lse		5"	6"	7"
45°		X			12	12	12
90°		X			12	12	12

No.503/502-OF Horizontal Oval Angle/Elbow							
Item	Bdl	Ctn	Lse		5"	6"	7"
45°		X			12	12	12
90°		X			12	12	12

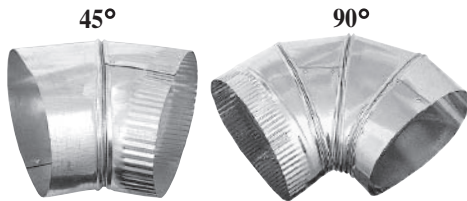

No.503-OF 45°
No.502-OF 90°
Horizontal Oval
Angle/Elbow

No.507-O/507-OD Oval Stackhead													
Item	Bdl	Ctn	Lse	10x4x6	10x4x7	10x6x5	10x6x6	10x6x7	12x4x6	12x6x6	12x6x7	14x6x7	14x6x8
all		X		12	12	12	12	12	12	12	12	12	12



No.507-O plain
No.507-OD double
Oval Stackhead



No.508-O straight
No.509-O Angle-45°
No.510-O Horizontal-90°
Square to Oval Boot

No.508/509/510-O Square to Oval Boot							
Item	Bdl	Ctn	Lse		10x4x6	12x2½x6	12x4x7
45°		X			12	12	12
90°		X			12	12	12
strt.		X			12	*	*



No.513
Oval Start Collar

No.513SE/LE Oval Start Collar								
Item	Bdl	Ctn	Lse		5"	6"	7"	8"
all		X			12	12	12	12

* = Contact Customer Service for quantities and availability. SE=Crimped LE=No Crimp

Adhesive/Spin Fittings

No.400M/401/402/403 Metal Spin-In Fitting															
Item	Bdl	Ctn	Lse	4"	5"	6"	7"	8"	9"	10"	12"	14"	16"	18"	20"
all		X		12	12	12	12	12	12	12	10	8	6	5	2



pln



dpr

No.400M plain
No.401M w/damper
No.402M w/scoop
No.403M w/scoop & damper
Metal Spin-In Fitting



scp

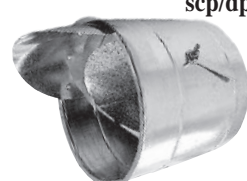

scp/dpr

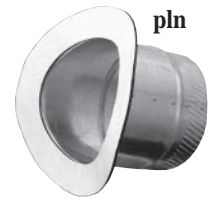

pln

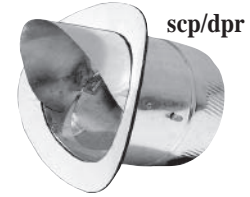

scp/dpr

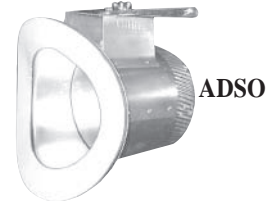

ADSO

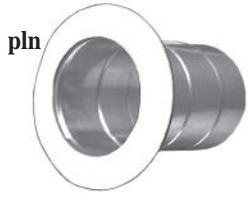

pln



ASDSO

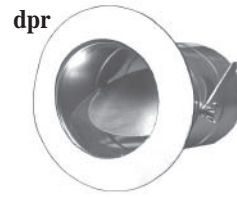

dpr

No.400A plain
No.400AD w/damper
No.400ADSO w/ S/O dpr.
No.400AS w/scoop
No.400ASD w/scoop & damper
NO.400ASDSO w/scp. & S/O dpr.
Adhesive Round to Round Takeoff



scp/dpr



dpr



scp



scp

No.400A/AD/AS/ASD/ASDSO Adhesive Round to Round Takeoff														
Item	Bdl	Ctn	Lse	4"	5"	6"	7"	8"	9"	10"	12"	14"	16"	18"
A/AD		X		12	12	12	12	12	10	10	8	6	4	2
AS/ASD		X		12	12	12	12	12	10	10	8	6	4	2

No.406A/AD/AS/ASD/ADSO Adhesive Saddle Takeoff														
Item	Bdl	Ctn	Lse	4"	5"	6"	7"	8"	9"	10"	12"	14"	16"	18"
R4.2		X		12	12	12	12	12	12	12	12	A/O	A/O	A/O
R6.0		X		12	12	12	12	12	12	12	12	A/O	A/O	A/O

A/O=Amount Ordered

No.400CM/401CMD Metal Conical Spin-In												
Item	Bdl	Ctn	Lse	5"	6"	7"	8"	9"	10"	12"	14"	16"
all		X		12	12	12	12	8	8	6	4	4



No.400CM plain
No.401CMD w/damper
Metal Conical Spin-In

Start Collars

Snap-Rite
Manufacturing, Inc.
A Gray Co.



No.313SE
No.313LE
Start Collar

No.313SE/LE Start Collar																
Item	Bdl	Ctn	Lse	3"	4"	5"	6"	7"	8"	9"	10"	12"	14"	16"	18"	20"
30ga.		X		24	24	24	24	24	24	24	24	24	24	*	*	*
26ga.		X		24	24	24	24	24	24	24	24	24	24	24	15	12

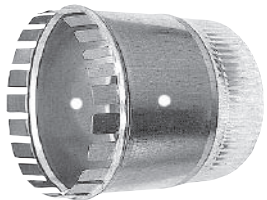

No.313FGSE/LE/SER
No.313FGLEDH
6L Start Collar
w/dpr. holes

No.313FGSE/LE/SER 6L Start Collar																
Item	Bdl	Ctn	Lse	3"	4"	5"	6"	7"	8"	9"	10"	12"	14"	16"	18"	20"
30ga.		X		12	12	12	18	12	12	12	12	12	12	*	*	*
26ga.		X		12	12	12	18	12	12	12	12	12	12	8	8	6



No.313FGDSE
No.313FGDLE
6L Start Collar
w/damper



FGSE
No.313FGSE/LE
No.313FGSER/LE
6L Start Collar
Standard or w/ring



FGSER
w/ring

No.313FGSSE
No.313FGSLE
6L Start Collar
w/scoop

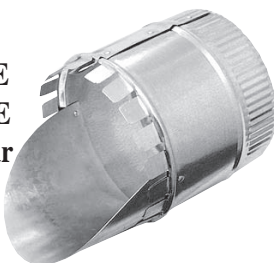

No.313FGSEDH/LE 6L Start Collar w/holes																
Item	Bdl	Ctn	Lse	3"	4"	5"	6"	7"	8"	9"	10"	12"	14"	16"	18"	20"
30ga.		X		12	12	12	18	12	12	12	12	12	12	*	*	*
26ga.		X		12	12	12	18	12	12	12	12	12	12	8	8	6



No.313FGSDSE
No.313FGSDLE
6L Start Collar
w/scoop & damper

No.313FGDSE/LE 6L Start Collar w/damper																
Item	Bdl	Ctn	Lse	3"	4"	5"	6"	7"	8"	9"	10"	12"	14"	16"	18"	20"
30ga.		X		12	12	12	18	12	12	12	12	12	12	*	*	*
26ga.		X		12	12	12	18	12	12	12	12	12	12	8	8	6

No.313FGSSE/LE 6L Start Collar w/scoop																
Item	Bdl	Ctn	Lse	3"	4"	5"	6"	7"	8"	9"	10"	12"	14"	16"	18"	20"
30ga.		X		12	12	12	18	12	12	12	12	12	12	*	*	*
26ga.		X		12	12	12	18	12	12	12	12	12	12	8	8	6

No.313FGSDSE/LE 6L Start Collar w/scoop & damper																
Item	Bdl	Ctn	Lse	3"	4"	5"	6"	7"	8"	9"	10"	12"	14"	16"	18"	20"
30ga.		X		12	12	12	18	12	12	12	12	12	12	*	*	*
26ga.		X		12	12	12	18	12	12	12	12	12	12	8	8	6

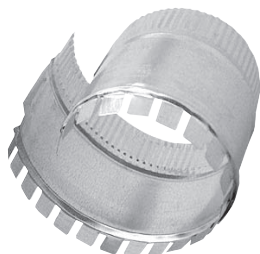

No.313FGSESL/SLDH
No.313FGLESL/SLDH
6L Snap-Lock Collar
specify dpr. holes

No.313FGSES/LE/SLDH 6L Snap-Lock Collar																
Item	Bdl	Ctn	Lse	3"	4"	5"	6"	7"	8"	9"	10"	12"	14"	16"	18"	20"
30ga.		X		12	12	12	12	12	12	12	12	12	12	*	*	*
26ga.		X		12	12	12	12	12	12	12	12	12	12	12	8	6

* = Contact Customer Service for quantities and availability. SE=Crimped LE=No Crimp
FG=6" long DH=damper holes

Ductboard Start Collars

No.404R/CR Ductboard Start Collar Ring

Item	Bdl	Ctn	Lse	4"	5"	6"	7"	8"	9"	10"	12"	14"	16"	18"	20"
all		X		A/O	A/O	A/O	A/O	A/O	A/O	A/O	A/O	A/O	A/O	A/O	A/O

A/O=Amount Ordered



R8.0



dpr

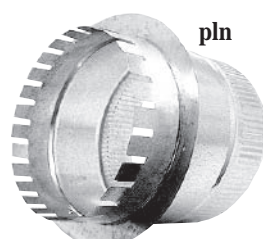

pln

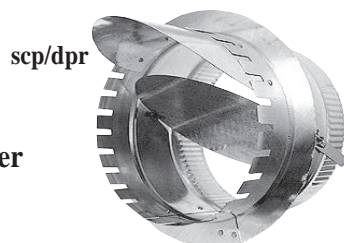

scp/dpr

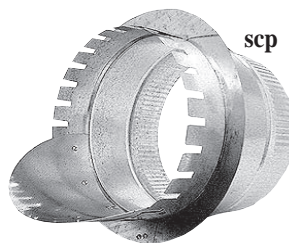

scp

No.404D plain
No.405D w/damper
No.404DS w/scoop
No.405DS w/scoop & damper
404D8 R8.0 plain
Ductboard Start Collar



CR



R

No.404R/CR
Ductboard Start
Collar Ring

No.404D/405D/404D8 Ductboard Start Collar

Item	Bdl	Ctn	Lse	3"	4"	5"	6"	7"	8"	9"	10"	12"	14"	16"	18"	20"
all		X		12	12	12	12	12	12	12	12	12	10	8	5	4

R8.0 available with scoop and damper.

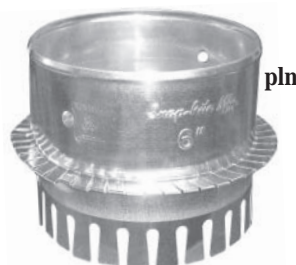

pln

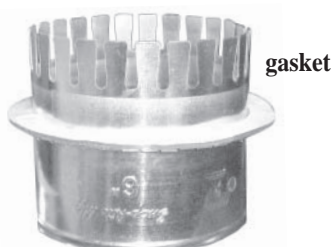

gasket



scp

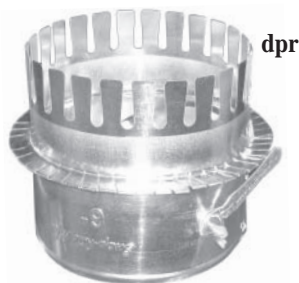

dpr

No.404DCC plain
No.405DCC w/damper
No.404DCCS w/scoop
No.405DCCS w/scoop & damper
No.404DCCG w/gasket
No.405DCCG w/damper & gasket
Ductboard Double-Click
Start Collar

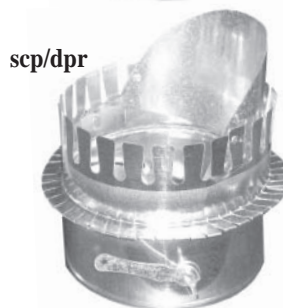

scp/dpr



No.404DCCSL
Ductboard Double-Click
Nested Snap-Lock Collar
Specify crimp/no crimp



No.404DCCCL
Ductboard Double-Click
Snap-Lock Collar
w/crimp
Specify nested or snapped

No.404/405DCC/D/S/G DB Double-Click Start Collar

Item	Bdl	Ctn	Lse	4"	5"	6"	7"	8"	9"	10"	12"	14"	16"	18"	20"
no crp.		X		175	120	80	55	45	40	35	23	20	15	14	12
crimp		X		*	*	*	*	*	*	*	*	*	*	*	*

Ring sealed with Hot Melt. Bulk packaging available.

* = Contact Customer Service for quantities and availability.

Ductboard-Spin Fittings/Takeoffs

Snap-Rite
Manufacturing, Inc.
A Gray Co.



pln



scp/dpr

No.400D plain
No.401D w/damper
No.402D w/scoop
No.403D w/scoop & damper
Ductboard Spin Fitting

No.400D/401D/402D/403D DB Spin Fittings															
Item	Bdl	Ctn	Lse	4"	5"	6"	7"	8"	9"	10"	12"	14"	16"	18"	20"
all		X		12	12	12	12	12	6	6	4	4	3	3	2

Specify 1" or 1½" ductboard.

No.401ACSO Airtite Conical w/ Standoff Dpr.				
Item	Bdl	Ctn	Lse	Description
all		X		A/O

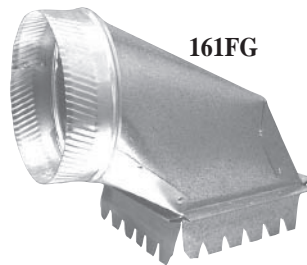

161FG

No.161FG 1"rise
No.161FG-RISE 0"rise
Ductboard Takeoff

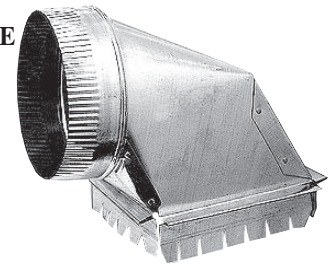

161FG-RISE

No.161FG/RISE DB Square to Round Takeoff								
Item	Bdl	Ctn	Lse	5"	6"	7"	8"	10"
161fg		X		12	12	12	8	4
161-R		X		12	12	12	12	*

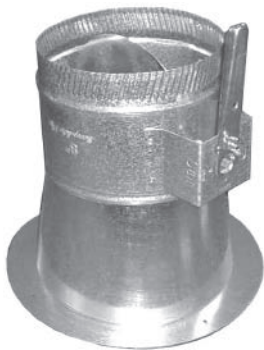

No.401ACSO
Airtite Conical
w/standoff dpr.

No.181FG Adjustable Ductboard Takeoff								
Item	Bdl	Ctn	Lse	5"	6"	7"	8"	10"
all		X		12	12	12	12	*



No.181FG
Adjustable
Ductboard Takeoff



No.302DB
Round to Round
Ductboard Takeoff

No.302DB Round to Round Ductboard Takeoff							
Item	Bdl	Ctn	Lse	5"	6"	7"	8"
all		X		12	12	12	12



No.163FGTOSO
Sq. to Rd. Ductboard Takeoff
w/standoff damper

No.163FGTOSO Sq. to Rd. Ductboard Takeoff-Standoff Dpr.											
Item	Bdl	Ctn	Lse	5"	6"	7"	8"	9"	10"	12"	14"
all		X		*	*	*	*	*	*	*	*

* = Contact Customer Service for quantities and availability. A/O=Amount Ordered

Venting Products

No.WHAB Wide Mouth Dryer Vent Hood/tail

Item	Bdl	Ctn	Lse	3"	4"
all		X		12	12



No.WHAB
 Wide Mouth Plastic
 Dryer Vent Hood/tail

No.WLAB Flush Mount Plastic Dryer Vent Hood/tail

Item	Bdl	Ctn	Lse	3"	4"
all		X		12	12



No.WLAB
 Flush Mount Plastic
 Dryer Vent Hood/tail

No.329 Galvanized Fresh-Air Intake

Item	Bdl	Ctn	Lse	4"	5"	6"	7"	8"	10"
all		X		12	12	12	12	12	12



No.329
 Galvanized
 Fresh-Air Intake

No.807 Aluminum Dryer Vent Hood

Item	Bdl	Ctn	Lse	3"	4"
all		X		A/O	A/O



No.807
 Aluminum Dryer
 Vent Hood

No.328 Galvanized Dryer Vent Hood/tail

Item	Bdl	Ctn	Lse	5"	6"
all		X		A/O	A/O

Specify tail length.

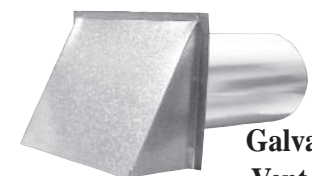

No.328
 Galvanized Dryer
 Vent Hood w/tail

No.801/C Compressed 8' Flexible Aluminum Duct

Item	Bdl	Ctn	Lse	3"	4"	5"	6"	7"
all		X		14	8	5	3	5



No.801 plain
 No.801C crimped
 Compressed Flexible
 Aluminum Duct

No.HOSE Vinyl Hose

Item	Bdl	Ctn	Lse	3" x 50'	4" x 50'
all		X		1	1



No.HOSE
 Vinyl Hose

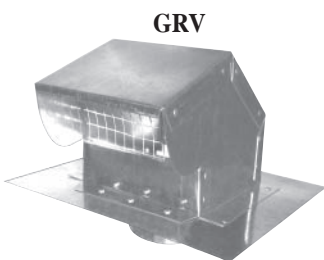

No.GRV reg.
 No.GRVD w/damper
 No.GRVT tall
 No.GRVXT extra tall
 Galvanized Roof Vent

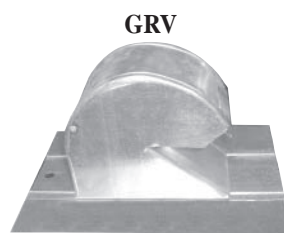

Gooseneck

No.GRV/D/T/XT Galvanized Roof Vent

Item	Bdl	Ctn	Lse	4"	5"	6"	7"	8"	10"
all		X		12	12	12	12	12	12

A/O=Amount Ordered

Specialty Products

Snap-Rite
Manufacturing, Inc.
 A Gray Co.



No.800
Aluminum
Round Pipe & Elbow



No.600
Black
Round Pipe & Elbow

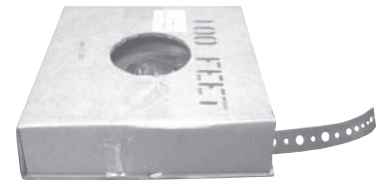

3/4" x 100'
Perforated Strap

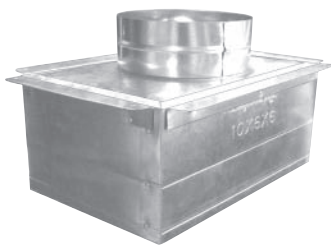

No.3506TF R4.2 w/flange
No.3606TF R6.0 w/flange
No.3606TF8 R8.0 w/flange
6" Deep Insulated Metal Top
Register Box w/ top flange

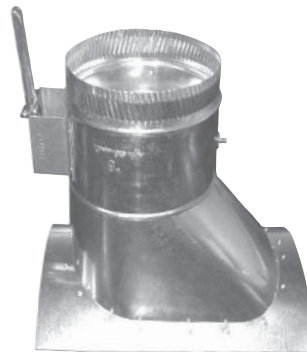

No.163SADSO
Sq. to Rd. Airtite Saddle
Takeoff w/standoff dpr.

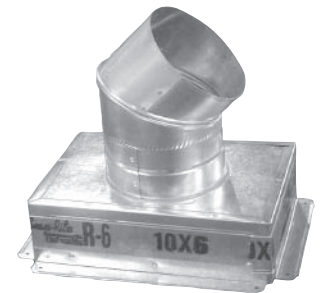

No.3500FA R4.2 w/flange
No.3500NFA R4.2 w/no flange
No.3600FA R6.0 w/flange
No.3600NFA R6.0 no flange
No.3600FA8 R8.0 w/flange
No.3600NFA8 R8.0 no flange
Insulated Metal Top
Register Box Angle Outlet

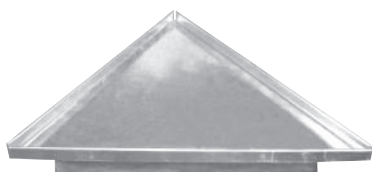

No.307INEND
Ins. Triangle
End Panel



No.307IN4
4" Ins. Triangle Wye
No.307IN6
6" Ins. Triangle Wye

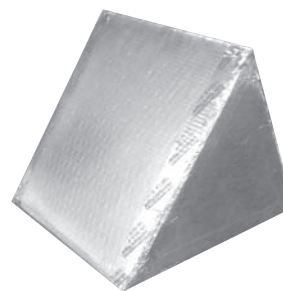

Ductboard Triangle
Specify Small,
Medium or Large

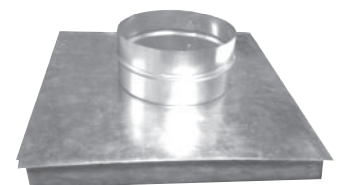

No.307 INPANEL
Square Insulated
Side Panel w/collar

Some Very Important Value Added Quality Features of *Snap-Rite*[®] Products Include:

- Hemmed Edges on Boots and many Fittings; thereby strengthening and providing a safety feature not seen on most competitive products**
- Most line items Embossed with size so measurement with ruler is not required when pulling and installing items**
- Palletized freight available in most shipping regions**
- Fittings packed in quantities of 12 allowing for less investment to meet box quantity minimums**

Remember - When Quality Counts - Ask for *Snap-Rite*[®]

NOTES: _____

Full Line • HVAC • Residential and Lite Commercial Air Duct Manufacturer

PIPE, ELBOWS, FITTINGS, RECTANGULAR DUCT, INSULATED REGISTER BOXES,
STARTING COLLARS, REDUCERS, INSULATED FIRE DAMPER BOXES,
DRAIN PANS, OVAL PIPE & FITTINGS, and over 120 more items to choose from.

www.snaprite.com

**6285 Peterson Rd.
Lake Park, GA. 31636**

PH: 229-559-3772

FX: 229-559-9965

**PO. Box 577
Coats, NC. 27521**

PH: 910-897-4080

FX: 910-897-6662

**FAST SERVICE
THE NAME IMPLIES**

Snap-Rite Manufacturing, Inc.

**14200 Darley Ave.
Cleveland, OH. 44110**

PH: 216-851-2740

FX: 216-851-2749

**MADE IN
THE USA**



04/10