

Q314 and Q327A Pilot Burners

Application

Pilot burners provide main burner ignition for standing pilot natural and LP gas systems. Used with a thermocouple to provide automatic pilot safety control. Used with a thermopile in a self-powered system. See Table 1 for model specifications.

TABLE 1—MODEL SPECIFICATIONS.

Model	Primary Aerated	Type of Orifice	Pilot Tip Type	Includes
Q314A	No	Insert	Target	Includes natural and LP gas orifices, 1/4 in. compression fitting, "F," "K," or "L" tip styles, "B" mounting bracket, and "A" mounting bracket adapter.
Q327A	Yes	Spud	Target	Includes natural and LP gas orifices, 1/4 in. compression fitting, and "B" mounting bracket with screws.

Installation

WHEN INSTALLING THIS PRODUCT...

1. Read these instructions carefully. Failure to follow instructions can damage product or cause a hazardous condition.
2. Check ratings given in instructions and on product to make sure product is suitable for your application.
3. Make sure installer is a trained, experienced service technician.
4. After completing installation, use these instructions to check out product operation.

A WARNING

FIRE OR EXPLOSION HAZARD CAN CAUSE PROPERTY DAMAGE, SEVERE INJURY, OR DEATH

Follow these warnings exactly.

1. Disconnect power supply before wiring to prevent electrical shock or equipment damage.
2. To avoid dangerous accumulation of fuel gas, turn off gas supply at appliance service valve before starting installation and perform Gas Leak Test after completion of installation.
3. Do not bend pilot tubing at the control or pilot after compression nut has been tightened. Gas leakage at the connection may result.

Follow appliance manufacturer's instructions if available; otherwise, use instructions provided below.

LOCATION

1. Position pilot burner for easy access, observation, and lighting. In replacement applications, replace pilot burner

with an identical unit and position new pilot burner in the same location and orientation as the original pilot burner.

2. Mount pilot burner on main burner. Mounting surfaces other than the main burner can shift, bend, or warp as furnace expands and contracts while operating. See Fig. 1.

3. Mount pilot burner so the ignition flame remains properly positioned with respect to the main burner flame. See Fig. 2.

4. Supply pilot flame with ample air free of combustion products.

5. Do not impinge pilot flame on adjacent parts. Do not impinge main burner flame on pilot burner.

6. Do not expose pilot flame to falling scale which could impair ignition of main burner.

7. Do not expose pilot burner to main burner rollout while igniting or extinguishing.

8. Do not expose pilot flame to drafts that push or pull pilot flame away from the thermocouple or thermopile.

Fig. 1—Mount pilot burner on main burner.

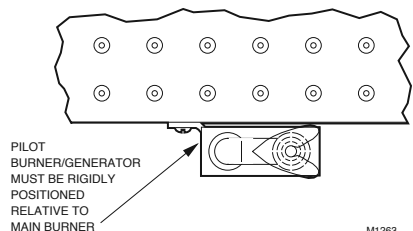

M1263

Fig. 2—Location of pilot burner.

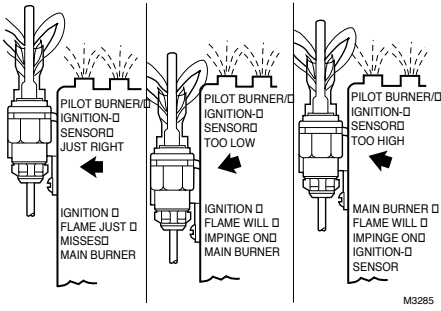

CONNECT PILOT GAS TUBING

1. Cut tubing to desired length and bend as necessary for routing to pilot burner. Do not make sharp bends or deform tubing. Do not bend tubing at control after compression nut has been tightened, as this can result in gas leakage at connection.
2. Square off and remove burrs from end of tubing.
3. Push tubing into compression nut clearance hole until tubing bottoms.

NOTE: When replacing a pilot burner or orifice, cut off old compression fitting and replace with new compression fitting provided with new pilot burner. Never use old compression fitting as it may not provide a gas-tight seal. See Fig. 3.

4. While holding tubing all the way in, engage threads and turn until finger tight.
5. Using a wrench, turn compression nut one turn beyond finger tight. **DO NOT OVERTIGHTEN.**
6. Connect other end of tubing to gas control according to gas control manufacturer instructions.

Fig. 3—Always use new compression fitting.

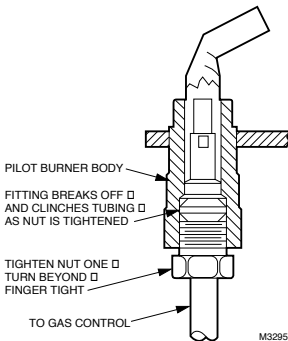

INSTALL THERMOCOUPLE OR THERMOPILE PUSH-IN DESIGN

1. Insert thermocouple or thermopile tip into hole or barrel provided beneath pilot burner. See Fig. 4.
2. Push in firmly until thermocouple or thermopile is locked into place.

ATTACHMENT NUT DESIGN

1. Insert thermocouple or thermopile tip into hole or barrel provided beneath pilot burner. See Figs. 4 and 5.
2. Engage attachment nut threads and tighten until thermocouple or thermopile is locked into place.

Fig. 4—Installing thermocouple or thermopile.

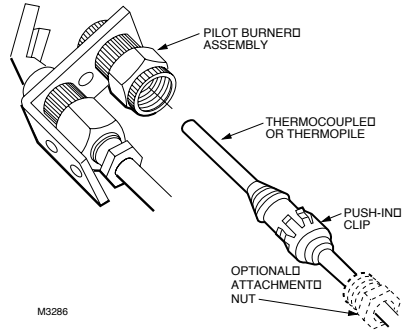
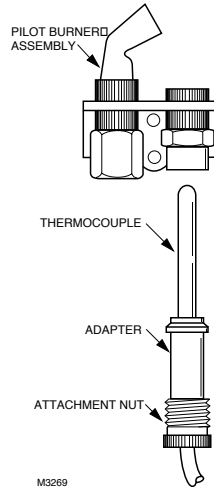

Fig. 5—Installing Q390 Thermocouple.

SCREW-IN TYPE



INSTALL BLEED GAS TUBING (if used):

1. Route bleed gas tubing from bleed tapping on gas control to the pilot burner.
2. Push clip into place. See Fig. 6.
3. Insert bleed gas tubing until 3/8 inch [10 mm] of tubing is above pilot burner bracket. Tip of bleed gas tubing must not extend into pilot flame.

INSTALL "A" MOUNTING BRACKET ADAPTER (optional)

To convert mounting bracket from "B" mounting bracket to "A" mounting bracket, install the "A" mounting bracket adapter to the pilot burner mounting bracket. Then install pilot burner to main burner.

Fig. 6—Bleed gas tube installation.

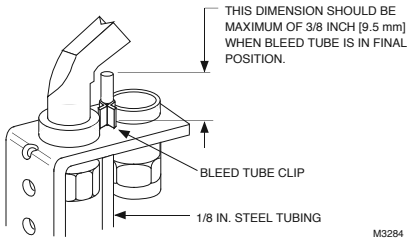

CHANGE INSERT ORIFICES (See Fig. 7)

1. Disconnect pilot tubing from the pilot burner and remove insert orifice. Sometimes a light force is required to remove the orifice.
2. Cut off old compression fitting.

NOTE: When replacing an orifice, cut off old compression fitting and replace with a new compression fitting. Never use old compression fitting as it may not provide a gas-tight seal. See Fig. 3.

3. Square off end of pilot tubing and remove all burrs.
4. Insert new compression nut over pilot tubing and slide out of the way.
5. Insert new orifice into pilot burner and push pilot tubing into the pilot burner until it bottoms.
6. While holding tubing all the way in, slide compression fitting into place and engage threads. Turn until finger tight.
7. Using a wrench, tighten compression fitting one turn beyond finger tight.

CHANGE SPUD ORIFICES (See Fig. 7)

1. Disconnect pilot tubing from orifice.
2. Unscrew old spud orifice and discard.
3. Cut off old compression fitting.

NOTE: When replacing an orifice, cut off old compression fitting and replace with a new compression fitting. Never use old compression fitting as it may not provide a gas-tight seal. See Fig. 3.

4. Square off end of pilot tubing and remove all burrs.
5. Insert new compression nut over pilot tubing and slide out of the way.
6. Insert new orifice into pilot burner and tighten securely.
7. Push pilot tubing into orifice until it bottoms.
8. While holding tubing all the way in, slide compression fitting into place and engage threads. Turn until finger tight.
9. Using a wrench, tighten compression fitting one turn beyond finger tight.

Fig. 7—Changing spud and insert orifices.

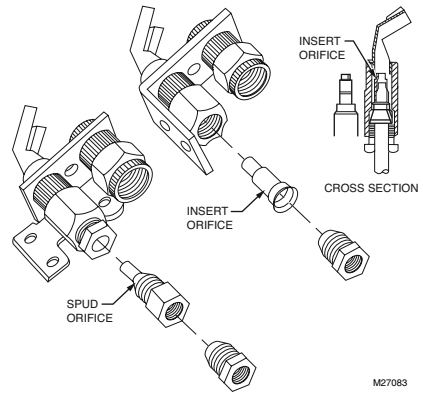

Startup and Checkout

PERFORM GAS LEAK TEST

⚠ WARNING

**FIRE OR EXPLOSION HAZARD
CAN CAUSE PROPERTY DAMAGE,
SEVERE INJURY, OR DEATH**

Check for gas leaks with soap and water solution any time work is done on a gas system.

GAS LEAK TEST:

1. Ensure that gas supply is turned on at the appliance service valve.
2. Paint pipe connections upstream of pilot burner with rich soap and water solution. Bubbles indicate gas leak.
3. If leak is detected, tighten pipe connections.
4. Stand clear of main burner while lighting to prevent injury caused from hidden leaks which could cause flashback in the appliance vestibule. Light main burner.
5. With main burner in operation, paint pipe joints (including adapters) and gas control inlet and outlet with rich soap and water solution.
6. If another leak is detected, tighten adapter screws, joints, and pipe connections.
7. Replace part if leak can not be stopped.

ADJUST PILOT FLAME

The pilot flame should envelop 3/8 to 1/2 in. [10 to 13 mm] of the thermocouple or thermopile tip. See Fig. 8. To adjust pilot flame:

1. Remove pilot adjustment cover screw from gas control.
2. Turn inner pilot adjustment screw clockwise ↻ to decrease or counterclockwise ↺ to increase pilot flame.
3. Always replace pilot adjustment cover screw and tighten firmly after completing adjustment to ensure proper operation.

Fig. 8—Thermocouple or thermopile tip must be in pilot flame.

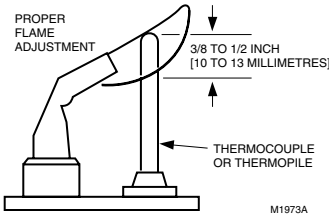

IGNITE PILOT BURNER

1. Before lighting pilot burner, turn thermostat to its lowest setting. Wait for unburned gas to vent.

NOTE: LP gas is heavier than air and will not vent upward. Smell for LP gas next to floor. If you smell gas, shut off the main valve in the gas piping, or, ON LP, AT THE TANK. Perform Gas Leak Test to recheck all connections.

2. Light pilot burner according to appliance manufacturer's instructions.

Service

⚠ WARNING

**FIRE OR EXPLOSION HAZARD
CAN CAUSE PROPERTY DAMAGE,
SEVERE INJURY, OR DEATH**

Perform Gas Leak Test anytime work is done to the system.





PILOT OUTAGE

1. If pilot flame goes out during normal operation, but is properly adjusted, recheck Mounting and Location instructions on page 1.

2. If all mounting and location instructions are followed but pilot continues to go out, construct shielding to protect pilot flame from main burner ignition and extinction and drafts. See Fig. 9.

3. Check pilot flame characteristics.
 - Check the pilot flame with the main burner operating.
 - Ensure the pilot flame continuously covers the tip of the thermocouple or thermopile, the spark gap and 3/8 to 1/2 in. [10 to 13 mm] of the ground rod. See Fig. 8.
 - Ensure the pilot flame is blue (a yellow tipped flame is acceptable on LP systems), soft and steady. See Fig. 9 for examples of possible pilot flame problems and their causes.
 - If pilot burner is damaged, replace it with an identical pilot burner and mount and position in the same location and orientation.

Fig. 9—Examples of unsatisfactory pilot flames.

APPEARANCE	CAUSE
<p>SMALL BLUE FLAME</p> 	<p>CHECK FOR LACK OF GAS FROM:</p> <ul style="list-style-type: none"> • CLOGGED ORIFICE FILTER • CLOGGED PILOT FILTER • LOW GAS SUPPLY PRESSURE • PILOT ADJUSTMENT AT MINIMUM
<p>LAZY YELLOW FLAME</p> 	<p>CHECK FOR LACK OF AIR FROM:</p> <ul style="list-style-type: none"> • LARGE ORIFICE • DIRTY LINT SCREEN, IF USED • DIRTY PRIMARY AIR OPENING, IF THERE IS ONE • PILOT ADJUSTMENT AT MINIMUM
<p>WAVING BLUE FLAME</p> 	<p>CHECK FOR:</p> <ul style="list-style-type: none"> • EXCESSIVE DRAFT AT PILOT LOCATION • RECIRCULATING PRODUCTS OF COMBUSTION
<p>NOISY LIFTING BLOWING FLAME</p> 	<p>CHECK FOR:</p> <ul style="list-style-type: none"> • HIGH GAS PRESSURE
<p>HARD SHARP FLAME</p> 	<p>THIS FLAME IS CHARACTERISTIC OF MANUFACTURED GAS</p> <p>CHECK FOR:</p> <ul style="list-style-type: none"> • HIGH GAS PRESSURE • ORIFICE TOO SMALL

PILOTSTAT SAFETY CONTROL POWER UNIT FAILURE

1. Ensure pilot flame is properly adjusted.
2. Ensure power unit connections clean and tight.
3. If power unit still fails to hold in, use the W129A Millivoltmeter to obtain the open and closed circuit voltage generated by the thermocouple or generator.
4. Compare measured open and closed circuit voltage values to Acceptable Range Charts in W129A Manual.
5. If W129A Millivoltmeter or other meter is not available, replace thermocouple or other meter is not available, replace thermocouple or other meter. If this does not correct the condition, replace power unit.

THERMOCOUPLE OR THERMOPILE PERFORMANCE

Thermocouples and thermopiles require proper temperature differential between the hot-junction (tip) and cold-junction (base) to provide satisfactory operation of gas controls. Thermocouples and thermopiles perform less effectively when exposed to excessive cold-junction or hot-junction temperatures.

Excessive cold-junction temperatures can be caused by heat radiation from adjacent surfaces or high ambient air temperatures. Excessive cold-junction temperatures can be eliminated by shielding the pilot flame, see Fig. 10, or constructing a baffle to direct secondary air over the pilot burner base.

Excessive hot-junction temperatures can be eliminated by proper pilot flame adjustment. To adjust pilot flame, see Adjust Pilot Flame section.

Fig. 10—Proper shielding of pilot flame.

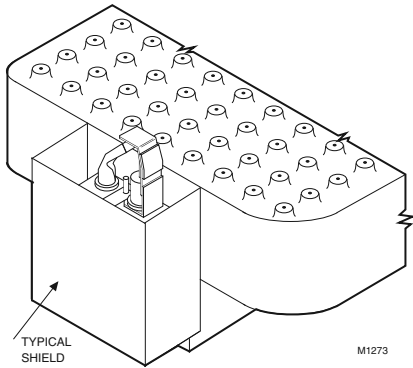



PILOT TURNDOWN TEST (30 mV safety control systems)

The Pilot Turndown Test assures that the pilot flame ignites the main burner within four seconds from the time gas reaches the main burner. In this test, the pilot flame is just sufficient enough to hold in the power unit or just above the point of flame extinction (whichever occurs at a higher pilot gas flow rate).

1. With the pilot and main burner operating, shut off the main burner by either lowering the thermostat temperature setting or turning the gas control knob to the PILOT position.

NOTE: If using a Honeywell W129A Millivoltmeter, turn the pilot gas adjustment screw until the thermocouple open circuit voltage is 2 mV. Omit steps 2,3, and 4 and proceed with step 5.

2. Turn the pilot gas adjustment screw clockwise until the pilot begins to decrease in size. Then, turn the pilot gas adjustment screw clockwise  1/4 turn a time (waiting one minute between each turn to allow the thermocouple to cool) until safety shutoff power unit just drops, causing safety shutdown.

3. Turn pilot gas adjustment screw counterclockwise slightly. 
4. Relight pilot burner. The power unit should hold in.
5. Turn gas control knob to ON position and set thermostat temperature setting above room temperature. Main burner should light within four seconds without flame rollout. If not, check pilot mounting and location instructions in Location section and repeat Pilot Turndown Test.
6. Readjust pilot burner flame. See Adjust Pilot Flame section.

EFFECTIVE IGNITION TEST (750 mV SYSTEMS)

The Effective Ignition Test assures that the pilot flame ignites the main burner within four seconds from the time gas reaches the main burner. In this test, the pilot flame is just sufficient to open the main gas valve.

1. Light the main burner according to the appliance manufacturer's instructions and allow to burn at least five minutes.

2. Remove one thermostat lead (TH) at the gas control terminal.

3. Using the pilot gas adjustment screw, decrease the pilot flame until it begins to pull away from the thermopile. Allow thermopile to cool for one minute.

4. Temporarily jumper the thermostat terminals (TH) on the gas control.

5. If the main burner ignites, reduce the pilot flame by turning the pilot adjustment screw 1/4 turn at a time until the valve fails to pull in. Allow the thermocouple to cool at least one minute between each reduction in the pilot flame level.

6. Increase the pilot flame just enough to pull in the gas control main valve.

7. Jumper the thermostat terminals. The main burner should light within four seconds and without flame roll-out. If it does not, check the Location and Mounting instructions on page 1 and repeat steps 1 through 6.

8. If main burner still does not light, replace thermopile and repeat steps 1 through 6.

9. Remove the jumper to shut off the main burner.

10. Readjust pilot burner flame. See Adjust Pilot Flame section.

11. Reconnect the thermopile lead and ensure all connections are correct and the system is functioning properly.

Honeywell

Helping You Control Your World

Home and Building Control

Honeywell Inc.
1985 Douglas Drive North
Golden Valley, MN 55422

Home and Building Control

Honeywell Limited—Honeywell Limitée
740 Ellesmere Road
Scarborough, Ontario
M1P 2V9



QUALITY IS KEY

Printed in U.S.A.