

### Features

- End drain.
- Integral lumbar support.
- 71-3/4" (1822 mm) x 36" (914 mm) x 20-7/8" (530 mm)

### Material

- Cast iron with Safeguard® finish.

### Hydrotherapy

- Six fully adjustable Flexjet™ hydrotherapy jets for water flow and direction.
- Built-in 1500 W heater.
- Two pulsating neckjets with pillows.

### Installation

- Drop-in or alcove.

### Required Accessories

- K- 7169-AF 1-1/2" Contoured Pop-up Drain
- K- 9696 Whirlpool 6-Jet Trim Kit

### Recommended Accessories

- K- 1179 Vinyl Tiling-in Bead
- K- 582 Under-mount Installation Kit



### Codes/Standards











ASME A112.19.1/CSA B45.2  
ASME A112.19.7/CSA B45.10  
UL 1795  
CSA C22.2 No. 218.2  
CARB P2

### KOHLER® Lifetime Limited Warranty for Cast Iron Components

See website for detailed warranty information.

### Available Color/Finishes

*Color tiles intended for reference only.*

Color	Code	Description
	0	White
	96	Biscuit
	47	Almond
	NY	Dune
	95	Ice™ Grey
	G9	Sandbar
	33	Mexican Sand™
	K4	Cashmere
	58	Thunder™ Grey
	7	Black Black™

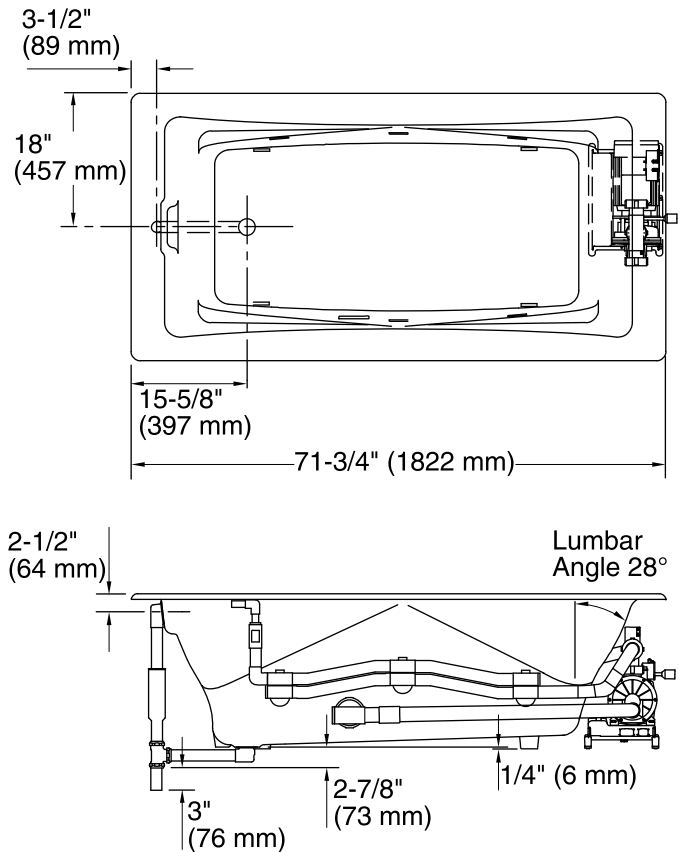

No change in measurements if connected with drain illustrated. (K-7169-AF)

Pump/Control Access  
34" (864 mm) W x 15" (381 mm) H

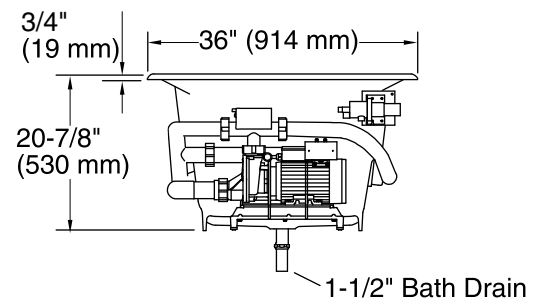

### Required Electrical Service

One dedicated circuit required, protected with Class A Ground-Fault Circuit-Interrupter (GFCI) or Residual Current Device (RCD).

Pump, Heater: 240 V, 20 A, 50/60 Hz

### Technical Information

All product dimensions are nominal.

Installation:	Drop-in, 3-Wall Alcove
Drain location:	End
Basin area, bottom:	49" x 22" (1245 mm x 559 mm)
Basin area, top:	62" x 28" (1575 mm x 711 mm)
Weight:	455 lbs (206.4 kg)
Minimum floor load:	69 lbs/ft <sup>2</sup> (336.9 kg/m <sup>2</sup> )
Water depth:	17" (432 mm)
Water capacity:	89 gal (336.9 L)
Cutout:	Drop-in, 70-1/4" x 34-1/2" (1784 mm x 876 mm)
Electrical component rating:	Pump: 240 V, 11 A Heater: 240 V, 6 A, 1500 W
Pump speed:	Variable

### Notes

Measure your actual product for rough-in details.

Install this product according to the installation instructions.

The hot water supply should be 70% of the capacity of the bath or greater. Installations will vary.

Cast iron whirlpools are extremely heavy, making some drop-in installations difficult. Splitting the deck/surround is recommended if installing into a deck.