

Basin Wrenches

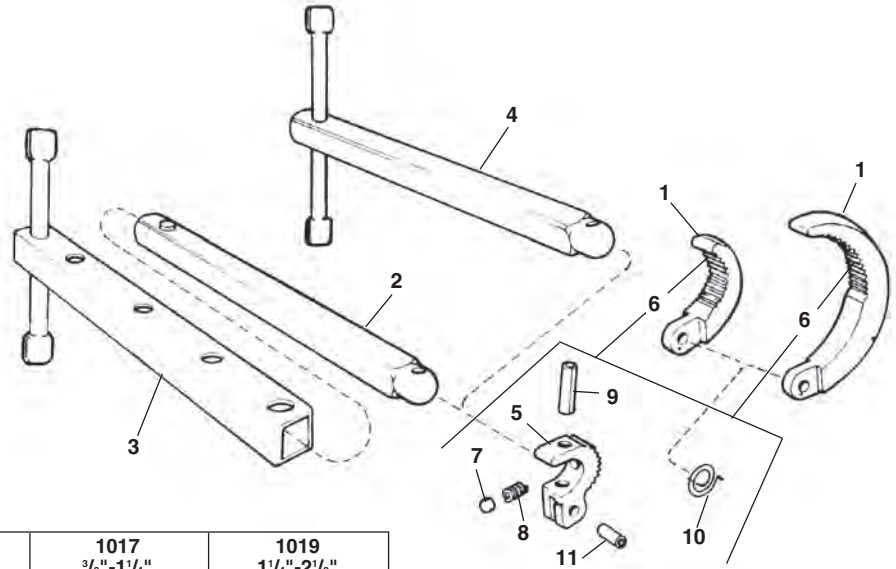

**NOTE: Order parts by Catalog Number only.
DO NOT order by Reference Number.**

Ref. No.	Description	1010	1017	1019
		3/8"-1 1/4"	3/8"-1 1/4"	1 1/4"-2 1/2"
Ref. No.	Description	Catalog No.	Catalog No.	Catalog No.
—	Basin Wrench	31170	31175	31180
1	Swing Jaw	32740	32740	32770
2	Slide Bar Assembly	—	32765	32765
3	Sleeve & Handle Assembly	—	32705	32720
4	Handle Assembly	32700	—	—
5	Fixed Jaw	32710	32710	32710
6	Jaw Assembly	32715	32715	32725
7	Tension Plug	32755	32755	32755
8	Coil Spring	32745	32745	32745
9	Spring Pin	32760	32760	32760
10	Spiral Spring	32730	32730	32730
11	Spring Pin	32475	32475	32475

2017 Basin Wrench

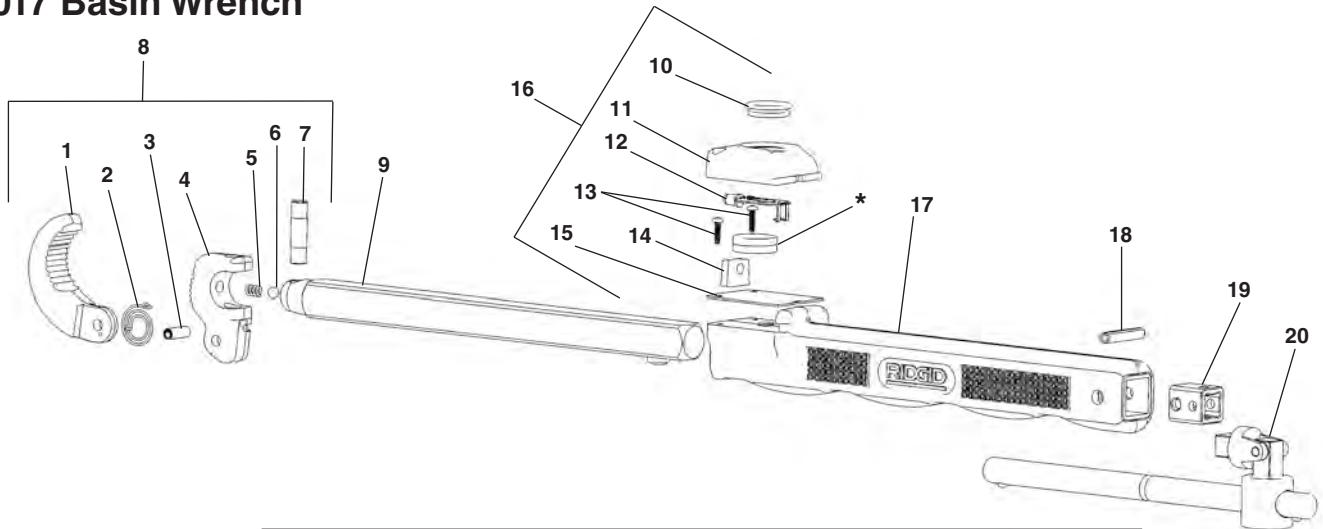

Ref. No.	Catalog No.	Description	Ref. No.	Catalog No.	Description
1	32740	Swing Jaw	11	48238	Battery Cover
2	32730	Spiral Spring	12	48243	Light PCB
3	32475	Spiral Pin .188OD x .50L	13	48258	Battery Cover Screws (2)
4	32710	Fixed Jaw	14	49503	Grommet
5	32745	Compression Spring	15	49508	Gasket
6	32755	Tension Plug 3/8"	16	48263	Battery Cover Assembly
7	32760	Groove Pin	17	48268	Sleeve Assembly
8	32715	Jaw Assembly	18	36387	Roll Pin
9	32765	Slide Bar Assembly	19	48273	Handle Adapter
10	48233	Light Button	20	48283	T-Handle Assembly

*CR2032 Batteries Required (2)