

DV Installation Instructions
English

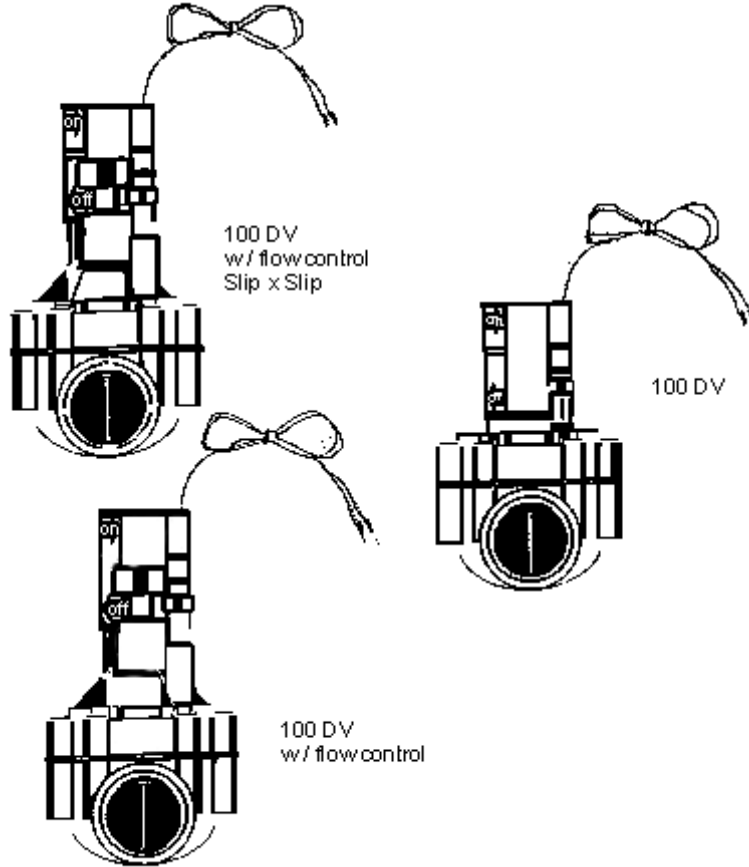

CONTENTS:

<input type="checkbox"/> General Information	2
<input type="checkbox"/> Tips on Installation	2
<input type="checkbox"/> Installation Steps	3
<input type="checkbox"/> Wiring the Valve	4
<input type="checkbox"/> Determining Valve Wire Size	5
<input type="checkbox"/> Manually Activating the System	6
<input type="checkbox"/> Trouble Shooting Guide	7
<input type="checkbox"/> Flow Control Stem	8
<input type="checkbox"/> Filters	8
<input type="checkbox"/> Winterization	8

GENERAL INFORMATION

THE DV SERIES OF VALVES OFFERS AN ARRAY OF PRODUCTS in both sizes and features to meet the standard installation needs for residential and light commercial irrigation requirements.

- The valves offered are a ¾" (20/27) non-flow control valve and a series of 1" (26/34) valves with or without flow control and threaded or slip x slip configurations on the inlet and outlet ports. The combination of forms available offers maximum versatility to the installing contractor.
- The ¾" valve should be used on laterals with flow rates of 3 to 22 GPM (0.75 to 5.0 m³/h or 11.4 to 83.4 L/m) or may be used on a drip master valve set-up with an RBY-075-200MX filter at flow rates as low as .2 GPM (0.05 m³/h or 0.8 L/m).
- The 1" valve series may be used on laterals with flows of 3 to 40 GPM (0.75 to 10 m³/h or 11.4 to 151.6 L/m).
- In either ¾" or 1" size, it is recommended that velocities be kept below 51/2 ft./sec. (1.68 m/sec.) DV valves will perform in an operating range of 15 to 150psi (1 to 10 bars or 100 to 1.000 kPa.).

TIPS ON INSTALLATION

Adequately flush the main water source prior to plumbing in the valves

VALVES ARE NOT BACK FLOW PREVENTION DEVICES. You will need to in-stall the appropriate device as mandated by local ordinance prior to the installation of the irrigation valve. Ensure that the selected device offers adequate flow and pressure to the downstream portion of the system to operate the sprinklers.

- Local practice may also dictate the installation of a master valve or isolation shut off valve prior to installation of the DV valve. This will be very useful in shutting down a portion of the irrigation system without affecting the entire system.
- Check the electrical specifications of the controller being in-stalled on the job to ensure that you have adequate inrush and holding current to electrically activate the valves. This is particularly important if you intend to wire more than one valve to a controller station. The DV solenoid is rated at .30 A. 24 VAC (7.2 VA) inrush and .19 A. 24 VAC (4.6 VA) holding current to maintain activation of the solenoid for the scheduled run time. Except for the EZ-1, all Rain Bird controllers will allow you to run two valves plus a master valve at one time. The EZ-1 allows one valve plus a master or two valves without a master valve.
- Local practice will dictate standard installation procedures. However, it is always recommended that valves be installed in a valve box to allow access if servicing is required. This process will also allow easier identification of where the valves are actually installed on the job site.

INSTALLATION STEPS

Adequately flush the main water source prior to plumbing in the valves

TAKE ALL NECESSARY STEPS TO CONNECT TO YOUR PRIMARY WATER SOURCE. Install master valves, isolation valves

- Notice the directional arrows on the inlet and outlet ports which indicate the flow path of the water. Valves cannot be reversed. Ensure that you are installing the valve correctly. As a hint, you will find that the solenoid is always positioned on the downstream side of the valve where the water will be exiting to service the sprinklers.
- The standard 3/4" and 1" DV comes with female threads. Use a 3/4" or 1" male by slip adapter to connect the valve to the water source. Use two wraps of teflon tape on the male threads of the adapters and screw them into the two water ports of the valve. Finger tighten the adapters into position and then turn one to two additional turns using a wrench to ensure water tight connections.
- Do not over tighten the adapter, or you could force the adapter to extrude over the solenoid exit port. The valve will not activate in this condition. Once properly attached, glue the slip portion of the adapter into the supply side pipe. Complete this step for all valves on a given master or isolation valve.
- The DV S x S eliminates the need for the adapter. In this case, simply glue the pipe directly into the supply side pipe. Use only minimal primer and glue to eliminate possible contamination of the valve ports from glue residue.
-
- In cold weather climates, it is more common to use poly pipe. Use appropriate installation techniques as specified by the manufacturer to properly attach and secure the poly adapter to the valve. Local practice will dictate the number of clamps used to secure the adapter.
- Slowly charge the water supply system to the installed valves. When water first enters the system, the valves will open until the upper diaphragm chamber charges and shuts down the valve.

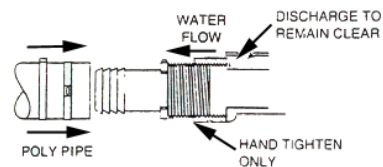
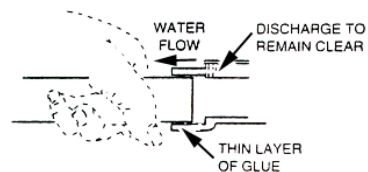
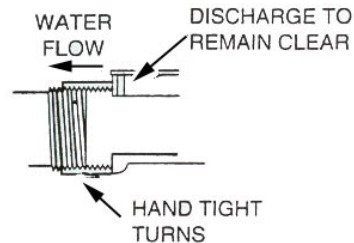
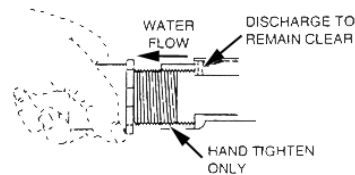
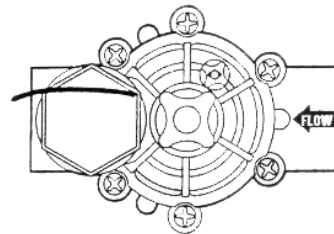

WIRING THE VALVE

THE DV SOLENOID COMES WITH TWO LEAD WIRES, BOTH BLACK. Either one may be used as the common or as the hot wire back to the controller.

- Select a wire gauge which will allow you to run back to the controller with minimal loss (see table on the next page). Most of-ten, multi-strand, direct burial wire will be preferable.
- All valves going back to the same controller can utilize the same common wire. If the valves are mainfolded, simply wire the valves together using water tight connectors and run one common wire back to the controller. If the valves are separated, run one common line and slice it to the remote valve common at each location.
- Each individual station must be wired separately to activate. Select a wire color and use a water tight electrical connector to wire the valve back to the controller. This wire runs directly from the valve back to the controller and is not ganged with any other wires. The use of Rain Bird ST-03 waterproof connectors are recommended for all water tight connections.
- Hook up all wires back into the controller by positioning a hot wire for each valve onto a controller terminal strip and connecting all the commons back to the correct position on the controller.

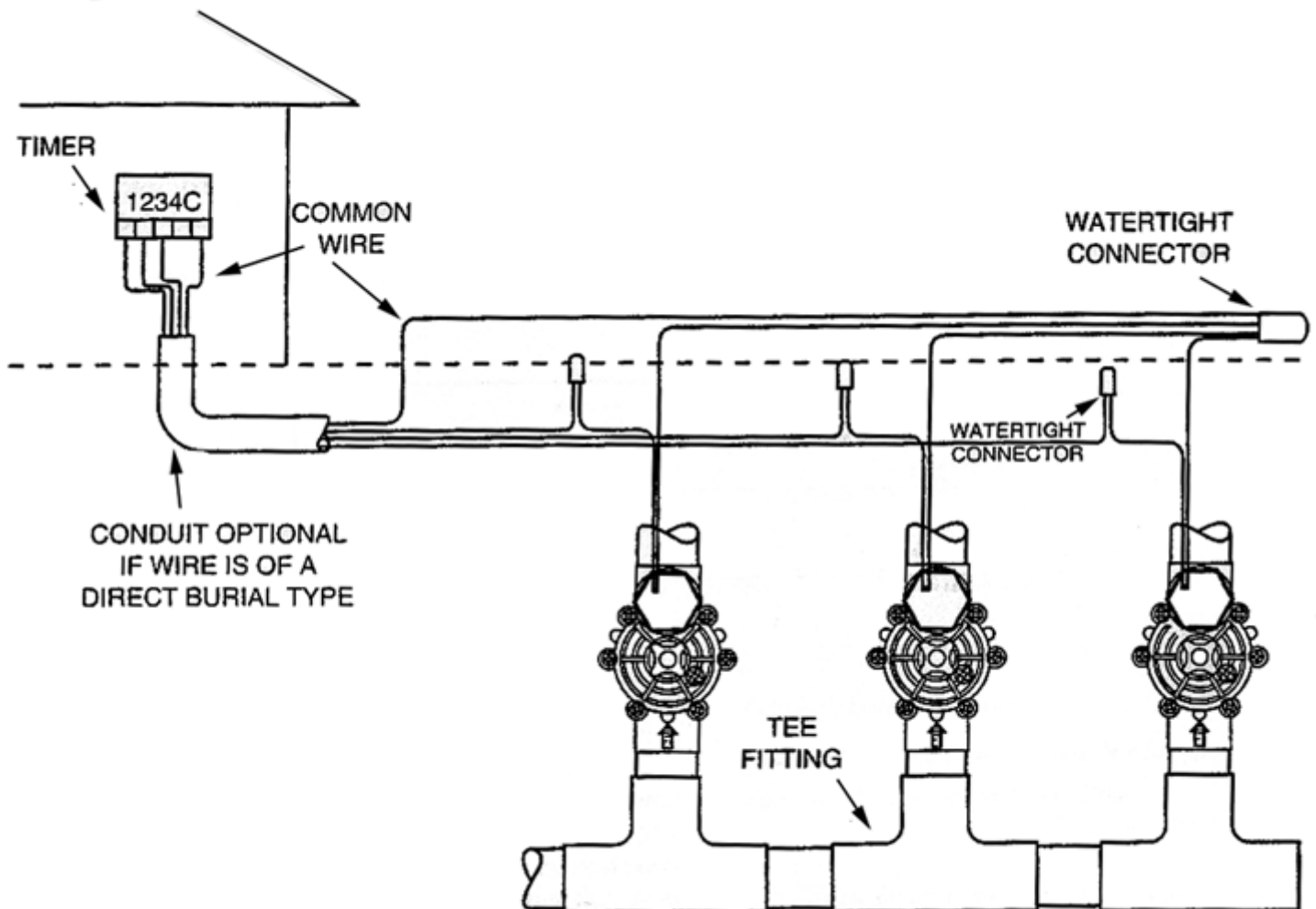

DETERMINING VALVE WIRE SIZES

DETERMINE ACTUAL DISTANCE, along wire run, from controller out to the first valve on a circuit and between each succeeding valve on a multiple valve circuit (as show in the example below).

Calculate the equivalent circuit length for each valve circuit on the controller.

Example: Solenoid elec. control valves with 24 VAC transformer controllers, with 150 psi water pressure at valves.

Equivalent Length Calculations:

Station #1 - Equivalent Length = 1 valve x 200 ft. = 200 ft.

Station #2 - Equivalent Length = (1 valve x 100 ft.) + (2 valves x 300 ft.) =700 ft.

Selecting Common Ground Wire Size - Using longest equivalent length calculated above, go to the appropriate valve chart (based on transformer voltage, 24 VAC, and water pressure at valve) and select ground wire and control wire combination that are as near the same size as possible (ground wire size should always be equal to - or one size larger than. the control wire size.)

In the example above, circuit for station #2 has longest equivalent length of 700 feet. In chart (for this example use high pressure chart for 150 psi water pressure at valve and 24 VAC transformer) select a wire size combination of size 16 and 18 wire. Select common ground wire as size 16 wire. Since one common ground wire shall be used for all valves on the controller, you have established the common ground wire size for that controller of size 16 wire.

Sizing Circuit Wires - Using the common ground wire selected (size #16)- proceed to select each control wire size from the chart, using the calculated equivalent length for each circuit.

Station # 1 - Equivalent Length = 1 valve x 200 ft. = 200 ft. Select size # 18 control wire.

Station #2 - Equivalent Length = 1 valve x 700 ft. = 700 ft. Select size # 18 control wire.

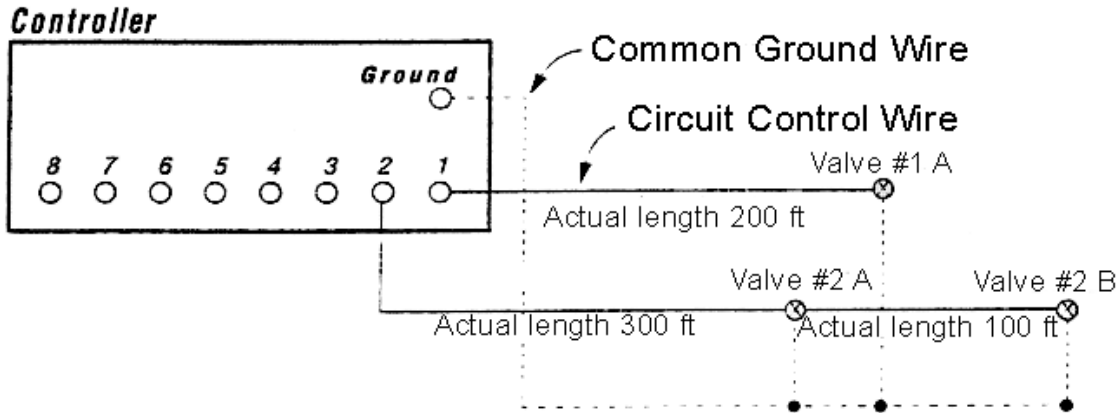

24 VAC

	150 PSI CONTROL WIRE SIZE				125 PSI CONTROL WIRE SIZE				100 PSI CONTROL WIRE SIZE				80 PSI CONTROL WIRE SIZE						
	18	16	14	12	18	16	14	12	18	16	14	12	18	16	14	12			
18	600	730	860	960	18	1400	1720	2000	2240	18	2300	2820	3290	3680	18	3000	3680	4290	4800
16	730	950	1170	1370	16	1720	2200	2730	3190	16	2820	3660	4490	5240	16	3680	4770	5850	6840
14	860	1170	1510	1860	14	2000	2730	3530	4340	14	3290	4490	5800	7130	14	4290	5850	7570	9300
12	960	1370	1860	2410	12	2240	3190	4340	5620	12	3680	5240	7130	9240	12	4800	6840	9300	12050

MANUALLY ACTIVATING THE SYSTEM

THE DV VALVE SERIES OFFERS TWO WAYS OF MANUALLY ACTIVATING THE SYSTEM.

- The solenoid allows manual activation of the system with internal downstream bleed. Utilizing this method will eliminate water in the valve box. On the side of the solenoid arrows indicate the on and off position. You need turn only $\frac{1}{4}$ turn CCW to manually activate the valve using the solenoid. Since the solenoid seat is subject to system pressure, it may be difficult to turn in high pressure situations. Turn $\frac{1}{4}$ turn CW to close the valve after flushing.
- The external bleed screw offers an alternative manual option. Because it is assisted by the pressure of the system, it may be easier to engage than the solenoid under high pressures. It is located on top of the bonnet assembly and may be turned to activate the valve. You will only need to turn it one turn before water starts to exit the valve directly below the bleed screw. Do not turn any further as the screw is not captive and could come out.
- Use the external bleed screw to flush the valve prior to electrically activating it. Continue piping the system until completion of the valve installation. Activate the valves electrically from the controller to ensure proper functioning.

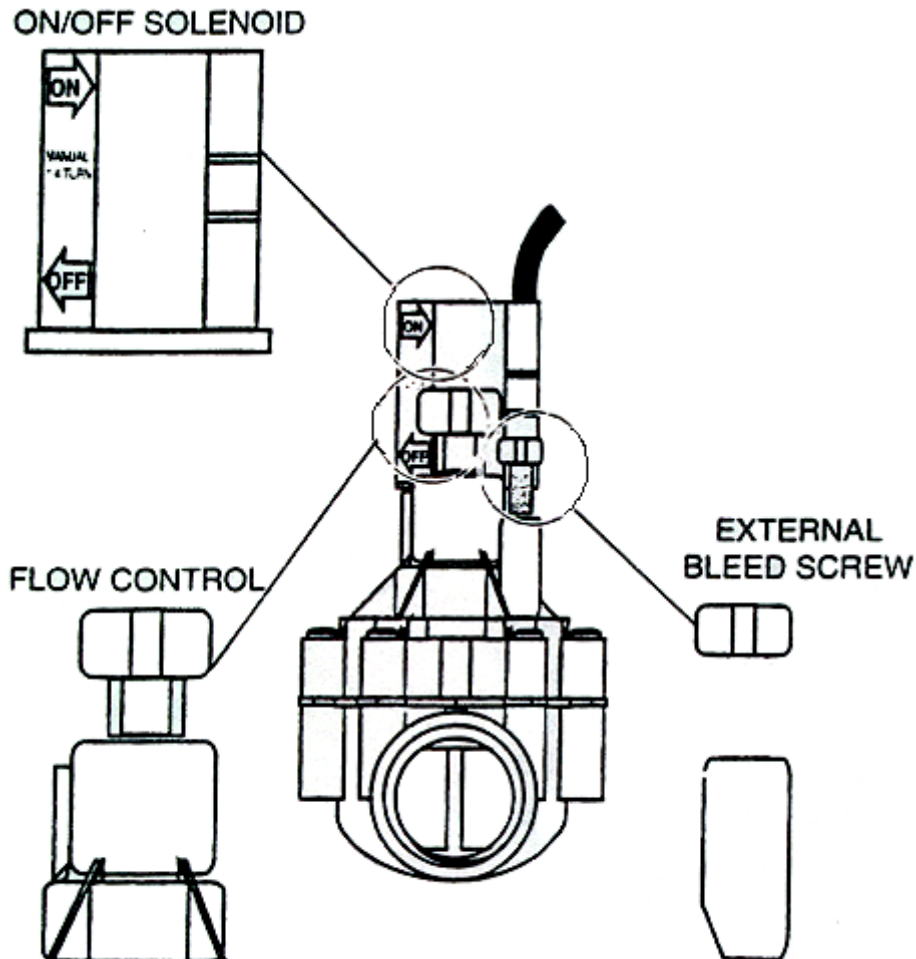

TROUBLE SHOOTING GUIDE

WATER WILL NOT SHUT OFF	
Time setting is incorrect at controller	Reset watering time
Valve in manual "ON" position	Tighten solenoid. Tighten bleed screw
Diaphragm filter blocked	Turn water off. Remove bonnet screws. Clean filter or replace with 210746 diaphragm kit
Dirty or damaged solenoid	Turn water off. Clean or replace solenoid
WATER LEAKS THROUGH SPRINKLER WHEN "OFF"	
Dirt on diaphragm	Use bleed screw to manually flush the valve.
Valve in manual "ON" position	Tighten solenoid. Tighten bleed screw
Solenoid O-ring damaged or twisted	Turn water off. Inspect O-ring. Reinstall or replace O-ring
Diaphragm damaged	Turn water off. Remove bonnet screws. Replace diaphragm with 210746 kit if damaged
Dirt in solenoid	Turn water off. Remove solenoid, solenoid filter and plunger retainer, clean. Replace solenoid if damaged
Water leaking from bonnet	Tighten bonnet screws
VALVE WILL NOT TURN "ON" ELECTRICALLY	
Controller power off	Turn controller power on
Station not on	See controller instructions
Water supply is off	Turn water supply on
Damaged solenoid	Turn water off. Without disconnecting wires, swap solenoid with a good valve and retest with water on. Replace solenoid or repair field wiring if necessary
Male pipe adapter overtightened on valve outlet side	Turn water off. Remove solenoid. Check for blockage of dump port passage by inserting paperclip. If blocked, reinstall male pipe adapter
Flow control stem not open	Open flow control stem
LOW OR INADEQUATE FLOW THROUGH VALVE	
Water running elsewhere reducing pressure	Water when supply pressure is higher
Too many sprinklers on circuit	Remove some sprayhead(s) from circuit until pressure increases
Upstream gate valve not fully open	Open gate valve fully
Flow control stem not open (DVF)	Open flow control stem

FLOW CONTROL SYSTEM

THE FLOW CONTROL STEM ALLOWS YOU TO REDUCE VALVE OUTPUT PRESSURE by turning down the stem until the desired effect is seen in the sprinkler operation. You may turn the handle with your fingers or use a slotted screwdriver.

FLOW CONTROL



FILTERS

THE DV SERIES HAS TWO FILTERS IN THE WATER FLOW PATH TO REDUCE PLUGGING OF THE VALVE PORTS.

- One filter is on the diaphragm to filter the upper chamber supply water. Do not remove the diaphragm filter because the valve will not operate. The other filter is in the solenoid to prevent plug-ging of the solenoid ports and to keep debris off the plunger if the solenoid is removed. Both filters are sized to allow the proper flow of water to achieve the desired hydraulic effects.

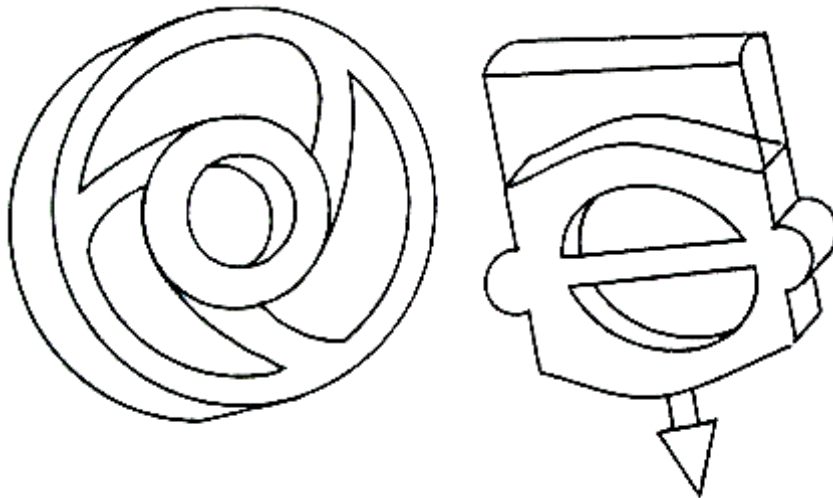

WINTERIZATION

AS WITH ALL IRRIGATION COMPONENTS, it is important to properly winterize the valves prior to the first hard freeze. Local practices will dictate how this is done, but blowing the system generally provides the best protection. Failure to properly winterize may result in damage to the valves as water captured in the valves freezes.

- Compressed air source should not exceed 60 psi.
- Upon completion of the winterization process, move the controller to the stand-by mode.



Rain Bird Sales, Inc.
Customer Support Center
6640 S. Bonney Ave.
Tucson, AZ 85706

1-800-RAIN BIRD

FAX (520) 434-6289

© 2000 Rain Bird Sprinkler Mfg. Corp.

® Registered Trademark of Rain Bird Sprinkler Mfg. Corp.