

COMMERCIAL GAS WATER HEATERS



500 Tennessee Waltz Parkway
Ashland City, TN 37015



**MODELS SBD71120(N,P)E thru
SBD100390(N,P)E
SERIES 118/119**

**INSTALLATION - OPERATION - SERVICE
- MAINTENANCE - LIMITED WARRANTY**



WARNING: If the information in these instructions is not followed exactly, a fire or explosion may result causing property damage, personal injury or death.

- Do not store or use gasoline or other flammable vapors and liquids in the vicinity of this or any other appliance.
- **WHAT TO DO IF YOU SMELL GAS:**
 - Do not try to light any appliance.
 - Do not touch any electrical switch; do not use any phone in your building.
 - Immediately call your gas supplier from a neighbor's phone. Follow the gas supplier's instructions.
 - If you cannot reach your gas supplier, call the fire department.
- Installation and service must be performed by a qualified installer, service agency or the gas supplier.

Thank you for buying this energy efficient water heater.
We appreciate your confidence in our products.



⚠ WARNING

Read and understand this instruction manual and the safety messages herein before installing, operating or servicing this water heater.

Failure to follow these instructions and safety messages could result in death or serious injury.

This manual must remain with the water heater.

PLACE THESE INSTRUCTIONS ADJACENT TO HEATER AND NOTIFY OWNER TO KEEP FOR FUTURE REFERENCE.

TABLE OF CONTENTS

TABLE OF CONTENTS.....	2	Outdoor Air Through Two Horizontal Ducts	17
SAFE INSTALLATION, USE AND SERVICE.....	3	Outdoor Air Through Two Vertical Ducts.....	18
APPROVALS	3	Air From Other Indoor Spaces.....	18
GENERAL SAFETY INFORMATION.....	4	Mechanical Venting	21
Precautions.....	5	WATER HEATER INSTALLATION.....	21
Grounding Instructions	5	Water Line Connections	21
Hydrogen Gas Flammable.....	5	T&P Valve Discharge Pipe.....	21
INTRODUCTION	6	Installation Diagrams - Top Inlet/Outlet Usage	22
Abbreviations Used	6	Heater Wiring.....	23
Qualifications	6	Gas Piping.....	24
Preparing For The Installation	6	Gas Line Leak Testing.....	24
FEATURES AND COMPONENTS	7	Purging	24
The Hydrocannon (self-cleaning system).....	7	Prior To Start Up	25
High Limit Switch.....	7	OPERATION.....	25
Automatic Flue Damper.....	7	SEQUENCE OF OPERATION	25
Uncrating	7	Lighting & Operation Label.....	27
INSTALLATION CONSIDERATIONS	8	Adjustments.....	29
Rough In Dimensions	8	Checking Venting.....	29
Locating The Water Heater.....	10	Checking The Input.....	29
Clearances	10	Venting System.....	31
NSF Leg Kit	11	Remote Storage Tank Temperature Control	31
Insulation Blanket	11	Temperature-Pressure Relief Valve Test	31
Hard Water	11	Anode Rod Inspection	31
Circulation Pumps	11	MAINTENANCE	31
High Altitude Installations	12	Draining And Flushing	32
INSTALLATION REQUIREMENTS	13	Recommended Procedure For Periodic Removal Of Lime Deposits From Tank Type Commercial Water Heaters	32
Gas Supply Systems	13	Delimiting Solvents.....	33
Supply Gas Regulator	13	Tank Cleanout Procedure.....	33
Power Supply	13	Delimiting Using Flo-Jug Method	33
Water Temperature Control And Mixing Valves	13	Pilot Burner.....	34
Dishwashing Machines.....	14	Main Burner.....	35
Closed Water Systems	14	Gas Control Valve.....	35
Thermal Expansion.....	14	Electrical Servicing	35
Temperature-Pressure Relief Valve.....	14	SERVICE.....	35
Contaminated Air.....	15	Ignition Module	36
Air Requirements.....	15	Flue Damper.....	36
VENTING INSTALLATION	16	TROUBLESHOOTING	36
Unconfined Space	16	TROUBLESHOOTING CHECKLIST	38
Confined Space	16	Start Up Conditions	39
Venting.....	16	Operational Conditions	39
Vent Reducer.....	16	FOR YOUR INFORMATION.....	39
Multiple Heater Manifold.....	17	WATER PIPING DIAGRAMS.....	40
Fresh Air Openings For Confined Spaces.....	17	MANIFOLD KITS.....	55
Outdoor Air Through Two Openings	17	NOTES	56
Outdoor Air Through One Opening.....	17	WARRANTY	59

SAFE INSTALLATION, USE AND SERVICE

The proper installation, use and servicing of this water heater is extremely important to your safety and the safety of others. Many safety-related messages and instructions have been provided in this manual and on your own water heater to warn you and others of a potential injury hazard. Read and obey all safety messages and instructions throughout this manual. It is very important that the meaning of each safety message is understood by you and others who install, use, or service this water heater.

	<p>This is the safety alert symbol. It is used to alert you to potential personal injury hazards. Obey all safety messages that follow this symbol to avoid possible injury or death.</p>
--	---

	<p>DANGER indicates an imminently hazardous situation which, if not avoided, will result in injury or death.</p>
	<p>WARNING indicates a potentially hazardous situation which, if not avoided, could result in injury or death.</p>
	<p>CAUTION indicates a potentially hazardous situation which, if not avoided, could result in minor or moderate injury.</p>
	<p>CAUTION used without the safety alert symbol indicates a potentially hazardous situation which, if not avoided, could result in property damage.</p>

All safety messages will generally tell you about the type of hazard, what can happen if you do not follow the safety message, and how to avoid the risk of injury.

APPROVALS



HLW



WATER QUALITY



LOW LEAD CONTENT

GAS-FIRED



LISTED

Note: ASME construction is optional on the water heaters covered in this manual.

GENERAL SAFETY INFORMATION

WARNING

Fire or Explosion Hazard

- Do not store or use gasoline or other flammable vapors and liquids in the vicinity of this or any other appliance.
- Avoid all ignition sources if you smell gas.
- Do not expose water heater controls to excessive gas pressure.
- Use only the gas shown on the water heater rating label.
- Maintain required clearances to combustibles.
- Keep ignition sources away from faucets after extended periods of non-use.



Read instruction manual before installing, using or servicing water heater.



WARNING

Fire Hazard

For continued protection against risk of fire:

- Do not install water heater on carpeted floor.
- Do not operate water heater if any part has been exposed to flooding or water damage.



WARNING

Fire and Explosion Hazard

- Use joint compound or Teflon tape compatible with propane gas.
- Leak test before placing the water heater in operation.
- Disconnect gas piping and main gas shutoff valve before leak testing.
- Install sediment trap in accordance with NFPA 54.



WARNING

Breathing Hazard - Carbon Monoxide Gas



- Install vent system in accordance with codes.
- Do not operate water heater if flood damaged.
- High altitude orifice must be installed for operation above 2,000 feet (610 m).
- Do not operate if soot is present.
- Do not obstruct water heater air intake with insulating jacket.
- Do not place chemical vapor emitting products near water heater.
- Gas and carbon monoxide detectors are available.

Breathing carbon monoxide can cause brain damage or death. Always read and understand instruction manual.

WARNING

Fire and Explosion Hazard

- Do not use water heater with any gas other than the gas shown on the rating label.
- Excessive gas pressure to gas valve can cause serious injury or death.
- Turn off gas lines during installation.
- Contact a qualified installer or service technician for installation and service.



CAUTION

Property Damage Hazard

- All water heaters eventually leak.
- Do not install without adequate drainage.

WARNING

Electrical Shock Hazard



- Turn off power to the water heater before performing any service.
- Label all wires prior to disconnecting when performing service. Wiring errors can cause improper and dangerous operation.
- Verify proper operation after servicing.
- Failure to follow these instructions can result in personal injury or death.

WARNING

Jumping out control circuits or components can result in property damage, personal injury or death.

- Service should only be performed by a qualified service technician using proper test equipment.
- Altering the water heater controls and/or wiring in any way could result in permanent damage to the controls or water heater and is not covered under the limited warranty.
- Altering the water heater controls and/or wiring in any way could result in altering the ignition sequence allowing gas to flow to the main burner before the hot surface igniter is at ignition temperature causing delayed ignition which can cause a fire or explosion.

Any bypass or alteration of the water heater controls and/or wiring will result in voiding the water heater warranty.



GENERAL SAFETY INFORMATION



⚠️ WARNING

Read and understand this instruction manual and the safety messages herein before installing, operating or servicing this water heater.

Failure to follow these instructions and safety messages could result in death or serious injury.

This manual must remain with the water heater.



⚠️ WARNING

Explosion Hazard

- Overheated water can cause water tank explosion.
- Properly sized temperature and pressure relief valve must be installed in the opening provided.

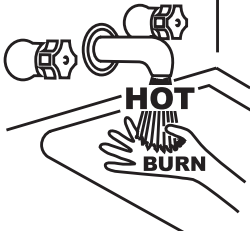

⚠️ DANGER

Water temperature over 125°F (52°C) can cause severe burns instantly resulting in severe injury or death.

Children, the elderly and the physically or mentally disabled are at highest risk for scald injury.

Feel water before bathing or showering.

Temperature limiting devices such as mixing valves must be installed when required by codes and to ensure safe temperatures at fixtures.

CAUTION

Improper installation, use and service may result in property damage.

- Do not operate water heater if any part has been exposed to flooding or water damage.
- Inspect anode rods regularly, replace if damaged.
- Install in location with drainage.
- Fill tank with water before operation.
- Properly sized thermal expansion tanks are required on all closed water systems.

Refer to this manual for installation and service.

Verify the power to the water heater is turned off before performing any service procedures.

PRECAUTIONS

DO NOT USE THIS WATER HEATER IF ANY PART HAS BEEN EXPOSED TO FLOODING OR WATER DAMAGE. Immediately call a qualified service technician to inspect the water heater and to make a determination on what steps should be taken next.

If the unit is exposed to the following, do not operate heater until all corrective steps have been made by a qualified service technician.

1. External fire.
2. Damage.
3. Firing without water.

GROUNDING INSTRUCTIONS

This water heater must be grounded in accordance with the National Electrical Code and/or local codes. These must be followed in all cases.

This water heater must be connected to a grounded, permanent wiring system; or an equipment grounding conductor must be run with the circuit conductors and connected to the equipment grounding terminal or lead on the water heater, see Figure 20.

HYDROGEN GAS FLAMMABLE



⚠️ WARNING

Explosion Hazard

- Flammable hydrogen gases may be present.
- Keep all ignition sources away from faucet when turning on hot water.

Hydrogen gas can be produced in a hot water system served by this water heater that has not been used for a long period of time (generally two weeks or more). Hydrogen gas is extremely flammable. To reduce the risk of injury under these conditions, it is recommended that a hot water faucet served by this water heater be opened for several minutes before using any electrical appliance connected to the hot water system. If hydrogen is present there will probably be an unusual sound such as air escaping through the pipe as the water begins to flow. THERE SHOULD BE NO SMOKING OR OPEN FLAME NEAR THE FAUCET AT THE TIME IT IS OPEN.

INTRODUCTION

Thank You for purchasing this water heater. Properly installed and maintained, it should give you years of trouble free service.

ABBREVIATIONS USED

Abbreviations found in this Instruction Manual include :

- ANSI - American National Standards Institute
- ASME - American Society of Mechanical Engineers
- AHRI - Air-Conditioning, Heating and Refrigeration Institute
- NEC - National Electrical Code
- NFPA - National Fire Protection Association
- UL - Underwriters Laboratory
- CSA - Canadian Standards Association

QUALIFICATIONS

QUALIFIED INSTALLER OR SERVICE AGENCY

Installation and service of this water heater requires ability equivalent to that of a Qualified Agency (as defined by ANSI below) in the field involved. Installation skills such as plumbing, air supply, venting, gas supply and electrical supply are required in addition to electrical testing skills when performing service.

ANSI Z223.1 2006 Sec. 3.3.83: "Qualified Agency" - "Any individual, firm, corporation or company that either in person or through a representative is engaged in and is responsible for (a) the installation, testing or replacement of gas piping or (b) the connection, installation, testing, repair or servicing of appliances and equipment; that is experienced in such work; that is familiar with all precautions required; and that has complied with all the requirements of the authority having jurisdiction."

If you are not qualified (as defined by ANSI above) and licensed or certified as required by the authority having jurisdiction to perform a given task do not attempt to perform any of the procedures described in this manual. If you do not understand the instructions given in this manual do not attempt to perform any procedures outlined in this manual.

PREPARING FOR THE INSTALLATION

1. Read the "General Safety" section, page 4-5 of this manual first and then the entire manual carefully. If you don't follow

the safety rules, the water heater will not operate properly. It could cause DEATH, SERIOUS BODILY INJURY AND/OR PROPERTY DAMAGE.

This manual contains instructions for the installation, operation, and maintenance of the gas-fired water heater. It also contains warnings throughout the manual that you must read and be aware of. All warnings and all instructions are essential to the proper operation of the water heater and your safety. Since we cannot put everything on the first few pages, **READ THE ENTIRE MANUAL BEFORE ATTEMPTING TO INSTALL OR OPERATE THE WATER HEATER.**

2. The installation must conform with these instructions and the local code authority having jurisdiction. In the absence of local codes, the installation must comply with the current editions of the National Fuel Gas Code, ANSI Z223.1/NFPA 54 or CAN/CSA-B149.1 the Natural Gas and Propane Installation Code. All documents are available from the Canadian Standards Association, 8501 East Pleasant Valley Road, Cleveland, OH 44131. NFPA documents are also available from the National Fire Protection Association, 1 Batterymarch Park, Quincy, MA 02269.
3. If after reading this manual you have any questions or do not understand any portion of the instructions, call the local gas utility or the manufacturer whose name appears on the rating plate.
4. Carefully plan the place where you are going to put the water heater. Correct combustion, vent action, and vent pipe installation are very important in preventing death from possible carbon monoxide poisoning and fires.
Examine the location to ensure the water heater complies with the "Locating the New Water Heater" section in this manual.
5. For California installation this water heater must be braced, anchored, or strapped to avoid falling or moving during an earthquake. See instructions for correct installation procedures. Instructions may be obtained from California Office of the State Architect, 400 P Street, Sacramento, CA 95814.
6. Massachusetts Code requires this water heater to be installed in accordance with Massachusetts 248-CMR 2.00: State Plumbing Code and 248-CMR 5.00.

FEATURES AND COMPONENTS

THE HYDROCANNON (SELF-CLEANING SYSTEM)

These units include The Hydrocannon (Self-Cleaning System) installed in the front water inlet. See Figure 1. The Hydrocannon inlet tube can only be used in the front water inlet connection. Do not install the Hydrocannon inlet tube in either the top or back inlet water connection. The Hydrocannon must be oriented correctly for proper function. There is a marked range on pipe nipple portion of the Hydrocannon, that must be aligned with top of inlet spud. A label above the jacket hole has an arrow that will point to marked portion of pipe nipple if the orientation is correct. If the arrow does not point within the marked range on pipe nipple, adjust the pipe nipple to correct. A pipe union is supplied with the Hydrocannon to reduce probability of misaligning the Hydrocannon accidentally while tightening the connection to inlet water supply line. Improper orientation of the Hydrocannon can cause poor performance of heater and can significantly reduce outlet water temperatures during heavy draws.



Note: The Hydrocannon may have 1, 3 or 7 cross tubes.

FIGURE 1.

HIGH LIMIT SWITCH

The digital thermostat (Figure 2) contains the high limit (energy cutout) switch. The high limit switch interrupts main burner gas flow should the water temperature reach 203°F (95°C).

In the event of high limit switch operation, the water heater cannot be restarted unless the water temperature is reduced to approximately 120°F (49°C). The high limit reset button on the front of the control then needs to be depressed.

Continued manual resetting of high limit control, preceded by higher than usual water temperature is evidence of high limit switch operation. The following is a possible reason for high limit switch operation:

- A malfunction in the thermostatic controls would allow the gas control valve to remain open causing water temperature to exceed the thermostat setting. The water temperature would continue to rise until high limit switch operation.

Contact your dealer or service agent if continued high limit switch operation occurs.

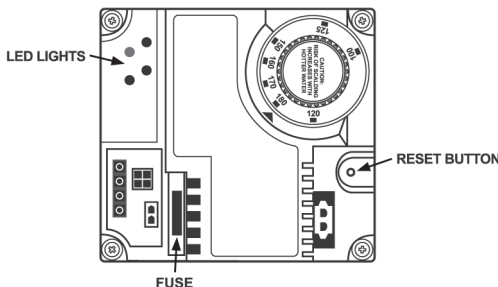

DIGITAL THERMOSTAT

FIGURE 2.

ELECTRONIC IGNITION CONTROL

Each heater is equipped with a Honeywell ignition module. The solid state ignition control ignites the pilot burner gas by

creating a spark at the pilot assembly. See Figure 3. Pilot gas is ignited and burns during each running cycle. The main burner and pilot gases are cut off during the OFF cycle. Pilot gas ignition is proven by the pilot sensor. Main burner ignition will not occur if the pilot sensor does not first sense pilot ignition.

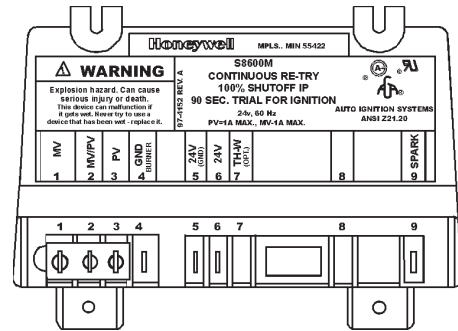

IGNITION MODULE

FIGURE 3.

AUTOMATIC FLUE DAMPER

All units are equipped with an automatic flue damper that reduces heat loss during the OFF cycles.

Each automatic flue damper drive assembly is equipped with a "Service Switch", as shown in Figure 4

The "Service Switch" has 2 positions: AUTOMATIC OPERATION and HOLD OPEN DAMPER. For normal operation the switch should be in the AUTOMATIC OPERATION position.

If there is a problem with the damper the "Service Switch" can be placed in the HOLD OPEN DAMPER position. When the switch is placed in the HOLD OPEN DAMPER position the damper disc will rotate to the open position and the heater may be used until vent assembly is repaired or replaced. DO NOT turn the damper disc manually; damage will occur to the drive assembly if operated manually. Refer to TESTING DAMPER OPERATION section of this manual for additional information.

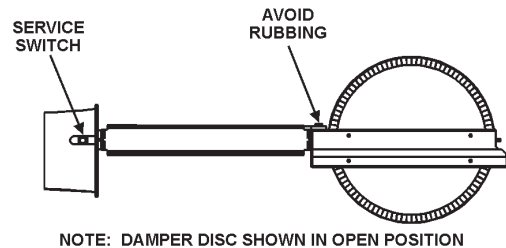

FLUE DAMPER

FIGURE 4.

UNCRATING

The heater is shipped with the flue damper already installed. The wiring conduit runs from the thermostat to the damper drive cover. Before turning unit on, check to make sure the wiring conduit is securely plugged into damper drive.

INSTALLATION CONSIDERATIONS

ROUGH IN DIMENSIONS

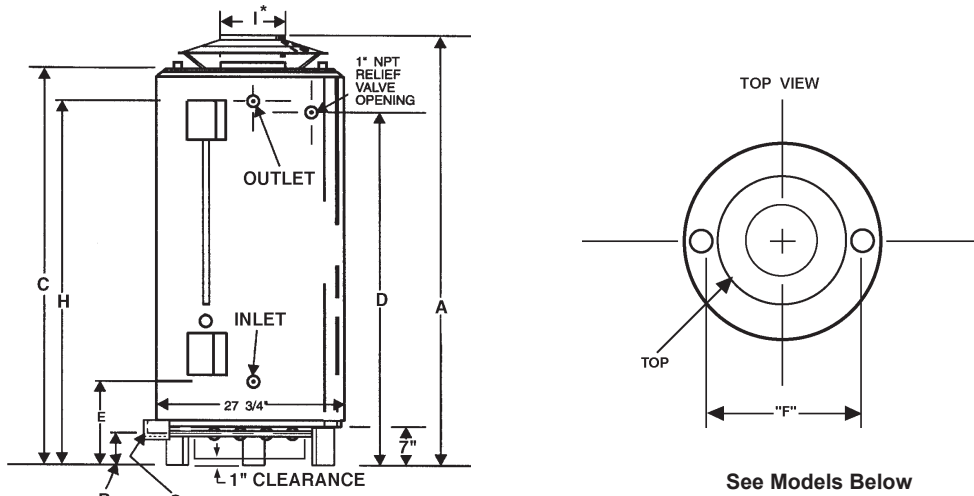

* SBD71120(N,P)E Models are approved for 5" (13 cm) venting using a 6" (15 cm) to 5" (13 cm) reducer.

FIGURE 5.

TABLE 1. SBD71120(N,P)E thru SBD100390(N,P)E

MODEL	INPUT RATE BTU/Hr.	APPROX TANK CAP.	A	B	C	D	E	F	GAS INLET G	H	VENT DIA I	J	CONNECTIONS						Approximate ship. Weight	
													INLET			OUTLET				
													TOP	FRONT	BACK	TOP	FRONT	BACK	STD.	ASME
SBD71120(N,P)E	120,000 BTU/Hr. 35 Kw/Hr	71 Gal 268 L	69-3/4" 177 cm	4-1/4" 11 cm	59-1/2" 151 cm	50-7/8" 129 cm	19-11/16" 50 cm	19" 48 cm	1/2" 1/2"	51-7/8" 132 cm	6" 15 cm	27-3/4" 71 cm	1-1/2" NPT 1-1/2" NPT	1-1/2" NPT 1-1/2" NPT	1-1/2" NPT 1-1/2" NPT	1-1/2" NPT 1-1/2" NPT	1-1/2" NPT 1-1/2" NPT	1-1/2" NPT 1-1/2" NPT	400 Lbs 182 Kg	NA NA
SBD81154(N,P)E	154,000 BTU/Hr 45 Kw/Hr	81 Gal 307 L	73" 185 cm	4-1/4" 11 cm	66-1/2" 169 cm	57-7/8" 147 cm	19-11/16" 50 cm	19" 48 cm	1/2" 1/2"	59" 150 cm	6" 15 cm	27-3/4" 71 cm	1-1/2" NPT 1-1/2" NPT	1-1/2" NPT 1-1/2" NPT	1-1/2" NPT 1-1/2" NPT	1-1/2" NPT 1-1/2" NPT	1-1/2" NPT 1-1/2" NPT	1-1/2" NPT 1-1/2" NPT	470 Lbs 213 Kg	NA NA
SBD81180(N,P)E	180,000 BTU/Hr 53 Kw/Hr	81 Gal 307 L	67-1/2" 171 cm	4-1/2" 12 cm	62" 157 cm	53-5/8" 136 cm	20-1/2" 52 cm	21" 53 cm	1/2" 1/2"	54-5/8" 139 cm	6" 15 cm	27-3/4" 71 cm	1-1/2" NPT 1-1/2" NPT	1-1/2" NPT 1-1/2" NPT	1-1/2" NPT 1-1/2" NPT	1-1/2" NPT 1-1/2" NPT	1-1/2" NPT 1-1/2" NPT	1-1/2" NPT 1-1/2" NPT	470 Lbs 213 Kg	NA NA
SBD100199(N,P)ET	199,000 BTU/Hr 58 Kw/Hr	100 Gal 379 L	75" 192 cm	4-1/2" 12 cm	70" 178 cm	61-5/8" 157 cm	20-1/2" 52 cm	21" 53 cm	1/2" 1/2"	62-5/8" 159 cm	6" 15 cm	27-3/4" 71 cm	1-1/2" NPT 1-1/2" NPT	1-1/2" NPT 1-1/2" NPT	1-1/2" NPT 1-1/2" NPT	1-1/2" NPT 1-1/2" NPT	1-1/2" NPT 1-1/2" NPT	1-1/2" NPT 1-1/2" NPT	603 Lbs 273 Kg	NA NA
SBD100199(N,P)E	199,000 BTU/Hr 58 Kw/Hr	100 Gal 379 L	75" 192 cm	4-1/2" 12 cm	70" 178 cm	61-5/8" 157 cm	20-1/2" 52 cm	21" 53 cm	1/2" 1/2"	61-1/2" 150 cm	6" 15 cm	27-3/4" 71 cm	1-1/2" NPT 1-1/2" NPT	1-1/2" NPT 1-1/2" NPT	2" NPT 2" NPT	1-1/2" NPT 1-1/2" NPT	1-1/2" NPT 1-1/2" NPT	2" NPT 2" NPT	603 Lbs 273 Kg	NA NA
SBD81199(N,P)	199,000 BTU/Hr 58 Kw/Hr	81 Gal 307 L	67-1/2" 171 cm	4-1/2" 12 cm	62" 157 cm	53-5/8" 136 cm	20-1/2" 52 cm	21" 53 cm	1/2" 1/2"	54-5/8" 139 cm	6" 15 cm	27-3/4" 71 cm	1-1/2" NPT 1-1/2" NPT	1-1/2" NPT 1-1/2" NPT	1-1/2" NPT 1-1/2" NPT	1-1/2" NPT 1-1/2" NPT	1-1/2" NPT 1-1/2" NPT	1-1/2" NPT 1-1/2" NPT	470 Lbs 213 Kg	NA NA
SBD100199(N,P)ES(A)	199,000 BTU/Hr 58 Kw/Hr	100 Gal 379 L	72" 183 cm	4-1/2" 12 cm	65-1/8" 165 cm	55-7/8" 142 cm	19-3/4" 50 cm	23" 58 cm	1/2" 1/2"	56-3/8" 143 cm	6" 15 cm	30-1/4" 77 cm	1-1/2" NPT 1-1/2" NPT	2" NPT 2" NPT	2" NPT 2" NPT	1-1/2" NPT 1-1/2" NPT	2" NPT 2" NPT	2" NPT 2" NPT	630 Lbs 286 Kg	725 Lbs 329 Kg
SBD100250(N,P)E(A)	250,000 BTU/Hr 72 Kw/Hr	100 Gal 379 L	72" 183 cm	4-1/2" 12 cm	65-1/8" 165 cm	55-7/8" 142 cm	19-1/4" 50 cm	23" 58 cm	1/2" 1/2"	56-3/8" 143 cm	8" 20 cm	30-1/4" 77 cm	1-1/2" NPT 1-1/2" NPT	2" NPT 2" NPT	2" NPT 2" NPT	1-1/2" NPT 1-1/2" NPT	2" NPT 2" NPT	2" NPT 2" NPT	630 Lbs 286 Kg	725 Lbs 329 Kg
SBD65251(N,P)E(A)	251,000 BTU/Hr 73 Kw/Hr	65 Gal 246 L	75" 191 cm	4-1/2" 12 cm	65-3/4" 167 cm	57-1/4" 145 cm	20" 51 cm	NA NA	1/2" 1/2"	58-3/4" 149 cm	8" 20 cm	27-3/4" 70 cm	NA NA	1-1/2" NPT 1-1/2" NPT	1-1/2" NPT 1-1/2" NPT	NA NA	1-1/2" NPT 1-1/2" NPT	1-1/2" NPT 1-1/2" NPT	750 Lbs 341 Kg	862 Lbs 391 Kg
SBD100275(N,P)E(A)	275,000 BTU/Hr 80 Kw/Hr	100 Gal 379 L	72" 183 cm	4-1/2" 12 cm	65-1/8" 165 cm	55-7/8" 142 cm	19-3/4" 50 cm	23" 58 cm	1/2" 1/2"	56-3/8" 143 cm	8" 20 cm	30-1/4" 77 cm	1-1/2" NPT 1-1/2" NPT	2" NPT 2" NPT	2" NPT 2" NPT	1-1/2" NPT 1-1/2" NPT	2" NPT 2" NPT	2" NPT 2" NPT	630 Lbs 286 Kg	725 Lbs 329 Kg
SBD65305(P,N)E(A)	305,000 BTU/Hr 89 Kw/Hr	65 Gal 246 L	75" 191 cm	4-1/2" 12 cm	65-3/4" 167 cm	57-1/4" 145 cm	20" 51 cm	NA NA	1/2" 1/2"	58-3/4" 149 cm	8" 20 cm	27-3/4" 70 cm	NA NA	1-1/2" NPT 1-1/2" NPT	1-1/2" NPT 1-1/2" NPT	NA NA	1-1/2" NPT 1-1/2" NPT	1-1/2" NPT 1-1/2" NPT	750 Lbs 341 Kg	862 Lbs 391 Kg
SBD85365(N,P)E	365,000 BTU/Hr 107 Kw/Hr	85 Gal 322 L	79-1/2" 202 cm	4-1/2" 12 cm	70-1/4" 178 cm	62-1/2" 159 cm	22-1/2" 57 cm	23" 58 cm	3/4" 3/4"	63" 160 cm	8" 20 cm	27-3/4" 70 cm	1-1/2" NPT 1-1/2" NPT	1-1/2" NPT 1-1/2" NPT	1-1/2" NPT 1-1/2" NPT	1-1/2" NPT 1-1/2" NPT	1-1/2" NPT 1-1/2" NPT	1-1/2" NPT 1-1/2" NPT	725 Lbs 329 Kg	833 Lbs 379 Kg
SBD100390(N,P)E(A)	390,000 BTU/Hr 114 Kw/Hr	100 Gal 379 L	75-1/2" 192 cm	4-1/2" 12 cm	67-1/2" 171 cm	58-1/4" 148 cm	26-3/4" 68 cm	23" 58 cm	3/4" 3/4"	59" 150 cm	8" 20 cm	30-1/4" 77 cm	1-1/2" NPT 1-1/2" NPT	2" NPT 2" NPT	2" NPT 2" NPT	1-1/2" NPT 1-1/2" NPT	2" NPT 2" NPT	2" NPT 2" NPT	760 Lbs 345 Kg	874 Lbs 396 Kg

INSTALLATION CONSIDERATIONS

TABLE 2. HEATER PERFORMANCE DATA BTR MODELS

MODEL	INPUT RATE BTUH	APPROX. GAL. CAP.	EFF. %	RECOVERY RATING CAPACITIES (GPH AND LPH)													
				30° F	40° F	50° F	60° F	70° F	80° F	90° F	100° F	110° F	120° F	130° F	140° F		
				17° C	22° C	28° C	33° C	39° C	44° C	50° C	56° C	61° C	67° C	72° C	78° C		
SBD71120(N,P)E	120,000 BTUH 35 Kw/Hr	71 Gal 268 L	80	388	291	233	194	166	145	129	116	106	97	90	83		
				1469	1102	882	734	628	549	488	439	401	367	341	314		
SBD81154(N,P)	154,000 BTUH 45 Kw/Hr	81 Gal 306 L	80	498	373	299	249	213	187	166	149	136	124	115	107		
				1885	1412	1132	943	806	708	628	564	515	469	435	405		
SBD81180(N,P)E	180,000 BTUH 53 Kw/Hr	81 Gal 306L	80	579	434	347	289	248	217	193	174	158	145	134	124		
				2192	1643	1314	1094	939	821	731	659	598	549	507	469		
SBD100199(N,P)ET	199,000 BTUH 58 Kw/Hr	100 Gal 379 L	80	643	482	386	322	276	241	214	193	175	161	148	132		
				2434	1825	1461	1219	1045	912	810	731	662	609	560	500		
SBD100199(N,P)E	199,000 BTUH 58 Kw/Hr	100 Gal 379L	80	643	482	386	322	276	241	214	193	175	161	148	132		
				2434	1825	1461	1219	1045	912	810	731	662	609	560	500		
SBD81199(N,P)E	199,000 BTUH 58 Kw/Hr	81 Gal 3 06 L	80	643	482	386	322	276	241	214	193	175	161	148	132		
				2434	1825	1461	1219	1045	912	810	731	662	609	560	500		
SBD100199(N,P)ES(A)	199,000 BTUH 58 Kw/Hr	100 Gal 379 L	80	643	482	386	322	276	241	214	193	175	161	148	132		
				2434	1825	1461	1219	1045	912	810	731	662	609	560	500		
SBD100250(N,P)E(A)	250,000 BTUH 73 Kw/Hr	100 Gal 379 L	80	808	606	485	404	346	303	269	242	220	202	186	173		
				3059	2294	1835	1529	1311	1147	1020	918	834	765	706	655		
SBD65251(N,P)E(A)	251,000 BTUH 73 Kw/Hr	65 Gal 246 L	80	811	608	487	406	348	304	270	243	221	203	187	174		
				3071	2303	1843	1536	1316	1152	1024	921	838	768	709	658		
SBD100275(N,P)E(A)	275,000 BTUH 80 Kw/Hr	100 Gal 379 L	80	889	667	533	444	381	333	296	267	242	222	205	190		
				3365	2524	2019	1682	1442	1262	1122	1009	918	841	776	721		
SBD65305(P,N)E(A)	305,000 BTUH 89 Kw/Hr	65 Gal 246 L	80	986	739	592	493	423	370	329	296	269	246	228	211		
				3732	2799	2239	1866	1599	1399	1244	1120	1018	933	861	800		
SBD85365(N,P)E(A)	365,000 BTUH 107 Kw/Hr	85 Gal 322 L	80	1180	885	708	590	506	442	393	354	322	295	272	253		
				4466	3349	2680	2233	1914	1675	1489	1340	1218	1116	1031	957		
SBD100390(N,P)E(A)	390,000 BTUH 14 Kw/Hr	100 Gal 379 L	80	1293	970	776	646	554	485	431	388	353	323	298	277		
				4894	3671	2936	2447	2097	1835	1631	1468	1335	1224	1129	1049		

TABLE 3. GAS AND ELECTRICAL CHARACTERISTICS

Model	Type of Gas	Gas Supply Pressure		Gas Manifold Pressure	Volts/Hz	Amperes
		Minimum	Maximum			
All Models	Natural	4.5" W.C. (1.12 kPa)	14" W.C. (3.48 kPa)	3.5" W.C. (0.87 kPa)	120/60	<5
All Models	Propane	11.0" W.C. (2.74kPa)	14" W.C. (3.48kPa)	10.0" W.C. (2.49 kPa)	120/60	<5

INSTALLATION CONSIDERATIONS

LOCATING THE WATER HEATER

CAUTION

Property Damage Hazard

- All water heaters eventually leak.
- Do not install without adequate drainage.

When installing the heater, consideration must be given to proper location. Location selected should be as close to the stack or chimney as practicable, with adequate air supply and as centralized with the piping system as possible.

WARNING

Fire or Explosion Hazard

- Do not store or use gasoline or other flammable vapors and liquids in the vicinity of this or any other appliance.
- Avoid all ignition sources if you smell gas.
- Do not expose water heater controls to excessive gas pressure.
- Use only the gas shown on the water heater rating label.
- Maintain required clearances to combustibles.
- Keep ignition sources away from faucets after extended periods of non-use.



Read instruction manual before installing, using or servicing water heater.



There is a risk in using fuel burning appliances such as gas water heaters in rooms, garages or other areas where gasoline, other flammable liquids or engine driven equipment or vehicles are stored, operated or repaired. Flammable vapors are heavy and travel along the floor and may be ignited by the heater's igniter or main burner flames causing fire or explosion. Some local codes permit operation of gas appliances in such areas if they are installed 18" or more above the floor. This may reduce the risk if location in such an area cannot be avoided.

Do not install this water heater directly on a carpeted floor. A fire hazard may result. Instead the water heater must be placed on a metal or wood panel extending beyond the full width and depth by at least 3 inches in any direction. If the heater is installed in a carpeted alcove, the entire floor shall be covered by the panel. Also, see the DRAINING requirements in MAINTENANCE Section.

The heater shall be located or protected so it is not subject to physical damage by a moving vehicle.

Flammable items, pressurized containers or any other potential fire hazardous articles must never be placed on or adjacent to the heater. Open containers or flammable material should not be stored or used in the same room with the heater.

The heater must not be located in an area where it will be subject to freezing.

Locate it near a floor drain. The heater should be located in an area where leakage from heater or connections will not result in damage to adjacent area or to lower floors of the structure.

When such locations cannot be avoided, a suitable metal drain pan should be installed under heater. Such pans should be fabricated with sides at least 2" deep, with length and width at least 2" greater than diameter of heater and must be piped to an adequate drain. Pan must not restrict combustion air flow.

CLEARANCES

These heaters are approved for installation on combustible flooring in an alcove when the minimum clearance from combustion or non-combustible construction are followed as indicated in Figure 6 and Table 4.

In all installations the minimum combustible clearances from draft hood surface or vent piping shall be 6" (152mm). Vent piping passing through a combustible wall or ceiling must be a continuous run (no joints) and retain 6" (152mm) clearance unless an approved reducing thimble is used.

A service clearance of 24" (610mm) should be maintained from serviceable parts, such as relief valves, baffles, thermostats, cleanout openings or drain valves.

TABLE 4. INSTALLATION CLEARANCES

	A (RIGHT SIDE)	B (LEFTSIDE)	C (BACK)	D (CEILING)
SBD71120(N,P)E	1" (2.54 cm)	1" (2.54 cm)	1" (2.54 cm)	12" (30.48 cm)
SBD81154(N,P)E	1" (2.54 cm)	1" (2.54 cm)	1" (2.54 cm)	12" (30.48 cm)
SBD81180(N,P)E	1" (2.54 cm)	1" (2.54 cm)	1" (2.54 cm)	12" (30.48 cm)
SBD100199(N,P)ET	1" (2.54 cm)	1" (2.54 cm)	1" (2.54 cm)	12" (30.48 cm)
SBD100199(N,P)E	1" (2.54 cm)	1" (2.54 cm)	1" (2.54 cm)	12" (30.48 cm)
SBD81199(N,P)E	1" (2.54 cm)	1" (2.54 cm)	1" (2.54 cm)	12" (30.48 cm)
SBD100199(N,P)ES(A)	1" (2.54 cm)	1" (2.54 cm)	1" (2.54 cm)	12" (30.48 cm)
SBD100250(N,P)E(A)	2" (5.08 cm)	2" (5.08 cm)	2" (5.08 cm)	12" (30.48 cm)
SBD65251(N,P)E(A)	2" (5.08 cm)	2" (5.08 cm)	2" (5.08 cm)	12" (30.48 cm)
SBD100275(N,P)E(A)	2" (5.08 cm)	2" (5.08 cm)	2" (5.08 cm)	12" (30.48 cm)
SBD65305(P,N)E(A)	2" (5.08 cm)	2" (5.08 cm)	2" (5.08 cm)	12" (30.48 cm)
SBD85365(N,P)E(A)	3" (7.75 cm)	3" (7.75 cm)	3" (7.75 cm)	12" (30.48 cm)
SBD100390(N,P)E(A)	3" (7.75 cm)	3" (7.75 cm)	3" (7.75 cm)	12" (30.48 cm)

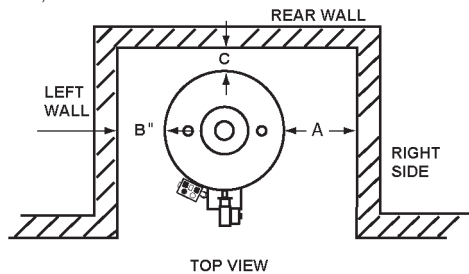
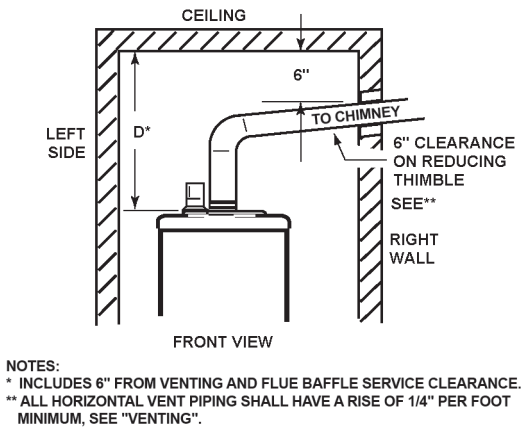

ILLUSTRATION OF MINIMUM COMBUSTIBLE CLEARANCES IN AN ALCOVE

FIGURE 6.

NSF LEG KIT

The NSF Leg Kit (part number 9003425205) is needed only for applications that must conform to NSF/ANSI Standard 5. Installation of the NSF leg kit will increase the height of the unit and all connection points by 3 inches. See Figure 7.

Follow these steps to install the Leg Kit:

1. Unit needs to be lifted in a way not to damage unit or laid on it's side to access the bottom of the legs.
2. Slide leg extension under leg and the bolt up through the bottom hole located in the bottom of the leg.
3. Once in place, screw nut down and secure.
4. Front of leg should line up with front of leg extension as shown to make sure weight of unit is distributed through the leg extension.

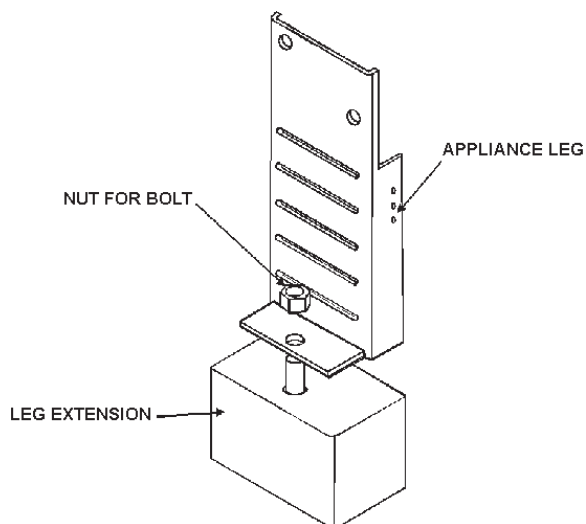

FIGURE 7.

INSULATION BLANKET

! WARNING	
Breathing Hazard - Carbon Monoxide Gas	
	<ul style="list-style-type: none"> • Do not obstruct water heater air intake with insulating blanket. • Gas and carbon monoxide detectors are available. • Install water heater in accordance with the instruction manual.
Breathing carbon monoxide can cause brain damage or death. Always read and understand instruction manual.	

Insulation blankets are available to the general public for external use on gas water heaters but are not necessary with these products. The purpose of an insulation blanket is to reduce the standby heat loss encountered with storage tank heaters. The water heaters covered by this manual meet or exceed the Energy Policy Act standards with respect to insulation and standby heat loss requirements, making an insulation blanket unnecessary.

Should you choose to apply an insulation blanket to this heater, you should follow these instructions. See the Features and Components section of this manual for identification of components mentioned below. Failure to follow these instructions can restrict the air flow required for proper combustion, potentially resulting in fire, asphyxiation, serious personal injury or death.

- **DO NOT** apply insulation to the top of the water heater, as this will interfere with safe operation of the draft hood.
- **DO NOT** cover the gas control valve, thermostat or the Temperature-Pressure-Relief Valve.
- **DO NOT** allow insulation to come within 2" (5 cm) of the burners, to prevent blockage of combustion air flow to the burners.
- **DO NOT** allow insulation to come within 9 inches (23 cm) of floor, (within 2 inches (5 cm) of bottom cover) to prevent blockage of combustion air flow to the burners..
- **DO NOT** cover the instruction manual. Keep it on the side of the water heater or nearby for future reference.
- **DO** obtain new warning and instruction labels from the manufacturer for placement on the blanket directly over the existing labels.
- **DO** inspect the insulation blanket frequently to make certain it does not sag, thereby obstructing combustion air flow.

HARD WATER

Where hard water conditions exist, water softening or the threshold type of water treatment is recommended. This will protect the dishwashers, coffee urns, water heaters, water piping and other equipment.

See the Maintenance Section in this manual for sediment and lime scale removal procedures.

CIRCULATION PUMPS

A circulating pump is used when a system requires a circulating loop or there is a storage tank used in conjunction with the water heater. See Water Piping Diagrams in this manual for installation location of circulating pumps.

See the Circulation Pump Wiring Diagrams in this manual for electrical hookup information. Install in accordance with the current edition of the National Electrical Code, NFPA 70 or the Canadian Electrical Code, CSA C22.1.

All-bronze circulating pumps are recommended for used with commercial water heaters.

Some circulating pumps are manufactured with sealed bearings and do not require further lubrication. Some circulating pumps

must be periodically oiled. Refer to the pump manufacturer's instructions for lubrication requirements.

CIRCULATING PUMP WIRING DIAGRAM
STORAGE TANK OR BUILDING RECIRCULATION

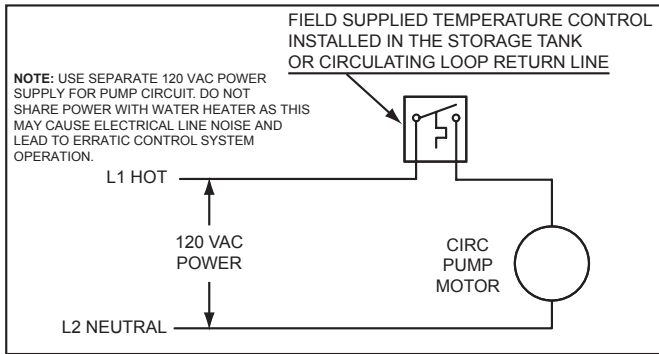

FIGURE 8.

CIRCULATING PUMP WIRING DIAGRAM
DISHWASHER LOOP WITH TOGGLE SWITCH

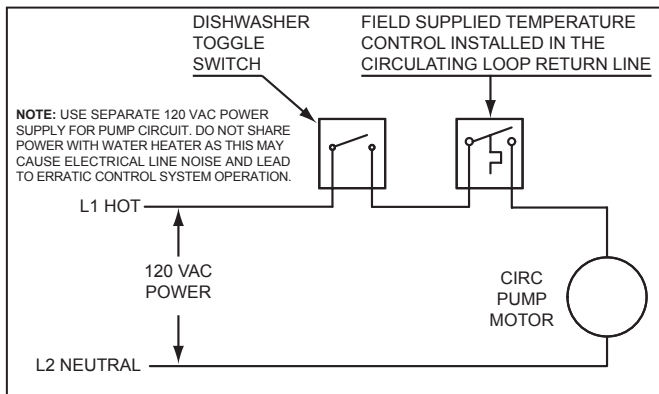



FIGURE 9.

HIGH ALTITUDE INSTALLATIONS

	<h1>WARNING</h1>
	<h2>Fire and Explosion Hazard</h2>
	<ul style="list-style-type: none"> • Under no circumstances should the input exceed the rate shown on the water heater's rating label. • Overfiring could result in fire or explosion. • Gas and carbon monoxide detectors are available.

<h1>WARNING</h1>	
<h2>Breathing Hazard - Carbon Monoxide Gas</h2>	
	<ul style="list-style-type: none"> • Under no circumstances should the input exceed the rate shown on the water heater's rating label. • Overfiring could result in damage to the water heater and sooting. • Gas and carbon monoxide detectors are available.
<p>Breathing carbon monoxide can cause brain damage or death. Always read and understand instruction manual.</p>	

Installations above 2000 feet (610 meters) require replacement of burner orifices in accordance with current edition of the National Fuel Gas Code (ANSI Z223.1). For Canadian installations consult Canadian Installations Code CAN/CSA B149.1. Failure to replace orifices will result in improper and inefficient operation of the water heater resulting in the production of increased levels of carbon monoxide gas in excess of safe limits which could result in serious personal injury or death.

You should contact your gas supplier for any specific changes which may be required in your area.

As the elevation above sea level is increased, there is less oxygen per cubic foot of air. Therefore, the heater input rate should be reduced at high altitudes for satisfactory operation with the reduced oxygen supply. Failure to make this reduction would result in an over firing of the heater causing sooting, poor combustion and/or unsatisfactory heater performance.

Ratings specified by manufacturers for most appliances apply for elevations up to 2000 feet (610m). For elevations above 2000 feet (610), ratings must be reduced at the rate of 4% for each 1000 feet (305m) above sea level. For example, if a heater is rated at 78,000 Btuh (22.9 Kwh) at sea level, to rate the heater at 4000 feet (1219m), you subtract 4 (once for each thousand feet) x.04 (4% input reduction) x 78,000 (original rating) from the original rating.

Therefore, to calculate the input rating at 4,000 feet (1219m):
 $4 \times .04 \times 78,000 = 12,480 \text{ Btuh (3.7 Kwh)}$, $78,000 (22.9 \text{ Kwh}) - 12,480 (3.7 \text{ Kwh}) = 65,520 \text{ Btuh (19.2 Kwh)}$. At 6000 feet (1829m) the correct input rating should be 59,280 Btuh (17.4 Kwh).

INSTALLATION REQUIREMENTS

GAS SUPPLY SYSTEMS

Low pressure building gas supply systems are defined as those systems that cannot under any circumstances exceed 14" W.C. (1/2 PSI Gauge). These systems do not require pressure regulation. Measurements should be taken to insure that gas pressures are stable and fall within the requirements stated on the water heater rating plate. Readings should be taken with all gas burning equipment off (static pressure) and with all gas burning equipment running at maximum rate (dynamic pressure). The gas supply pressure must be stable within 1.5" W.C. from static to dynamic pressure to provide good performance. Pressure drops that exceed 1.5" W.C. may cause rough starting, noisy combustion or nuisance outages. Increases or spikes in static pressure during off cycles may cause failure to ignite or in severe cases damage to appliance gas valves. If your low pressure system does NOT meet these requirements, the installer is responsible for the corrections.

High Pressure building supply systems use pressures that exceed 14" W.C. (1/2 PSI Gauge). These systems must use field supplied regulators to lower the gas pressure to less than 14" W.C. (1/2 PSI Gauge). Water heaters require gas regulators that are properly sized for the water heater input and deliver the rating plate specified pressures. Gas supply systems where pressure exceeds 5 PSI often require multiple regulators to achieve desired pressures. Systems in excess of 5 PSI building pressure should be designed by gas delivery professionals for best performance. Water heaters connected to gas supply systems that exceed 14" W.C. (1/2 PSI Gauge) at any time must be equipped with a gas supply regulator.

All models require a minimum gas supply pressure of 4.5" W.C. for natural gas and 11.0" W.C. for propane gas. The minimum supply pressure is measured while gas is flowing (dynamic pressure). The supply pressure should never fall below 4.5" W.C. for natural gas and 11.0" W.C. for propane gas. The supply pressure should be measured with all gas fired appliances connected to the common main firing at full capacity. If the supply pressure drops more than 1.5" W.C. as gas begins to flow to the water heater then the supply gas system including the gas line and/or the gas regulator may be restricted or undersized. See Supply Gas Regulator section and Gas Piping section of this manual. The gas valve on all models has a maximum gas supply pressure limit of 14" W.C. The maximum supply pressure is measured while gas is not flowing (static pressure).

SUPPLY GAS REGULATOR

The maximum allowable gas supply pressure for this water heater is 14 inches W.C. (3.48 kPa). Install a positive lock-up gas pressure regulator in the gas supply line if inlet gas pressure can exceed 14 inches W.C. (3.48 kPa) at any time. Regulators must be sized/used according to manufacturer's specifications.

If a positive lock-up regulator is required follow these instructions:

1. Positive lock-up gas pressure regulators must be rated at or above the input Btu/hr rating of the water heater they supply.
2. Positive lock-up gas pressure regulator(s) should be installed no closer than 3 equivalent feet (1 meter) and no farther than 8 equivalent feet (2.4 meters) from water heater's inlet gas connection.
3. After installing the positive lock-up gas pressure regulator(s) an initial nominal supply pressure setting of 7.0" W.C. while the water heater is operating is recommended and will generally provide good water heater operation. Some addition adjustment maybe required later to maintain a steady gas supply pressure.

4. When installing multiple water heaters in the same gas supply system it is recommended that individual positive lock-up gas pressure regulators be installed at each unit.

POWER SUPPLY

The water heaters covered in this manual require a 120 VAC, 1Ø (single phase), 60Hz, 15 amp power supply and must also be electrically grounded in accordance with local codes or, in the absence of local codes, with the National Electrical Code, ANSI/NFPA 70 or the Canadian Electrical Code, CSA C22.1.

WATER TEMPERATURE CONTROL AND MIXING VALVES



Water temperature over 125°F (52°C) can cause severe burns instantly resulting in severe injury or death.

Children, the elderly and the physically or mentally disabled are at highest risk for scald injury.

Feel water before bathing or showering.

Temperature limiting devices such as mixing valves must be installed when required by codes and to ensure safe temperatures at fixtures.

Water heated to a temperature which will satisfy clothes washing, dish washing, and other sanitizing needs can scald and cause permanent injury upon contact. Short repeated heating cycles caused by small hot water uses can cause temperatures at the point of use to exceed the water heater's temperature setting by up to 20°F (11°C).

Some people are more likely to be permanently injured by hot water than others. These include the elderly, children, the infirm and the physically/mentally disabled. Table 5 shows approximate time-to-burn relationship for normal adult skin. If anyone using hot water provided by the water heater being installed fits into one of these groups or if there is a local code or state law requiring a certain water temperature at the point of use, then special precautions must be taken.

In addition to using the lowest possible temperature setting that satisfies the demand of the application a Mixing Valve should be installed at the water heater (see Figure 10) or at the hot water taps to further reduce system water temperature.

Mixing valves are available at plumbing supply stores. Consult a Qualified Installer or Service Agency. Follow mixing valve manufacturer's instructions for installation of the valves.

TABLE 5.

Water Temperature °F	Time for 1st Degree Burn (Less Severe Burns)	Time for Permanent Burns 2nd & 3rd Degree (Most Severe Burns)
110	(normal shower temp.)	
116	(pain threshold)	
116	35 minutes	45 minutes
122	1 minute	5 minutes
131	5 seconds	25 seconds
140	2 seconds	5 seconds
149	1 second	2 seconds
154	instantaneous	1 second

(U.S. Government Memorandum, C.P.S.C., Peter L. Armstrong, Sept. 15, 1978)

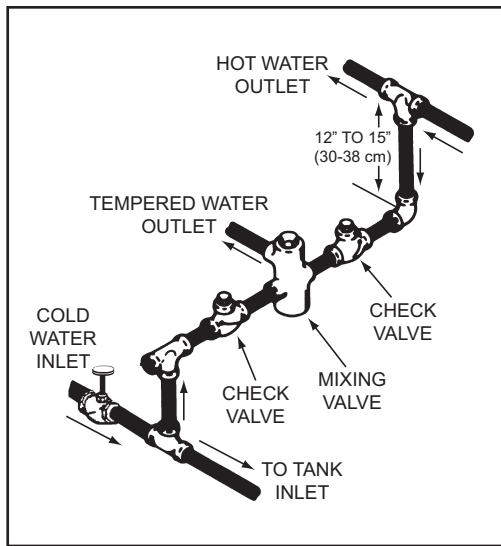

FIGURE 10.

DISHWASHING MACHINES

All dishwashing machines meeting the National Sanitation Foundation requirements are designed to operate with water flow pressures between 15 and 25 pounds per square inch (103 kPa and 173 kPa). Flow pressures above 25 pounds per square inch (173 kPa), or below 15 pounds per square inch (103 kPa), will result in improperly sanitized dishes. Where pressures are high, a water pressure reducing or flow regulating control valve should be used in the 180°F (82°C) line to the dishwashing machine and should be adjusted to deliver water pressure between these limits.

The National Sanitation Foundation also recommends circulation of 180°F (82°C) water. The circulation flow rate should be just enough to provide 180°F (82°C) water at the point of take-off to the dishwashing machine.

Adjust flow by throttling a full port ball valve installed in the circulating line on the outlet side of the pump. Never throttle flow on the suction side of a pump. See Water Piping Diagrams in this manual.

NOTE: These water heaters meet the NSF Standard 5 for sanitary installations when used with the leg kit part number 9003425205.

CLOSED WATER SYSTEMS

Water supply systems may, because of code requirements or such conditions as high line pressure, among others, have installed devices such as pressure reducing valves, check valves, and back flow preventers. Devices such as these cause the water system to be a closed system.

THERMAL EXPANSION

As water is heated, it expands (thermal expansion). In a closed system the volume of water will grow when it is heated. As the volume of water grows there will be a corresponding increase in water pressure due to thermal expansion. Thermal expansion can cause premature tank failure (leakage). This type of failure is not covered under the limited warranty. Thermal expansion can also cause intermittent Temperature-Pressure Relief Valve operation: water discharged from the valve due to excessive pressure build up. This condition is not covered under the limited warranty. The Temperature-Pressure Relief Valve is not intended for the constant relief of thermal expansion.

A properly sized thermal expansion tank must be installed on all closed systems to control the harmful effects of thermal expansion. Contact a local plumbing service technician to have a thermal expansion tank installed.

See Water Line Connections on page 21 and the Water Piping Diagrams beginning on page 40.

TEMPERATURE-PRESSURE RELIEF VALVE

	<h1>! WARNING</h1>
	<h3>Explosion Hazard</h3>
	<ul style="list-style-type: none"> • Temperature-Pressure Relief Valve must comply with ANSI Z21.22- CSA 4.4 and ASME code. • Properly sized temperature-pressure relief valve must be installed in opening provided. • Can result in overheating and excessive tank pressure. • Can cause serious injury or death.

This water heater is provided with a properly rated/sized and certified combination Temperature-Pressure Relief Valve (T&P valve) by the manufacturer. The valve is certified by a nationally recognized testing laboratory that maintains periodic inspection of production of listed equipment of materials as meeting the requirements for Pressure Relief Valves for Hot Water Supply Systems, ANSI Z21.22 • CSA 4.4, and the code requirements of ASME.

If replaced, the new T&P valve must meet the requirements of local codes, but not less than a combination Temperature-Pressure Relief Valve rated/sized and certified as indicated in the above paragraph. The new valve must be marked with a maximum set pressure not to exceed the marked hydrostatic working pressure of the water heater (150 psi = 1,035 kPa) and a discharge capacity not less than the water heater Btu/hr or kW input rate as shown on the water heater's model rating label.

NOTE: In addition to the factory installed Temperature-Pressure Relief Valve on the water heater, each remote storage tank that may be installed and piped to a water heating appliance must also have its own properly sized, rated and approved Temperature-Pressure Relief Valve installed. Call the toll free technical support phone number listed on the back cover of this manual for technical assistance in sizing a Temperature-Pressure Relief Valve for remote storage tanks.

For safe operation of the water heater, the Temperature-Pressure Relief Valve must not be removed from its designated opening nor plugged. The Temperature-Pressure Relief Valve must be installed directly into the fitting of the water heater designed for the pressure relief valve. Install discharge piping so that any discharge will exit the pipe within 6 inches (15.2 cm) above an adequate floor drain, or external to the building. In cold climates it is recommended that it be terminated at an adequate drain inside the building. Be certain that no contact is made with any live electrical part. The discharge opening must not be blocked or reduced in size under any circumstances. Excessive length, over 30 feet (9.14 m), or use of more than four elbows can cause restriction and reduce the discharge capacity of the valve.

No valve or other obstruction is to be placed between the Temperature-Pressure Relief Valve and the tank. Do not connect discharge piping directly to the drain unless a 6" (15.2 cm) air gap is provided. To prevent bodily injury, hazard to life, or property damage, the relief valve must be allowed to discharge water in adequate quantities should circumstances demand. If the discharge pipe is not connected to a drain or other suitable means, the water flow may cause property damage.

CAUTION
Water Damage Hazard
<ul style="list-style-type: none"> • Temperature-Pressure Relief Valve discharge pipe must terminate at adequate drain.

T&P Valve Discharge Pipe Requirements:

- Shall not be smaller in size than the outlet pipe size of the valve, or have any reducing couplings or other restrictions.
- Shall not be plugged or blocked.
- Shall not be exposed to freezing temperatures.
- Shall be of material listed for hot water distribution.
- Shall be installed so as to allow complete drainage of both the Temperature-Pressure Relief Valve and the discharge pipe.
- Must terminate a maximum of six inches above a floor drain or external to the building. In cold climates, it is recommended that the discharge pipe be terminated at an adequate drain inside the building.
- Shall not have any valve or other obstruction between the pressure relief valve and the drain.

⚠ DANGER	<ul style="list-style-type: none"> • Burn hazard. • Hot water discharge. • Keep clear of Temperature-Pressure Relief Valve discharge outlet.

The Temperature-Pressure Relief Valve must be manually operated at least twice a year. Caution should be taken to ensure that (1) no one is in front of or around the outlet of the Temperature-Pressure Relief Valve discharge line, and (2) the water manually discharged will not cause any bodily injury or property damage because the water may be extremely hot. If after manually operating the valve, it fails to completely reset and continues to release water, immediately close the cold water inlet to the water heater, follow the draining instructions in this manual, and replace the Temperature-Pressure Relief Valve with a properly rated/sized new one.

NOTE: The purpose of a Temperature-Pressure Relief Valve is to prevent excessive temperatures and pressures in the storage tank. The T&P valve is not intended for the constant relief of thermal expansion. A properly sized thermal expansion tank must be installed on all closed systems to control thermal expansion, see Closed Water Systems and Thermal Expansion on page 14.

If you do not understand these instructions or have any questions regarding the Temperature-Pressure Relief Valve call the toll free number listed on the back cover of this manual for technical assistance.

CONTAMINATED AIR

⚠ WARNING	
Breathing Hazard - Carbon Monoxide Gas	
	<ul style="list-style-type: none"> • Install water heater in accordance with the Instruction Manual and NFPA 54 or CAN/CSA-B149.1. • To avoid injury, combustion and ventilation air must be taken from outdoors. • Do not place chemical vapor emitting products near water heater.
Breathing carbon monoxide can cause brain damage or death. Always read and understand instruction manual.	

Corrosion of the flue ways and vent system may occur if air for combustion contains certain chemical vapors. Such corrosion may result in failure and risk of asphyxiation.

Combustion air that is contaminated can greatly diminish the life span of the water heater and water heater components such as hot surface igniters and burners. Propellants of aerosol sprays, beauty shop supplies, water softener chemicals and chemicals used in dry cleaning processes that are present in the combustion, ventilation or ambient air can cause such damage.

Do not store products of this sort near the water heater. Air which is brought in contact with the water heater should not contain any of these chemicals. If necessary, uncontaminated air should be obtained from remote or outdoor sources. The limited warranty is voided when failure of water heater is due to a corrosive atmosphere. (See limited warranty for complete terms and conditions).

AIR REQUIREMENTS

⚠ WARNING	
Breathing Hazard - Carbon Monoxide Gas	
	<ul style="list-style-type: none"> • Install water heater in accordance with the Instruction Manual and NFPA 54 or CAN/CSA-B149.1. • To avoid injury, combustion and ventilation air must be taken from outdoors. • Do not place chemical vapor emitting products near water heater.
Breathing carbon monoxide can cause brain damage or death. Always read and understand instruction manual.	

For safe operation an adequate supply of fresh uncontaminated air for combustion and ventilation must be provided.

An insufficient supply of air can cause recirculation of combustion products resulting in contamination that may be hazardous to life. Such a condition often will result in a yellow, luminous burner flame, causing sooting of the combustion chamber, burners and flue tubes and creates a risk of asphyxiation.

Do not install the water heater in a confined space unless an adequate supply of air for combustion and ventilation is brought in to that space using the methods described in the Confined Space section that follows.

Never obstruct the flow of ventilation air. If you have any doubts or questions at all, call your gas supplier. Failure to provide the proper amount of combustion air can result in a fire or explosion and cause property damage, serious bodily injury or death.

UNCONFINED SPACE

An Unconfined Space is one whose volume IS NOT LESS THAN 50 cubic feet per 1,000 Btu/hr (4.8 cubic meters per kW) of the total input rating of all appliances installed in the space. Rooms communicating directly with the space, in which the appliances are installed, through openings not furnished with doors, are considered a part of the unconfined space.

Makeup air requirements for the operation of exhaust fans, kitchen ventilation systems, clothes dryers and fireplaces shall also be considered in determining the adequacy of a space to provide combustion, ventilation and dilution air.

UNUSUALLY TIGHT CONSTRUCTION

In unconfined spaces in buildings, infiltration may be adequate to provide air for combustion, ventilation and dilution of flue gases. However, in buildings of unusually tight construction (for example, weather stripping, heavily insulated, caulked, vapor barrier, etc.) additional air must be provided using the methods described in the Confined Space section that follows.

CONFINED SPACE

A Confined Space is one whose volume is less than 50 cubic feet per 1,000 Btu/hr (4.8 cubic meters per kW) of the total input rating of all appliances installed in the space.

Openings must be installed to provide fresh air for combustion, ventilation and dilution in confined spaces. The required size for the openings is dependent on the method used to provide fresh air to the confined space and the total Btu/hr input rating of all appliances installed in the space.

DIRECT VENT APPLIANCES

Appliances installed in a Direct Vent configuration that derive all air for combustion from the outdoor atmosphere through sealed intake air piping are not factored in the total appliance input Btu/hr calculations used to determine the size of openings providing fresh air into confined spaces.

EXHAUST FANS

Where exhaust fans are installed, additional air shall be provided to replace the exhausted air. When an exhaust fan is installed in the same space with a water heater, sufficient openings to provide fresh air must be provided that accommodate the requirements for all appliances in the room and the exhaust fan. Undersized openings will cause air to be drawn into the room through the water heater's vent system causing poor combustion. Sooting, serious damage to the water heater and the risk of fire or explosion may result. It can also create a risk of asphyxiation.

LOUVERS AND GRILLES

The free areas of the fresh air openings in the instructions that follow do not take in to account the presence of louvers, grilles or screens in the openings.

The required size of openings for combustion, ventilation and dilution air shall be based on the "net free area" of each opening. Where the free area through a design of louver or grille or screen is known, it shall be used in calculating the size of opening required to provide the free area specified. Where the louver and grille design and free area are not known, it shall be assumed that wood louvers will have 25% free area and metal louvers and grilles will have 75% free area. Non motorized louvers and grilles shall be fixed in the open position.

VENTING INSTALLATION

VENTING

THE INSTRUCTIONS IN THIS SECTION ON VENTING MUST BE FOLLOWED TO AVOID CHOKED COMBUSTION OR RECIRCULATION OF FLUE GASES. SUCH CONDITIONS CAUSE SOOTING OR RISKS OF FIRE AND ASPHYXIATION.

Heater must be protected from freezing downdrafts.

Remove all soot or other obstructions from the chimney that will retard a free draft.

Type B venting is recommended with these heaters. For typical venting application see TECHNICAL DATA VENTING on pages 19 and 20.

This water heater must be vented in compliance with all local codes, the current revision of the National Fuel Gas Code (ANSI-Z223.1) and with the Category I Venting Tables.

If any part of the vent system are exposed to ambient temperatures below 40°F it must be insulated to prevent condensation.

- Do not connect the heater to a common vent or chimney with solid fuel burning equipment. This practice is prohibited by many local building codes as is the practice of venting gas fired equipment to the duct work of ventilation systems.
- Where a separate vent connection is not available and the vent pipe from the heater must be connected to a common vent with an oil burning furnace, the vent pipe should enter the smaller common vent or chimney at a point above the large vent pipe.

VENT REDUCER

Model SBD71120(N,P)E is shipped with a 6" to 5" flue outlet adapter. Models SBD100250(N,P)E(A), SBD65251(N,P)E(A) and SBD100275(N,P)E(A) are shipped with a 8" to 6" flue outlet adapter.

Each adapter fits on top of the installed flue damper. Use only vent reducers supplied with the unit. The venting must comply with the current editions of the NATIONAL FUEL GAS CODE, ANSI Z223.1/ NFPA 54 or NATURAL GAS AND PROPANE INSTALLATION CODE CAN/CSA-B149.1

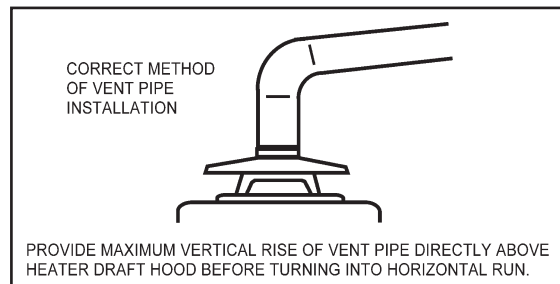

FIGURE 11.

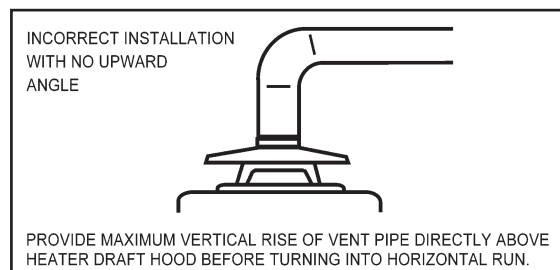

FIGURE 12.

MULTIPLE HEATER MANIFOLD

Figure 13 and tables on pages 19 and 20 should be used for horizontally manifolded two or more heaters.

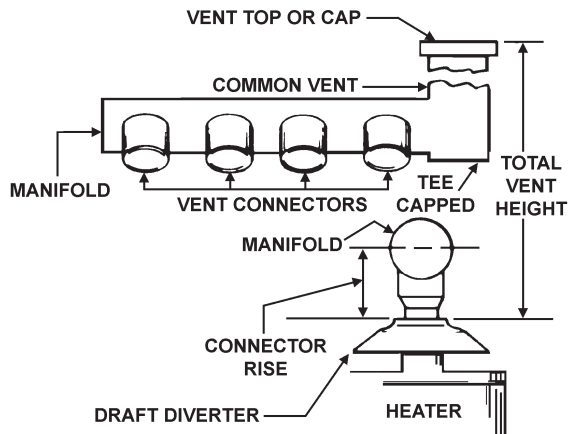

FIGURE 13.

FRESH AIR OPENINGS FOR CONFINED SPACES

The following instructions shall be used to calculate the size, number and placement of openings providing fresh air for combustion, ventilation and dilution in confined spaces. The illustrations shown in this section of the manual are a reference for the openings that provide fresh air into confined spaces only. DO NOT refer to these illustrations for the purpose of vent installation. See Venting Installation on page 16 for complete venting installation instructions.

OUTDOOR AIR THROUGH TWO OPENINGS

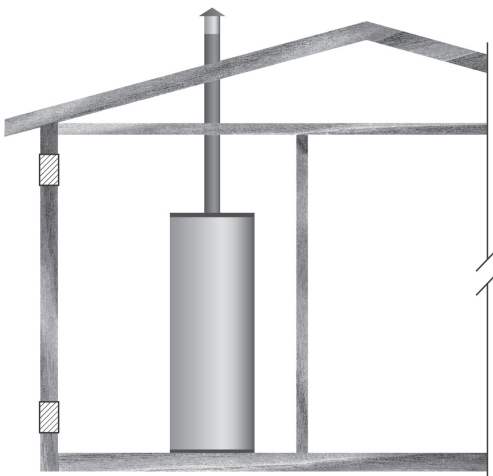

FIGURE 14.

The confined space shall be provided with two permanent openings, one commencing within 12 inches (300 mm) of the top and one commencing within 12 inches (300 mm) of the bottom of the enclosure. The openings shall communicate directly with the outdoors. See Figure 14.

Each opening shall have a minimum free area of 1 square inch per 4,000 Btu/hr (550 mm² per kW) of the aggregate input rating of all appliances installed in the enclosure. Each opening shall not be less than 100 square inches (645 cm²).

OUTDOOR AIR THROUGH ONE OPENING

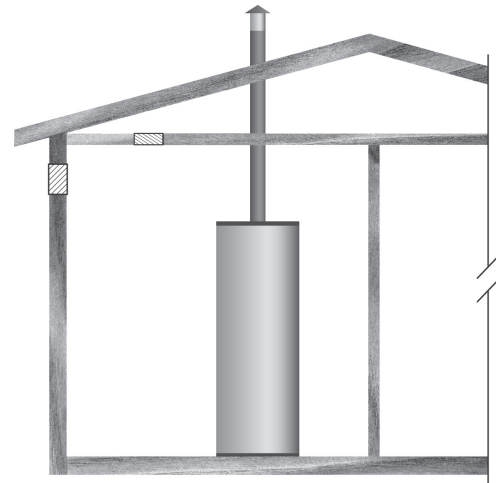

FIGURE 15.

Alternatively a single permanent opening, commencing within 12 inches (300 mm) of the top of the enclosure, shall be provided. See Figure 14. The water heater shall have clearances of at least 1 inch (25 mm) from the sides and back and 6 inches (150 mm) from the front of the water heater. The opening shall directly communicate with the outdoors or shall communicate through a vertical or horizontal duct to the outdoors or spaces that freely communicate with the outdoors and shall have a minimum free area of the following:

- 1 square inch per 3000 Btu/hr (733 mm² per kW) of the total input rating of all appliances located in the enclosure, and
- Not less than the sum of the areas of all vent connectors in the space.

OUTDOOR AIR THROUGH TWO HORIZONTAL DUCTS

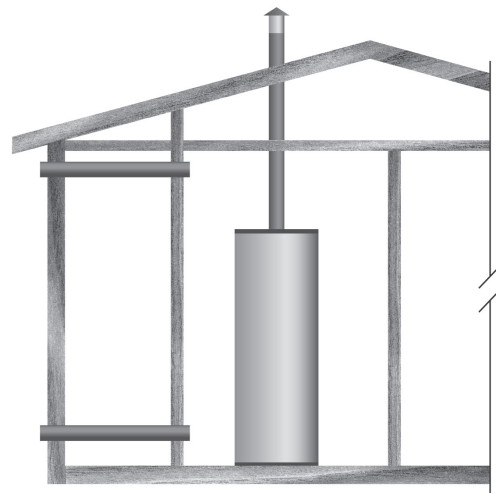

FIGURE 16.

The confined space shall be provided with two permanent horizontal ducts, one commencing within 12 inches (300 mm) of the top and one commencing within 12 inches (300 mm) of the bottom of the enclosure. The horizontal ducts shall communicate directly with the outdoors. See Figure 16.

Each duct opening shall have a minimum free area of 1 square inch per 2,000 Btu/hr (1100 mm² per kW) of the aggregate input rating of all appliances installed in the enclosure.

When ducts are used, they shall be of the same cross sectional area as the free area of the openings to which they connect. The minimum dimension of rectangular air ducts shall be not less than 3 inches.

OUTDOOR AIR THROUGH TWO VERTICAL DUCTS

The illustrations shown in this section of the manual are a reference for the openings that provide fresh air into confined spaces only.

DO NOT refer to these illustrations for the purpose of vent installation. See Venting Installation on page 14 for complete venting installation instructions.

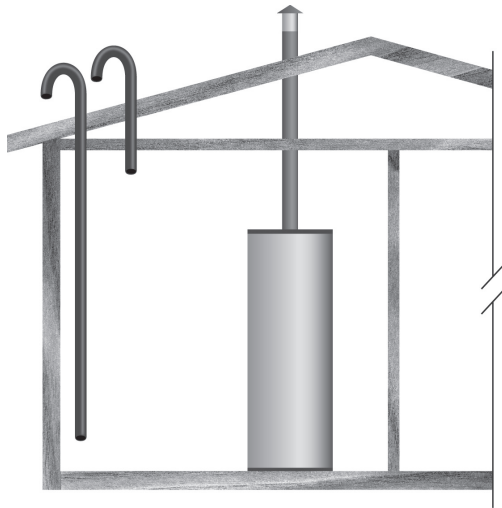

FIGURE 17.

The confined space shall be provided with two permanent vertical ducts, one commencing within 12 inches (300 mm) of the top and one commencing within 12 inches (300 mm) of the bottom of the enclosure. The vertical ducts shall communicate directly with the outdoors. See Figure 17.

Each duct opening shall have a minimum free area of 1 square inch per 4,000 Btu/hr (550 mm² per kW) of the aggregate input rating of all appliances installed in the enclosure.

When ducts are used, they shall be of the same cross sectional area as the free area of the openings to which they connect. The minimum dimension of rectangular air ducts shall be not less than 3 inches.

AIR FROM OTHER INDOOR SPACES

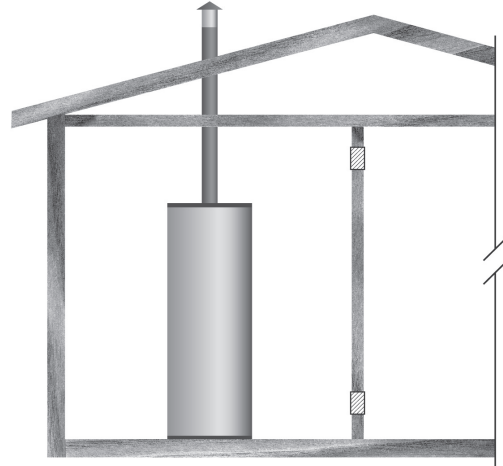

FIGURE 18.

The confined space shall be provided with two permanent openings, one commencing within 12 inches (300 mm) of the top and one commencing within 12 inches (300 mm) of the bottom of the enclosure. See Figure 18.

Each opening shall communicate directly with an additional room(s) of sufficient volume so that the combined volume of all spaces meets the criteria for an Unconfined Space.

Each opening shall have a minimum free area of 1 square inch per 1,000 Btu/hr (2200 mm² per kW) of the aggregate input rating of all appliances installed in the enclosure. Each opening shall not be less than 100 square inches (645 cm²).

TABLE 6. TECHNICAL DATA VENTING

**TYPE B GAS VENT
Multiple Gas Fired Tank-Type Heaters**

When venting multiple tank type heaters using Type B vent pipe, follow the installation diagram (figure 13) and tables below which give sizing and data based upon NFPA 54/ANSI Z223.

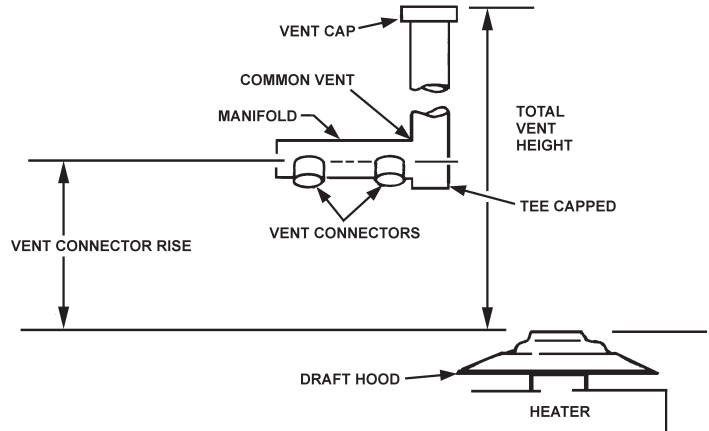

MODEL SBD71120(N,P)E											
Input: 120,000 Btuh		Total Vent Height (Feet)									
Draft Hood: 5"											
Input Btuh	Rise	Vent Connector Diameter (inches)									
		6	8	10	15	20	30	50	100		
		7	7	7	6	6	6	6	6		
		6	6	6	6	6	6	6	5		
120,000	2 Ft.	6	6	6	6	6	6	6	6	6	5
120,000	3 Ft.	6	6	6	6	6	6	5	5	5	5
Number of Heaters	Combined Input in Thousands of Btuh	Manifold and Common Vent Diameter (In inches)									
2	240	10	8	8	7	7	7	6	7		
3	360	10	10	10	10	8	8	7	7		
4	480	12	12	12	10	10	10	8	8		
MODEL SBD81154(N,P)E											
Input: 154,000 Btuh		Total Vent Height (Feet)									
Draft Hood: 6"											
Input Btuh	Rise	Vent Connector Diameter (in inches)									
		6	8	10	15	20	30	50	100		
		8	8	7	7	7	7	7	7		
		7	7	7	7	7	6	6	6		
154,000	1 Ft.	8	8	7	7	7	7	7	7	7	
154,000	2 Ft.	7	7	7	7	7	6	6	6	6	
154,000	3 Ft.	7	7	7	6	6	6	6	6	6	
Numbers of Heaters	Combined Input in Thousands of Btuh	Manifold and Common Vent Diameter (in inches)									
2	308	10	10	10	8	8	7	7	7		
3	462	12	12	12	10	10	10	8	8		
4	616	14	14	12	12	12	10	1	10		
MODEL SBD81180(N,P)E, SBD100199(N,P)ET, SBD100199(N,P)E, SBD81199(N,P)E, & SBD100199(N,P)ES(A)											
Input: 180,000, 199,000 Btuh		Total Vent Height (Feet)									
Draft Hood: 6"											
Input Btuh	Rise	Vent Connector Diameter (in inches)									
		6	8	10	15	20	30	50	100		
		8	8	8	8	8	7	7	7		
		-	-	8	8	8	8	8	7		
		8	8	7	7	7	7	7	7		
		8	8	8	8	7	7	7	7		
		7	7	7	7	7	7	6	6		
180,000	1 Ft.	8	8	8	8	8	7	7	7		
199,000	2 Ft.	8	8	7	7	7	7	7	7		
180,000	3 Ft.	7	7	7	7	7	7	6	6		
199,000	3 Ft.	8	8	7	7	7	7	7	6		
Number of Heaters	Combined Input in Thousands of Btuh	Manifold & Common Vent Diameter									
2	360	10	10	10	10	8	8	7	7		
	398	12	10	10	10	10	8	8	7		
3	540	14	12	12	12	10	10	10	8		
	597	14	14	12	12	12	10	10	10		
4	720	14	14	14	12	12	12	10	10		
	796	16	14	14	14	12	12	12	10		

MODEL SBD100250(N,P)E(A), SBD65251(N,P)E(A) TECHNICAL DATA VENTING, TABLE 6 (Continued)

Input: 250,000, 251,000			Total Vent Height (Feet)							
Draft Hood: 6"			6	8	10	15	20	30	50	100
Number of Heaters	Input Btuh	Rise	Vent Connector Diameter (in inches)							
	250/251,000	1 Ft.	-	-	-	-	-	-	8	8
	250/251,000	2 Ft.	-	-	-	8	8	8	8	8
	250/251,000	3 Ft.	-	8	8	8	8	8	8	7
Number of Heaters	Combined Input in Thousands of Btuh	Manifold and Common Vent Diameter (In inches)								
2	500/502	14	12	12	10	10	10	10	10	8
3	750/753	16	14	14	14	12	12	12	10	10
4	1000/1004	18	16	16	14	14	14	14	12	12

SBD100275(N,P)E(A)			Total Vent Height (Feet)							
Input: 275,000 Btuh			6	8	10	15	20	30	50	100
Draft Hood: 6"	Input Btuh	Rise	Vent Connector Diameter (in inches)							
	275,000	2 Ft.	-	-	-	-	-	8	8	8
	275,000	3 Ft.	-	-	-	8	8	8	8	8
Numbers of Heaters	Combined Input in Thousands of Btuh	Manifold and Common Vent Diameter (in inches)								
2	550	-	-	-	12	10	10	10	10	10
3	825	-	-	-	14	14	12	12	12	12
4	1100	-	-	-	16	14	14	14	12	12

SBD65305(P,N)E(A)			Total Vent Height (Feet)							
Input: 305,000 Btuh			6	8	10	15	20	30	50	100
Draft Hood: 8"	Input Btuh	Rise	Vent Connector Diameter (in inches)							
	305,000	1 Ft.	-	-	10	10	10	10	10	10
	305,000	2 Ft.	10	10	10	10	10	10	8	8
	305,000	3 Ft.	10	10	10	10	10	8	8	8
Number of Heaters	Combined Input in Thousands of Btuh	Manifold & Common Vent Diameter								
2	610	14	14	12	12	12	10	10	10	10
3	915	16	16	16	14	14	12	12	12	12
4	1220	18	18	16	16	16	14	14	14	12

SBD85365(N,P)E(A), SBD100399(N,P)E(A)			Total Vent Height (Feet)							
Input: 365,000, 399,000			6	8	10	15	20	30	50	100
Draft Hood: 8"	Input Btuh	Rise	Vent Connector Diameter (in inches)							
	365,000	1 Ft.	-	-	-	-	-	10	10	10
	399,000	1 Ft.	-	-	-	-	-	-	10	10
	365,000	2 FT.	12	12	10	10	10	10	10	10
	399,000	2 FT.	12	12	12	12	10	10	10	10
	365,000	3 FT.	10	10	10	10	10	10	10	10
	399,000	3 FT.	12	10	10	10	10	10	10	10
Number of Heaters	Combined Input in Thousands of Btuh	Manifold & Common Vent Diameter (inches)								
2	730	14	14	14	12	12	12	10	10	10
	798	16	14	14	14	12	12	10	10	10
3	1095	18	18	16	16	14	14	12	12	12
	1197	18	18	18	16	16	14	14	12	12
4	1460	20	20	18	18	16	16	14	12	12
	1596	22	20	20	18	18	16	14	14	14

MECHANICAL VENTING

SINGLE UNIT INSTALLATION

When mechanical venting of these heaters is desired, the following kits are available.

Models with inputs from 120,000 to 200,000 btu/h
Part number 9005381205

Models with inputs from 250,000 to 390,000 btu/h
Part number 9003434205

Where an approved power venter is to be installed to operate in conjunction with the water heater thermostat, the following codes must be adhered to. Field wiring should conform to the current edition of the National Electrical Code NFPA 70. For Canadian installations the electrical connections and grounding shall be done in accordance with the current edition

of the Canadian Electrical Code CSA C22.1 and/or local codes.

VENT INSTALLATION

Seal all joints between the power venter and the vent termination. This is to prevent leakage of exhaust products into the room(s) due to positive pressure of blower.

The "Sequence of Operation" description will be the same with mechanical venting except;

When the water heater thermostat calls for heat:

Thermostat contacts "Close" and the power venter blower (120 VAC) is energized. Sufficient draft must be established for the "Draft Prover Switch (N.O.)" to "Close". When the draft prover switch "Closes" the relay coil of the flue damper is energized.

WATER HEATER INSTALLATION

WATER LINE CONNECTIONS

The water piping installation must conform to these instructions and to all local code authority having jurisdiction. Good practice requires that all heavy piping be supported.

Read and observe all requirements in the following sections before installation of the water piping begins:

1. Water Temperature Control and Mixing Valves on page 13.
2. Dishwashing Machines on page 14.
3. Temperature-Pressure Relief Valve on page 14-15.
4. Closed Systems and Thermal Expansion on page 14.
5. For multiple water heater installations see Water Piping Diagrams beginning on page 40.

WATER (POTABLE) HEATING AND SPACE HEATING

1. All piping components connected to this unit for space heating applications shall be suitable for use with potable water.
2. Toxic chemicals, such as those used for boiler treatment, shall NEVER be introduced into this system.
3. This unit may NEVER be connected to any existing heating system or component(s) previously used with a non-potable water heating appliance.
4. When the system requires water for space heating at temperatures higher than required for domestic water purposes, a tempering valve must be installed. Please refer to installation diagrams beginning on page 40 of this manual for suggested piping arrangements.
5. These water heaters cannot be used in space heating applications only

THERMOMETERS (NOT SUPPLIED)

Thermometers should be obtained and field installed as shown in the installation diagrams.

Thermometers are installed in the system as a means of detecting the temperature of the outlet water supply.

WATER PIPING DIAGRAMS

This manual provides detailed water piping diagrams for typical methods of application for the water heaters, see Water Piping Diagrams beginning on page 40.

The water heater may be installed by itself, or with a separate storage tank. When used with a separate storage tank, the circulation may be either by gravity or by means of circulating pump. Adjust flow by throttling a full port ball valve installed in the circulating line on the outlet side of the pump. Never throttle flow on the suction side of a pump. See the Water Piping Diagrams beginning on page 40.

NOTE: In addition to the factory installed Temperature-Pressure Relief Valve (T&P valve) on the water heater, each remote storage tank that may be installed and piped to a water heating appliance must also have its own properly sized, rated and approved Temperature-Pressure Relief Valve installed.

Call the toll free technical support phone number listed on the back cover of this manual for further assistance in sizing a T&P valve for remote storage tanks.

T&P VALVE DISCHARGE PIPE

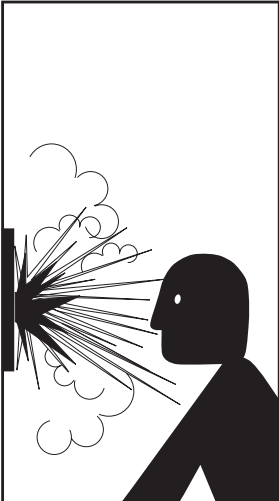
	! WARNING
	Explosion Hazard
	<ul style="list-style-type: none">• Temperature-Pressure Relief Valve must comply with ANSI Z21.22- CSA 4.4 and ASME code.• Properly sized temperature-pressure relief valve must be installed in opening provided.• Can result in overheating and excessive tank pressure.• Can cause serious injury or death.

This water heater is provided with a properly rated/sized and certified combination temperature - pressure (T&P) relief valve by the manufacturer. See Temperature-Pressure Relief Valve on pages 14-15 for information on replacement and other requirements.

CAUTION

Water Damage Hazard

- Temperature-Pressure Relief Valve discharge pipe must terminate at adequate drain.

Install a discharge pipe between the T&P valve discharge opening and a suitable floor drain. Do not connect discharge piping directly to the drain unless a 6" (15.2 cm) air gap is provided. To prevent bodily injury, hazard to life, or property damage, the relief valve must be allowed to discharge water in adequate quantities should circumstances demand. If the discharge pipe is not connected to a drain or other suitable means, the water flow may cause property damage.

T&P VALVE DISCHARGE PIPE REQUIREMENTS:

- Shall not be smaller in size than the outlet pipe size of the valve, or have any reducing couplings or other restrictions.
- Shall not be plugged or blocked.
- Shall not be exposed to freezing temperatures.

- Shall be of material listed for hot water distribution.
- Shall be installed so as to allow complete drainage of both Temperature-Pressure Relief Valve and the discharge pipe.
- Must terminate a maximum of six inches above a floor drain or external to the building. In cold climates, it is recommended that the discharge pipe be terminated at an adequate drain inside the building.
- Shall not have any valve or other obstruction between the relief valve and the drain.

INSTALLATION DIAGRAMS - TOP INLET/OUTLET USAGE

Use of the top inlet water connection requires an inlet dip tube (refer to figure 19). The tube is supplied in the heater. Follow caution labels if applying heat to this fitting. Do not allow pipe dope to contact the plastic tube during installation.

TUBE INLET INSTALLATION

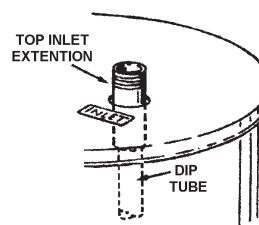

FIGURE 19.

HEATER WIRING

All electrical work must be installed in accordance with the current edition of the National Electrical Code ANSI/NFPA No. 70 or Canadian Electrical Code CSA C22.1 and must conform to all local code authority having jurisdiction. AN ELECTRICAL GROUND IS REQUIRED TO REDUCE RISK OF ELECTRICAL SHOCK OR POSSIBLE ELECTROCUTION.

If any of the original wire as supplied with the water heater must be replaced, use only type 105°C thermoplastic or equivalent 250°C type F must be used for the flame sensor and igniter leads.

The controls of this water heater are polarity sensitive. Be certain to properly wire the hot and neutral connections.

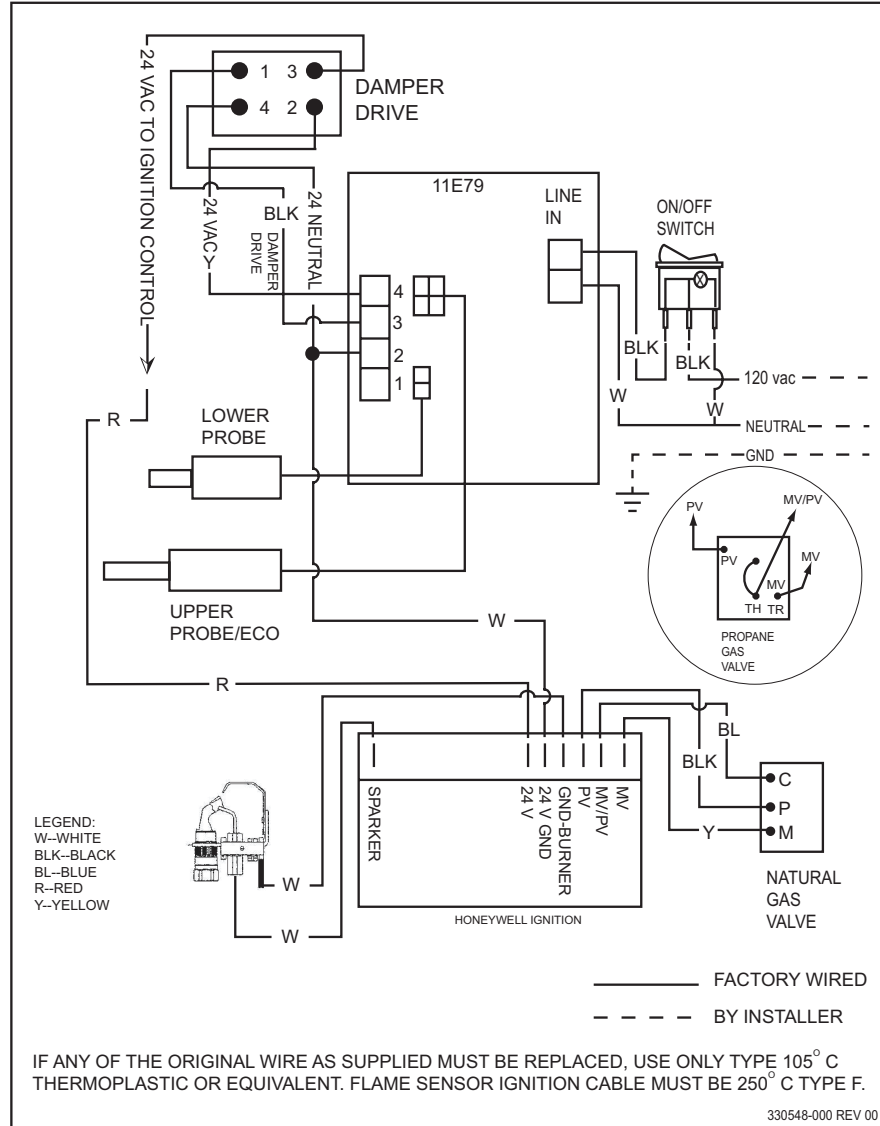

FIGURE 20.

GAS PIPING

Contact your local gas service company to ensure that adequate gas service is available and to review applicable installation codes for your area.

Size the main gas line in accordance with Table 7. The figures shown are for straight lengths of pipe at 0.5 in. W.C. pressure drop, which is considered normal for low pressure systems. Note: Fittings such as elbows, tees and line regulators will add to the pipe pressure drop. Also refer to the latest version of the National Fuel Gas Code.

Schedule 40 Steel or Wrought Iron Pipe is the preferred material for the gas line of this water heater. It is imperative to follow the sizing recommendations in the latest version of the National Fuel Gas Code if Corrugated Stainless Steel Tubing (CSST) is used as the gas line for this water heater.

The heater is not intended for operation at higher than 14.0" W.C.-natural gas, (1/2 pound per square inch gage) supply gas pressure. Exposure to higher supply pressure may cause damage to the gas valve which could result in fire or explosion. If overpressure has occurred such as through improper testing of gas lines or emergency malfunction of the supply system, the gas valve must be checked for safe operation. Make sure that the outside vents on the supply regulators and the safety vent valves are protected against blockage. These are parts of the gas supply system, not the heater. Vent blockage may occur during ice storms.

**TABLE 7. GAS SUPPLY PIPE LENGTHS (IN FEET)
Maximum Equivalent Pipe Length - Natural Gas Only**

Input rate (BTU/HR)	Schedule 40 Steel or Wrought Iron Pipe				
	1/2"	3/4"	1"	1 1/4"	1 1/2"
120,000	20	70	200	200	200
154,000	10	40	150	200	200
180,000	-	30	100	200	200
199,000	-	30	90	200	200
250,000	-	20	60	200	200
275,000	-	10	50	200	200
310,000	-	10	40	150	200
366,000	-	-	30	100	200
390,000	-	-	20	100	200
Fitting Type*	Equivalent length in feet				
45°El	0.7	1.0	1.2	1.6	1.9
90°El	1.6	2.1	2.6	3.5	4.0
Tee	3.1	4.1	5.2	6.9	8.0

Natural Gas 0.60 Specific Gravity, 0.50" W.C. Pressure Drop

*Screwed Fittings

It is important to guard against gas valve fouling from contaminants in gas ways. Such fouling may cause improper operation, fire or explosion.

If copper supply lines are used they must be internally tinned and certified for gas service. Before attaching the gas line, be sure that all gas pipe is clean on the inside.

To trap any dirt or foreign material in the gas supply line, a sediment trap must be incorporated in the piping (see Figure 21). The sediment trap must be readily accessible and not subject to freezing conditions. Install in accordance with recommendations of serving gas suppliers. Refer to the latest version of the National Fuel Gas Code.

To prevent damage, care must be taken not to apply too much torque when attaching gas supply pipe to gas valve inlet.

Apply joint compounds (pipe dope) sparingly and only to the male threads of pipe joints. Do not apply compounds to the first two threads. Use compounds resistant to the action of liquefied petroleum gases.

GAS METER SIZE – NATURAL GASES ONLY

Be sure the gas meter has sufficient capacity to supply the full rated gas input of the water heater as well as the requirements of all other gas fired equipment supplied by the meter. If gas meter is too small, ask the gas company to install a larger meter having adequate capacity.

GAS PIPING AND SEDIMENT TRAP INSTALLATION

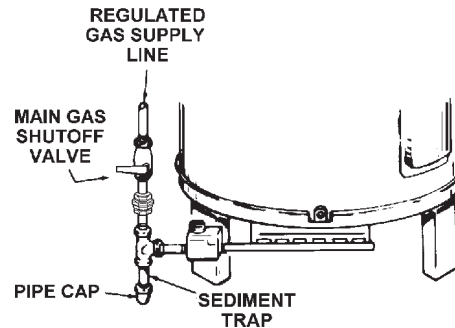

FIGURE 21.

GAS LINE LEAK TESTING



WARNING

Fire and Explosion Hazard

- Use joint compound or Teflon tape compatible with propane gas.
- Leak test before placing the water heater in operation.
- Disconnect gas piping and main gas shutoff valve before leak testing.
- Install sediment trap in accordance with NFPA 54.

Any time work is done on the gas supply system perform a leak test to avoid the possibility of fire or explosion.

1. For test pressures exceeding 1/2 psi (3.45 kPa) disconnect the water heater and its Main Gas Shutoff Valve from the gas supply piping system during testing, see Figure 21. The gas supply line must be capped when disconnected from the water heater.
2. For test pressures of 1/2 psi (3.45 kPa) or less, the water heater need not be disconnected, but must be isolated from the supply gas line by closing the Main Gas Shutoff Valve during testing.
3. Coat all supply gas line joints and connections upstream of the water heater with a non-corrosive soap and water solution to test for leaks. Bubbles indicate a gas leak. Do not use matches, candles, flame or other sources of ignition for this purpose.
4. Repair any leaks before placing the water heater in operation.

PURGING

Gas line purging is required with new piping or systems in which air has entered.

Purging should be performed per the current edition of NFPA 54 the National Fuel Gas Code.

OPERATION

WARNING

Fire or Explosion Hazard

- Gas line purging is required with new piping or systems in which air has entered.
- To avoid risk of fire or explosion purge discharge must not enter into confined areas or spaces where ignition can occur.
- The area must be well ventilated and all sources of ignition must be deactivated or removed.



Read instruction manual before installing, using or servicing water heater.



PRIOR TO START UP

Installation and start up of this water heater requires abilities and skills equivalent to that of a licensed tradesman in the field involved, see Qualifications on page 6.

Do not place the water heater in operation if any part has been under water. Immediately call a qualified service technician to inspect the water heater and to replace any part of the control system and any gas control which has been under water.

Light the water heater in accordance with the Lighting and Operation Instruction label on the water heater and in this manual on pages 27 and 28.

The water heaters covered by this manual are equipped with an electronic control system that automatically sequences the Igniter, the 24 VAC Gas Valve, the Burner ignition, and flame sensing.

Before attempting start up, thoroughly study and know the exact Sequence Of Operation. See written Sequence Of Operation on page 25 and Sequence Of Operation Flow Chart on page 26.

Be certain that the water heater is full of water, that air is purged from the gas and water lines and that there are no leaks in the gas and water lines. Ensure all inlet water valves are open.

FILLING THE WATER HEATER

Follow these steps to fill the water heater prior to start up.

1. Close the heater drain valve.
2. Open a nearby hot water faucet to permit air in system to escape.
3. Fully open the cold water inlet valve allowing the piping and water heater to fill with water.
4. Close hot water faucet opened in Step 2 as water starts to flow.

Read SEQUENCE OF OPERATION section of this manual prior to lighting and operating this water heater.

With above conditions satisfied, start the unit in accordance with the instructions on the operating label attached to the heater. For your convenience a copy of the instructions are shown on pages 27 and 28.

SEQUENCE OF OPERATION

The following information will describe the Sequence of Operation for this water heater.

1. Switch power on to unit.
2. Thermostat calls for heat.
3. Ignition Control performs diagnostic self check on system components.
4. The Ignition Control begins the trial for ignition.
5. The Ignition Control turns on the Spark Igniter and opens the Pilot Gas Valve.
6. The Ignition Control monitors the Flame Sensor during the ignition trial period.
7. If the Ignition Control does not sense the pilot flame during the ignition trial period, the Ignition Control shuts the Pilot Gas Valve and turns off the Spark Igniter. Depending on the water heater model, the Ignition Control will either retry the ignition trial at step 4 or lockout the ignition sequence. If the ignition sequence is locked out, the power to the unit must be cycled to restart the Ignition Control.
8. If the pilot flame is proved during the ignition trial period, the Ignition Control turns off the Spark Igniter and opens the Main Gas Valve.
9. The Ignition Control allows a 2 second pilot flame stabilization period to insure that the pilot flame is not extinguished by the main burner light-off process.
10. The Ignition Control monitors the Flame Sensor during the heating cycle. If the flame signal is lost, the Ignition Control shuts the Main Gas Valve and Pilot Gas Valve and re-starts the ignition process at step 4.
11. Once the unit is satisfied, the Ignition Control will shut off the Main Gas Valve and the Pilot Gas Valve and the unit will be in standby mode until another call for heat is initiated by the thermostat.

See the flow chart on page 26 for more information.

SEQUENCE OF OPERATION FLOW CHART

Description of this flow chart can be found in the "SEQUENCE OF OPERATION" section found on page 25.

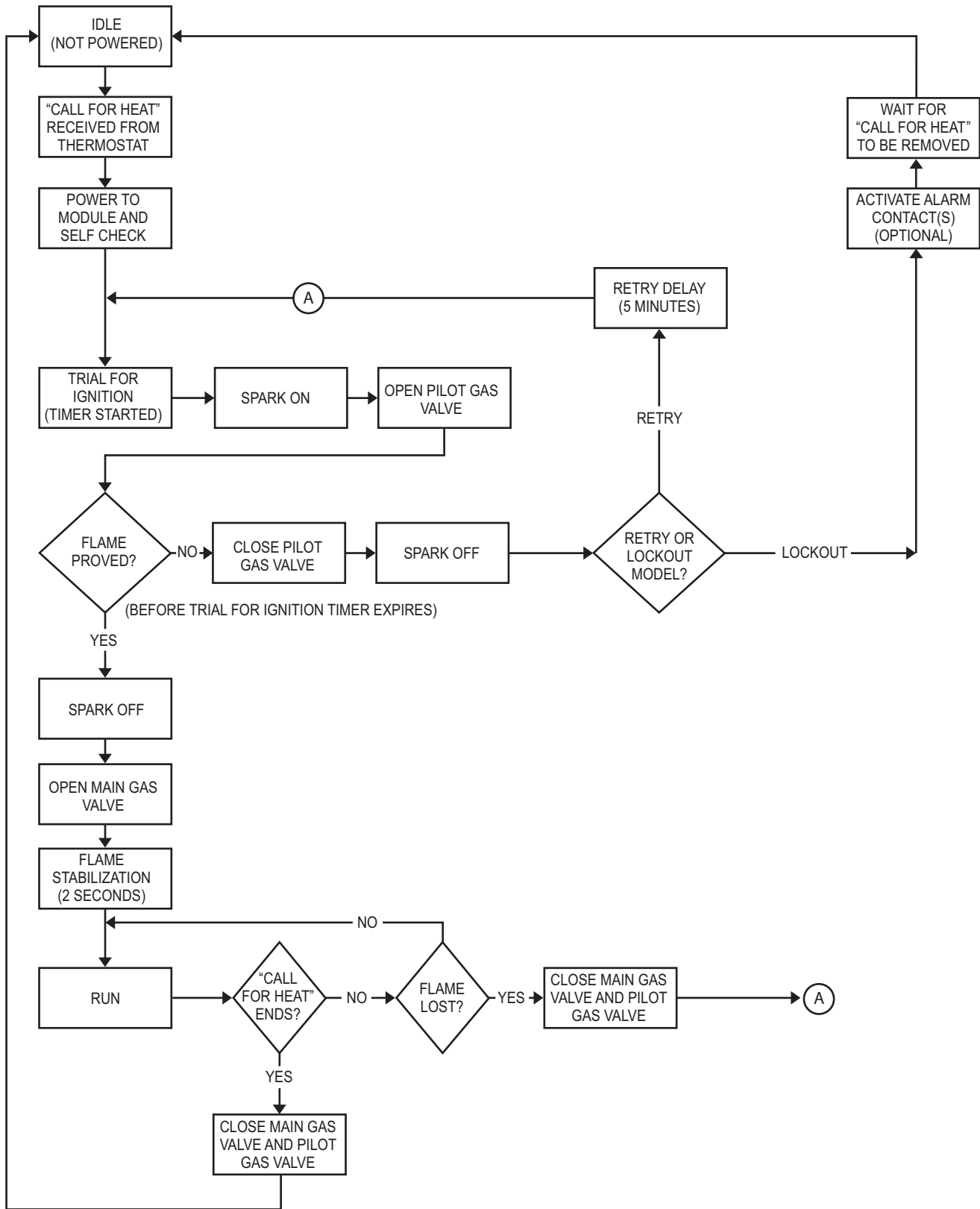

FLOW CHART 1.

FOR YOUR SAFETY READ BEFORE OPERATING



WARNING If you do not follow these instructions exactly, a fire or explosion may result causing property damage, personal injury, or loss of life.



- A. This appliance is equipped with an ignition device which automatically lights the pilot. Do not try to light the pilot by hand.
- B. BEFORE OPERATING smell all around the appliance area for gas. Be sure to smell next to the floor because some gas is heavier than air and will settle on the floor.

"WHAT TO DO IF YOU SMELL GAS"

- Do not try to light any appliance.
- Do not touch any electric switch; do not use any telephone in your building.
- Immediately call your gas supplier from a neighbor's telephone. Follow the gas suppliers instructions.
- If you cannot reach your gas supplier, call the fire department.

- C. Use only your hand to switch the gas valve on or off. Never use tools. If the on/off switch will not move, don't try to repair it. Call a qualified service technician. Force or attempted repair may result in a fire or explosion.
- D. Do not use this appliance if any part has been under water. Immediately call a qualified service technician to inspect the appliance and to replace any part of the control system and any gas control which has been under water.

OPERATING INSTRUCTIONS

1. STOP! Read the safety information above on this label.
2. Set thermostat to lowest setting.
3. Turn off all electric power to the appliance.
4. This appliance is equipped with an ignition device which automatically lights the burner. Do not try to light the burner by hand.
5. Move "Off/On" switch to the "Off" position. Wait five(5) minutes to clear out any gas. If you then smell gas, STOP!. Follow "B" in the safety information above on this label. If you don't smell gas, go on to next step.
6. Move "Off/On" switch to the "On" position.

7. Turn on all electric power to the appliance.
8. Set thermostat to desired setting.
9. If the appliance will not operate, follow the instructions "To Turn Off Gas To Appliance" and call your service technician or gas supplier.

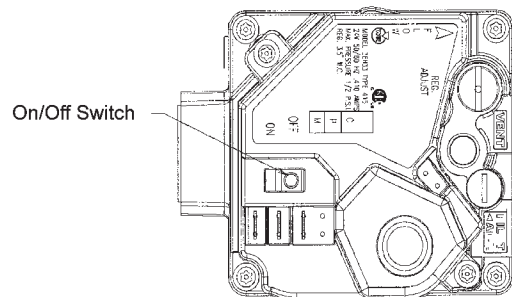

FOR YOUR SAFETY READ BEFORE OPERATING

1. Set the thermostat to lowest setting.
2. Turn off all electric power to appliance if service is to be performed.
3. Move "Off/On" switch to the "Off" position. do not force.

FIGURE 22. LABEL FOR NATURAL GAS MODELS

FOR YOUR SAFETY READ BEFORE OPERATING



WARNING

If you do not follow these instructions exactly, a fire or explosion may result causing property damage, personal injury, or loss of life.



A. This appliance does not have a pilot. It is equipped with an ignition device which automatically lights the burner. Do not try to light the pilot by hand.

B. BEFORE OPERATING smell all around the appliance area for gas. Be sure to smell next to the floor because some gas is heavier than air and will settle on the floor.

"WHAT TO DO IF YOU SMELL GAS"

- Do not try to light any appliance.
- Do not touch any electric switch; do not use any telephone in your building.
- Immediately call your gas supplier from a neighbor's telephone. Follow the gas suppliers instructions.
- If you cannot reach your gas supplier, call the fire department.

C. Use only your hand to push in or turn the gas control knob. Never use tools. If the knob will not push in or turn by hand, don't try to repair it. Call a qualified service technician. Force or attempted repair may result in a fire or explosion.

D. Do not use this appliance if any part has been under water. Immediately call a qualified service technician to inspect the appliance and to replace any part of the control system and any gas control which has been under water.

OPERATING INSTRUCTIONS

1. STOP! Read the safety information above on this label.
2. Set thermostat to lowest setting.
3. Turn off all electric power to the appliance.
4. This appliance is equipped with an ignition device which automatically lights the burner. Do not try to light the burner by hand.
5. Turn top knob of the gas control valve clockwise to the "OFF" position. Note: It may be necessary to slightly depress knob while turning. Do not force knob.
6. Wait five (5) minutes to clear out any gas. If you then smell gas, STOP!! Follow "B" in the safety information above on this label. If you do not smell gas, go to the next step.
7. Turn gas control top knob counter clockwise to "ON" position. Do not force knob.
8. Turn on all electrical power to the appliance.
9. Set thermostat to desired setting.
10. If the appliance will not operate, follow the instructions "To Turn Off Gas To Appliance" and call your service technician or gas supplier.

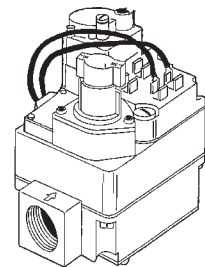
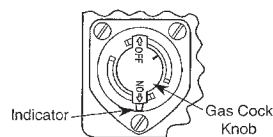

TO TURN OFF GAS TO APPLIANCE

1. Set the thermostat to lowest setting.
2. Turn off all electric power to appliance if service is to be performed.
3. Turn top knob of gas control valve clockwise to "OFF" position. Do not force.

FIGURE 23. LABEL FOR PROPANE GAS MODELS

ADJUSTMENTS

ON INITIAL STARTUP SOME ADJUSTMENTS MAY BE NECESSARY.

Check Manifold and inlet gas pressures (see GAS SUPPLY SYSTEMS on page 13 and CHECKING THE INPUT on page 29-30.)

Check Pilot Burner (See Pilot Burner section on page 34.)

TESTING DAMPER OPERATION

With the Service Switch in the AUTOMATIC OPERATION position, check the operation of the flue damper three (3) times with the water operating controls for proper operating sequence:

- The damper disc must be open (in the vertical position) before the ignition and combustion process begins.
- The damper disc must be in the open position when the main burner is firing.
- The gas control valve must close and the main burner must have ceased firing before the damper disc begins its return to the closed (horizontal) position.

If during testing of the operation of the damper you find that there is a problem with the operation of the water heater when the Service Switch is in the AUTOMATIC OPERATION position: Reset the Service Switch to the HOLD OPEN DAMPER position and check operation again.

If the water heater does operate when placed in the HOLD OPEN DAMPER position:

- Refer to the EFFIKAL RVGP-FSF-SERIES TROUBLESHOOTING GUIDE on page 37.

If the water heater does not operate with the Service Switch in either position:

- Refer to the Troubleshooting Sections and Troubleshooting Checklist.

CHECKING VENTING

The following steps shall be followed with each appliance connected to the venting system placed in operation, while any other appliances connected to the venting system are not in operation.

1. Seal any unused openings in the venting system.
2. Inspect the venting system for proper size and horizontal pitch, as required in the National Fuel Gas Code, ANSI Z223.1 or the CAN/CGA B149 Installation Codes and these instructions. Determine that there is no blockage or restriction, leakage, corrosion and other deficiencies which could cause an unsafe condition.
3. So far as is practical, close all building doors and windows and all doors between the space in which the water heater(s) connected to the venting system are located and other spaces of the building. Turn on all appliances not connected to the venting system. Turn on all exhaust fans, such as range hoods and bathroom exhausts, so they shall operate at maximum speed. Close fireplace dampers.
4. Follow the lighting instruction. Place the water heater being inspected in operation. Adjust thermostat so water heater shall operate continuously.
5. Test for draft hood spillage at the relief opening after 5 minutes of main burner operation.
6. After it has been determined that each appliance connected to the venting system properly vents when tested as outlined above, return doors, windows, exhaust fans, fireplace dampers and any other gas burning appliance to their previous conditions of use.
7. If improper venting is observed during any of the above tests, the venting system must be corrected.

FAILURE TO CORRECT BACK DRAFTS MAY CAUSE AIR CONTAMINATION AND UNSAFE CONDITIONS.

- If the back draft cannot be corrected by the normal method or if a suitable draft cannot be obtained, a blower type flue gas exhauster must be employed to assure proper venting and correct combustion.

CHECKING THE INPUT

For installation locations with elevations above 2000 feet, refer to HIGH ALTITUDE INSTALLATIONS section of this manual for input reduction procedure.

1. Attach a pressure gauge or a manometer to the manifold pressure tap on the gas control valve and refer to Table 8, for correct manifold pressure.
2. Use this formula to "clock" the meter. Be sure that other gas consuming appliances are not operating during this interval.

$$(3600/T) \times H = \text{Btuh}$$

T = Time in seconds to burn one cubic foot of gas.

H = Btu's per cubic foot of gas.

Btuh = Actual heater input.

Example:

T = 15.1 seconds

H = 1050 Btu

Btuh = ?

$$(3600/15.1) \times 1050 = 250,000$$

TABLE 8.
APPROXIMATE TIME REQUIRED TO CONSUME
1 CU. FT. OF GAS AT FULL CAPACITY

INPUT RATE (BTUH)	TYPE OF GAS	BTUH PER CU. FT.	TIME REQ'D TO CONSUME 1 CU. FT. OF GAS
120,000	NATURAL PROPANE	1050 2500	31.5 SEC. 75.0 SEC.
154,000	NATURAL PROPANE	1050 2500	24.5 SEC. 58.4 SEC.
180,000	NATURAL PROPANE	1050 2500	21.0 SEC. 50.0 SEC.
199,000	NATURAL PROPANE	1050 2500	19.0 SEC. 45.2 SEC.
250,000	NATURAL PROPANE	1050 2500	15.1 SEC. 36.0 SEC.
251,000	NATURAL PROPANE	1050 2500	15.1 SEC. 35.9 SEC.
275,000	NATURAL PROPANE	1050 2500	13.7 SEC. 32.7 SEC.
305,000	NATURAL PROPANE	1050 2500	12.4 SEC. 29.5 SEC.
365,000	NATURAL PROPANE	1050 2500	10.4 SEC. 24.7 SEC.
390,000	NATURAL PROPANE	1050 2500	9.7 SEC. 23.1 SEC.

Should it be necessary to adjust the gas pressure to the burners to obtain the full input rate, the steps below should be followed:

3. Remove the regulator adjustment sealing cap and adjust the pressure by turning the adjusting screw with a screwdriver. See Figure 24.

↻ Clockwise to increase gas pressure and input rate.

↻ Counterclockwise to decrease gas pressure and input rate.

4. "Clock" the meter as in step 2 above.
5. Repeat steps 3 and 4 until the specified input rate is achieved.
6. Turn the gas control knob to PILOT. Remove the pressure gauge and replace the sealing cap and the Allen wrench set screw in the pressure tap opening.

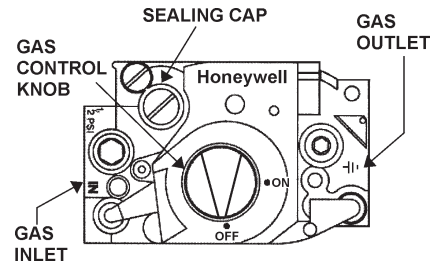

FIGURE 24.

UNDER NO CIRCUMSTANCES SHOULD THE GAS INPUT EXCEED THE INPUT SHOWN ON THE HEATER MODEL AND RATING PLATE. OVERFIRING COULD RESULT IN DAMAGE OR SOOTING OF THE HEATER.

MAINTENANCE

VENTING SYSTEM

Examine the venting system every six months for obstructions and/or deterioration of the vent piping.

Remove all soot or other obstructions from chimney which will retard free draft.

REMOTE STORAGE TANK TEMPERATURE CONTROL

The water temperature in the remote storage tank (if used) is controlled by the storage tank temperature control. The sensing element is mounted in the hot water storage tank, see Water Piping Diagram section.

A change in water temperature in the storage tank lower than the tank temperature control setting will cause the sensor to activate the circulating pump. The pump then circulates the water through the heater where the thermostat senses the drop in water temperature and activates main burner operation of the water heater.

If the storage tank temperature control is out of calibration, replace with new control.

SHOULD OVERHEATING OCCUR OR THE GAS SUPPLY FAIL TO SHUT OFF, TURN OFF THE MANUAL GAS CONTROL VALVE TO THE WATER HEATER.

TEMPERATURE-PRESSURE RELIEF VALVE TEST

	<ul style="list-style-type: none">• Burn hazard.• Hot water discharge.• Keep clear of Temperature-Pressure Relief Valve discharge outlet.
---	---

It is recommended that the Temperature-Pressure Relief Valve should be checked to ensure that it is in operating condition every 6 months.

When checking the Temperature-Pressure Relief Valve operation, make sure that (1) no one is in front of or around the outlet of the Temperature-Pressure Relief Valve discharge line, and (2) that the water discharge will not cause any property damage, as the water may be extremely hot. Use care when operating valve as the valve may be hot.

To check the pressure relief valve, lift the lever at the end of the valve several times, see Figure 25. The valve should seat properly and operate freely.

If after manually operating the valve, it fails to completely reset and continues to release water, immediately close the cold water inlet to the water heater and drain the water heater, see Draining And Flushing on page 32. Replace the Temperature-Pressure Relief

Valve with a properly rated/sized new one, see Temperature-Pressure Relief Valve on pages 12-13 for instructions on replacement.

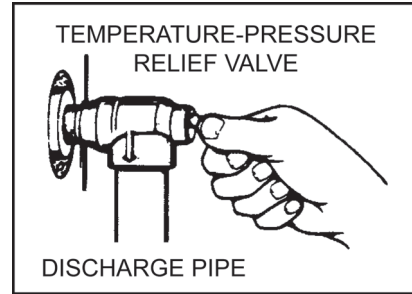

FIGURE 25.

If the Temperature-Pressure Relief Valve on water heater weeps or discharges periodically, this may be due to thermal expansion.

NOTE: Excessive water pressure is the most common cause of Temperature-Pressure Relief Valve leakage. Excessive water system pressure is most often caused by "thermal expansion" in a "closed system." See Closed Water Systems and Thermal Expansion on page 14. The Temperature-Pressure Relief Valve is not intended for the constant relief of thermal expansion.

Temperature-Pressure Relief Valve leakage due to pressure build up in a closed system that does not have a thermal expansion tank installed is not covered under the limited warranty. Thermal expansion tanks must be installed on all closed water systems.

DO NOT PLUG THE TEMPERATURE-PRESSURE RELIEF VALVE OPENING. THIS CAN CAUSE PROPERTY DAMAGE, SERIOUS INJURY OR DEATH.

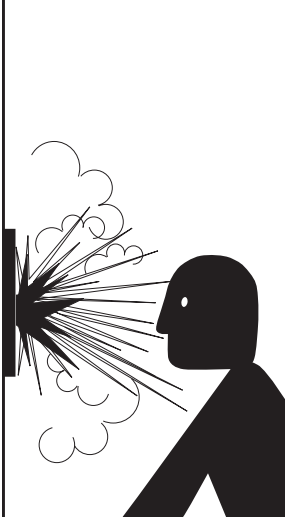
	WARNING
	Explosion Hazard <ul style="list-style-type: none">• Temperature-Pressure Relief Valve must comply with ANSI Z21.22-CSA 4.4 and ASME code.• Properly sized temperature-pressure relief valve must be installed in opening provided.• Can result in overheating and excessive tank pressure.• Can cause serious injury or death.

ANODE ROD INSPECTION

CAUTION
Property Damage Hazard
<ul style="list-style-type: none">• Avoid water heater damage.• Inspection and replacement of anode rod required.

The anode rod is used to protect the tank from corrosion. Most hot water tanks are equipped with an anode rod. The submerged rod sacrifices itself to protect the tank. Instead of corroding tank,

water ions attack and eat away the anode rod. This does not affect water's taste or color. The rod must be maintained to keep tank in operating condition.

Anode rod deterioration depends on water conductivity, not necessarily water condition. A corroded or pitted anode rod indicates high water conductivity and should be checked and/or replaced more often than an anode rod that appears to be intact. Replacement of a depleted anode rod can extend the life of your water heater. Inspection should be conducted by a qualified technician, and at a minimum should be checked annually after the warranty period.

Artificially softened water is exceedingly corrosive because the process substitutes sodium ions for magnesium and calcium ions.

The use of a water softener may decrease the life of the water heater tank.

The anode rod should be inspected after a maximum of three years and annually thereafter until the condition of the anode rod dictates its replacement. Anode replacement is not covered by warranty. NOTE: artificially softened water requires the anode rod to be inspected annually.

DRAINING AND FLUSHING



- Burn hazard.
- Hot water discharge.
- Keep hands clear of drain valve discharge.

It is recommended that the water heater storage tank be drained and flushed every 6 months to reduce sediment buildup. The water heater should be drained if being shut down during freezing temperatures. See Features And Components in this manual for the location of the water heater components described below.

TO DRAIN THE WATER HEATER STORAGE TANK:

1. Turn off the electrical supply to the water heater.
2. Turn off the gas supply at the Main Gas Shutoff Valve if the water heater is going to be shut down for an extended period.
3. Ensure the cold water inlet valve is open.
4. Open a nearby hot water faucet and let the water run until the water is no longer hot.
5. Close the cold water inlet valve to the water heater.
6. Connect a hose to the water heater drain valve and terminate it to an adequate drain.
7. Open the water heater drain valve and allow all the water to drain from the storage tank.
8. Close the water heater drain valve when all water in the storage tank has drained.
9. Close the hot water faucet opened in Step 4.
10. If the water heater is going to be shut down for an extended period, the drain valve should be left open.

TO FLUSH THE WATER HEATER STORAGE TANK:

1. Turn off the electrical supply to the water heater.
2. Ensure the cold water inlet valve is open.
3. Open a nearby hot water faucet and let the water run until the water is no longer hot. Then close the hot water faucet.
4. Connect a hose to the drain valve and terminate it to an adequate drain.

5. Ensure the drain hose is secured before and during the entire flushing procedure. Flushing is performed with system water pressure applied to the water heater.
6. Open the water heater drain valve to flush the storage tank.
7. Flush the water heater storage tank to remove sediment and allow the water to flow until it runs clean.
8. Close the water heater drain valve when flushing is completed.
9. Remove the drain hose.
10. Fill the water heater - see Filling The Water Heater in this manual.
11. Turn on the electrical supply to place the water heater back in operation.
12. Allow the water heater to complete several heating cycles to ensure it is operating properly.

RECOMMENDED PROCEDURE FOR PERIODIC REMOVAL OF LIME DEPOSITS FROM TANK TYPE COMMERCIAL WATER HEATERS

The amount of calcium carbonate (lime) released from water is in direct proportion to water temperature and usage, see chart. The higher the water temperature or water usage, the more lime deposits are dropped out of the water. This is the lime scale which forms in pipes, heaters and on cooking utensils.

Lime accumulation not only reduces the life of equipment but also reduces efficiency of the heater and increases fuel consumption.

The usage of water softening equipment greatly reduces the hardness of the water. However, this equipment does not always remove all of the hardness (lime). For this reason it is recommended that a regular schedule for deliming be maintained.

The time between cleaning will vary from weeks to months depending upon water conditions and usage.

The depth of lime buildup should be measured periodically. Heaters equipped with cleanouts will have about 2" of lime buildup when the level of lime has reached the bottom of the cleanout opening. A schedule for deliming should then be set up, based on the amount of time it would take for a 1" buildup of lime. It is recommended that the water heater initially be inspected after 6 months.

Example 1:

Initial inspection after 6 months shows 1/2" of lime accumulation. Therefore, the heater should be delimed once a year.

Example 2:

Initial inspection after 6 months shows 2" of lime accumulation. Therefore, the heater should be delimed every 3 months.

POUNDS OF LIME DEPOSITED VS. TEMPERATURE AND WATER USAGE

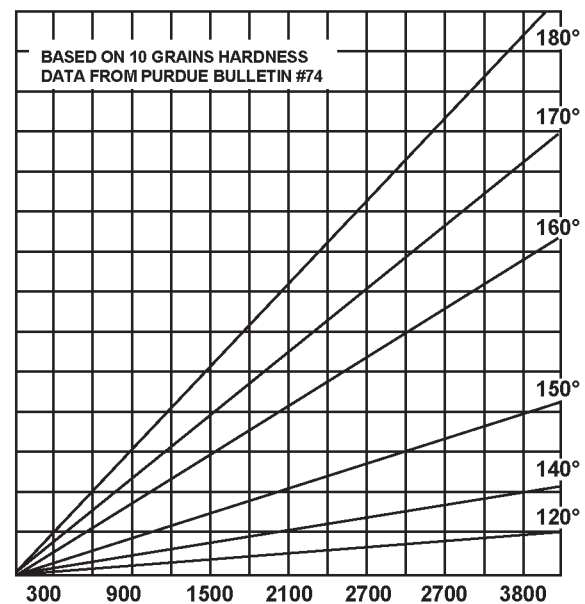

FIGURE 26.

DELIMING SOLVENTS

UN•LIME is recommended for deliming. UN•LIME is a patented food grade acid which is safe to handle and does not create the harmful fumes which are associated with other products.

UN•LIME may be obtained from your dealer, distributor or water heater manufacturer. Order Part Number 9005416105, 1 gallon, packed 4 gallons per case or Part Number 9005417105, 5 gallon container.

NOTE: Un•Lime is not available for use in Canada.

Hydrochloric base acids are not recommended for use on glass lined tanks.

Observe handling instructions on label of product being used.

TANK CLEANOUT PROCEDURE

The following practices will ensure longer life and enable the unit to operate at its designed efficiency:

1. Once a month the heater should be flushed. Open the drain valve and allow two gallons of water to drain from the heater. Inlet water valve should remain open to maintain pressure in tank.
2. A cleanout opening is provided for periodic cleaning of the tank. Gas must be shut off and heater drained before opening cleanout.

To clean heater through cleanout opening, proceed as follows:

3. Drain heater.
4. Remove outer cover plate from lower side of heater jacket.
5. Remove six (6) hex head screws securing tank cleanout plate and remove plate.
6. Remove lime, scale, or sediment using care not to damage the glass lining.
7. Inspect cleanout plate gasket, if new gasket is required, replace with part no. 9004099215.
8. Install cleanout plate. Be sure to draw plate up tight by tightening screws securely.
9. Replace outer jacket cover plate.

In some water areas the sediment might not be removed by this method and may result in the water heater making rumbling or boiling noises. To dissolve and remove these more stubborn mineral deposits, UN•LIME Professional Delimer should be used.

DELIMING USING FLO-JUG METHOD

UN•LIME in the 5 gallon size is recommended for deliming of all models. Contact your local dealer, distributor or, water heater manufacturer.

Prepare the Water Heater

To delime the water heater using the Flo-Jug method, first prepare the heater for deliming.

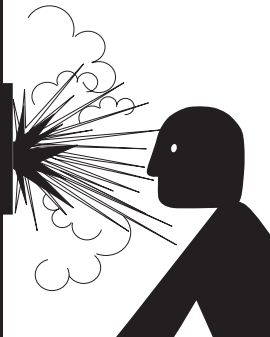
	! WARNING
	Explosion Hazard
	<ul style="list-style-type: none">• Flammable hydrogen gases may be present.• Keep all ignition sources away from faucet when turning on hot water.

Do not smoke or have open flame or sparks in vicinity of heater. Do not mix UN•LIME with other chemicals. Do not allow contact with magnesium, aluminum or galvanized metals.

	! CAUTION
	Chemical Hazard
	<ul style="list-style-type: none">• Product contains phosphoric acid.• Keep out of reach of children.• Use rubber or neoprene gloves.

Contains phosphoric acid. In case of external contact, flush with cool water. If irritation persists, get medical attention. If swallowed, give 1 or 2 glasses of water or milk and call physician.

Get immediate medical attention for eyes. Keep out of reach of children.

NOTE: THE USE OF RUBBER OR NEOPRENE GLOVES IS RECOMMENDED, ESPECIALLY IF YOU HAVE ANY OPEN SORES OR CUTS TO AVOID UNNECESSARY IRRITATION OR DISCOMFORT.

1. Turn off fuel and/or power supply to heater. Also, turn off power to any electrical device or equipment, which is attached, or part of the system.
2. Open hot water side of faucet closest to heater and allow water to run until it is cool enough to handle safely.
3. Close cold water inlet valve to heater.
4. Connect hose to drain valve at bottom of heater and start draining heater into suitable floor drain area.
5. Remove pressure relief valve while heater is draining. NOTE: Do not replace pressure relief valve until deliming is completed. Pressure relief valve opening will also act as a vent in case of possible contact between the delimer and the anode rod(s), which may produce flammable hydrogen-air mixtures.
6. If pressure relief valve appears to be limed-up, place it in a clean glass or plastic container adequate in size so that you can pour enough UN•LIME® into container to cover the valve and allow space for foaming. When foaming stops, run fresh cool water into the container and rinse the pressure relief valve for a few minutes.
7. If heater does not drain completely after a reasonable length of time, turn off the main water supply valve to stop water from entering the tank due to a by-pass problem or defective cold water inlet valve. Also, check for clogged drain valve opening. Heater must be completely drained before introducing UN•LIME.
8. Remove the cleanout cover and place a clean plastic bucket next to the cleanout opening.

Partially open the cold water inlet valve to allow time to accomplish the following and then close the valve.

While the water is being run through the tank, insert a stiff wire, copper tube flattened at one end or an opened wire coat hanger through the cleanout opening and scrape out any loose deposits of scale or sediment. This is an economical way to avoid unnecessary usage of the deliming solution.

Repeat the opening and closing of the cold water inlet valve as necessary but be sure the heater is completely drained when ready to introduce the UN•LIME.

Upon completion, reinstall the cleanout cover and use a new cleanout cover gasket (part number 9004099215).

Remove the drain valve.

9. Install the long plastic male adapter insert fitting into the drain valve opening of heater after applying Teflon tape or paste to threads. Tighten firmly by hand and use wrench or adjustable pliers to check for secure connection. Do not over tighten to avoid damage to threads and fittings.

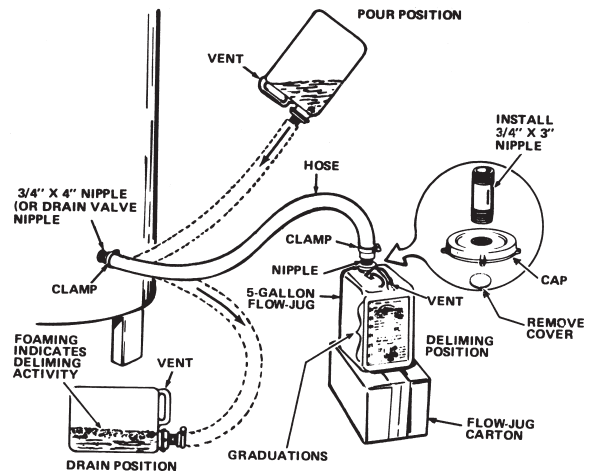

FIGURE 27.

Prepare the Up-N-Down Transfer Kit

The next step is the preparation on the Up-N-Down Transfer Kit, if you have not already done so:

1. With the 5 gallon Up-N-Down container in the vertical position, unscrew the plastic vent cap in the handle and pierce the plastic membrane over the vent boss under the cap to allow the container to vent.

Note: If your container does not have the vent cap and vent boss, drill a 3/16" hole in the handle. When you have finished delimiting you will be able to plug this drilled vent with the stainless steel screw that is supplied with the kit.

2. Remove the container's cap and cut the plastic membrane located in the 3/4" IPT opening in the cap. Take care to not damage the threads.
3. Find the 3/4" male adapter, apply teflon tape to the threaded end and screw it into the 3/4" IPT opening in the cap.
4. Put cap with male adapter back on the container and slide 3/4" hose over end of male adapter and fasten in place using hose clamp provided.

Delime using Flo-Jug Method

5. Slide the hose clamp over end of hose and slide hose over the male adapter in the water heater drain opening and secure in place using hose clamp.
6. Lift container to the "Pour" Position, see Figure 27, being careful to keep the vent in the handle above the liquid level and pour the UN•LIME into the heater.
7. Lower container, you may have to place the container on its empty carton to prevent the UN•LIME from flowing back into the container.
8. Let UN•LIME remain in the heater for 5 minutes and then lower the container to the "Drain" Position, see Figure 27.
9. Delimiting activity is indicated by foaming on the surface of the UN•LIME. If there is delimiting activity, repeat steps 6 thru 8.

Normally, lime removal will be completed within one hour. Severe build-up of lime may take longer than an hour to complete descaling.

Note: To check UN•LIME for continued use, place some scale or white chalk in a glass with a small amount of UN•LIME. If the material is vigorously dissolved by the UN•LIME, it can be reused; if not, the UN•LIME should be replaced.

PILOT BURNER

At least once a year, check the pilot burner, Figure 29, and the main burner, Figure 30, for proper operation. See Figure 28 for the location of the Pilot Burner and the Main Burners. For access to pilot, unfasten two screws to burner cover and remove. Locate the burner with pilot and remove screw holding burner to manifold. Unfasten pilot tubing from valve and slide out burner and pilot.

Servicing the pilot burner includes keeping pilot free of lint, cleaning the burner head, the primary air opening and the orifice of the pilot burner.

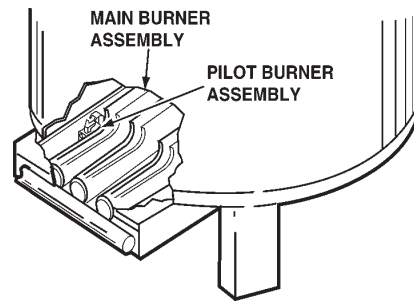

FIGURE 28.

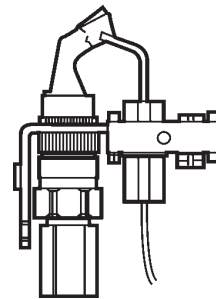

FIGURE 29.

Pilot burner flame is affected by:

1. Low gas pressure.
 - Adjust pilot flame by means of the pilot gas adjustment located on the gas control valve. See Figure 31.
 - The pilot flame should envelop sensing device with 5/8" (1.6cm) flame, Figure 30. Remove pilot adjustment cover screw, Figure 31. Turn inner adjustment screw clockwise to decrease, or counterclockwise to increase pilot flame. Be sure to replace cover screw on gas control valve after adjustment to prevent possible gas leakage.
2. Clogged pilot burner orifice.
 - Clean or replace orifice. A clogged orifice will restrict gas flow.

Pilot sensing device must sense a flame before sparking will stop. Loose wires or a draft may cause intermittent or abnormal sparking. To eliminate this condition, first correct loose wiring condition, and then, if necessary, increase pilot flame.

MAIN BURNER

The main burner, Figure 30, should display the following characteristics:

- Cause rapid ignition and carry over of flame across entire burner.
- Give reasonably quiet operation during ignition, burning and extinction.
- Cause no excessive lifting of flame from burner ports.

If the preceding burner characteristics are not evident, check for accumulation of lint or other foreign material that restricts or other foreign material that restricts or blocks air openings to burner or heater.

To clean main burners:

1. Remove main burners from unit.
2. Check that burner venturi and ports are free of foreign matter.
3. Clean burners with bristle brush and/or vacuum cleaner DO NOT distort burner ports or pilot location.
4. Reinstall burners in unit. Make sure front and rear of burners are installed correctly in burner support brackets.

Also check for good flow of combustion and ventilating air to the unit.

TYPICAL PILOT AND MAIN BURNER FLAMES

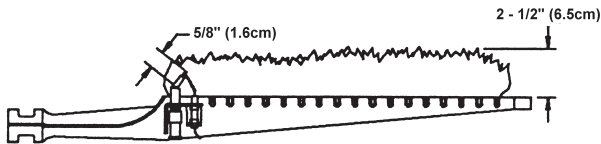
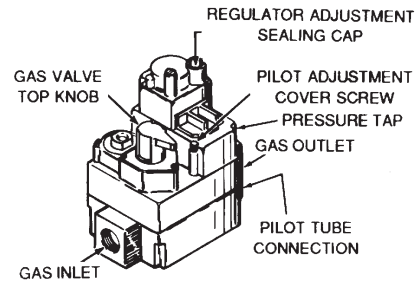

FIGURE 30.

GAS CONTROL VALVE

Figure 31 shows the two types of combination gas control valves used on these heaters.

If gas control valve becomes defective, repairs should not be attempted. A new valve should be installed in place of defective one.



WHITE-RODGERS GAS VALVE
LP VALVE

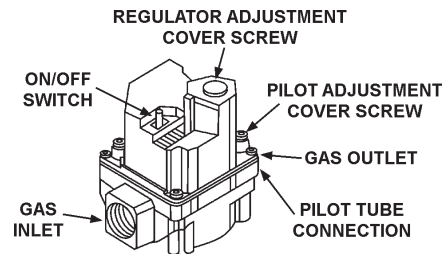

NATURAL VALVE

FIGURE 31.

SERVICE

The installer may be able to observe and correct certain problems which may arise when the unit is put into operation. HOWEVER, it is recommended that only a qualified service technician or qualified agency, using appropriate test equipment, be allowed to service the heater.

As preliminary step, check wiring against diagram, check for grounded, broken or loose wires. Check all wire ends to be sure that they are making good contact.

ELECTRICAL SERVICING

LABEL ALL WIRES PRIOR TO DISCONNECTION WHEN SERVICING CONTROLS. WIRING ERRORS CAN CAUSE IMPROPER AND DANGEROUS OPERATION.

VERIFY PROPER OPERATION AFTER SERVICING.

TROUBLESHOOTING

IGNITION MODULE

Before calling your service agent, the following checklist should be examined to eliminate obvious problems from those requiring replacement or servicing.

- Check that “main manual gas shut-off valve” is fully open and that gas service has not been interrupted.
- Check that after following the water OPERATING INSTRUCTIONS, the “Top Knob” of the gas control valve is in “ON” position.
- Check electrical supply to the water heater for possible blown (or tripped) fusing or power interruption.
- Is the water temperature in tank below the thermostat dial setting on the thermostat (calling for heat)?
- It is possible that the high limit (E.C.O.) has functioned to shut off the water heater. See FEATURES - Water Temperature Control for reset procedure. Contact your serviceman if limit continues to function to shut off water heater.

Green LED Flash Code ^a	Indicates	Next System Action	Recommended Service Action
OFF	No “Call for Heat”	Not applicable	None
Flash Fast	Power up - internal check	Not applicable	None
Heartbeat	Normal startup – ignition sequence started (including prepurge)	Not applicable	None
4 Seconds ON then “x” flashes	Device in run mode. “x” = flame current to the nearest μ A.	Not applicable	None
2	5 minute Retry Delay - Pilot flame not detected during trial for ignition	Initiate new trial for ignition after retry delay completed.	If system fails to light on next trial for ignition check gas supply, pilot burner, spark and flame sense wiring, flame rod contaminated or out of position, burner ground connection.
3	Recycle - Flame failed during run	Initiate new trial for ignition. Flash code will remain through the ignition trial until flame is proved.	If system fails to light on next trial for ignition, check gas supply, pilot burner, flame sense wiring, contamination of flame rod, burner ground connection.
4	Flame sensed out of sequence	If situation self corrects within 10 seconds, control returns to normal sequence. If flame out of sequence remains longer than 10 seconds, control will resume normal operation 1 hour after error is corrected.	Check for pilot flame. Replace gas valve if pilot flame present. If no pilot flame, cycle “Call for Heat.” If error repeats, replace control.
6	Control Internal Error	Control remains in wait mode. When the fault corrects, control resumes normal operation.	Cycle “Call for Heat”. If error repeats, replace control.
7	Flame rod shorted to ground	Control remains in wait mode. When the fault corrects, control resumes normal operation.	Check flame sense lead wire for damage or shorting. Check that flame rod is in proper position. Check flame rod ceramic for cracks, damage or tracking.
8	Low secondary voltage supply	Control remains in wait mode. When the fault corrects, control resumes normal operation.	Check transformer and AC line for proper input voltage to the control. Check with full system load on the transformer.

^a Flash Code Descriptions:

- Flash Fast: rapid blinking.
- Heartbeat: Constant ½ second bright, ½ second dim cycles.
- 4 second solid on pulse followed by “x” 1 second flashes indicates flame current to the nearest μ A. This is only available in run mode.
- A single flash code number signifies that the LED flashes X times at 2Hz, remains off for two seconds, and then repeats the sequence.

FLUE DAMPER

Do not turn damper open manually or motor damage will result, use the service switch. All readings are taken from harness

receptacle. Do not push meter leads into harness receptacle. This opens the pins and will create connection problems. See the following EFFIKAL RVGP-KSF-SERIES FLUE DAMPER TROUBLE SHOOTING GUIDE.

EFFIKAL RVGP-KSF-SERIES FLUE DAMPER TROUBLE SHOOTING GUIDE

Do not turn damper open manually or motor damage will result, use the service switch.
 All readings are taken from harness receptacle. Do not push meter leads into harness receptacle.
 This opens the pins and will create connection problems.

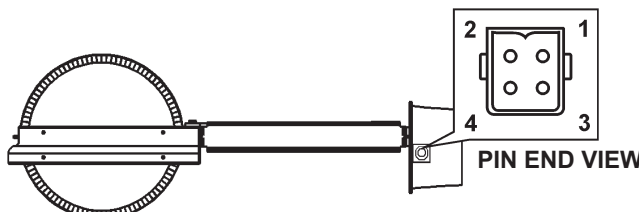

Effikal Pinouts & wire colors	Function	Adapter wire colors in*
1. Brown	24 VAC HOT	Black
2. Orange	Signal In	Yellow
3. Yellow	Signal Out	Red
4. Black	24 VAC Common	White

NOTE: DAMPER DISC SHOWN IN OPEN POSITION.

24 V.A.C. NORMAL SEQUENCE OF OPERATION	
<p>A. FLUE DAMPER OPEN OR OPENING (Unit is calling for heat and damper disc should be in vertical position) VOLTAGE ACROSS:</p> <p>4 & 1 All Times that High Limit is closed</p> <p>4 & 2 Calling for Heat Open or Opening</p> <p>4 & 3 During Combustion Damper Open+</p>	<div style="border: 1px solid black; padding: 5px; width: fit-content; margin: auto;"> <p>⚠ WARNING Do not negate the action of any existing safety or operational controls.</p> </div>
<p>B. FLUE DAMPER CLOSED (Unit is not calling for heat and damper disc should be in horizontal position) NOTE: POSITION 4 IS COMMON AND POSITION 3 IS HOT 24VAC VOLTAGE ACROSS:</p> <p>4 & 1 All Times that High Limit is closed</p> <p>NO VOLTAGE ACROSS:</p> <p>4 & 3 or 4 & 2 1. Thermostat not calling for heat.</p>	

ABNORMAL OPERATION	
<p>A. NOTHING WORKING NO VOLTAGE ACROSS:</p> <p>4 & 1</p>	<ol style="list-style-type: none"> 1. High Limit has tripped and is OPEN. Determine reason for tripping of high limit 2. Bad Transformer 3. Loose or broken connections 4. Blown fuse or circuit breaker 5. Disconnect switch off 6. Harness not plugged into water heater receptacle
<p>B. DAMPER HAS OPENED, NO COMBUSTION VOLTAGE ACROSS:</p> <p>4 & 1; 4 & 2; 4 & 3:</p>	<ol style="list-style-type: none"> 1. Check for power at ignition module terminals. If 24VAC power is present damper is working properly. 2. Defective component in water heater after the flue damper. 3. If 24 VAC is not present at the ignition module, look for loose or broken connections between damper and ignition module. 4. If the connections from damper to ignition module seem proper, replace damper assembly. If a damper assembly is not available, place the service switch in the hold open position. This should keep the damper in the open position and allow the customer to have automatic heat, until a replacement damper can be installed.
<p>C. DAMPER ROTATES CONTINUOUSLY</p>	<p>Change the entire damper assembly</p>
<p>D. DAMPER STICKS</p>	<ol style="list-style-type: none"> 1. Make sure no screws obstruct the damper blade. 2. Make sure damper pipe assembly is not egg shaped. 3. Make sure damper rod is not rubbing on pipe assembly. See figure on front page of this insert sheet

IMPORTANT: DAMPER MUST BE OPEN BEFORE COMBUSTION TAKES PLACE. If all steps have been tried and damper problems persists call State Technical Center at 1-800-821-2017.

TROUBLESHOOTING CHECKLIST

COMPLAINT	CAUSE	REMEDY	
		USER	QUALIFIED SERVICE AGENCY
Water not hot enough.	Thermostat set too low.	Set thermostat dial to a higher temperature.	
	Upper and/or lower temperature probe out of calibration.	Call qualified service agency.	Check continuity and resistance (Ohms) of upper and lower thermostat probes. Replace probes if out of specification.
Insufficient hot water	Thermostat set too low.	Set thermostat dial to a higher temperature.	
	Upper and/or lower temperature probe out of calibration.	Call qualified service agency.	Check continuity and resistance (Ohms) of upper and lower thermostat probes. Replace probes if out of specification..
	Main manual gas shutoff valve partially closed.	Open main manual gas shutoff valve to fullest extent.	
	Heater too small for demand.	Space usage to give heater time to restore water temperature.	
	Heater recovery is slower.	Call qualified service agency.	Check gas input. If incorrect, adjust gas pressure or replace main burner orifice.
	Draft hood not installed or one or more baffles.	Call qualified service agency.	Install draft hood or baffles as furnished with unit.
Water temperature too hot.	Thermostat set too high.	Set thermostat to a lower setting.	
Heater makes sounds: sizzling.	Condensation on outside of tank - normal.		
Rumbling.	Sediment accumulation on bottom of tank.	Drain a quantity of water through drain valve. If rumbling persists, call a qualified service agency.	Delime heater.
Ticking or metallic sounds.	Expansion and contraction-normal.		
Pounding / water hammer.	Air chambers in piping have become waterlogged. Thermal expansion tank damaged, improperly charged, or improperly sized.	Drain piping system and refill. Heater must be off while this is being done. Check thermal expansion tank charge pressure when the water system pressure is zero.	Follow the manufacturer's instructions for proper charging of the thermal expansion tank.
Combustion noises.	Too much primary air.	Adjust shutters.	
	Overtired heater. Incorrect burners or orifice for types of gas used.	Call qualified service agency.	Check and correct as necessary.
Water leaks.	Drain valve not closed tightly.	If drain valve cannot be closed tightly, replace.	
	If leakage source cannot be corrected or identified, call qualified service agency.	Shut off gas supply to heater and close cold water inlet valve to heater.	Repair or in case of suspected tank leakage, be certain to confirm before replacing heater.
Gas odors.	Heater is overtired.	Shut off gas supply to heater and call qualified service agency.	Check for sooted flue passage.
			Check for obstructed vent line.
			Check backdraft or lack of draft.
			Draft hood may be improperly installed or not sized properly.
	Possible gas leaks.	Shut off gas supply to heater and call gas company at once.	

FOR YOUR INFORMATION

START UP CONDITIONS

SMOKE/ODOR

It is not uncommon to experience a small amount of smoke and odor during the initial start-up. This is due to burning off of oil from metal parts, and will disappear in a short while.

STRANGE SOUNDS

Possible noises due to expansion and contraction of some metal parts during periods of heat-up and cool-down do not necessarily represent harmful or dangerous conditions.

Condensation causes sizzling and popping within the burner area during heating and cooling periods and should be considered normal. See "Condensation" section in this manual.

CONDENSATION

Whenever the water heater is filled with cold water, some condensate will form while the burner is on. A water heater may appear to be leaking when in fact the water is condensation. This usually happens when:

- a. A new water heater is filled with cold water for the first time.
- b. Burning gas produces water vapor in water heaters, particularly high efficiency models where flue temperatures are lower.
- c. Large amounts of hot water are used in a short time and the refill water in the tank is very cold.

Moisture from the products of combustion condense on the cooler tank surfaces and form drops of water which may fall onto the burner or other hot surfaces to produce a "sizzling" or "frying" noise.

OPERATIONAL CONDITIONS

HOT WATER ODOR

In each water heater there is installed at least one anode rod for corrosion protection of the tank. Certain water conditions will cause a reaction between this rod and the water. The most common complaint associated with the anode rod is one of a "rotten egg smell" in the hot water. The smell is a result of four factors which must all be present for the odor to develop:

- a. A concentration of sulfate in the supply water.
- b. Little or no dissolved oxygen in the water.

- c. A sulfate reducing bacteria which has accumulated within the water heater (this harmless bacteria is nontoxic to humans).
- d. An excess of active hydrogen in the tank. This is caused by the corrosion protective action of the anode rod.

Smelly water may be eliminated or reduced in some water heater models by replacing the anode rod(s) with one of less active material, and then chlorinating water heater tank and all water lines.

Contact the local water heater supplier or service agency for further information concerning an Anode Rod Replacement Kit and this chlorination treatment.

If smelly water persists after anode rod replacement and chlorination treatment, we can only suggest that chlorination or aeration of the water supply be considered to eliminate the water problem.

Do not remove the anode rod leaving the tank unprotected. By doing so, all warranty on the water heater tank is voided.

"AIR" IN HOT WATER FAUCETS

HYDROGEN GAS: Hydrogen gas can be produced in a hot water system that has not been used for a long period of time (generally two weeks or more). Hydrogen gas is extremely flammable and explosive. To prevent the possibility of injury under these conditions, we recommend the hot water faucet, located farthest away, be opened for several minutes before any electrical appliances which are connected to the hot water system are used (such as a dishwasher or washing machine). If hydrogen gas is present, there will probably be an unusual sound similar to air escaping through the pipe as the hot water faucet is opened. There must be no smoking or open flame near the faucet at the time it is open.









HIGH WATER TEMPERATURE SHUT OFF SYSTEM

This water heater is equipped with a manual reset type high limit (Energy Cutout) switch. The high limit switch interrupts the main burner gas flow should water temperature reach 203°F (95°C).

In the event of high limit switch operation, the water heater cannot be restarted unless the water temperature is reduced to approximately 120F (49C). The high limit reset button on the front of the thermostat then needs to be depressed. See Figure 2 for the location of the reset button.

WATER PIPING DIAGRAMS

LEGEND







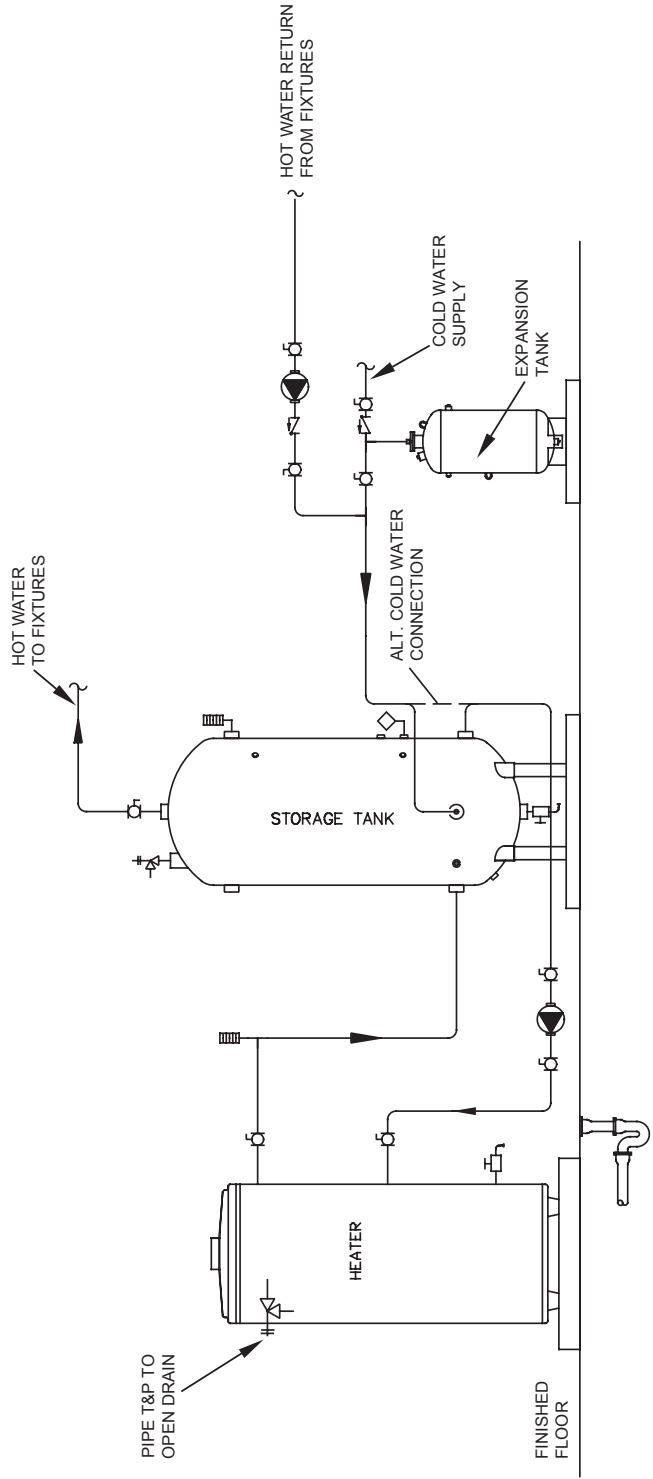

MULTI FLOOR - (1 UNIT) WITH VERTICAL STORAGE TANK

WARNING: THIS DRAWING SHOWS SUGGESTED PIPING CONFIGURATION AND OTHER DEVICES; CHECK WITH LOCAL CODES AND ORDINANCES FOR ADDITIONAL REQUIREMENTS.



- NOTES:**
1. Preferred piping diagram.
 2. The temperature and pressure relief valve setting shall not exceed pressure rating of any component in the system.
 3. Service valves are shown for servicing unit. However, local codes shall govern their usage.
 4. The Tank Temperature Control should be wired to and control the pump between the water heater(s) and the storage tank(s).
 5. The water heater's operating thermostat should be set 5 degrees F higher than the Tank Temperature Control.

LEGEND

	TEMPERATURE & PRESSURE RELIEF VALVE		FULL PORT BALL VALVE
	PRESSURE RELIEF VALVE		CHECK VALVE
	CIRCULATING PUMP		TEMPERATURE GAGE
	TANK TEMPERATURE CONTROL		WATER FLOW SWITCH
	DRAIN		

MULTI FLUE - (1 UNIT) WITH HORIZONTAL STORAGE TANK

WARNING: THIS DRAWING SHOWS SUGGESTED PIPING CONFIGURATION AND OTHER DEVICES; CHECK WITH LOCAL CODES AND ORDINANCES FOR ADDITIONAL REQUIREMENTS.

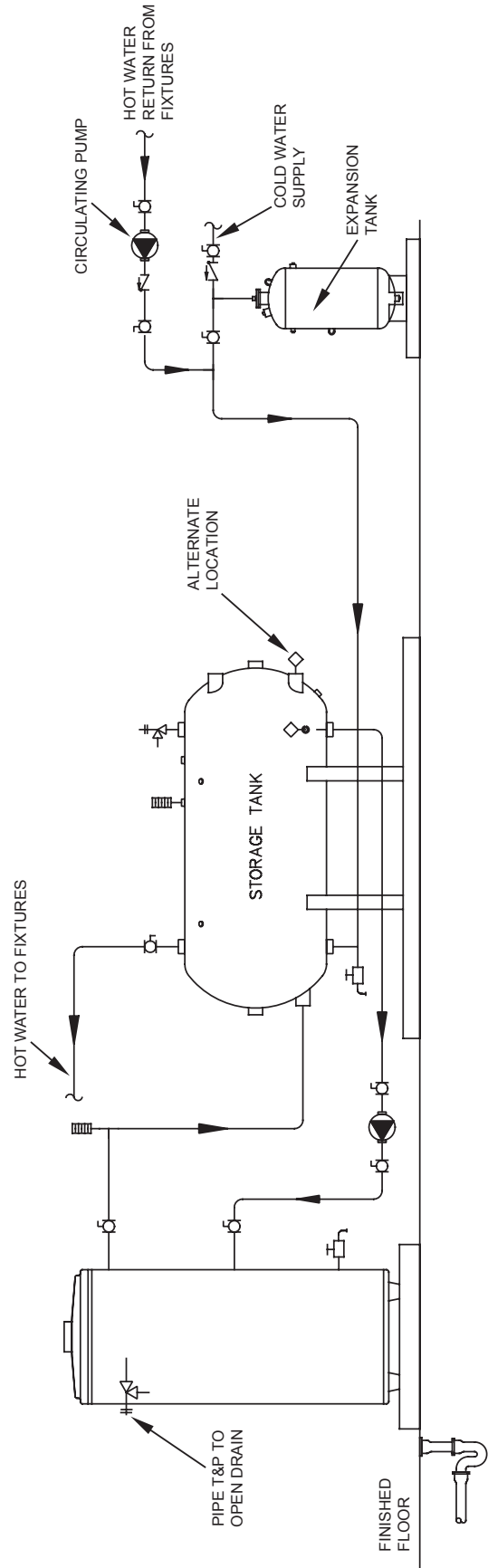









NOTES:

1. Preferred piping diagram.
2. The temperature and pressure relief valve setting shall not exceed pressure rating of any component in the system.
3. Service valves are shown for servicing unit. However, local codes shall govern their usage.
4. The Tank Temperature Control should be wired to and control the pump between the water heater(s) and the storage tank(s).
5. The water heater's operating thermostat should be set 5 degrees F higher than the Tank Temperature Control.

MULTI FLUE - (1 UNIT) WITH MIXING VALVE TWO TEMPERATURE

WARNING: THIS DRAWING SHOWS SUGGESTED PIPING CONFIGURATION AND OTHER DEVICES; CHECK WITH LOCAL CODES AND ORDINANCES FOR ADDITIONAL REQUIREMENTS.

LEGEND

	TEMPERATURE & PRESSURE RELIEF VALVE		FULL PORT BALL VALVE
	PRESSURE RELIEF VALVE		CHECK VALVE
	CIRCULATING PUMP		TEMPERATURE GAGE
	TANK TEMPERATURE CONTROL		WATER FLOW SWITCH

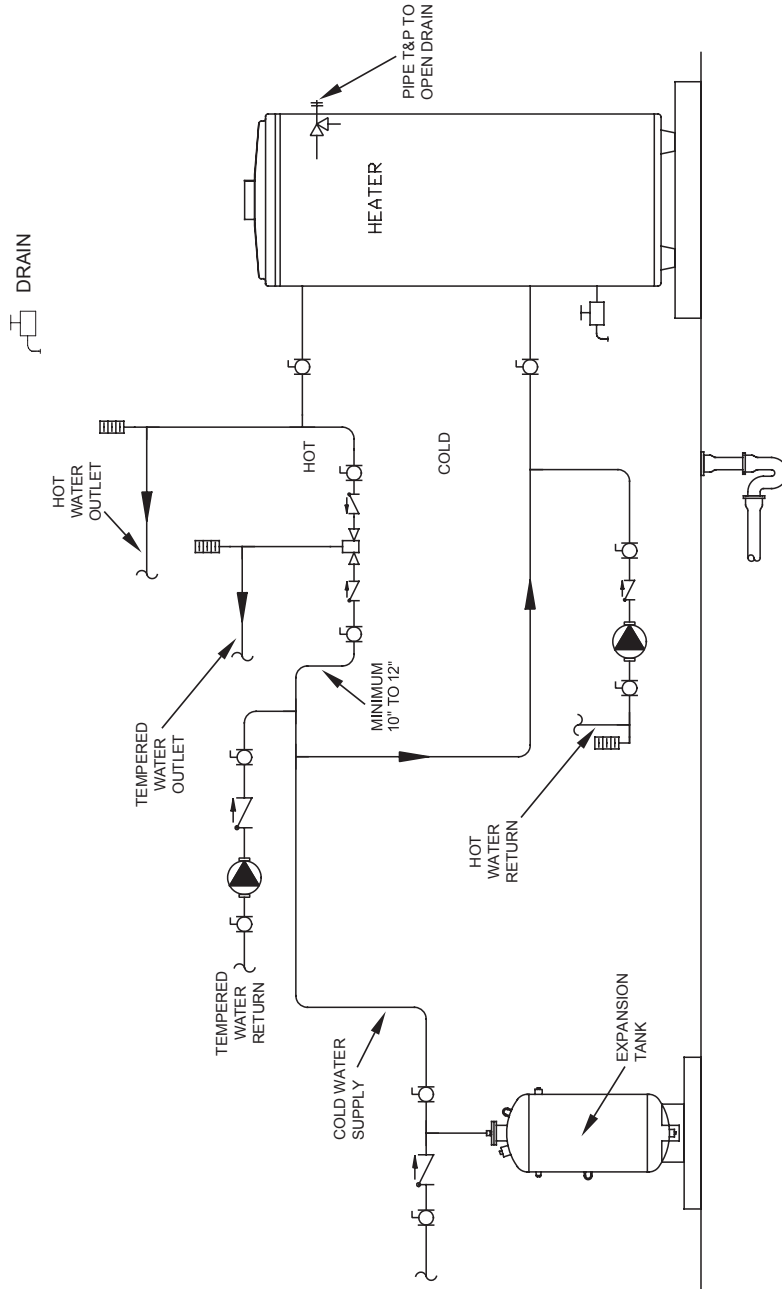









- NOTES:**
1. Preferred piping diagram.
 2. The temperature and pressure relief valve setting shall not exceed pressure rating of any component in the system.
 3. Service valves are shown for servicing unit. However, local codes shall govern their usage.

MULTI FLUE - (2 UNITS)

WARNING: THIS DRAWING SHOWS SUGGESTED PIPING CONFIGURATION AND OTHER DEVICES; CHECK WITH LOCAL CODES AND ORDINANCES FOR ADDITIONAL REQUIREMENTS.

LEGEND

	TEMPERATURE & PRESSURE RELIEF VALVE		FULL PORT BALL VALVE
	PRESSURE RELIEF VALVE		CHECK VALVE
	CIRCULATING PUMP		TEMPERATURE GAGE
	TANK TEMPERATURE CONTROL		WATER FLOW SWITCH
	DRAIN		

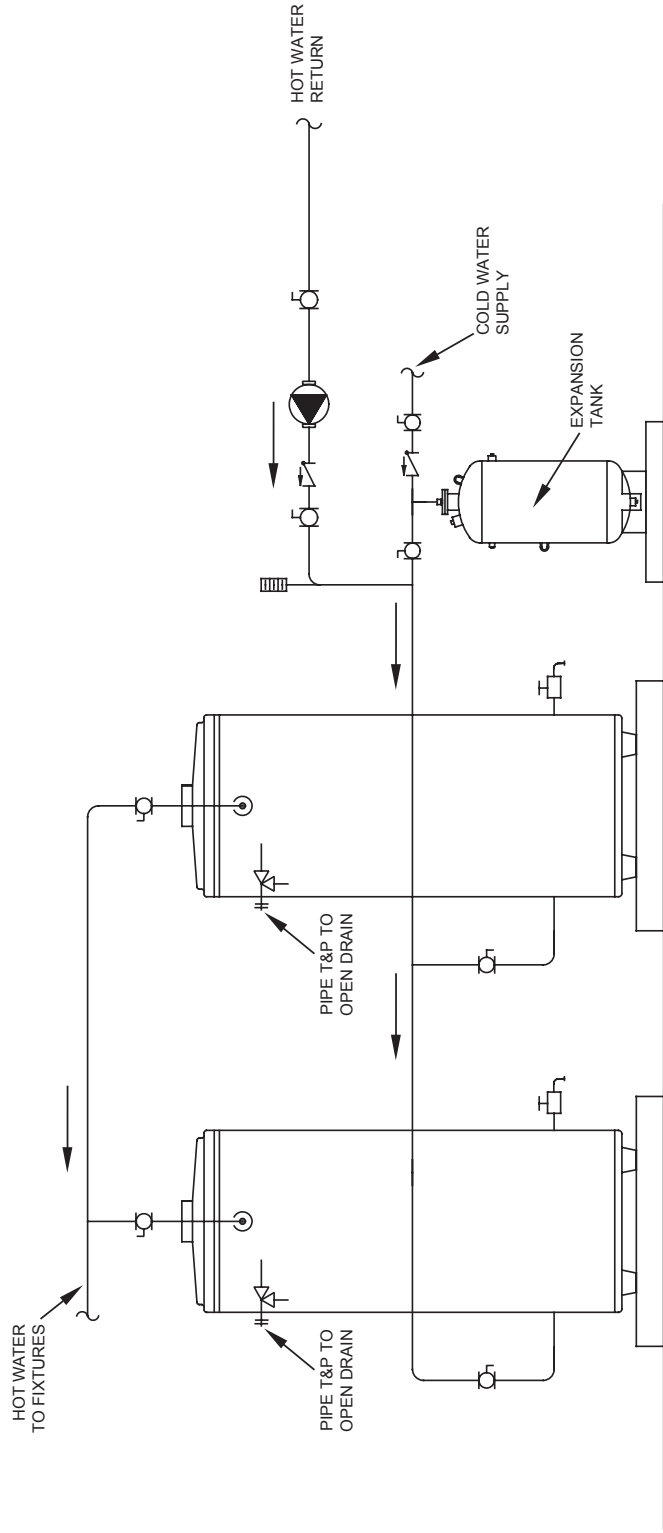









NOTES:

1. Preferred piping diagram.
2. The temperature and pressure relief valve setting shall not exceed pressure rating of any component in the system.
3. Service valves are shown for servicing unit. However, local codes shall govern their usage.

MULTI FLUE - (2 UNITS) WITH VERTICAL STORAGE TANK

WARNING: THIS DRAWING SHOWS SUGGESTED PIPING CONFIGURATION AND OTHER DEVICES; CHECK WITH LOCAL CODES AND ORDINANCES FOR ADDITIONAL REQUIREMENTS.

LEGEND

	TEMPERATURE & PRESSURE RELIEF VALVE		FULL PORT BALL VALVE
	PRESSURE RELIEF VALVE		CHECK VALVE
	CIRCULATING PUMP		TEMPERATURE GAGE
	TANK TEMPERATURE CONTROL		WATER FLOW SWITCH
	DRAIN		

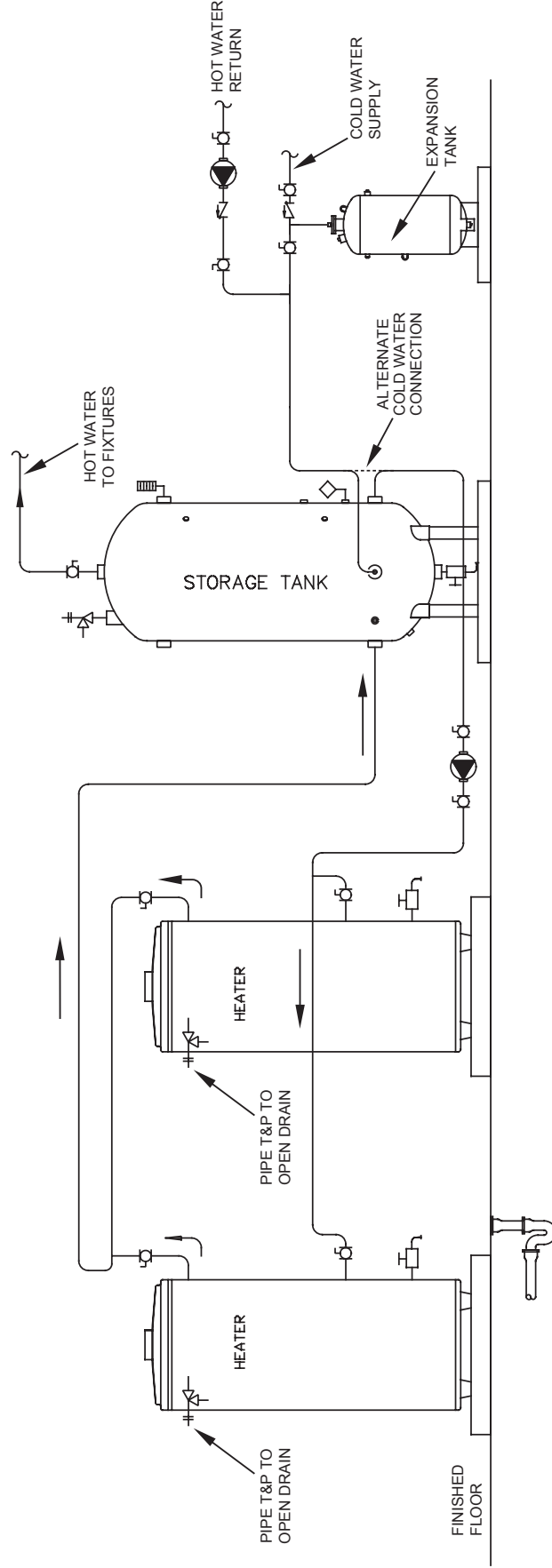









NOTES:

1. Preferred piping diagram.
2. The temperature and pressure relief valve setting shall not exceed pressure rating of any component in the system.
3. Service valves are shown for servicing unit. However, local codes shall govern their usage.
4. The Tank Temperature Control should be wired to and control the pump between the water heater(s) and the storage tank(s).
5. The water heater's operating thermostat should be set 5 degrees F higher than the Tank Temperature Control.

MULTI FLUE - (2 UNITS) WITH VERTICAL STORAGE TANK

WARNING: THIS DRAWING SHOWS SUGGESTED PIPING CONFIGURATION AND OTHER DEVICES; CHECK WITH LOCAL CODES AND ORDINANCES FOR ADDITIONAL REQUIREMENTS.

LEGEND

	TEMPERATURE & PRESSURE RELIEF VALVE		FULL PORT BALL VALVE
	PRESSURE RELIEF VALVE		CHECK VALVE
	CIRCULATING PUMP		TEMPERATURE GAGE
	TANK TEMPERATURE CONTROL		WATER FLOW SWITCH
	DRAIN		

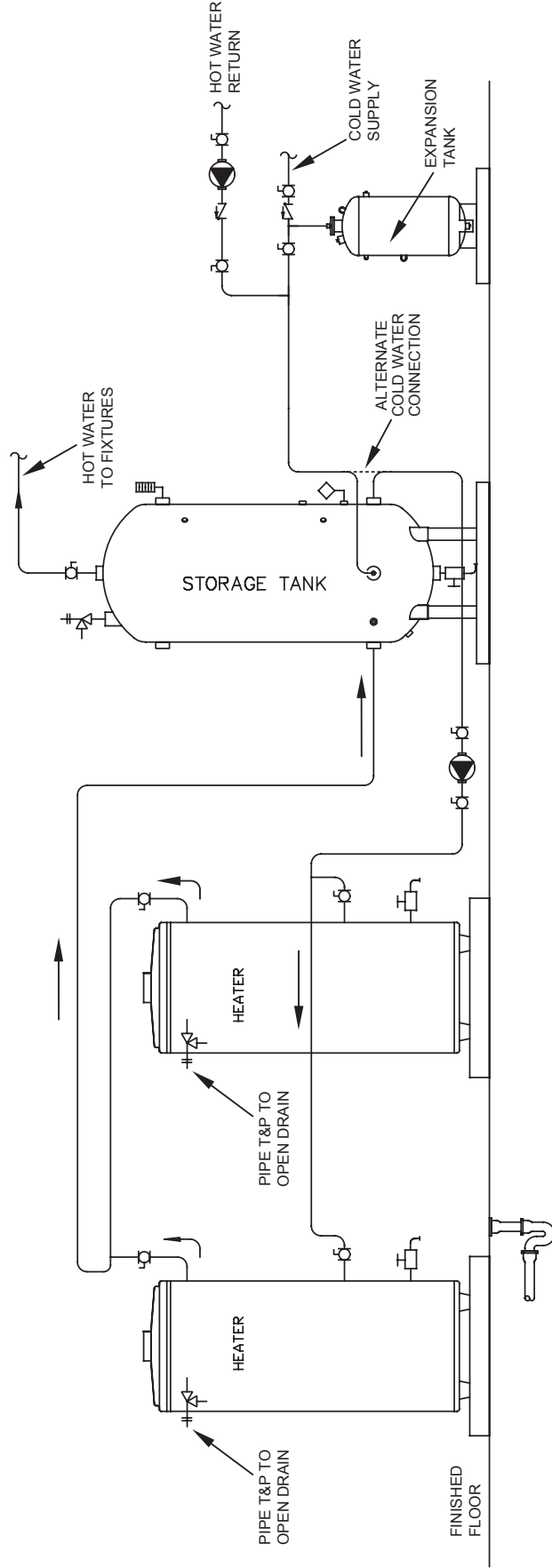









NOTES:

1. Preferred piping diagram.
2. The temperature and pressure relief valve setting shall not exceed pressure rating of any component in the system.
3. Service valves are shown for servicing unit. However, local codes shall govern their usage.
4. The Tank Temperature Control should be wired to and control the pump between the water heater(s) and the storage tank(s).
5. The water heater's operating thermostat should be set 5 degrees F higher than the Tank Temperature Control.

MULTI FLUE - (2 UNITS) WITH HORIZONTAL STORAGE TANK

WARNING: THIS DRAWING SHOWS SUGGESTED PIPING CONFIGURATION AND OTHER DEVICES; CHECK WITH LOCAL CODES AND ORDINANCES FOR ADDITIONAL REQUIREMENTS.

LEGEND

	TEMPERATURE & PRESSURE RELIEF VALVE		FULL PORT BALL VALVE
	PRESSURE RELIEF VALVE		CHECK VALVE
	CIRCULATING PUMP		TEMPERATURE GAGE
	TANK TEMPERATURE CONTROL		WATER FLOW SWITCH
	DRAIN		

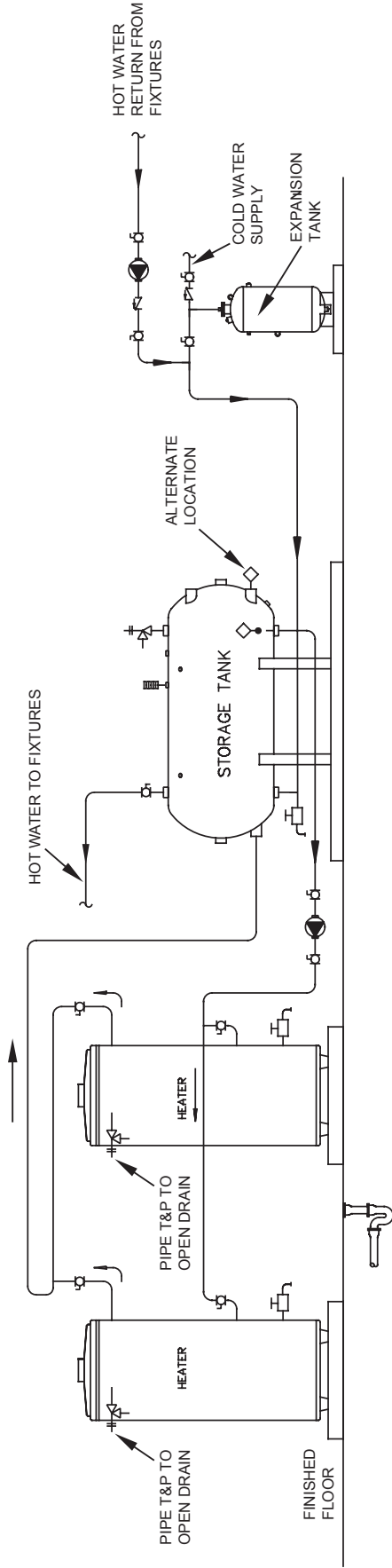









NOTES:

1. Preferred piping diagram.
2. The temperature and pressure relief valve setting shall not exceed pressure rating of any component in the system.
3. Service valves are shown for servicing unit. However, local codes shall govern their usage.
4. The Tank Temperature Control should be wired to and control the pump between the water heater(s) and the storage tank(s).
5. The water heater's operating thermostat should be set 5 degrees F higher than the Tank Temperature Control.

MULTI FLUE (2 UNITS) TWO TEMPERATURE

WARNING: THIS DRAWING SHOWS SUGGESTED PIPING CONFIGURATION AND OTHER DEVICES; CHECK WITH LOCAL CODES AND ORDINANCES FOR ADDITIONAL REQUIREMENTS.

LEGEND

	TEMPERATURE & PRESSURE RELIEF VALVE		FULL PORT BALL VALVE
	PRESSURE RELIEF VALVE		CHECK VALVE
	CIRCULATING PUMP		TEMPERATURE GAGE
	TANK TEMPERATURE CONTROL		WATER FLOW SWITCH
	DRAIN		

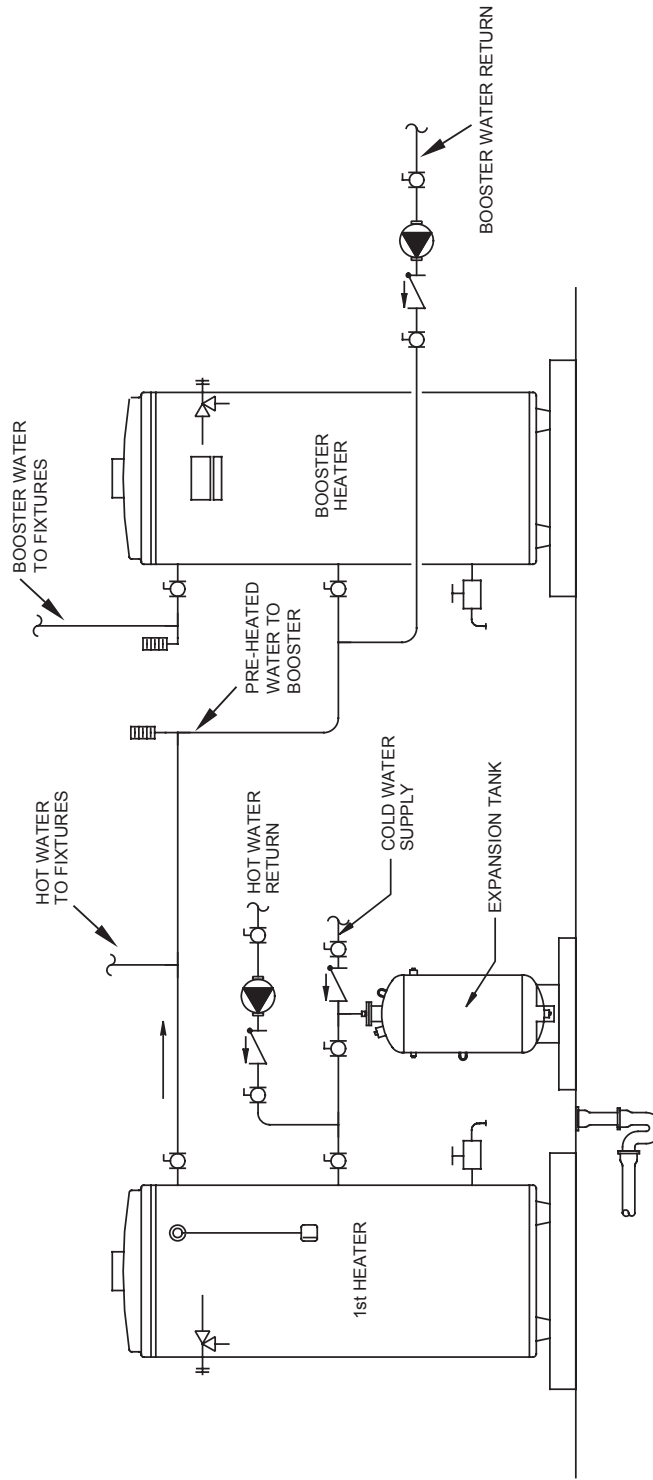









NOTES:

1. Preferred piping diagram.
2. The temperature and pressure relief valve setting shall not exceed pressure rating of any component in the system.
3. Service valves are shown for servicing unit. However, local codes shall govern their usage.

MULTI FLUE (2 UNITS) WITH BOOSTER TWO TEMPERATURE

WARNING: THIS DRAWING SHOWS SUGGESTED PIPING CONFIGURATION AND OTHER DEVICES; CHECK WITH LOCAL CODES AND ORDINANCES FOR ADDITIONAL REQUIREMENTS.

LEGEND

	TEMPERATURE & PRESSURE RELIEF VALVE		FULL PORT BALL VALVE
	PRESSURE RELIEF VALVE		CHECK VALVE
	CIRCULATING PUMP		TEMPERATURE GAGE
	TANK TEMPERATURE CONTROL		WATER FLOW SWITCH
	DRAIN		

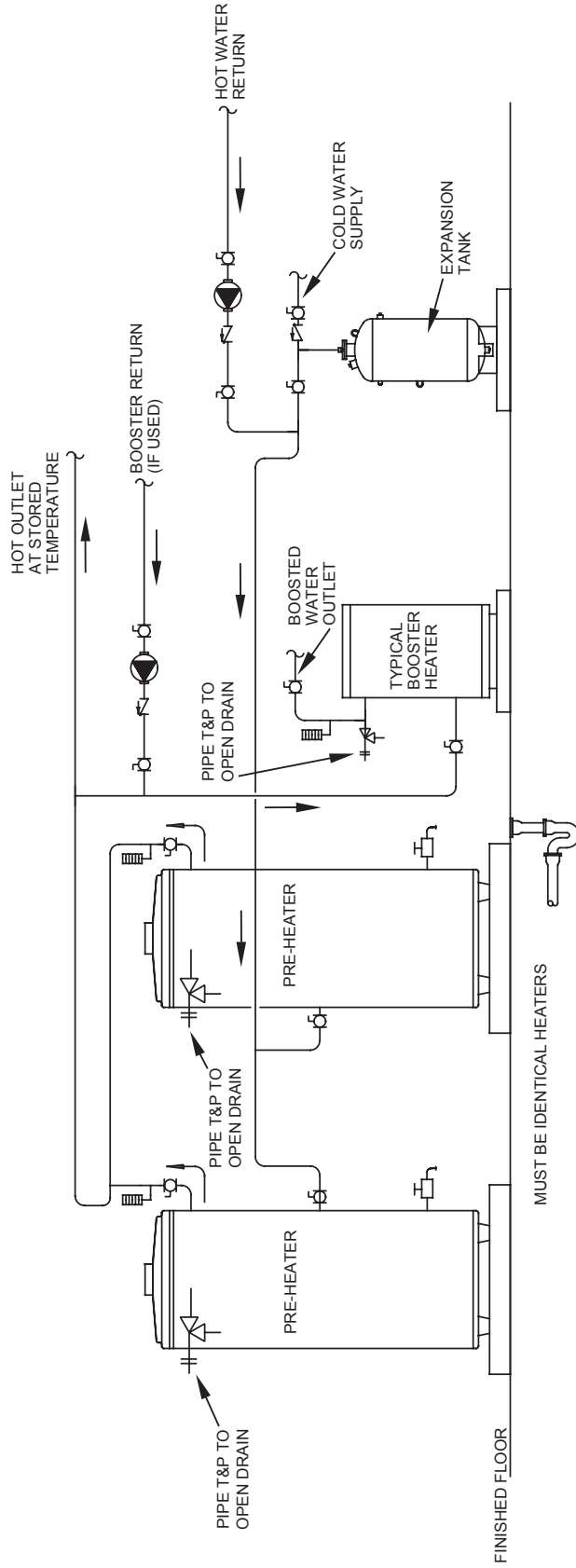









NOTES:

1. Preferred piping diagram.
2. The temperature and pressure relief valve setting shall not exceed pressure rating of any component in the system.
3. Service valves are shown for servicing unit. However, local codes shall govern their usage.

MULTI-FLUE (3 UNITS)

WARNING: THIS DRAWING SHOWS SUGGESTED PIPING CONFIGURATION AND OTHER DEVICES; CHECK WITH LOCAL CODES AND ORDINANCES FOR ADDITIONAL REQUIREMENTS.

LEGEND



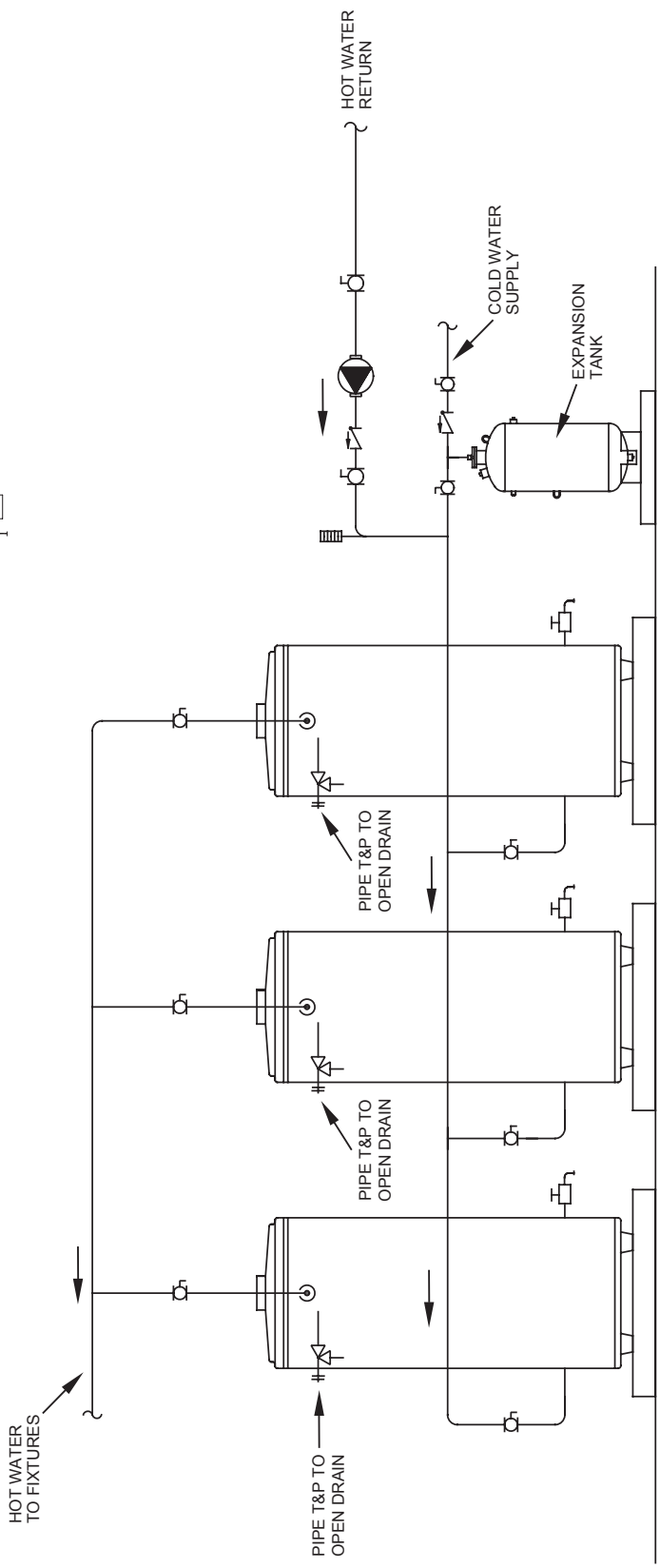





	TEMPERATURE & PRESSURE RELIEF VALVE		FULL PORT BALL VALVE
	PRESSURE RELIEF VALVE		CHECK VALVE
	CIRCULATING PUMP		TEMPERATURE GAGE
	TANK TEMPERATURE CONTROL		WATER FLOW SWITCH
	DRAIN		



NOTES:

1. Preferred piping diagram.
2. The temperature and pressure relief valve setting shall not exceed pressure rating of any component in the system.
3. Service valves are shown for servicing unit. However, local codes shall govern their usage.

LEGEND

	TEMPERATURE & PRESSURE RELIEF VALVE		FULL PORT BALL VALVE
	PRESSURE RELIEF VALVE		CHECK VALVE
	CIRCULATING PUMP		TEMPERATURE GAGE
	TANK TEMPERATURE CONTROL		WATER FLOW SWITCH
	DRAIN		

MULTI-FLUE (3 UNITS) WITH VERTICAL STORAGE TANK



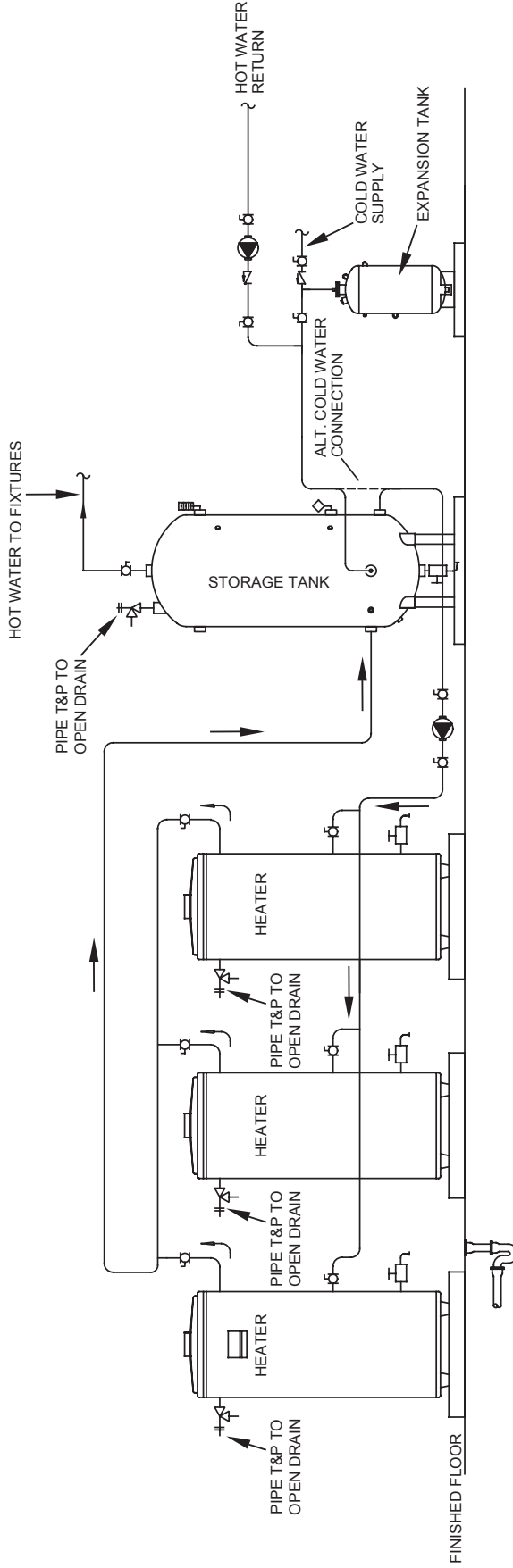





WARNING: THIS DRAWING SHOWS SUGGESTED PIPING CONFIGURATION AND OTHER DEVICES; CHECK WITH LOCAL CODES AND ORDINANCES FOR ADDITIONAL REQUIREMENTS.



NOTES:

1. Preferred piping diagram.
2. The temperature and pressure relief valve setting shall not exceed pressure rating of any component in the system.
3. Service valves are shown for servicing unit. However, local codes shall govern their usage.
4. The Tank Temperature Control should be wired to and control the pump between the water heater(s) and the storage tank(s).
5. The water heater's operating thermostat should be set 5 degrees F higher than the Tank Temperature Control.

LEGEND

	TEMPERATURE & PRESSURE RELIEF VALVE		FULL PORT BALL VALVE
	PRESSURE RELIEF VALVE		CHECK VALVE
	CIRCULATING PUMP		TEMPERATURE GAGE
	TANK TEMPERATURE CONTROL		WATER FLOW SWITCH
	DRAIN		

MULTI-FLUE (3 UNITS) WITH HORIZONTAL STORAGE TANK

WARNING: THIS DRAWING SHOWS SUGGESTED PIPING CONFIGURATION AND OTHER DEVICES; CHECK WITH LOCAL CODES AND ORDINANCES FOR ADDITIONAL REQUIREMENTS.

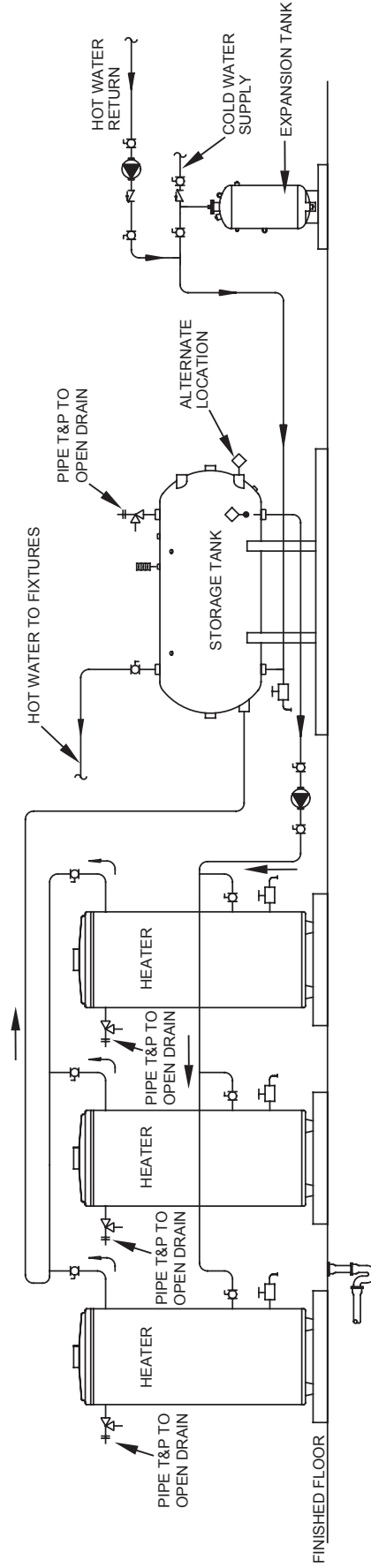









NOTES:

1. Preferred piping diagram.
2. The temperature and pressure relief valve setting shall not exceed pressure rating of any component in the system.
3. Service valves are shown for servicing unit. However, local codes shall govern their usage.
4. The Tank Temperature Control should be wired to and control the pump between the water heater(s) and the storage tank(s).
5. The water heater's operating thermostat should be set 5 degrees F higher than the Tank Temperature Control.

MULTI FLUE FLUE (4 UNITS)

WARNING: THIS DRAWING SHOWS SUGGESTED PIPING CONFIGURATION AND OTHER DEVICES; CHECK WITH LOCAL CODES AND ORDINANCES FOR ADDITIONAL REQUIREMENTS.

LEGEND



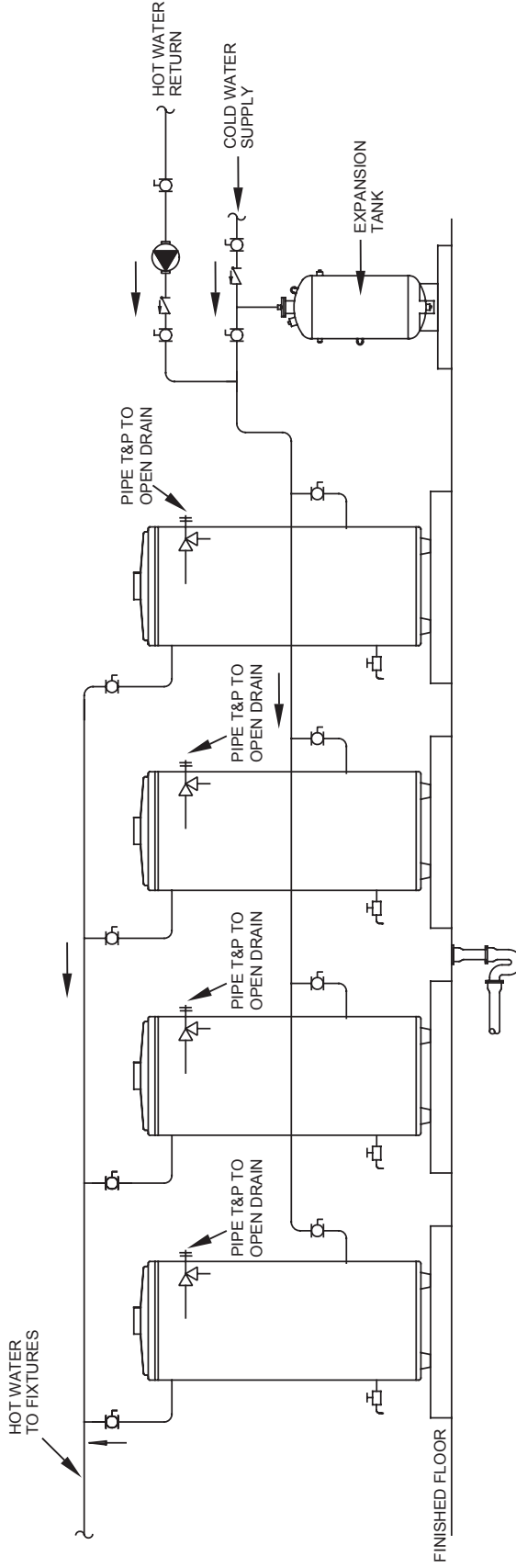





	TEMPERATURE & PRESSURE RELIEF VALVE		FULL PORT BALL VALVE
	PRESSURE RELIEF VALVE		CHECK VALVE
	CIRCULATING PUMP		TEMPERATURE GAGE
	TANK TEMPERATURE CONTROL		WATER FLOW SWITCH
	DRAIN		



NOTES:

1. Preferred piping diagram.
2. The temperature and pressure relief valve setting shall not exceed pressure rating of any component in the system.
3. Service valves are shown for servicing unit. However, local codes shall govern their usage.

LEGEND

	TEMPERATURE & PRESSURE RELIEF VALVE		FULL PORT BALL VALVE
	PRESSURE RELIEF VALVE		CHECK VALVE
	CIRCULATING PUMP		TEMPERATURE GAGE
	TANK TEMPERATURE CONTROL		WATER FLOW SWITCH
	DRAIN		

MULTI-FLUE (4 UNITS) WITH VERTICAL STORAGE TANK

WARNING: THIS DRAWING SHOWS SUGGESTED PIPING CONFIGURATION AND OTHER DEVICES; CHECK WITH LOCAL CODES AND ORDINANCES FOR ADDITIONAL REQUIREMENTS.

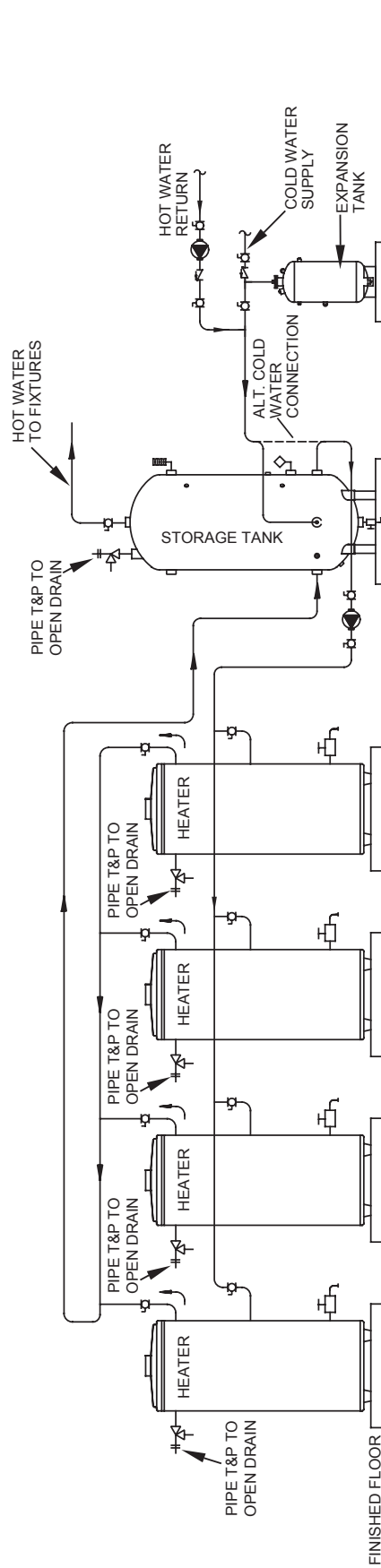









NOTES:

1. Preferred piping diagram.
2. The temperature and pressure relief valve setting shall not exceed pressure rating of any component in the system.
3. Service valves are shown for servicing unit. However, local codes shall govern their usage.
4. The Tank Temperature Control should be wired to and control the pump between the water heater(s) and the storage tank(s).
5. The water heater's operating thermostat should be set 5 degrees F higher than the Tank Temperature Control.

MULTI-FLUE (4 UNITS) WITH HORIZONTAL STORAGE TANK

WARNING: THIS DRAWING SHOWS SUGGESTED PIPING CONFIGURATION AND OTHER DEVICES; CHECK WITH LOCAL CODES AND ORDINANCES FOR ADDITIONAL REQUIREMENTS.

LEGEND

	TEMPERATURE & PRESSURE RELIEF VALVE		FULL PORT BALL VALVE
	PRESSURE RELIEF VALVE		CHECK VALVE
	CIRCULATING PUMP		TEMPERATURE GAGE
	TANK TEMPERATURE CONTROL		WATER FLOW SWITCH
	DRAIN		

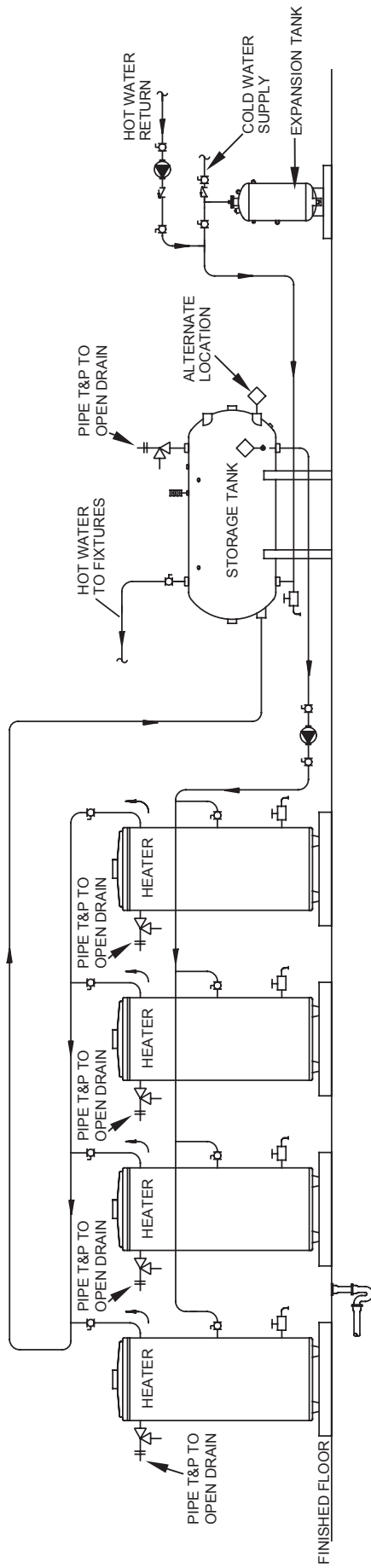

NOTES:

1. Preferred piping diagram.
2. The temperature and pressure relief valve setting shall not exceed pressure rating of any component in the system.
3. Service valves are shown for servicing unit. However, local codes shall govern their usage.
4. The Tank Temperature Control should be wired to and control the pump between the water heater(s) and the storage tank(s).
5. The water heater's operating thermostat should be set 5 degrees F higher than the Tank Temperature Control.

MANIFOLD KITS

TWO UNIT MANIFOLD KIT (9003426205)

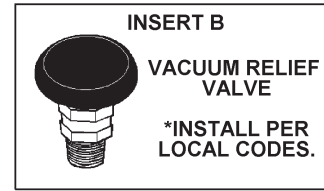
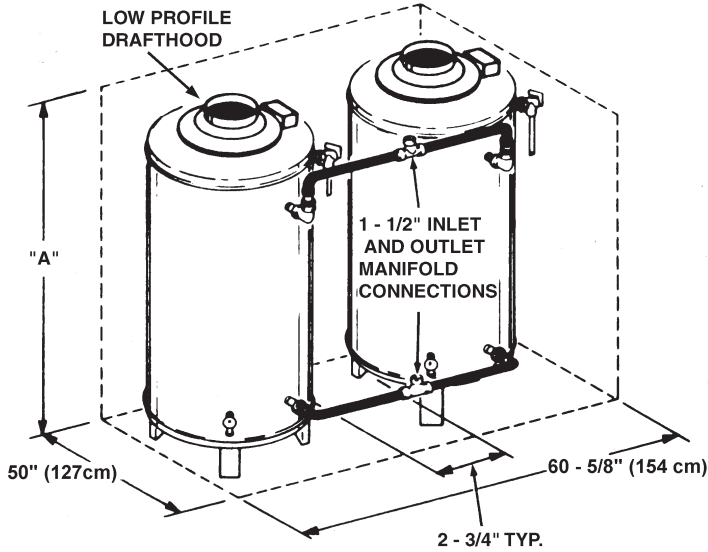

MODEL	DIMENSIONS "A" INCHES (CM)
	LOW PROFILE VERTICAL HOOD "A"
SBD71120(N,P)E	69.75" (177cm)
SBD81154(N,P)E	73.00" (185cm)
SBD81180(N,P)E	67.50" (171cm)
SBD100199(N,P)ET	75.00" (192cm)
SBD81199(N,P)E	67.50" (171cm)
SBD100199(N,P)ES(A)	72.00" (183cm)
SBD100250(N,P)E(A)	72.00" (183cm)
SBD65251(N,P)E(A)	75.00" (191cm)
SBD100275(N,P)E(A)	72.00" (183cm)
SBD65305(P,N)E(A)	75.00" (191cm)
SBD85365(N,P)E(A)	79.50" (202cm)
SBD100390(N,P)E(A)	75.50" (192cm)

THREE UNIT MANIFOLD KIT (9003427205)

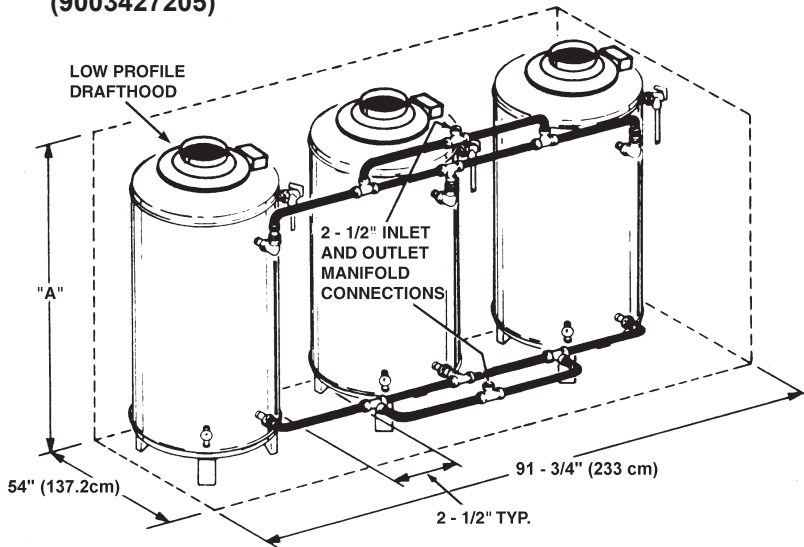

FOUR UNIT MANIFOLD KIT (9003428205)

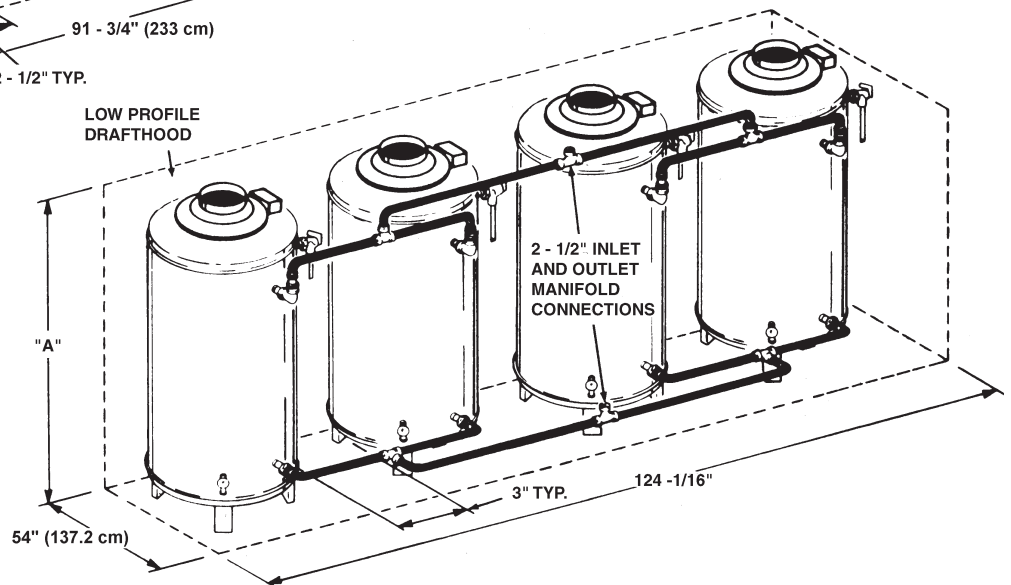

NOTES

NOTES

NOTES

COMMERCIAL WATER HEATER LIMITED WARRANTY



EFFECTIVE

For 3 Years, in the event of a tank leak, we will repair or, at our discretion, replace the defective water heater.

For 1 Year, in the event of part failure, we will repair or, at our discretion, replace the defective part.

We warrant this product against defects in materials or workmanship as described in this document if installed within the United States or Canada and provided the product remains at its original place of installation.

Warranty coverage begins the date of installation OR the date of manufacture if installation cannot be verified.

WHAT'S COVERED

Subject to these terms, in the event of defect in materials and/or workmanship resulting in a **tank leak** during the **first three years**, we will:

- Replace the water heater should the tank leak.

Subject to these terms, in the event of a defect in materials and/or workmanship appearing during the **first year**, we will:

- Repair or, at our discretion, replace any part of the water heater covered under this limited warranty excluding parts subject to normal maintenance (Example: non-electronic anode rod, filter, etc)

Service/labor, shipping, delivery, installation, handling or any other costs are not covered at any time under this warranty.

Any replacement part or product will be warranted only for the unexpired portion of the original water heater's limited warranty period.

If an identical model is no longer available due to a change in law, regulation, or standard, we will replace the product with one having comparable capacity and input. In these instances, the owner will have the option of paying the difference between what was paid for the original model and the new model with the additional features, or receiving a refund of the portion of the purchase price, on a pro-rata basis allocable to the unexpired portion of the warranty.

WHAT'S NOT COVERED

- Problems caused by improper: gas supply line sizing, gas type, venting, connections, combustion air, voltage, wiring, or fusing
- Failure to follow applicable codes
- Failure to follow printed instructions
- Abuse, misuse, accident, fire, flood, Acts of God
- Improper installation, sizing, delivery, or maintenance
- Claims related to rust, noise, smell, or taste of water
- Failure to conduct authorized factory start up if required
- Alterations to the water heater
- Non-outdoor heaters installed outdoors
- Damages due to a failure to allow for thermal expansion
- Heat exchanger failure due to lack of adequate / proper supply of water
- Heaters moved from their original location
- Service trips to explain proper installation, use, or maintenance of the product/unit or to describe compliance requirements under applicable codes and regulations
- Charges related to accessing your heater including but not limited to door/wall removal, equipment rental, etc.
- Replacement parts after expiration of this warranty

LIMITATIONS

NOTWITHSTANDING ANYTHING ELSE TO THE CONTRARY, THIS IS YOUR SOLE AND EXCLUSIVE WARRANTY. ALL OTHER WARRANTIES INCLUDING A WARRANTY OF MERCHANTABILITY OR FITNESS FOR PARTICULAR PURPOSE ARE EXPRESSLY DISCLAIMED. SELLER SHALL NOT BE LIABLE FOR ANY CONSEQUENTIAL, INCIDENTAL, SPECIAL, PUNITIVE OR OTHER INDIRECT DAMAGES. TOTAL LIABILITY ARISING AT ANY TIME SHALL NOT EXCEED THE PURCHASE PRICE PAID WHETHER BASED ON CONTRACT, TORT, STRICT LIABILITY OR ANY OTHER LEGAL THEORY.

SERVICE INQUIRIES:

For service inquiries call the telephone number listed below. Be prepared to provide the following information: name, address, and telephone number; the model and serial number of the water heater; proof of installation; and a clear description of the problem.

For your records, fill in the product:

Serial: _____

Model: _____

U.S. Customers:

State Water Heaters
500 Tennessee Waltz Parkway
Ashland City, Tennessee 37015
800-365-0024
www.statewaterheaters.com



500 Tennessee Waltz Parkway, Ashland City, TN 37015
Technical Support: 800-365-8170 • Parts: 800-821-2017
www.statewaterheaters.com