

Type _____

	-30	-35
P7273	<input type="checkbox"/>	<input type="checkbox"/>
P7274	<input type="checkbox"/>	<input type="checkbox"/>
P7275	<input type="checkbox"/>	<input type="checkbox"/>
P7276	<input type="checkbox"/>	<input type="checkbox"/>

Catalog No.	Finish		Chassis	Dimensions (Inches)		
	White	Natural Oak		A	B	C
P7273	-30	-35	P7213-30*	26	26-1/2	4-3/4
P7274	-30	-35	P7214-30*	15	50-1/2	4-3/4
P7275	-30	-35	P7215-30*	18	50-1/2	4-3/4
P7276	-30	-35	P7216-30*	26-1/2	50-1/2	4-3/4

*Specify ES or EB (See Chassis spec. sheet)

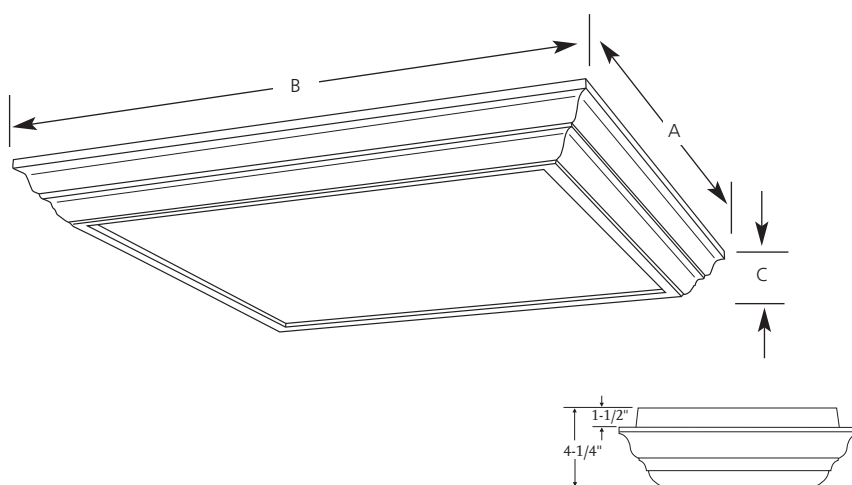

Specifications:

General

- Crown molding configuration on all wood finishes.
- White finish (-30) trim can be painted to match room decor
- Lift and shift action for easy removal for cleaning and lamp replacement
- All white acrylic lay-in diffuser
 P7273: 22.5" x 22"
 P7274: 10.87" x 46.62"
 P7275: 14" x 46.62"
 P7276: 22.5" x 46.62"
- Chassis is regressed when diffuser is installed
- For use with designated chassis as shown

Mounting

- Mounts only on designated chassis (see above and refer to Chassis spec. sheets)

P7214-30ES/P7274-35

P7214-30ES WITH P7274-35TRIM

Report No. 99021

No. Lamps: 2 Type Lamp: F40CW/RS/SS - SYLVANIA Total Lumens: 5700

Fixture Efficiency: 47.5%

S/MH Ratio: 1.4 (0) 1.3 (90)

Single Fixture Data

Ceiling Ht.(Ft.)	10% Values		Zero Degrees Ft.-C	50% Values	
	Beam Angle - 112			Beam Angle - 68	
	Ft.-C	Beam Dia.		Ft.-C	Beam Dia.
8	2.9	16	29.1	14.6	7
10	1.6	22	15.6	7.8	10
12	1.0	28	9.8	4.9	13
14	0.7	34	6.7	3.3	16
16	0.5	40	4.8	2.4	18

Ft.-C (Footcandles) are initial and measured 2'-6" from floor

Quick Calculator Charts

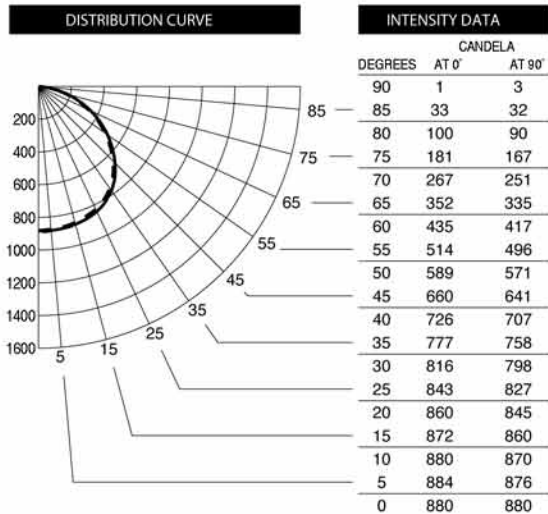
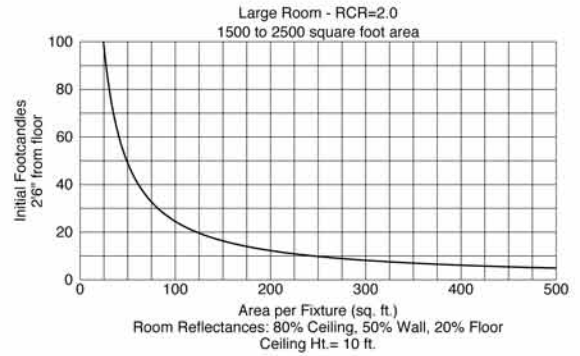
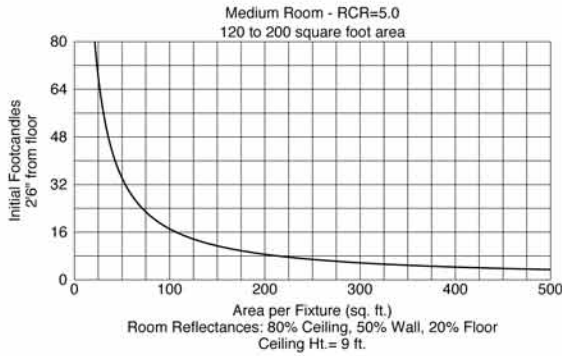

ZONAL CAVITY COEFFICIENTS OF UTILIZATION

Effective Floor Cavity Reflectance 0.20

RC	Effective Floor Cavity Reflectance 0.20																						
	80				70				50				30				10				0		
RW	70	50	30	10	70	50	30	10	50	30	10	50	30	10	50	30	10	50	30	10	0		
0	57	57	57	57	55	55	55	55	53	53	53	51	51	51	48	48	48	47					
1	52	49	47	46	50	48	46	45	46	45	43	44	43	42	43	42	41	40					
2	47	43	40	37	46	42	39	37	40	38	36	39	37	35	37	36	34	33					
3	43	38	34	31	42	37	33	30	36	32	30	34	32	29	33	31	29	28					
4	39	33	29	26	38	33	29	26	31	28	25	30	27	25	29	27	25	24					
5	36	30	25	22	35	29	25	22	28	25	22	27	24	22	26	24	21	20					
6	33	27	22	19	32	26	22	19	25	22	19	25	21	19	24	21	19	18					
7	31	24	20	17	30	24	20	17	23	19	17	22	19	17	22	19	17	16					
8	28	22	18	15	28	22	18	15	21	17	15	20	17	15	20	17	15	14					
9	27	20	16	14	26	20	16	14	19	16	13	19	16	13	18	15	13	12					
10	25	19	15	12	24	18	15	12	18	14	12	17	14	12	17	14	12	11					

P7216-30ES/P7276-35

P7216-30ES WITH P7276-35 TRIM

Report No. 99002

No. Lamps: 4 Type Lamp: F34T12-GE Total Lumens: 11400

Fixture Efficiency: 60.6%

S/MH Ratio: 1.4 (0) 1.4 (90)

Quick Calculator Charts

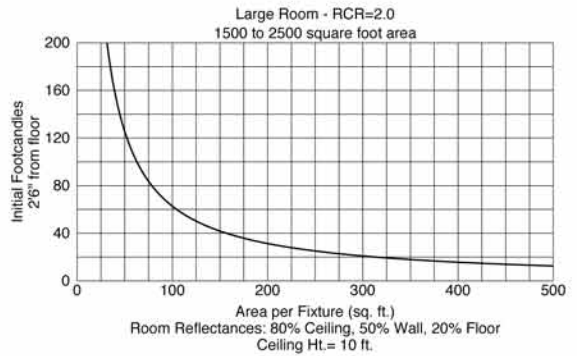
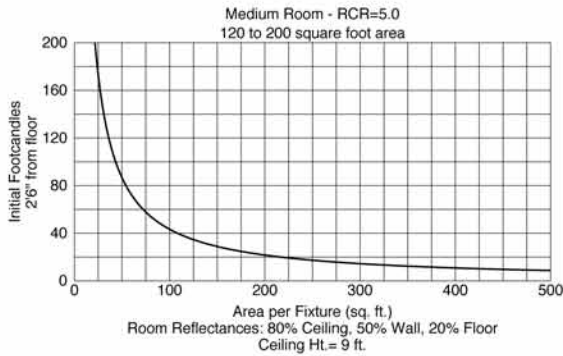

DISTRIBUTION CURVE

INTENSITY DATA

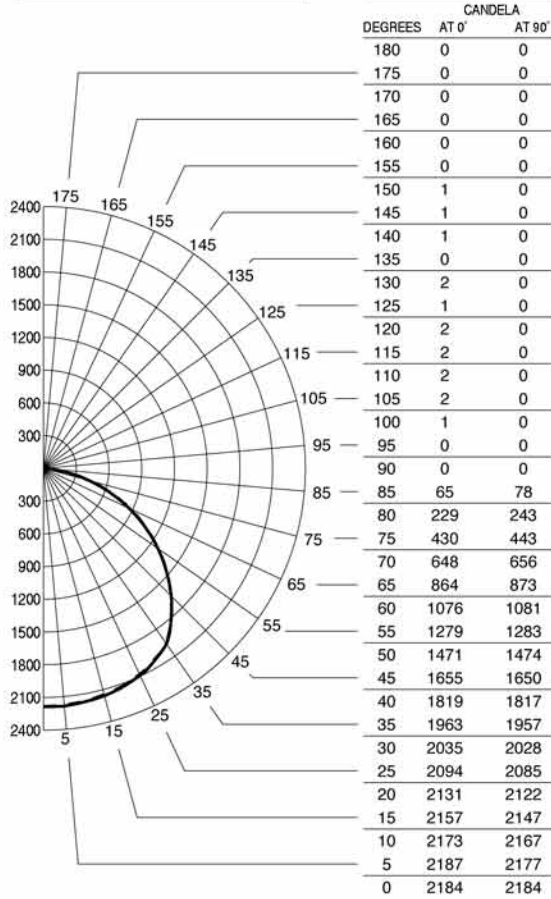

Single Fixture Data

Ceiling Ht. (Ft.)	10% Values Beam Angle - 112		Zero Degrees	50% Values Beam Angle - 69	
	Ft.-C	Beam Dia.		Ft.-C	Beam Dia.
	8	7.2	16	72.2	36.1
10	3.9	22	38.8	19.4	10
12	2.4	28	24.2	12.1	13
14	1.7	34	16.5	8.3	16
16	1.2	40	12.0	6.0	19

Ft.-C (Footcandles) are initial and measured 2'-6" from floor

ZONAL CAVITY COEFFICIENTS OF UTILIZATION

Effective Floor Cavity Reflectance 0.20

RC	Effective Floor Cavity Reflectance 0.20																						
	80				70				50				30				10				0		
RW	70	50	30	10	70	50	30	10	50	30	10	50	30	10	50	30	10	50	30	10	0		
0	72	72	72	72	70	70	70	70	67	67	67	64	64	64	62	62	62	61					
1	66	63	60	58	64	62	59	57	59	57	55	57	55	54	54	53	52	51					
2	60	55	51	47	58	54	50	47	51	48	45	49	47	44	48	45	43	42					
3	54	48	43	39	53	47	42	39	45	41	38	43	40	37	42	39	37	35					
4	50	42	37	33	48	42	37	33	40	36	32	39	35	32	37	34	31	30					
5	46	38	32	28	44	37	32	28	36	31	28	35	31	27	33	30	27	26					
6	42	34	28	24	41	33	28	24	32	28	24	31	27	24	30	27	24	22					
7	39	31	25	22	38	30	25	21	29	25	21	28	24	21	28	24	21	20					
8	36	28	23	19	35	27	23	19	27	22	19	26	22	19	25	21	19	18					
9	34	26	21	17	33	25	20	17	24	20	17	24	20	17	23	20	17	16					
10	32	24	19	15	31	23	19	15	23	18	15	22	18	15	22	18	15	14					