

Honeywell

THE R4222, R8222, R4228 AND R8228 ARE GENERAL PURPOSE RELAYS FOR USE IN REFRIGERATION AND AIR CONDITIONING EQUIPMENT, APPLIANCES, VENDING MACHINES, AND OTHER APPLICATIONS REQUIRING GENERAL PURPOSE SWITCHING.

- R4222 and R8222 contacts are available for Powerpile (millivoltage), pilot duty, and power pole applications.
- R4228 and R8228 have power rated contacts only.
- R4222 and R4228 models have line voltage (120, 208/240, 277, or 480 Vac) coils. R8222 and R8228 models have low voltage (24 Vac) coils.
- Models available with a variety of switching configurations.
- Laminated magnet construction for high efficiency.
- Contacts rated for voltages up to 600 Vac.
- Molded terminal numbers and circuit diagram on top of relay provide easy identification for wiring and checking system operation.
- Relay constructed for high reliability.
- Quick-connect terminals are standard; double quick-connects available on coil terminals.

SWITCHING RELAYS

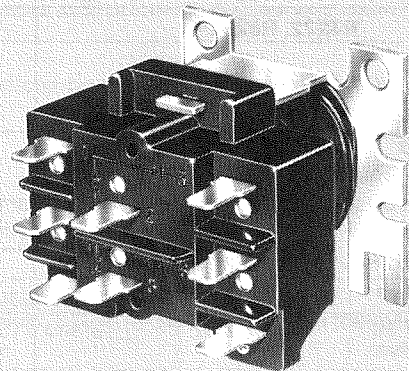

**R4222; R8222;
R4228; R8228**

SPECIFICATIONS

IMPORTANT

THE SPECIFICATIONS GIVEN IN THIS PUBLICATION DO NOT INCLUDE NORMAL MANUFACTURING TOLERANCES. THEREFORE, THIS UNIT MAY NOT MATCH THE LISTED SPECIFICATIONS EXACTLY. ALSO, THIS PRODUCT IS TESTED AND CALIBRATED UNDER CLOSELY CONTROLLED CONDITIONS, AND SOME MINOR DIFFERENCES IN PERFORMANCE CAN BE EXPECTED IF THOSE CONDITIONS ARE CHANGED.

TRADELINE MODELS

TRADELINE models are selected and packaged to provide ease of stocking, ease of handling and maximum replacement value. TRADELINE model specifications are the same as those of standard models except as noted below.

TRADELINE MODELS AVAILABLE:

R4222B,D,N,V Switching Relay—line voltage.
 R8222B,D,N,V Switching Relay—low voltage.
 R4228A,B,D Heavy-duty Relay—line voltage.
 R8228A,B,D Heavy-duty Relay—low voltage.

TERMINALS: R4222, R8222, R4228D and R8228D have single quick-connects on poles, double quick-connects on coil terminals. R4228A,B and

R8228A,B have double quick-connects on poles and double quick-connects on coil terminals.
 SWITCHING CONFIGURATIONS: R4222 and R8222, see Table II. R4228 and R8228, see Table I.

ADDITIONAL FEATURES:

TRADELINE pack with cross reference label and special instruction sheet.

STANDARD MODELS

MODELS:

R4222—General purpose relay: 120, 208/240, 277, and 480 Vac coil.
 R8222—General purpose relay: 24 Vac coil.

R4228—Heavy-duty general purpose relay: 120, 208/240, 277, and 480 Vac coil.

R8228—Heavy-duty general purpose relay: 24 Vac coil.

CONTACT RATINGS:

Power Pole (amperes per pole)—

R4222, R8222 ^c	120 Vac	208 Vac	240 Vac	277 Vac	480 Vac
Inductive					
Full Load	12	6	6	6	3
Locked Rotor	60	35	35	35	18
Resistive					
A and C Models ^b (equivalent resistive power)	20.8 (2.5 kW)	20.8 (4.3 kW)	20.8 (5.0 kW)	20.8 (5.7 kW)	10 (4.8 kW)
All Others ^b	15	15	15	15	10
Combined Ratings for A and C Models ^a					
Resistive (equivalent resistive power)	12.5 (1.5 kW)	12.5 (2.6 kW)	12.5 (3.0 kW)	12.5 (3.4 kW)	6.25 (3.0 kW)
Inductive	+4.2 AFL 10.0 ALR	+4.2 AFL 10.0 ALR	+4.2 ALF 10.0 ALR	+4.2 AFL 10.0 ALR	+2.1 AFL +5.0 ALR
Horsepower	3/4 hp	3/4 hp	3/4 hp	3/4 hp	3/4 hp

^aCombined ratings indicate that both a resistive and inductive load can be operated by each pole.

^bAlso rated 5 amp resistive at 600 volts. ^cUnderwriters Laboratories Inc. and CSA approved for 50 cycle applications.

ORDERING INFORMATION

WHEN PURCHASING REPLACEMENT AND MODERNIZATION PRODUCTS FROM YOUR TRADELINE WHOLESALER OR YOUR DISTRIBUTOR, REFER TO THE TRADELINE CATALOG OR PRICE SHEETS FOR COMPLETE ORDERING NUMBER, OR SPECIFY—

1. Order number, include suffix letter and specify TRADELINE if desired.
2. Contact ratings.
3. Coil ratings.
4. Double quick-connects on coil terminals if desired.
5. Accessories.

IF YOU HAVE ADDITIONAL QUESTIONS, NEED FURTHER INFORMATION, OR WOULD LIKE TO COMMENT ON OUR PRODUCTS OR SERVICES, PLEASE WRITE OR PHONE:

1. YOUR LOCAL HONEYWELL RESIDENTIAL DIVISION SALES OFFICE (CHECK WHITE PAGES OF PHONE DIRECTORY).
2. RESIDENTIAL DIVISION CUSTOMER SERVICE
 HONEYWELL INC., 1885 DOUGLAS DRIVE NORTH
 MINNEAPOLIS, MINNESOTA 55422-4386 (612) 542-7500

IN CANADA—HONEYWELL CONTROLS LIMITED, 740 ELLESMERE ROAD, SCARBOROUGH, ONTARIO M1P 2V9.
 INTERNATIONAL SALES AND SERVICE OFFICES IN ALL PRINCIPAL CITIES OF THE WORLD.

Pilot Duty Poles for R4222 and R8222 Only:
 Minimum—3 VA at 24, 120, and 480 Vac.
 Maximum—25 VA at 24 Vac, 125 VA at 120, 240, and 480 Vac.
 Resistive—3 A at 277 Vac (0.75 power factor).

Power Pole (amperes per pole)—
 Powerpile (millivoltage) for R4222 and R8222 Only:
 The normally open pilot duty contacts are rated for Powerpile (millivoltage) applications—0.25 A at 0.25 to 12 Vdc.

R4228A,B; R8228A,B	120 Vac	208 Vac	240 Vac	277 Vac	480 Vac
Inductive					
Full Load	16 18	18	18	12	5
Locked Rotor	96 72	72	72	72	30
Resistive ^a (equivalent resistive power)	25 (3.0 kW)	25 (5.2 kW)	25 (6.0 kW)	25 (6.9 kW)	15 (7.2 kW)
Horsepower	1 hp	2 hp	2 hp	2 hp	1.5 hp
R4228C,D; R8228C,D	120 Vac	208 Vac	240 Vac	277 Vac	480 Vac
Inductive					
Full Load	5.5	5.5	5.5	5.5	3.0
Locked Rotor	15	15	15	15	8
Resistive ^a (equivalent resistive power)	25 (3.0 kW)	25 (5.2 kW)	25 (6.0 kW)	25 (6.9 kW)	12.5 (6.0 kW)
Combined Ratings ^b					
Resistive (equivalent resistive power)	20.8 (2.5 kW)	20.8 (4.3 kW)	20.8 (5.0 kW)	20.8 (5.6 kW)	10.4 (5.0 kW)
Inductive	+4.2 AFL 10.0 ALR	+4.2 AFL 10.0 ALR	+4.2 AFL 10.0 ALR	+4.2 AFL 10.0 ALR	+2.1 AFL 5.0 ALR
R4228E; R8228E	120 Vac	208 Vac	240 Vac	277 Vac	480 Vac
Inductive					
Full Load	16	—	18	5	5
Locked Rotor	96	—	72	30	30
Resistive ^a	25	—	25	25	15

^aAlso rated 10 A resistive at 600 V.

^bCombined ratings indicate that both a resistive and an inductive load can be operated by each pole.

COIL RATINGS: All coils meet Underwriters Laboratories Inc. requirements for Class B coils. If coil voltages other than those listed below are desired, contact your local Honeywell representative for additional information.

COIL RATINGS		24 V	120 V	208/240 V	277 V	480 V
DC Resistive		9.5 ohms 9.25 ohms ^b	232 ohms	875 ohms	1385 ohms	3600 ohms
Pickup Voltage (maximum) ^a		18 V	96 V	176 V	220 V	384 V
Pickup Voltage (nominal)		16 ± 2 V	80 ± 10 V	150 ± 20 V	190 ± 30 V	330 ± 40 V
Inrush VA (maximum)		20 VA	20 VA	20 VA	20 VA	20 VA
Inrush VA (nominal)		17.0 VA 17.7 VA ^b	17.0 VA	13.5 VA/18.5 VA	17.8 VA	17 VA
Sealed VA (maximum), Sealed VA (nominal)		10 VA 9 VA 9.5 VA ^b	10 VA 9 VA	10 VA 6.7 VA/9.2 VA	10 VA 9.7 VA	10 VA 9 VA
Sealed Amps (nominal)		0.375 A 0.400 A ^b	0.075 A	0.032 A/0.038 A	0.034 A	0.019 A
Sealed Wattage		5.0 W 5.3 W ^b	5.4 W	3.6 W/5 W	5.5 W	5.5 W
Admittance	(open)	0.029 0.031 ^b	0.0012	0.0003	0.0002	0.00007
	(sealed)	0.016 0.016 ^b	0.0006	0.00015	0.00012	0.00004

^aVoltages listed are for the relay base mounted vertical. With the terminals pointing down, pickup voltage is increased by 12 percent.

^bR8222D,G,J,N,R,T,V only.

NOTE: Pickup voltage varies with pole form. Specific models will have lower tolerance than shown above.

TERMINALS: Quick-connects are provided as shown:

MODEL	TERMINALS	NUMBER OF QUICK-CONNECTS	
		SINGLE	DOUBLE
R4222 & R8222	Coil	Std.	Opt.
	Load	Std.	—
R4228 & R8228E	Coil	—	Std.
	Load	—	Std.
R4228A,B & R8228A,B	Load	Std.	—

MOUNTING: Use 2 screws (up to No. 10 size) through holes in the metal base. Base is designed for easy replacement of competitive relays.

AMBIENT TEMPERATURE RANGE: Minus 20 F [minus 29 C] to 155 F [68 C].

DIMENSIONS: See Fig. 1.

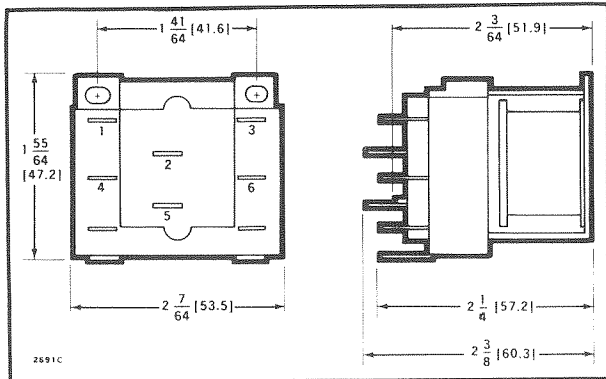

FIG. 1—RELAY DIMENSIONS IN in. [mm IN BRACKETS].

SWITCHING CONFIGURATIONS

The following tables give switching configurations, contact ratings, and terminal designations for the switching relays. For example, the R4222A is a spst switching relay with normally open power rated contacts. The R4222K is a spst relay with normally open contacts rated for pilot duty applications. Electrical connections to the A and K models would be made to terminals 1 and 3.

TABLE I—R4228, R8228

SWITCHING CONFIGURATION	TERMINALS	R4228 OR R8228 MODEL SUFFIX POWER RATED ONLY
SPST, N.O. (DOUBLE QUICK-CONNECTS)		A
SPDT, (DOUBLE QUICK-CONNECTS)		B
SPST, N.O.		C
DPST, N.O.		D
SPST, N.C.		E

TABLE II—R4222, R8222

SWITCHING CONFIGURATION	TERMINALS	R4222 OR R8222 MODEL SUFFIX	
		POWER RATED	PILOT DUTY RATED
SPST, N.O.		A	K
SPDT		B	L
DPST, N.O.		C	M
DPDT		D	N
SPST, N.C.		E	P
DPST, 1-N.O. AND 1-N.C.		F	Q
DPST, N.C.		G	R
SPDT AND SPST, N.O.		H	S
SPDT AND SPST, N.C.		J	T
DPST N.O. (ONE POWER AND ONE PILOT DUTY)			†U
DPDT (ONE POWER AND ONE PILOT DUTY)			†V
SPDT AND SPST, N.O. (ONE POWER AND ONE PILOT DUTY)			†W
SPDT AND SPST, N.O. (ONE POWER AND ONE PILOT DUTY)			†Y
DPST, N.C.			†Z

†Models with suffix letters U,V,W,Y and Z have power rated contacts on silver colored terminals and pilot duty rated contacts on brass colored terminals.

ACCESSORIES:

1. 129384A Case and Cover Assembly.
2. 4074BVJ Receptacle with 8 color-coded plug-in leadwires and retaining bail, for panel mounting applications; see Fig. 2.
3. Q633A1003—4 x 4 plate-mounted relay receptacle with metal relay cover and 8 color-coded plug-in leadwires.

NOTE:

- a. Use the receptacle in applications within the current carrying rating of the wire size and quick-connect terminal being used.
- b. The receptacle will accept relays with double quick-connect terminals.

4. 135959 Receptacle only. Leads and quick-connect terminals are not supplied with the receptacle.

NOTE: Not all standard quick-connect terminals will be adequately retained in this receptacle. It is recommended that a quick-connect terminal with 0.016 inch [0.406 mm] maximum material thickness be

used (0.012 inch [0.305 mm] preferred). The maximum permissible dimension between the rolls is 0.115 inch [2.92 mm]. These requirements are met by AMP, Inc. Faston "250" series terminal No. 42100-1 quick-connects or equivalent.

5. 135887 Wire Bail only.
6. 137881A Adapters for converting 1/4 inch [6.4 mm] quick-connects to No. 6 screw terminals (bag of eight).

UNDERWRITERS LABORATORIES INC.
COMPONENT RECOGNIZED:

R4222 and R8222 models: A to H,J,U,V,W,Y,Z; File No. E59779; Guide No. NLDX2.

R4222 and R8222 models: K,L,M,N,P,Q,R,S,T; File No. E49809; Guide No. NKCR2.

R4228 and R8228 models: A,B,C,D,E; File No. E59779; Guide No. NLDX2.

CANADIAN STANDARDS ASSOCIATION COMPONENT CERTIFIED:

R4222 and R8222: File No. LR35066; Guide No. 184-N-13.13.

R4228 and R8228: File No. LR35066; Guide No. 184-N-13.13.

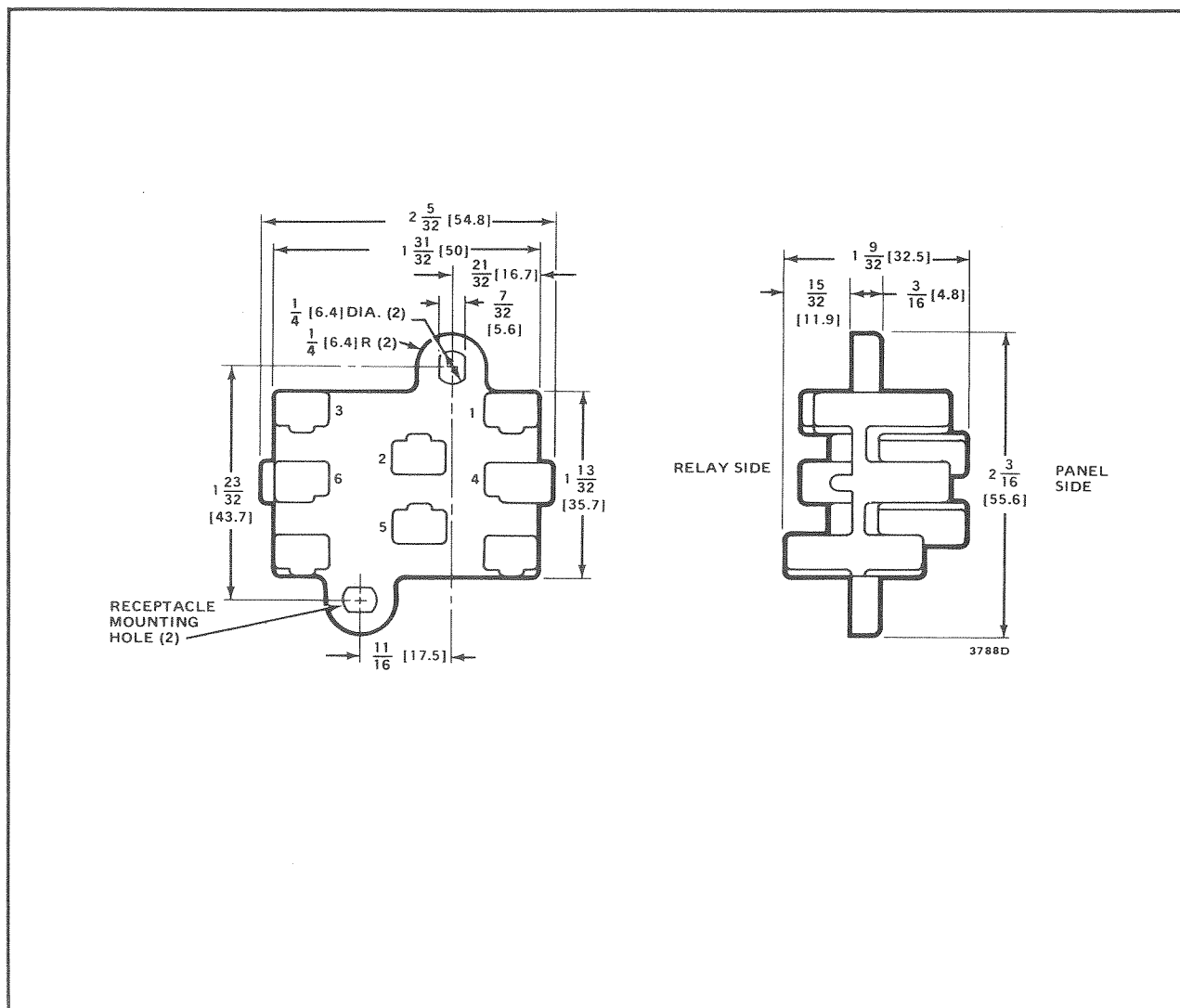

FIG. 2—DIMENSIONS OF WIRING RECEPTACLE.

INSTALLATION

WHEN INSTALLING THIS PRODUCT . . .

1. Read these instructions carefully. Failure to follow them could damage the product or cause a hazardous condition.
2. Check the ratings given in the instructions and on the product to make sure the product is suitable for your application.
3. Installer must be a trained, experienced service technician.
4. After installation is complete, check out product operation as provided in these instructions.

CAUTION

Disconnect power supply before beginning installation to prevent electrical shock or equipment damage.

LOCATION

Mount the relay on a flat, solid surface as close as possible to the equipment being controlled. *The relay may be mounted in any position except with the terminals pointed down.* Secure in place with two screws through holes or slots in the mounting base or as shown in Fig. 3 or 4. See Fig. 1 for mounting dimensions.

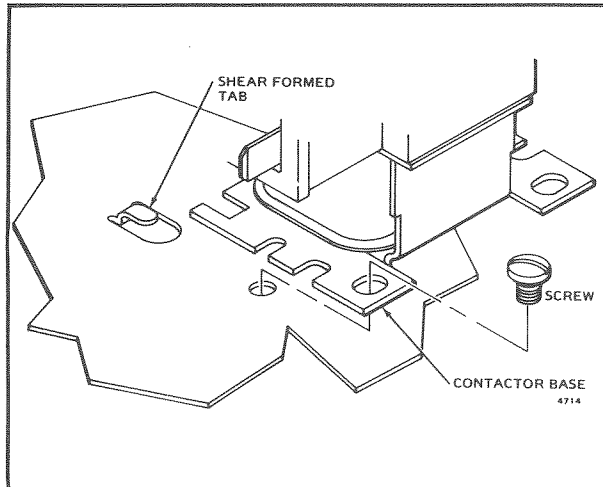

FIG. 3—MOUNTING RELAY ON PANEL WITH SHEAR-FORMED TAB AND ONE SCREW.

WIRING

Disconnect power supply before connecting wiring to avoid electrical shock or equipment damage.

All wiring must comply with local codes and ordinances. Crimp female quick-connects to the system wires and attach to the male quick-connect terminals of the relay. The relay has molded terminal numbers and circuit diagram for easy identification when wiring. Fig. 6 shows the location and circuits of all models.

Do not exceed contact and coil ratings when wiring into system.

Leadwires are provided with the 135959 Receptacle in 4074BVJ Bag Assembly for additional relay pole positions. Insert the required leadwires in the relay receptacle as follows.

Determine the leadwire colors required for the relay and application desired. Push the leadwire terminal into the receptacle plate from the side stamped with the numbers (Fig. 5). When inserting the leadwire, the tang on the quick-connect terminal must align with the small clearance slot in the terminal opening. Press the terminal in until it locks in place.

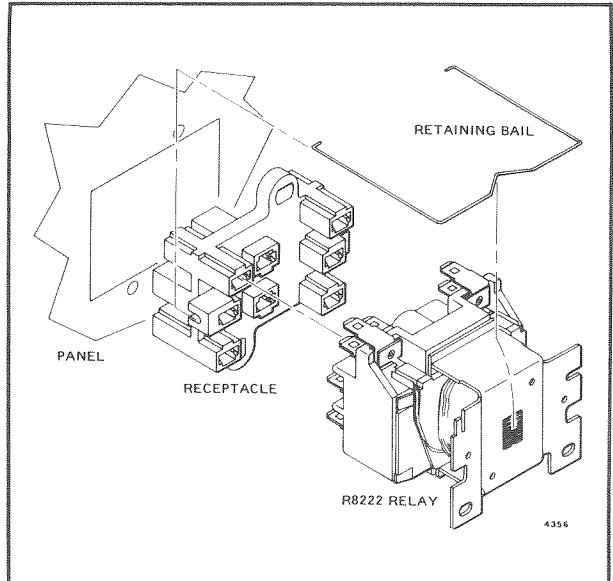

FIG. 4—RELAY MOUNTING USING RECEPTACLE AND RETAINING BAIL.

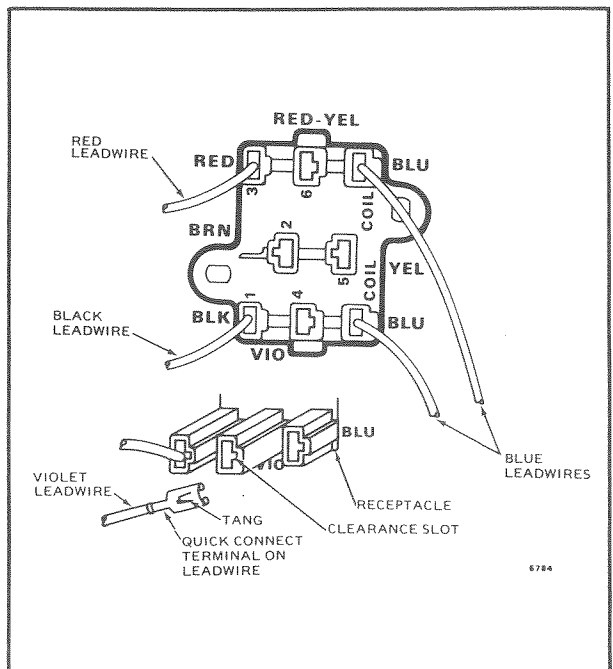

FIG. 5—BOTTOM OF 135959 RECEPTACLE SHOWING LEADWIRE INSTALLATION.

CHECKOUT

Operate the relay and controlled equipment to make sure that relay pulls in when the coil is energized and that controlled equipment operates as intended.

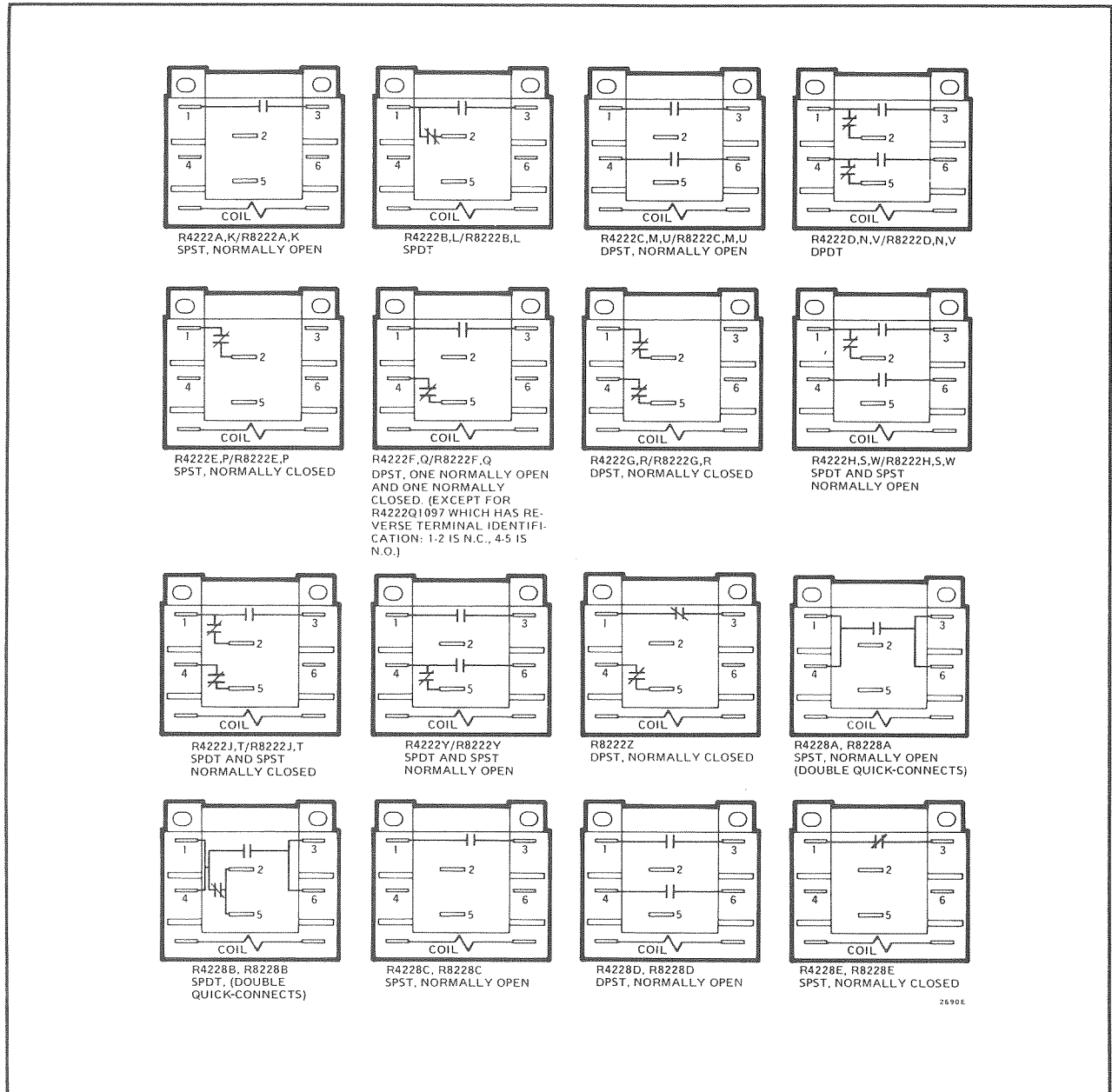

FIG. 6—R4222/R8222, R4228/R8228 CIRCUIT AND TERMINAL DESIGNATION.

