

**Effective Date 1/20/2012**

**Supersedes Price Book  
3/4/2011**

***tyco***

***Fire Protection Products***

**U. S. List Prices**

*for*

**Sprinklers, Devices, Grooved Piping,  
CPVC, Accessories and Repair Parts**

All products furnished by Tyco Fire Protection Products (hereinafter "Seller") shall be in accordance with the following terms and conditions unless otherwise stated in writing:

**ACCEPTANCE AND COMPLETE AGREEMENT** - Buyer's order is binding only when accepted in writing at the principal office of Seller. The terms and conditions of sale are only those stated below, which shall constitute the complete agreement between the parties and may not be altered or modified except in writing duly executed by each party. The parties agree there are no agreements between the parties, oral or written, with respect to the products sold hereunder (including any made or implied from past dealings) except as expressed herein. No terms and conditions stated in or attached to Buyer's communications to Seller, including but not limited to Buyer's purchase orders, the terms of which are hereby rejected, are applicable to these terms and conditions in any way and are not to be considered Buyer's exceptions to the provisions of these terms and conditions. Trade custom, trade usage and past performance are superseded by these terms and conditions and shall not be used to interpret these terms and conditions.

**DELIVERY** – Delivery dates are estimates only and are not guaranteed. Seller will use every *commercially reasonable* effort to make shipments as scheduled and may make partial shipments.

**EXPORTATION** - If the products ordered are to be exported from the United States, the quoted shipping dates are subject to receipt of all export documents and authorizations. Regardless of ultimate destination, the prices quoted are based on packing for domestic shipment unless otherwise stated in writing. Buyer agrees to provide Seller in writing with the ultimate destination and identity of the end-user prior to shipment if the products are to be exported. These commodities, technology or software shall be exported from the United States in accordance with the Export Administration Regulations. Diversion contrary to U.S. law is prohibited. Domestic Destinations – The Buyer of items shipping to USA destinations is solely responsible for complying with applicable U.S. export laws.

**PRICES** - Prices quoted, unless otherwise stated in writing, do not include sales, use, excise or similar taxes or duties. Buyer shall pay these taxes directly if the law permits or will reimburse Seller if it is required to pay them. Buyer will provide tax exemption certificates or evidence of tax payment on request. Unless otherwise stated, prices are valid for 60 days and for the delivery date specified in the quotation. Revisions to the desired delivery date by the Buyer and delays not due to Seller's negligence may be subject to escalation of prices at Seller's sole discretion.

For direct and indirect U.S. government contracts only, all Products and Services provided by Seller shall be considered "commercial items" as defined in FAR Part 2, 2.101 and in accordance with FAR 52.244-6. If the reasonableness of the price cannot be established, if cost or pricing data is required for any other reason, or if the Products or Services cannot be considered "commercial items," Seller may cancel the Contract without liability.

**PAYMENT** - Standard payment terms are net thirty (30) days from date of invoice. In the event credit has not been established Seller reserves the right to require payment, or the issuance of an irrevocable letter of credit, in advance of shipment. Any amounts not paid when due shall bear interest at the rate of 1 1/2% per month or at the highest rate permitted by law (whichever is less), from the date of shipment until paid. Seller reserves a purchase money security interest in each product shipped, which will be satisfied by payment in full. Seller has the right to file a copy of this document as a financing statement.

**SOLVENCY** - Buyer's order will be deemed a representation that Buyer is solvent and able to pay for the products ordered. If Buyer fails to make payments when due or if bankruptcy or insolvency proceedings are instituted by or against Buyer, or if Buyer makes an assignment for the benefit of creditors, Buyer will be deemed to be in default and Seller will have the right to terminate its obligations by written notice to Buyer, but such termination will not affect Buyer's obligation to pay for products delivered and works in progress.

**CANCELLATION** - No products may be returned without prior written approval of Seller. Orders placed with and accepted by Seller may not be canceled except upon Seller's written consent prior to shipment and Buyer's acceptance of Seller's cancellation charges which shall protect Seller against all costs and losses. Seller reserves the right to cancel any sale hereunder in Seller's sole discretion without liability to Buyer (except for refund of monies already paid).

**MANUFACTURE** - Seller reserves the right to discontinue the manufacture of, or change or modify the design and/or construction of the products sold pursuant to these terms and conditions, without incurring any obligation to Buyer.

**JURISDICTION AND DISPUTES** - These terms and conditions shall be governed in accordance with the law of the Commonwealth of Pennsylvania. All disputes under these terms and conditions shall be resolved by the state or federal courts of the Commonwealth of Pennsylvania and the parties all consent to the jurisdiction of such courts, agree to accept service process by mail, and hereby waive any jurisdiction or venue defenses otherwise available.

**INSPECTION** - All products must be inspected within five (5) calendar days of receipt. If any damage is discovered, a claim must be filed with the carrier. A full report of the damage must be forwarded to Seller so that it can arrange for repair or replacement.

**TITLE** –Unless otherwise provided on the face hereof, all products furnished hereunder will be shipped “Ex-Works (EX-W),” and title in, risk of loss, and the right of possession to such goods shall pass to the Buyer upon the Seller’s delivery to carrier at Seller’s shipping facility, and Seller is not responsible for damage or loss in transit, regardless of whether or not Buyer may have the right to reject or revoke acceptance of said products. Seller can arrange for in-transit insurance at Buyer’s expense, but will not do so without Buyer’s written instructions. Unless otherwise stated in contract documents, all goods will be shipped freight prepaid and billed. Charges for shipping may not reflect net transportation cost paid by the Seller.

**WARRANTY** – Unless otherwise stated in quotation documents or product literature provided with the product at the time of sale, products manufactured by Tyco Fire Protection Products (TFPP) are warranted solely to the original Buyer for eighteen months (18) months from date of shipment or one (1) year from date of installation against defects in material and workmanship when paid for and properly installed and maintained under normal use and service. In all cases, this warranty will expire not later than ten (10) years from date of shipment by TFPP. Warranty will be immediately voided by substitution of non-TFPP provided parts. No warranty is given for products or components manufactured by companies not affiliated by ownership with TFPP or for products and components which have been subject to misuse, improper installation, corrosion, or which have not been installed, maintained, modified or repaired in accordance with applicable Standards of the National Fire Protection Association, and/ or the standards of any other Authorities Having Jurisdiction. Materials found by TFPP to be defective shall be either repaired or replaced, at TFPP’s sole option. TFPP neither assumes, nor authorizes any person to assume for it, any other obligation in connection with the sale of products or parts of products. Seller shall not be responsible for sprinkler system design errors or inaccurate or incomplete information supplied by Buyer or Buyer’s representatives.

In no event shall TFPP be liable, in contract, tort, strict liability or under any other legal theory, for incidental, indirect, special or consequential damages, including but not limited to lost profits and labor charges, regardless of whether TFPP was informed about the possibility of such damages, and in no event shall TFPP’s liability exceed an amount equal to the sales price.

**THE FOREGOING WARRANTY IS MADE IN LIEU OF ANY AND ALL OTHER WARRANTIES, EXPRESS OR IMPLIED, INCLUDING WARRANTIES OF MERCHANTABILITY AND FITNESS FOR A PARTICULAR PURPOSE.**

This limited warranty sets forth the exclusive remedy for claims based on failure of or defect in products, materials or components, whether the claim is made in contract, tort, strict liability or any other legal theory.

This warranty will apply to the full extent permitted by law. The invalidity, in whole or part, of any portion of this warranty will not affect the remainder.

**COMPLIANCE WITH LAWS, CODES, AND STANDARDS** - Seller represents that the Products will be produced in compliance with applicable fair labor standards laws, occupational safety and health laws, and laws related to nonsegregation and equal employment opportunity. Warranties for design services and the accuracy of any materials list provided by Seller shall be limited only to those codes, standards or specification requirements specifically stated in Seller’s quotation documents or transmittal sheets or accepted change order or revisions and only as in effect at the time of quotation or Seller accepted change revisions. The Contract price, delivery and performance dates and any performance guarantees will be equitably adjusted to reflect additional costs or obligations incurred by Seller resulting from a change in industry specifications, codes, standards, applicable laws or regulations.

**DRAWINGS** - Any drawings submitted herewith are only to show the general style, arrangement, and approximate dimensions of the products offered. No work is to be based on drawings unless the drawings are certified. In no event will manufacturing or proprietary drawings be supplied.

**CONFIDENTIALITY** - Buyer agrees that all drawings, prints and other technical material which Seller provides to Buyer, whether prepared by Seller or by third parties under contract to Seller, contain data which embody trade secrets and confidential know-how of commercial value to Seller or third parties under contract to Seller. Buyer agrees (a) to keep such information confidential; (b) that it will not disclose such information to any other person, corporate division or entity; (c) will not use such information except in connection with the products supplied hereunder; and (d) will not sell, lease, loan or permit any other person, corporate division or entity to use such information for any purpose, without Seller’s prior written consent. Nothing herein shall restrict the use of information generally available to the public.

**PATENT INDEMNITY** - If a product delivered by Seller to Buyer becomes or, in Seller’s opinion, may become the subject of any claim, suit or proceeding for infringement of any patent, Seller may at its option and expense (i) obtain for Buyer the right to use, lease or sell the product, (ii) replace the product, (iii) modify the product, or (iv) remove the product and refund the purchase price paid by Buyer less a reasonable amount for use, damage or obsolescence. Seller will not be liable for any infringement arising from any modification of a product, from any combination of a product with any product(s), or from the use of a product in practicing a process or unintended applications. Seller’s total liability to Buyer will not, under any circumstances exceed the purchase price paid for the allegedly infringing product. Buyer agrees, at its expense, to protect and defend Seller against any claim of patent infringement arising from compliance with Buyer’s designs, specifications or instructions and to hold Seller harmless from damages, costs and expenses attributable to any such claim.

**INDEMNITY** – Buyer agrees to defend, indemnify and hold the Seller (and its agents, representatives, employees, officers, related companies, successors and assigns, and customers) harmless from all claims, demands, actions, damages, and liabilities (including attorney’s fees and consequential and incidental damages) arising out of any injury (including death) to any person or damage to any property in any way connected with any act or omission of Buyer, its agents, employees, or subcontractors.

**EXCUSABLE DELAYS** - Seller shall not be liable nor in breach or default of its obligations under the Contract to the extent performance of such obligations is delayed or prevented, directly or indirectly, due to causes beyond its reasonable control, including, but not limited to, acts of God, fire, terrorism, war (declared or undeclared), epidemics, material shortages, insurrection, acts (or omissions) of Buyer or Buyer’s suppliers or agents, any act (or omission) by any governmental authority, strikes, labor disputes, transportation shortages, or vendor non-performance. The delivery or performance date shall be extended for a period equal to the time lost by reason of delay, plus such additional time as may be reasonably necessary to overcome the effect of the delay. If Seller is delayed by any acts (or omissions) of Buyer, or by the prerequisite work of Buyer’s other contractors or suppliers, Seller shall be entitled to an equitable price and performance adjustment.

**WAIVER** - No failure to exercise and no delay in exercising on the part of Seller any right, power or privilege hereunder will operate as a waiver thereof nor will any single or partial exercise of any right, power or privilege hereunder preclude further exercise of the same right, power or privilege.

**VALIDITY OF PROVISIONS** - In the event any provision or any part or portion of any provision of these Terms and Conditions shall be held to be invalid, void or otherwise unenforceable, such holding shall not affect the remaining part or portions of that provision, or any other provision hereof.

#### **Additional Terms and Conditions of Sale**

##### **Return Goods Policy**

1. The request to return material must include the description of material, reason for return, customer order number and/or customer invoice number to enable the request to be processed. No materials may be returned without this information.
2. When the request is approved, a Return Authorization form will be completed and include a predetermined number for reference and advise where the material should be returned. The Return Authorization form will contain a Packing list copy which must accompany materials when they are returned. Return Authorizations are valid for 30 days only from date of issue.
3. No credit will be issued for returned materials without an approved Return Authorization.
4. Materials being returned due to order entry and/or shipping errors on the part of TFPP will be credited at full value providing the materials are returned within 30 days from the date of the original shipment.
5. Credit of the actual price paid will be issued for defective materials only after the material has been inspected and verified to contain a defect by TFPP.
6. A 25% restocking charge and/or a \$25.00 minimum charge, whichever is greater, will be assessed for inspecting, handling and restocking the material, and the total credit will depend upon the resale value of the material. Returned freight will be at the customer’s expense.
7. Items purchased for resale by TFPP may be returned under the Manufacturer’s terms and conditions only. If the Manufacturer will not accept the materials, credit will not be issued by TFPP to the Buyer.
8. Special material orders and made-to-order products are non-returnable.
9. Credit will not be issued for discontinued items. Items no longer manufactured or items superseded by another model are defined as discontinued.
10. In order to receive consideration for credit, material must be returned less than 2 years from date of original invoice and of reasonable quantities.
11. To receive consideration for credit, material must be in resalable condition.
12. Material that has been approved for return must be packed in such a way as to prevent damage during shipment. The use of original packaging is preferred. Credit cannot be issued for materials damaged in transit due to improper packaging.

##### **Minimum Billing**

The Minimum Billing Policy is \$100.00 per Order.



**Section 1 - Standard Spray Sprinklers**

TY-L, Pendent, Recessed Pendent & Upright, K=5.6, 1/2" N.P.T. ....	1-1
TY-L, Pendent, Recessed Pendent & Upright, K=8.0, 3/4" N.P.T. ....	1-2
TY-L, Pendent, Recessed Pendent and Upright Sprinklers, K=8.0, 1/2" N.P.T. ....	1-3
TY-L, Horizontal Sidewall Sprinkler, K=5.6, 1/2" N.P.T. ....	1-3
TY-FRL, Pendent, Recessed Pendent & Upright, Quick Response Sprinkler, K=2.8, 1/2" N.P.T. ....	1-4
TY-FRL, Pendent, Recessed Pendent & Upright, Quick Response Sprinkler, K=5.6, 1/2" N.P.T. ....	1-5
TY-FRL, Pendent & Upright, Quick Response Sprinkler, K=8.0, 3/4" N.P.T. ....	1-6
TY-FRL, Horizontal Sidewall Sprinkler, K=5.6, 1/2" N.P.T. ....	1-6
TY-B, 5mm Bulb, Pendent, Recessed Pendent and Upright, K=5.6, 1/2" N.P.T. ....	1-7
TY-B, 5mm Bulb, Pendent and Upright Sprinklers, K=8.0, 1/2" N.P.T. ....	1-8
TY-B, 5mm Bulb, Pendent, Recessed Pendent and Upright Sprinklers, K=8.0, 3/4" N.P.T. ....	1-9
TY-B, 5mm Bulb, Horizontal, Recessed Horizontal, and Vertical Sidewall Sprinklers, K=5.6, 1/2" N.P.T. ....	1-10
TY-FRB, 3mm Bulb, Quick Response, Pendent, Recessed Pendent and Upright Sprinklers, K=2.8, 1/2" N.P.T. ....	1-11
TY-FRB, 3mm Bulb, Quick Response, Pendent, Recessed Pendent and Upright Sprinklers, K=4.2, 1/2" N.P.T. ....	1-12
TY-FRB, 3mm Bulb, Quick Response, Pendent, Recessed Pendent and Upright Sprinkler, K=5.6, 1/2" N.P.T. ....	1-13
TY-FRB, 3mm Bulb, Quick Response, Pendent, Recessed Pendent and Upright Sprinkler, K=8.0, 3/4" N.P.T. ....	1-14
TY-FRB, 3mm Bulb, Quick Response, Horizontal, Recessed Horizontal Sidewall and Vertical Sidewall, K=5.6, 1/2" N.P.T. ....	1-15
RFII, Standard Response, "Royal Flush II" Pendent Concealed Sprinklers, K=5.6, 1/2" N.P.T. ....	1-16
RFII, Quick Response, "Royal Flush II" Pendent Concealed Sprinklers, K=5.6, 1/2" N.P.T. ....	1-17
TYQR, Quick Response Standard Coverage, Flush Pendent Sprinkler, K=5.6, 1/2" N.P.T. ....	1-18

**Section 2 - Extended Coverage Sprinklers**

EC-14, Upright Sprinklers, K=14.0, 3/4" N.P.T. ....	2-1
EC-14, Pendent and Recessed Pendent Sprinklers, K=14.0, 3/4" N.P.T. ....	2-2
EC-11, Pendent, Recessed Pendent and Upright Sprinklers, K=11.2, 3/4" N.P.T. ....	2-3
TY-FRB, 3mm Bulb, Quick Response, Extended Coverage, Horizontal & Recessed Horizontal Sidewall, K=5.6, 1/2" N.P.T. ....	2-4
TY-FRB, 3mm Bulb, Quick Response, Extended Coverage, Horizontal & Recessed Horizontal Sidewall, K=8.0, 3/4" N.P.T. ....	2-5
ELO SW-20, ECOH, Sidewall Sprinklers, K=11.2, 3/4" N.P.T. ....	2-6
ELO SW-24, ECOH, Sidewall Sprinklers, K=11.2, 3/4" N.P.T. ....	2-6
ELOC Extended Coverage, Concealed Sprinklers, K=11.2, 3/4" N.P.T. ....	2-6
RFII, "Royal Flush II" Pendent Concealed Sprinklers Extended Coverage, Quick & Standard Response, K=5.6. ....	2-7
TY-FRL, Extended Coverage Quick Response, Horizontal Sidewall Sprinkler, K=5.6, 1/2" N.P.T. ....	2-7
TY-FRL, Quick Response, Extended Coverage Horizontal Sidewall Sprinklers, K=8.0, 3/4" N.P.T. ....	2-8
CHEC, ECLH Concealed Horizontal Sidewall Extended Coverage Sprinklers, K=8.0, 3/4" N.P.T. ....	2-8
EC-8, QR, ECLH, Pendent and Recessed Pendent Sprinklers, K=8.0, 3/4" N.P.T. ....	2-9
EC-5, QR, Pendent, Recessed Pendent and Sidewall Sprinklers, K=5.6, 1/2" N.P.T. ....	2-10

**Section 3- Storage Sprinklers**

ESFR-25™, Early Suppression, Fast Response Sprinkler, K=25.2, 1" N.P.T. ....	3-1
EC-25, Upright, Area/Density, Extended Coverage, K=25.2, 1" N.P.T. ....	3-1
ESFR-17, Early Suppression, Fast Response Upright Sprinkler, K=16.8, 3/4" N.P.T. ....	3-1
ESFR-17, Early Suppression, Fast Response Pendent Sprinkler, K=16.8, 3/4" N.P.T. ....	3-2
ESFR-1, Early Suppression, Fast Response Sprinkler, K=14.0, 3/4" N.P.T. ....	3-2
Ultra K17, Upright, Thread Specific Application, K=16.8, 3/4" N.P.T. ....	3-3
K17-231, Thread, Upright, K=16.8, 3/4" N.P.T. ....	3-3
K17-231, Thread, Pendent, K=16.8, 3/4" N.P.T. ....	3-3
ELO-231 and ELO-231B, Standard Response, Upright and Pendent Sprinklers, K=11.2, 1/2" N.P.T. & 3/4" N.P.T. ....	3-4
ELO-231 FRB, Quick Response, Upright, Pendent Sprinklers, K=11.2, 3/4" N.P.T. ....	3-5
LD, Large Drop Upright Sprinklers, K=11.2, 3/4" N.P.T. ....	3-5
TY-B, 5mm Bulb, Standard Response, Intermediate Level Upright and Pendent Sprinklers with Shield, K=5.6, 1/2" N.P.T. ....	3-6
TY-B, 5mm Bulb, Standard Response, Intermediate Level Upright and Pendent Sprinklers with Shield, K=8.0, 3/4" N.P.T. ....	3-7
TY-FRB, 3mm Bulb, Quick Response, Intermediate Level Upright and Pendent Sprinklers with Shield, K=5.6, 1/2" N.P.T. ....	3-8
TY-FRB, 3mm Bulb, Quick Response, Intermediate Level Upright and Pendent Sprinklers with Shield, K=8.0, 3/4" N.P.T. ....	3-9
TY-L, Standard Response, Intermediate Level Upright and Pendent Sprinklers with Shield, K=5.6, 1/2" N.P.T. ....	3-10
TY-L, Standard Response, Intermediate Level Upright and Pendent Sprinklers with Shield, K=8.0, 3/4" N.P.T. ....	3-11
TY-FRL, Quick Response, Intermediate Level Upright and Pendent Sprinkler with Shield, K=5.6, 1/2" N.P.T. ....	3-12
TY-FRL, Quick Response, Intermediate Level Upright and Pendent Sprinkler with Shield, K=8.0, 3/4" N.P.T. ....	3-13

**Section 4 - Residential Products**

LFII, Low Flow Pendent, Fast Response, K=3.0, 1/2" N.P.T. ....	4-1
LFII, Low Flow Horizontal Sidewall, K=4.2, 1/2" N.P.T. ....	4-1
LFII, Low Flow Horizontal Sidewall, K=4.4, 1/2" N.P.T. ....	4-2
LFII, Low Flow Pendent, K=4.9, 1/2" N.P.T. ....	4-2
LFII, Residential Concealed Pendent Domed Plate, K=4.9 (pendent), 1/2" N.P.T. ....	4-3
LFII, Residential Flat-Plate Concealed Sprinkler, K=4.9, 1/2" N.P.T. ....	4-3
LFII, Residential Flush Pendent, K=4.2, 1/2" N.P.T. ....	4-4
LFII, Residential Flush Horizontal Sidewall Sprinkler, K=4.2, 1/2" N.P.T. ....	4-4
LFII, Residential NFPA 13 Optimized Horizontal Sidewall Sprinkler, K=5.8 & K=5.6, 1/2" N.P.T. ....	4-5
LFII, Residential NFPA 13 Optimized Pendent Recessed & Concealed, K=6.9, 3/4" N.P.T. ....	4-6
LFII, Residential Dry, Recessed Pendent and Domed Concealed Pendent, K=4.9 ....	4-7
LFII, Residential Dry, Horizontal Sidewall and Recessed Horizontal Sidewall, K=4.4 ....	4-7
RCP-1, Residential Control Panel 1" & 1 1/2", 175 psi ....	4-8
Residential Domestic Shutoff Valve ....	4-9

**Section 5 - Dry Sprinklers**

DS-1, Dry, Standard Coverage, Pendent, Upright & Horizontal Sidewall, Standard Response, K=5.6, 1" NPT. ....	5-1
DS-1, Dry, Standard Coverage, Pendent, & Horizontal Sidewall, Standard Response, K=5.6, 3/4" NPT. ....	5-2
DS-1, Dry, Standard Coverage, Pendent, Upright & Horizontal Sidewall, Quick Response, K=5.6 ....	5-3
DS-1, Dry, Extended Coverage, Horizontal Sidewall, Quick Response & Standard Response, K=5.6 ....	5-4
DS-1, Dry, Stainless Steel, Standard Coverage, Pendent, QR or SR, K=5.6 ....	5-5
DS-1, Dry, Stainless Steel, Standard & Extended Coverage, Horizontal Sidewall, QR or SR, K=5.6 ....	5-6
DS-2, Dry, ELO Standard Coverage, Pendent, Standard Response, K=11.2. ....	5-7
DS-2, Dry, ELO Standard Coverage, Pendent, Quick Response, K=11.2 ....	5-8
DS-2, Dry, ELO Extended Coverage, Pendent, Quick Response & Standard Response, K=11.2. ....	5-9
DS-3, Dry, Extended Coverage Ordinary Hazard (ECOH), Horizontal Sidewall, 1" NPT, 3 mm bulb, K=11.2 ....	5-10
DS-C, Dry Concealed, Standard Response, K=5.6 ....	5-11
DS-C, Dry Concealed, Quick Response, K=5.6 ....	5-12
DS-ECC, Dry Extended Concealed Coverage, Quick Response, K=5.6 ....	5-13

**Section 6 - Special Sprinklers**

Illusion™ Casino Sprinkler ELO Extra Large Orifice, Concealed Pendent Sprinklers, K=11.2, 3/4" N.P.T. ....	6-1
CC2, Combustible Concealed Space Upright Sprinklers, K=5.6, 1/2" N.P.T. ....	6-1
CC2, Combustible Concealed Space Upright Sprinklers, K=4.2, 1/2" N.P.T. ....	6-2
CC1, Combustible Concealed Space Upright Sprinklers, K=2.8, 1/2" N.P.T. ....	6-2
WS Window Sprinklers, K=5.6, 1/2" N.P.T. ....	6-2
Attic Sprinklers, K=4.2, 1/2" N.P.T., K=5.6, 1/2" N.P.T. & K=8.0, 3/4" N.P.T., Models BB, SD, HIP & AP ....	6-3
TFP TY-B, Stainless Steel & Titanium, Upright and Pendent Sprinkler, K=5.6 & 8.0, 1/2" & 3/4" N.P.T. ....	6-4
TFP TY-B, Stainless Steel & Titanium, Horizontal Sidewall Sprinkler, K=5.6 & 8.0, 1/2" & 3/4" N.P.T. ....	6-5
TFP TY-FRB, Stainless Steel & Titanium, Upright and Pendent Sprinkler, QR, K=5.6 & 8.0, 1/2" & 3/4" N.P.T. ....	6-6
TFP TY-FRB, Stainless Steel & Titanium, Horizontal Sidewall Sprinkler, QR, K=5.6 & 8.0, 1/2" & 3/4" N.P.T. ....	6-7
Tyco® RAVEN™, I-Series Institutional Pendent & Horizontal Sidewall Sprinkler, QR, Standard & Extended Coverage ....	6-8
TY-B, 5mm Bulb, Conventional (Old Style) Sprinklers, K=5.6, 1/2" N.P.T. ....	6-9
TY-B, 5mm Bulb, Conventional (Old Style) Sprinklers, K=8.0, 3/4" N.P.T. ....	6-10
TY-FRB, 3mm Bulb, Quick Response, Conventional (Old Style) Sprinklers, K=5.6, 1/2" N.P.T. ....	6-11
TY-FRB, 3mm Bulb, Quick Response, Conventional (Old Style) Sprinklers, K=8.0, 3/4" NPT. ....	6-12
Issue "D" Quartzoid®, High Temperature, K=5.6, 1/2" N.P.T. ....	6-13
Issue "D" Quartzoid®, Series – High Temperature, K=8.0, 3/4" NPT. ....	6-14

**Section 7 - Nozzles and Sprinkler Accessories**

D-3, Protectospray Nozzles, 1/2" N.P.T.	7-1
EA-1, Protectospray Nozzles	7-2
Mulsifyre Nozzles, 800 Series, 3/4" NPT Connection	7-3
High Velocity Spray Nozzles Type HV	7-3
Cooling Tower Nozzles, 3/4" NPT, K=2.90	7-4
Exposure Sprinklers, Model A, 1/2" NPT	7-4
Exposure Nozzles, B, 3/4" NPT	7-4
B-1, 1/2" Foam Water Sprinkler, 1/2" Male NPT	7-5
U.S. Navy, Nozzle, Type G, 1/2" NPT	7-5
U.S. Navy, Nozzle, Type SB, 1/2" NPT	7-5
Protectospray Nozzles, Type D4-A, 1/2" NPT	7-6
AM4, WaterMist Nozzles, Open Type, 1/2" NPT	7-6
AM6, WaterMist Nozzles, Bulb Type, 1/2" NPT	7-7
AM10, WaterMist Nozzles, Open Type, 1/2" NPT	7-7
AM11, WaterMist Nozzles, Bulb Type, 1/2" NPT	7-8
AM22, WaterMist Nozzles, Bulb Type, 1/2" NPT	7-8
AM24, WaterMist Nozzles, Bulb Type, 1/2" NPT	7-9
FTR-1, Fixed Temperature Release for Deluge & Preaction Systems Wet or Dry Pilot Release Service, 1/2" NPT	7-9
Blow-Off Caps and Dust Caps for Mulsifyre Projectors and Nozzles	7-10
Blow-Off Plugs for Protectospray Nozzles, Model D-3	7-10
Miscellaneous Escutcheons	7-10
Typical Escutcheons	7-11
Sprinkler Head Cabinets	7-12
G1 and G4 Sprinkler Guards, G1/S1 and G4/S3 Guards and Shields	7-12
DS-1 Dry Sprinkler Guard	7-12
G2 Guard, WS-2 Shield and WSG-2 Guard & Shield for ELO-231 Series	7-13
Special Services	7-13
Sprinkler Wrenches	7-14

**Section 8 - Wet System Valves**

AV-1-300, Alarm Valves	8-1, 8-2
CV-1FR, Shotgun Riser Check Valve	8-2
Residential Domestic Shutoff Valve	8-3
Riser Manifolds – Commercial & Residential	8-3
RC-1, Retard Chamber	8-4
Resi-Risers	8-4

**Section 9 - Water Motor Alarms**

WMA-1, Water Motor Alarm	9-1
--------------------------	-----

**Section 10 - Dry Pipe Valves**

DPV-1, Dry Pipe Valve	10-1
-----------------------	------

**Section 11 - Quick Opening Devices**

"VISOR" Model EDPA - Electronic Dry Pipe Accelerator	11-1
QRS, Electronic Accelerator	11-2
ACC-1, Dry Pipe Valve Accelerator	11-3

**Section 12 - Air Maintenance Devices**

Air Maintenance Devices	12-1
Accessories for Air Maintenance Devices	12-1

**Section 13 - Deluge Valves & Accessories**

DV-5, Deluge Valves, Diaphragm Style . . . . .	13-1, 13-2
DP-1, Dry Pilot Actuator . . . . .	13-3
Deluge Valve Accessories . . . . .	13-3
Model DV-5 Deluge Valves With Remote-Resetting Trim . . . . .	13-4, 13-5
Model DV-5 Deluge Valves With Remote-Resetting, Pressure-Reducing Trim . . . . .	13-6, 13-7
<b>Full Deluge Systems and Components</b>	
DV-5 Deluge Valves, Wet Pilot Actuation – 1½" thru 8" . . . . .	13-8
DV-5 Deluge Valves, Dry Pilot Actuation – 1½" thru 8" . . . . .	13-9
DV-5 Deluge Valves, Electric Actuation – 1½" thru 8" . . . . .	13-10
Red-E-Cabinets, with DV-5 Valves, Deluge, Double Interlock and Preaction Systems in Cabinets . . . . .	13-11 thru 13-13
Red-E-Cabinets, with "MCC" Mist Control Center, Preassembled Fire Pump, Controller, Deluge Valve Cabinet. . . . .	13-14
DV-5 Deluge Valve and Preaction Pre-Trimmed, Wet Pilot, Dry Pilot, & Electric Actuation . . . . .	13-15
DV-5 Deluge Valve and Preaction Pre-Trimmed, Single or Double Interlock . . . . .	13-16
DV-5 Deluge Valve and Preaction Pre-Trimmed, Remote-Resetting Trim, or Remote-Resetting, Pressure-Reducing Trim . . . . .	13-17

**Section 14 - Preaction Systems**

<b>Full Preaction Systems and Components</b>	
DV-5 Single Interlock, Wet Pilot Actuation, 1½" thru 8" . . . . .	14-1
DV-5 Single Interlock, Dry Pilot Actuation, 1½" thru 8" . . . . .	14-2
DV-5 Single Interlock, Electric Actuation, 1½" thru 8" . . . . .	14-3
DV-5 Double Interlock, Electric/Pneumatic Actuation, 1½" thru 8" . . . . .	14-4
DV-5 Double Interlock, Electric/Electric Actuation, 1½" thru 8" . . . . .	14-5
Optional Equipment for Single Interlock, Preaction Systems, Supervised . . . . .	14-6
Preaction Trim for Model DV-5 . . . . .	14-7, 14-8

**Section 15 - General Purpose Valves**

CV-1F Grooved Check Valves . . . . .	15-1
BFV-N Butterfly Valves - Wafer Style with Supervisory Switches - 250psi . . . . .	15-2
BFV-N Butterfly Valves - Lug Style with Supervisory Switches - 250psi . . . . .	15-2
Additional Wafer and Lug Lengths, withPIVA . . . . .	15-2
BFV-N Butterfly Valves - G x G, Gear Operated with Tamper Switches - 300psi . . . . .	15-3
PRV-1 Pressure Regulating Valve, 2" thru 8", 250 psi, Pilot Operated . . . . .	15-3
Model RV-1 Pressure Relief Valves 2" thru 8", 250 psi, Pilot Operated, Globe and Angle Body Styles . . . . .	15-4

**Section 16 - Specialty Items**

Valve System Accessories . . . . .	16-1
F350 Sectional Control Accessories . . . . .	16-1
F1321 Sight Flow Connection . . . . .	16-1
Ball Drip Valves . . . . .	16-1
Fill or Drip Cups . . . . .	16-1
DD-1 (Drum Drip) Wiliag Drain . . . . .	16-1
Manual Control Stations . . . . .	16-2
G16AC812 Automatic Supervisory Air Supply . . . . .	16-2
Water and Air Gauges . . . . .	16-2
Fusible Links/Fire Door Links Type C . . . . .	16-2
Zonecheck Flow Switch Tester . . . . .	16-3
"A" Strainers and SS Baskets . . . . .	16-3
"B-1" Strainer, Painted Finish and SS Baskets . . . . .	16-4
"C" Strainer, Heavy Duty, Welded Body . . . . .	16-4
Sprinkler Identification Signs . . . . .	16-5
Restriction Unions . . . . .	16-5

**Section 17 - Steel Pipe & Threaded Fittings**

Contact your TFPP Representative. (not included in this price book)

**Section 18 - Grooved Products \***

#577 G-FIRE Global and Domestic – Rigid Coupling with Grade “A” EPDM Fire Protection Pre-Lubricated Gasket . . . . .	18-1
#577 G-FIRE Domestic – Rigid Tri-Seal Coupling with Grade “E” EPDM Tri-Seal Gasket . . . . .	18-1
#705 Global and Domestic – Flexible Coupling with Grade “A” EPDM Fire Protection Pre-Lubricated Gasket . . . . .	18-2
#705 Domestic – Flexible Tri-Seal Coupling with Grade “E” EPDM Tri-Seal Gasket . . . . .	18-2
#707 Domestic Heavy-Duty Flexible Coupling with Grade “E” EPDM Gasket . . . . .	18-3
#707 Domestic Heavy-Duty Flexible Coupling with Grade “E” EPDM Tri-Seal Gasket . . . . .	18-3
#716 Domestic – Reducing Coupling with Grade “E” EPDM Non-Lubricated Gasket . . . . .	18-4
#716 Reducing Coupling Plate . . . . .	18-4
Replacement Gaskets, Grade “E” EPDM Gasket for #716 Reducing Coupling . . . . .	18-4
#71 Domestic – Grooved Flange Adapter with Grade “E” EPDM Non-Lubricated Gasket . . . . .	18-5
#71 Flange Adapter – Metal Washer & Nut, Bolt, and Gasket Kit . . . . .	18-5
#702 Global – Outlet Coupling Grade “E” Gasket, Female Threaded End . . . . .	18-6
#702 Global – Outlet Coupling Grade “E” Gasket, Male Threaded End . . . . .	18-6
#702 Global – Outlet Coupling Grade “E” Gasket, Grooved End . . . . .	18-6
Replacement Gaskets . . . . .	18-7
Coupling Nut and Bolt Kit . . . . .	18-7
GRINNELL Gasket Lubricant . . . . .	18-7
Pipe Tape . . . . .	18-7
#510S Global and Domestic – Fire Protection Short Pattern Grooved 90° Elbow . . . . .	18-8
#519S Global and Domestic – Fire Protection Short Pattern Grooved Tee . . . . .	18-8
#501 Global and Domestic – Fire Protection Standard Pattern Grooved 45° Elbow . . . . .	18-8
#510 Global and Domestic – Fire Protection Standard Pattern Grooved 90° Elbow . . . . .	18-9
#510DE Domestic – 90° Elbow with 1" Outlet . . . . .	18-9
#519 Global and Domestic – Fire Protection Standard Pattern Grooved Tee . . . . .	18-9
#260 Domestic and Global – Grooved Cap . . . . .	18-10
#260 Domestic and Global – Grooved Cap with 1/2" Tap . . . . .	18-10
#260 Domestic and Global – Grooved Cap with 1" Tap . . . . .	18-10
#40-5 Domestic – Strap . . . . .	18-11
ADACAP #750 Domestic . . . . .	18-11
#512 Domestic – Grooved 22 1/2° Elbow . . . . .	18-12
#511 Domestic – Grooved 11 1/4° Elbow . . . . .	18-12
#321 Domestic – Grooved Reducing Tee . . . . .	18-13
#550 and #350 Domestic – Concentric Reducer . . . . .	18-14
#341 Domestic – Grooved x Flanged Adapter 150 Lbs. – Schedule 40 . . . . .	18-15
#342 Domestic – Grooved x Flanged Adapter 300 Lbs. – Schedule 40 . . . . .	18-15
#320 Domestic – Grooved x Male Thread Tee . . . . .	18-15
Standpipe Domestic – Tee . . . . .	18-16
#507/#50L Domestic – Bullhead Tee . . . . .	18-16
#323 Domestic – Reducing Tee with Threaded Branch . . . . .	18-16
#327 Domestic – Grooved Cross . . . . .	18-17
#372 Domestic – Reducer Small End Threaded (Male) . . . . .	18-17
#391 Domestic – Groove x Male Thread Adapter Nipple . . . . .	18-18
#392 Domestic – Groove x Groove Adapter Nipple . . . . .	18-18
#393 Domestic – Groove x Plain Adapter Nipple . . . . .	18-19
#730 Domestic – Threaded Mechanical Tee with Grade “E” EPDM Gasket Threaded Outlet . . . . .	18-20
#730 Domestic – Grooved Mechanical Tee with Grade “E” EPDM Gasket Grooved Outlet . . . . .	18-21
#730 Domestic – Threaded Mechanical Cross with Grade “E” EPDM Gasket Threaded Outlet . . . . .	18-22
#730 Domestic – Grooved Mechanical Cross with Grade “E” EPDM Gasket Grooved Outlet . . . . .	18-23
#BFV-N Domestic – Grooved Butterfly Valves Fire Protection . . . . .	18-24
#CV-1F Global – Grooved Check Valve . . . . .	18-24
Roll Grooving Machine Selection Chart . . . . .	18-25
Roll Grooving – Accessories . . . . .	18-25
Roll Grooving – Roll Selection Chart . . . . .	18-26
Domestic Grooved Couplings – Packaging Quantity . . . . .	18-27
Domestic Grooved Fittings – Packaging Quantity . . . . .	18-27 – 18-28
Grooved Fittings – Pieces Per Carton/Case . . . . .	18-28
Global Grooved Couplings – Packaging Quantity . . . . .	18-29
Global Grooved Fittings – Packaging Quantity . . . . .	18-29

\*As used in this Table of Contents and Price Book, the designation “domestic” is meant to identify where the last point of manufacture or assembly takes place for a product. However, this designation does not represent compliance with any government regulatory standards or contract specifications and should not be relied upon for such purposes. You must request separate certifications or other representations concerning the specific regulatory standards or contract specifications which apply for your application.

In order to request regulatory or specification certifications/representations please contact Tyco Trade Compliance at 215-362-0700 for assistance. In your request, please identify the part numbers and specific regulatory standards or contract specifications about which you are inquiring.



**Section 19 - CPVC**

PATHFINDER - 90° Elbow (Slip x Slip) . . . . .	19-1
PATHFINDER - 45° Elbow (Slip x Slip) . . . . .	19-1
PATHFINDER - Cap (Slip) . . . . .	19-1
PATHFINDER - Coupling (Slip x Slip) . . . . .	19-1
PATHFINDER - Tee (Slip x Slip x Slip) . . . . .	19-1
PATHFINDER - Reducing Tee (Slip x Slip x Slip) . . . . .	19-1
PATHFINDER - Cross (Slip x Slip x Slip x Slip) . . . . .	19-1
PATHFINDER - Reducing Bushing (Slip x Slip) . . . . .	19-1
PATHFINDER - Female Adapter w/Brass (Slip x Female) . . . . .	19-1
PATHFINDER - Sprinkler Adapter w/Brass (Slip x FIPT) . . . . .	19-1
PATHFINDER - Sprinkler 90° Elbow w/Brass (Slip x FIPT) . . . . .	19-1
PATHFINDER - Sprinkler Head Tee w/Brass (Slip x FIPT) . . . . .	19-1
Cap (Slip) . . . . .	19-2
Coupling (Slip x Slip) . . . . .	19-2
Reducing Coupling (Slip x Slip) . . . . .	19-2
90° Elbow (Slip x Slip) . . . . .	19-2
45° Elbow (Slip x Slip) . . . . .	19-2
Tee (Slip x Slip x Slip) . . . . .	19-2
Reducing Tee (Slip x Slip x Slip) . . . . .	19-3
Cross (Slip x Slip x Slip x Slip) . . . . .	19-3
Reducer Bushing (Slip x Slip) . . . . .	19-3
Female Sprinkler Head Adapter (Slip x FIPT) with Brass Threaded Insert . . . . .	19-3
Back-to-Back Tee, Sprinkler Head Adapter (FIPT x FIPT x Slip) with Brass Threaded Inserts . . . . .	19-4
Back-to-Back Cross Sprinkler Head Adapter (Slip x FIPT) with Brass Threaded Inserts . . . . .	19-4
Spigot Sprinkler Head Adapter (Slip x FIPT) with Brass Threaded Insert . . . . .	19-4
Sprinkler Head 90° Elbow (Slip x FIPT) with Brass Threaded Insert . . . . .	19-4
Sprinkler Head Tee (Slip x Female) with Brass Threaded Insert . . . . .	19-4
CPVC to Female Adapter (slip x female) with Brass Threaded Insert . . . . .	19-4
Male Adapter (Slip x Male) with Brass Threaded Insert . . . . .	19-4
Grooved Coupling Adapter (Groove x Slip) . . . . .	19-4
CPVC Pipe . . . . .	19-5
Primers & Cements . . . . .	19-6
Accessories . . . . .	19-6
Fire Stop . . . . .	19-6
Rothenberger Tools . . . . .	19-6
Tyco Fire Products CPVC Tools . . . . .	19-6
McNulty Tools . . . . .	19-6
Reed Tool Manufacturing . . . . .	19-6

**Section 20 - Miscellaneous**

Discontinued Valve Replacement Parts	
Model "AF" or "AG" - 4" Dry Pipe Valve (2002) . . . . .	20-1
Model "AF" or "AG" - 6" Dry Pipe Valves (2002) . . . . .	20-1
Model "H & K" - 4" Dry Pipe Valve (1988) . . . . .	20-1
Model "H & K" - 6" Dry Pipe Valve (1988) . . . . .	20-1
Model "D" - 2" & 2½" Dry Pipe Valve (1988) . . . . .	20-2
Model "D" - 3" Dry Pipe Valve (1988) . . . . .	20-2
Model "D" - 4" Dry Pipe Valve (1988) . . . . .	20-2
Model "A" - 4" Deluge Valve (2001) . . . . .	20-2
Model "A" - 6" Deluge Valve (2001) . . . . .	20-2
Model DV-3 Deluge Valve (2007) . . . . .	20-3
Model "F" and "G" - 2½" thru 8" Alarm Valve (2003) . . . . .	20-3
Model "AF" 2", 2½" and 3" Dry Pipe Valves/Trim (2007) . . . . .	20-4
Model F-302 & F-3021, 4" Dry Pipe Valve Replacement Parts (2002) . . . . .	20-4
Model F-302 & F-3021, 6" Dry Pipe Valve Replacement Parts (2002) . . . . .	20-4
Model A-2, 2" Dry Pipe Valve Replacement Parts (1999) . . . . .	20-4
Model B Deluge Valve (2004) . . . . .	20-5
Model DV-1 Deluge Valves (2007) . . . . .	20-5
Model E Alarm Check Valve 8" - (1999) . . . . .	20-6
Model F Alarm Check Valves 4" & 6" - (1999) . . . . .	20-6
Model A-1 Dry Pipe Valves, 4" & 6" (2002) . . . . .	20-6
Model F and G Dry Pipe Valves 3", 4" & 6" (1985) . . . . .	20-7
Model "A-1" Preaction Valve (2003) . . . . .	20-7
Model "D" - Deluge Valve 3", 6" & Coils - (Electromatic) (2002) . . . . .	20-8
Model BB - Exhauster (2006) . . . . .	20-8
Discontinued Sprinkler Accessories	
A Royal Flush Concealed Ceiling Plate Assembly (2002) . . . . .	20-9
Starmist Escutcheons (2002) . . . . .	20-9
PH2, Institutional Pendent, Standard Response Sprinkler, K=5.6, ½" N.P.T. (2005) . . . . .	20-10
PH5, Institutional Horizontal Sidewall, Standard Response Sprinkler, K=5.6, ½" N.P.T. (2005) . . . . .	20-11
LFII - Residential Concealed Sprinkler, K=4.2, 1/2" N.P.T. (2010) . . . . .	20-12
LFII - Residential Concealed Sprinkler, K=4.9, 1/2" N.P.T. (2010) . . . . .	20-12

**Section 21 - Electrical**

Electrical	
Waterflow Switches .....	21-1
Tamper Switches - OS&Y .....	21-1
Tamper Switches - Butterfly/PIV .....	21-1
Pressure Switches .....	21-1
Explosion Proof Switches .....	21-1
Switches for Copper Systems .....	21-1
Electric Bells .....	21-1
Weatherproof Backbox .....	21-1
Horns .....	21-1
Release Panel .....	21-1
Batteries for Release Panel .....	21-1
Corrosion Inhibiting Device .....	21-1
Solenoid Valves	
Ordinary Location .....	21-1
Hazardous Location .....	21-1
Heat Detectors .....	21-1
Horn Strobes .....	21-1
General Air Products	
Air Compressors .....	21-2
Magnetic Line Starter .....	21-2
Riser Mount Kits - Universal Bracket .....	21-2
Dry Air Pacs .....	21-2
Accessories .....	21-2
Quell Fire Sprinkler Systems Products	
Thermocable LHD - Linear Heat Detection Wire, PVC Jacket (Vinyl) .....	21-3
Mounting Straps, Temperatures -40°F to 185°F .....	21-3
Mounting Clips and Clamps, Temperatures -40°F to 185°F .....	21-4
GuideWire Mounting Accessories .....	21-4
Surface Mounting .....	21-5
Installation .....	21-5
Cable Connecting Accessories .....	21-5
Cable Splicing Accessories .....	21-6
Fire Alarm Control / Releasing Panel - Modules .....	21-6

**Section C - Valves and Hose Equipment**

<b>Kennedy Valves</b>	
O.S.&Y. Gate Valve UL/FM Resilient Wedge with 3/4" Tap and Plug - Model #4068A	C-1
O.S.&Y. Valve Flanged x Grooved - Model #7092A	C-1
Grooved Check Valve - Model #426	C-1
Iron Body Swing Check Valves UL/FM Flanged 175 PSI – Model 126A	C-1
Wafer Check Valves UL/FM 300 PSI – Model 706	C-1
Flanged PIV Non Rising Stem Gate Valve Resilient Wedge – Model 4701	C-1
#01G - Grooved BFV	C-1
#01G - Wafer BFV	C-1
PIV, NRS Gate Valve UL/FM Mechanical Joint with Accessories Resilient Wedge – Model 4071	C-1
Wall Post Indicator Model 641-13 Includes Stem and Coupling	C-1
Vertical Post Indicator (Formerly Model #741)	C-1
<b>Babbitt Valve Chainwheels</b>	
Cast Iron Standard Chainwheel	C-1
Epoxy Coated Corrosion Resistant Chainwheel	C-1
Hot Dipped Galvanized Standard Chain	C-1
<b>United Brass Bronze Valves</b>	
Globe Valves	C-2
Swing Checks	C-2
Ball Valves	C-2
Angle Valves	C-2
OS&Y Valves	C-2
<b>Milwaukee Butterball Valves</b>	
Valve with two (2) tamper switches	C-2
Valve only	C-2
<b>Trim Valves</b>	
Globe Valves	C-2
Swing Checks	C-2
Ball Valves	C-2
Angle Valves	C-2
<b>Hose Valves &amp; FDC's</b>	
Hose Valves	C-3
STORZ Equipment	C-3
Fire Department Connections	C-3
<b>Croker Standpipe and Hose Equipment</b>	
Hose Rack Units	C-3
Adjustable Fog Nozzles	C-3
Fire Hose	C-3
Hose Valves	C-3
Fire Department Inlet Connections	C-4 – C-5
Check Valves	C-5
Storz Connections (with Plate & Cap)	C-5
Roof Manifolds (Body Only)	C-5
Cabinets	C-5
<b>Guardian Standpipe and Hose Equipment</b>	
Hose Rack Units	C-6
Adjustable Fog Nozzles	C-6
Fire Hose	C-6
Hose Valves	C-6
Reducer	C-6
Pressure Restricting Hose Valves	C-6
Fire Department Inlet Connections	C-6 – C-7
Check Valves	C-7
Storz Connections (with Plate & Cap)	C-7
Roof Manifolds (Body Only)	C-8
Cabinets	C-8

**Section "D" Backflow**

<b>Ames</b>	
Model Maxim M200 With FxG OS&Y Valve . . . . .	D-1
Model Maxim M200 With Grooved Butterfly Valve . . . . .	D-1
Model Maxim M300 DCDA With FxG OS&Y Valve (GPM Meter) . . . . .	D-1
Model Maxim M300 DCDA With FxG OS&Y Valve (CFM Meter) . . . . .	D-1
Model Maxim M300 DCDA With Grooved Butterfly Valve (GPM Meter) . . . . .	D-1
Model Maxim M300 DCDA With Grooved Butterfly Valve (CFM Meter) . . . . .	D-1
Model Maxim M400 With FxG OS&Y Valve . . . . .	D-1
Model Maxim M400N With Grooved Butterfly Valve . . . . .	D-1
Model Maxim M500 RPDA With FxG OS&Y Valve (GPM Meter) . . . . .	D-1
Model Maxim M500 RPDA With FxG OS&Y Valve (CFM Meter) . . . . .	D-1
Model Maxim M500N RPDA With Grooved Butterfly Valve (GPM Meter) . . . . .	D-1
Model Maxim M500N RPDA With Grooved Butterfly Valve (CFM Meter) . . . . .	D-1
Model 1000 DCV Detector Check . . . . .	D-1
Model 1005 DCV Detector Check . . . . .	D-1
Model 2000B Brass Double Check Assy . . . . .	D-1
Model 3000B Brass Assembly . . . . .	D-2
Model 4000B Brass Reduced Pressure Backflow Assy . . . . .	D-2
Model 2000 SS Double Check Backflow Assembly . . . . .	D-2
Model 3000 SS Double Check Detector Backflow Assembly . . . . .	D-2
Model 4000 SS Reduced Pressure Backflow Prevention Assembly . . . . .	D-2
Model 5000 SS Reduced Pressure Detector Assembly . . . . .	D-2
Air Gap Drains Model 2001 SS Double Check Assembly . . . . .	D-2
Maxim/Colt Air Gap Drains . . . . .	D-2
<b>Colt</b>	
Model C200 Double Check Assembly . . . . .	D-3
Model C300 Double Check Detector Assembly . . . . .	D-3
Model C400 Reduced Pressure Assembly . . . . .	D-3
Model C500 Reduced Pressure Detector Assembly . . . . .	D-3
<b>Febco</b>	
Model 850 Double Check Assembly . . . . .	D-3
Model 870V (Vertical) Double Check Assembly . . . . .	D-3
Model 856 Double Check Detector Assembly . . . . .	D-3
Model 876V (Vertical) Double Check Detector Assembly (with O.S.&Y. Valves) . . . . .	D-4
Model 860 Reduced Pressure Assembly (with O.S.&Y. Valves) . . . . .	D-4
Model 880V Reduced Pressure Assembly . . . . .	D-4
Model 826 Reduced Pressure Detector Assembly . . . . .	D-4
Model 850U Double Check Assembly . . . . .	D-4
Model 850 Double Check Assembly . . . . .	D-4
Model 860 Reduced Pressure Assembly . . . . .	D-4
Model 825 Y Reduced Pressure Assembly . . . . .	D-4
Air Gaps Drains . . . . .	D-4
<b>Wilkins</b>	
Model 310 & 310A Single Check Valve Assembly . . . . .	D-5
Model 350AB & 350A Double Check Valve . . . . .	D-5
Model 350ADA Double Check Detector . . . . .	D-5
Model 375 Reduced Pressure Principle . . . . .	D-5
Model 375ADA Reduced Pressure Detector Assembly . . . . .	D-5, D-6
Model 475 Reduced Pressure Principle . . . . .	D-6
Model 950XL Double Check Valve Assembly . . . . .	D-6
Model 975 Reduced Pressure Principle . . . . .	D-6
<b>Watts Regulator (Small Backflow Preventors)</b>	
Model 007 LF, Model 007 QT Double Check Backflow . . . . .	D-7
Model 009 LF, Model 009 QT Reduced Pressure Backflow . . . . .	D-7
Air Gap Drains . . . . .	D-7
Backflow Repair Kits . . . . .	D-7
Model 709 Double Check Valve Backflow Assembly . . . . .	D-7
Model 007/709 Double Check Detector Assembly . . . . .	D-7
Model 009/909 Reduced Pressure Zone Backflow Preventor . . . . .	D-7, D-8
Model 909 Reduced Pressure Zone Backflow Detector Assembly . . . . .	D-8



**Section "F" Pipe & Accessories**

SCI		
SCI Coop-Let F.T. & Grooved	.....	F-1
Merit		
Grooved Outlets	.....	F-2
Adjustable Drop Nipples	.....	F-2
Welded Flange	.....	F-2
Flexhead Flexible Drop Nipples	.....	F-2
SprinkFlex Flexible Drop Nipples	.....	F-2
Test/Drain Assemblies	.....	F-3
Sight Drains	.....	F-3
Bolt, Nut, Gasket Kits	.....	F-3
Red Rubber Gaskets	.....	F-3
Split Rings Plastic Floor and Ceiling Plates	.....	F-3
Flanged Fittings		
Flanged 90° Elbow	.....	F-4
Flanged 45° Elbow	.....	F-4
Flanged Straight Tee	.....	F-4
Flanged Reducing Tee	.....	F-4
Cast Iron Companion Flange	.....	F-4
Flanged Concentric Reducer	.....	F-4
Blind Flange	.....	F-4
Long Radius Flanged 90° Elbow	.....	F-4
Floor Flange	.....	F-4
Flanged Reducing 90° Elbow	.....	F-5
Flanged Bull Tee	.....	F-5
Flanged Eccentric Reducer	.....	F-5
Ductile Iron Fittings		
#811 Ductile Iron 90° Elbows	.....	F-5
#813 Ductile Iron 45° Elbows	.....	F-5
#814 Ductile Iron Tees	.....	F-5
#818 Ductile Iron Couplings	.....	F-5
#820 Ductile Iron Caps	.....	F-5
#817 Ductile Iron Crosses	.....	F-5
#719 Ductile Iron Plugs	.....	F-5
#825 Ductile Iron Extension Pieces	.....	F-5
#817 Ductile Iron Reducing Crosses	.....	F-5
#827 Ductile Iron Hex Bushings	.....	F-5
#816 Ductile Iron Reducing Couplings	.....	F-6
#830 Ductile Iron Unions	.....	F-6
#812 Ductile Iron Reducing 90° Elbows	.....	F-6
#815 Ductile Iron Reducing Tees	.....	F-6
Central Sprinkler California Fittings	.....	F-7
Male Outlets Tees	.....	F-7
Male 90° Street Elbow	.....	F-7
Standard Black Nipple	.....	F-7
Extra Heavy Black Nipple	.....	F-8
Galvanized Nipple	.....	F-8

**Section "H" Hangers**

<b>Erico Hangers</b>	
CPVC Hangers & Surge Restraints . . . . .	H-1
CPVC Hangers - Head Set Bracket . . . . .	H-1
Heavy Duty Swivel Hanger - Model 115 . . . . .	H-1
Beam Clamps - Model 300 . . . . .	H-1
Heavy Duty Beam Clamps - Model 547 . . . . .	H-1
Steel C-Clamp - Model 200 . . . . .	H-1
Eye Sockets - Model 37 . . . . .	H-1
300-C Retaining Strap (Bulk Units) . . . . .	H-1
Eye Socket Offset - Model 38 . . . . .	H-1
Wide Flange Purlin Clamp - Model 315 . . . . .	H-1
Steel Wood Drive Screw - Model 43 . . . . .	H-1
Steel Rod Coupling - Model 25 . . . . .	H-2
Knurled Hanger Inserts - Model 100N . . . . .	H-2
Coach Screw Rod Machine Thread - Model 41 . . . . .	H-2
Lag Screw - Model 42 . . . . .	H-2
Clevis Hanger Standard - Model 400 . . . . .	H-2
Concrete Insert - Model 355 & 355N . . . . .	H-2
Nail Plate - Model 30482 . . . . .	H-2
Plastic Rod Button - Model 15 . . . . .	H-2
Toggle - Model 148 . . . . .	H-2
Pipe Clamp Standard - Model 450 . . . . .	H-2
Riser Clamp - Model 510 . . . . .	H-2
Steel Side Beam Attachment - Model 325 . . . . .	H-3
Tapped Side Beam Steel Connector - Model 328 . . . . .	H-3
Steel Wall Plate - Model 365 . . . . .	H-3
Yook U Type Hanger - Model 135 (Fits 1" & 1 1/4" Pipe) . . . . .	H-3
Yook Wrap-a-Round U Type Hanger Model 137 . . . . .	H-3
Strut Clamp - Model RIGD . . . . .	H-3
Multi-Flange Rod Hanger . . . . .	H-3
<b>Tolco for CPVC</b>	
Hangers for CPVC Plastic Pipe, Model 22, Model 23, Model 24 . . . . .	H-4
Ring Hangers - Model 200 . . . . .	H-4
<b>Tolco Earthquake Bracing</b>	
Fast Clamp Sway Brace Attachment - #1000 & #1001 . . . . .	H-4
Longitudinal 4-way Brace Attachment - #907 . . . . .	H-4
Non-Threaded Structural Attachment - #909 . . . . .	H-4
Threaded Structural Attachment - #910 . . . . .	H-4
Threaded Straight Fittings - #975 . . . . .	H-4
Pipe Clamp for Sway Bracing - #4A . . . . .	H-4
Beam Clamp Retaining Straps - #69 . . . . .	H-4
<b>Threaded Rod Company</b>	
All Thread Rod . . . . .	H-5
All Thread Stud . . . . .	H-5
<b>Elco Ind. - Hanger Mate</b>	
Wood, Metal, and Concrete Screws . . . . .	H-5
Drill Adapters, Masonry Bit, Drive Sockets . . . . .	H-5
<b>Sammy Super Screw</b>	
Steel, Concrete, & Wood Screws . . . . .	H-6
Nut Drivers . . . . .	H-6
Sammy Screw Sidewinder . . . . .	H-6
Sammy Screw X-Press . . . . .	H-6
Swivel-Head Sammy Screw - Wood and Steel . . . . .	H-6
<b>Afcon</b>	
Sway Brace Clamp Model E-001, Model 410, Model E-020 . . . . .	H-7
Threaded Attachment End - Model E-070 . . . . .	H-7
Locking Attachment - Model 077 . . . . .	H-7
U-Bolt With Nut - Model 240 . . . . .	H-7
Surge Restrainer . . . . .	H-7
Afcon for CPVC . . . . .	H-7

**Section "J" Lubricants**

LA-CO Industries	
Thread Sealant Paste .....	J-1
Gasket Lubricant .....	J-1
Tape .....	J-1
Pipe Markers (Valve Action) .....	J-1
Noble Company "Fire Fighter"	
Anti-Freeze - Glycol for Steel Pipe (pre-mix, concentrate, pure) .....	J-1
Gasket Lubricant	
Silicone Gasket Lubricant .....	J-1
FPPI Sealant	
FPPI Thread-Fit Cutting Oil .....	J-2
FPPI PipeFit Thread Sealant .....	J-2
Oatey Great White Thread Sealant .....	J-2
FPPI LubeFit Gasket Lubricant .....	J-2

**Section "K" Misc.**

MIFAB / PMR	
Access Doors .....	K-1
Acudor Products	
Access Door, Flush, Prime coated steel, UF5000 .....	K-1



**Model TY-L, K=5.6, 1/2" NPT**

100 Box Quantity (Upright 21.5 lbs/box (SIN TY3111), Pendent 19 lbs/box (SIN TY3211))

	<i>C.O.</i>	<i>Upright</i>	<i>Pendent</i>	<i>Finish</i>	<i>Temperature</i>	<i>List Price</i>	
		53-111-1-165	53-112-1-165	Brass	165°F/74°C	\$25.50	
		53-111-1-212	53-112-1-212	Brass	212°F/100°C	\$25.50	
		53-111-1-280	53-112-1-280	Brass	280°F/138°C	\$25.50	
		53-111-9-165	53-112-9-165	Chrome	165°F/74°C	\$31.25	
	▶	53-111-9-212	53-112-9-212	Chrome	212°F/100°C	\$31.25	
	▶	53-111-9-280	53-112-9-280	Chrome	280°F/138°C	\$31.25	
	▶	53-111-7-165	53-112-7-165	Lead Coated	165°F/74°C	\$66.25	
	▶	53-111-7-212	53-112-7-212	Lead Coated	212°F/100°C	\$66.25	
	▶	53-111-7-280	53-112-7-280	Lead Coated	280°F/138°C	\$66.25	
	▶	53-111-6-165	53-112-6-165	Wax Coated	165°F/74°C	\$63.00	
	▶	53-111-6-212	53-112-6-212	Wax Coated	212°F/100°C	\$63.00	
	▶	53-111-8-165	53-112-8-165	Wax over Lead Coated	165°F/74°C	\$88.00	
	▶	53-111-8-212	53-112-8-212	Wax over Lead Coated	212°F/100°C	\$88.00	
		<b>Recessed Escutcheons (Order Separately)</b>					
			56-705-2-010	1/2" Brass Plated (Style 20)			\$9.05
			56-705-9-010	1/2" Chrome Plated (Style 20)			\$6.25
		56-705-4-010	1/2" White Color Coated (Style 20)			\$6.25	
		<b>Sprinkler Wrench</b>					
		56-000-1-849	W-Type 9 Wrench			\$43.50	
		56-000-1-948	W-Type 10 Wrench (Recessed Only)			\$67.25	
	<b>Technical Data Sheet: TFP110</b>						

Section 1  
Standard Spray Sprinklers

Section 2  
Extended Coverage Sprinklers

Section 3  
Storage Sprinklers

Section 4  
Residential Products

Section 5  
Dry Sprinklers

Section 6  
Special Sprinklers

Section 7  
Nozzles and Sprinkler Accessories

See latest Technical Data Sheets for specific Approvals, Listings, Design Parameters & available finishes. Sprinkler heads & escutcheons are priced separately unless otherwise noted.

Items marked "C.O." are made to order and may require longer delivery times. Please contact customer service for availability.



Section 1  
Standard Spray Sprinklers

Section 2  
Extended Coverage Sprinklers

Section 3  
Storage Sprinklers

Section 4  
Residential Products

Section 5  
Dry Sprinklers

Section 6  
Special Sprinklers

Section 7  
Nozzles and Sprinkler Accessories

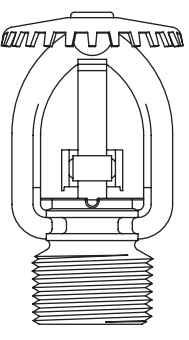
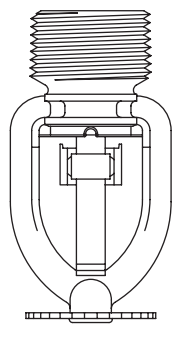
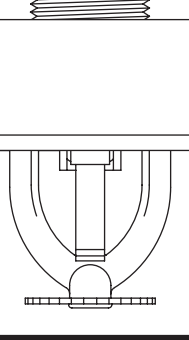
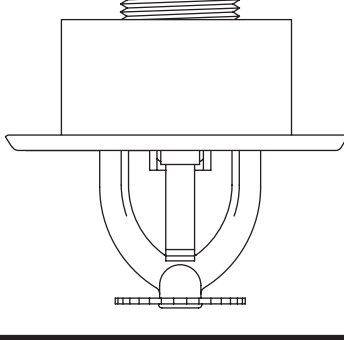
<b>Model TY-L, K=8.0, 3/4" Male NPT</b>						
100 Box Quantity (Upright 21.5 lbs/box (SIN TY4111), Pendent 21.5 lbs/box (SIN TY4211))						
	<i>C.O.</i>	<i>Upright</i>	<i>Pendent</i>	<i>Finish</i>	<i>Temperature</i>	<i>List Price</i>
		<b>53-101-1-165</b>	<b>53-102-1-165</b>	Brass	165°F/74°C	\$43.50
	▶	<b>53-101-1-212</b>	<b>53-102-1-212</b>	Brass	212°F/100°C	\$43.50
		<b>53-101-1-280</b>	<b>53-102-1-280</b>	Brass	280°F/138°C	\$43.50
		<b>53-101-9-165</b>	<b>53-102-9-165</b>	Chrome	165°F/74°C	\$49.50
	▶	<b>53-101-9-212</b>	<b>53-102-9-212</b>	Chrome	212°F/100°C	\$49.50
	▶	<b>53-101-7-165</b>	<b>53-102-7-165</b>	Lead Coated	165°F/74°C	\$107.50
	▶	<b>53-101-7-212</b>	<b>53-102-7-212</b>	Lead Coated	212°F/100°C	\$107.50
	▶	<b>53-101-7-280</b>	<b>53-102-7-280</b>	Lead Coated	280°F/138°C	\$107.50
	▶	<b>53-101-6-165</b>	<b>53-102-6-165</b>	Wax Coated	165°F/74°C	\$101.50
	▶	<b>53-101-6-212</b>	<b>53-102-6-212</b>	Wax Coated	212°F/100°C	\$101.50
	▶	<b>53-101-8-165</b>	<b>53-102-8-165</b>	Wax over Lead Coated	165°F/74°C	\$138.00
	▶	<b>53-101-8-212</b>	<b>53-102-8-212</b>	Wax over Lead Coated	212°F/100°C	\$138.00
	<b>Recessed Escutcheons (Order Separately)</b>					
		<b>56-705-2-011</b>	3/4" Brass Recessed (Style 30)			\$9.05
		<b>56-705-9-011</b>	3/4" Chrome Recessed (Style 30)			\$6.50
	<b>56-705-4-011</b>	3/4" White Recessed (Style 30)			\$6.50	
	<b>Sprinkler Wrench</b>					
		<b>56-000-1-849</b>	W-Type 9 Wrench			\$43.50
	<b>56-000-1-948</b>	W-Type 10 Wrench (Recessed Only)			\$67.25	
	<b>Technical Data Sheet: TFP110</b>					

Items marked "C.O." are made to order and may require longer delivery times. Please contact customer service for availability.

See latest Technical Data Sheets for specific Approvals, Listings, Design Parameters & available finishes. Sprinkler heads & escutcheons are priced separately unless otherwise noted.

**Model TY-L, K=8.0, 1/2" Male NPT, Pendent, Recessed Pendent and Upright Sprinklers**

100 Box Quantity (Upright 21.5 lbs/box (SIN TY4811), Pendent 21.5 lbs/box (SIN TY4911))

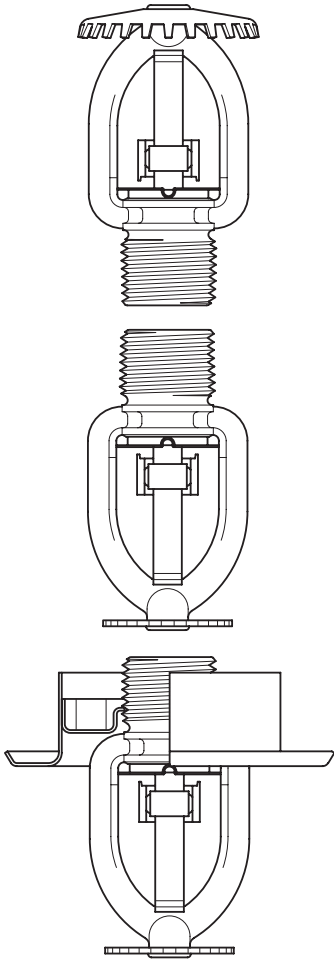
	C.O.	Upright	Pendent	Finish	Temperature	List Price	
		53-106-1-165	53-107-1-165	Brass	165°F/74°C	\$76.50	
	▶	53-106-1-212	53-107-1-212	Brass	212°F/100°C	\$76.50	
		53-106-1-280	53-107-1-280	Brass	280°F/138°C	\$76.50	
	▶	53-106-7-165	53-107-7-165	Lead Coated	165°F/74°C	\$147.00	
	▶	53-106-7-212	53-107-7-212	Lead Coated	212°F/100°C	\$147.00	
	▶	53-106-7-280	53-107-7-280	Lead Coated	280°F/138°C	\$147.00	
	▶	53-106-6-165	53-107-6-165	Wax Coated	165°F/74°C	\$140.50	
	▶	53-106-6-212	53-107-6-212	Wax Coated	212°F/100°C	\$140.50	
	▶	53-106-8-165	53-107-8-165	Wax over Lead	165°F/74°C	\$172.50	
	▶	53-106-8-212	53-107-8-212	Wax over Lead	212°F/100°C	\$172.50	
	<b>Recessed Escutcheons (Order Separately)</b>						
			56-705-2-010	1/2" Brass Plated (Style 20)			\$9.05
		56-705-9-010	1/2" Chrome Plated (Style 20)			\$6.25	
		56-705-4-010	1/2" White Color Coated (Style 20)			\$6.25	
<b>Sprinkler Wrench</b>							
		56-000-1-849	W-Type 9 Wrench			\$43.50	
		56-000-1-948	W-Type 10 Wrench (Recessed Only)			\$67.25	
<b>Technical Data Sheet: TFP110</b>							

Section 1  
Standard Spray Sprinklers

Section 2  
Extended Coverage Sprinklers

Section 3  
Storage Sprinklers

Section 4  
Residential Products

Section 5  
Dry Sprinklers

**Model TY-L, K=5.6, 1/2" NPT, Horizontal Sidewall Sprinkler**

100 Box Quantity (19 lbs/box) (SIN TY3311)

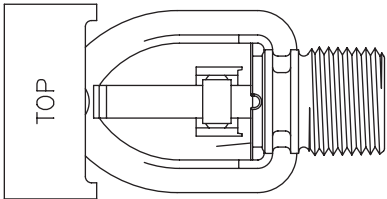
	C.O.	Horiz. Sidewall	Finish	Temperature	List Price	
		53-113-1-165	Brass	165°F/74°C	\$45.00	
	▶	53-113-1-212	Brass	212°F/100°C	\$45.00	
		53-113-1-280	Brass	280°F/138°C	\$45.00	
	▶	53-113-9-165	Chrome	165°F/74°C	\$50.00	
		53-113-9-212	Chrome	212°F/100°C	\$50.00	
		53-113-9-280	Chrome	280°F/138°C	\$50.00	
	<b>Sprinkler Wrench</b>					
			56-000-1-849	W-Type 9 Wrench		\$43.50
	<b>Technical Data Sheet: TFP120</b>					

Section 6  
Special Sprinklers

Section 7  
Nozzles and Sprinkler Accessories

See latest Technical Data Sheets for specific Approvals, Listings, Design Parameters & available finishes. Sprinkler heads & escutcheons are priced separately unless otherwise noted.

Items marked "C.O." are made to order and may require longer delivery times. Please contact customer service for availability.

**Model TY-FRL , K=2.8, 1/2" NPT, Quick Response Sprinkler**

100 Box Quantity (Upright 20 lbs/box (SIN TY1121), Pendent 18.5 lbs/box (SIN TY1221))

C.O.	Upright	Pendent	Finish	Temperature	List Price
	<b>58-973-1-165</b>	<b>58-981-1-165</b>	Brass	165°F/74°C	\$88.75
	<b>58-973-1-212</b>	<b>58-981-1-212</b>	Brass	212°F/100°C	\$88.75
	<b>58-973-9-165</b>	<b>58-981-9-165</b>	Chrome	165°F/74°C	\$95.75
	<b>58-973-9-212</b>	<b>58-981-9-212</b>	Chrome	212°F/100°C	\$95.75
<b>Recessed Escutcheons (Order Separately)</b>					
	<b>56-705-2-010</b>	1/2" Brass (Style 20)			\$9.05
	<b>56-705-9-010</b>	1/2" Chrome (Style 20)			\$6.25
	<b>56-705-4-010</b>	1/2" White (Style 20)			\$6.25
<b>Sprinkler Wrench</b>					
	<b>56-000-1-849</b>	W-Type 9 Wrench			\$43.50
	<b>56-798-1-001</b>	W-Type 12 (Recessed Only)			\$61.75

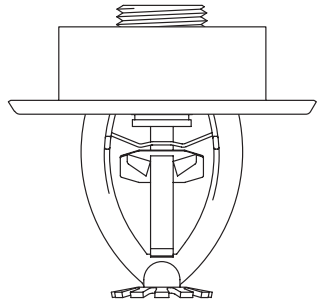
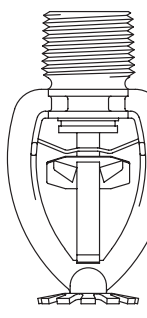
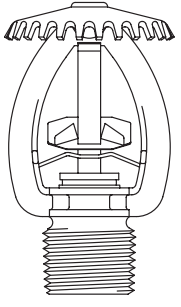

Technical Data Sheet: TFP130

Section 1  
Standard Spray Sprinklers

Section 2  
Extended Coverage Sprinklers

Section 3  
Storage Sprinklers

Section 4  
Residential Products

Section 5  
Dry Sprinklers

Section 6  
Special Sprinklers

Section 7  
Nozzles and Sprinkler Accessories

Items marked "C.O." are made to order and may require longer delivery times. Please contact customer service for availability.

See latest Technical Data Sheets for specific Approvals, Listings, Design Parameters & available finishes. Sprinkler heads & escutcheons are priced separately unless otherwise noted.

**Model TY-FRL, K=5.6, 1/2" NPT, Quick Response Sprinkler**

100 Box Quantity (Upright 20 lbs/box (SIN TY3121), Pendent 18.5 lbs/box (SIN TY3221))

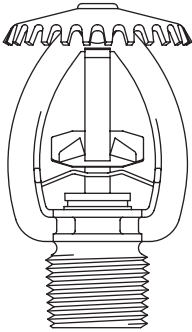
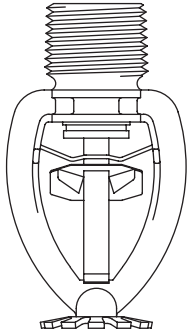
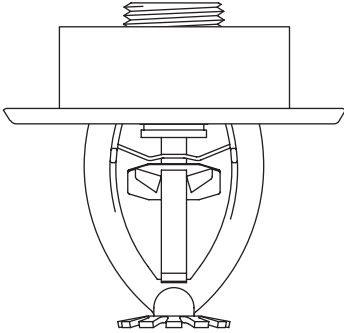
	C.O.	Upright <i>pp</i>	Pendent	Description	Temperature	List Price
		<b>58-974-1-165</b>	<b>58-982-1-165</b>	Brass	165°F/74°C	\$79.00
		<b>58-974-1-212</b>	<b>58-982-1-212</b>	Brass	212°F/100°C	\$79.00
		<b>58-974-9-165</b>	<b>58-982-9-165</b>	Chrome	165°F/74°C	\$86.25
		<b>58-974-9-212</b>	<b>58-982-9-212</b>	Chrome	212°F/100°C	\$86.25
<b>Recessed Escutcheons (Order Separately)</b>						
		<b>56-705-2-010</b>	1/2" Brass (Style 20)			\$9.05
		<b>56-705-9-010</b>	1/2" Chrome (Style 20)			\$6.25
		<b>56-705-4-010</b>	1/2" White (Style 20)			\$6.25
<b>Sprinkler Wrench</b>						
		<b>56-000-1-849</b>	W-Type 9 Wrench			\$43.50
		<b>56-798-1-001</b>	W-Type 12 (Recessed Only)			\$61.75
						
						
<b>Technical Data Sheet: TFP130</b>						

Section 1  
Standard Spray Sprinklers

Section 2  
Extended Coverage Sprinklers

Section 3  
Storage Sprinklers

Section 4  
Residential Products

Section 5  
Dry Sprinklers

Section 6  
Special Sprinklers

Section 7  
Nozzles and Sprinkler Accessories

See latest Technical Data Sheets for specific Approvals, Listings, Design Parameters & available finishes. Sprinkler heads & escutcheons are priced separately unless otherwise noted.

Items marked "C.O." are made to order and may require longer delivery times. Please contact customer service for availability.

**Model TY-FRL, K=8.0, 3/4" NPT, Quick Response Sprinkler**

100 Box Quantity (Upright 25 lbs/box (SIN TY4121), Pendent 25 lbs/box (SIN TY4221))

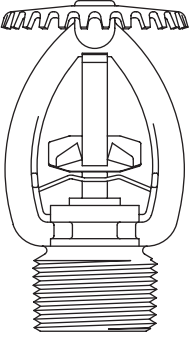
	C.O.	Upright	Pendent	Description	Temperature	List Price
		<b>58-174-1-165</b>	<b>58-172-1-165</b>	Brass	165°F/74°C	\$92.25
		<b>58-174-1-212</b>	<b>58-172-1-212</b>	Brass	212°F/100°C	\$92.25
		<b>58-174-9-165</b>	<b>58-172-9-165</b>	Chrome	165°F/74°C	\$112.00
		<b>58-174-9-212</b>	<b>58-172-9-212</b>	Chrome	212°F/100°C	\$112.00
<b>Sprinkler Wrench</b>						
		<b>56-000-1-849</b>	W-Type 9 Wrench			\$43.50
<b>Technical Data Sheet: TFP130</b>						

**Model TY-FRL, K=5.6, 1/2" NPT, Horizontal Sidewall Quick Response Sprinkler**

100 Box Quantity (20 lbs/box) (SIN TY3321)

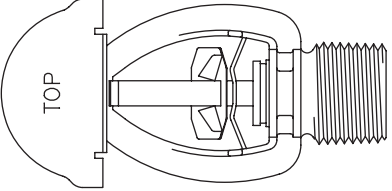
	C.O.	Horiz. Sidewall	Finish	Temperature	List Price
		<b>58-946-1-165</b>	Brass	165°F/74°C	\$101.00
	▶	<b>58-946-1-212</b>	Brass	212°F/100°C	\$101.00
		<b>58-946-9-165</b>	Chrome	165°F/74°C	\$111.50
	▶	<b>58-946-9-212</b>	Chrome	212°F/100°C	\$111.50
<b>Sprinkler Wrench</b>					
		<b>56-000-1-849</b>	W-Type 9 Wrench		\$43.50
<b>Technical Data Sheet: TFP140</b>					

Items marked "C.O." are made to order and may require longer delivery times. Please contact customer service for availability.

See latest Technical Data Sheets for specific Approvals, Listings, Design Parameters & available finishes. Sprinkler heads & escutcheons are priced separately unless otherwise noted.



**TY-B, 5mm Bulb, K=5.6, 1/2" NPT Pendent, Recessed Pendent and Upright**

100 Box Quantity (Upright 18 lbs/box (SIN TY3151), Pendent 17 lbs/box (SIN TY3251))

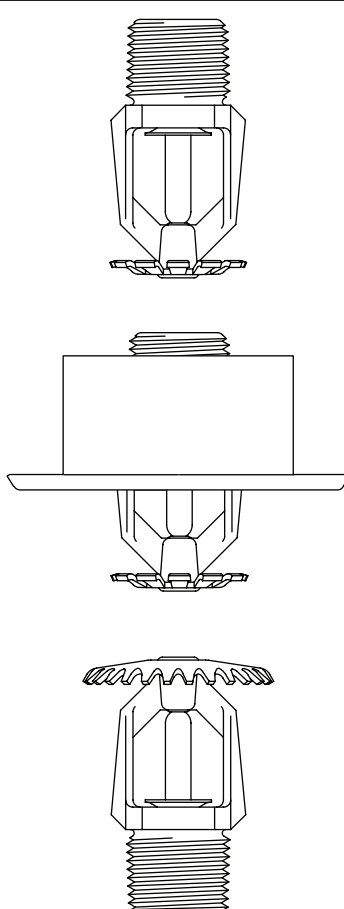
	C.O.	Upright	Pendent	Finish	Temperature	List Price
	▶	57-570-1-135	57-571-1-135	Brass	135°F/57°C	\$18.25
		57-570-1-155	57-571-1-155	Brass	155°F/68°C	\$17.25
	▶	57-570-1-175	57-571-1-175	Brass	175°F/79°C	\$18.25
		57-570-1-200	57-571-1-200	Brass	200°F/93°C	\$17.25
		57-570-1-286	57-571-1-286	Brass	286°F/141°C	\$17.25
	▶	57-570-1-360	57-571-1-360	Brass	360°F/182°C	\$21.25
	▶	57-570-9-135	57-571-9-135	Chrome	135°F/57°C	\$21.25
		57-570-9-155	57-571-9-155	Chrome	155°F/68°C	\$20.25
	▶	57-570-9-175	57-571-9-175	Chrome	175°F/79°C	\$21.25
	▶	57-570-9-200	57-571-9-200	Chrome	200°F/93°C	\$21.25
	▶	57-570-9-286	57-571-9-286	Chrome	286°F/141°C	\$21.25
	▶	57-570-9-360	57-571-9-360	Chrome	360°F/182°C	\$25.50
	▶	57-570-4-135	57-571-4-135	White	135°F/57°C	\$21.25
		57-570-4-155	57-571-4-155	White	155°F/68°C	\$20.25
	▶	57-570-4-175	57-571-4-175	White	175°F/79°C	\$21.25
		57-570-4-200	57-571-4-200	White	200°F/93°C	\$21.25
	▶	57-570-4-286	57-571-4-286	White	286°F/141°C	\$21.25
	▶	57-570-4-360	57-571-4-360	White	360°F/182°C	\$25.50
		57-570-X-155	57-571-X-155	Black	155°F/68°C	\$51.25
		57-570-X-200	57-571-X-200	Black	200°F/93°C	\$51.25
	▶	57-570-7-135	57-571-7-135	Lead Coated	135°F/57°C	\$59.00
	▶	57-570-7-155	57-571-7-155	Lead Coated	155°F/68°C	\$59.00
	▶	57-570-7-175	57-571-7-175	Lead Coated	175°F/79°C	\$59.00
	▶	57-570-7-200	57-571-7-200	Lead Coated	200°F/93°C	\$59.00
	▶	57-570-7-286	57-571-7-286	Lead Coated	286°F/141°C	\$59.00
	▶	57-570-7-360	57-571-7-360	Lead Coated	360°F/182°C	\$59.00
	▶	57-570-6-135	57-571-6-135	Wax Coated	135°F/57°C	\$54.50
	▶	57-570-6-155	57-571-6-155	Wax Coated	155°F/68°C	\$54.50
▶	57-570-6-175	57-571-6-175	Wax Coated	175°F/79°C	\$54.50	
▶	57-570-6-200	57-571-6-200	Wax Coated	200°F/93°C	\$54.50	
▶	57-570-6-286	57-571-6-286	Wax Coated	286°F/141°C	\$54.50	
▶	57-570-8-135	57-571-8-135	Wax over Lead Coated	135°F/57°C	\$78.25	
▶	57-570-8-155	57-571-8-155	Wax over Lead Coated	155°F/68°C	\$78.25	
▶	57-570-8-175	57-571-8-175	Wax over Lead Coated	175°F/79°C	\$78.25	
▶	57-570-8-200	57-571-8-200	Wax over Lead Coated	200°F/93°C	\$78.25	
▶	57-570-8-286	57-571-8-286	Wax over Lead Coated	286°F/141°C	\$78.25	
<b>Recessed Escutcheons (Order Separately)</b>						
	56-701-2-010	1/2" Brass Plated (Style 10)				\$9.05
	56-701-9-010	1/2" Chrome Plated (Style 10)				\$6.25
	56-701-4-010	1/2" White Color Coated (Style 10)				\$6.25
	56-701-6-010	1/2" Black Color Coated (Style 10)				\$8.15
<b>Sprinkler Wrench</b>						
	56-000-6-387	W-Type 6 Wrench				\$48.75
	56-850-4-001	W-Type 7 Wrench (Recessed Only)				\$81.00
<b>Technical Data Sheet: TFP151</b>						

Section 1  
Standard Spray Sprinklers

Section 2  
Extended Coverage Sprinklers

Section 3  
Storage Sprinklers

Section 4  
Residential Products

Section 5  
Dry Sprinklers

Section 6  
Special Sprinklers

Section 7  
Nozzles and Sprinkler Accessories

See latest Technical Data Sheets for specific Approvals, Listings, Design Parameters & available finishes. Sprinkler heads & escutcheons are priced separately unless otherwise noted.

Items marked "C.O." are made to order and may require longer delivery times. Please contact customer service for availability.

**TY-B, 5mm Bulb, K=8.0, 1/2" NPT, Pendent and Upright Sprinklers,**

100 Box Quantity (Upright 21 lbs/box (SIN TY4851), Pendent 21 lbs/box (SIN TY4951))

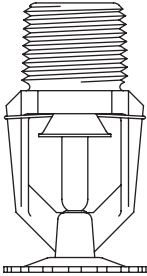
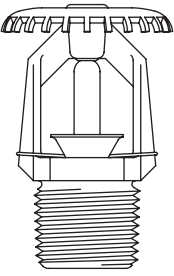
	<i>C.O.</i>	<i>Upright</i>	<i>Pendent</i>	<i>Finish</i>	<i>Temperature</i>	<i>List Price</i>	
	▶	57-560-1-135	57-561-1-135	Brass	135°F/57°C	\$25.00	
		57-560-1-155	57-561-1-155	Brass	155°F/68°C	\$25.00	
	▶	57-560-1-175	57-561-1-175	Brass	175°F/79°C	\$25.00	
		57-560-1-200	57-561-1-200	Brass	200°F/93°C	\$25.00	
		57-560-1-286	57-561-1-286	Brass	286°F/141°C	\$25.00	
	▶	57-560-1-360	57-561-1-360	Brass	360°F/182°C	\$27.50	
	▶	57-560-9-135	57-561-9-135	Chrome	135°F/57°C	\$27.50	
		57-560-9-155	57-561-9-155	Chrome	155°F/68°C	\$27.50	
	▶	57-560-9-175	57-561-9-175	Chrome	175°F/79°C	\$27.50	
	▶	57-560-9-200	57-561-9-200	Chrome	200°F/93°C	\$27.50	
	▶	57-560-9-286	57-561-9-286	Chrome	286°F/141°C	\$27.50	
	▶	57-560-9-360	57-561-9-360	Chrome	360°F/182°C	\$30.75	
	▶	57-560-4-135	57-561-4-135	White	135°F/57°C	\$27.50	
		57-560-4-155	57-561-4-155	White	155°F/68°C	\$27.50	
	▶	57-560-4-175	57-561-4-175	White	175°F/79°C	\$27.50	
	▶	57-560-4-200	57-561-4-200	White	200°F/93°C	\$27.50	
	▶	57-560-4-286	57-561-4-286	White	286°F/141°C	\$27.50	
	▶	57-560-4-360	57-561-4-360	White	360°F/182°C	\$30.75	
	<b>Sprinkler Wrench</b>						
		56-000-6-387	W-Type 6 Wrench				\$48.75

**Technical Data Sheet: TFP151**

Items marked "C.O." are made to order and may require longer delivery times. Please contact customer service for availability.

See latest Technical Data Sheets for specific Approvals, Listings, Design Parameters & available finishes. Sprinkler heads & escutcheons are priced separately unless otherwise noted.

Section 1  
Standard Spray Sprinklers

Section 2  
Extended Coverage Sprinklers

Section 3  
Storage Sprinklers

Section 4  
Residential Products

Section 5  
Dry Sprinklers

Section 6  
Special Sprinklers

Section 7  
Nozzles and Sprinkler Accessories

**TY-B, 5mm Bulb, K=8.0, 3/4" NPT, Pendent, Recessed Pendent and Upright Sprinklers**

100 Box Quantity (Upright 21 lbs/box (SIN TY4151), Pendent 21 lbs/box (SIN TY4251))

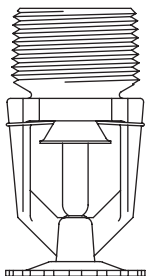
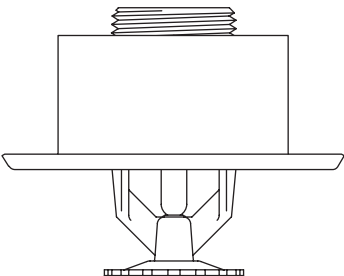
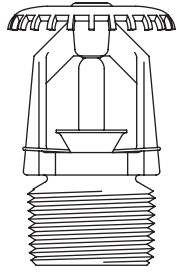
	C.O.	Upright	Pendent	Finish	Temperature	List Price	
	▶	57-590-1-135	57-591-1-135	Brass	135°F/57°C	\$21.00	
		57-590-1-155	57-591-1-155	Brass	155°F/68°C	\$20.00	
	▶	57-590-1-175	57-591-1-175	Brass	175°F/79°C	\$21.00	
		57-590-1-200	57-591-1-200	Brass	200°F/93°C	\$20.00	
		57-590-1-286	57-591-1-286	Brass	286°F/141°C	\$20.00	
	▶	57-590-1-360	57-591-1-360	Brass	360°F/182°C	\$24.25	
	▶	57-590-9-135	57-591-9-135	Chrome	135°F/57°C	\$24.25	
		57-590-9-155	57-591-9-155	Chrome	155°F/68°C	\$24.25	
	▶	57-590-9-175	57-591-9-175	Chrome	175°F/79°C	\$24.25	
	▶	57-590-9-200	57-591-9-200	Chrome	200°F/93°C	\$24.25	
	▶	57-590-9-286	57-591-9-286	Chrome	286°F/141°C	\$24.25	
	▶	57-590-9-360	57-591-9-360	Chrome	360°F/182°C	\$27.25	
	▶	57-590-4-135	57-591-4-135	White	135°F/57°C	\$24.25	
		57-590-4-155	57-591-4-155	White	155°F/68°C	\$24.25	
	▶	57-590-4-175	57-591-4-175	White	175°F/79°C	\$24.25	
	▶	57-590-4-200	57-591-4-200	White	200°F/93°C	\$24.25	
	▶	57-590-4-286	57-591-4-286	White	286°F/141°C	\$24.25	
	▶	57-590-4-360	57-591-4-360	White	360°F/182°C	\$27.25	
	▶	57-590-7-135	57-591-7-135	Lead Coated	135°F/57°C	\$63.75	
	▶	57-590-7-155	57-591-7-155	Lead Coated	155°F/68°C	\$63.75	
	▶	57-590-7-175	57-591-7-175	Lead Coated	175°F/79°C	\$63.75	
	▶	57-590-7-200	57-591-7-200	Lead Coated	200°F/93°C	\$63.75	
	▶	57-590-7-286	57-591-7-286	Lead Coated	286°F/141°C	\$63.75	
	▶	57-590-7-360	57-591-7-360	Lead Coated	360°F/182°C	\$63.75	
	▶	57-590-6-135	57-591-6-135	Wax Coated	135°F/57°C	\$59.50	
	▶	57-590-6-155	57-591-6-155	Wax Coated	155°F/68°C	\$59.50	
	▶	57-590-6-175	57-591-6-175	Wax Coated	175°F/79°C	\$59.50	
	▶	57-590-6-200	57-591-6-200	Wax Coated	200°F/93°C	\$59.50	
	▶	57-590-6-286	57-591-6-286	Wax Coated	286°F/141°C	\$59.50	
	▶	57-590-8-135	57-591-8-135	Wax over Lead Coated	135°F/57°C	\$83.00	
	▶	57-590-8-155	57-591-8-155	Wax over Lead Coated	155°F/68°C	\$83.00	
	▶	57-590-8-175	57-591-8-175	Wax over Lead Coated	175°F/79°C	\$83.00	
	▶	57-590-8-200	57-591-8-200	Wax over Lead Coated	200°F/93°C	\$83.00	
	▶	57-590-8-286	57-591-8-286	Wax over Lead Coated	286°F/141°C	\$83.00	
	<b>Recessed Escutcheons (Order Separately)</b>						
			56-700-2-010	3/4" Brass Recessed (Style 40)			\$9.05
		56-700-9-010	3/4" Chrome Recessed (Style 40)			\$6.50	
		56-700-4-010	3/4" White Recessed (Style 40)			\$6.50	
<b>Sprinkler Wrench</b>							
		56-000-6-387	W-Type 6 Wrench			\$48.75	
		56-850-4-001	W-Type 7 Wrench (Recessed Only)			\$81.00	
<b>Technical Data Sheet: TFP151</b>							

Section 1  
Standard Spray Sprinklers

Section 2  
Extended Coverage Sprinklers

Section 3  
Storage Sprinklers

Section 4  
Residential Products

Section 5  
Dry Sprinklers

Section 6  
Special Sprinklers



Section 7  
Nozzles and Sprinkler Accessories

See latest Technical Data Sheets for specific Approvals, Listings, Design Parameters & available finishes. Sprinkler heads & escutcheons are priced separately unless otherwise noted.

Items marked "C.O." are made to order and may require longer delivery times. Please contact customer service for availability.

**TY-B, 5mm Bulb, K=5.6, 1/2" NPT, Horizontal,  
Recessed Horizontal, and Vertical Sidewall Sprinklers**

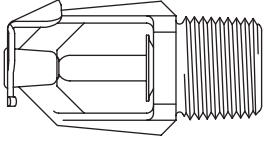
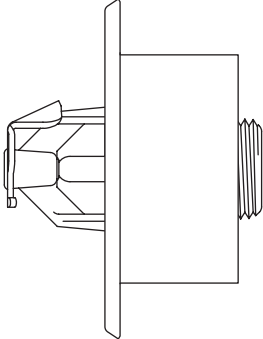
100 Box Quantity (HSW 18 lbs/box (SIN TY3351), VSW 18 lbs/box (SIN TY3451))

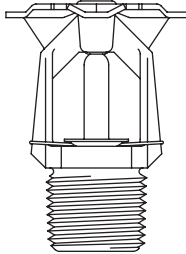
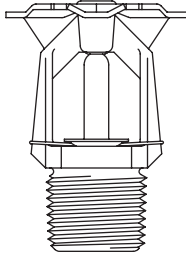
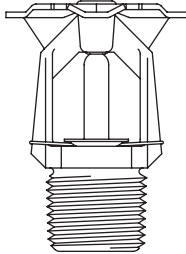
	C.O.	Horiz. Sidewall	Vertical	Finish	Temperature	List Price	
	▶	57-578-1-135	57-575-1-135	Brass	135°F/57°C	\$33.25	
		57-578-1-155	57-575-1-155	Brass	155°F/68°C	\$33.25	
	▶	57-578-1-175	57-575-1-175	Brass	175°F/79°C	\$33.25	
		57-578-1-200	57-575-1-200	Brass	200°F/93°C	\$33.25	
		57-578-1-286	57-575-1-286	Brass	286°F/141°C	\$33.25	
	▶	57-578-1-360	57-575-1-360	Brass	360°F/182°C	\$38.00	
	▶	57-578-9-135	57-575-9-135	Chrome	135°F/57°C	\$35.50	
		57-578-9-155	57-575-9-155	Chrome	155°F/68°C	\$35.50	
	▶	57-578-9-175	57-575-9-175	Chrome	175°F/79°C	\$35.50	
		57-578-9-200	57-575-9-200	Chrome	200°F/93°C	\$35.50	
	▶	57-578-9-286	57-575-9-286	Chrome	286°F/141°C	\$35.50	
	▶	57-578-9-360	57-575-9-360	Chrome	360°F/182°C	\$42.75	
	▶	57-578-4-135	57-575-4-135	White	135°F/57°C	\$35.50	
		57-578-4-155	57-575-4-155	White	155°F/68°C	\$35.50	
	▶	57-578-4-175	57-575-4-175	White	175°F/79°C	\$35.50	
	▶	57-578-4-200	57-575-4-200	White	200°F/93°C	\$35.50	
	▶	57-578-4-286	57-575-4-286	White	286°F/141°C	\$35.50	
	▶	57-578-4-360	57-575-4-360	White	360°F/182°C	\$42.75	
	▶	57-578-7-135	57-575-7-135	Lead Coated	135°F/57°C	\$71.50	
	▶	57-578-7-155	57-575-7-155	Lead Coated	155°F/68°C	\$71.50	
	▶	57-578-7-175	57-575-7-175	Lead Coated	175°F/79°C	\$71.50	
	▶	57-578-7-200	57-575-7-200	Lead Coated	200°F/93°C	\$71.50	
	▶	57-578-7-286	57-575-7-286	Lead Coated	286°F/141°C	\$71.50	
	▶	57-578-7-360	57-575-7-360	Lead Coated	360°F/182°C	\$71.50	
	▶	57-578-6-135	57-575-6-135	Wax Coated	135°F/57°C	\$68.00	
	▶	57-578-6-155	57-575-6-155	Wax Coated	155°F/68°C	\$68.00	
	▶	57-578-6-175	57-575-6-175	Wax Coated	175°F/79°C	\$68.00	
	▶	57-578-6-200	57-575-6-200	Wax Coated	200°F/93°C	\$68.00	
	▶	57-578-6-286	57-575-6-286	Wax Coated	286°F/141°C	\$68.00	
	▶	57-578-8-135	57-575-8-135	Wax over Lead Coated	135°F/57°C	\$91.25	
	▶	57-578-8-155	57-575-8-155	Wax over Lead Coated	155°F/68°C	\$91.25	
	▶	57-578-8-175	57-575-8-175	Wax over Lead Coated	175°F/79°C	\$91.25	
	▶	57-578-8-200	57-575-8-200	Wax over Lead Coated	200°F/93°C	\$91.25	
	▶	57-578-8-286	57-575-8-286	Wax over Lead Coated	286°F/141°C	\$91.25	
	<b>Recessed Escutcheons (Order Separately)</b>						
		56-701-2-010	1/2" Brass Plated (Style 10)				\$9.05
	56-701-9-010	1/2" Chrome Plated (Style 10)				\$6.25	
	56-701-4-010	1/2" White Color Coated (Style 10)				\$6.25	
<b>Sprinkler Wrench</b>							
	56-000-6-387	W-Type 6 Wrench				\$48.75	
	56-850-4-001	W-Type 7 Wrench (Recessed Only)				\$81.00	
<b>Technical Data Sheet: TFP161</b>							

Items marked "C.O." are made to order and may require longer delivery times. Please contact customer service for availability.

See latest Technical Data Sheets for specific Approvals, Listings, Design Parameters & available finishes. Sprinkler heads & escutcheons are priced separately unless otherwise noted.

**TY-FRB, 3mm Bulb, Quick Response, K=2.8,  
1/2" NPT, Pendent, Recessed Pendent and Upright Sprinklers**

100 Box Quantity (Upright 18 lbs/box (SIN TY1131), Pendent 17 lbs/box (SIN TY1231))

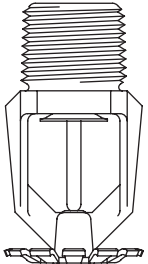
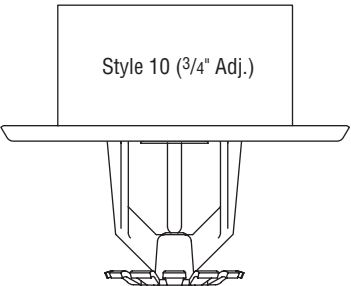
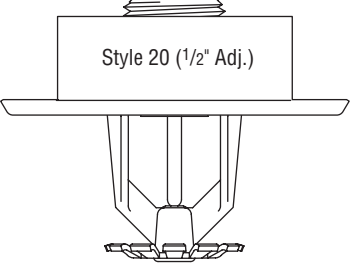
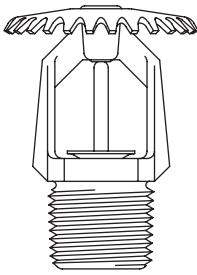
	C.O.	Upright	Pendent	Finish	Temperature	List Price
	▶	57-330-1-135	57-331-1-135	Brass	135°F/57°C	\$37.00
		57-330-1-155	57-331-1-155	Brass	155°F/68°C	\$37.00
	▶	57-330-1-175	57-331-1-175	Brass	175°F/79°C	\$37.00
		57-330-1-200	57-331-1-200	Brass	200°F/93°C	\$37.00
	▶	57-330-1-286	57-331-1-286	Brass	286°F/141°C	\$37.00
	▶	57-330-9-135	57-331-9-135	Chrome	135°F/57°C	\$40.25
		57-330-9-155	57-331-9-155	Chrome	155°F/68°C	\$40.25
	▶	57-330-9-175	57-331-9-175	Chrome	175°F/79°C	\$40.25
	▶	57-330-9-200	57-331-9-200	Chrome	200°F/93°C	\$40.25
	▶	57-330-9-286	57-331-9-286	Chrome	286°F/141°C	\$40.25
	▶	57-330-4-135	57-331-4-135	White	135°F/57°C	\$40.25
		57-330-4-155	57-331-4-155	White	155°F/68°C	\$40.25
	▶	57-330-4-175	57-331-4-175	White	175°F/79°C	\$40.25
	▶	57-330-4-200	57-331-4-200	White	200°F/93°C	\$40.25
	▶	57-330-4-286	57-331-4-286	White	286°F/141°C	\$40.25
	<b>Recessed Escutcheons (Order Separately)</b>					
	56-701-2-010	1/2" Brass Plated (Style 10)				\$9.05
	56-701-9-010	1/2" Chrome Plated (Style 10)				\$6.25
	56-701-4-010	1/2" White Color Coated (Style 10)				\$6.25
	56-705-2-010	1/2" Brass Plated (Style 20)				\$9.05
	56-705-9-010	1/2" Chrome Plated (Style 20)				\$6.25
	56-705-4-010	1/2" White Color Coated (Style 20)				\$6.25
<b>Sprinkler Wrench</b>						
	56-000-6-387	W-Type 6 Wrench				\$48.75
	56-850-4-001	W-Type 7 Wrench (Recessed Only)				\$81.00
	<b>Technical Data Sheet: TFP 171</b>					

Section 1  
Standard Spray Sprinklers

Section 2  
Extended Coverage Sprinklers

Section 3  
Storage Sprinklers

Section 4  
Residential Products

Section 5  
Dry Sprinklers

Section 6  
Special Sprinklers

Section 7  
Nozzles and Sprinkler Accessories

See latest Technical Data Sheets for specific Approvals, Listings, Design Parameters & available finishes. Sprinkler heads & escutcheons are priced separately unless otherwise noted.

Items marked "C.O." are made to order and may require longer delivery times. Please contact customer service for availability.

**TY-FRB, 3mm Bulb, Quick Response, K=4.2,  
1/2" NPT, Pendent, Recessed Pendent and Upright Sprinklers**

100 Box Quantity (Upright 18 lbs/box (SIN TY2131), Pendent 17 lbs/box (SIN TY2231))

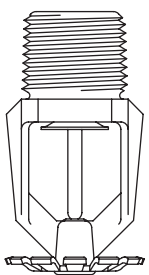
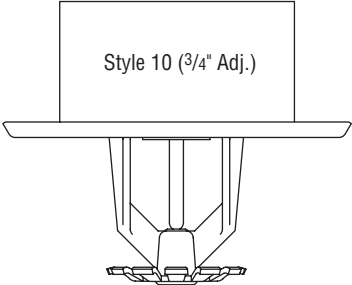
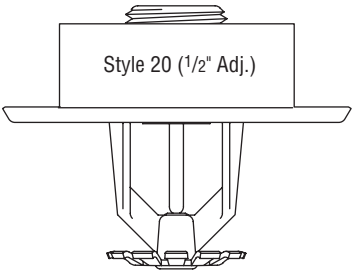
	C.O.	Upright	Pendent	Finish	Temperature	List Price
	▶	57-340-1-135	57-341-1-135	Brass	135°F/57°C	\$37.00
		57-340-1-155	57-341-1-155	Brass	155°F/68°C	\$37.00
	▶	57-340-1-175	57-341-1-175	Brass	175°F/79°C	\$37.00
		57-340-1-200	57-341-1-200	Brass	200°F/93°C	\$37.00
	▶	57-340-1-286	57-341-1-286	Brass	286°F/141°C	\$37.00
	▶	57-340-9-135	57-341-9-135	Chrome	135°F/57°C	\$40.25
		57-340-9-155	57-341-9-155	Chrome	155°F/68°C	\$40.25
	▶	57-340-9-175	57-341-9-175	Chrome	175°F/79°C	\$40.25
	▶	57-340-9-200	57-341-9-200	Chrome	200°F/93°C	\$40.25
	▶	57-340-9-286	57-341-9-286	Chrome	286°F/141°C	\$40.25
	▶	57-340-4-135	57-341-4-135	White	135°F/57°C	\$40.25
		57-340-4-155	57-341-4-155	White	155°F/68°C	\$40.25
	▶	57-340-4-175	57-341-4-175	White	175°F/79°C	\$40.25
	▶	57-340-4-200	57-341-4-200	White	200°F/93°C	\$40.25
	▶	57-340-4-286	57-341-4-286	White	286°F/141°C	\$40.25
<b>Recessed Escutcheons (Order Separately)</b>						
	56-701-2-010	1/2" Brass Plated (Style 10)				\$9.05
	56-701-9-010	1/2" Chrome Plated (Style 10)				\$6.25
	56-701-4-010	1/2" White Color Coated (Style 10)				\$6.25
	56-705-2-010	1/2" Brass Plated (Style 20)				\$9.05
	56-705-9-010	1/2" Chrome Plated (Style 20)				\$6.25
	56-705-4-010	1/2" White Color Coated (Style 20)				\$6.25
<b>Sprinkler Wrench</b>						
	56-000-6-387	W-Type 6 Wrench				\$48.75
	56-850-4-001	W-Type 7 Wrench (Recessed Only)				\$81.00
<b>Technical Data Sheet: TFP171</b>						

Items marked "C.O." are made to order and may require longer delivery times. Please contact customer service for availability.

See latest Technical Data Sheets for specific Approvals, Listings, Design Parameters & available finishes. Sprinkler heads & escutcheons are priced separately unless otherwise noted.



**TY-FRB, 3mm Bulb, Quick Response, K=5.6, 1/2" NPT, Pendent,  
Recessed Pendent and Upright Sprinkler**

100 Box Quantity (Upright 18 lbs/box (SIN TY3131), Pendent 17 lbs/box (SIN TY3231))

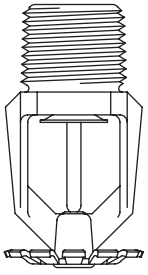
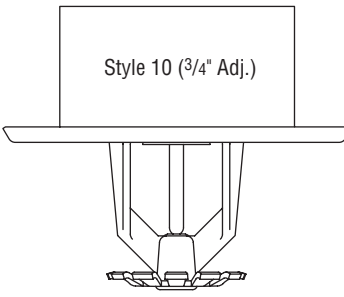
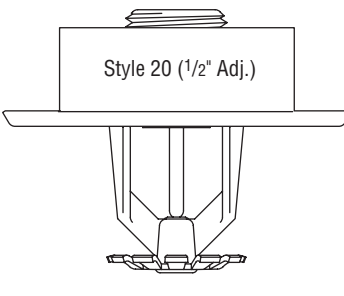
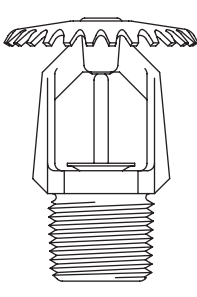
	C.O.	Upright	Pendent	Finish	Temperature	List Price	
	▶	57-370-1-135	57-371-1-135	Brass	135°F/57°C	\$30.75	
		57-370-1-155	57-371-1-155	Brass	155°F/68°C	\$28.75	
	▶	57-370-1-175	57-371-1-175	Brass	175°F/79°C	\$30.75	
		57-370-1-200	57-371-1-200	Brass	200°F/93°C	\$28.75	
		57-370-1-286	57-371-1-286	Brass	286°F/141°C	\$28.75	
	▶	57-370-9-135	57-371-9-135	Chrome	135°F/57°C	\$33.50	
		57-370-9-155	57-371-9-155	Chrome	155°F/68°C	\$31.25	
	▶	57-370-9-175	57-371-9-175	Chrome	175°F/79°C	\$33.50	
	▶	57-370-9-200	57-371-9-200	Chrome	200°F/93°C	\$33.50	
	▶	57-370-9-286	57-371-9-286	Chrome	286°F/141°C	\$33.50	
	▶	57-370-4-135	57-371-4-135	White	135°F/57°C	\$31.25	
		57-370-4-155	57-371-4-155	White	155°F/68°C	\$31.25	
	▶	57-370-4-175	57-371-4-175	White	175°F/79°C	\$31.25	
	▶	57-370-4-200	57-371-4-200	White	200°F/93°C	\$31.25	
	▶	57-370-4-286	57-371-4-286	White	286°F/141°C	\$31.25	
		57-370-X-155	57-371-X-155	Black	155°F/68°C	\$87.75	
		57-370-X-200	57-371-X-200	Black	200°F/93°C	\$87.75	
		▶	57-370-7-135	57-371-7-135	Lead Coated	135°F/57°C	\$93.25
		▶	57-370-7-155	57-371-7-155	Lead Coated	155°F/68°C	\$93.25
		▶	57-370-7-175	57-371-7-175	Lead Coated	175°F/79°C	\$93.25
	▶	57-370-7-200	57-371-7-200	Lead Coated	200°F/93°C	\$93.25	
	▶	57-370-7-286	57-371-7-286	Lead Coated	286°F/141°C	\$93.25	
 Style 10 (3/4" Adj.)	<b>Recessed Escutcheons (Order Separately)</b>						
		56-701-2-010	1/2" Brass Plated (Style 10)			\$9.05	
		56-701-9-010	1/2" Chrome Plated (Style 10)			\$6.25	
		56-701-4-010	1/2" White Color Coated (Style 10)			\$6.25	
		56-701-6-010	1/2" Black Color Coated (Style 10)			\$8.15	
		56-705-2-010	1/2" Brass Plated (Style 20)			\$9.05	
		56-705-9-010	1/2" Chrome Plated (Style 20)			\$6.25	
		56-705-4-010	1/2" White Color Coated (Style 20)			\$6.25	
		56-705-6-010	1/2" Black Color Coated (Style 20)			\$8.15	
	 Style 20 (1/2" Adj.)	<b>Sprinkler Wrench</b>					
		56-000-6-387	W-Type 6 Wrench			\$48.75	
		56-850-4-001	W-Type 7 Wrench (Recessed Only)			\$81.00	
	<b>Technical Data Sheet: TFP171</b>						

Section 1  
Standard Spray Sprinklers

Section 2  
Extended Coverage Sprinklers

Section 3  
Storage Sprinklers

Section 4  
Residential Products

Section 5  
Dry Sprinklers

Section 6  
Special Sprinklers

Section 7  
Nozzles and Sprinkler Accessories

See latest Technical Data Sheets for specific Approvals, Listings, Design Parameters & available finishes. Sprinkler heads & escutcheons are priced separately unless otherwise noted.

Items marked "C.O." are made to order and may require longer delivery times. Please contact customer service for availability.



**TY-FRB, 3mm Bulb, Quick Response, K=8.0, 3/4" NPT, Pendent,  
Recessed Pendent and Upright Sprinkler**

100 Box Quantity (Upright 18 lbs/box (SIN TY4131), Pendent 17 lbs/box (SIN TY4231))

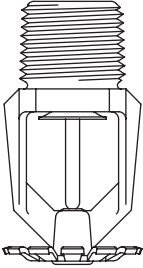
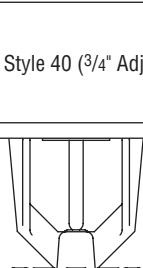
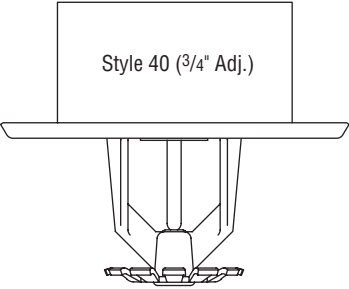
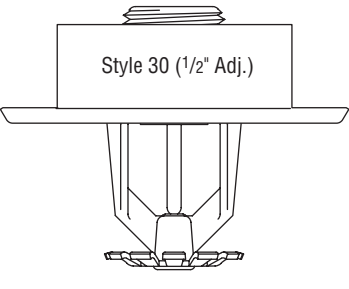
	C.O.	Upright	Pendent	Finish	Temperature	List Price
	▶	57-390-1-135	57-391-1-135	Brass	135°F/57°C	\$40.75
		57-390-1-155	57-391-1-155	Brass	155°F/68°C	\$40.75
	▶	57-390-1-175	57-391-1-175	Brass	175°F/79°C	\$40.75
	▶	57-390-1-200	57-391-1-200	Brass	200°F/93°C	\$40.75
		57-390-1-286	57-391-1-286	Brass	286°F/141°C	\$40.75
	▶	57-390-9-135	57-391-9-135	Chrome	135°F/57°C	\$43.25
		57-390-9-155	57-391-9-155	Chrome	155°F/68°C	\$43.25
	▶	57-390-9-175	57-391-9-175	Chrome	175°F/79°C	\$43.25
		57-390-9-200	57-391-9-200	Chrome	200°F/93°C	\$43.25
	▶	57-390-9-286	57-391-9-286	Chrome	286°F/141°C	\$43.25
	▶	57-390-4-135	57-391-4-135	White	135°F/57°C	\$43.25
		57-390-4-155	57-391-4-155	White	155°F/68°C	\$43.25
	▶	57-390-4-175	57-391-4-175	White	175°F/79°C	\$43.25
		57-390-4-200	57-391-4-200	White	200°F/93°C	\$43.25
	▶	57-390-4-286	57-391-4-286	White	286°F/141°C	\$43.25
	▶	57-390-7-135	57-391-7-135	Lead Coated	135°F/57°C	\$105.00
		57-390-7-155	57-391-7-155	Lead Coated	155°F/68°C	\$105.00
	▶	57-390-7-175	57-391-7-175	Lead Coated	175°F/79°C	\$105.00
	▶	57-390-7-200	57-391-7-200	Lead Coated	200°F/93°C	\$105.00
	▶	57-390-7-286	57-391-7-286	Lead Coated	286°F/141°C	\$105.00
<b>Recessed Escutcheons (Order Separately)</b>						
		56-705-2-011	3/4" Brass Recessed (Style 30)			\$9.05
		56-705-9-011	3/4" Chrome Recessed (Style 30)			\$6.50
		56-705-4-011	3/4" White Recessed (Style 30)			\$6.50
		56-700-2-010	3/4" Brass Plated (Style 40)			\$9.05
		56-700-9-010	3/4" Chrome Plated (Style 40)			\$6.50
		56-700-4-010	3/4" White Recessed (Style 40)			\$6.50
<b>Sprinkler Wrench</b>						
		56-000-6-387	W-Type 6 Wrench			\$48.75
		56-850-4-001	W-Type 7 Wrench (Recessed Only)			\$81.00
<b>Technical Data Sheet: TFP171</b>						

Items marked "C.O." are made to order and may require longer delivery times. Please contact customer service for availability.

See latest Technical Data Sheets for specific Approvals, Listings, Design Parameters & available finishes. Sprinkler heads & escutcheons are priced separately unless otherwise noted.

**TY-FRB, 3mm Bulb, Quick Response, K=5.6, 1/2" NPT  
Horizontal Sidewall Sprinkler, Recessed Horizontal Sidewall and Vertical Sidewall**

100 Box Quantity (18 lbs/box) (Horizontal Sidewall SIN TY3331) (Vertical Sidewall SIN TY3431)

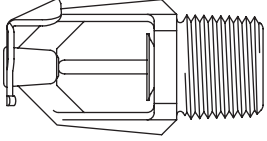
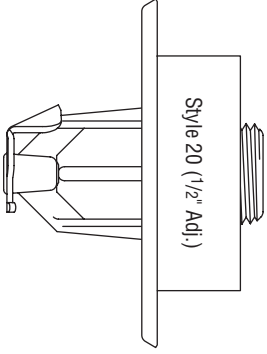
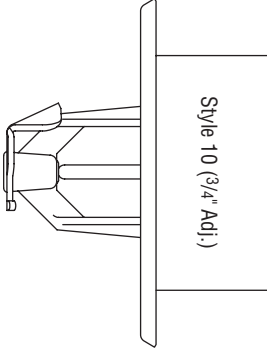
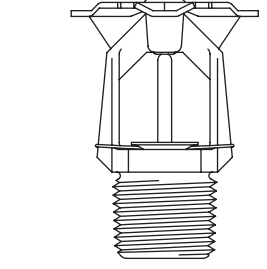
	C.O.	Horiz. Sidewall	Vertical Sidewall	Finish	Temperature	List Price
	▶	57-378-1-135	57-375-1-135	Brass	135°F/57°C	\$55.75
		57-378-1-155	57-375-1-155	Brass	155°F/68°C	\$55.75
	▶	57-378-1-175	57-375-1-175	Brass	175°F/79°C	\$55.75
		57-378-1-200	57-375-1-200	Brass	200°F/93°C	\$55.75
	▶	57-378-1-286	57-375-1-286	Brass	286°F/141°C	\$55.75
	▶	57-378-9-135	57-375-9-135	Chrome	135°F/57°C	\$60.00
		57-378-9-155	57-375-9-155	Chrome	155°F/68°C	\$60.00
	▶	57-378-9-175	57-375-9-175	Chrome	175°F/79°C	\$60.00
		57-378-9-200	57-375-9-200	Chrome	200°F/93°C	\$60.00
	▶	57-378-9-286	57-375-9-286	Chrome	286°F/141°C	\$60.00
	▶	57-378-4-135	57-375-4-135	White	135°F/57°C	\$60.00
		57-378-4-155	57-375-4-155	White	155°F/68°C	\$60.00
	▶	57-378-4-175	57-375-4-175	White	175°F/79°C	\$60.00
	▶	57-378-4-200	57-375-4-200	White	200°F/93°C	\$60.00
	▶	57-378-4-286	57-375-4-286	White	286°F/141°C	\$60.00
	▶	57-378-7-135	57-375-7-135	Lead Coated	135°F/57°C	\$105.00
	▶	57-378-7-155	57-375-7-155	Lead Coated	155°F/68°C	\$105.00
	▶	57-378-7-175	57-375-7-175	Lead Coated	175°F/79°C	\$105.00
	▶	57-378-7-200	57-375-7-200	Lead Coated	200°F/93°C	\$105.00
	▶	57-378-7-286	57-375-7-286	Lead Coated	286°F/141°C	\$105.00
<b>Recessed Escutcheons (Order Separately)</b>						
		56-701-2-010	1/2" Brass (Style 10)			\$9.05
		56-701-9-010	1/2" Chrome (Style 10)			\$6.25
		56-701-4-010	1/2" White (Style 10)			\$6.25
		56-705-2-010	1/2" Brass (Style 20)			\$9.05
		56-705-9-010	1/2" Chrome (Style 20)			\$6.25
		56-705-4-010	1/2" White (Style 20)			\$6.25
<b>Sprinkler Wrench</b>						
		56-000-6-387	W-Type 6 Wrench			\$48.75
		56-850-4-001	W-Type 7 Wrench (Recessed Only)			\$81.00
<b>Technical Data Sheet: TFP176</b>						

Section 1  
Standard Spray Sprinklers

Section 2  
Extended Coverage Sprinklers

Section 3  
Storage Sprinklers

Section 4  
Residential Products

Section 5  
Dry Sprinklers

Section 6  
Special Sprinklers

Section 7  
Nozzles and Sprinkler Accessories

See latest Technical Data Sheets for specific Approvals, Listings, Design Parameters & available finishes. Sprinkler heads & escutcheons are priced separately unless otherwise noted.

Items marked "C.O." are made to order and may require longer delivery times. Please contact customer service for availability.

**Series RFI, 5.6 K-factor, Standard Response, "Royal Flush II" Pendent Concealed Sprinklers**

80 Box Quantity (29 lbs/box) SIN TY3551 - 250 psi

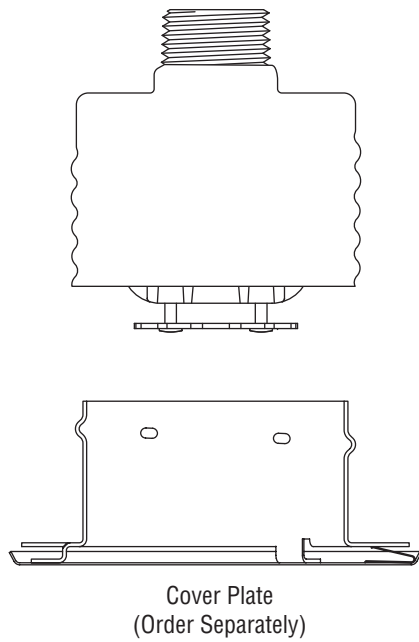

**Note:**  
All "Special Order" cover plates are special ordered and are Non-Returnable. Please see "Terms & Conditions"

C.O.	Pendent	Finish	Temperature	List Price
<b>High Pressure (250 psi)</b>				
▶	51-790-1-155	Brass	155°F/68°C	\$41.25
▶	51-790-1-200	Brass	200°F/93°C	\$41.25
<b>Cover Plate (For use with 155° F Sprinkler)</b>				
80 Box Quantity (14.5 lbs/box)				
	56-792-1-135	Brass	135°F/57°C	\$21.25
	56-792-9-135	Chrome	135°F/57°C	\$21.25
	56-792-0-135	Grey White	135°F/57°C	\$21.25
	56-792-4-135	Signal (Bright) White	135°F/57°C	\$21.25
▶	56-792-X-135	Special Order*	135°F/57°C	\$22.75
<b>Cover Plate (For use with 200° F Sprinkler)</b>				
80 Box Quantity (14.5 lbs/box)				
	56-792-1-165	Brass	165°F/74°C	\$21.25
	56-792-9-165	Chrome	165°F/74°C	\$21.25
	56-792-0-165	Grey White	165°F/74°C	\$21.25
	56-792-4-165	Signal (Bright) White	165°F/74°C	\$21.25
▶	56-792-X-165	Special Order*	165°F/74°C	\$22.75
<b>Notes</b>				
	6012	*Special Order paint match subject to set-up charge. (Net Price)		\$376.50
<b>Sprinkler Wrench</b>				
	56-000-1-075	RFI Wrench		\$81.00
<b>Air and Dust Seal</b>				
	56-908-1-001	Air and Dust Seal		\$12.00
<b>Technical Data Sheet: TFP181</b>				

Items marked "C.O." are made to order and may require longer delivery times. Please contact customer service for availability.

See latest Technical Data Sheets for specific Approvals, Listings, Design Parameters & available finishes. Sprinkler heads & escutcheons are priced separately unless otherwise noted.

**Series RFI, 5.6 K-factor, Quick Response,  
"Royal Flush II" Pendent Concealed Sprinklers**

80 Box Quantity (29 lbs/box) SIN TY3531 - 250 psi

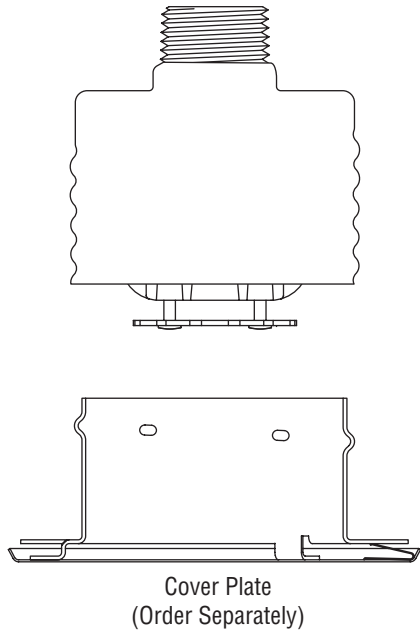

**Note:**  
All "Special Order" cover plates are special ordered and are Non-Returnable. Please see "Terms & Conditions"

C.O.	Pendent	Finish	Temperature	List Price
<b>High Pressure (250 psi)</b>				
▶	<b>51-792-1-155</b>	Brass	155°F/68°C	\$39.50
▶	<b>51-792-1-200</b>	Brass	200°F/93°C	\$39.50
<b>Cover Plate (For use with 155° F Sprinkler)</b>				
80 Box Quantity (14.5 lbs/box)				
	<b>56-792-1-135</b>	Brass	135°F/57°C	\$21.25
	<b>56-792-9-135</b>	Chrome	135°F/57°C	\$21.25
	<b>56-792-0-135</b>	Grey White	135°F/57°C	\$21.25
	<b>56-792-4-135</b>	Signal (Bright) White	135°F/57°C	\$21.25
▶	<b>56-792-X-135</b>	Special Order*	135°F/57°C	\$22.75
<b>Cover Plate (For use with 200° F Sprinkler)</b>				
80 Box Quantity (14.5 lbs/box)				
	<b>56-792-1-165</b>	Brass	165°F/74°C	\$21.25
	<b>56-792-9-165</b>	Chrome	165°F/74°C	\$21.25
	<b>56-792-0-165</b>	Grey White	165°F/74°C	\$21.25
	<b>56-792-4-165</b>	Signal (Bright) White	165°F/74°C	\$21.25
▶	<b>56-792-X-165</b>	Special Order*	165°F/74°C	\$22.75
<b>Notes</b>				
	<b>6012</b>	*Special Order paint match subject to set-up charge. (Net Price)		\$376.50
<b>Sprinkler Wrench</b>				
	<b>56-000-1-075</b>	RFII Wrench		\$81.00
<b>Air and Dust Seal</b>				
	<b>56-908-1-001</b>	Air and Dust Seal		\$12.00
<b>Technical Data Sheet: TFP181</b>				

Section 1  
Standard Spray Sprinklers

Section 2  
Extended Coverage Sprinklers

Section 3  
Storage Sprinklers

Section 4  
Residential Products

Section 5  
Dry Sprinklers

Section 6  
Special Sprinklers

Section 7  
Nozzles and Sprinkler Accessories

See latest Technical Data Sheets for specific Approvals, Listings, Design Parameters & available finishes. Sprinkler heads & escutcheons are priced separately unless otherwise noted.

Items marked "C.O." are made to order and may require longer delivery times. Please contact customer service for availability.

**Model TYQRF, K=5.6, Quick Response Standard Coverage, Flush Pendent Sprinklers**

(SIN TY3261)

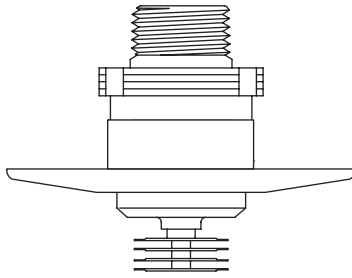

<i>C.O.</i>	<i>Pendent</i>	<i>Finish</i>	<i>Temperature</i>	<i>List Price</i>
	<b>53-261-9-162</b>	Chrome	162°F (72°C)	\$58.50
	<b>53-261-4-162</b>	White	162°F (72°C)	\$58.50
	<b>53-261-6-162</b>	Black	162°F (72°C)	\$66.00
<b>Trim Plates (Order Separately)</b>				
	<b>56-123-9-001</b>	Chrome Escutcheon		\$7.25
	<b>56-123-4-001</b>	White Escutcheon		\$7.25
	<b>56-123-6-001</b>	Black Escutcheon		\$7.25
<b>Sprinkler Wrench</b>				
	<b>56-000-4-947</b>	Wrench (Socket Only)		\$86.50
	<b>56-000-4-948</b>	Socket/Ratchet Wrench		\$128.50
	<b>56-000-4-300</b>	Protective Cover Removal Tool		\$28.50
<b>Technical Data Sheet: TFP190</b>				

Section 1  
Standard Spray Sprinklers

Section 2  
Extended Coverage Sprinklers

Section 3  
Storage Sprinklers

Section 4  
Residential Products

Section 5  
Dry Sprinklers

Section 6  
Special Sprinklers

Section 7  
Nozzles and Sprinkler Accessories

Items marked "C.O." are made to order and may require longer delivery times. Please contact customer service for availability.

See latest Technical Data Sheets for specific Approvals, Listings, Design Parameters & available finishes. Sprinkler heads & escutcheons are priced separately unless otherwise noted.

**Series EC-14, Upright Sprinklers K=14.0, 3/4" N.P.T.**

100 Box Quantity 27 lbs/box SIN TY6137

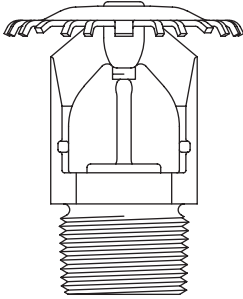
	<i>C.O.</i>	<i>Upright</i>	<i>Description</i>	<i>Temperature</i>	<i>List Price</i>
	▶	<b>51-896-1-135</b>	Brass	135°F/57°C	\$81.50
		<b>51-896-1-155</b>	Brass	155°F/68°C	\$81.50
	▶	<b>51-896-1-175</b>	Brass	175°F/79°C	\$81.50
		<b>51-896-1-200</b>	Brass	200°F/93°C	\$81.50
	▶	<b>51-896-1-286</b>	Brass	286°F/141°C	\$81.50
	▶	<b>51-896-9-135</b>	Chrome	135°F/57°C	\$85.50
		<b>51-896-9-155</b>	Chrome	155°F/68°C	\$85.50
	▶	<b>51-896-9-175</b>	Chrome	175°F/79°C	\$85.50
	▶	<b>51-896-9-200</b>	Chrome	200°F/93°C	\$85.50
	▶	<b>51-896-9-286</b>	Chrome	286°F/141°C	\$85.50
	▶	<b>51-896-4-135</b>	White	135°F/57°C	\$85.50
		<b>51-896-4-155</b>	White	155°F/68°C	\$85.50
	▶	<b>51-896-4-175</b>	White	175°F/79°C	\$85.50
	▶	<b>51-896-4-200</b>	White	200°F/93°C	\$85.50
	▶	<b>51-896-4-286</b>	White	286°F/141°C	\$85.50
		<b>51-896-X-155</b>	Black	155°F/68°C	\$124.00
		<b>51-896-X-200</b>	Black	200°F/93°C	\$124.00
	▶	<b>51-896-7-135</b>	Lead Coated	135°F/57°C	\$130.00
	▶	<b>51-896-7-155</b>	Lead Coated	155°F/68°C	\$130.00
	▶	<b>51-896-7-175</b>	Lead Coated	175°F/79°C	\$130.00
▶	<b>51-896-7-200</b>	Lead Coated	200°F/93°C	\$130.00	
▶	<b>51-896-7-286</b>	Lead Coated	286°F/141°C	\$130.00	
<b>Sprinkler Wrench</b>					
	<b>56-895-1-001</b>	W-Type 3 Wrench			\$67.25
<b>Technical Data Sheet: TFP220</b>					

Section 1  
Standard Spray Sprinklers

Section 2  
Extended Coverage Sprinklers

Section 3  
Storage Sprinklers

Section 4  
Residential Products

Section 5  
Dry Sprinklers

Section 6  
Special Sprinklers



Section 7  
Nozzles and Sprinkler Accessories

See latest Technical Data Sheets for specific Approvals, Listings, Design Parameters & available finishes. Sprinkler heads & escutcheons are priced separately unless otherwise noted.

Items marked "C.O." are made to order and may require longer delivery times. Please contact customer service for availability.

**Series EC-14, Pendent and Recessed Pendent Sprinklers K=14.0, 3/4" N.P.T.**

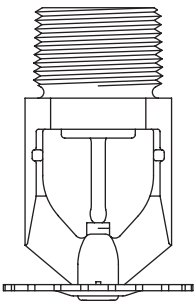
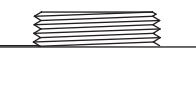
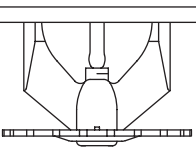
100 Box Quantity, 27 lbs/box (SIN TY6237)

	C.O.	Pendent	Description	Temperature	List Price	
	▶	<b>51-895-1-135</b>	Brass	135°F/57°C	\$57.50	
		<b>51-895-1-155</b>	Brass	155°F/68°C	\$57.50	
	▶	<b>51-895-1-175</b>	Brass	175°F/79°C	\$57.50	
		<b>51-895-1-200</b>	Brass	200°F/93°C	\$57.50	
	▶	<b>51-895-1-286</b>	Brass	286°F/141°C	\$57.50	
		▶	<b>51-895-9-135</b>	Chrome	135°F/57°C	\$60.75
			<b>51-895-9-155</b>	Chrome	155°F/68°C	\$60.75
		▶	<b>51-895-9-175</b>	Chrome	175°F/79°C	\$60.75
		▶	<b>51-895-9-200</b>	Chrome	200°F/93°C	\$60.75
		▶	<b>51-895-9-286</b>	Chrome	286°F/141°C	\$60.75
	▶	<b>51-895-4-135</b>	White	135°F/57°C	\$60.75	
		<b>51-895-4-155</b>	White	155°F/68°C	\$60.75	
	▶	<b>51-895-4-175</b>	White	175°F/79°C	\$60.75	
	▶	<b>51-895-4-200</b>	White	200°F/93°C	\$60.75	
	▶	<b>51-895-4-286</b>	White	286°F/141°C	\$60.75	
		<b>51-895-X-155</b>	Black	155°F/68°C	\$114.00	
		<b>51-895-X-200</b>	Black	200°F/93°C	\$114.00	
	▶	<b>51-895-7-135</b>	Lead Coated	135°F/57°C	\$119.50	
	▶	<b>51-895-7-155</b>	Lead Coated	155°F/68°C	\$119.50	
	▶	<b>51-895-7-175</b>	Lead Coated	175°F/79°C	\$119.50	
	▶	<b>51-895-7-200</b>	Lead Coated	200°F/93°C	\$119.50	
	▶	<b>51-895-7-286</b>	Lead Coated	286°F/141°C	\$119.50	
<b>Recessed Escutcheons (Order Separately)</b>						
		<b>56-705-2-011</b>	3/4" Brass Recessed (Style 30)		\$9.05	
		<b>56-705-9-011</b>	3/4" Chrome Recessed (Style 30)		\$6.50	
		<b>56-705-4-011</b>	3/4" White Recessed (Style 30)		\$6.50	
		<b>56-705-6-011</b>	3/4" Black Recessed (Style 30)		\$8.30	
		<b>56-700-2-010</b>	3/4" Brass Recessed (Style 40)		\$9.05	
		<b>56-700-9-010</b>	3/4" Chrome Recessed (Style 40)		\$6.50	
		<b>56-700-4-010</b>	3/4" White Recessed (Style 40)		\$6.50	
		<b>56-700-6-010</b>	3/4" Black Recessed (Style 40)		\$8.30	
		<b>208102</b>	3/4" Chrome Recessed (Style 60)		\$6.50	
		<b>208104</b>	3/4" White Recessed (Style 60)		\$6.50	
		<b>208107</b>	3/4" Brass Recessed (Style 60)		\$9.05	
<b>Sprinkler Wrench</b>						
		<b>56-895-1-001</b>	W-Type 3 Wrench		\$67.25	
		<b>56-665-7-001</b>	W-Type 22 (Recessed Only)		\$81.00	
<b>Technical Data Sheet: TFP220</b>						

Items marked "C.O." are made to order and may require longer delivery times. Please contact customer service for availability.

See latest Technical Data Sheets for specific Approvals, Listings, Design Parameters & available finishes. Sprinkler heads & escutcheons are priced separately unless otherwise noted.



**Series EC-11, Pendent, Recessed Pendent and Upright Sprinklers - K=11.2, 3/4" NPT**

100 Box Quantity (Upright 27 lbs/box (SIN TY5137), Pendent 27 lbs/box (SIN TY5237))

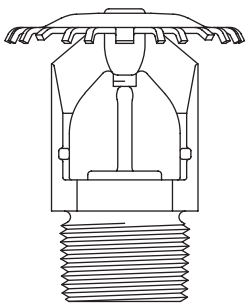
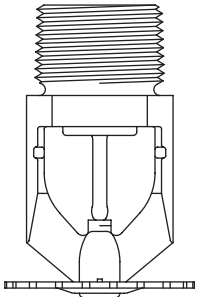
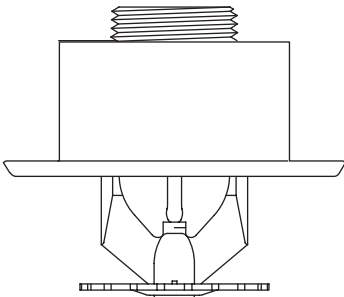
	C.O.	Upright	Pendent	Description	Temperature	List Price
	▶	51-894-1-135	51-893-1-135	Brass	135°F/57°C	\$52.25
		51-894-1-155	51-893-1-155	Brass	155°F/68°C	\$52.25
	▶	51-894-1-175	51-893-1-175	Brass	175°F/79°C	\$52.25
		51-894-1-200	51-893-1-200	Brass	200°F/93°C	\$52.25
	▶	51-894-1-286	51-893-1-286	Brass	286°F/141°C	\$52.25
	▶	51-894-9-135	51-893-9-135	Chrome	135°F/57°C	\$54.75
		51-894-9-155	51-893-9-155	Chrome	155°F/68°C	\$54.75
	▶	51-894-9-175	51-893-9-175	Chrome	175°F/79°C	\$54.75
	▶	51-894-9-200	51-893-9-200	Chrome	200°F/93°C	\$54.75
	▶	51-894-9-286	51-893-9-286	Chrome	286°F/141°C	\$54.75
	▶	51-894-4-135	51-893-4-135	White	135°F/57°C	\$54.75
		51-894-4-155	51-893-4-155	White	155°F/68°C	\$54.75
	▶	51-894-4-175	51-893-4-175	White	175°F/79°C	\$54.75
	▶	51-894-4-200	51-893-4-200	White	200°F/93°C	\$54.75
	▶	51-894-4-286	51-893-4-286	White	286°F/141°C	\$54.75
		51-894-X-155	51-893-X-155	Black	155°F/68°C	\$103.00
		51-894-X-200	51-893-X-200	Black	200°F/93°C	\$103.00
	▶	51-894-7-135	51-893-7-135	Lead Coated	135°F/57°C	\$108.00
	▶	51-894-7-155	51-893-7-155	Lead Coated	155°F/68°C	\$108.00
	▶	51-894-7-175	51-893-7-175	Lead Coated	175°F/79°C	\$108.00
▶	51-894-7-200	51-893-7-200	Lead Coated	200°F/93°C	\$108.00	
▶	51-894-7-286	51-893-7-286	Lead Coated	286°F/141°C	\$108.00	
	<b>Recessed Escutcheons (Order Separately)</b>					
		56-705-2-011	3/4" Brass Recessed (Style 30)			\$9.05
		56-705-9-011	3/4" Chrome Recessed (Style 30)			\$6.50
		56-705-4-011	3/4" White Recessed (Style 30)			\$6.50
		56-705-6-011	3/4" Black Recessed (Style 30)			\$8.30
		56-700-2-010	3/4" Brass Recessed (Style 40)			\$9.05
		56-700-9-010	3/4" Chrome Recessed (Style 40)			\$6.50
		56-700-4-010	3/4" White Recessed (Style 40)			\$6.50
		56-700-6-010	3/4" Black Recessed (Style 40)			\$8.30
		208102	3/4" Chrome Recessed (Style 60)			\$6.50
	208104	3/4" White Recessed (Style 60)			\$6.50	
	208107	3/4" Brass Recessed (Style 60)			\$9.05	
<b>Sprinkler Wrench</b>						
	56-895-1-001	W-Type 3 Wrench				\$67.25
	56-665-7-001	W-Type 22 (Recessed Only)				\$81.00
<b>Technical Data Sheet: TFP220</b>						

Section 1	Standard Spray Sprinklers
Section 2	Extended Coverage Sprinklers
Section 3	Storage Sprinklers
Section 4	Residential Products
Section 5	Dry Sprinklers
Section 6	Special Sprinklers
Section 7	Nozzles and Sprinkler Accessories

See latest Technical Data Sheets for specific Approvals, Listings, Design Parameters & available finishes. Sprinkler heads & escutcheons are priced separately unless otherwise noted.

Items marked "C.O." are made to order and may require longer delivery times. Please contact customer service for availability.

**TY-FRB, 3 mm Bulb, K=5.6, 1/2" NPT, Quick Response**  
**Extended Coverage, Horizontal Sidewall and Recessed Horizontal Sidewall Sprinklers**

100 Box Quantity (21 lbs/box) (SIN TY3332)

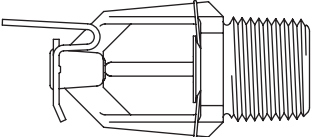
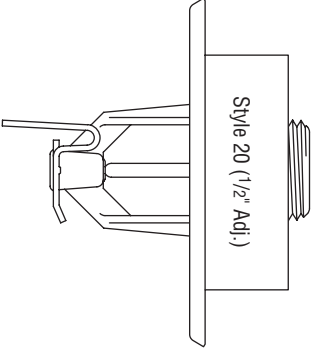
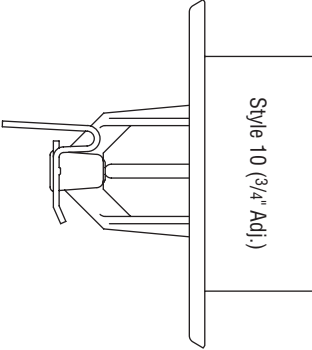
	<i>C.O.</i>	<i>Horizontal Sidewall</i>	<i>Finish</i>	<i>Temperature</i>	<i>List Price</i>
	▶	<b>57-376-1-135</b>	Brass	135°F/57°C	\$33.75
		<b>57-376-1-155</b>	Brass	155°F/68°C	\$33.75
	▶	<b>57-376-1-175</b>	Brass	175°F/79°C	\$33.75
	▶	<b>57-376-9-135</b>	Chrome	135°F/57°C	\$36.50
		<b>57-376-9-155</b>	Chrome	155°F/68°C	\$36.50
	▶	<b>57-376-9-175</b>	Chrome	175°F/79°C	\$36.50
	▶	<b>57-376-4-135</b>	White	135°F/57°C	\$36.50
		<b>57-376-4-155</b>	White	155°F/68°C	\$36.50
		<b>57-376-4-175</b>	White	175°F/79°C	\$36.50
 Style 20 (1/2" Adj.)	<b>Recessed Escutcheons (Order Separately)</b>				
		<b>56-701-2-010</b>	1/2" Brass Recessed (Style 10)		\$9.05
		<b>56-701-9-010</b>	1/2" Chrome Recessed (Style 10)		\$6.25
		<b>56-701-4-010</b>	1/2" White Recessed (Style 10)		\$6.25
		<b>56-705-2-010</b>	1/2" Brass Recessed (Style 20)		\$9.05
		<b>56-705-9-010</b>	1/2" Chrome Recessed (Style 20)		\$6.25
		<b>56-705-4-010</b>	1/2" White Recessed (Style 20)		\$6.25
	<b>Sprinkler Wrench</b>				
		<b>56-000-6-387</b>	W-Type 6 Wrench		\$48.75
	<b>56-850-4-001</b>	W-Type 7 Wrench (Recessed Only)		\$81.00	
 Style 10 (3/4" Adj.)	<b>Technical Data Sheet: TFP296</b>				

Items marked "C.O." are made to order and may require longer delivery times. Please contact customer service for availability.

See latest Technical Data Sheets for specific Approvals, Listings, Design Parameters & available finishes. Sprinkler heads & escutcheons are priced separately unless otherwise noted.

Section 1  
Standard Spray Sprinklers

Section 2  
Extended Coverage Sprinklers

Section 3  
Storage Sprinklers

Section 4  
Residential Products

Section 5  
Dry Sprinklers

Section 6  
Special Sprinklers

Section 7  
Nozzles and Sprinkler Accessories

**TY-FRB, 3 mm Bulb, K=8.0, 3/4" NPT, Quick Response-Extended Coverage,  
Horizontal Sidewall and Recessed Horizontal Sidewall Sprinklers**

100 Box Quantity (21 lbs/box) (SIN TY4332)

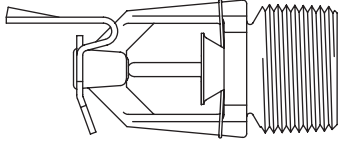
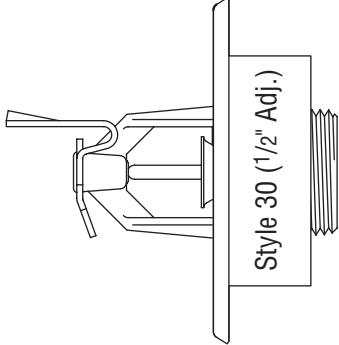
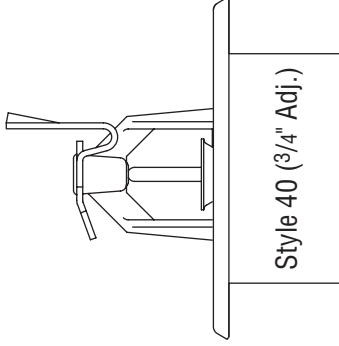
	<i>C.O.</i>	<i>Sidewall</i>	<i>Finish</i>	<i>Temperature</i>	<i>List Price</i>
	▶	<b>57-396-1-135</b>	Brass	135°F/57°C	\$34.50
		<b>57-396-1-155</b>	Brass	155°F/68°C	\$34.50
	▶	<b>57-396-1-175</b>	Brass	175°F/79°C	\$34.50
	▶	<b>57-396-9-135</b>	Chrome	135°F/57°C	\$39.00
		<b>57-396-9-155</b>	Chrome	155°F/68°C	\$39.00
	▶	<b>57-396-9-175</b>	Chrome	175°F/79°C	\$39.00
	▶	<b>57-396-4-135</b>	White	135°F/57°C	\$39.00
		<b>57-396-4-155</b>	White	155°F/68°C	\$39.00
		▶	<b>57-396-4-175</b>	White	175°F/79°C
 Style 30 (1/2" Adj.)	<b>Recessed Escutcheons (Order Separately)</b>				
		<b>56-705-2-011</b>	3/4" Brass Recessed (Style 30)		\$9.05
		<b>56-705-9-011</b>	3/4" Chrome Recessed (Style 30)		\$6.50
		<b>56-705-4-011</b>	3/4" White Recessed (Style 30)		\$6.50
		<b>56-700-2-010</b>	3/4" Brass Recessed (Style 40)		\$9.05
		<b>56-700-9-010</b>	3/4" Chrome Recessed (Style 40)		\$6.50
		<b>56-700-4-010</b>	3/4" White Recessed (Style 40)		\$6.50
	<b>Sprinkler Wrench</b>				
		<b>56-000-6-387</b>	W-Type 6 Wrench		\$48.75
	<b>56-850-4-001</b>	W-Type 7 Wrench (Recessed Only)		\$81.00	
 Style 40 (3/4" Adj.)	<b>Technical Data Sheet: TFP296</b>				

Section 1	Standard Spray Sprinklers
Section 2	Extended Coverage Sprinklers
Section 3	Storage Sprinklers
Section 4	Residential Products
Section 5	Dry Sprinklers
Section 6	Special Sprinklers
Section 7	Nozzles and Sprinkler Accessories

See latest Technical Data Sheets for specific Approvals, Listings, Design Parameters & available finishes. Sprinkler heads & escutcheons are priced separately unless otherwise noted.

Items marked "C.O." are made to order and may require longer delivery times. Please contact customer service for availability.

**ELO SW-20 ECOH, Sidewall Sprinklers, K=11.2, 3/4" N.P.T.**

100 Box Quantity (32 lbs/box) (SIN TY5332)

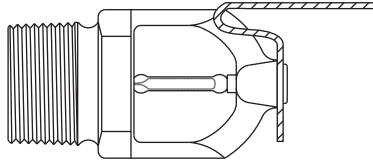

C.O.	Part No.	Model	Finish	Temperature	List Price
	51-072-1-155	ECOH ELO S/W-20	Brass	155°F/68°C	\$125.00
	51-072-1-200	ECOH ELO S/W-20	Brass	200°F/93°C	\$125.00
	51-072-9-155	ECOH ELO S/W-20	Chrome	155°F/68°C	\$129.50
	51-072-9-200	ECOH ELO S/W-20	Chrome	200°F/93°C	\$129.50
	51-072-4-155	ECOH ELO S/W-20	White	155°F/68°C	\$129.50
	51-072-4-200	ECOH ELO S/W-20	White	200°F/93°C	\$129.50
<b>Sprinkler Wrench</b>					
	56-895-1-001	W-Type 3 Wrench			\$67.25
<b>Technical Data Sheet: TFP230</b>					

**ELO SW-24 ECOH, Sidewall Sprinklers, K=11.2, 3/4" N.P.T.**

100 Box Quantity (32 lbs/box) (SIN TY5337)

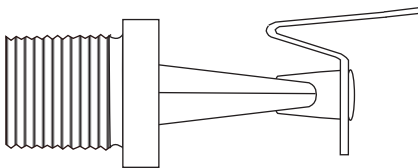

C.O.	Part No.	Model	Finish	Temperature	List Price
	51-073-1-200	ECOH ELO SW-24	Brass	200°F/93°C	\$125.00
	51-073-9-200	ECOH ELO SW-24	Chrome	200°F/93°C	\$129.50
	51-073-4-200	ECOH ELO SW-24	White	200°F/93°C	\$129.50
<b>Sprinkler Wrench</b>					
	56-895-1-001	W-Type 3 Wrench			\$67.25
<b>Technical Data Sheet: TFP230</b>					

**ELOC Extended Coverage, Concealed Sprinklers, K=11.2, 3/4" N.P.T. (SIN TY5522)**

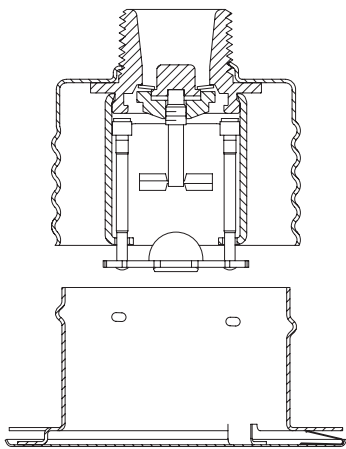

C.O.	Part No.	Model	Finish	Temperature	List Price
	50-701-1-160	ELOC	Brass	160°F/71°C	\$56.50
▶	50-701-1-212	ELOC	Brass	212°F/100°C	\$56.50
<b>Cover Plates (Order Separately)</b>					
	56-892-1-135	ELOC Cover Plate	Brass	135°F/57°C	\$21.25
	56-892-8-135	ELOC Cover Plate	Chrome	135°F/57°C	\$21.25
	56-892-8-165	ELOC Cover Plate	Chrome	165°F/74°C	\$21.25
	56-892-9-135	ELOC Cover Plate	Brushed Chrome	135°F/57°C	\$21.25
	56-892-9-165	ELOC Cover Plate	Brushed Chrome	165°F/74°C	\$21.25
	56-892-0-135	ELOC Cover Plate	Grey White	135°F/57°C	\$21.25
	56-892-0-165	ELOC Cover Plate	Grey White	165°F/74°C	\$21.25
	56-892-4-135	ELOC Cover Plate	Signal (Bright) White	135°F/57°C	\$21.25
▶	56-892-X-135	ELOC Cover Plate	Special Order*	135°F/57°C	\$25.00
<b>Clean Room Seals (Order Separately)</b>					
	56-908-1-001	ELOC Clean Room Seal			\$12.00
<b>Sprinkler Wrench</b>					
	56-000-1-265	W-Type 18 Wrench			\$81.00
<b>Notes</b>					
	6012	*Special Order paint match subject to set-up charge. (Net Price)			\$376.50
<b>Technical Data Sheet: TFP250</b>					

**Note: All "Special Order" cover plates are special ordered and are Non-Returnable. Please see "Terms & Conditions"**

Items marked "C.O." are made to order and may require longer delivery times. Please contact customer service for availability.

See latest Technical Data Sheets for specific Approvals, Listings, Design Parameters & available finishes. Sprinkler heads & escutcheons are priced separately unless otherwise noted.

**Series RFI, 5.6 K-factor, "Royal Flush II" Pendent Concealed Sprinklers  
Extended Coverage, Quick and Standard Response**

80 Box Quantity (29 lbs/box) (SIN TY3532)

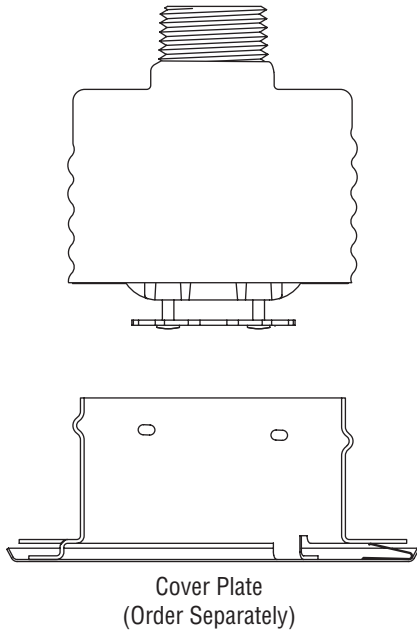

**Note: All "Special Order" cover plates are special ordered and are Non-Returnable. Please see "Terms & Conditions"**

C.O.	Pendent	Finish	Temperature	List Price
<b>Standard Pressure (175 psi)</b>				
	<b>51-794-1-155</b>	Bronze	155°F/68°C	\$42.50
	<b>51-794-1-200</b>	Bronze	200°F/93°C	\$42.50
<b>Cover Plate (For use with 155° F Sprinkler)</b>				
80 Box Quantity (14.5 lbs/box)				
	<b>56-792-1-135</b>	Brass	135°F/57°C	\$21.25
	<b>56-792-9-135</b>	Chrome	135°F/57°C	\$21.25
	<b>56-792-0-135</b>	Grey White	135°F/57°C	\$21.25
	<b>56-792-4-135</b>	Signal (Bright) White	135°F/57°C	\$21.25
	<b>56-792-X-135</b>	Special Order*	135°F/57°C	\$22.75
<b>Cover Plate (For use with 200° F Sprinkler)</b>				
80 Box Quantity (14.5 lbs/box)				
	<b>56-792-1-165</b>	Brass	165°F/74°C	\$21.25
	<b>56-792-9-165</b>	Chrome	165°F/74°C	\$21.25
	<b>56-792-0-165</b>	Grey White	165°F/74°C	\$21.25
	<b>56-792-4-165</b>	Signal (Bright) White	165°F/74°C	\$21.25
	<b>56-792-X-165</b>	Special Order*	165°F/74°C	\$22.75
<b>Air and Dust Seal</b>				
	<b>56-908-1-001</b>	Air and Dust Seal		\$12.00
<b>Sprinkler Wrench</b>				
	<b>56-000-1-075</b>	RFII Wrench		\$81.00
<b>Notes</b>				
	<b>6012</b>	*Special Order paint match subject to set-up charge. (Net Price)		\$376.50
<b>Technical Data Sheet: TFP260</b>				

**Model TY-FRL, K=5.6, 1/2" NPT Extended Coverage Quick Response  
Horizontal Sidewall Sprinkler**

100 Box Quantity (20 lbs/box) (SIN TY3322)

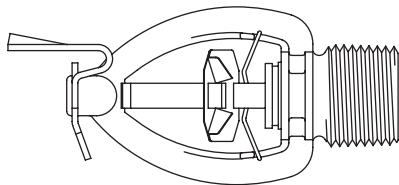

C.O.	Horizontal Sidewall	Finish	Temperature	List Price
	<b>58-970-1-165</b>	Brass	165°F/74°C	\$75.00
	<b>58-970-9-165</b>	Chrome	165°F/74°C	\$84.50
<b>Sprinkler Wrench</b>				
	<b>56-000-1-849</b>	W-Type 9 Wrench		\$43.50
<b>Technical Data Sheet: TFP280</b>				

See latest Technical Data Sheets for specific Approvals, Listings, Design Parameters & available finishes. Sprinkler heads & escutcheons are priced separately unless otherwise noted.

Items marked "C.O." are made to order and may require longer delivery times. Please contact customer service for availability.

Section 1  
Standard Spray Sprinklers

Section 2  
Extended Coverage Sprinklers

Section 3  
Storage Sprinklers

Section 4  
Residential Products

Section 5  
Dry Sprinklers

Section 6  
Special Sprinklers

Section 7  
Nozzles and Sprinkler Accessories

**Model TY-FRL, K=8.0, 3/4" NPT, Quick Response**  
**Extended Coverage Horizontal Sidewall Sprinklers**

100 Box Quantity (25 lbs/box) (SIN TY4322)

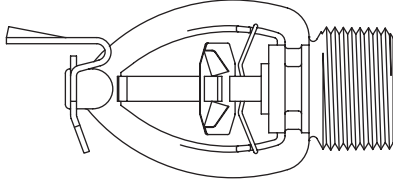

C.O.	Horizontal Sizewall	Description	Temperature	List Price
	<b>58-170-1-165</b>	Brass	165°F/74°C	\$84.50
	<b>58-170-9-165</b>	Chrome	165°F/74°C	\$94.25

**Sprinkler Wrench**

<b>56-000-1-849</b>	W-Type 9 Wrench	\$43.50
---------------------	-----------------	---------

**Technical Data Sheet: TFP280**

**CHEC Concealed Horizontal Sidewall**  
**Extended Coverage Sprinklers, K=8.0, 3/4" N.P.T. ECLH (SIN TY4332)**

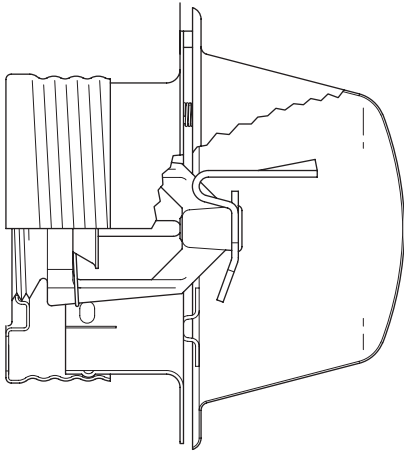

C.O.	Number	Model	Temperature	List Price
	<b>51-396-1-155</b>	CHEC Sidewall	155°F/68°C	\$35.75

**Cover Plate (Order Separately)**

<b>56-396-4-135</b>	Signal (Bright) White	\$20.00
<b>56-396-9-135</b>	Chrome	\$20.00
<b>56-396-X-135</b>	Special Order	\$20.00

**Sprinkler Wrench**

<b>56-850-4-001</b>	Wrench W-Type 7	\$81.00
---------------------	-----------------	---------

**Notes**

<b>6012</b>	*Special Order paint match subject to set-up charge. (Net Price)	\$376.50
-------------	--	----------

**Note: All "Special Order" cover plates are special ordered and are Non-Returnable. Please see "Terms & Conditions"**

**Technical Data Sheet: TFP265**

Section 1  
Standard Spray Sprinklers

Section 2  
Extended Coverage Sprinklers

Section 3  
Storage Sprinklers

Section 4  
Residential Products

Section 5  
Dry Sprinklers

Section 6  
Special Sprinklers

Section 7  
Nozzles and Sprinkler Accessories

Items marked "C.O." are made to order and may require longer delivery times. Please contact customer service for availability.

See latest Technical Data Sheets for specific Approvals, Listings, Design Parameters & available finishes. Sprinkler heads & escutcheons are priced separately unless otherwise noted.

**EC-8 QR Pendent and Recessed Pendent Sprinklers K=8.0, 3/4" N.P.T. ECLH**

100 Box Quantity (24 lbs/box) (SIN TY4232)

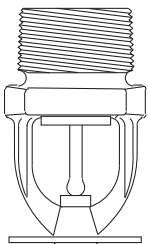
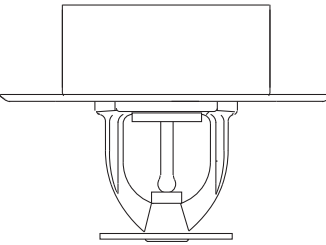
	<i>C.O.</i>	<i>Number</i>	<i>Model</i>	<i>Finish</i>	<i>Temperature</i>	<i>List Price</i>	
	▶	<b>50-801-1-135</b>	EC-8 QR	Brass	135°F/57°C	\$37.25	
		<b>50-801-1-155</b>	EC-8 QR	Brass	155°F/68°C	\$37.25	
	▶	<b>50-801-9-135</b>	EC-8 QR	Chrome	135°F/57°C	\$40.50	
		<b>50-801-9-155</b>	EC-8 QR	Chrome	155°F/68°C	\$40.50	
	▶	<b>50-801-4-135</b>	EC-8 QR	White	135°F/57°C	\$40.50	
		<b>50-801-4-155</b>	EC-8 QR	White	155°F/68°C	\$40.50	
	<b>Recessed Escutcheons (Order Separately)</b>						
	▶	<b>56-705-2-011</b>	3/4" Brass Recessed (Style 30)				\$9.05
		<b>56-705-9-011</b>	3/4" Chrome Recessed (Style 30)				\$6.50
		<b>56-705-4-011</b>	3/4" White Recessed (Style 30)				\$6.50
	<b>56-700-2-010</b>	3/4" Brass Recessed (Style 40)				\$9.05	
	<b>56-700-9-010</b>	3/4" Chrome Recessed (Style 40)				\$6.50	
	<b>56-700-4-010</b>	3/4" White Recessed (Style 40)				\$6.50	
	<b>Sprinkler Wrench</b>						
		<b>56-895-1-001</b>	W-Type 3 Wrench			\$67.25	
		<b>56-000-6-838</b>	W-Type 23 Wrench (Recessed Only)			\$81.00	
<b>Technical Data Sheet: TFP223</b>							

Section 1	Standard Spray Sprinklers
Section 2	Extended Coverage Sprinklers
Section 3	Storage Sprinklers
Section 4	Residential Products
Section 5	Dry Sprinklers
Section 6	Special Sprinklers
Section 7	Nozzles and Sprinkler Accessories

See latest Technical Data Sheets for specific Approvals, Listings, Design Parameters & available finishes. Sprinkler heads & escutcheons are priced separately unless otherwise noted.

Items marked "C.O." are made to order and may require longer delivery times. Please contact customer service for availability.



**EC-5 QR Pendent, Recessed Pendent and Sidewall Sprinklers K=5.6, 1/2" N.P.T.**

100 Box Quantity (Pendent 15 lbs/box (SIN TY3232), Sidewall 16 lbs/box (SIN TY3302))

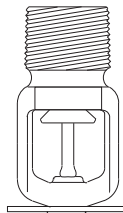
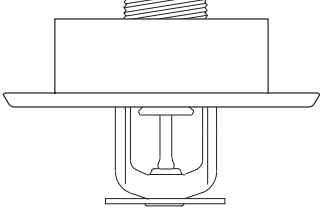
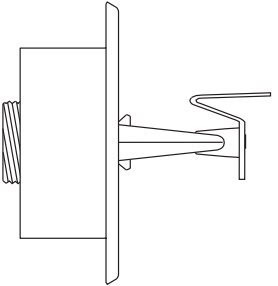
	C.O.	Pendent	Sidewall	Model	Finish	Temperature	List Price
		51-051-1-135	51-053-1-135	EC-5 1/2"	Brass	135°F/57°C	\$41.50
		51-051-1-155	51-053-1-155	EC-5 1/2"	Brass	155°F/68°C	\$41.50
		-	51-053-1-200	EC-5 1/2"	Brass	200°F/93°C	\$41.50
		51-051-9-135	51-053-9-135	EC-5 1/2"	Chrome	135°F/57°C	\$45.00
		51-051-9-155	51-053-9-155	EC-5 1/2"	Chrome	155°F/68°C	\$45.00
		-	51-053-9-200	EC-5 1/2"	Chrome	200°F/93°C	\$45.00
		51-051-4-135	51-053-4-135	EC-5 1/2"	White	135°F/57°C	\$45.00
		51-051-4-155	51-053-4-155	EC-5 1/2"	White	155°F/68°C	\$45.00
		-	51-053-4-200	EC-5 1/2"	White	200°F/93°C	\$45.00
	<b>Recessed Escutcheons (Order Separately)</b>						
		56-711-2-010	1/2" Brass Recessed (Style 50)				\$9.05
		56-711-9-010	1/2" Chrome Recessed (Style 50)				\$6.25
		56-711-4-010	1/2" White Recessed (Style 50)				\$6.25
	<b>Sprinkler Wrench</b>						
		56-000-6-387	W-Type 6 Wrench				\$48.75
	56-850-4-001	W-Type 7 Wrench (Recessed Only)				\$81.00	

**Technical Data Sheet: Pendent-TFP228, Sidewall-TFP298**

Items marked "C.O." are made to order and may require longer delivery times. Please contact customer service for availability.

See latest Technical Data Sheets for specific Approvals, Listings, Design Parameters & available finishes. Sprinkler heads & escutcheons are priced separately unless otherwise noted.

Section 1  
Standard Spray Sprinklers

Section 2  
Extended Coverage Sprinklers

Section 3  
Storage Sprinklers

Section 4  
Residential Products

Section 5  
Dry Sprinklers

Section 6  
Special Sprinklers

Section 7  
Nozzles and Sprinkler Accessories

**Model ESFR-25™, K=25.2, 1" NPT, Early Suppression, Fast Response Sprinkler**

50 Box Quantity (23 lbs/box) (SIN TY9226)

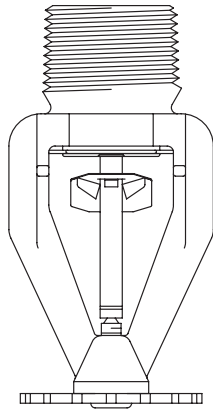

C.O.	Pendent	Description	Temperature	Price
	<b>58-441-1-165</b>	Brass	165°F (74°C)	\$89.75
	<b>58-441-1-214</b>	Brass	214°F (101°C)	\$89.75
<b>Sprinkler Wrench</b>				
	<b>56-872-1-025</b>	W-Type 1 Wrench		\$61.75

Technical Data Sheet: TFP312

Section 1  
Standard Spray Sprinklers

Section 2  
Extended Coverage Sprinklers

**Model EC-25, K=25.2, 1" NPT, Upright, Area/Density, Extended Coverage (SIN TY9128)**

SIN TY9128

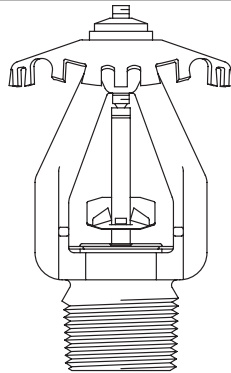

C.O.	Upright	Description	Temperature	List Price
	<b>58-450-1-165</b>	Brass	165°F/74°C	\$94.25
	<b>58-450-1-214</b>	Brass	214°F/101°C	\$94.25
<b>Sprinkler Wrench</b>				
	<b>56-872-1-025</b>	W-Type 1 Wrench		\$61.75

Technical Data Sheet: TFP213

Section 3  
Storage Sprinklers

Section 4  
Residential Products

Section 5  
Dry Sprinklers

**ESFR-17, K=16.8, 3/4" NPT, Early Suppression, Fast Response Upright Sprinkler**

50 Box Quantity (20 lbs/box) (SIN TY7126)

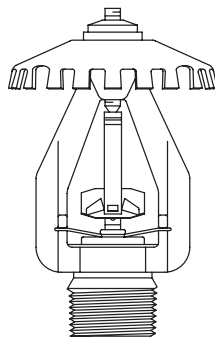

C.O.	Upright	Description	Temperature	Price
	<b>58-447-1-165</b>	Brass	165°F (74°C)	\$79.00
	<b>58-447-1-214</b>	Brass	214°F (101°C)	\$79.00
<b>Sprinkler Wrench</b>				
	<b>56-001-0-686</b>	W-Type 21 Wrench		\$48.75

Technical Data Sheet: TFP316

Section 6  
Special Sprinklers

Section 7  
Nozzles and Sprinkler Accessories

See latest Technical Data Sheets for specific Approvals, Listings, Design Parameters & available finishes. Sprinkler heads & escutcheons are priced separately unless otherwise noted.

Items marked "C.O." are made to order and may require longer delivery times. Please contact customer service for availability.

**ESFR-17, K=16.8, 3/4" NPT, Early Suppression, Fast Response Pendent Sprinkler**

50 Box Quantity (20 lbs/box) (SIN TY7226)

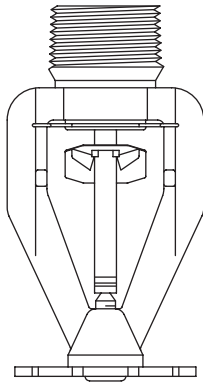

<i>C.O.</i>	<i>Pendent</i>	<i>Description</i>	<i>Temperature</i>	<i>Price</i>
	<b>58-445-1-165</b>	Brass	165°F (74°C)	\$61.75
	<b>58-445-1-214</b>	Brass	214°F (101°C)	\$61.75
<b>Sprinkler Wrench</b>				
	<b>56-001-0-686</b>	W-Type 21 Wrench		\$48.75

Technical Data Sheet: TFP315

**Model ESFR-1, K=14.0, 3/4" NPT, Early Suppression, Fast Response Sprinkler**

50 Box Quantity (21 lbs/box) (SIN TY6226)

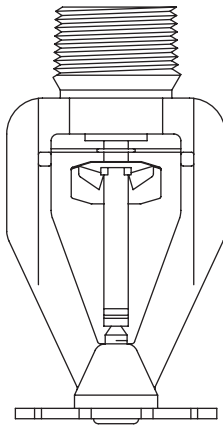

<i>C.O.</i>	<i>Pendent</i>	<i>Description</i>	<i>Temperature</i>	<i>Price</i>
	<b>58-440-1-165</b>	Brass	165°F (74°C)	\$49.00
	<b>58-440-1-214</b>	Brass	214°F (101°C)	\$49.00
<b>Sprinkler Wrench</b>				
	<b>56-872-1-001</b>	W-Type 2 Wrench		\$48.75

Technical Data Sheet: TFP318

Section 1  
Standard Spray Sprinklers

Section 2  
Extended Coverage Sprinklers

Section 3  
Storage Sprinklers

Section 4  
Residential Products

Section 5  
Dry Sprinklers

Section 6  
Special Sprinklers

Section 7  
Nozzles and Sprinkler Accessories

Items marked "C.O." are made to order and may require longer delivery times. Please contact customer service for availability.

See latest Technical Data Sheets for specific Approvals, Listings, Design Parameters & available finishes. Sprinkler heads & escutcheons are priced separately unless otherwise noted.

**Ultra K17, Upright, K=16.8, 3/4" Thread Specific Application**

100 Box Quantity (31 lbs/box) (SIN TY7153)

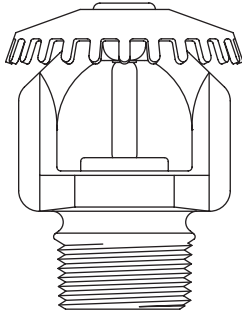

C.O.	Upright	Description	Temperature	Price
	51-887-1-155	Brass	155°F/68°C	\$71.50
	51-887-1-200	Brass	200°F/93°C	\$71.50
	51-887-1-286	Brass	286°F/141°C	POA
<b>Sprinkler Wrench</b>				
	56-892-1-001	W-Type 8 Wrench		\$81.00
<b>Technical Data Sheet: TFP330</b>				

Section 1  
Standard Spray Sprinklers

Section 2  
Extended Coverage Sprinklers

**Model K17-231, K=16.8, 3/4" Thread, Upright Sprinkler**

100 Box Quantity, 31 lbs/box (SIN TY7151)

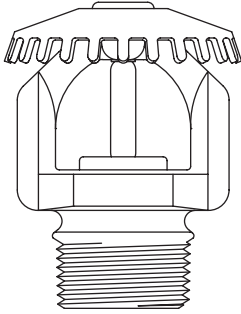

C.O.	Upright	Description	Temperature	Price
	51-888-1-155	Brass	155°F/68°C	\$41.00
	51-888-1-200	Brass	200°F/93°C	\$41.00
	51-888-1-286	Brass	286°F/141°C	\$41.00
<b>Sprinkler Wrench</b>				
	56-892-1-001	W-Type 8 Wrench		\$81.00
<b>Technical Data Sheet: TFP332</b>				

Section 3  
Storage Sprinklers

Section 4  
Residential Products

**Model K17-231, K=16.8, 3/4" Thread, Pendent Sprinkler**

100 Box Quantity, 27 lbs/box (SIN TY7251)

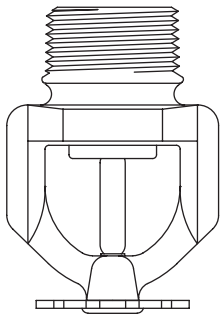

C.O.	Pendent	Description	Temperature	Price
	51-889-1-155	Brass	155°F/68°C	\$38.25
	51-889-1-200	Brass	200°F/93°C	\$38.25
	51-889-1-286	Brass	286°F/141°C	\$38.25
<b>Sprinkler Wrench</b>				
	56-892-1-001	W-Type 8 Wrench		\$81.00
<b>Technical Data Sheet: TFP332</b>				

Section 5  
Dry Sprinklers

Section 6  
Special Sprinklers

Section 7  
Nozzles and Sprinkler Accessories

See latest Technical Data Sheets for specific Approvals, Listings, Design Parameters & available finishes. Sprinkler heads & escutcheons are priced separately unless otherwise noted.

Items marked "C.O." are made to order and may require longer delivery times. Please contact customer service for availability.

**Model ELO-231 and ELO-231B, Standard Response,  
Upright and Pendent Sprinklers K=11.2, 1/2" & 3/4" N.P.T.**

100 Box Quantity (ELO-231 - Upright 33 lbs/box (SIN-TY5111),  
Pendent 31lbs/box (SIN-TY5211), Upright - 1/2 NPT -TY5811)  
(ELO-231B - Upright 36 lbs/box (SIN-TY5151), Pendent 33 lbs/box (SIN-TY5251), Upright - 1/2 NPT - TY5851)

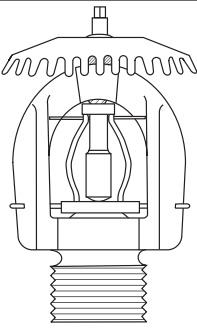
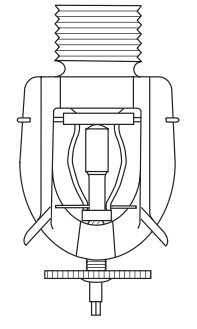
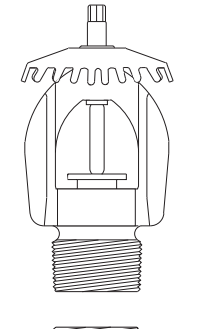
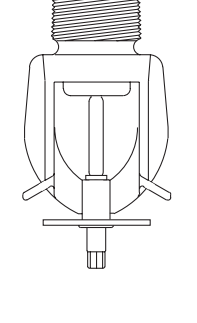
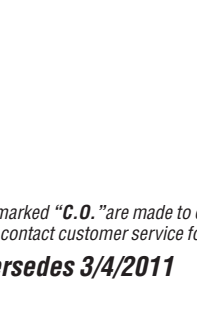
	C.O.	Upright	Pendent	Model	Finish	Temperature	List Price
		50-510-1-155	50-512-1-155	ELO-231B	Brass	155°F/68°C	\$38.75
		50-510-1-200	50-512-1-200	ELO-231B	Brass	200°F/93°C	\$38.75
		50-510-1-286	50-512-1-286	ELO-231B	Brass	286°F/121°C	\$38.75
	▶	50-510-7-155	50-512-7-155	ELO-231B	Lead Coated	155°F/68°C	\$91.75
	▶	50-510-7-200	50-512-7-200	ELO-231B	Lead Coated	200°F/93°C	\$91.75
	▶	50-510-7-286	50-512-7-286	ELO-231B	Lead Coated	286°F/121°C	\$91.75
	▶	50-510-6-155	50-512-6-155	ELO-231B	Wax Coated	155°F/68°C	\$84.25
	▶	50-510-6-200	50-512-6-200	ELO-231B	Wax Coated	200°F/93°C	\$84.25
	▶	50-510-6-286	50-512-6-286	ELO-231B	Wax Coated	286°F/121°C	\$84.25
	▶	50-510-8-155	50-512-8-155	ELO-231B	Wax over Lead	155°F/68°C	\$137.00
	▶	50-510-8-200	50-512-8-200	ELO-231B	Wax over Lead	200°F/93°C	\$137.00
	▶	50-510-8-286	50-512-8-286	ELO-231B	Wax over Lead	286°F/121°C	\$137.00
		50-110-1-165	50-112-1-165	ELO-231	Brass	165°F/74°C	\$40.50
		50-110-1-212	50-112-1-212	ELO-231	Brass	212°F/100°C	\$43.50
		50-110-1-286	50-112-1-286	ELO-231	Brass	286°F/141°C	\$40.50
	▶	50-110-7-165	50-112-7-165	ELO-231	Lead Coated	155°F/68°C	\$91.75
	▶	50-110-7-212	50-112-7-212	ELO-231	Lead Coated	200°F/93°C	\$91.75
	▶	50-110-7-286	50-112-7-286	ELO-231	Lead Coated	286°F/121°C	\$91.75
	▶	50-110-6-165	50-112-6-165	ELO-231	Wax Coated	155°F/68°C	\$84.25
	▶	50-110-6-212	50-112-6-212	ELO-231	Wax Coated	200°F/93°C	\$84.25
	▶	50-110-6-286	50-112-6-286	ELO-231	Wax Coated	286°F/121°C	\$84.25
	▶	50-110-8-165	50-112-8-165	ELO-231	Wax over Lead	155°F/68°C	\$137.00
	▶	50-110-8-212	50-112-8-212	ELO-231	Wax over Lead	200°F/93°C	\$137.00
	▶	50-110-8-286	50-112-8-286	ELO-231	Wax over Lead	286°F/121°C	\$137.00
	▶	50-501-1-155	-	ELO-231B x 1/2	Brass	155°F/68°C	\$57.75
	▶	50-501-1-200	-	ELO-231B x 1/2	Brass	200°F/93°C	\$57.75
	▶	50-501-1-286	-	ELO-231B x 1/2	Brass	286°F/121°C	\$57.75
	▶	50-210-1-165	-	ELO-231 x 1/2	Brass	165°F/74°C	\$61.75
	▶	50-210-1-212	-	ELO-231 x 1/2	Brass	212°F/100°C	\$61.75
	▶	50-210-1-286	-	ELO-231 x 1/2	Brass	286°F/141°C	\$61.75
				<b>Sprinkler Wrench</b>			
		56-895-1-001		W-Type 3 Wrench		\$67.25	
<b>Notes</b>							
ELO-231 = Strut							
ELO-231B = 5mm Glass Bulb							
<b>Technical Data Sheet: TFP340 &amp; TFP342</b>							

Items marked "C.O." are made to order and may require longer delivery times.  
Please contact customer service for availability.

See latest Technical Data Sheets for specific Approvals, Listings,  
Design Parameters & available finishes. Sprinkler heads & escutcheons  
are priced separately unless otherwise noted.

**ELO-231 FRB, Quick Response, Upright, Pendent Sprinklers K=11.2, 3/4" N.P.T.**

100 Box Quantity (32 lbs/box) (SIN Upright TY5131) (SIN Pendent TY5231)

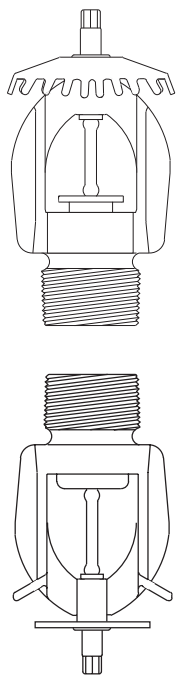
	<i>C.O.</i>	<i>Upright</i>	<i>Pendent</i>	<i>Model</i>	<i>Finis</i>	<i>Temperature</i>	<i>List Price</i>
		<b>50-500-1-155</b>	<b>50-502-1-155</b>	ELO-231FRB	Brass	155°F/68°C	\$57.75
		<b>50-500-1-200</b>	<b>50-502-1-200</b>	ELO-231FRB	Brass	200°F/93°C	\$57.75
		<b>50-500-1-286</b>	<b>50-502-1-286</b>	ELO-231FRB	Brass	286°F/141°C	\$57.75
	<b>Sprinkler Wrench</b>						
		<b>56-895-1-001</b>		W-Type 3 Wrench			\$67.25

**Technical Data Sheet: TFP344**

Section 1  
Standard Spray Sprinklers

Section 2  
Extended Coverage Sprinklers

Section 3  
Storage Sprinklers

Section 4  
Residential Products

Section 5  
Dry Sprinklers

Section 6  
Special Sprinklers

Section 7  
Nozzles and Sprinkler Accessories

**LD Large Drop Upright Sprinklers K=11.2, 3/4" N.P.T.**

100 Box Quantity (32 lbs/box) (SIN TY5153)

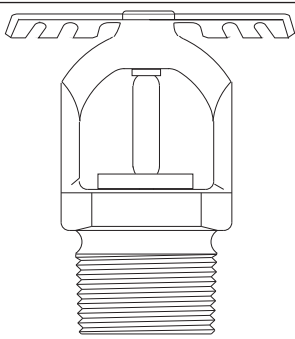
	<i>C.O.</i>	<i>Upright</i>	<i>Model</i>	<i>Finis</i>	<i>Temperature</i>	<i>List Price</i>
		<b>50-400-2-155</b>	LD Large Drop	Brass	155°F/68°C	\$61.25
		<b>50-400-2-200</b>	LD Large Drop	Brass	200°F/93°C	\$61.25
		<b>50-400-2-286</b>	LD Large Drop	Brass	286°F/141°C	\$61.25
	<b>Sprinkler Wrench</b>					
		<b>56-895-1-001</b>	W-Type 3 Wrench			\$67.25

**Technical Data Sheet: TFP335**

See latest Technical Data Sheets for specific Approvals, Listings, Design Parameters & available finishes. Sprinkler heads & escutcheons are priced separately unless otherwise noted.

Items marked "C.O." are made to order and may require longer delivery times. Please contact customer service for availability.

**TY-B, 5mm Bulb, K=5.6, 1/2" NPT, Standard Response,  
Intermediate Level Upright and Pendent Sprinklers w/Shield**

50 Box Quantity (28 lbs/box) (Upright - SIN TY3153), (Pendent - SIN TY3251)

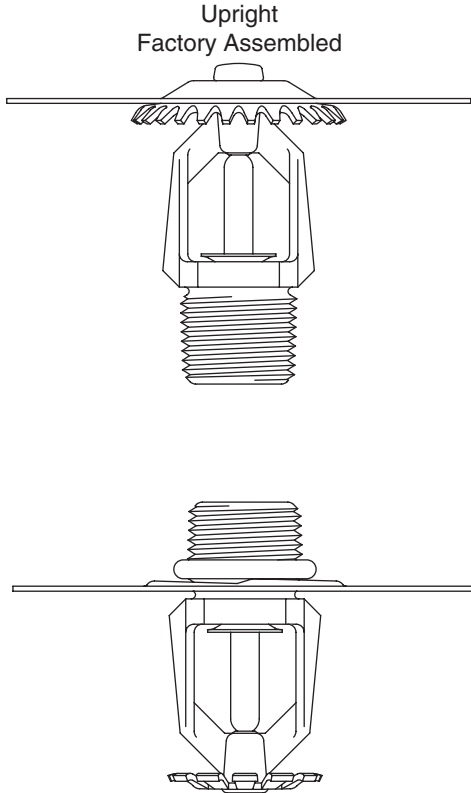

\*Pendent Shown Field Assembled  
(Order 57-571-X-XXX Sprinkler  
and Shield Assembly Separately)

C.O.	Upright w/Shield	Description	Temperature	List Price
▶	57-533-1-135	Brass	135°F/57°C	\$27.75
	57-533-1-155	Brass	155°F/68°C	\$27.75
▶	57-533-1-175	Brass	175°F/79°C	\$27.75
	57-533-1-200	Brass	200°F/93°C	\$27.75
	57-533-1-286	Brass	286°F/141°C	\$27.75
▶	57-533-1-360	Brass	360°F/182°C	\$30.75
▶	57-533-7-135	Lead Coated	135°F/57°C	\$74.50
▶	57-533-7-155	Lead Coated	155°F/68°C	\$74.50
▶	57-533-7-175	Lead Coated	175°F/79°C	\$74.50
▶	57-533-7-200	Lead Coated	200°F/93°C	\$74.50
▶	57-533-7-286	Lead Coated	286°F/141°C	\$74.50
▶	57-533-6-155	Wax Coated	155°F/68°C	\$70.50
▶	57-533-6-175	Wax Coated	175°F/79°C	\$70.50
▶	57-533-6-200	Wax Coated	200°F/93°C	\$70.50
▶	57-533-6-286	Wax Coated	286°F/141°C	\$70.50
▶	57-533-8-135	Wax over Lead Coated	135°F/57°C	\$92.50
▶	57-533-8-155	Wax over Lead Coated	155°F/68°C	\$92.50
▶	57-533-8-175	Wax over Lead Coated	175°F/79°C	\$92.50
▶	57-533-8-200	Wax over Lead Coated	200°F/93°C	\$92.50
▶	57-533-8-286	Wax over Lead Coated	286°F/141°C	\$92.50
<b>Pendent Version</b>				
For pendent TY-B with S2 Shield, order the pendent TY-B sprinkler (57-571-X-XXX) and the S2 deflector shield and O-Ring assembly separately				
	56-070-9-332	1/2" NPT, S2 Pendent Shield and O-Ring Assembly		\$7.50
<b>Sprinkler Wrench</b>				
	56-000-6-387	W-Type 6 Wrench		\$48.75
<b>Technical Data Sheet: TFP351</b>				

Section 1  
Standard Spray Sprinklers

Section 2  
Extended Coverage Sprinklers

Section 3  
Storage Sprinklers

Section 4  
Residential Products

Section 5  
Dry Sprinklers

Section 6  
Special Sprinklers

Section 7  
Nozzles and Sprinkler Accessories

Items marked "C.O." are made to order and may require longer delivery times. Please contact customer service for availability.

See latest Technical Data Sheets for specific Approvals, Listings, Design Parameters & available finishes. Sprinkler heads & escutcheons are priced separately unless otherwise noted.



**TY-B, 5mm Bulb, K=8.0, 3/4" NPT, Standard Response, Intermediate Level Upright and Pendent Sprinkler w/Shield**

50 Box Quantity (30 lbs/box) (Upright - SIN TY4153), (Pendent TY4251)

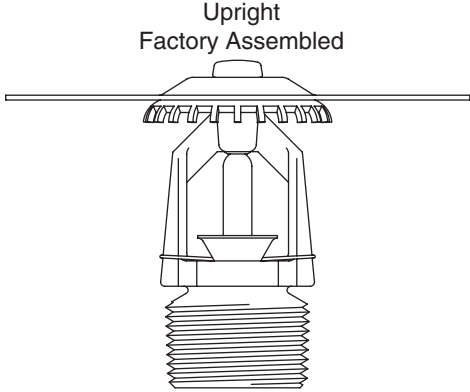
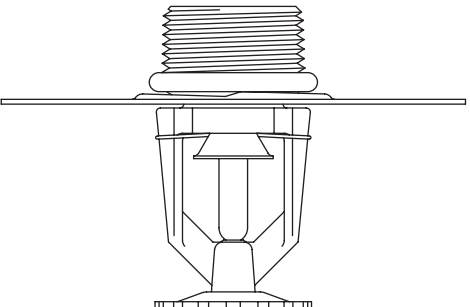
	C.O.	Upright w/Shield	Finish	Temperature	List Price
 <p>Upright Factory Assembled</p>  <p>*Pendent Shown Field Assembled (Order 57-591-X-XXX Sprinkler and Shield Assembly Separately)</p>	▶	<b>57-543-1-135</b>	Brass	135°F/57°C	\$30.75
		<b>57-543-1-155</b>	Brass	155°F/68°C	\$30.75
	▶	<b>57-543-1-175</b>	Brass	175°F/79°C	\$30.75
		<b>57-543-1-200</b>	Brass	200°F/93°C	\$30.75
		<b>57-543-1-286</b>	Brass	286°F/141°C	\$30.75
	▶	<b>57-543-1-360</b>	Brass	360°F/182°C	\$33.50
	▶	<b>57-543-7-135</b>	Lead Coated	135°F/57°C	\$78.75
	▶	<b>57-543-7-155</b>	Lead Coated	155°F/68°C	\$78.75
	▶	<b>57-543-7-175</b>	Lead Coated	175°F/79°C	\$78.75
	▶	<b>57-543-7-200</b>	Lead Coated	200°F/93°C	\$78.75
	▶	<b>57-543-7-286</b>	Lead Coated	286°F/141°C	\$78.75
	▶	<b>57-543-6-155</b>	Wax Coated	155°F/68°C	\$74.50
	▶	<b>57-543-6-175</b>	Wax Coated	175°F/79°C	\$74.50
	▶	<b>57-543-6-200</b>	Wax Coated	200°F/93°C	\$74.50
	▶	<b>57-543-6-286</b>	Wax Coated	286°F/141°C	\$74.50
	▶	<b>57-543-8-135</b>	Wax over Lead Coated	135°F/57°C	\$97.75
	▶	<b>57-543-8-155</b>	Wax over Lead Coated	155°F/68°C	\$97.75
	▶	<b>57-543-8-175</b>	Wax over Lead Coated	175°F/79°C	\$97.75
	▶	<b>57-543-8-200</b>	Wax over Lead Coated	200°F/93°C	\$97.75
	▶	<b>57-543-8-286</b>	Wax over Lead Coated	286°F/141°C	\$97.75
<b>Pendent Version</b>					
For pendent TY-B with S2 Shield, order the pendent TY-B sprinkler (57-591-X-XXX) and the S2 deflector shield and O-Ring Assembly separately					
	<b>56-070-9-342</b>	3/4" NPT, S2 Pendent Shield & O-Ring Assembly			\$7.50
<b>Sprinkler Wrench</b>					
	<b>56-000-6-387</b>	W-Type 6 Wrench			\$48.75
<b>Technical Data Sheet: TFP351</b>					

Section 1	Standard Spray Sprinklers
Section 2	Extended Coverage Sprinklers
Section 3	Storage Sprinklers
Section 4	Residential Products
Section 5	Dry Sprinklers
Section 6	Special Sprinklers
Section 7	Nozzles and Sprinkler Accessories

See latest Technical Data Sheets for specific Approvals, Listings, Design Parameters & available finishes. Sprinkler heads & escutcheons are priced separately unless otherwise noted.

Items marked "C.O." are made to order and may require longer delivery times. Please contact customer service for availability.

**TY-FRB, 3mm Bulb, K=5.6, 1/2" NPT, Quick Response,  
Intermediate Level Upright and Pendent Sprinklers w/Shield**

50 Box Quantity (28 lbs/box) - (Upright - SIN TY3133), (Pendent - SIN TY3231)

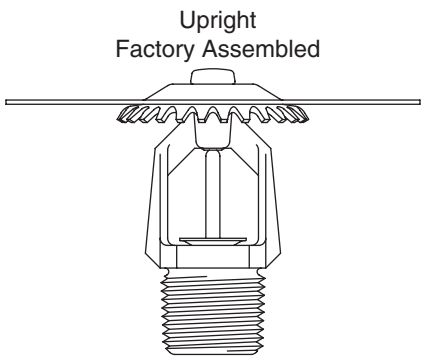
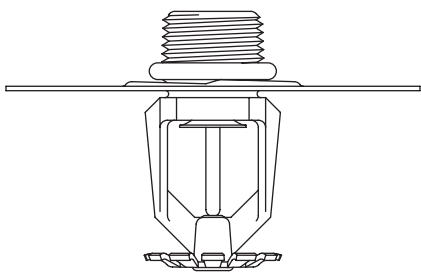
	C.O.	Upright w/Shield	Description	Temperature	Price
 <p>Upright Factory Assembled</p>	▶	<b>57-333-1-135</b>	Brass	135°F/57°C	\$40.00
		<b>57-333-1-155</b>	Brass	155°F/68°C	\$40.50
	▶	<b>57-333-1-175</b>	Brass	175°F/79°C	\$40.50
		<b>57-333-1-200</b>	Brass	200°F/93°C	\$40.50
		<b>57-333-1-286</b>	Brass	286°F/141°C	\$40.50
	▶	<b>57-333-7-135</b>	Lead Coated	135°F/57°C	\$97.25
	▶	<b>57-333-7-155</b>	Lead Coated	155°F/68°C	\$97.25
	▶	<b>57-333-7-175</b>	Lead Coated	175°F/79°C	\$97.25
	▶	<b>57-333-7-200</b>	Lead Coated	200°F/93°C	\$97.25
	▶	<b>57-333-7-286</b>	Lead Coated	286°F/141°C	\$97.25
<b>Pendent Version</b>					
For pendent TY-FRB with Shield, order the pendent TY-FRB sprinkler (57-371-X-XXX) and the deflector shield and O-Ring Assembly separately					
		<b>56-070-9-332</b>	1/2" NPT, S2 Pendent Shield and O-Ring Assembly		\$7.50
<b>Sprinkler Wrench</b>					
		<b>56-000-6-387</b>	W-Type 6 Wrench		\$48.75
<p>*Pendent Shown Field Assembled (Order 57-371-X-XXX Sprinkler and Shield Assembly Separately)</p>					
<b>Technical Data Sheet: TFP356</b>					

Items marked "C.O." are made to order and may require longer delivery times. Please contact customer service for availability.

See latest Technical Data Sheets for specific Approvals, Listings, Design Parameters & available finishes. Sprinkler heads & escutcheons are priced separately unless otherwise noted.

**TY-FRB, 3mm Bulb, K=8.0, 3/4" NPT Quick Response,  
Intermediate Level Upright and Pendent Sprinklers w/Shield**

50 Box Quantity (30 lbs/box) - (Upright - SIN TY4133), (Pendent - SIN TY4231)

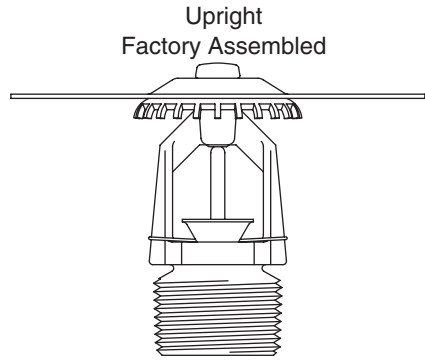

Upright  
Factory Assembled

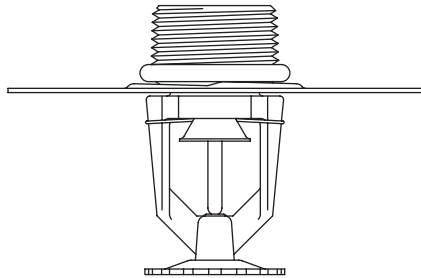

\*Pendent Shown Field Assembled  
(Order 57-391-X-XXX Sprinkler  
and Shield Assembly Separately)

C.O.	Upright w/Shield	Description	Temperature	Price
▶	57-343-1-135	Brass	135°F/57°C	\$44.25
	57-343-1-155	Brass	155°F/68°C	\$44.25
▶	57-343-1-175	Brass	175°F/79°C	\$44.25
	57-343-1-200	Brass	200°F/93°C	\$44.25
	57-343-1-286	Brass	286°F/141°C	\$44.25
▶	57-343-7-135	Lead Coated	135°F/57°C	\$108.00
▶	57-343-7-155	Lead Coated	155°F/68°C	\$108.00
▶	57-343-7-175	Lead Coated	175°F/79°C	\$108.00
▶	57-343-7-200	Lead Coated	200°F/93°C	\$108.00
▶	57-343-7-286	Lead Coated	286°F/141°C	\$108.00
<b>Pendent Version</b>				
For pendent TY-FRB with Shield, order the pendent TY-FRB sprinkler (57-391-X-XXX) and the deflector shield and O-Ring Assembly separately				
	56-070-9-342	3/4" NPT Pendent Shield & O-Ring Assembly		\$7.50
<b>Sprinkler Wrench</b>				
	56-000-6-387	W-Type 6 Wrench		\$48.75

Technical Data Sheet: TFP356

Section 1  
Standard Spray Sprinklers

Section 2  
Extended Coverage Sprinklers

Section 3  
Storage Sprinklers

Section 4  
Residential Products

Section 5  
Dry Sprinklers

Section 6  
Special Sprinklers

Section 7  
Nozzles and Sprinkler Accessories

See latest Technical Data Sheets for specific Approvals, Listings, Design Parameters & available finishes. Sprinkler heads & escutcheons are priced separately unless otherwise noted.

Items marked "C.O." are made to order and may require longer delivery times. Please contact customer service for availability.

**TY-L, K=5.6, 1/2" NPT, Standard Response  
Intermediate Level Upright and Pendent Sprinklers w/Shield**

(Upright - SIN TY3113), (Pendent - SIN TY3211)

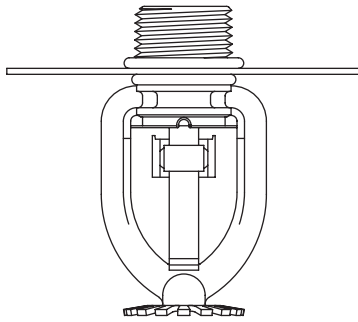
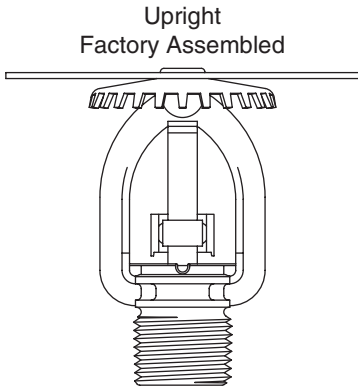

C.O.	Upright w/Shield	Description	Temperature	Price
▶	53-253-1-135	Brass	135°F/57°C	\$31.50
	53-253-1-165	Brass	165°F (74°C)	\$31.50
▶	53-253-1-212	Brass	212°F/100°C	\$31.50
	53-253-1-280	Brass	280°F/138°C	\$31.50

**Pendent Version**

For pendent TY-L with Shield, order the pendent TY-L sprinkler (53-112-X-XXX) and the deflector shield and O-Ring Assembly separately

	56-015-6-802	1/2" TY-L Shield Package (Shield/O-Ring)		\$7.50
--	--------------	--	--	--------

**Sprinkler Wrench**

	56-000-1-849	W-Type 9 Wrench		\$43.50
--	--------------	-----------------	--	---------

Technical Data Sheet: TFP350

Section 1  
Standard Spray Sprinklers

Section 2  
Extended Coverage Sprinklers

Section 3  
Storage Sprinklers

Section 4  
Residential Products

Section 5  
Dry Sprinklers

Section 6  
Special Sprinklers

Section 7  
Nozzles and Sprinkler Accessories

Items marked "C.O." are made to order and may require longer delivery times. Please contact customer service for availability.

See latest Technical Data Sheets for specific Approvals, Listings, Design Parameters & available finishes. Sprinkler heads & escutcheons are priced separately unless otherwise noted.

**TY-L, K=8.0, 3/4" NPT, Standard Response  
Intermediate Level Upright and Pendent Sprinklers w/Shield**

(Upright - SIN TY4113), (Pendent - SIN TY4211)

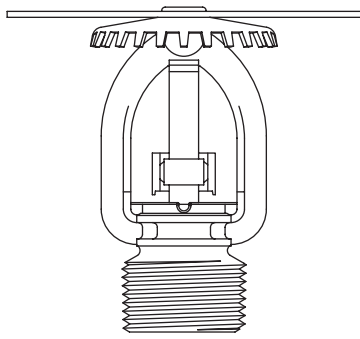
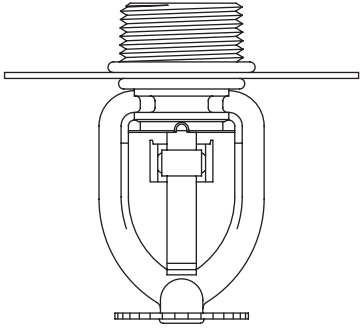
	<i>C.O.</i>	<i>Upright w/Shield</i>	<i>Description</i>	<i>Temperature</i>	<i>Price</i>
 <p>Upright Factory Assembled</p>	▶	<b>53-153-1-135</b>	Brass	135°F/57°C	\$43.75
		<b>53-153-1-165</b>	Brass	165°F (74°C)	\$43.75
	▶	<b>53-153-1-212</b>	Brass	212°F/100°C	\$43.75
		<b>53-153-1-280</b>	Brass	280°F/138°C	\$43.75
<b>Pendent Version</b>					
<p><b>For pendent TY-L with Shield</b>, order the pendent TY-L sprinkler (53-102-X-XXX) and the deflector shield and O-Ring separately</p>					
		<b>56-015-6-803</b>	3/4" TY-L Shield Package (Shield/(2)O-Ring)		\$7.50
<b>Sprinkler Wrench</b>					
		<b>56-000-1-849</b>	W-Type 9 Wrench		\$43.50
 <p>Pendent Field Assembled (order separately) 53-102-X-XXX Sprinkler Shield</p>	<b>Technical Data Sheet: TFP350</b>				

Section 1  
Standard Spray Sprinklers

Section 2  
Extended Coverage Sprinklers

Section 3  
Storage Sprinklers

Section 4  
Residential Products

Section 5  
Dry Sprinklers

Section 6  
Special Sprinklers

Section 7  
Nozzles and Sprinkler Accessories

See latest Technical Data Sheets for specific Approvals, Listings, Design Parameters & available finishes. Sprinkler heads & escutcheons are priced separately unless otherwise noted.

Items marked "C.O." are made to order and may require longer delivery times. Please contact customer service for availability.

**TY-FRL, K=5.6, 1/2" Male NPT, Quick Response,  
Intermediate Level Upright and Pendent Sprinkler w/Shield**

(Upright - SIN TY3123), (Pendent - SIN TY3221)

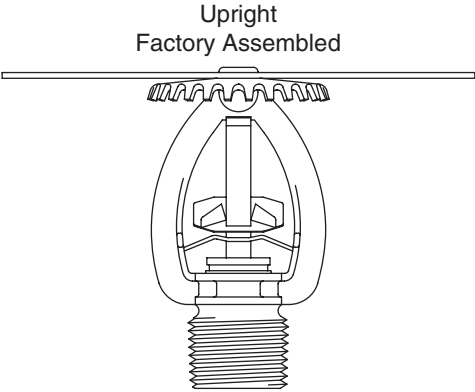
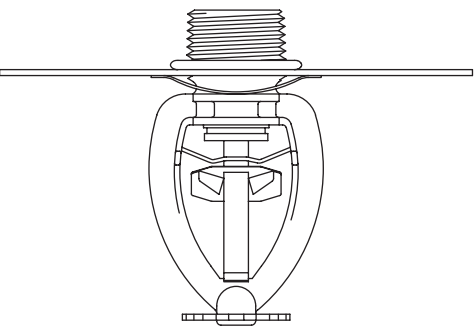
	<i>C.O.</i>	<i>Upright w/Shield</i>	<i>Description</i>	<i>Temperature</i>	<i>Price</i>
 <p>Upright Factory Assembled</p>		<b>58-986-1-165</b>	Brass	165°F (74°C)	\$63.50
	<p align="center"><b>Pendent Version</b></p> <p><b>For pendent TY-FRL with Shield, order the pendent TY-FRL sprinkler (57-982-X-XXX) and the deflector shield and O-Ring Assembly separately</b></p>				
 <p>*Pendent Shown Field Assembled (Order 57-972-X-XXX Sprinkler and Shield Assembly Separately)</p>		<b>56-952-1-001</b>	Brass 1/2" NPT, Pendent Shield /O-Ring/Speed Nut assembly		\$7.50
	<p align="center"><b>Sprinkler Wrench</b></p>				
		<b>56-000-1-849</b>	W-Type 9 Wrench		\$43.50
<b>Technical Data Sheet: TFP355</b>					

Section 1  
Standard Spray Sprinklers

Section 2  
Extended Coverage Sprinklers

Section 3  
Storage Sprinklers

Section 4  
Residential Products

Section 5  
Dry Sprinklers

Section 6  
Special Sprinklers

Section 7  
Nozzles and Sprinkler Accessories

Items marked "C.O." are made to order and may require longer delivery times. Please contact customer service for availability.

See latest Technical Data Sheets for specific Approvals, Listings, Design Parameters & available finishes. Sprinkler heads & escutcheons are priced separately unless otherwise noted.

**TY-FRL, K=8.0, 3/4" NPT, Quick Response,  
Intermediate Level Upright and Pendent Sprinkler w/Shield**

(Upright - SIN TY4123), (Pendent - SIN TY4221)

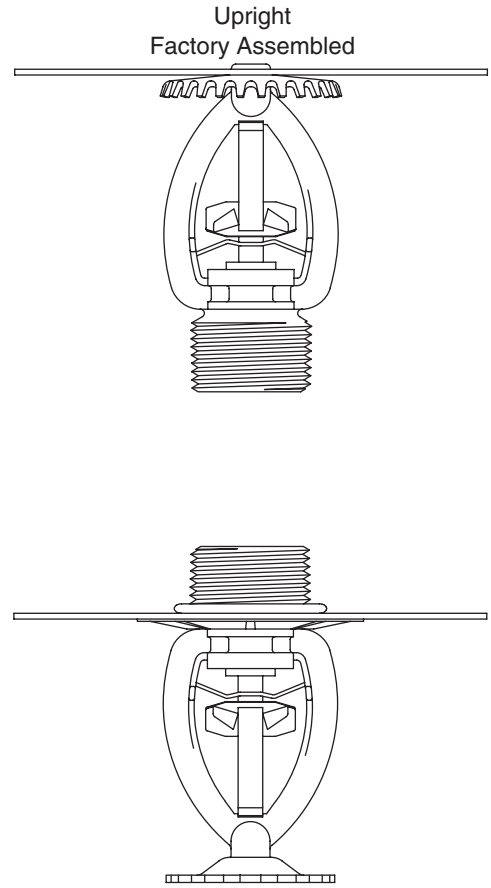
	<i>C.O.</i>	<i>Upright w/Shield</i>	<i>Description</i>	<i>Temperature</i>	<i>Price</i>	
 <p>Upright Factory Assembled</p> <p>*Pendent Shown Field Assembled (Order 58-172-X-XXX Sprinkler and Shield Assembly Separately)</p>		<b>58-153-1-165</b>	Brass	165°F (74°C)	\$73.50	
	<b>Pendent Version</b>					
	<b>For pendent TY-FRL with Shield</b> , order the pendent TY-FRL sprinkler (58-172-X-XXX) and the deflector shield and O-Ring Assembly separately					
			<b>56-152-1-001</b>	3/4" Shield Assy. Brass/O-Ring/Speed Nut		\$7.50
	<b>Sprinkler Wrench</b>					
		<b>56-000-1-849</b>	W-Type 9 Wrench		\$43.50	

Technical Data Sheet: TFP355

Section 1	Standard Spray Sprinklers
Section 2	Extended Coverage Sprinklers
Section 3	Storage Sprinklers
Section 4	Residential Products
Section 5	Dry Sprinklers
Section 6	Special Sprinklers
Section 7	Nozzles and Sprinkler Accessories

See latest Technical Data Sheets for specific Approvals, Listings, Design Parameters & available finishes. Sprinkler heads & escutcheons are priced separately unless otherwise noted.

Items marked "C.O." are made to order and may require longer delivery times. Please contact customer service for availability.



Section 1 Standard Spray Sprinklers
Section 2 Extended Coverage Sprinklers
Section 3 Storage Sprinklers
Section 4 Residential Products
Section 5 Dry Sprinklers
Section 6 Special Sprinklers
Section 7 Nozzles and Sprinkler Accessories

Items marked "C.O." are made to order and may require longer delivery times.  
Please contact customer service for availability.

**Supersedes 3/4/2011**

See latest Technical Data Sheets for specific Approvals, Listings,  
Design Parameters & available finishes. Sprinkler heads & escutcheons  
are priced separately unless otherwise noted.

**LF II - Low Flow Pendant, Fast Response, K=3.0 1/2" N.P.T.**

100 Box Quantity (Pendent 20 lbs/box (SIN TY1234))

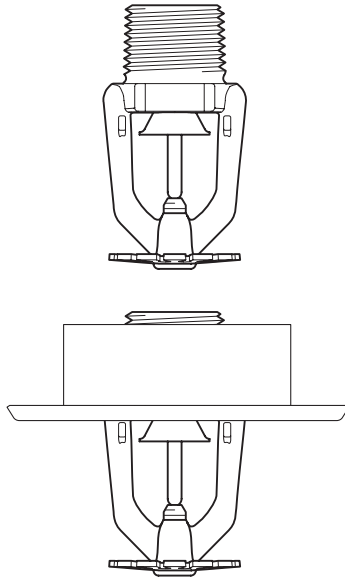

C.O.	Number	Model	Finish	Temperature	List Price
	51-010-1-155	LFII Pendent	Brass	155°F/68°C	\$33.50
	51-010-1-175	LFII Pendent	Brass	175°F/79°C	\$33.50
	51-010-9-155	LFII Pendent	Chrome	155°F/68°C	\$37.25
	51-010-9-175	LFII Pendent	Chrome	175°F/79°C	\$37.25
	51-010-4-155	LFII Pendent	White	155°F/68°C	\$37.25
	51-010-4-175	LFII Pendent	White	175°F/79°C	\$37.25
<b>Recessed Escutcheons (Order Separately)</b>					
▶	56-705-2-010	1/2" Bright Brass (Style 20)			\$9.05
	56-705-9-010	1/2" Chrome Plated (Style 20)			\$6.25
	56-705-4-010	1/2" White (Style 20)			\$6.25
<b>Sprinkler Wrench</b>					
	56-000-6-387	W-Type 6 Wrench			\$48.75
	56-850-4-001	W-Type 7 Wrench (Recessed Only)			\$81.00
<b>Notes:</b>					
	92-000-0-412	Plastic Cap Protective Cover.			\$0.30
<b>Technical Data Sheet: Pendent TFP402, Design Guide: TFP490</b>					

**LF II - Low Flow Horizontal Sidewall, K=4.2(HSW), 1/2" N.P.T.**

100 Box Quantity HSW 19 lbs/box (SIN TY1334))

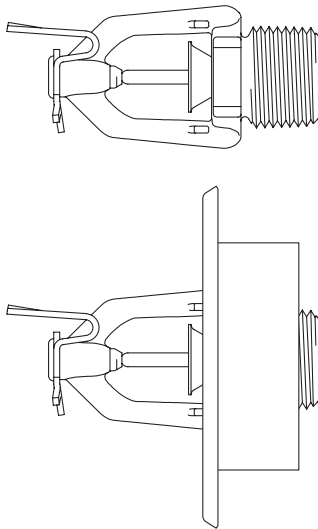

C.O.	Number	Model	Finish	Temperature	List Price
	51-211-1-155	LFII Sidewall	Brass	155°F/68°C	\$35.75
▶	51-211-1-175	LFII Sidewall	Brass	175°F/79°C	\$35.75
	51-211-9-155	LFII Sidewall	Chrome	155°F/68°C	\$37.75
▶	51-211-9-175	LFII Sidewall	Chrome	175°F/79°C	\$37.75
	51-211-4-155	LFII Sidewall	White	155°F/68°C	\$37.75
▶	51-211-4-175	LFII Sidewall	White	175°F/79°C	\$37.75
<b>Recessed Escutcheons (Order Separately)</b>					
▶	56-705-2-010	1/2" Bright Brass (Style 20)			\$9.05
	56-705-9-010	1/2" Chrome Plated (Style 20)			\$6.25
	56-705-4-010	1/2" White (Style 20)			\$6.25
<b>Sprinkler Wrench</b>					
	56-000-6-387	W-Type 6 Wrench			\$48.75
	56-850-4-001	W-Type 7 Wrench (Recessed Only)			\$81.00
<b>Notes:</b>					
	92-000-0-412	Plastic Cap Protective Cover.			\$0.30
<b>Technical Data Sheet: TFP410, Design Guide: TFP490</b>					

See latest Technical Data Sheets for specific Approvals, Listings, Design Parameters & available finishes. Sprinkler heads & escutcheons are priced separately unless otherwise noted.

Items marked "C.O." are made to order and may require longer delivery times. Please contact customer service for availability.

Section 1  
Standard Spray Sprinklers

Section 2  
Extended Coverage Sprinklers

Section 3  
Storage Sprinklers

Section 4  
Residential Products

Section 5  
Dry Sprinklers

Section 6  
Special Sprinklers

Section 7  
Nozzles and Sprinkler Accessories

**LF II - Low Flow Horizontal Sidewall, K=4.4, 1/2" N.P.T.**

SIN TY2334

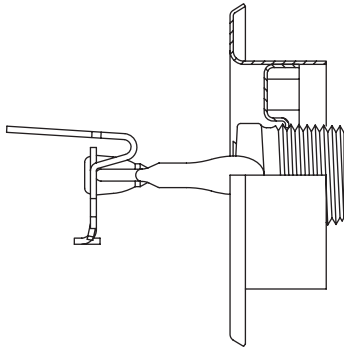
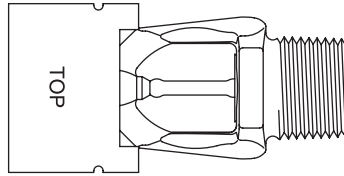

C.O.	Number	Model	Finish	Temperature	List Price
	51-215-1-155	LFII Sidewall	Brass	155°F/68°C	\$35.75
▶	51-215-1-175	LFII Sidewall	Brass	175°F/79°C	\$35.75
	51-215-9-155	LFII Sidewall	Chrome	155°F/68°C	\$37.75
▶	51-215-9-175	LFII Sidewall	Chrome	175°F/79°C	\$37.75
	51-215-4-155	LFII Sidewall	White	155°F/68°C	\$37.75
▶	51-215-4-175	LFII Sidewall	White	175°F/79°C	\$37.75
<b>Recessed Escutcheons (Order Separately)</b>					
▶	56-705-2-010	1/2" Bright Brass (Style 20)			\$9.05
	56-705-9-010	1/2" Chrome Plated (Style 20)			\$6.25
	56-705-4-010	1/2" White (Style 20)			\$6.25
<b>Sprinkler Wrench</b>					
	56-000-6-387	W-Type 6 Wrench			\$48.75
	56-850-4-001	W-Type 7 Wrench (Recessed Only)			\$81.00
<b>Notes:</b>					
	92-000-0-412	Plastic Cap Protective Cover.			\$0.30

**Technical Data Sheet: TFP412, Design Guide: TFP490**

**LF II - Low Flow Pendant, K=4.9 (pendent), 1/2" N.P.T.**

100 Box Quantity (Pendent 20 lbs/box (SIN TY2234))

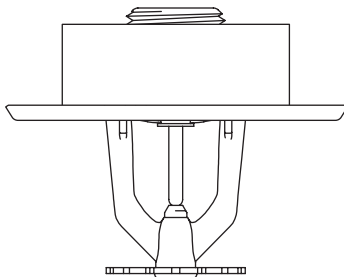

C.O.	Number	Model	Finish	Temperature	List Price
	51-201-1-155	LFII Pendent	Brass	155°F/68°C	\$33.50
▶	51-201-1-175	LFII Pendent	Brass	175°F/79°C	\$33.50
	51-201-9-155	LFII Pendent	Chrome	155°F/68°C	\$37.25
▶	51-201-9-175	LFII Pendent	Chrome	175°F/79°C	\$37.25
	51-201-4-155	LFII Pendent	White	155°F/68°C	\$37.25
▶	51-201-4-175	LFII Pendent	White	175°F/79°C	\$37.25
<b>Recessed Escutcheons (Order Separately)</b>					
▶	56-705-2-010	1/2" Bright Brass (Style 20)			\$9.05
	56-705-9-010	1/2" Chrome Plated (Style 20)			\$6.25
	56-705-4-010	1/2" White (Style 20)			\$6.25
<b>Sprinkler Wrench</b>					
	56-000-6-387	W-Type 6 Wrench			\$48.75
	56-850-4-001	W-Type 7 Wrench (Recessed Only)			\$81.00
<b>Notes:</b>					
	92-000-0-412	Plastic Cap Protective Cover.			\$0.30

**Technical Data Sheet: Pendent TFP400,  
HSW TFP410, Design Guide: TFP490**

Items marked "C.O." are made to order and may require longer delivery times. Please contact customer service for availability.

See latest Technical Data Sheets for specific Approvals, Listings, Design Parameters & available finishes. Sprinkler heads & escutcheons are priced separately unless otherwise noted.

**LFII - Residential Concealed Pendent Sprinkler, Domed Plate, K=4.9, 1/2" N.P.T.**

(SIN TY2234)

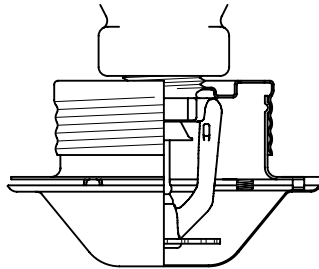

**Note: All "Special Order" cover plates are special ordered and are Non-Returnable. Please see "Terms & Conditions"**

C.O.	Number	Model	Finish	Temperature	List Price
	<b>51-873-1-155</b>	LFII Pendent Sprinkler	Brass	155°F/68°C	\$48.25
<b>Cover Plates (Order Separately)</b>					
	<b>56-873-9-135</b>	LFII Cover Plate	Chrome	135°F/57°C	\$24.25
	<b>56-873-4-135</b>	LFII Cover Plate	Signal (Bright) White	135°F/57°C	\$24.25
	<b>56-873-X-135</b>	LFII Cover Plate	Special Order*	135°F/57°C	\$26.75
<b>Sprinkler Wrench</b>					
	<b>56-850-4-001</b>	W-Type 7 Wrench			\$81.00
<b>Notes</b>					
	<b>6012</b>	*Special Order paint match subject to set-up charge. (Net Price)			\$376.50
<b>Technical Data Sheet: TFP450 Design Guide: TFP490</b>					

Section 1  
Standard Spray Sprinklers

Section 2  
Extended Coverage Sprinklers

**LFII - Residential Flat-Plate Concealed Pendent Sprinkler, K=4.9, 1/2" N.P.T.**

(SIN TY2524)

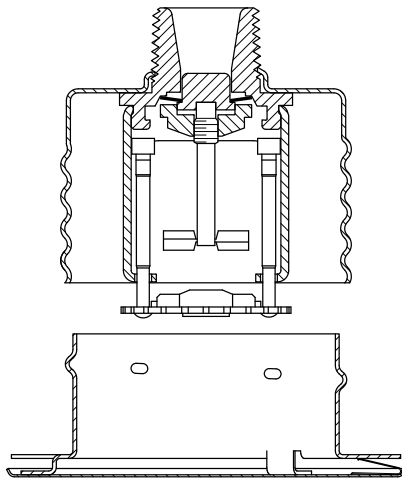

**Note: All "Special Order" cover plates are special ordered and are Non-Returnable. Please see "Terms & Conditions"**

C.O.	Number	Model	Finish	Temperature	List Price
	<b>51-114-1-160</b>	LFII Pendent Sprinkler	Brass	160°F/71°C	\$55.00
<b>Cover Plates (Order Separately)</b>					
	<b>56-201-4-135</b>	LFII Cover Plate	Signal (Bright) White	135°F/57°C	\$22.25
	<b>56-201-3-135</b>	LFII Cover Plate	Pure White (RAL 9010)	135°F/57°C	\$22.25
	<b>56-201-X-135</b>	LFII Cover Plate	Special Order*	135°F/57°C	\$22.25
<b>Sprinkler Wrench</b>					
	<b>56-000-1-265</b>	W-Type 18 Wrench			\$81.00
<b>Notes</b>					
	<b>6012</b>	*Special Order paint match subject to set-up charge. (Net Price).			\$376.50
<b>Technical Data Sheet: TFP443 Design Guide: TFP490</b>					

Section 3  
Storage Sprinklers

Section 4  
Residential Products

Section 5  
Dry Sprinklers

Section 6  
Special Sprinklers

Section 7  
Nozzles and Sprinkler Accessories

See latest Technical Data Sheets for specific Approvals, Listings, Design Parameters & available finishes. Sprinkler heads & escutcheons are priced separately unless otherwise noted.

Items marked "C.O." are made to order and may require longer delivery times. Please contact customer service for availability.

Section 1  
Standard Spray Sprinklers

Section 2  
Extended Coverage Sprinklers

Section 3  
Storage Sprinklers

Section 4  
Residential Products

Section 5  
Dry Sprinklers

Section 6  
Special Sprinklers

Section 7  
Nozzles and Sprinkler Accessories

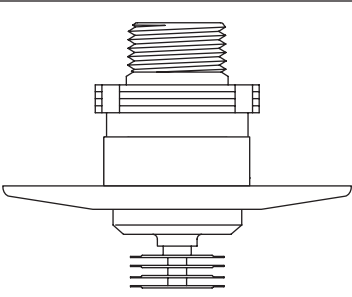
<b>Model LFII, K=4.2, Residential Flush Pendent</b>					
(SIN TY2284)					
	<i>C.O.</i>	<i>Pendent</i>	<i>Finish</i>	<i>Temperature</i>	<i>List Price</i>
		<b>51-123-0-162</b>	Chrome	162°F (72°C)	\$69.50
		<b>51-123-4-162</b>	White	162°F (72°C)	\$69.50
		<b>51-123-6-162</b>	Black	162°F (72°C)	\$82.50
		<b>51-123-1-162</b>	Antique Brass	162°F (72°C)	\$82.50
<b>Trim Plates (Order Separately)</b>					
		<b>56-123-9-001</b>	Chrome Escutcheon		\$7.25
		<b>56-123-4-001</b>	White Escutcheon		\$7.25
		<b>56-123-6-001</b>	Black Escutcheon		\$7.25
		<b>56-123-1-001</b>	Antique Brass Escutcheon		\$7.25
<b>Sprinkler Wrench</b>					
		<b>56-000-4-947</b>	Wrench (Socket Only)		\$86.50
		<b>56-000-4-948</b>	Socket/Ratchet Wrench		\$128.50
		<b>56-000-4-300</b>	Protective Cover Removal Tool		\$28.50
<b>Technical Data Sheet: TFP420 Design Guide: TFP490</b>					

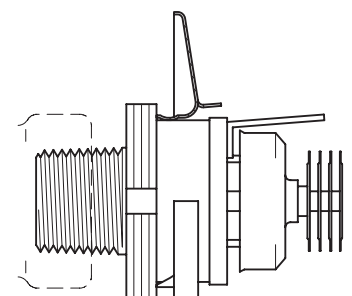
<b>Model LFII, K=4.2, Residential Flush Horizontal Sidewall Sprinkler</b>					
(SIN TY2384)					
	<i>C.O.</i>	<i>Horizontal Sidewall</i>	<i>Finish</i>	<i>Temperature</i>	<i>List Price</i>
		<b>51-124-9-162</b>	Chrome	162°F (72°C)	\$69.50
		<b>51-124-4-162</b>	White	162°F (72°C)	\$69.50
		<b>51-124-5-162</b>	Black	162°F (72°C)	\$82.50
	<b>Trim Plates (Order Separately)</b>				
		<b>56-124-9-001</b>	Chrome Escutcheon		\$7.25
		<b>56-124-4-001</b>	White Escutcheon		\$7.25
		<b>56-124-5-001</b>	Black Escutcheon		\$7.25
<b>Sprinkler Wrench</b>					
		<b>56-000-4-949</b>	Wrench (Socket Only)		\$86.50
		<b>56-000-4-950</b>	Socket/Ratchet Wrench		\$128.50
		<b>56-000-4-300</b>	Protective Cover Removal Tool		\$28.50
<b>Technical Data Sheet: TFP425 Design Guide: TFP490</b>					

Items marked "C.O." are made to order and may require longer delivery times. Please contact customer service for availability.

See latest Technical Data Sheets for specific Approvals, Listings, Design Parameters & available finishes. Sprinkler heads & escutcheons are priced separately unless otherwise noted.

**Model LFII, K=5.8 & K=5.6, Residential,  
NFPA 13 Optimized Horizontal Sidewall Sprinklers**

(K=5.8 SIN TY4334)(K=5.6 SIN TY3334)

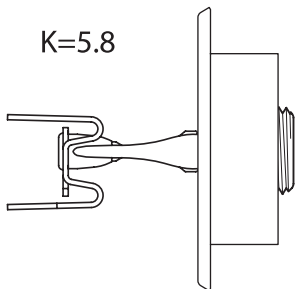
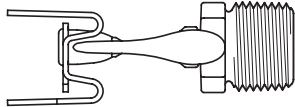
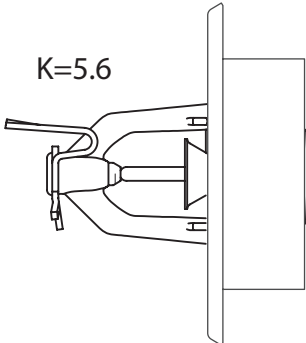
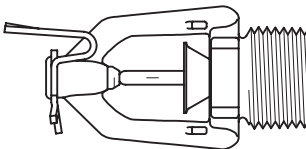
	C.O.	K=5.8 Part Numbers	K=5.6 Part Numbers	Finish	Temperature	List Price
 <p>K=5.8</p>		51-534-1-155	51-524-1-155	Brass	155°F (68°C)	\$40.25
		51-534-1-175	51-524-1-175	Brass	175°F (79°C)	\$40.25
		51-534-9-155	51-524-9-155	Chrome	155°F (68°C)	\$40.25
		51-534-9-175	51-524-9-175	Chrome	175°F (79°C)	\$40.25
		51-534-4-155	51-524-4-155	White	155°F (68°C)	\$40.25
		51-534-4-175	51-524-4-175	White	175°F (79°C)	\$40.25
<b>Recessed Escutcheons (Order Separately)</b>						
		56-705-2-010	1/2" Brass Plated (Style 20)			\$9.05
		56-705-9-010	1/2" Chrome Plated (Style 20)			\$6.25
		56-705-4-010	1/2" White Color Plated (Style 20)			\$6.25
<b>Sprinkler Wrench</b>						
		56-000-6-387	W-Type 6 Sprinkler Wrench			\$48.75
		56-850-4-001	W-Type 7 Sprinkler Wrench			\$81.00
 <p>K=5.6</p>	<b>Technical Data Sheet: K=5.8 - TFP417, K=5.6 - TFP415</b> <b>Design Guide: TFP490</b>					
						

Section 1  
Standard Spray Sprinklers

Section 2  
Extended Coverage Sprinklers

Section 3  
Storage Sprinklers

Section 4  
Residential Products

Section 5  
Dry Sprinklers

Section 6  
Special Sprinklers

Section 7  
Nozzles and Sprinkler Accessories

See latest Technical Data Sheets for specific Approvals, Listings, Design Parameters & available finishes. Sprinkler heads & escutcheons are priced separately unless otherwise noted.

Items marked "C.O." are made to order and may require longer delivery times. Please contact customer service for availability.

**LFII - Residential NFPA 13 Optimized Pendent,  
Recessed and Concealed Sprinklers, K=6.9, 3/4" N.P.T.**

100 Box Quantity (SIN TY4234)

C.O.	Number	Model	Finish	Temperature	List Price
	51-069-1-155	LFII Pendent Sprinkler	Brass	155°F/68°C	\$39.00
	51-069-1-175	LFII Pendent Sprinkler	Brass	175°F/79°C	\$39.00
	51-069-9-155	LFII Pendent Sprinkler	Chrome	155°F/68°C	\$41.50
	51-069-9-175	LFII Pendent Sprinkler	Chrome	175°F/79°C	\$41.50
	51-069-4-155	LFII Pendent Sprinkler	White	155°F/68°C	\$41.50
	51-069-4-175	LFII Pendent Sprinkler	White	175°F/79°C	\$41.50
	51-068-1-155	LFII Concealed Pendent Sprinkler		155°F/68°C	\$50.00
	51-068-1-175	LFII Concealed Pendent Sprinkler		175°F/79°C	\$50.00
<b>Cover Plates (Order Separately)</b>					
	56-873-9-135	LFII Cover Plate	Chrome	135°F/57°C	\$24.25
	56-873-0-135	LFII Cover Plate	Grey White	135°F/57°C	\$24.25
	56-873-4-135	LFII Cover Plate	Signal (Bright) White	135°F/57°C	\$24.25
	56-873-X-135	LFII Cover Plate	Special Order*	135°F/57°C	\$26.75
<b>Recessed Escutcheons (Order Separately)</b>					
	56-705-2-011	3/4" Bright Brass (Style 30)			\$9.05
	56-705-9-011	3/4" Chrome Plated (Style 30)			\$6.50
	56-705-4-011	3/4" White (Style 30)			\$6.50
<b>Sprinkler Wrench</b>					
	56-000-6-387	W-Type 6 Wrench			\$48.75
	56-850-4-001	W-Type 7 Wrench (Recessed & Concealed Only)			\$81.00
<b>Notes</b>					
	6012	*Special Order paint match subject to set-up charge. (Net Price)			\$376.50

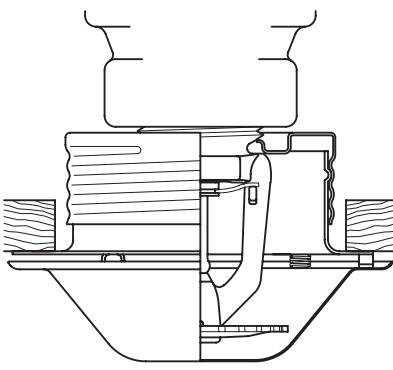
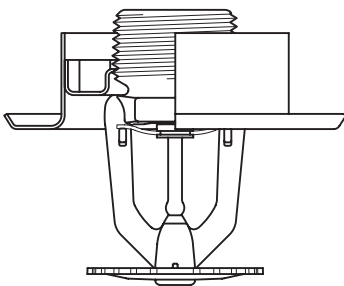
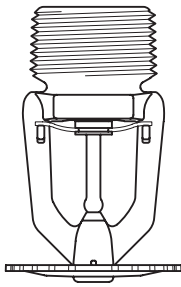

**Note: All "Special Order" cover plates are special ordered and are Non-Returnable. Please see "Terms & Conditions"**

**Technical Data Sheet: TFP408**

Section 1  
Standard Spray Sprinklers

Section 2  
Extended Coverage Sprinklers

Section 3  
Storage Sprinklers

Section 4  
Residential Products

Section 5  
Dry Sprinklers

Section 6  
Special Sprinklers

Section 7  
Nozzles and Sprinkler Accessories

Items marked "C.O." are made to order and may require longer delivery times. Please contact customer service for availability.

See latest Technical Data Sheets for specific Approvals, Listings, Design Parameters & available finishes. Sprinkler heads & escutcheons are priced separately unless otherwise noted.



Series LFII, Dry-Type, Residential  
Recessed Pendent, K=4.9, and  
Horizontal Sidewall and Recessed Horizontal Sidewall, K=4.4

P/N 63 - XXX - X - XXX

		MODEL/SIN	TEMP. RATING		SPRINKLER FINISH	RECESSED ESCUTCHEON FINISH	ORDER LENGTH (EXAMPLES)	
10	Pendent w/ Recessed Escutcheon	TY2235	1	155°F / 68°C	9	Chrome Plated	055	5.50"
12	Horizontal Sidewall with Recessed Escutcheon	TY2335	2†	175°F / 79°C	4	White Polyester Coated	082	8.25"
13	Horizontal Sidewall without Escutcheon	TY2335	† For Wet Pipe Systems Only		2	Natural Brass	180	18.00"
							187	18.75"
							240	24.00"

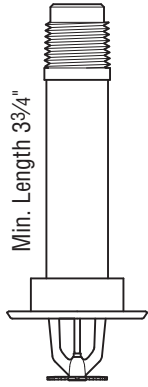
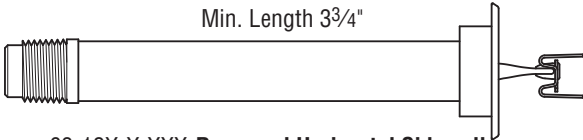
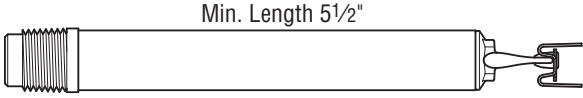
	Length (24" Max)	Pendent & HSW
 <p>63-10X-X-XXX w/Std. Escutcheon</p>	3-3/4" to 6"	\$176.00
	6-1/4" to 8"	\$185.50
	8-1/4" to 12"	\$200.00
	12-1/4" to 15"	\$208.50
	15-1/4" to 18"	\$219.50
	18-1/4" to 21"	\$229.00
	21-1/4" to 24"	\$238.00
<b>Replacement Escutcheons</b>		
56-705-2-010	1/2" Brass Plated (Style 20)	\$9.05
56-705-9-010	1/2" Chrome Plated (Style 20)	\$6.25
56-705-4-010	1/2" White Color (Style 20)	\$6.25
<b>Sprinkler Wrench (Standard Pipe Wrench for Pipe Barrel)</b>		
56-000-6-387	W-Type 6 Wrench	\$48.75
56-850-4-001	W-Type 7 Wrench (Recessed)	\$81.00
 <p>63-12X-X-XXX <b>Recessed Horizontal Sidewall</b> w/Std. Escutcheon (1" NPT)</p>		
	 <p>63-13X-X-XXX <b>Horizontal Sidewall</b> (1" NPT)</p>	
<b>Technical Data Sheets:</b> Pendent – TFP460, HSW – TFP461		

**Note: All Dry Sprinklers are special ordered and are Non-Returnable. Please see "Terms & Conditions".**

See latest Technical Data Sheets for specific Approvals, Listings, Design Parameters & available finishes. Sprinkler heads & escutcheons are priced separately unless otherwise noted.

Items marked "C.O." are made to order and may require longer delivery times. Please contact customer service for availability.

Section 1  
Standard Spray Sprinklers

Section 2  
Extended Coverage Sprinklers

Section 3  
Storage Sprinklers

Section 4  
Residential Products

Section 5  
Dry Sprinklers

Section 6  
Special Sprinklers

Section 7  
Nozzles and Sprinkler Accessories

**RAPID RESPONSE  
Model RCP-1 Residential Control Panel 1" & 1½", 175 psi**

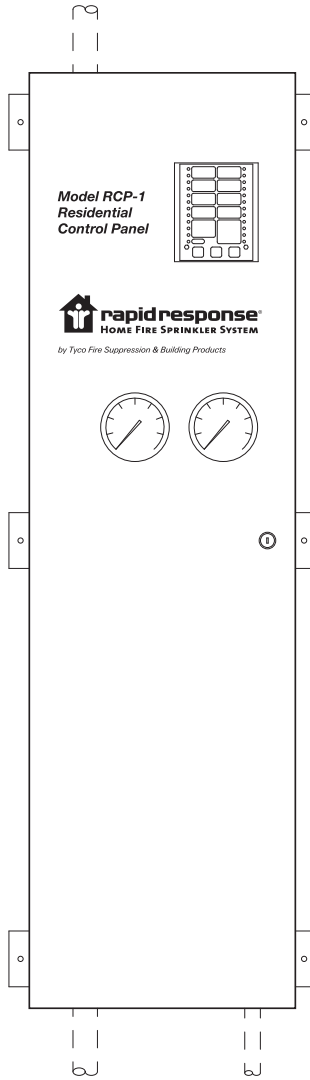

**Model RCP-1 Panel**

<i>Description</i>	<i>Part No.</i>	<i>List Price</i>
Model RCP-1 Residential Control Panel - 1"	<b>52-310-2-601</b>	POA
Model RCP-1 Residential Control Panel - 1½"	<b>52-310-2-602</b>	POA
<b>Separately Ordered Parts for Model RCP-1 Panel</b>		
Bezel for use with Model RCP-1 Residential Control Panel	<b>52-310-2-603</b>	POA
Replacement Battery (BT-80 8.0 AH Battery)	<b>2656</b>	\$79.50

**Technical Data Sheet: TFP480**

Items marked "C.O." are made to order and may require longer delivery times. Please contact customer service for availability.

See latest Technical Data Sheets for specific Approvals, Listings, Design Parameters & available finishes. Sprinkler heads & escutcheons are priced separately unless otherwise noted.

Section 1  
Standard Spray Sprinklers

Section 2  
Extended Coverage Sprinklers

Section 3  
Storage Sprinklers

Section 4  
Residential Products

Section 5  
Dry Sprinklers

Section 6  
Special Sprinklers

Section 7  
Nozzles and Sprinkler Accessories

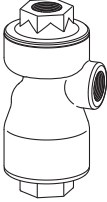
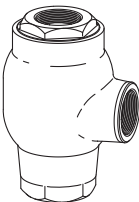
Residential Shutoff Valves			
	Description	Part No.	List Price
 <p>1" RSV-1</p>  <p>2" RSV-1</p>	1" Model RSV-1	52-540-1-001	\$998.00
	2" Model RSV-1	52-540-1-002	\$1,575.00
Technical Data Sheet - TFP980			

Section 1	Standard Spray Sprinklers
Section 2	Extended Coverage Sprinklers
Section 3	Storage Sprinklers
Section 4	Residential Products
Section 5	Dry Sprinklers
Section 6	Special Sprinklers
Section 7	Nozzles and Sprinkler Accessories

See latest Technical Data Sheets for specific Approvals, Listings, Design Parameters & available finishes. Sprinkler heads & escutcheons are priced separately unless otherwise noted.

Items marked "C.O." are made to order and may require longer delivery times. Please contact customer service for availability.

Section 1 Standard Spray Sprinklers
Section 2 Extended Coverage Sprinklers
Section 3 Storage Sprinklers
Section 4 Residential Products
Section 5 Dry Sprinklers
Section 6 Special Sprinklers
Section 7 Nozzles and Sprinkler Accessories

Items marked "C.O." are made to order and may require longer delivery times.  
Please contact customer service for availability.

**Supersedes 3/4/2011**

See latest Technical Data Sheets for specific Approvals, Listings,  
Design Parameters & available finishes. Sprinkler heads & escutcheons  
are priced separately unless otherwise noted.

**Series DS-1, Dry, Standard Coverage, Pendent, Upright & Horizontal Sidewall, SR, K=5.6, 5mm Bulb**

P/N 60 - XXX - X - XXX

96	Pendent w/Std. Escutcheon (1" NPT)
93	Pendent w/Deep Escutcheon (1" NPT)
97	Pendent w/Std. Recessed Escutcheon (1" NPT)
92	Pendent w/o Escutcheon (1" NPT)
94	Sidewall w/Std. Escutcheon (1" NPT)
53	Sidewall w/Deep Escutcheon (1" NPT)
54	Sidewall w/o Escutcheon (1" NPT)
98	Upright w/o Escutcheon (1" NPT)

C.O. Temperature	
0	135°F/57°C
1	155°F/68°C
2	175°F/79°C
3	200°F/93°C
4	286°F/141°C
5	360°F/182°C

Finish	
Sprinkler	Escutcheon
2	Brass
1	Brass
4	White
0	Chrome
9	Chrome

Length (for example)	
060	6.00"
062	6.25"
065	6.50"
067	6.75"
372	37.25"
480	48.00"

**DS-1 Standard Coverage - Standard Response**  
SIN (Upright TY3155), (Pendent TY3255), (HSW TY3355)

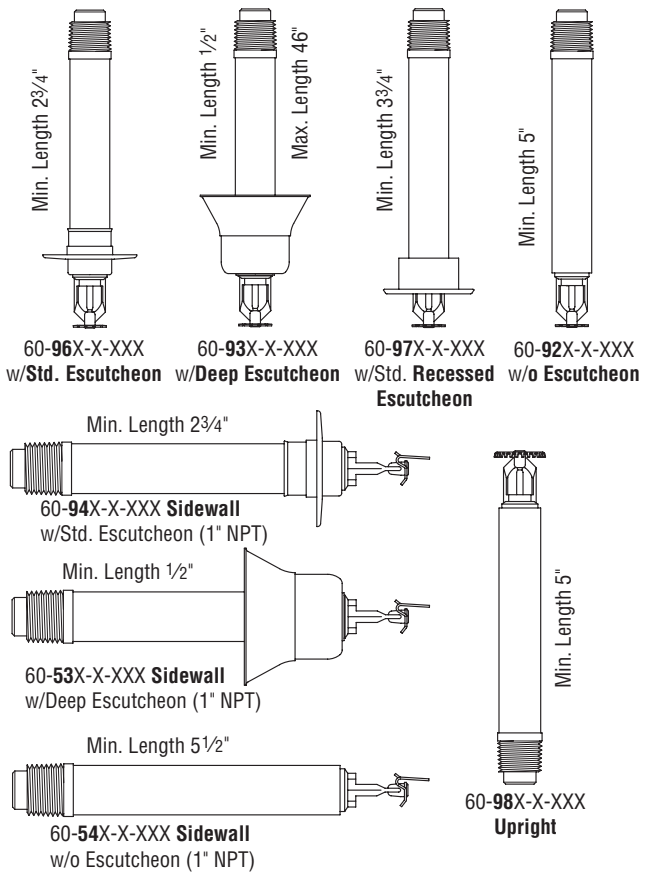

Length (48" Max)	60-98X-X-XXX Upright	60-96X-X-XXX 60-93X-X-XXX 60-97X-X-XXX 60-92X-X-XXX Pendent	60-53X-X-XXX 60-54X-X-XXX Sidewall
1/2" to 5-3/4"	\$148.50	\$148.50	\$158.00
6"	\$142.00	\$142.00	\$148.50
6-1/4" to 7-3/4"	\$158.00	\$158.00	\$166.50
8"	\$151.00	\$151.00	\$158.00
8-1/4" to 11-3/4"	\$166.50	\$166.50	\$177.50
12"	\$159.50	\$159.50	\$166.50
12-1/4" to 15"	\$185.00	\$185.00	\$196.00
15-1/4" to 18"	\$196.00	\$196.00	\$205.00
18-1/4" to 21"	\$205.00	\$205.00	\$215.00
21-1/4" to 24"	\$215.00	\$215.00	\$224.50
24-1/4" to 27"	\$226.00	\$226.00	\$232.50
27-1/4" to 30"	\$235.50	\$235.50	\$242.50
30-1/4" to 33"	\$243.00	\$243.00	\$253.50
33-1/4" to 36"	\$254.50	\$254.50	\$262.00
36-1/4" to 39"	\$263.00	\$263.00	\$272.00
39-1/4" to 42"	\$272.00	\$272.00	\$280.50
42-1/4" to 45"	\$280.50	\$280.50	\$289.00
45-1/4" to 48"	\$289.00	\$289.00	\$299.00

Replacement Escutcheons		
56-701-2-010	1/2" Brass Plated (Style 10)	\$9.05
56-701-9-010	1/2" Chrome Plated (Style 10)	\$6.25
56-701-4-010	1/2" White Color Coated (Style 10)	\$6.25
91-106-2-007	Brass Plated (Push On)	\$6.35
91-106-9-007	Chrome Plated (Push On)	\$6.25
91-106-0-007	White Color (Push On)	\$6.25

Dry Sprinkler Rubber Boot Kit		
63-000-0-002	DSB-2 Dry Sprinkler Boot Kit Includes: 1-EPDM Rubber Boot, 2-Nylon Ties, 1-1/3 oz tube of adhesive	\$43.50

Sprinkler Wrench (Standard Pipe Wrench for pipe barrel)		
56-850-4-001	W-Type 7 Wrench (Recessed Only)	\$81.00

**Technical Data Sheet: TFP500, Sprinkler Boot-TFP591**

**Note: All sprinklers are special ordered and are Non-Returnable. Please see "Terms & Conditions"**

See latest Technical Data Sheets for specific Approvals, Listings, Design Parameters & available finishes. Sprinkler heads & escutcheons are priced separately unless otherwise noted.

Items marked "C.O." are made to order and may require longer delivery times. Please contact customer service for availability.

Section 1  
Standard Spray Sprinklers

Section 2  
Extended Coverage Sprinklers

Section 3  
Storage Sprinklers

Section 4  
Residential Products

Section 5  
Dry Sprinklers

Section 6  
Special Sprinklers

Section 7  
Nozzles and Sprinkler Accessories

**Series DS-1, Dry, Standard Coverage, 3/4" NPT**  
**Pendent, Upright & Horizontal Sidewall, QR, K=5.6, 3mm Bulb**

P/N 60 - XXX - X - XXX

01	Pendent w/Std. Escutcheon (3/4" NPT)
02	Pendent w/Deep Escutcheon (3/4" NPT)
03	Pendent w/Std. Recessed Escutcheon (3/4" NPT)
04	Pendent w/o Escutcheon (3/4" NPT)

05	Sidewall w/Std. Escutcheon (3/4" NPT)
06	Sidewall w/Deep Escutcheon (3/4" NPT)
07	Sidewall w/o Escutcheon (3/4" NPT)

C.O.	Temperature
0	135°F/57°C
1	155°F/68°C
2	175°F/79°C
3	200°F/93°C
4	286°F/141°C
5	360°F/182°C

Finish	
Sprinkler	Escutcheon
2	Brass
1	Brass
4	White
0	White
9	White
0	Chrome
9	Chrome

Length (for example)	
060	6.00"
062	6.25"
065	6.50"
067	6.75"
372	37.25"
480	48.00"

3/4" NPT SIN (Pendent TY3935), (HSW TY3735)

**Length**  
(48" Max)

**Pendent**

**Sidewall**

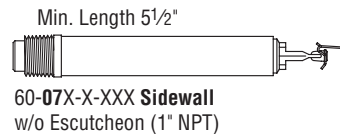
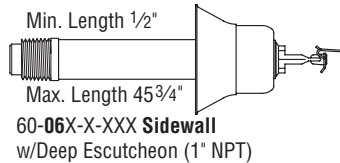
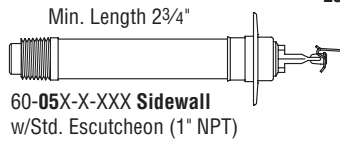
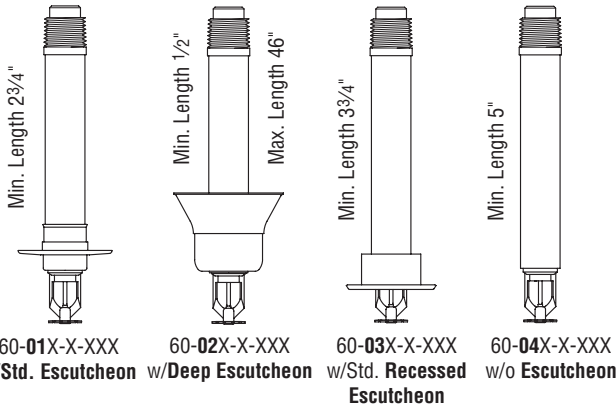

1/2" to 5-3/4"	\$191.00	\$204.00
6"	\$182.00	\$191.50
6-1/4" to 7-3/4"	\$202.50	\$213.00
8"	\$191.00	\$204.00
8-1/4" to 11-3/4"	\$218.00	\$230.50
12"	\$202.50	\$213.00
12-1/4" to 15"	\$228.50	\$243.00
15-1/4" to 18"	\$239.50	\$252.00
18-1/4" to 21"	\$251.00	\$263.50
21-1/4" to 24"	\$262.50	\$276.00
24-1/4" to 27"	\$273.00	\$284.50
27-1/4" to 30"	\$284.00	\$294.00
30-1/4" to 33"	\$293.50	\$306.50
33-1/4" to 36"	\$306.00	\$316.50
36-1/4" to 39"	\$316.00	\$328.50
39-1/4" to 42"	\$328.00	\$340.00
42-1/4" to 45"	\$339.00	\$350.00
45-1/4" to 48"	\$349.50	\$360.00

**Replacement Escutcheons**

<b>56-701-2-010</b>	1/2" Brass Plated (Style 10)	\$9.05
<b>56-701-9-010</b>	1/2" Chrome Plated (Style 10)	\$6.25
<b>56-701-4-010</b>	1/2" White Color Coated (Style 10)	\$6.25
<b>91-106-2-007</b>	Brass Plated (Push On)	\$6.35
<b>91-106-9-007</b>	Chrome Plated (Push On)	\$6.25
<b>91-106-0-007</b>	White Color (Push On)	\$6.25

**Dry Sprinkler Rubber Boot Kit**

<b>63-000-0-002</b>	DSB-2 Dry Sprinkler Boot Kit Includes: 1-EPDM Rubber Boot, 2-Nylon Ties, 1-1/3 oz tube of adhesive	\$43.50
---------------------	--	---------

**Sprinkler Wrench** (Standard Pipe Wrench for pipe barrel)

<b>56-850-4-001</b>	W-Type 7 Wrench (Recessed Only)	\$81.00
---------------------	---------------------------------	---------

**Technical Data Sheet: TFP510, Sprinkler Boot-TFP591**

**Note: All Dry Sprinklers are special ordered and are Non-Returnable. Please see "Terms & Conditions"**

Items marked "C.O." are made to order and may require longer delivery times. Please contact customer service for availability.

See latest Technical Data Sheets for specific Approvals, Listings, Design Parameters & available finishes. Sprinkler heads & escutcheons are priced separately unless otherwise noted.

**Series DS-1, Dry, Standard Coverage, 1" NPT  
Pendent, Upright & Horizontal Sidewall, QR, K=5.6, 3mm Bulb**

P/N 60 - XXX - X - XXX

36	Pendent w/Std. Escutcheon (1" NPT)
33	Pendent w/Deep Escutcheon (1" NPT)
37	Pendent w/Std. Recessed Escutcheon (1" NPT)
32	Pendent w/o Escutcheon (1" NPT)
34	Sidewall w/Std. Escutcheon (1" NPT)
43	Sidewall w/Deep Escutcheon (1" NPT)
44	Sidewall w/o Escutcheon (1" NPT)
38	Upright w/o Escutcheon (1" NPT)

C.O.	Temperature
0	135°F/57°C
1	155°F/68°C
2	175°F/79°C
3	200°F/93°C
4	286°F/141°C
5	360°F/182°C

Finish	
Sprinkler	Escutcheon
2	Brass
1	Brass
4	White
0	Chrome
9	Chrome

Length (for example)	
060	6.00"
062	6.25"
065	6.50"
067	6.75"
372	37.25"
480	48.00"

Section 1  
Standard Spray Sprinklers

Section 2  
Extended Coverage Sprinklers

Section 3  
Storage Sprinklers

Section 4  
Residential Products

Section 5  
Dry Sprinklers

Section 6  
Special Sprinklers

Section 7  
Nozzles and Sprinkler Accessories

1" NPT SIN (Upright TY3135), (Pendent TY3235), (HSW TY3335)

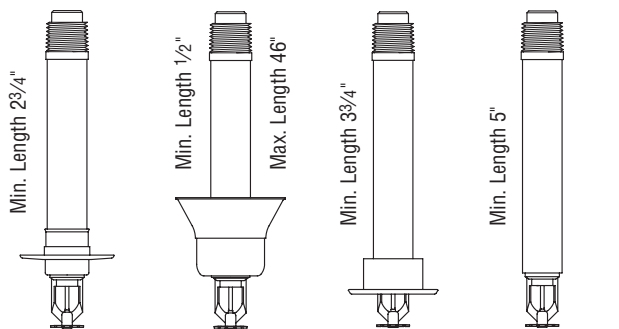

60-36X-X-XXX w/Std. Escutcheon  
60-33X-X-XXX w/Deep Escutcheon  
60-37X-X-XXX w/Std. Recessed Escutcheon  
60-32X-X-XXX w/o Escutcheon

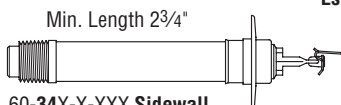

60-34X-X-XXX Sidewall w/Std. Escutcheon (1" NPT)

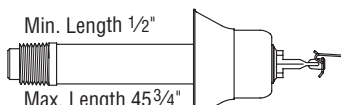

60-43X-X-XXX Sidewall w/Deep Escutcheon (1" NPT)

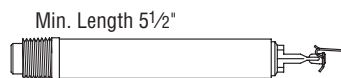

60-44X-X-XXX Sidewall w/o Escutcheon (1" NPT)

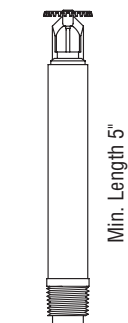

60-38X-X-XXX Upright

**Note: All Dry Sprinklers are special ordered and are Non-Returnable. Please see "Terms & Conditions"**

Length (48" Max)	Upright	Pendent	Sidewall
1/2" to 5-3/4"	\$166.00	\$166.00	\$177.50
6"	\$158.00	\$158.00	\$166.50
6-1/4" to 7-3/4"	\$176.00	\$176.00	\$185.00
8"	\$166.00	\$166.00	\$177.50
8-1/4" to 11-3/4"	\$189.50	\$189.50	\$200.00
12"	\$176.00	\$176.00	\$185.00
12-1/4" to 15"	\$199.00	\$199.00	\$211.00
15-1/4" to 18"	\$208.00	\$208.00	\$219.00
18-1/4" to 21"	\$218.00	\$218.00	\$229.00
21-1/4" to 24"	\$228.00	\$228.00	\$240.00
24-1/4" to 27"	\$237.50	\$237.50	\$247.00
27-1/4" to 30"	\$246.50	\$246.50	\$255.50
30-1/4" to 33"	\$255.00	\$255.00	\$267.00
33-1/4" to 36"	\$266.50	\$266.50	\$275.50
36-1/4" to 39"	\$275.00	\$275.00	\$285.50
39-1/4" to 42"	\$285.00	\$285.00	\$295.50
42-1/4" to 45"	\$295.00	\$295.00	\$304.50
45-1/4" to 48"	\$304.00	\$304.00	\$313.00

**Replacement Escutcheons**

56-701-2-010	1/2" Brass Plated (Style 10)	\$9.05
56-701-9-010	1/2" Chrome Plated (Style 10)	\$6.25
56-701-4-010	1/2" White Color Coated (Style 10)	\$6.25
91-106-2-007	Brass Plated (Push On)	\$6.35
91-106-9-007	Chrome Plated (Push On)	\$6.25
91-106-0-007	White Color (Push On)	\$6.25

**Dry Sprinkler Rubber Boot Kit**

63-000-0-002	DSB-2 Dry Sprinkler Boot Kit Includes: 1-EPDM Rubber Boot, 2-Nylon Ties, 1-1/3 oz tube of adhesive	\$43.50
--------------	--	---------

**Sprinkler Wrench (Standard Pipe Wrench for pipe barrel)**

56-850-4-001	W-Type 7 Wrench (Recessed Only)	\$81.00
--------------	---------------------------------	---------

**Technical Data Sheet: TFP510, Sprinkler Boot-TFP591**

See latest Technical Data Sheets for specific Approvals, Listings, Design Parameters & available finishes. Sprinkler heads & escutcheons are priced separately unless otherwise noted.

Items marked "C.O." are made to order and may require longer delivery times. Please contact customer service for availability.



**Series DS-1, Dry, Extended Coverage, Horizontal Sidewall, QR & SR, K=5.6, 3mm & 5mm Bulb**

P/N 60 - XXX - X - XXX

C.O. EC Sidewall 3mm Bulb (QR)		Finish		Length	
		Sprinkler	Escutcheon		(for example)
350	▶ 135°F/57°C (1" NPT)	2	Brass	Brass	060 6.00"
351	155°F/68°C (1" NPT)	1	Brass	White	062 6.25"
		4	White	White	065 6.50"
		0	Chrome	White	067 6.75"
		9	Chrome	Chrome	372 37.25"
					480 48.00"

  

C.O. EC Sidewall 5mm Bulb (SR)	
950	▶ 135°F/57°C (1" NPT)
951	155°F/68°C (1" NPT)

**DS-1 Extended Coverage Sidewall**  
SIN (SR TY3358), (QR TY3338)

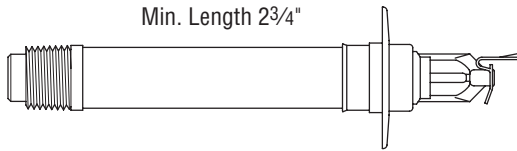

60-95X-X-XXX **Extended Coverage Sidewall**  
SR, w/Std. Escutcheon (1" NPT)

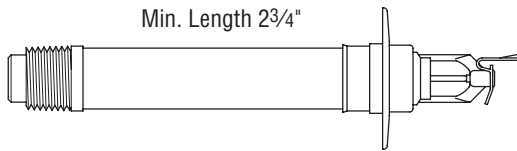

60-35X-X-XXX **Extended Coverage Sidewall**  
QR, w/Std. Escutcheon (1" NPT)

**Note: All Dry Sprinklers are special ordered and are Non-Returnable. Please see "Terms & Conditions"**

<i>Length</i> (48" Max)	(SR) EC S/W	(QR) EC S/W
2-3/4" to 6"	\$182.50	\$197.00
6-1/4" to 8"	\$192.00	\$206.50
8-1/4" to 12"	\$206.50	\$219.00
12-1/4" to 15"	\$215.00	\$229.00
15-1/4" to 18"	\$226.00	\$240.00
18-1/4" to 21"	\$235.50	\$247.00
21-1/4" to 24"	\$244.50	\$255.50
24-1/4" to 27"	\$255.00	\$267.00
27-1/4" to 30"	\$265.50	\$275.50
30-1/4" to 33"	\$275.50	\$285.50
33-1/4" to 36"	\$286.50	\$295.50
36-1/4" to 39"	\$295.00	\$304.50
39-1/4" to 42"	\$305.50	\$313.00
42-1/4" to 45"	\$314.00	\$329.50
45-1/4" to 48"	\$324.00	\$340.00

**Replacement Escutcheons**

<b>91-106-2-007</b>	Brass Plated (Push On)	\$6.35
<b>91-106-9-007</b>	Chrome Plated (Push On)	\$6.25
<b>91-106-0-007</b>	White Color (Push On)	\$6.25

**Dry Sprinkler Rubber Boot Kit**

<b>63-000-0-002</b>	DSB-2 Dry Sprinkler Boot Kit Includes: 1-EPDM Rubber Boot, 2-Nylon Ties, 1-1/3 oz tube of adhesive	\$43.50
---------------------	--	---------

**Sprinkler Wrench** (Standard Pipe Wrench for pipe barrel)

<b>56-850-4-001</b>	W-Type 7 Wrench	\$81.00
---------------------	-----------------	---------

**Technical Data Sheet: TFP520, Sprinkler Boot-TFP591**

Items marked "C.O." are made to order and may require longer delivery times. Please contact customer service for availability.

See latest Technical Data Sheets for specific Approvals, Listings, Design Parameters & available finishes. Sprinkler heads & escutcheons are priced separately unless otherwise noted.

**Series DS-1, Dry, Stainless Steel, Standard Coverage, Pendent, QR or SR, K=5.6**

P/N 60 - XXX - X - XXX

		SIN
11	SS Pendent QR w/ Standard Escutcheon	TY3230
12	SS Pendent QR w/ Recessed Escutcheon	TY3230
13	SS Pendent QR w/ Deep Escutcheon	TY3230
14	SS Pendent QR w/o Escutcheon	TY3230
21	SS Pendent SR w/ Standard Escutcheon	TY3250
22	SS Pendent SR w/ Recessed Escutcheon	TY3250
23	SS Pendent SR w/ Deep Escutcheon	TY3250
24	SS Pendent SR w/o Escutcheon	TY3250

C.O.	TEMPERATURE RATING (2)
0	135°F / 57°C
1	155°F / 68°C
2	175°F / 79°C
3	200°F / 93°C
4	286°F / 141°C
5	360°F / 182°C

Finish
6 Stainless Steel for Sprinkler & Escutcheon

ORDER LENGTH* EXAMPLES	
055	5.50"
082	8.25"
180	18.00"
187	18.75"
372	37.25"
480	48.00"

- Notes:**
1. Dry-Type Sprinklers are furnished based upon "Order Length" as measured per Figures 10 through 17 in TD sheet TFP560 and for each individual sprinkler where it is to be installed. After taking the measurement, round it to the nearest 1/4 inch increment.
  2. Temperature ratings 286°F/141°C and 360°F/182°C apply to non-recessed sprinkler assemblies.

Section 1  
Standard Spray Sprinklers

Section 2  
Extended Coverage Sprinklers

Section 3  
Storage Sprinklers

Section 4  
Residential Products

Section 5  
Dry Sprinklers

Section 6  
Special Sprinklers

Section 7  
Nozzles and Sprinkler Accessories

**DS-1 Stainless Steel, Standard Coverage, Pendent Standard Response or Quick Response**



SR - 60-21X-X-XXX  
QR - 60-11X-X-XXX  
w/Std. Escutcheon

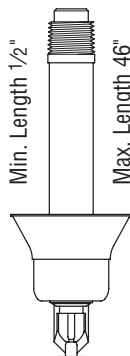

SR - 60-23X-X-XXX  
QR - 60-13X-X-XXX  
w/Deep Escutcheon



SR - 60-22X-X-XXX  
QR - 60-12X-X-XXX  
w/Std. Recessed Escutcheon



SR - 60-24X-X-XXX  
QR - 60-14X-X-XXX  
w/o Escutcheon

**Note: All Dry Sprinklers are special ordered and are Non-Returnable. Please see "Terms & Conditions"**

Length (48" Max)	List Price
1/2" to 5-3/4"	\$368.50
6"	\$368.50
6-1/4" to 7-3/4"	\$383.00
8"	\$383.00
8-1/4" to 11-3/4"	\$383.00
12"	\$383.00
12-1/4" to 15"	\$395.00
15-1/4" to 18"	\$407.50
18-1/4" to 21"	\$419.50
21-1/4" to 24"	\$432.00
24-1/4" to 27"	\$444.50
27-1/4" to 30"	\$456.50
30-1/4" to 33"	\$469.00
33-1/4" to 36"	\$481.00
36-1/4" to 39"	\$493.00
39-1/4" to 42"	\$505.50
42-1/4" to 45"	\$517.50
45-1/4" to 48"	\$529.50
<b>Replacement Escutcheon</b>	
<b>56-701-0-010</b> 1/2" Stainless Steel (Style 10)	\$17.50
<b>Dry Sprinkler Rubber Boot Kit</b>	
<b>63-000-0-002</b> DSB-2 Dry Sprinkler Boot Kit Includes: 1-EPDM Rubber Boot, 2-Nylon Ties, 1-1/3 oz tube of adhesive	\$43.50
<b>Sprinkler Wrench</b> (Standard Pipe Wrench for pipe barrel)	
<b>56-850-4-001</b> W-Type 7 Wrench (Recessed Only)	\$81.00
<b>Technical Data Sheet: TFP560, Sprinkler Boot-TFP591</b>	

See latest Technical Data Sheets for specific Approvals, Listings, Design Parameters & available finishes. Sprinkler heads & escutcheons are priced separately unless otherwise noted.

Items marked "C.O." are made to order and may require longer delivery times. Please contact customer service for availability.

**Series DS-1, Dry, Stainless Steel, Standard & Extended Coverage, Horizontal Sidewall, QR or SR, K=5.6**

P/N 60 - XXX - X - XXX

		SIN
15	SS HSW QR, SC w/ Standard Escutcheon	TY3337
16	SS HSW QR, SC w/ Deep Escutcheon	TY3337
17	SS HSW QR SC w/o Escutcheon	TY3337
25	SS HSW SR, SC w/ Standard Escutcheon	TY3357
26	SS HSW SR, SC w/ Deep Escutcheon	TY3357
27	SS HSW SR w/o Escutcheon	TY3357
18	SS HSW QR, EC w/ Standard Escutcheon	TY3339

C.O.	TEMPERATURE RATING (2)
0	135°F / 57°C
1	155°F / 68°C
2	175°F / 79°C
3	200°F / 93°C
4	286°F / 141°C
5	360°F / 182°C

FINISH
6 Stainless Steel for Sprinkler & Escutcheon

ORDER LENGTH* EXAMPLES	
055	5.50"
082	8.25"
180	18.00"
187	18.75"
372	37.25"
480	48.00"

- Notes:**
1. Dry-Type Sprinklers are furnished based upon "Order Length" as measured per Figures 10 through 17 and for each individual sprinkler where it is to be installed. After taking the measurement, round it to the nearest 1/4 inch increment.
  2. Temperature ratings 286°F/141°C and 360°F/182°C apply to non-recessed sprinkler assemblies.

**DS-1 Stainless Steel, Standard Coverage, HSW Standard Response or Quick Response**

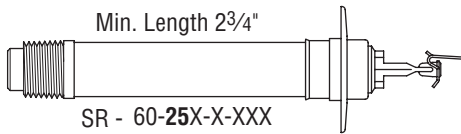

Min. Length 2<sup>3</sup>/<sub>4</sub>"  
SR - 60-25X-X-XXX  
QR - 60-15X-X-XXX  
w/Std. Escutcheon (1" NPT)

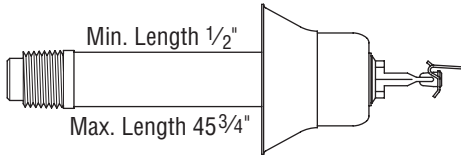

Min. Length 1/2"  
Max. Length 45<sup>3</sup>/<sub>4</sub>"  
SR - 60-26X-X-XXX  
QR - 60-16X-X-XXX  
w/Deep Escutcheon (1" NPT)

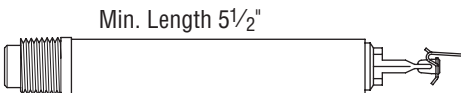

Min. Length 5<sup>1</sup>/<sub>2</sub>"  
SR - 60-27X-X-XXX  
QR - 60-17X-X-XXX  
w/o Escutcheon (1" NPT)

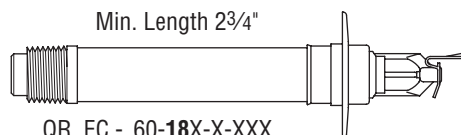

Min. Length 2<sup>3</sup>/<sub>4</sub>"  
QR, EC - 60-18X-X-XXX  
w/Std. Escutcheon (1" NPT)

**Note: All Dry Sprinklers are special ordered and are Non-Returnable. Please see "Terms & Conditions"**

Length (48" Max)	List Price
1/2" to 5-3/4"	\$368.50
6"	\$368.50
6-1/4" to 7-3/4"	\$383.00
8"	\$383.00
8-1/4" to 11-3/4"	\$383.00
12"	\$383.00
12-1/4" to 15"	\$395.00
15-1/4" to 18"	\$407.50
18-1/4" to 21"	\$419.50
21-1/4" to 24"	\$432.00
24-1/4" to 27"	\$444.50
27-1/4" to 30"	\$456.50
30-1/4" to 33"	\$469.00
33-1/4" to 36"	\$481.00
36-1/4" to 39"	\$493.00
39-1/4" to 42"	\$505.50
42-1/4" to 45"	\$517.50
45-1/4" to 48"	\$529.50
<b>Replacement Escutcheons</b>	
56-701-0-010	1/2" Stainless Steel (Style 10) \$17.50
<b>Dry Sprinkler Rubber Boot Kit</b>	
63-000-0-002	DSB-2 Dry Sprinkler Boot Kit Includes: 1-EPDM Rubber Boot, 2-Nylon Ties, 1-1/3 oz tube of adhesive \$43.50
<b>Sprinkler Wrench</b> (Standard Pipe Wrench for pipe barrel)	
56-850-4-001	W-Type 7 Wrench (Recessed Only) \$81.00
<b>Technical Data Sheet: TFP560, Sprinkler Boot-TFP591</b>	

Items marked "C.O." are made to order and may require longer delivery times. Please contact customer service for availability.

See latest Technical Data Sheets for specific Approvals, Listings, Design Parameters & available finishes. Sprinkler heads & escutcheons are priced separately unless otherwise noted.

**Series DS-2, ELO Dry, Standard Coverage, Pendent, SR, K=11.2, 5mm Bulb**

P/N 61 - XXX - X - XXX

Pendent		C.O. Temperature		Finish		Length (for example)	
				Sprinkler	Escutcheon		
10	w/Flush Escutcheon	0	135°F/57°C	1	Brass White	060	6.00"
11	w/Recessed Escutcheon	1	155°F/68°C	4	White White	062	6.25"
12	w/Extended Escutcheon	2	175°F/79°C	9	Chrome Chrome	065	6.50"
13	w/o Escutcheon	3	200°F/93°C	0	Chrome White	067	6.75"
		4	286°F/141°C	5	Brass Brass	372	37.25"
						480	48.00"

**DS-2 Standard Response**  
SIN TY5255

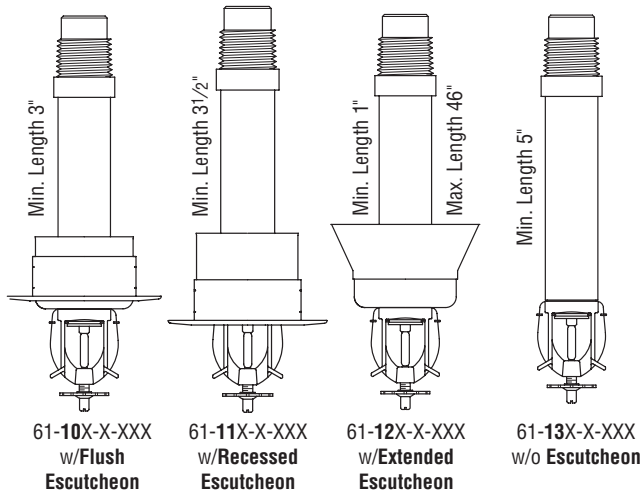

**Note: All Dry Sprinklers are special ordered and are Non-Returnable. Please see "Terms & Conditions"**

Length (48" Max)	List Price
1" to 6"	\$222.50
6-1/4" to 8"	\$231.50
8-1/4" to 12"	\$241.50
12-1/4" to 15"	\$251.50
15-1/4" to 18"	\$261.00
18-1/4" to 21"	\$270.50
21-1/4" to 24"	\$280.50
24-1/4" to 27"	\$290.50
27-1/4" to 30"	\$301.00
30-1/4" to 33"	\$311.00
33-1/4" to 36"	\$321.50
36-1/4" to 39"	\$331.50
39-1/4" to 42"	\$340.50
42-1/4" to 45"	\$350.50
45-1/4" to 48"	\$366.50
Replacement Escutcheons (Recessed Outer)	
<b>854922</b>	Brass Plated - Flush \$6.25
<b>854912</b>	Chrome Plated - Flush \$6.25
<b>854902</b>	Flush White Color - Flush \$9.05
<b>854822</b>	Brass Plated - Deep \$6.25
<b>854812</b>	Chrome Plated - Deep \$6.25
<b>854802</b>	White Color - Deep \$6.25
Dry Sprinkler Rubber Boot Kit	
<b>63-000-0-002</b>	DSB-2 Dry Sprinkler Boot Kit Includes: 1-EPDM Rubber Boot, 2-Nylon Ties, 1-1/3 oz tube of adhesive \$43.50
Sprinkler Pipe Wrench (Standard Pipe Wrench for pipe barrel)	
<b>56-010-4-118</b>	W-Type 17 Wrench (Recessed Only) \$70.00
Technical Data Sheet: TFP530, Sprinkler Boot-TFP591	

See latest Technical Data Sheets for specific Approvals, Listings, Design Parameters & available finishes. Sprinkler heads & escutcheons are priced separately unless otherwise noted.

Items marked "C.O." are made to order and may require longer delivery times. Please contact customer service for availability.

Section 1  
Standard Spray Sprinklers

Section 2  
Extended Coverage Sprinklers

Section 3  
Storage Sprinklers

Section 4  
Residential Products

Section 5  
Dry Sprinklers

Section 6  
Special Sprinklers

Section 7  
Nozzles and Sprinkler Accessories

**Series DS-2, ELO Dry, Standard Coverage, Pendent, QR, K=11.2, 3mm Bulb**

P/N 61 - XXX - X - XXX

Pendent		C.O. Temperature		Finish		Length (for example)	
				Sprinkler	Escutcheon		
30	w/Flush Escutcheon	0	▶ 135F/57°C	1	Brass White	060	6.00"
31	w/Recessed Escutcheon	1	155F/68°C	4	White White	062	6.25"
32	w/Extended Escutcheon	2	▶ 175F/79°C	9	Chrome Chrome	065	6.50"
35	w/o Escutcheon	3	200F/93°C	0	Chrome White	067	6.75"
		4	286F/141°C	5	Brass Brass	372	37.25"
						480	48.00"

**DS-2 Quick Response, Standard Coverage**  
SIN TY5235

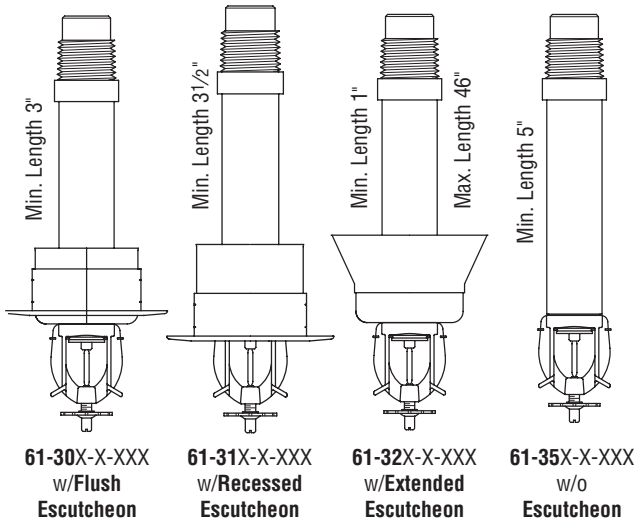

**Note: All Dry Sprinklers are special ordered and are Non-Returnable. Please see "Terms & Conditions"**

Length (48" Max)	List Price
1" to 6"	\$222.50
6-1/4" to 8"	\$231.50
8-1/4" to 12"	\$241.50
12-1/4" to 15"	\$251.50
15-1/4" to 18"	\$261.00
18-1/4" to 21"	\$270.50
21-1/4" to 24"	\$280.50
24-1/4" to 27"	\$290.50
27-1/4" to 30"	\$301.00
30-1/4" to 33"	\$311.00
33-1/4" to 36"	\$321.50
36-1/4" to 39"	\$331.50
39-1/4" to 42"	\$340.50
42-1/4" to 45"	\$350.50
45-1/4" to 48"	\$366.50
Replacement Escutcheons (Recessed Outer)	
<b>8549-02</b>	Brass Plated - Flush \$6.25
<b>8549-12</b>	Chrome Plated - Flush \$6.25
<b>8549-22</b>	Flush White Color - Flush \$9.05
<b>54-812-1-199</b>	Brass Plated - Deep \$6.25
<b>54-812-1-198</b>	Chrome Plated - Deep \$6.25
<b>54-812-1-200</b>	White Color - Deep \$6.25
Dry Sprinkler Rubber Boot Kit	
<b>63-000-0-002</b>	DSB-2 Dry Sprinkler Boot Kit Includes: 1-EPDM Rubber Boot, 2-Nylon Ties, 1-1/3 oz tube of adhesive \$43.50
Sprinkler Wrench (Standard Pipe Wrench for pipe barrel)	
<b>56-010-4-118</b>	W-Type 17 Wrench \$70.00
Technical Data Sheet: TFP530, Sprinkler Boot-TFP591	

Items marked "C.O." are made to order and may require longer delivery times. Please contact customer service for availability.

See latest Technical Data Sheets for specific Approvals, Listings, Design Parameters & available finishes. Sprinkler heads & escutcheons are priced separately unless otherwise noted.

Section 1  
Standard Spray Sprinklers

Section 2  
Extended Coverage Sprinklers

Section 3  
Storage Sprinklers

Section 4  
Residential Products

Section 5  
Dry Sprinklers

Section 6  
Special Sprinklers

Section 7  
Nozzles and Sprinkler Accessories

**Series DS-2, ELO Dry, Extended Coverage, Pendent, QR & SR, K=11.2, 3mm Bulb**

P/N 61 - XXX - X - XXX

Pendent		C.O. Temperature		Finish		Length (for example)		
				Sprinkler	Escutcheon			
40	w/Flush Escutcheon	0	135°F/57°C	1	Brass	White	060	6.00"
41	w/Recessed Escutcheon	1	155°F/68°C	4	White	White	062	6.25"
42	w/Extended Escutcheon	2	175°F/79°C	9	Chrome	Chrome	065	6.50"
43	w/o Escutcheon	3	200°F/93°C	0	Chrome	White	067	6.75"
		4	286°F/141°C	5	Brass	Brass	372	37.25"
							480	48.00"

**DS-2 Extended Coverage**  
SIN TY5238

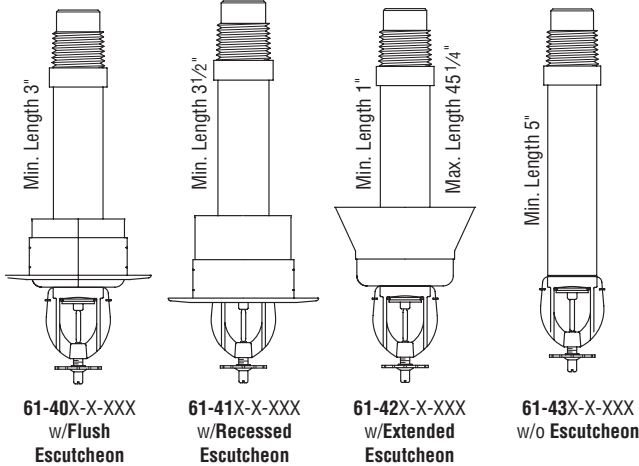

**Note: All Dry Sprinklers are special ordered and are Non-Returnable. Please see "Terms & Conditions"**

Length (48" Max)	List Price
1" to 6"	\$270.50
6-1/4" to 8"	\$280.50
8-1/4" to 12"	\$290.50
12-1/4" to 15"	\$301.00
15-1/4" to 18"	\$311.00
18-1/4" to 21"	\$321.50
21-1/4" to 24"	\$331.50
24-1/4" to 27"	\$340.50
27-1/4" to 30"	\$350.50
30-1/4" to 33"	\$360.00
33-1/4" to 36"	\$369.50
36-1/4" to 39"	\$379.50
39-1/4" to 42"	\$390.00
42-1/4" to 45"	\$401.50
45-1/4" to 48"	\$420.50

**Replacement Escutcheons**

<b>8549-02</b>	Brass Plated - Flush	\$6.25
<b>8549-12</b>	Chrome Plated - Flush	\$6.25
<b>8549-22</b>	Flush White Color - Flush	\$9.05
<b>54-812-1-199</b>	Brass Plated - Deep	\$6.25
<b>54-812-1-198</b>	Chrome Plated - Deep	\$6.25
<b>54-812-1-200</b>	White Color - Deep	\$6.25

**Dry Sprinkler Rubber Boot Kit**

<b>63-000-0-002</b>	DSB-2 Dry Sprinkler Boot Kit Includes: 1-EPDM Rubber Boot, 2-Nylon Ties, 1-1/3 oz tube of adhesive	\$43.50
---------------------	--	---------

**Sprinkler Wrench (Standard Pipe Wrench for pipe barrel)**

<b>56-010-4-118</b>	W-Type 17 Wrench	\$70.00
---------------------	------------------	---------

**Notes**

Quick response or standard response is dependent on hazard.  
See technical data sheet for additional information.

**Technical Data Sheet: TFP540, Sprinkler Boot-TFP591**



**Series DS-3, Dry, Extended Coverage Ordinary Hazard (ECOH),  
Horizontal Sidewall, 1" NPT, K=11.2, 3mm bulb**

P/N 61 — XXX — X — XXX

		MODEL/SIN			ORDER LENGTH (1) (EXAMPLES)		
161	<b>Flush Escutcheon</b> (1"NPT), 155F/68C	TY5339	SPRINKLER FINISH	ESCUTCHEON FINISH (2)	055	5.50"	
163	<b>Flush Escutcheon</b> (1"NPT), 200F/93C	TY5339			1	NATURAL BRASS	BRASS PLATED
171	<b>Deep Escutcheon Skirt</b> (1"NPT), 155F/68C	TY5339	4	WHITE POLYESTER	WHITE COATED	180	18.00"
173	<b>Deep Escutcheon Skirt</b> (1"NPT), 200F/93C	TY5339	9	CHROME PLATED	CHROME PLATED	187	18.75"
151	<b>Without Escutcheon</b> (1"NPT), 155F/68C	TY5339	0	CHROME PLATED	WHITE COATED	372	37.25"
153	<b>Without Escutcheon</b> (1"NPT), 200F/93C	TY5339			480	48.00"	

**DS-3 Extended Coverage Ordinary Hazard Sidewall  
SIN (TY5339)**

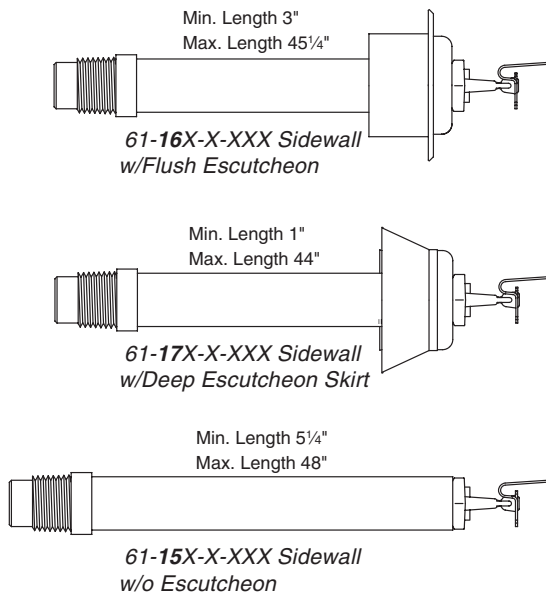

<i>Length (48" Max)</i>	<i>ECOH S/W</i>
1" to 6"	\$248.50
6-1/4" to 8"	\$254.50
8-1/4" to 12"	\$261.50
12-1/4" to 15"	\$268.00
15-1/4" to 18"	\$275.00
18-1/4" to 21"	\$281.00
21-1/4" to 24"	\$288.00
24-1/4" to 27"	\$295.00
27-1/4" to 30"	\$301.50
30-1/4" to 33"	\$308.00
33-1/4" to 36"	\$314.50
36-1/4" to 39"	\$322.00
39-1/4" to 42"	\$328.50
42-1/4" to 45"	\$335.00
45-1/4" to 48"	\$341.00

**Replacement Escutcheons**

<b>8549-22</b>	Brass Plated - Flush	\$9.05
<b>8549-12</b>	Chrome Plated - Flush	\$6.25
<b>8549-02</b>	Flush White Color - Flush	\$6.25
<b>54-812-1-199</b>	Brass Plated - Deep	\$6.25
<b>54-812-1-198</b>	Chrome Plated - Deep	\$6.25
<b>54-812-1-200</b>	White Color - Deep	\$6.25

**Dry Sprinkler Rubber Boot Kit**

<b>63-000-0-002</b>	DSB-2 Dry Sprinkler Boot Kit Includes: 1-EPDM Rubber Boot, 2-Nylon Ties, 1-1/3 oz tube of adhesive	\$43.50
---------------------	--	---------

**Sprinkler Wrench (Standard Pipe Wrench for pipe barrel)**

<b>56-892-1-001</b>	W-Type 8 Wrench	\$81.00
---------------------	-----------------	---------

**Technical Data Sheet: TFP550, Sprinkler Boot-TFP591**

**Note: All Dry Sprinklers are special ordered and are  
Non-Returnable. Please see "Terms & Conditions"**

Items marked "C.O." are made to order and may require longer delivery times.  
Please contact customer service for availability.

See latest Technical Data Sheets for specific Approvals, Listings,  
Design Parameters & available finishes. Sprinkler heads & escutcheons  
are priced separately unless otherwise noted.



**Series DS-C, Dry Concealed, Standard Response, K=5.6, 5mm Bulb**

DS-C SR Concealed SIN TY3555		c.o.	Length (48" Max)	List Price																				
<p>P/N 60 - 86 X - 1 - XXX</p> <table border="1"> <tr> <th>C.O.</th> <th>Temperature</th> <th>Length (for example)</th> </tr> <tr> <td>1</td> <td>155°F/68°C</td> <td>060 6.00"</td> </tr> <tr> <td>3</td> <td>200°F/93°C</td> <td>062 6.25"</td> </tr> <tr> <td></td> <td></td> <td>065 6.50"</td> </tr> <tr> <td></td> <td></td> <td>067 6.75"</td> </tr> <tr> <td></td> <td></td> <td>372 37.25"</td> </tr> <tr> <td></td> <td></td> <td>480 48.00"</td> </tr> </table> <p>60-86X-1-XXX</p> <p>Cover Plate (Order Separately)</p> <p><b>Note: All Dry Sprinklers are special ordered and are Non-Returnable.</b> <b>Please see "Terms &amp; Conditions"</b> <b>Note: All Dry Sprinklers are 4 7/8" Min. Length and 48" Max.</b></p>		C.O.	Temperature	Length (for example)	1	155°F/68°C	060 6.00"	3	200°F/93°C	062 6.25"			065 6.50"			067 6.75"			372 37.25"			480 48.00"	5" to 8"	\$188.50
		C.O.	Temperature	Length (for example)																				
		1	155°F/68°C	060 6.00"																				
		3	200°F/93°C	062 6.25"																				
				065 6.50"																				
				067 6.75"																				
				372 37.25"																				
				480 48.00"																				
		8-1/4" to 12"	\$200.50																					
		12-1/4" to 15"	\$214.50																					
		15-1/4" to 18"	\$229.00																					
		18-1/4" to 21"	\$242.50																					
		21-1/4" to 27"	\$256.00																					
		27-1/4" to 30"	\$270.50																					
		30-1/4" to 33"	\$285.00																					
33-1/4" to 36"	\$299.50																							
36-1/4" to 39"	\$311.50																							
39-1/4" to 42"	\$325.50																							
42-1/4" to 45"	\$340.00																							
45-1/4" to 48"	\$352.50																							
<b>Cover Plates</b>																								
80 Box Quantity (14.5 lbs/box)																								
<b>Cover Plate (For use with 155° F Sprinkler)</b>																								
56-792-1-135	Brass	135°F/57°C	\$21.25																					
56-792-9-135	Chrome	135°F/57°C	\$21.25																					
56-792-0-135	Grey White	135°F/57°C	\$21.25																					
56-792-4-135	Signal (Bright) White	135°F/57°C	\$21.25																					
56-792-X-135	Special Order*	135°F/57°C	\$22.75																					
<b>Cover Plate (For use with 200° F Sprinkler)</b>																								
56-792-1-165	Brass	165°F/74°C	\$21.25																					
56-792-9-165	Chrome	165°F/74°C	\$21.25																					
56-792-0-165	Grey White	165°F/74°C	\$21.25																					
56-792-4-165	Signal (Bright) White	165°F/74°C	\$21.25																					
56-792-X-165	Special Order*	165°F/74°C	\$22.75																					
<b>Notes</b>																								
6012	*Special order paint match subject to set-up charge. (Net Price)		\$376.50																					
<b>Dry Sprinkler Rubber Boot Kit</b>																								
63-000-0-002	DSB-2 Dry Sprinkler Boot Kit Includes: 1-EPDM Rubber Boot, 2-Nylon Ties, 1-1/3 oz tube of adhesive		\$43.50																					
<b>Sprinkler Wrench (Standard Pipe Wrench for pipe barrel)</b>																								
56-000-1-075	RFII Wrench		\$81.00																					
<b>Technical Data Sheet: TFP515, Sprinkler Boot-TFP591</b>																								

Section 1  
Standard Spray Sprinklers

Section 2  
Extended Coverage Sprinklers

Section 3  
Storage Sprinklers

Section 4  
Residential Products

Section 5  
Dry Sprinklers

Section 6  
Special Sprinklers

Section 7  
Nozzles and Sprinkler Accessories

See latest Technical Data Sheets for specific Approvals, Listings, Design Parameters & available finishes. Sprinkler heads & escutcheons are priced separately unless otherwise noted.

Items marked "C.O." are made to order and may require longer delivery times. Please contact customer service for availability.

**Series DS-C, Dry Concealed, Quick Response, K=5.6, 3mm Bulb**

**DS-C QR Concealed**  
SIN TY3535

P/N 60 - 46 X - 1 - XXX

C.O. Temperature		Length (for example)	
1	155°F/68°C	060	6.00"
3	200°F/93°C	062	6.25"
		065	6.50"
		067	6.75"
		372	37.25"
		480	48.00"



60-46X-1-XXX

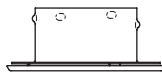

Cover Plate  
(Order Separately)

**Note: All Dry Sprinklers are special ordered and are Non-Returnable.**  
Please see "Terms & Conditions"  
**Note: All Dry Sprinklers are 4 7/8" Min. Length and 48" Max.**

C.O.	Length (48" Max)	List Price
	5" to 8"	\$200.50
	8-1/4" to 12"	\$214.50
	12-1/4" to 15"	\$229.00
	15-1/4" to 18"	\$242.50
	18-1/4" to 21"	\$256.00
	21-1/4" to 27"	\$270.50
	27-1/4" to 30"	\$285.00
	30-1/4" to 33"	\$299.50
	33-1/4" to 36"	\$311.50
	36-1/4" to 39"	\$325.50
	39-1/4" to 42"	\$340.00
	42-1/4" to 45"	\$352.50
	45-1/4" to 48"	\$368.50

**Cover Plates**

80 Box Quantity (14.5 lbs/box)

**Cover Plate (For use with 155° F Sprinkler)**

56-792-1-135	Brass	135°F/57°C	\$21.25
56-792-9-135	Chrome	135°F/57°C	\$21.25
56-792-0-135	Grey White	135°F/57°C	\$21.25
56-792-4-135	Signal (Bright) White	135°F/57°C	\$21.25
56-792-X-135	Special Order*	135°F/57°C	\$22.75

**Cover Plate (For use with 200° F Sprinkler)**

56-792-1-165	Brass	165°F/74°C	\$21.25
56-792-9-165	Chrome	165°F/74°C	\$21.25
56-792-0-165	Grey White	165°F/74°C	\$21.25
56-792-4-165	Signal (Bright) White	165°F/74°C	\$21.25
56-792-X-165	Special Order*	165°F/74°C	\$22.75

**Notes**

6012	*Special order paint match subject to set-up charge. (Net Price)	\$376.50
------	--	----------

**Dry Sprinkler Rubber Boot Kit**

63-000-0-002	DSB-2 Dry Sprinkler Boot Kit Includes: 1-EPDM Rubber Boot, 2-Nylon Ties, 1-1/3 oz tube of adhesive	\$43.50
--------------	---	---------

**Sprinkler Wrench** (Standard Pipe Wrench for pipe barrel)

56-000-1-075	RFII Wrench	\$81.00
--------------	-------------	---------

**Technical Data Sheet: TFP515,  
Sprinkler Boot-TFP591**

Items marked "C.O." are made to order and may require longer delivery times. Please contact customer service for availability.

See latest Technical Data Sheets for specific Approvals, Listings, Design Parameters & available finishes. Sprinkler heads & escutcheons are priced separately unless otherwise noted.

**Series DS-ECC, Dry Extended Concealed Coverage, Quick Response, K=5.6, 3mm Bulb**

**DS-ECC Extended Concealed Coverage**  
SIN TY3539

P/N 60 - 45 X - 1 - XXX

C.O. Temperature		Length (for example)	
1	155°F/68°C	060	6.00"
3	200°F/93°C	062	6.25"
		065	6.50"
		067	6.75"
		372	37.25"
		480	48.00"

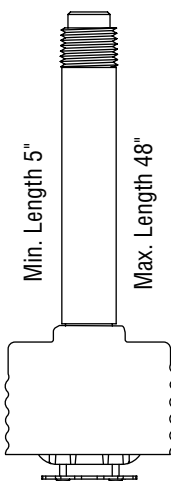

60-45X-1-XXX

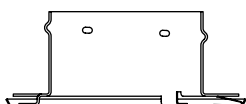

Cover Plate  
(Order Separately)

**Note: All Dry Sprinklers are special ordered and are Non-Returnable. Please see "Terms & Conditions"**

**Note: All Dry Sprinklers are 4 7/8" Min. Length and 48" Max.**

c.o.	Length (48" Max)	List Price
	5" to 8"	\$214.50
	8-1/4" to 12"	\$229.00
	12-1/4" to 15"	\$242.50
	15-1/4" to 18"	\$256.00
	18-1/4" to 21"	\$270.50
	21-1/4" to 27"	\$285.00
	27-1/4" to 30"	\$299.50
	30-1/4" to 33"	\$311.50
	33-1/4" to 36"	\$325.50
	36-1/4" to 39"	\$340.00
	39-1/4" to 42"	\$352.50
	42-1/4" to 45"	\$368.50
	45-1/4" to 48"	\$388.00

**Cover Plates**

80 Box Quantity (14.5 lbs/box)

**Cover Plate (For use with 155° F Sprinkler)**

56-792-1-135	Brass	135°F/57°C	\$21.25
56-792-9-135	Chrome	135°F/57°C	\$21.25
56-792-0-135	Grey White	135°F/57°C	\$21.25
56-792-4-135	Signal (Bright) White	135°F/57°C	\$21.25
56-792-X-135	Special Order*	135°F/57°C	\$22.75

**Cover Plate (For use with 200° F Sprinkler)**

56-792-1-165	Natural Brass	165°F/74°C	\$21.25
56-792-9-165	Bright Chrome	165°F/74°C	\$21.25
56-792-0-165	Grey White	165°F/74°C	\$21.25
56-792-4-165	Signal (Bright) White	165°F/74°C	\$21.25
56-792-X-165	Special Order*	165°F/74°C	\$22.75

**Notes**

6012	*Special order paint match subject to set-up charge. (Net Price)	\$376.50
------	--	----------

**Dry Sprinkler Rubber Boot Kit**

63-000-0-002	DSB-2 Dry Sprinkler Boot Kit Includes: 1-EPDM Rubber Boot, 2-Nylon Ties, 1-1/3 oz tube of adhesive	\$43.50
--------------	--	---------

**Sprinkler Wrench (Standard Pipe Wrench for pipe barrel)**

56-000-1-075	RFI Wrench	\$81.00
--------------	------------	---------

**Technical Data Sheet: TFP518,  
Sprinkler Boot-TFP591**

Section 1  
Standard Spray Sprinklers

Section 2  
Extended Coverage Sprinklers

Section 3  
Storage Sprinklers

Section 4  
Residential Products

Section 5  
Dry Sprinklers

Section 6  
Special Sprinklers

Section 7  
Nozzles and Sprinkler Accessories

See latest Technical Data Sheets for specific Approvals, Listings, Design Parameters & available finishes. Sprinkler heads & escutcheons are priced separately unless otherwise noted.

Items marked "C.O." are made to order and may require longer delivery times. Please contact customer service for availability.



Section 1 Standard Spray Sprinklers
Section 2 Extended Coverage Sprinklers
Section 3 Storage Sprinklers
Section 4 Residential Products
Section 5 Dry Sprinklers
Section 6 Special Sprinklers
Section 7 Nozzles and Sprinkler Accessories

Items marked "C.O." are made to order and may require longer delivery times.  
Please contact customer service for availability.

**Supersedes 3/4/2011**

See latest Technical Data Sheets for specific Approvals, Listings,  
Design Parameters & available finishes. Sprinkler heads & escutcheons  
are priced separately unless otherwise noted.

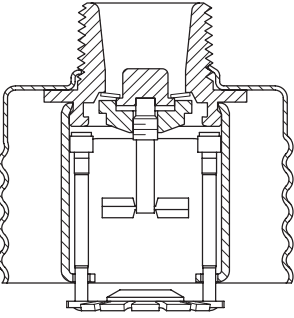
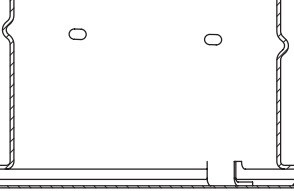
**Illusion™ Casino Sprinkler ELO Extra Large Orifice, Concealed Pendent Sprinklers, Quick Response, Standard Coverage, K=11.2, 3/4" N.P.T. (SIN TY5521)**

	C.O.	Part No.	Model	Finish	Temperature	List Price	
  <p>Note: All "Special Order" cover plates are special ordered and are Non-Returnable. Please see "Terms &amp; Conditions"</p>		<b>50-711-1-160</b>	Illusion Casino	Brass	160°F/71°C	\$41.75	
		<b>50-711-1-212</b>	Illusion Casino	Brass	212°F/100°C	\$41.75	
	<b>Cover Plates (Order Separately)</b>						
			<b>56-892-1-135</b>	Cover Plate	Brass	135°F/57°C	\$21.25
			<b>56-892-1-165</b>	Cover Plate	Brass	165°F/74°C	\$21.25
			<b>56-892-9-135</b>	Cover Plate	Chrome	135°F/57°C	\$21.25
			<b>56-892-9-165</b>	Cover Plate	Chrome	165°F/74°C	\$21.25
			<b>56-892-4-135</b>	Cover Plate	Signal White	135°F/57°C	\$21.25
			<b>56-892-4-165</b>	Cover Plate	Signal White	165°F/74°C	\$21.25
			<b>56-892-0-135</b>	Cover Plate	Grey White	135°F/57°C	\$21.25
			<b>56-892-0-165</b>	Cover Plate	Grey White	165°F/74°C	\$21.25
			<b>56-892-X-135</b>	Cover Plate	Special Order*	135°F/57°C	\$25.00
			<b>56-892-X-165</b>	Cover Plate	Special Order*	165°F/74°C	\$25.00
	<b>Clean Room Seals (Order Separately)</b>						
		<b>56-908-1-001</b>	Air and Dust Seal			\$12.00	
<b>Sprinkler Wrench</b>							
		<b>56-000-1-265</b>	W-Type 18 Wrench			\$81.00	
<b>Notes</b>							
		<b>6012</b>	*Special Order paint match subject to set-up charge. (Net Price)			\$376.50	
 <b>Technical Data Sheet: TFP184</b>							

Section 1  
Standard Spray Sprinklers

Section 2  
Extended Coverage Sprinklers

Section 3  
Storage Sprinklers

Section 4  
Residential Products

Section 5  
Dry Sprinklers

Section 6  
Special Sprinklers

Section 7  
Nozzles and Sprinkler Accessories

**CC2 Combustible Concealed Space Upright Sprinklers K=5.6, 1/2" N.P.T.**

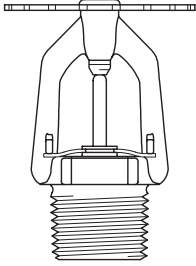
SIN TY3189							
	C.O.	No.	Model	Finish	Temp.	List Price	
		<b>51-301-1-175</b>	CC2	Brass	175°F/79°C	\$46.25	
	<b>Sprinkler Wrench</b>						
			<b>56-000-6-387</b>	W-Type 6 Wrench			\$48.75
<b>Technical Data Sheet: TFP632</b>							

See latest Technical Data Sheets for specific Approvals, Listings, Design Parameters & available finishes. Sprinkler heads & escutcheons are priced separately unless otherwise noted.

Items marked "C.O." are made to order and may require longer delivery times. Please contact customer service for availability.

**CC2 Combustible Concealed Space Upright Sprinklers K=4.2, 1/2" N.P.T.**

SIN TY2189

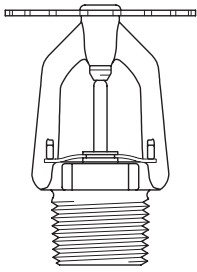

C.O.	No.	Model	Finish	Temp.	List Price
	51-311-1-175	CC2	Brass	175°F/79°C	\$42.50
<b>Sprinkler Wrench</b>					
	56-000-6-387	W-Type 6 Wrench			\$48.75

Technical Data Sheet: TFP632

**CC1 Combustible Concealed Upright Sprinklers K=2.8, 1/2" N.P.T.**

SIN TY1189

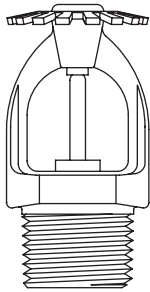

C.O.	No.	Model	Finish	Temp.	List Price
	50-300-1-175	CC1	Brass	175°F/79°C	\$43.75
<b>Sprinkler Wrench</b>					
	56-000-1-106	W-Type 20 Combination Wrench			\$81.00

Technical Data Sheet: TFP630

**WS Window Sprinklers K=5.6, 1/2" N.P.T.**

100 Box Quantity (VSW 20 lbs/box (SIN TY3488), HSW 17 lbs/box (SIN TY3388))

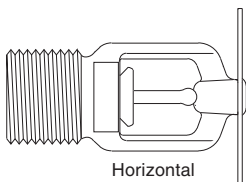
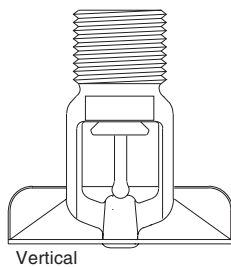

C.O.	No.	Model	Finish	Temperature	List Price
	50-305-1-155	Horizontal Sidewall	Brass	155°F/68°C	\$365.50
	50-305-1-200	Horizontal Sidewall	Brass	200°F/93°C	\$365.50
	50-305-9-155	Horizontal Sidewall	Chrome	155°F/68°C	\$365.50
	50-305-9-200	Horizontal Sidewall	Chrome	200°F/93°C	\$365.50
	50-305-4-155	Horizontal Sidewall	White	155°F/68°C	\$365.50
	50-305-4-200	Horizontal Sidewall	White	200°F/93°C	\$365.50
	50-304-1-155	Vertical Sidewall	Brass	155°F/68°C	\$365.50
	50-304-1-200	Vertical Sidewall	Brass	200°F/93°C	\$365.50
	50-304-9-155	Vertical Sidewall	Chrome	155°F/68°C	\$365.50
	50-304-9-200	Vertical Sidewall	Chrome	200°F/93°C	\$365.50
	50-304-4-155	Vertical Sidewall	White	155°F/68°C	\$365.50
	50-304-4-200	Vertical Sidewall	White	200°F/93°C	\$365.50

**Sprinkler Wrench**

	56-000-1-106	W-Type 20 Combination Wrench			\$81.00
--	--------------	------------------------------	--	--	---------



Technical Data Sheet: TFP620

Items marked "C.O." are made to order and may require longer delivery times. Please contact customer service for availability.

See latest Technical Data Sheets for specific Approvals, Listings, Design Parameters & available finishes. Sprinkler heads & escutcheons are priced separately unless otherwise noted.

**Attic Sprinklers K=4.2, K=5.6 & K=8.0, 1/2" and 3/4" N.P.T.**

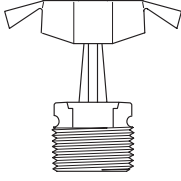
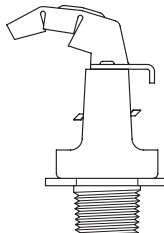
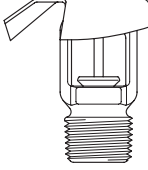
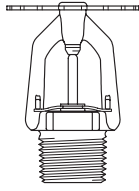
100 Box Quantity (BB/SD 31 lbs/box, HIP 22 lbs/box)

	C.O.	Part No.	Model	SIN Number	Pitch Rise over Run	Finish	K-Factor	Temperature	List Price
		51-623-1-200	ATTIC BB1, 17/32	TY4180	4/12 to < 7/12	Brass	8.0	200°F/93°C	\$193.50
		51-621-1-200	ATTIC BB2, 17/32	TY4181	7/12 to < 10/12	Brass	8.0	200°F/93°C	\$193.50
		51-622-1-200	ATTIC BB3, 17/32	TY4182	10/12 to 12/12	Brass	8.0	200°F/93°C	\$193.50
Back to Back (BB)		50-601-1-212	ATTIC BB1, 1/2	TY3180	4/12 to < 7/12	Brass	5.6	212°F/100°C	\$150.50
		50-602-1-212	ATTIC BB2, 1/2	TY3181	7/12 to < 10/12	Brass	5.6	212°F/100°C	\$150.50
		50-603-1-212	ATTIC BB3, 1/2	TY3182	10/12 to 12/12	Brass	5.6	212°F/100°C	\$150.50
		50-620-1-200	ATTIC BB1, 1/2	TY2180	4/12 to < 7/12	Brass	4.2	200°F/93°C	\$73.00
		50-621-1-200	ATTIC BB2, 1/2	TY2181	7/12 to < 10/12	Brass	4.2	200°F/93°C	\$73.00
		50-622-1-200	ATTIC BB3, 1/2	TY2182	10/12 to 12/12	Brass	4.2	200°F/93°C	\$73.00
Single Directional (SD)		50-611-1-212	ATTIC SD1, 1/2	TY3183	4/12 to < 7/12	Brass	5.6	212°F/100°C	\$150.50
		50-612-1-212	ATTIC SD2, 1/2	TY3184	7/12 to < 10/12	Brass	5.6	212°F/100°C	\$150.50
		50-613-1-212	ATTIC SD3, 1/2	TY3185	10/12 to 12/12	Brass	5.6	212°F/100°C	\$150.50
		51-620-1-200	ATTIC HIP	TY3187	4/12 to 12/12	Brass	5.6	200°F/93°C	\$150.50
		50-625-1-200	AP, 1/2, K=5.6	TY3190	3/12 to 12/12	Brass	5.6	200°F/93°C	\$27.00
		50-624-1-200	AP, 1/2, K=4.2	TY2190	3/12 to 12/12	Brass	4.2	200°F/93°C	\$27.00
	<b>Sprinkler Wrench</b>								
		56-895-1-001	W-Type 3 Wrench						\$67.25
		56-000-6-387	W-Type 6 Wrench						\$48.75
HIP		56-000-1-106	W-Type 20 Combination Wrench						\$81.00
	 <b>PEAK</b> <sup>TM</sup> <b>PERFORMANCE</b> ATTIC PROTECTION SPRINKLER SYSTEM Technical Data Sheet: TFP610								

Section 1  
Standard Spray Sprinklers

Section 2  
Extended Coverage Sprinklers

Section 3  
Storage Sprinklers

Section 4  
Residential Products

Section 5  
Dry Sprinklers

Section 6  
Special Sprinklers

Section 7  
Nozzles and Sprinkler Accessories

See latest Technical Data Sheets for specific Approvals, Listings, Design Parameters & available finishes. Sprinkler heads & escutcheons are priced separately unless otherwise noted.

Items marked "C.O." are made to order and may require longer delivery times. Please contact customer service for availability.



**Series TY-B , K=5.6 & K=8.0 - Stainless Steel and Titanium, - Standard Response Upright, Pendent, and Conventional Sprinklers**

P/N 57 — XXX — 0 — XXX — SUFFIX

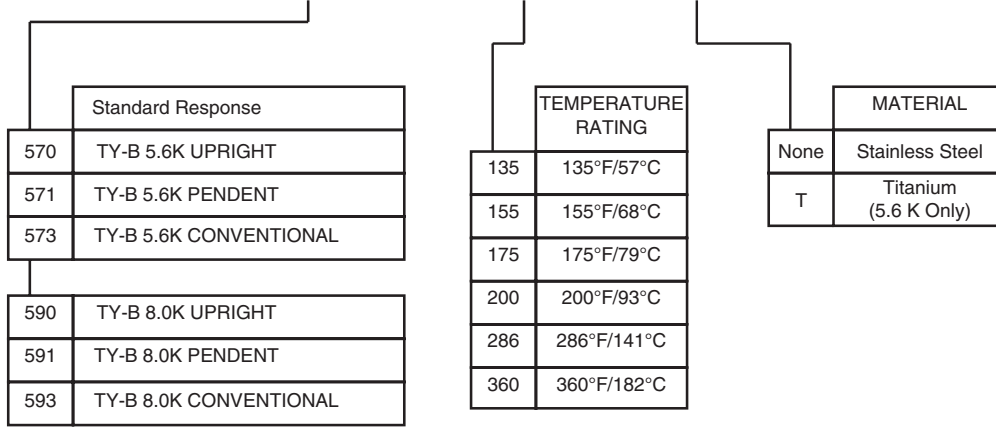

Product Symbol Numbers can be developed by using the table show above. Refer to the Technical data sheet for Sprinkler Identification Numbers. All response, orifice sizes, materials and finishes as follows:

Nozzle	Description	K-Factor	List Price
<b>57-570-0-XXX</b>	TY-B Upright, Standard Response	5.6	\$285.50
<b>57-571-0-XXX</b>	TY-B Pendent, Standard Response	5.6	\$285.50
<b>57-573-0-XXX</b>	TY-B Conventional, Standard Response	5.6	\$285.50
<b>57-XXX-0-XXX T</b>	Titanium Material - Add "T" Suffix (K=5.6 only)	5.6	POA
<b>57-590-0-XXX</b>	TY-B Upright, Standard Response	8.0	\$314.50
<b>57-591-0-XXX</b>	TY-B Pendent, Standard Response	8.0	\$314.50
<b>57-593-0-XXX</b>	TY-B Conventional, Standard Response	8.0	\$314.50
<b>Recessed Escutcheons (Order Separately)</b>			
<b>56-701-0-010</b>	1/2" Stainless Steel (Style 10), with White Paint Finish		\$17.50
<b>56-700-0-010</b>	3/4" Stainless Steel (Style 40), with White Paint Finish		\$17.50
<b>Sprinkler Wrench</b>			
<b>56-000-6-387</b>	W-Type 6 Wrench		\$48.75
<b>56-850-4-001</b>	W-Type 7 Wrench		\$81.00

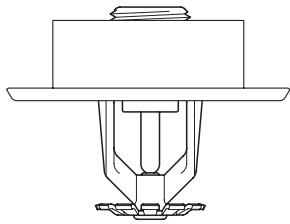

Note: TY-B Standard Response 1/2" NPT K=5.6 Sprinklers is shown

**Note: All Alternate Materials Sprinklers are special ordered and are Non-Returnable. Please see "Terms & Conditions"**  
**All Titanium Sprinklers are POA**

**Technical Data Sheet: TFP680**

Items marked "C.O." are made to order and may require longer delivery times. Please contact customer service for availability.

See latest Technical Data Sheets for specific Approvals, Listings, Design Parameters & available finishes. Sprinkler heads & escutcheons are priced separately unless otherwise noted.

**Series TY-B , K=5.6 - Stainless Steel and Titanium, - Standard Response  
Horizontal Sidewall and Recessed Horizontal Sidewall Sprinklers**

Product Symbol Numbers can be developed by using the table show above. Refer to the Technical data sheet for Sprinkler Identification Numbers. All response, orifice sizes, materials and finishes as follows:

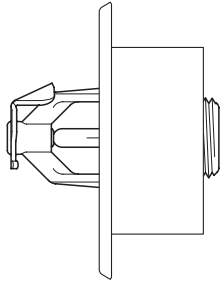
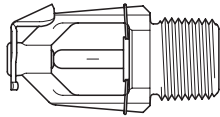

Note: TY-B Standard Response  
1/2" NPT K=5.6 Sprinklers is shown

Nozzle	Description	Temperature	K-Factor	List Price
<b>57-578-0-135</b>	TY-B Horizontal Sidewall, SR	135°F/57°C	5.6	\$285.50
<b>57-578-0-155</b>	TY-B Horizontal Sidewall, SR	155°F/68°C	5.6	\$285.50
<b>57-578-0-175</b>	TY-B Horizontal Sidewall, SR	175°F/79°C	5.6	\$285.50
<b>57-578-0-200</b>	TY-B Horizontal Sidewall, SR	200°F/93°C	5.6	\$285.50
<b>57-578-0-286</b>	TY-B Horizontal Sidewall, SR	286°F/141°C	5.6	\$285.50
<b>57-578-0-360</b>	TY-B Horizontal Sidewall, SR	360°F/182°C	5.6	\$285.50
<b>57-578-0-XXX T</b>	Titanium Material - Add "T" Suffix (K=5.6 only)		5.6	POA
<b>Recessed Escutcheons (Order Separately)</b>				
<b>56-701-0-010</b>	1/2" Stainless Steel (Style 10), with White Paint Finish			\$17.50
<b>Sprinkler Wrench</b>				
<b>56-000-6-387</b>	W-Type 6 Wrench			\$48.75
<b>56-850-4-001</b>	W-Type 7 Wrench			\$81.00

**Note: All Alternate Materials Sprinklers are special ordered and are Non-Returnable. Please see "Terms & Conditions"**  
**All Titanium Sprinklers are POA**

**Technical Data Sheet: TFP680**

Section 1  
Standard Spray Sprinklers

Section 2  
Extended Coverage Sprinklers

Section 3  
Storage Sprinklers

Section 4  
Residential Products

Section 5  
Dry Sprinklers

Section 6  
Special Sprinklers

Section 7  
Nozzles and Sprinkler Accessories

**Series TY-FRB , K=5.6 & K=8.0 - Stainless Steel and Titanium, - Quick Response Upright, Pendent, and Conventional Sprinklers**

P/N 57 — XXX — 0 — XXX — SUFFIX

Quick Response		TEMPERATURE RATING		MATERIAL	
370	TY-FRB 5.6K UPRIGHT	135	135°F/57°C	None	Stainless Steel
371	TY-FRB 5.6K PENDENT	155	155°F/68°C	T	Titanium (5.6 K Only)
373	TY-FRB 5.6K CONVENTIONAL	175	175°F/79°C		
		200	200°F/93°C		
390	TY-FRB 8.0K UPRIGHT	286	286°F/141°C		
391	TY-FRB 8.0K PENDENT				
393	TY-FRB 8.0K CONVENTIONAL				

Product Symbol Numbers can be developed by using the table show above. Refer to the Technical data sheet for Sprinkler Identification Numbers. All response, orifice sizes, materials and finishes as follows:

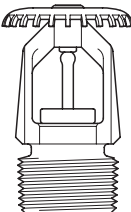
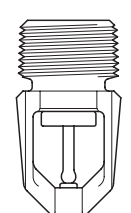
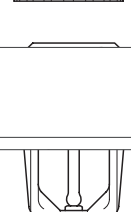
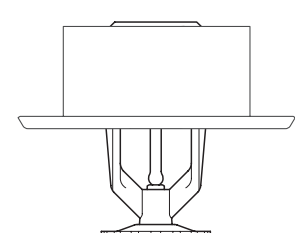
	Nozzle	Description	K-Factor	List Price
	<b>57-370-0-XXX</b>	TY-FRB Upright, Quick Response	5.6	\$285.50
	<b>57-371-0-XXX</b>	TY-FRB Pendent, Quick Response	5.6	\$285.50
	<b>57-373-0-XXX</b>	TY-FRB Conventional, Quick Response	5.6	\$285.50
	<b>57-XXX-0-XXX T</b>	Titanium Material - Add "T" Suffix (K=5.6 only)	5.6	\$603.50
	<b>57-390-0-XXX</b>	TY-FRB Upright, Quick Response	8.0	\$314.50
	<b>57-391-0-XXX</b>	TY-FRB Pendent, Quick Response	8.0	\$314.50
	<b>57-393-0-XXX</b>	TY-FRB Conventional, Quick Response	8.0	\$314.50
<b>Recessed Escutcheons (Order Separately)</b>				
	<b>56-701-0-010</b>	1/2" Stainless Steel (Style 10), with White Paint Finish		\$17.50
	<b>56-700-0-010</b>	3/4" Stainless Steel (Style 40), with White Paint Finish		\$17.50
<b>Sprinkler Wrench</b>				
	<b>56-000-6-387</b>	W-Type 6 Wrench		\$48.75
	<b>56-850-4-001</b>	W-Type 7 Wrench		\$81.00
<p><b>Note: All Alternate Materials Sprinklers are special ordered and are Non-Returnable. Please see "Terms &amp; Conditions"</b></p> <p><b>All Titanium Sprinklers are POA</b></p>				
<b>Technical Data Sheet: TFP680</b>				

Note: TY-FRB Standard Response 3/4" NPT K=8.0 Sprinklers is shown

Items marked "C.O." are made to order and may require longer delivery times. Please contact customer service for availability.

See latest Technical Data Sheets for specific Approvals, Listings, Design Parameters & available finishes. Sprinkler heads & escutcheons are priced separately unless otherwise noted.

**Series TY-FRB , K=5.6 - Stainless Steel and Titanium, - Quick Response  
Horizontal Sidewall and Recessed Horizontal Sidewall Sprinklers**

Product Symbol Numbers can be developed by using the table show above. Refer to the Technical data sheet for Sprinkler Identification Numbers. All response, orifice sizes, materials and finishes as follows:

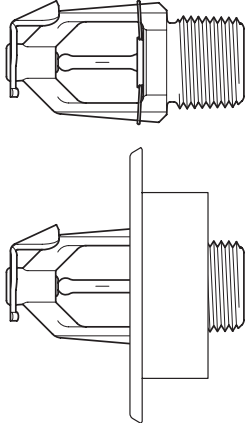
	Nozzle		Description		K-Factor	List Price	
 <p>Note: TY-FRB Standard Response 1/2" NPT K=5.6 Sprinklers is shown</p>	57-378-0-135		TY-B Horizontal Sidewall, QR	135°F/57°C	5.6	\$285.50	
	57-378-0-155		TY-B Horizontal Sidewall, QR	155°F/68°C	5.6	\$285.50	
	57-378-0-175		TY-B Horizontal Sidewall, QR	175°F/79°C	5.6	\$285.50	
	57-378-0-200		TY-B Horizontal Sidewall, QR	200°F/93°C	5.6	\$285.50	
	57-378-0-286		TY-B Horizontal Sidewall, QR	286°F/141°C	5.6	\$285.50	
	57-378-0-360		TY-B Horizontal Sidewall, QR	360°F/182°C	5.6	\$285.50	
	57-378-0-XXX T		Titanium Material - Add "T" Suffix (K=5.6 only)		5.6	\$603.50	
	<b>Recessed Escutcheons (Order Separately)</b>						
	56-701-0-010		1/2" Stainless Steel (Style 10), with White Paint Finish				\$17.50
	<b>Sprinkler Wrench</b>						
56-000-6-387		W-Type 6 Wrench				\$48.75	
56-850-4-001		W-Type 7 Wrench				\$81.00	
<p><b>Note: All Alternate Materials Sprinklers are special ordered and are Non-Returnable. Please see "Terms &amp; Conditions"</b></p> <p><b>All Titanium Sprinklers are POA</b></p>							
<b>Technical Data Sheet: TFP680</b>							

Section 1  
Standard Spray Sprinklers

Section 2  
Extended Coverage Sprinklers

Section 3  
Storage Sprinklers

Section 4  
Residential Products

Section 5  
Dry Sprinklers

Section 6  
Special Sprinklers

Section 7  
Nozzles and Sprinkler Accessories

See latest Technical Data Sheets for specific Approvals, Listings, Design Parameters & available finishes. Sprinkler heads & escutcheons are priced separately unless otherwise noted.

Items marked "C.O." are made to order and may require longer delivery times. Please contact customer service for availability.

**Tyco® RAVEN™, K=5.6, I-Series Institutional Pendent and Horizontal Sidewall, Quick Response, Standard and Extended Coverage Sprinklers**

Pendent - (Standard Coverage SIN TY3281), (Extended Coverage SIN TY3282)  
Horizontal Sidewall - (Standard Coverage SIN TY3381), (Extended Coverage SIN TY3382)

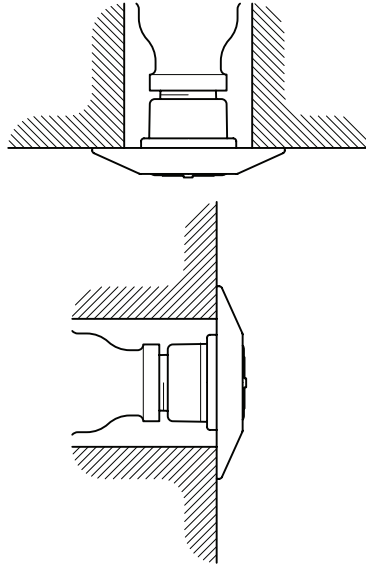

C.O.	Part Number	Finish	Coverage	Temperature	List Price
<b>Pendent</b>					
	<b>50-314-9-165</b>	Chrome	Standard	165°F/74°C	\$62.50
	<b>50-314-4-165</b>	White Color	Standard	165°F/74°C	\$62.50
	<b>50-315-9-165</b>	Chrome	Extended	165°F/74°C	\$63.50
	<b>50-315-4-165</b>	White Color	Extended	165°F/74°C	\$63.50
<b>Horizontal Sidewall</b>					
	<b>50-316-9-165</b>	Chrome	Standard	165°F/74°C	\$75.00
	<b>50-316-4-165</b>	White Color	Standard	165°F/74°C	\$75.00
	<b>50-317-9-165</b>	Chrome	Extended	165°F/74°C	\$74.50
	<b>50-317-4-165</b>	White Color	Extended	165°F/74°C	\$74.50
<b>Order Escutcheon Separately</b>					
	<b>56-314-9-010</b>	Chrome	Style F (3" Dia.)		\$18.75
	<b>56-314-4-010</b>	White Color	Style F (3" Dia.)		\$18.75
	<b>56-312-9-010</b>	Chrome	Style G (4" Dia.)		\$18.75
	<b>56-312-4-010</b>	White Color	Style G (4" Dia.)		\$18.75
<b>Accessories</b>					
	<b>56-000-1-781</b>	Centering Grommet – Model 1781			\$2.90
	<b>56-000-1-780</b>	Retaining Flange – Model 1780			\$34.75
	<b>56-000-1-755</b>	I-Series Adjustable Spacer Ring			\$0.40
<b>Sprinkler Wrench</b>					
	<b>56-314-1-001</b>	W-Type 25			\$141.50
<b>Technical Data Sheet: TFP651</b>					

Items marked "C.O." are made to order and may require longer delivery times. Please contact customer service for availability.

See latest Technical Data Sheets for specific Approvals, Listings, Design Parameters & available finishes. Sprinkler heads & escutcheons are priced separately unless otherwise noted.

**Supersedes 3/4/2011**

Section 1  
Standard Spray Sprinklers

Section 2  
Extended Coverage Sprinklers

Section 3  
Storage Sprinklers

Section 4  
Residential Products

Section 5  
Dry Sprinklers

Section 6  
Special Sprinklers

Section 7  
Nozzles and Sprinkler Accessories

**TY-B, 5mm Bulb, K=5.6, 1/2" NPT Conventional (Old Style) Sprinklers**

100 Box Quantity (18 lbs/box) (SIN TY3651)

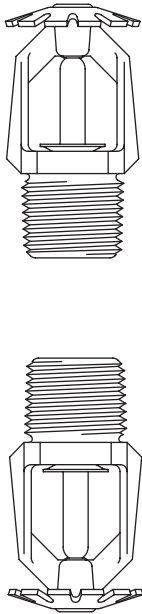
	<i>C.O.</i>	<i>Conventional</i>	<i>Finish</i>	<i>Temperature</i>	<i>List Price</i>
	▶	57-573-1-135	Brass	135°F/57°C	\$20.50
		57-573-1-155	Brass	155°F/68°C	\$20.50
	▶	57-573-1-175	Brass	175°F/79°C	\$20.50
	▶	57-573-1-200	Brass	200°F/93°C	\$20.50
		57-573-1-286	Brass	286°F/141°C	\$20.50
	▶	57-573-1-360	Brass	360°F/182°C	\$23.25
	▶	57-573-9-135	Chrome	135°F/57°C	\$23.25
		57-573-9-155	Chrome	155°F/68°C	\$23.25
	▶	57-573-9-175	Chrome	175°F/79°C	\$23.25
	▶	57-573-9-200	Chrome	200°F/93°C	\$23.25
	▶	57-573-9-286	Chrome	286°F/141°C	\$23.25
	▶	57-573-9-360	Chrome	360°F/182°C	\$26.25
	▶	57-573-4-135	White	135°F/57°C	\$23.25
		57-573-4-155	White	155°F/68°C	\$23.25
	▶	57-573-4-175	White	175°F/79°C	\$23.25
	▶	57-573-4-200	White	200°F/93°C	\$23.25
	▶	57-573-4-286	White	286°F/141°C	\$23.25
	▶	57-573-4-360	White	360°F/182°C	\$26.25
	▶	57-573-7-135	Lead Coated	135°F/57°C	\$59.75
	▶	57-573-7-155	Lead Coated	155°F/68°C	\$59.75
	▶	57-573-7-175	Lead Coated	175°F/79°C	\$59.75
	▶	57-573-7-200	Lead Coated	200°F/93°C	\$59.75
	▶	57-573-7-286	Lead Coated	286°F/141°C	\$59.75
	▶	57-573-7-360	Lead Coated	360°F/182°C	\$59.75
	▶	57-573-6-135	Wax Coated	135°F/57°C	\$56.00
	▶	57-573-6-155	Wax Coated	155°F/68°C	\$56.00
	▶	57-573-6-175	Wax Coated	175°F/79°C	\$56.00
	▶	57-573-6-200	Wax Coated	200°F/93°C	\$56.00
▶	57-573-6-286	Wax Coated	286°F/141°C	\$56.00	
▶	57-573-8-135	Wax over Lead Coated	135°F/57°C	\$79.25	
▶	57-573-8-155	Wax over Lead Coated	155°F/68°C	\$79.25	
▶	57-573-8-175	Wax over Lead Coated	175°F/79°C	\$79.25	
▶	57-573-8-200	Wax over Lead Coated	200°F/93°C	\$79.25	
▶	57-573-8-286	Wax over Lead Coated	286°F/141°C	\$79.25	
<b>Sprinkler Wrench</b>					
		56-000-6-387	W-Type 6 Wrench		\$48.75
<b>Technical Data Sheet: TFP661</b>					

Section 1	Standard Spray Sprinklers
Section 2	Extended Coverage Sprinklers
Section 3	Storage Sprinklers
Section 4	Residential Products
Section 5	Dry Sprinklers
Section 6	Special Sprinklers
Section 7	Nozzles and Sprinkler Accessories

See latest Technical Data Sheets for specific Approvals, Listings, Design Parameters & available finishes. Sprinkler heads & escutcheons are priced separately unless otherwise noted.

Items marked "C.O." are made to order and may require longer delivery times. Please contact customer service for availability.

**TY-B, 5mm Bulb, K=8.0, 3/4" NPT Conventional (Old Style) Sprinklers**

100 Box Quantity (21 lbs/box) (SIN TY4651)

	<i>C.O.</i>	<i>Conventional</i>	<i>Finish</i>	<i>Temperature</i>	<i>List Price</i>
Section 1 Standard Spray Sprinklers	▶	57-593-1-135	Brass	135°F/57°C	\$22.75
		57-593-1-155	Brass	155°F/68°C	\$22.75
	▶	57-593-1-175	Brass	175°F/79°C	\$22.75
	▶	57-593-1-200	Brass	200°F/93°C	\$22.75
		57-593-1-286	Brass	286°F/141°C	\$22.75
	▶	57-593-1-360	Brass	360°F/182°C	\$25.50
Section 2 Extended Coverage Sprinklers	▶	57-593-9-135	Chrome	135°F/57°C	\$26.25
		57-593-9-155	Chrome	155°F/68°C	\$26.25
	▶	57-593-9-175	Chrome	175°F/79°C	\$26.25
	▶	57-593-9-200	Chrome	200°F/93°C	\$26.25
	▶	57-593-9-286	Chrome	286°F/141°C	\$26.25
	▶	57-593-9-360	Chrome	360°F/182°C	\$29.75
Section 3 Storage Sprinklers	▶	57-593-4-135	White	135°F/57°C	\$26.25
		57-593-4-155	White	155°F/68°C	\$26.25
	▶	57-593-4-175	White	175°F/79°C	\$26.25
	▶	57-593-4-200	White	200°F/93°C	\$26.25
	▶	57-593-4-286	White	286°F/141°C	\$26.25
	▶	57-593-4-360	White	360°F/182°C	\$29.75
Section 4 Residential Products	▶	57-593-7-135	Lead Coated	135°F/57°C	\$64.25
	▶	57-593-7-155	Lead Coated	155°F/68°C	\$64.25
	▶	57-593-7-175	Lead Coated	175°F/79°C	\$64.25
	▶	57-593-7-200	Lead Coated	200°F/93°C	\$64.25
	▶	57-593-7-286	Lead Coated	286°F/141°C	\$64.25
	▶	57-593-7-360	Lead Coated	360°F/182°C	\$64.25
Section 5 Dry Sprinklers	▶	57-593-6-135	Wax Coated	135°F/57°C	\$59.75
	▶	57-593-6-155	Wax Coated	155°F/68°C	\$59.75
	▶	57-593-6-175	Wax Coated	175°F/79°C	\$59.75
	▶	57-593-6-200	Wax Coated	200°F/93°C	\$59.75
	▶	57-593-6-286	Wax Coated	286°F/141°C	\$59.75
Section 6 Special Sprinklers	▶	57-593-8-135	Wax over Lead Coated	135°F/57°C	\$84.50
	▶	57-593-8-155	Wax over Lead Coated	155°F/68°C	\$84.50
	▶	57-593-8-175	Wax over Lead Coated	175°F/79°C	\$84.50
	▶	57-593-8-200	Wax over Lead Coated	200°F/93°C	\$84.50
	▶	57-593-8-286	Wax over Lead Coated	286°F/141°C	\$84.50
<b>Sprinkler Wrench</b>					
		56-000-6-387	W-Type 6 Wrench		\$48.75
<b>Technical Data Sheet: TFP661</b>					

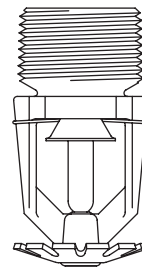
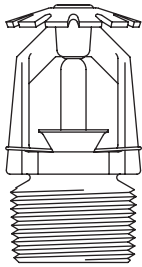

Items marked "C.O." are made to order and may require longer delivery times. Please contact customer service for availability.

See latest Technical Data Sheets for specific Approvals, Listings, Design Parameters & available finishes. Sprinkler heads & escutcheons are priced separately unless otherwise noted.

Section 1  
Standard Spray Sprinklers

Section 2  
Extended Coverage Sprinklers

Section 3  
Storage Sprinklers

Section 4  
Residential Products

Section 5  
Dry Sprinklers

Section 6  
Special Sprinklers

Section 7  
Nozzles and Sprinkler Accessories



**TY-FRB, 3mm Bulb, Quick Response, K=5.6, 1/2" NPT Conventional (Old Style) Sprinklers**

100 Box Quantity (18 lbs/box) (SIN TY3631)

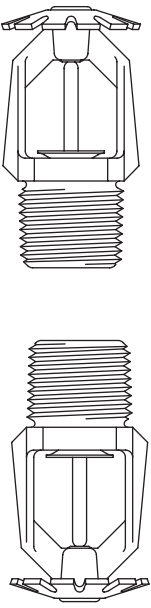
	<i>C.O.</i>	<i>Conventional</i>	<i>Finish</i>	<i>Temperature</i>	<i>List Price</i>
	▶	<b>57-373-1-135</b>	Brass	135°F/57°C	\$40.75
		<b>57-373-1-155</b>	Brass	155°F/68°C	\$40.75
	▶	<b>57-373-1-175</b>	Brass	175°F/79°C	\$40.75
	▶	<b>57-373-1-200</b>	Brass	200°F/93°C	\$40.75
		<b>57-373-1-286</b>	Brass	286°F/141°C	\$40.75
	▶	<b>57-373-9-135</b>	Chrome	135°F/57°C	\$42.75
		<b>57-373-9-155</b>	Chrome	155°F/68°C	\$42.75
	▶	<b>57-373-9-175</b>	Chrome	175°F/79°C	\$42.75
	▶	<b>57-373-9-200</b>	Chrome	200°F/93°C	\$42.75
	▶	<b>57-373-9-286</b>	Chrome	286°F/141°C	\$42.75
	▶	<b>57-373-4-135</b>	White	135°F/57°C	\$42.75
		<b>57-373-4-155</b>	White	155°F/68°C	\$42.75
	▶	<b>57-373-4-175</b>	White	175°F/79°C	\$42.75
	▶	<b>57-373-4-200</b>	White	200°F/93°C	\$42.75
	▶	<b>57-373-4-286</b>	White	286°F/141°C	\$42.75
	▶	<b>57-373-7-135</b>	Lead Coated	135°F/57°C	\$103.00
	▶	<b>57-373-7-155</b>	Lead Coated	155°F/68°C	\$103.00
	▶	<b>57-373-7-175</b>	Lead Coated	175°F/79°C	\$103.00
	▶	<b>57-373-7-200</b>	Lead Coated	200°F/93°C	\$103.00
	▶	<b>57-373-7-286</b>	Lead Coated	286°F/141°C	\$103.00
<b>Sprinkler Wrench</b>					
		<b>56-000-6-387</b>	W-Type 6 Wrench		\$48.75
<b>Technical Data Sheet: TFP666</b>					

Section 1	Standard Spray Sprinklers
Section 2	Extended Coverage Sprinklers
Section 3	Storage Sprinklers
Section 4	Residential Products
Section 5	Dry Sprinklers
Section 6	Special Sprinklers
Section 7	Nozzles and Sprinkler Accessories

See latest Technical Data Sheets for specific Approvals, Listings, Design Parameters & available finishes. Sprinkler heads & escutcheons are priced separately unless otherwise noted.

Items marked "C.O." are made to order and may require longer delivery times. Please contact customer service for availability.

**TY-FRB, 3mm Bulb, Quick Response, K=8.0, 3/4" NPT Conventional (Old Style) Sprinklers**

•100 Box Quantity (21 lbs/box) (SIN TY4631)

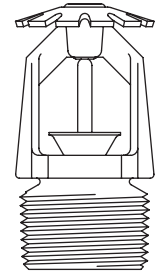
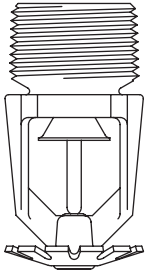
	<i>C.O.</i>	<i>Conventional</i>	<i>Finish</i>	<i>Temperature</i>	<i>List Price</i>
	▶	<b>57-393-1-135</b>	Brass	135°F/57°C	\$45.75
		<b>57-393-1-155</b>	Brass	155°F/68°C	\$45.75
	▶	<b>57-393-1-175</b>	Brass	175°F/79°C	\$45.75
	▶	<b>57-393-1-200</b>	Brass	200°F/93°C	\$45.75
		<b>57-393-1-286</b>	Brass	286°F/141°C	\$45.75
	▶	<b>57-393-9-135</b>	Chrome	135°F/57°C	\$49.50
		<b>57-393-9-155</b>	Chrome	155°F/68°C	\$49.50
	▶	<b>57-393-9-175</b>	Chrome	175°F/79°C	\$49.50
	▶	<b>57-393-9-200</b>	Chrome	200°F/93°C	\$49.50
	▶	<b>57-393-9-286</b>	Chrome	286°F/141°C	\$49.50
	▶	<b>57-393-4-135</b>	White	135°F/57°C	\$49.50
		<b>57-393-4-155</b>	White	155°F/68°C	\$49.50
	▶	<b>57-393-4-175</b>	White	175°F/79°C	\$49.50
	▶	<b>57-393-4-200</b>	White	200°F/93°C	\$49.50
	▶	<b>57-393-4-286</b>	White	286°F/141°C	\$49.50
	▶	<b>57-393-7-135</b>	Lead Coated	135°F/57°C	\$116.00
	▶	<b>57-393-7-155</b>	Lead Coated	155°F/68°C	\$116.00
	▶	<b>57-393-7-175</b>	Lead Coated	175°F/79°C	\$116.00
	▶	<b>57-393-7-200</b>	Lead Coated	200°F/93°C	\$116.00
	▶	<b>57-393-7-286</b>	Lead Coated	286°F/141°C	\$116.00
<b>Sprinkler Wrench</b>					
		<b>56-000-6-387</b>	W-Type 6 Wrench		\$48.75
<b>Technical Data Sheet: TFP666</b>					

Items marked "C.O." are made to order and may require longer delivery times. Please contact customer service for availability.

See latest Technical Data Sheets for specific Approvals, Listings, Design Parameters & available finishes. Sprinkler heads & escutcheons are priced separately unless otherwise noted.

**Supersedes 3/4/2011**

Section 1  
Standard Spray Sprinklers

Section 2  
Extended Coverage Sprinklers

Section 3  
Storage Sprinklers

Section 4  
Residential Products

Section 5  
Dry Sprinklers

Section 6  
Special Sprinklers

Section 7  
Nozzles and Sprinkler Accessories

**Issue "D" Quartzoid® Series – High Temperature, K=5.6, 1/2" NPT, Special Sprinklers Issue D**

100 Box Quantity (Upright 27.5 lbs/box (SIN TY3191), Pendent 27.5 lbs/box (SIN TY3296))

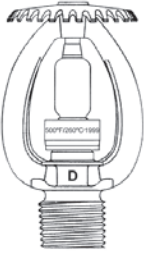
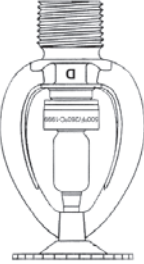
	<i>C.O.</i>	<i>Upright</i>	<i>Pendent</i>	<i>Finish</i>	<i>Temperature</i>	<i>List Price</i>
 	▶	<b>51-036-1-400</b>	<b>51-040-1-400</b>	Brass	400°F/204°C	\$125.00
	▶	<b>51-036-1-500</b>	<b>51-040-1-500</b>	Brass	500°F/260°C	\$125.00
	▶	<b>51-036-1-650</b>	<b>51-040-1-650</b>	Brass	650°F/343°C	\$342.50
	▶	<b>51-036-9-400</b>	<b>51-040-9-400</b>	Chrome	500°F/260°C	\$166.50
	▶	<b>51-036-9-500</b>	<b>51-040-9-500</b>	Chrome	500°F/260°C	\$166.50
	▶	<b>51-036-9-650</b>	<b>51-040-9-650</b>	Chrome	650°F/343°C	\$452.00
	▶	<b>51-036-7-400</b>	<b>51-040-7-400</b>	Lead Coated	400°F/204°C	\$154.50
	▶	<b>51-036-7-500</b>	<b>51-040-7-500</b>	Lead Coated	500°F/260°C	\$154.50
<b>Sprinkler Wrench</b>						
		<b>56-452-1-001</b>	W-Type 11 Wrench			\$29.50
<p><b>Note: All High Temperature Sprinklers are special ordered and are Non-Returnable. Please see "Terms &amp; Conditions"</b></p> <p><b>Technical Data Sheet: TFP690</b></p>						

Section 1  
Standard Spray Sprinklers

Section 2  
Extended Coverage Sprinklers

Section 3  
Storage Sprinklers

Section 4  
Residential Products

Section 5  
Dry Sprinklers

Section 6  
Special Sprinklers

Section 7  
Nozzles and Sprinkler Accessories

See latest Technical Data Sheets for specific Approvals, Listings, Design Parameters & available finishes. Sprinkler heads & escutcheons are priced separately unless otherwise noted.

Items marked "C.O." are made to order and may require longer delivery times. Please contact customer service for availability.

**Issue "D" Quartzoid® Series – High Temperature, K=8.0, 3/4" NPT, Special Sprinklers Issue D**

100 Box Quantity (Upright 27.5 lbs/box (SIN TY4191), Pendent 27.5 lbs/box (SIN TY4291))

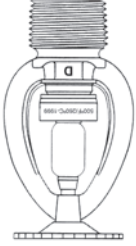
	C.O.	Upright	Pendent	Finish	Temperature	List Price
	▶	51-136-1-400	51-140-1-400	Brass	400°F/204°C	\$166.50
	▶	51-136-1-500	51-140-1-500	Brass	500°F/260°C	\$166.50
	▶	51-136-9-400	51-140-9-400	Chrome	400°F/204°C	\$168.00
	▶	51-136-9-500	51-140-9-500	Chrome	500°F/260°C	\$168.00
	▶	51-136-7-400	51-140-7-400	Lead Coated	400°F/204°C	\$195.00
	▶	51-136-7-500	51-140-7-500	Lead Coated	500°F/260°C	\$195.00
	▶	51-136-8-400	51-140-8-400	Wax over Lead Coated	400°F/204°C	\$219.00
	▶	51-136-8-500	51-140-8-500	Wax over Lead Coated	500°F/260°C	\$219.00
	<b>Sprinkler Wrench</b>					
		56-452-1-001	W-Type 11 Wrench			\$29.50
<p><b>Note: All High Temperature Sprinklers are special ordered and are Non-Returnable. Please see "Terms &amp; Conditions"</b></p> <p><b>Technical Data Sheet: TFP690</b></p>						

Section 1  
Standard Spray Sprinklers

Section 2  
Extended Coverage Sprinklers

Section 3  
Storage Sprinklers

Section 4  
Residential Products

Section 5  
Dry Sprinklers

Section 6  
Special Sprinklers

Section 7  
Nozzles and Sprinkler Accessories

Items marked "C.O." are made to order and may require longer delivery times. Please contact customer service for availability.

See latest Technical Data Sheets for specific Approvals, Listings, Design Parameters & available finishes. Sprinkler heads & escutcheons are priced separately unless otherwise noted.

**Protectospray Nozzles Model D-3**  
**Orifice Size #16 to #34 Inclusive with 1/2" NPT Connection, Brass**

**Protectospray Nozzles**

Protectospray Nozzles are available as open nozzles (D Series) or as a bulb type nozzle (EA-1 Series). Both types are available with deflectors designed to produce discharge patterns having included angles of : 65, 80, 95, 110, 125, 140, 160 and 180 degree

**49 - 3XX - X - XXX**

ORIFICE		FINISH & MATERIAL		ANGLE	
16	.206" (1/2" NPT)	1	PLAIN BRASS	065	65°
18	.250" (1/2" NPT)	7	LEADED COATED BRASS	080	80°
21	.281" (1/2" NPT)	4	TEFLON COATED BRASS	095	95°
24	.328" (1/2" NPT)	9	CHROME PLATED BRASS	110	110°
28	.375" (1/2" NPT)	0	PLAIN STAINLESS STEEL 1/2" NPT only.	125	125°
32	.438" (1/2" NPT)			140	140°
34	.500" (1/2" NPT)			160	160°
				180	180°

Orifice size of "D" Series nozzles is by numerical designations with decimal inch equivalents. Product Symbol Numbers for D Series nozzles can be developed by using the table show above. All discharge spray pattern, orifice sizes, materials and finishes as follows:

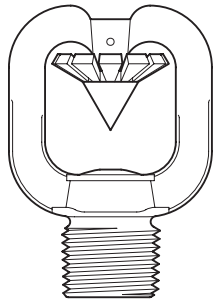

Nozzle	Finish	List Price
<b>49-3XX-1-XXX</b>	Plain	\$105.50
<b>49-3XX-7-XXX</b>	Lead Coated *	\$130.50
<b>49-3XX-4-XXX</b>	Teflon Coated *	\$253.50
<b>49-3XX-9-XXX</b>	Chrome Plated	\$127.00
<b>49-3XX-0-XXX</b>	Stainless	\$460.50
Notes		
<b>6012</b>	*Special Order Lead or Teflon coating subject to set-up charge. (Net Price)	\$376.50

**Note: All Protectospray Nozzles are special ordered and are Non-Returnable. Please see "Terms & Conditions"**

**Technical Data Sheet: TFP 802**

**Protectospray Nozzles, Model EA-1**

**49 - XXX - X - XXX**

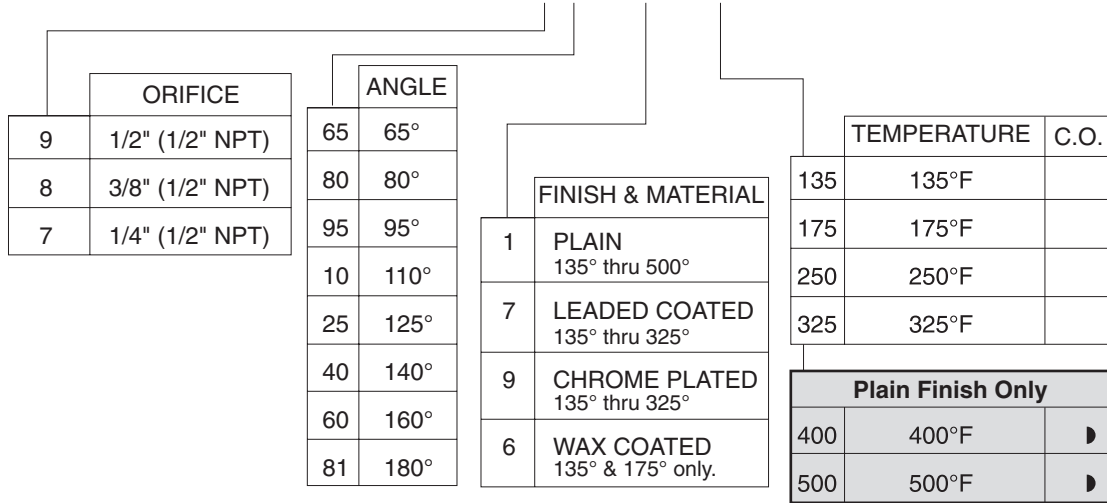

Product Symbol Numbers for Model EA-1 Protectospray Nozzles can be determined by using the following table.

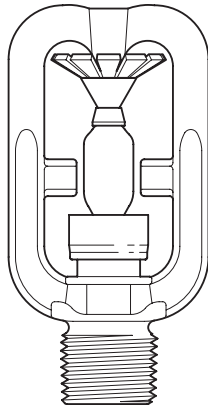

**Note: All Protectospray Nozzles are special ordered and are Non-Returnable. Please see "Terms & Conditions"**

Nozzle	Finish	List Price
<b>1/2" Protectospray Nozzles Model EA-1</b>		
49-9XX-1-XXX	Plain (135° - 325°)	\$244.50
49-9XX-1-400	<b>Plain (Only)</b>	\$437.50
49-9XX-1-500	<b>Plain (Only)</b>	\$438.50
49-9XX-7-XXX	Lead Coated *	\$315.00
49-9XX-9-XXX	Chrome Plated	\$335.00
49-9XX-6-XXX	Wax Coated	\$305.50
<b>1/4" Protectospray Nozzles Model EA-1</b>		
49-7XX-1-XXX	Plain (135° - 325°)	\$319.00
49-7XX-1-400	<b>Plain (Only)</b>	\$572.00
49-7XX-1-500	<b>Plain (Only)</b>	\$572.00
49-7XX-7-XXX	Lead Coated *	\$395.50
49-7XX-9-XXX	Chrome Plated	\$440.50
49-7XX-6-XXX	Wax Coated	\$377.50
<b>3/8" Protectospray Nozzles Model EA-1</b>		
49-8XX-1-XXX	Plain (135° - 325°)	\$309.00
49-8XX-1-400	<b>Plain (Only)</b>	\$551.50
49-8XX-1-500	<b>Plain (Only)</b>	\$551.50
49-8XX-7-XXX	Lead Coated *	\$377.50
49-8XX-9-XXX	Chrome Plated	\$418.50
49-8XX-6-XXX	Wax Coated	\$366.00
<b>Notes</b>		
<b>Temperatures of 400° F &amp; 500° F Available in Plain Finish Only</b>		
6012	*Special Order Lead coating subject to set-up charge. (Net Price)	\$376.50
<b>Technical Data Sheet: TFP 800</b>		

Items marked "C.O." are made to order and may require longer delivery times. Please contact customer service for availability.

See latest Technical Data Sheets for specific Approvals, Listings, Design Parameters & available finishes. Sprinkler heads & escutcheons are priced separately unless otherwise noted.

**Mulsifyre Nozzles, 800 Series, 3/4" NPT Connection**

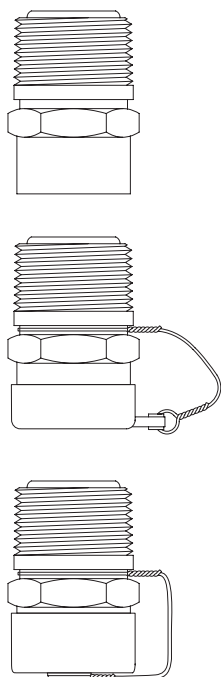
	Nozzle	Description	List Price
 <p><b>Note: All Mulsifyre Nozzles are special ordered and are Non-Returnable. Please see "Terms &amp; Conditions"</b></p>	<b>Without Blow-Off Cap</b>		
	49-800-1-822	Model F822	\$132.00
	49-800-1-824	Model F824	\$132.00
	49-800-1-826	Model F826	\$132.00
	49-800-1-828	Model F828	\$132.00
	49-800-1-832	Model F832	\$132.00
	49-800-1-834	Model F834	\$132.00
	<b>With Dust Cap</b>		
	49-801-1-822	Model F822	\$178.50
	49-801-1-824	Model F824	\$178.50
	49-801-1-826	Model F826	\$178.50
	49-801-1-828	Model F828	\$178.50
	49-801-1-832	Model F832	\$178.50
	49-801-1-834	Model F834	\$178.50
	<b>With Blow-Off Cap</b>		
	49-802-1-822	Model F822B	\$457.50
	49-802-1-824	Model F824B	\$457.50
	49-802-1-826	Model F826B	\$457.50
	49-802-1-828	Model F828B	\$457.50
	49-802-1-832	Model F832B	\$457.50
	49-802-1-834	Model F834B	\$457.50
<b>Technical Data Sheet: TFP810</b>			

Section 1  
Standard Spray Sprinklers

Section 2  
Extended Coverage Sprinklers

Section 3  
Storage Sprinklers

Section 4  
Residential Products

Section 5  
Dry Sprinklers

Section 6  
Special Sprinklers

Section 7  
Nozzles and Sprinkler Accessories

**High Velocity Spray Nozzles Type HV**

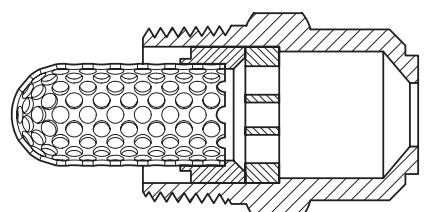
	Nozzle	Description	Finish	List Price	
 <p><b>Note: All High Velocity Spray Nozzles are special ordered and are Non-Returnable. Please see "Terms &amp; Conditions"</b></p>	49-014-1-001	HV 14	Brass	\$184.00	
	49-017-1-001	HV 17	Brass	\$226.50	
	49-026-1-001	HV 26	Brass	\$226.50	
	49-037-1-001	HV 37	Brass	\$226.50	
	49-045-1-001	HV 45	Brass	\$226.50	
	49-060-1-001	HV 60	Brass	\$215.00	
	49-014-0-001	HV 14	Stainless Steel	\$525.50	
	49-017-0-001	HV 17	Stainless Steel	\$525.50	
	49-026-0-001	HV 26	Stainless Steel	\$525.50	
	49-037-0-001	HV 37	Stainless Steel	\$525.50	
	49-045-0-001	HV 45	Stainless Steel	\$525.50	
	49-060-0-001	HV 60	Stainless Steel	\$525.50	
	<b>Technical Data Sheet: TFP 815</b>				

See latest Technical Data Sheets for specific Approvals, Listings, Design Parameters & available finishes. Sprinkler heads & escutcheons are priced separately unless otherwise noted.

Items marked "C.O." are made to order and may require longer delivery times. Please contact customer service for availability.



**3/4" NPT, K=2.90, Open Nozzle for Cooling Towers, Type 1 and Type 2**

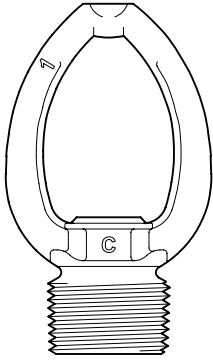

Nozzle	Type, Finish	List Price
50-081-1-000	Type 1, Brass	\$135.00
50-081-0-001	Type 1, Stainless Steel	\$180.00
50-082-1-001	Type 2, Brass	\$135.00
50-082-0-001	Type 2, Stainless Steel	\$180.00
<b>Sprinkler Wrench</b>		
56-452-1-001	W-Type 11 Wrench	\$29.50

Technical Data Sheet: TFP830

**Model A and Model B, 1/2" NPT, Exposure Nozzles**

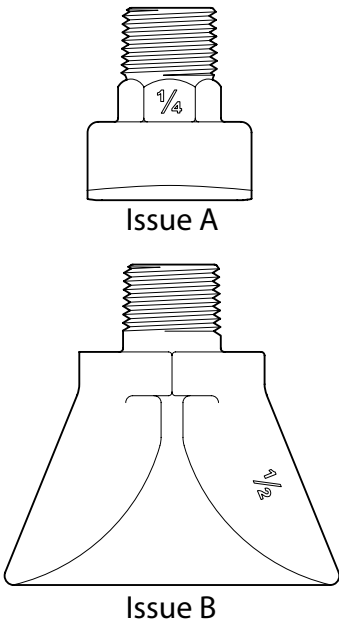

**49 - XXX - X - XXX**

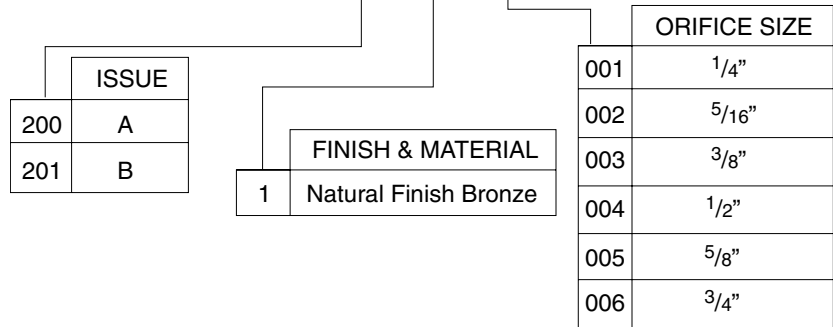

Exposure Sprinkler	Orifice, Finish	List Price
49-200-1-XXX	Issue A, Natural Bronze	\$157.00
49-201-1-XXX	Issue B, Natural Bronze	\$208.00

Technical Data Sheet: TFP 835

Items marked "C.O." are made to order and may require longer delivery times. Please contact customer service for availability.

See latest Technical Data Sheets for specific Approvals, Listings, Design Parameters & available finishes. Sprinkler heads & escutcheons are priced separately unless otherwise noted.

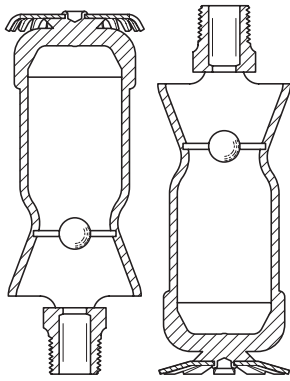
Model B-1, 1/2" Foam Water Sprinkler, 1/2" Male NPT			
	Upright Deflector	Pendent Deflector	List Price
	49-210-1-001	49-211-1-001	\$344.50
Technical Data Sheet: TFP 840			

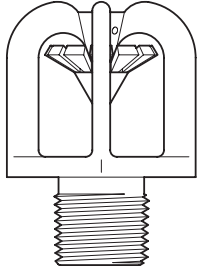
U.S. Navy Nozzle Type G, 1/2" NPT			
	Nozzle	Finish	List Price
	49-554-1-328	Bronze, Type G	\$403.50
<p><b>Note: All Nozzles are special ordered and are Non-Returnable. Please see "Terms &amp; Conditions"</b></p> <p>Technical Data Sheet: TFP 820</p>			

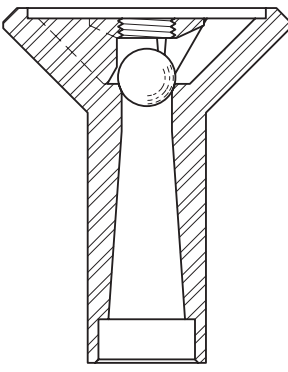
U.S. Navy Nozzle Type SB, 1/2" NPT			
	Nozzle	Finish	List Price
	49-556-1-012	Stainless Steel, Type SB	\$730.00
	<b>Type SB Replacement Kits:</b>		
	91-556-1-001	Stainless Steel Kit	\$329.00
	91-556-1-004	Threaded Insert Installation Tool	\$135.50
<p><b>Note: All Nozzles are special ordered and are Non-Returnable. Please see "Terms &amp; Conditions"</b></p> <p>Technical Data Sheet: TFP 825</p>			

See latest Technical Data Sheets for specific Approvals, Listings, Design Parameters & available finishes. Sprinkler heads & escutcheons are priced separately unless otherwise noted.

Items marked "C.O." are made to order and may require longer delivery times. Please contact customer service for availability.

Section 1  
Standard Spray Sprinklers  
  
 Section 2  
Extended Coverage Sprinklers  
  
 Section 3  
Storage Sprinklers  
  
 Section 4  
Residential Products  
  
 Section 5  
Dry Sprinklers  
  
 Section 6  
Special Sprinklers  
  
 Section 7  
Nozzles and Sprinkler Accessories

Section 1  
Standard Spray Sprinklers

Section 2  
Extended Coverage Sprinklers

Section 3  
Storage Sprinklers

Section 4  
Residential Products

Section 5  
Dry Sprinklers

Section 6  
Special Sprinklers

Section 7  
Nozzles and Sprinkler Accessories

**Protectospray Nozzle, Type D4-a, 1/2" NPT**

**49 - 4XX - X - XXX**

ORIFICE		SPRAY ANGLE	
16	No. 16	065	65°
18	No. 18	080	80°
21	No. 21	095	95°
24	No. 24	110	110°
28	No. 28	125	125°
32	No. 32	140	140°
34	No. 34	160	160°
		180	180°

  

FINISH & MATERIAL	
1	Natural Finish Bronze
4	Teflon Coated Bronze

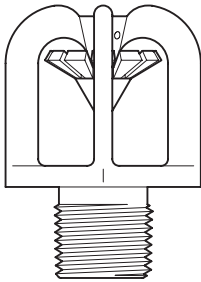

Nozzle	Finish	List Price
49-4XX-1-XXX	Natural Bronze	\$429.50
49-4XX-4-XXX	Teflon Coated Bronze *	\$612.50
Notes		
6012	*Special Order Teflon coating subject to set-up charge. (Net Price)	\$376.50
<b>Note: All Nozzles are special ordered and are Non-Returnable. Please see "Terms &amp; Conditions"</b>		
<b>Technical Data Sheet: TFP 806</b>		

**Type AM4 WaterMist Nozzles, Open Bulb Type, 1/2" NPT**

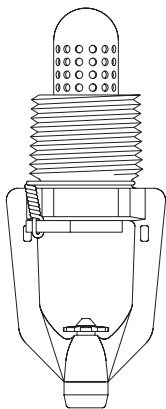

Nozzle	Finish	List Price
49-204-0-001	Stainless Steel	\$349.00
49-204-0-011	Stainless Steel W/Dust Cap	\$365.00
Replacement Parts		
56-885-0-001	Replacement Model F885 Dust Cap	\$69.00
<b>Note: All Nozzles are special ordered and are Non-Returnable. Please see "Terms &amp; Conditions"</b>		
<b>Technical Data Sheet: GEM TD 1173</b>		

Items marked "C.O." are made to order and may require longer delivery times. Please contact customer service for availability.

See latest Technical Data Sheets for specific Approvals, Listings, Design Parameters & available finishes. Sprinkler heads & escutcheons are priced separately unless otherwise noted.

**Type AM6, WaterMist Nozzles, Bulb Type, 1/2" NPT**

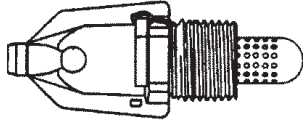

**Note: All Nozzles are special ordered and are Non-Returnable. Please see "Terms & Conditions"**

Nozzle	Finish	Temperature	List Price
49-206-1-135	Brass	135°F/57°C	\$322.00
49-206-4-135	White	135°F/57°C	\$322.00
49-206-9-135	Chrome	135°F/57°C	\$322.00
49-206-0-135	Stainless Steel	135°F/57°C	\$366.50
49-206-1-155	Brass	155°F/68°C	\$322.00
49-206-4-155	White	155°F/68°C	\$322.00
49-206-9-155	Chrome	155°F/68°C	\$322.00
49-206-0-155	Stainless Steel	155°F/68°C	\$366.50
49-206-1-175	Brass	175°F/79°C	\$322.00
49-206-4-175	White	175°F/79°C	\$322.00
49-206-9-175	Chrome	175°F/79°C	\$322.00
49-206-0-175	Stainless Steel	175°F/79°C	\$366.50
49-206-1-200	Brass	200°F/93°C	\$322.00
49-206-4-200	White	200°F/93°C	\$322.00
49-206-9-200	Chrome	200°F/93°C	\$322.00
49-206-0-200	Stainless Steel	200°F/93°C	\$366.50

**Technical Data Sheet: GEM TD 1170**

**Type AM10 WaterMist Nozzles, Open Type, 1/2" NPT**

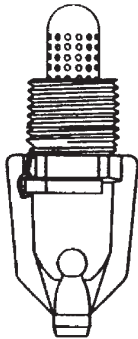

Nozzle	Finish	List Price
49-207-0-001	Stainless Steel	\$349.00
49-207-0-011	Stainless Steel w/Dust Cap	\$365.00
<b>Replacement Parts</b>		
56-885-0-001	Replacement Model F885 Dust Cap	\$69.00

**Note: All Nozzles are special ordered and are Non-Returnable. Please see "Terms & Conditions"**

**Technical Data Sheet: GEM TD1174**

See latest Technical Data Sheets for specific Approvals, Listings, Design Parameters & available finishes. Sprinkler heads & escutcheons are priced separately unless otherwise noted.

Items marked "C.O." are made to order and may require longer delivery times. Please contact customer service for availability.

Section 1  
Standard Spray Sprinklers

Section 2  
Extended Coverage Sprinklers

Section 3  
Storage Sprinklers

Section 4  
Residential Products

Section 5  
Dry Sprinklers

Section 6  
Special Sprinklers

Section 7  
Nozzles and Sprinkler Accessories

**Type AM11 WaterMist Nozzles, Bulb Type, 1/2" NPT**

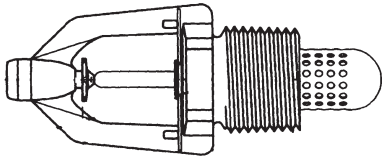

**Note: All Nozzles are special ordered and are Non-Returnable. Please see "Terms & Conditions"**

Nozzle	Finish	Temperature	List Price
49-208-1-135	Brass	135°F/57°C	P.O.A.
49-208-4-135	White	135°F/57°C	P.O.A.
49-208-9-135	Chrome	135°F/57°C	P.O.A.
49-208-1-155	Brass	155°F/68°C	P.O.A.
49-208-4-155	White	155°F/68°C	P.O.A.
49-208-9-155	Chrome	155°F/68°C	P.O.A.
49-208-1-175	Brass	175°F/79°C	P.O.A.
49-208-4-175	White	175°F/79°C	P.O.A.
49-208-9-175	Chrome	175°F/79°C	P.O.A.
49-208-1-200	Brass	200°F/93°C	P.O.A.
49-208-4-200	White	200°F/93°C	P.O.A.
49-208-9-200	Chrome	200°F/93°C	P.O.A.

**Type AM22 WaterMist Nozzles, Bulb Type, 1/2" NPT**

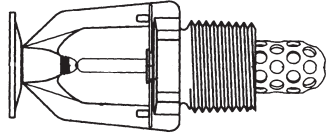

**Note: All Nozzles are special ordered and are Non-Returnable. Please see "Terms & Conditions"**

Nozzle	Finish	Temperature	List Price
49-209-1-135	Brass	135°F/57°C	\$322.00
49-209-4-135	White	135°F/57°C	\$322.00
49-209-9-135	Chrome	135°F/57°C	\$322.00
49-209-1-155	Brass	155°F/68°C	\$322.00
49-209-4-155	White	155°F/68°C	\$322.00
49-209-9-155	Chrome	155°F/68°C	\$322.00
49-209-1-175	Brass	175°F/79°C	\$322.00
49-209-4-175	White	175°F/79°C	\$322.00
49-209-9-175	Chrome	175°F/79°C	\$322.00
49-209-1-200	Brass	200°F/93°C	\$322.00
49-209-4-200	White	200°F/93°C	\$322.00
49-209-9-200	Chrome	200°F/93°C	\$322.00

Section 1  
Standard Spray Sprinklers

Section 2  
Extended Coverage Sprinklers

Section 3  
Storage Sprinklers

Section 4  
Residential Products

Section 5  
Dry Sprinklers

Section 6  
Special Sprinklers

Section 7  
Nozzles and Sprinkler Accessories

Items marked "C.O." are made to order and may require longer delivery times. Please contact customer service for availability.

See latest Technical Data Sheets for specific Approvals, Listings, Design Parameters & available finishes. Sprinkler heads & escutcheons are priced separately unless otherwise noted.

**Type AM24 WaterMist Nozzles, Bulb Type, 1/2" NPT**

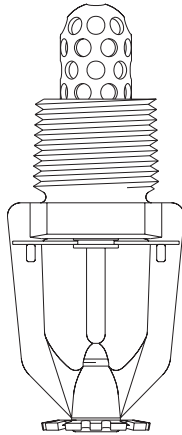

**Note: All Nozzles are special ordered and are Non-Returnable. Please see "Terms & Conditions"**

Nozzle	Finish	List Price
49-210-1-135	Brass	\$322.00
49-210-4-135	White	\$322.00
49-210-9-135	Chrome	\$322.00
49-210-1-155	Brass	\$322.00
49-210-4-155	White	\$322.00
49-210-9-155	Chrome	\$322.00
49-210-1-175	Brass	\$322.00
49-210-4-175	White	\$322.00
49-210-9-175	Chrome	\$322.00
49-210-1-200	Brass	\$322.00
49-210-4-200	White	\$322.00
49-210-9-200	Chrome	\$322.00

**Technical Data Sheet: GEM TD 1172**

Note: For ISO Connection, Replace (210) In Order Sequence With (220)

**Pilot Sprinkler Model FTR-1 Fixed Temperature Release, 1/2" NPT**  
**For Deluge and Preaction Systems Wet or Dry Pilot Release Service**

(SIN TY3030)

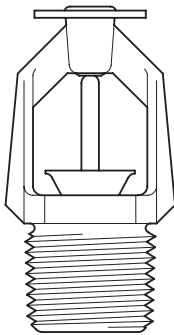

Nozzle	Finish	Temperature	List Price
51-041-1-135	Brass	135°F/57°C	\$27.25
51-041-4-135	White	135°F/57°C	\$30.50
51-041-3-135	Teflon	135°F/57°C	\$54.00
51-041-1-155	Brass	155°F/68°C	\$27.25
51-041-4-155	White	155°F/68°C	\$30.50
51-041-3-155	Teflon	155°F/68°C	\$54.00
51-041-1-175	Brass	175°F/79°C	\$27.25
51-041-4-175	White	175°F/79°C	\$30.50
51-041-3-175	Teflon	175°F/79°C	\$54.00
51-041-1-200	Brass	200°F/93°C	\$27.25
51-041-4-200	White	200°F/93°C	\$30.50
51-041-3-200	Teflon	200°F/93°C	\$54.00

**Sprinkler Wrench**

56-000-6-387	W-Type 6 Wrench	\$48.75
--------------	-----------------	---------

**Technical Data Sheet: TFP1388**

**Nozzle Accessories - Blow-Off Caps and Dust Caps for Mulsifyre Projectors and Nozzles**

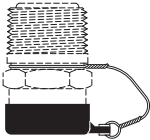
	C.O.	Part No.	Description	List Price
		<b>56-802-1-001</b>	Blow-Off Caps for Models F822B through F834B	\$35.75
		<b>56-880-1-001</b>	Dust Caps for Models F822 through F834	\$22.00
		<b>56-885-0-001</b>	Blow-Off Dust Caps with Wire	\$69.00
<b>Technical Data Sheet: TFP810</b>				

**Blow-Off Plugs for Protectospray Nozzles Model D-3**

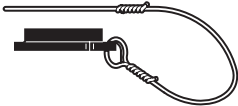
	C.O.	Part Number	Description	List Price	
		<b>56-320-1-001</b>	Blow Off Plug/Wire D-3 "A" (16)	\$28.50	
		<b>56-320-1-004</b>	Blow Off Plug/Wire D-3 "D" (34)	\$28.50	
		<b>56-320-1-005</b>	Blow Off Plug/Wire D-3 "E" (32) (1/2" for TY-B Sprinklers)	\$28.50	
		<b>56-320-1-006</b>	Blow Off Plug/Wire D-3 "H" (28)	\$28.50	
		<b>56-320-1-007</b>	Blow Off Plug/Wire D-3 "I" (24)	\$28.50	
		<b>56-320-1-008</b>	Blow Off Plug/Wire D-3 "J" (21)	\$28.50	
		<b>56-320-1-009</b>	Blow Off Plug/Wire D-3 "K" (18)	\$28.50	
		<b>56-320-1-010</b>	Blow Off Plug/Wire "N" (17/32")	\$28.50	
	<b>Technical Data Sheet: TFP890</b>				

**Miscellaneous Flush Escutcheons**

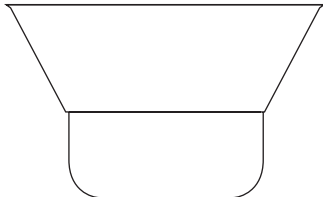





	C.O.	Part Number	Description	List Price
	<b>Model 65 Flat Escutcheons</b>			
	▶	<b>1150</b>	1/2" Flat Escutcheon-Brass	\$5.25
	▶	<b>1184</b>	3/4" Flat Escutcheon-Brass	\$5.25
		<b>1153</b>	1/2" Flat Escutcheon-Chrome	\$1.90
		<b>1152</b>	3/4" Flat Escutcheon-Chrome	\$1.90
		<b>1174</b>	1/2" Flat Escutcheon-White	\$4.40
		<b>1175</b>	3/4" Flat Escutcheon-White	\$4.40
	<b>Model 401 2-Piece Adjustable Extended Escutcheons</b>			
		<b>1192</b>	1/2" Cup for 2 pc. Escutcheon-Chrome	\$2.55
		<b>1193</b>	3/4" Cup for 2 pc. Escutcheon-Chrome	\$2.55
		<b>1198</b>	Skirt for 2 pc. Escutcheon-Chrome	\$2.55
	▶	<b>1194</b>	1/2" Cup for 2 pc. Escutcheon-Brass	\$2.90
	▶	<b>1195</b>	3/4" Cup for 2 pc. Escutcheon-Brass	\$2.90
	▶	<b>1199</b>	Skirt for 2 pc. Escutcheon-Brass	\$2.90
		<b>1196</b>	1/2" Cup for 2 pc. Escutcheon-White	\$2.90
		<b>1197</b>	3/4" Cup for 2 pc. Escutcheon-White	\$2.90
		<b>1200</b>	Skirt for 2 pc. Escutcheon-White	\$2.90
<b>Technical Data Sheet: TFP777</b>				

Items marked "C.O." are made to order and may require longer delivery times. Please contact customer service for availability.

See latest Technical Data Sheets for specific Approvals, Listings, Design Parameters & available finishes. Sprinkler heads & escutcheons are priced separately unless otherwise noted.



**Typical Escutcheons**

	C.O.	Part Number	Description	List Price
     	<b>Recessed Escutcheons Style 10, 1/2" NPT (Order Separately)</b>			
	▶	56-701-2-010	1/2" Brass Plated (Style 10)	\$9.05
		56-701-9-010	1/2" Chrome Plated (Style 10)	\$6.25
		56-701-4-010	1/2" White Color Coated (Style 10)	\$6.25
		56-701-0-010	1/2" Stainless Steel (Style 10) with White Paint Finish	\$17.50
	<b>Recessed Escutcheons Style 20, 1/2" NPT (Order Separately)</b>			
	▶	56-705-2-010	1/2" Brass Plated (Style 20)	\$9.05
		56-705-9-010	1/2" Chrome Plated (Style 20)	\$6.25
		56-705-4-010	1/2" White Color Coated (Style 20)	\$6.25
		56-705-0-010	1/2" Stainless Steel (Style 20) with White Paint Finish	\$16.25
	<b>Recessed Escutcheons Style 30, 3/4" NPT (Order Separately)</b>			
	▶	56-705-2-011	3/4" Brass Plated (Style 30)	\$9.05
		56-705-9-011	3/4" Chrome Plated (Style 30)	\$6.50
		56-705-4-011	3/4" White Color Coated (Style 30)	\$6.50
		56-705-0-011	3/4" Stainless Steel (Style 30) with White Paint Finish	\$16.25
	<b>Recessed Escutcheons Style 40, 3/4" NPT (Order Separately)</b>			
	▶	56-700-2-010	3/4" Brass Plated (Style 40)	\$9.05
		56-700-9-010	3/4" Chrome Plated (Style 40)	\$6.50
		56-700-4-010	3/4" White Color Coated (Style 40)	\$6.50
		56-700-0-010	3/4" Stainless Steel (Style 40) with White Paint Finish	\$17.50
	<b>Recessed Escutcheons Style 50, 1/2" NPT (Order Separately)</b>			
		56-711-2-010	1/2" Brass Plated (Style 50)	\$9.05
		56-711-9-010	1/2" Chrome Plated (Style 50)	\$6.25
		56-711-4-010	1/2" White Color Coated (Style 50)	\$6.25
		56-711-0-010	1/2" Stainless Steel (Style 50) with White Paint Finish	\$16.25
	<b>Two-Piece Flush Escutcheons Style 60, 3/4" NPT (Order Separately)</b>			
		208107	3/4" Brass Plated (Style 60)	\$9.05
		208102	3/4" Chrome Plated (Style 60)	\$6.50
	208104	3/4" White Color Coated (Style 60)	\$6.50	
<b>Protective Cover (Order Separately)</b>				
	100-25-700	Plastic Cap Protective Cover for FR II Disposable Cover	\$2.65	
<b>Technical Data Sheet: Style 10 thru 50 TFP 770, Style 60 TFP778</b>				

Section 1  
Standard Spray Sprinklers

Section 2  
Extended Coverage Sprinklers

Section 3  
Storage Sprinklers

Section 4  
Residential Products

Section 5  
Dry Sprinklers

Section 6  
Special Sprinklers

Section 7  
Nozzles and Sprinkler Accessories

See latest Technical Data Sheets for specific Approvals, Listings, Design Parameters & available finishes. Sprinkler heads & escutcheons are priced separately unless otherwise noted.

Items marked "C.O." are made to order and may require longer delivery times. Please contact customer service for availability.

Section 1  
Standard Spray Sprinklers

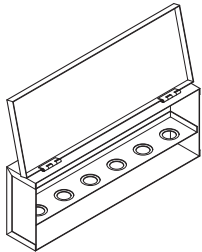
<b>Sprinkler Head Cabinets</b>				
	<i>C.O.</i>	<i>Part Number</i>	<i>Description</i>	<i>List Price</i>
		<b>1177</b>	3 - Head Cabinet	\$25.25
		<b>1119</b>	6 - Head Cabinet	\$42.50
		<b>1124</b>	12 - Head Cabinet	\$42.50
		<b>1111</b>	6 - ESFR Head Cabinet	\$64.00
<b>Technical Data Sheet: TFP785</b>				

Section 2  
Extended Coverage Sprinklers

<b>G1 and G4 Sprinkler Guards</b> <b>G1/S1 and G4/S3 Guards and Shields</b> <b>(For Series TY-B, TY-FRB, TY-L and TY-FRL Sprinklers)</b>				
	<i>C.O.</i>	<i>Part Number</i>	<i>Description</i>	<i>List Price</i>
		<b>56-938-1-001</b>	G1 Guard, Red	\$8.45
		<b>56-938-9-001</b>	G1 Guard, Zinc	\$8.45
		<b>56-937-1-001</b>	G4 Guard, Red	\$10.00
		<b>56-937-9-001</b>	G4 Guard, Zinc	\$10.00
		<b>56-938-1-066</b>	G1/S1 Guard and Shield, Red	\$10.20
		<b>56-938-9-066</b>	G1/S1 Guard and Shield, Zinc	\$10.20
		<b>56-937-1-066</b>	G4/S3 Guard and Shield, Red	\$12.25
		<b>56-937-9-066</b>	G4/S3 Guard and Shield, Zinc	\$12.25
		<b>56-000-8-597</b>	Guard Installation Tool	\$1.95
<b>Technical Data Sheet: TFP780</b>				

Section 3  
Storage Sprinklers

Section 4  
Residential Products

Section 5  
Dry Sprinklers

Section 6  
Special Sprinklers



<b>G5 Sprinkler Guard</b> <b>(For Series DS-1 Dry Sprinklers)</b>				
	<i>C.O.</i>	<i>Part Number</i>	<i>Description</i>	<i>List Price</i>
		<b>56-938-9-000</b>	G5 Sprinkler Guard for Series DS 1 Sprinklers	\$19.75
<b>Technical Data Sheet: TFP783</b>				

Section 7  
Nozzles and Sprinkler Accessories

Items marked "C.O." are made to order and may require longer delivery times. Please contact customer service for availability.

See latest Technical Data Sheets for specific Approvals, Listings, Design Parameters & available finishes. Sprinkler heads & escutcheons are priced separately unless otherwise noted.

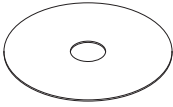
**G2 Guard, WS-2 Shield and WSG-2 Guard & Shield  
for ELO-231 Series**

	<i>C.O.</i>	<i>Part Number</i>	<i>Description</i>	<i>List Price</i>
		<b>56-000-1-087</b>	G-2 Guard, Red	\$6.65
		<b>56-000-1-086</b>	G-2 Guard, Zinc	\$6.65
		<b>56-000-1-081</b>	WS-2 Shield (1/2), Red	\$7.35
		<b>56-000-1-080</b>	WS-2 Shield (1/2), Zinc	\$7.35
		<b>56-000-1-083</b>	WS-2 Shield (3/4), Red	\$7.35
		<b>56-000-1-082</b>	WS-2 Shield (3/4), Zinc	\$7.35
		<b>56-000-1-098</b>	WSG-2 Guard & Shield , Red	\$10.20
		<b>56-000-1-097</b>	WSG-2 Guard & Shield , Zinc	\$10.20

**Technical Data Sheet: TFP782**

**Special Services**

**Clean Room Seal / Air, Dust Seal**

<i>Description</i>	<i>Part Number</i>	<i>List Price</i>
ELOC Concealed Clean Room Seal	<b>10908100</b>	\$12.75
RFII Air and Dust Seal	<b>56-908-1-001</b>	\$12.00
Plastic Cap Protective Cover - LFII	<b>92-000-0-412</b>	\$0.30

**All Special Finishes and Coatings are special ordered and are Non-Returnable.  
Please see "Terms & Conditions"**

Section 1  
Standard Spray Sprinklers

Section 2  
Extended Coverage Sprinklers

Section 3  
Storage Sprinklers

Section 4  
Residential Products

Section 5  
Dry Sprinklers

Section 6  
Special Sprinklers

Section 7  
Nozzles and Sprinkler Accessories

See latest Technical Data Sheets for specific Approvals, Listings, Design Parameters & available finishes. Sprinkler heads & escutcheons are priced separately unless otherwise noted.

Items marked "C.O." are made to order and may require longer delivery times. Please contact customer service for availability.

**Sprinkler Wrench List**

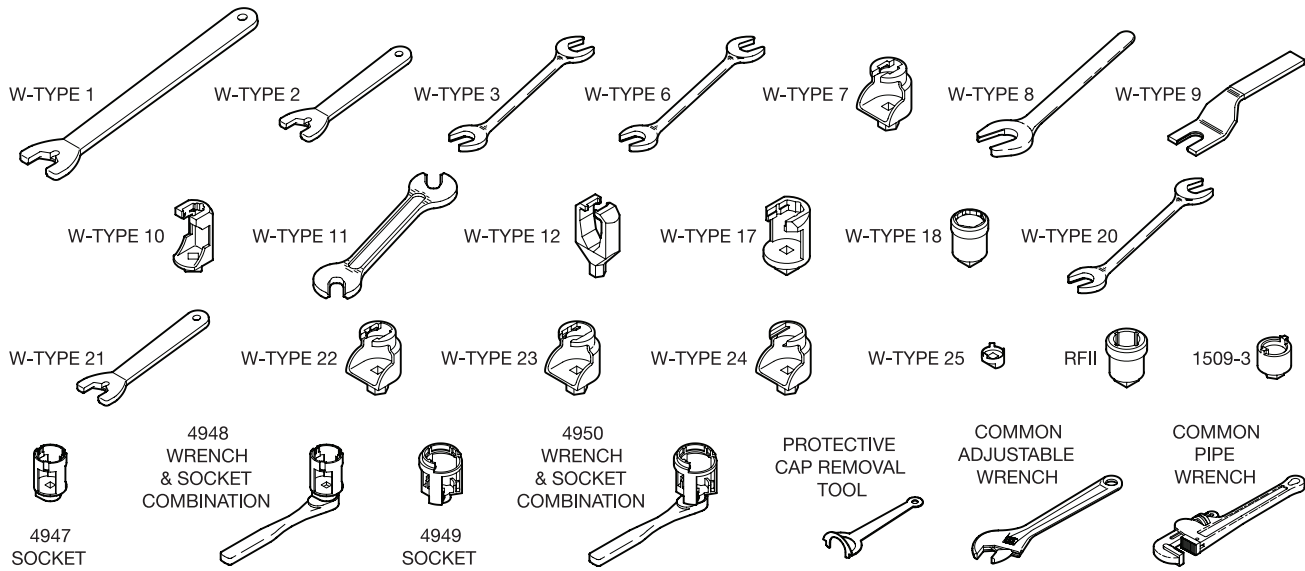

Wrench Type	Wrench used with the following Sprinkler Models:	Part No.	List Price
W-Type 1	EC-25, ESFR-25	<b>56-872-1-025</b>	\$61.75
W-Type 2	ESFR Pendent	<b>56-872-1-001</b>	\$48.75
W-Type 3	BB1 17/32, EPEC, EC-8, EC-11, EC-14, EC-17, ELO SW-20, ELO SW-24, ELO-231, ELO-231 B, ELO-231 FRB, LD	<b>56-895-1-001</b>	\$67.25
W-Type 6	CG2, EC-5, LFII, TY-B, TY-FRB	<b>56-000-6-387</b>	\$48.75
W-Type 7	CHEC, DS-1, EC-5, LFII, TY-B, TY-FRB, TY-FRFS, TY-FS, TY-FS Special	<b>56-850-4-001</b>	\$81.00
W-Type 8	DS-3, K17-231, Ultra K17	<b>56-892-1-001</b>	\$81.00
W-Type 9	TY-FRL, TY-L	<b>56-000-1-849</b>	\$43.50
W-Type 10	TY-FRFS, TY-FS, TY-FS Special, TY-L	<b>56-000-1-948</b>	\$67.25
W-Type 11	Issue D Quartzoid, Type EA-1, D3, D3S, Type 1 & 2	<b>56-452-1-001</b>	\$29.50
W-Type 12	TY-FRL	<b>56-798-1-001</b>	\$61.75
W-Type 17	DS-2	<b>56-010-4-118</b>	\$70.00
W-Type 18	ELOC, LFII	<b>56-000-1-265</b>	\$81.00
W-Type 20	CC1, HIP, WS	<b>56-000-1-106</b>	\$81.00
W-Type 21	ESFR-17	<b>56-001-0-686</b>	\$48.75
W-Type 22	EC-11, EC-14	<b>56-665-7-001</b>	\$81.00
W-Type 23	EC-8	<b>56-000-6-838</b>	\$81.00
W-Type 24	EC-17	<b>56-000-6-856</b>	\$81.00
W-Type 25	Tyco Raven Institutional	<b>56-314-1-001</b>	\$141.50
RFII	DS-C, DS-ECC, RFII	<b>56-000-1-075</b>	\$81.00
1509-3	TFP MAX, TFP PH2, TFP PH5	<b>56-001-5-093</b>	\$141.50
4947 Socket	LFII, TY-QRF	<b>56-000-4-947</b>	\$86.50
4948 Wrench & Socket Combo	LFII, TY-QRF	<b>56-000-4-948</b>	\$128.50
4949 Socket	LFII	<b>56-000-4-949</b>	\$86.50
4950 Wrench & Socket Combo	LFII	<b>56-000-4-950</b>	\$128.50
Protective Cap Removal Tool	LFII	<b>56-000-4-300</b>	\$28.50
Pipe Wrench	DS-1, DS-2, DS-C, DS-ECC	<b>N/A</b>	<b>N/A</b>
Adjustable Wrench	BB1, BB2, BB3, SD1, SD2, SD3, Type D4a, F822 thru F834, HV-14 thru HV-60, Issue A & B, B-1	<b>N/A</b>	<b>N/A</b>

Items marked "C.O." are made to order and may require longer delivery times. Please contact customer service for availability.

See latest Technical Data Sheets for specific Approvals, Listings, Design Parameters & available finishes. Sprinkler heads & escutcheons are priced separately unless otherwise noted.

**Model AV-1-300 Alarm Check Valve, 300 psi 2 1/2" thru 8"**

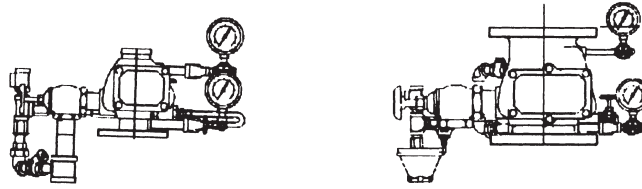

Description	Part No.	List Price
2 1/2" Model AV-1-300, Groove x Groove, Vertical	52-203-1-110	\$1,304.00
4" Model AV-1-300, Groove x Groove, Vertical/Horizontal	52-203-1-113	\$1,304.00
6" Model AV-1-300, Groove x Groove, Vertical/Horizontal	52-203-1-115	\$1,605.00
8" Model AV-1-300, Groove x Groove, Vertical/Horizontal	52-203-1-916	\$2,306.00
2 1/2" Model AV-1-300, Flange x Groove, Vertical	52-203-1-210	\$1,304.00
4" Model AV-1-300, Flange x Groove, Vertical/Horizontal	52-203-1-413	\$1,304.00
6" Model AV-1-300, Flange x Groove, Vertical/Horizontal	52-203-1-615	\$1,605.00
8" Model AV-1-300, Flange x Groove, Vertical/Horizontal	52-203-1-816	\$2,306.00
4" Model AV-1-300, Flange x Flange, Vertical/Horizontal	52-203-1-013	\$1,304.00
6" Model AV-1-300, Flange x Flange, Vertical/Horizontal	52-203-1-015	\$1,605.00
8" Model AV-1-300, Flange x Flange, Vertical/Horizontal	52-203-1-016	\$2,306.00
<b>Preassembled Alarm Check Valves</b>		
2 1/2" Model AV-1-300, Groove x Groove, Pre-Trimmed	52-203-2-110	\$3,072.00
4" Model AV-1-300, Flange x Groove, Pre-Trimmed	52-203-2-414	\$2,988.00
6" Model AV-1-300, Groove x Groove, Pre-Trimmed	52-203-2-115	\$3,740.00
6" Model AV-1-300, Flange x Groove, Pre-Trimmed	52-203-2-615	\$3,740.00
8" Model AV-1-300, Flange x Groove, Pre-Trimmed	52-203-2-816	\$4,446.00
<b>Trim Assemblies for 2 1/2", 4", 6" &amp; 8" Alarm Check Valves Model AV-1-300</b>		
2 1/2" Vertical Closed Drain, Basic Trim (Galvanized) AV-1-300	52-204-4-950	\$929.50
4" & 6" Vertical Closed Drain, Basic Trim (Galvanized) AV-1-300	52-204-4-951	\$1,144.00
4" & 6" Vertical Open Drain, Basic Trim (Galvanized) AV-1-300	52-204-4-954	\$1,006.00
4" & 6" Horizontal Closed Drain, Basic Trim (Galvanized) AV-1-300	52-204-4-057	\$1,220.00
8" Vertical Closed Drain, Basic Trim (Galvanized) AV-1-300	52-204-4-952	\$1,144.00
8" Vertical Open Drain, Basic Trim (Galvanized) AV-1-300	52-204-4-955	\$1,006.00
8" Horizontal Closed Drain, Basic Trim (Galvanized) AV-1-300	52-204-4-058	\$1,220.00
Pressure Relief Trim, 175 PSI	52-201-2-047	\$240.00
Pressure Relief Trim, 185 PSI	52-201-2-048	\$240.00
175 PSI Pressure Relief Valve	92-343-1-025	\$112.50
185 PSI Pressure Relief Valve	92-343-1-026	\$112.50
Main Drain	52-201-1-011	\$301.50
Trim, Alarm Vent	52-201-2-012	\$84.50
RC-1 Retard Chamber with Trim	52-211-1-002	\$524.00
<b>Notes</b>		
Other Options per TFP910; Pressure switch must be ordered separately, if required.		
(Replacement Parts are on the next page)		

Section 8  
Wet System Valves  
  
 Section 9  
Water Motor Alarms  
  
 Section 10  
Dry Pipe Valves  
  
 Section 11  
Quick Opening Devices  
  
 Section 12  
Air Maintenance Devices  
  
 Section 13  
Deluge Valves & Accessories  
  
 Section 14  
Preaction Systems  
  
 Section 15  
General Purpose Valves

See latest Technical Data Sheets for specific Approvals, Listings, Design Parameters & available finishes on [www.tyco-fire.com](http://www.tyco-fire.com).

**Model AV-1-300 Alarm Check Valve, 300 psi 2 1/2" thru 8"**

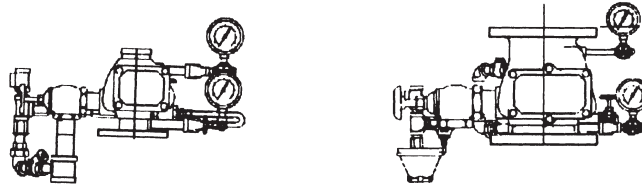

**Replacement Parts for 2 1/2" Model AV-1-300 Alarm Check Valves**

<b>Repair Parts Kit</b> Includes: 1-Handhole Cover Gasket & 1-Clapper Facing	<b>92-200-1-216</b>	\$92.50
<b>Clapper Assembly Kit</b> Includes: 1-Clapper, 1-Clapper Facing, 1-Clapper Washer, 1-Clapper Lock Nut, 1-Clapper Hinge Pin, 2-Clapper Hinge Pin Bushings & 1-Clapper Spring	<b>92-200-1-218</b>	\$327.00

**Replacement Parts for 4" Model AV-1-300 Alarm Check Valves**

<b>Repair Parts Kit</b> Includes: 1-Handhole Cover Gasket & 1-Clapper Facing	<b>92-200-1-416</b>	\$107.50
<b>Clapper Assembly Kit</b> Includes: 1-Clapper, 1-Clapper Facing, 1-Clapper Washer, 1-Hex Self-Locking Cap Screw, 1-Clapper Hinge Pin Bushing & 1-Clapper Spring	<b>92-200-1-423</b>	\$497.50

**Replacement Parts for 6" Model AV-1-300 Alarm Check Valves**

<b>Repair Parts Kit</b> Includes: 1-Handhole Cover Gasket & 1-Clapper Facing	<b>92-200-1-620</b>	\$125.00
<b>Clapper Assembly Kit</b> Includes: 1-Clapper, 1-Clapper Facing, 1-Clapper Washer, 1-Hex Self-Locking Cap Screw, 1-Clapper Hinge Pin Bushing & 1-Clapper Spring	<b>92-200-1-623</b>	\$628.00

**Replacement Parts for 8" Model AV-1-300 Alarm Check Valves**

<b>Repair Parts Kit</b> Includes: 1-Handhole Cover Gasket & 1-Clapper Facing	<b>92-200-1-816</b>	\$174.50
<b>Clapper Assembly Kit</b> Includes: 1-Clapper, 1-Clapper Facing, 1-Clapper Washer, 1-Hex Self-Locking Cap Screw, 1-Clapper Hinge Pin Bushing & 1-Clapper Spring	<b>92-200-1-823</b>	\$992.00

**Technical Data Sheet - TFP910**

**Shotgun CV-1FR Riser Check Valve**

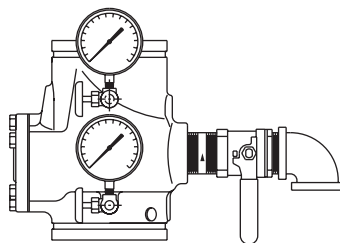

<i>Part Numbers</i>	<i>Description</i>	<i>List Price</i>
<b>59-590-1-020</b>	2" Shotgun Riser Check Valve	\$618.50
<b>59-590-1-025</b>	2 1/2" Shotgun Riser Check Valve	\$607.00
<b>59-590-1-030</b>	3" Shotgun Riser Check Valve	\$618.50
<b>59-590-1-040</b>	4" Shotgun Riser Check Valve	\$618.50
<b>59-590-1-050</b>	5" Shotgun Riser Check Valve	\$1,129.00
<b>59-590-1-060</b>	6" Shotgun Riser Check Valve	\$1,148.00
<b>59-590-1-080</b>	8" Shotgun Riser Check Valve	\$2,077.00
<b>Trim Assemblies for 2" thru 8" CV-1FR Riser Check Valve</b>		
<b>59-591-1-020</b>	2" Shotgun Check Trim (w/ gauges)	\$412.00
<b>59-591-1-030</b>	2 1/2" - 3" Shotgun Check Trim (w/ gauges)	\$412.00
<b>59-591-1-080</b>	4" - 8" Shotgun Check Trim (w/ gauges)	\$412.00

**Technical Data Sheet: TFP950**

See latest Technical Data Sheets for specific Approvals, Listings, Design Parameters & available finishes on [www.tyco-fire.com](http://www.tyco-fire.com).

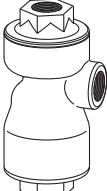
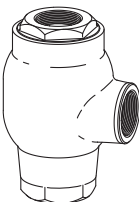
<b>Residential Shutoff Valves</b>			
	<i>Description</i>	<i>Part No.</i>	<i>List Price</i>
 1" RSV-1   2" RSV-1	1" Model RSV-1	<b>52-540-1-001</b>	\$998.00
	2" Model RSV-1	<b>52-540-1-002</b>	\$1,575.00
<b>Technical Data Sheet - TFP980</b>			

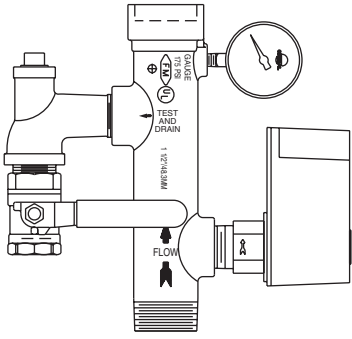
<b>Riser Manifolds – Commercial &amp; Residential</b>							
	<i>Size</i>	<i>Description</i>	<i>Type</i>	<i>Part No.</i>	<i>Part No. Canada</i>	<i>List Price</i>	
	1"	Residential	Female Thread x Female Thread	<b>4067</b>	<b>4085</b>	\$705.00	
	1 1/2"	Residential	Male Thread x Female Thread	<b>4057</b>	<b>4088</b>	\$705.00	
	1 1/2"	Residential	Male Thread x Male Thread	<b>4058</b>	<b>4089</b>	\$705.00	
	2"	Residential	Groove x Groove	<b>4059</b>	<b>4093</b>	\$725.50	
	2"	Residential	Male Thread x Groove	<b>4064</b>	<b>4094</b>	\$786.50	
	1 1/2"	Commercial	Male Thread x Female Thread	<b>4055</b>	<b>4086</b>	\$786.50	
	1 1/2"	Commercial	Male Thread x Male Thread	<b>4056</b>	<b>4087</b>	\$786.50	
	2"	Commercial	Groove x Groove	<b>4060</b>	<b>4090</b>	\$786.50	
	2 1/2"	Commercial	Groove x Groove	<b>4061</b>	<b>4091</b>	\$878.00	
	3"	Commercial	Groove x Groove	<b>4062</b>	<b>4092</b>	\$920.00	
	4"	Commercial	Groove x Groove	<b>4065</b>	<b>4095</b>	\$1,128.00	
	6"	Commercial	Groove x Groove	<b>4066</b>	<b>4096</b>	\$1,248.00	
	<b>Optional Pressure Relief Valve and Trim Kit</b>						
		1 1/2" - 2"	Manifold Accessory Kit		<b>4063</b>		\$224.00
	2 1/2" - 3"	Manifold Accessory Kit		<b>4072</b>		\$224.00	
	4" - 6"	Manifold Accessory Kit		<b>4073</b>		\$224.00	
<b>Technical Data Sheet - Residential - TFP960, Commercial - TFP962</b>							

See latest Technical Data Sheets for specific Approvals, Listings, Design Parameters & available finishes on [www.tyco-fire.com](http://www.tyco-fire.com).

Section 8  
Wet System Valves  
  
 Section 9  
Water Motor Alarms  
  
 Section 10  
Dry Pipe Valves  
  
 Section 11  
Quick Opening Devices  
  
 Section 12  
Air Maintenance Devices  
  
 Section 13  
Deluge Valves & Accessories  
  
 Section 14  
Preaction Systems  
  
 Section 15  
General Purpose Valves



Section 8  
Wet System Valves

Section 9  
Water Motor Alarms

Section 10  
Dry Pipe Valves

Section 11  
Quick Opening Devices

Section 12  
Air Maintenance Devices

Section 13  
Deluge Valves & Accessories

Section 14  
Preaction Systems

Section 15  
General Purpose Valves

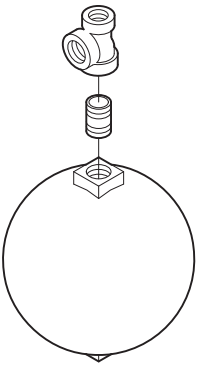
<b>Model RC-1 Retard Chamber</b>			
	<i>Part No.</i>	<i>Description</i>	<i>List Price</i>
	52-211-1-002	Retard Chamber, Model RC-1 w/trim	\$524.00
	<b>Replacement Parts for Model RC-1 Retard Chamber</b>		
92-210-2-005	Restriction Assembly	\$471.00	
<b>Technical Data Sheet - TFP920</b>			

<b>Resi-Risers</b>		
<b>Resi-Risers w/Retard Feature on Flow Switch and Without Pressure Relief Valve</b>		
<i>Description</i>	<i>Part No.</i>	<i>List Price</i>
1" Resi-Riser	54-360-1-011	\$756.50
1 1/4" Resi-Riser	54-360-1-012	\$854.50
1 1/2" Resi-Riser	54-360-1-013	\$906.00
2" Resi-Riser	54-360-1-014	\$1,036.00
<b>Resi-Risers w/Pressure Relief Valve and Retard Feature</b>		
1" Resi-Riser	54-360-1-111	\$794.50
1 1/4" Resi-Riser	54-360-1-112	\$884.50
1 1/2" Resi-Riser	54-360-1-113	\$934.00
2" Resi-Riser	54-360-1-114	\$1,068.00

See latest Technical Data Sheets for specific Approvals, Listings, Design Parameters & available finishes on [www.tyco-fire.com](http://www.tyco-fire.com).

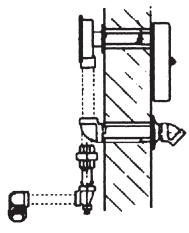
<b>Water Motor Alarm Model WMA-1</b>			
	<i>Description</i>	<i>Part No.</i>	<i>List Price</i>
	WMA-1, (Aluminum), Complete with Trim	<b>52-630-2-001P</b>	\$725.50
	WMA-1, (Red), Complete with Trim	<b>52-630-1-001P</b>	\$725.50
	Optional Drain Trim	<b>52-630-2-002</b>	\$145.00
	<b>Replacement Components for Water Motor Alarms</b>		
	Water Motor	<b>92-630-1-012</b>	\$415.00
	Repair Kit: Striker, Gong (Red) and Cap Nut	<b>92-630-1-025</b>	\$415.00
	Repair Kit: Striker, Gong (Aluminum) and Cap Nut	<b>92-630-2-025</b>	\$415.00
	<b>Replacement Trim Components</b>		
	<sup>3</sup> / <sub>4</sub> " Strainer	<b>52-271-1-001</b>	\$212.50
	<sup>3</sup> / <sub>4</sub> " Check Valve	<b>52-403-1-005</b>	\$172.50
<b>Technical Data Sheet - TFP 921</b>			

Section 8	Wet System Valves
Section 9	Water Motor Alarms
Section 10	Dry Pipe Valves
Section 11	Quick Opening Devices
Section 12	Air Maintenance Devices
Section 13	Deluge Valves & Accessories
Section 14	Preaction Systems
Section 15	General Purpose Valves

See latest Technical Data Sheets for specific Approvals, Listings, Design Parameters & available finishes on [www.tyco-fire.com](http://www.tyco-fire.com).

Section 8 Wet System Valves
<b>Section 9 Water Motor Alarms</b>
Section 10 Dry Pipe Valves
Section 11 Quick Opening Devices
Section 12 Air Maintenance Devices
Section 13 Deluge Valves & Accessories
Section 14 Preaction Systems
Section 15 General Purpose Valves

See latest Technical Data Sheets for specific Approvals, Listings, Design Parameters & available finishes on [www.tyco-fire.com](http://www.tyco-fire.com).

**DPV-1 Dry Pipe Valve**

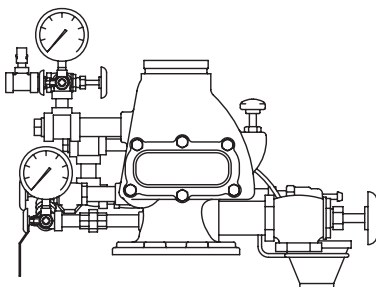
	Description	Part No.	List Price
	2 1/2" Model DPV-1 Groove x Groove	52-310-1-925	\$2,838.00
	3" Model DPV-1 Groove x Groove	52-310-1-930	\$3,153.00
	4" Model DPV-1 Groove x Groove	52-310-1-940	\$3,362.00
	6" Model DPV-1 Groove x Groove	52-310-1-960	\$4,265.00
	4" Model DPV-1 Flange x Groove	52-310-1-440	\$3,362.00
	6" Model DPV-1 Flange x Groove	52-310-1-460	\$4,265.00
	4" Model DPV-1 Flange x Flange	52-310-1-040	\$3,362.00
	6" Model DPV-1 Flange x Flange	52-310-1-060	\$4,265.00

**DPV-1 Dry Pipe Valve Trim**

2 1/2" and 3" DPV-1 Semi-Preassembled Trim (Galvanized)	52-309-2-005	\$1,125.00
4" DPV-1 Semi-Preassembled Trim (Galvanized)	52-309-2-001	\$1,208.00
6" DPV-1 Semi-Preassembled Trim (Galvanized)	52-309-2-002	\$1,208.00

**DPV-1 Preassembled Valve & Trim**

2 1/2" DPV-1 Groove x Groove Pre-Trimmed (Galvanized)	52-310-2-925	\$4,964.00
3" DPV-1 Groove x Groove Pre-Trimmed (Galvanized)	52-310-2-930	\$4,964.00
4" DPV-1 Groove x Groove Pre-Trimmed (Galvanized)	52-310-2-940	\$5,410.00
6" DPV-1 Groove x Groove Pre-Trimmed (Galvanized)	52-310-2-960	\$6,313.00
4" DPV-1 Flange x Groove Pre-Trimmed (Galvanized)	52-310-2-440	\$5,410.00
6" DPV-1 Flange x Groove Pre-Trimmed (Galvanized)	52-310-2-460	\$6,313.00
4" DPV-1 Flange x Flange Pre-Trimmed (Galvanized)	52-310-2-040	\$5,410.00
6" DPV-1 Flange x Flange Pre-Trimmed (Galvanized)	52-310-2-060	\$6,313.00

**Notes**

Specify size and dry valve when ordering trim. Trim include alarm test valve and connections for gauges, priming, air supply and drains but does not include pressure supervisory or alarm devices.

**Replacement Parts for Model "DPV-1" Dry Pipe Valve**

2 1/2" and 3" Clapper Assembly	92-310-2-203	\$1,113.00
2 1/2" and 3" Repair Parts Kit	92-310-1-204	\$191.00
4" Clapper Assembly	92-310-2-403	\$1,113.00
4" Repair Parts Kit	92-310-1-404	\$191.00
Reset Plunger Parts Kit	92-310-1-405	\$821.50
6" Clapper Assembly	92-310-2-603	\$2,026.00
6" Repair Parts Kit	92-310-1-604	\$291.50

**Technical Data Sheet - TFP1020**

Section 8  
Wet System Valves

Section 9  
Water Motor Alarms

Section 10  
Dry Pipe Valves

Section 11  
Quick Opening Devices

Section 12  
Air Maintenance Devices

Section 13  
Deluge Valves & Accessories

Section 14  
Preaction Systems

Section 15  
General Purpose Valves

Section 8 Wet System Valves
Section 9 Water Motor Alarms
Section 10 Dry Pipe Valves
Section 11 Quick Opening Devices
Section 12 Air Maintenance Devices
Section 13 Deluge Valves & Accessories
Section 14 Preaction Systems
Section 15 General Purpose Valves

See latest Technical Data Sheets for specific Approvals, Listings, Design Parameters & available finishes on [www.tyco-fire.com](http://www.tyco-fire.com).

**“VIZOR” Model EDPA - Electronic Dry Pipe Accelerator  
(Quick Opening Device)**

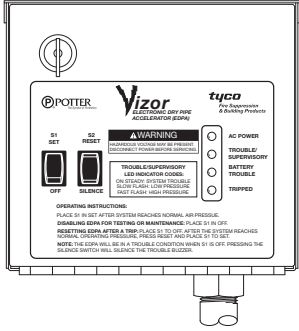
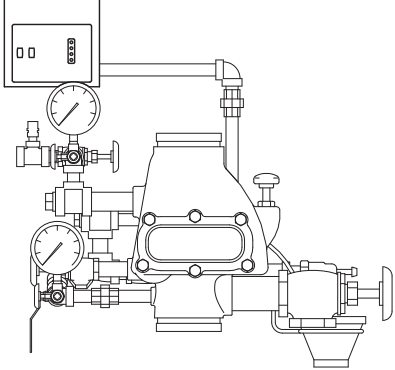
Description	Part No.	List Price Each
 <p>“VIZOR” - Electronic Dry Pipe Accelerator (EDPA) Switch  (Note: Switch Only)</p>	52-312-3-000	\$2,699.00
 <p>“VIZOR” - Electronic Dry Pipe Accelerator (EDPA) with the Model EDPA Trim for use with 4 or 6 inch Model DPV-1 Dry Pipe Valve  (Note: DPV-1 Dry Pipe Valve and Batteries are not included)</p>	52-312-3-001	\$2,755.00
VIZOR Battery Cabinet EDPA (For use with BT-40 only)	52-312-3-002	\$143.50
Replacement Battery BT-40 (5 Amp) (Requires 2)	2654	\$73.50
Replacement Battery BT-10 (1.3 Amp) (Requires 2)	2653	\$73.50
Fuse Holder EDPA	2655	\$29.00
Fuse 5 Amp EDPA	2657	\$4.40
<b>Technical Data Sheet - TFP1105</b>		

Section 8  
Wet System Valves

Section 9  
Water Motor Alarms

Section 10  
Dry Pipe Valves

Section 11  
Quick Opening Devices

Section 12  
Air Maintenance Devices

Section 13  
Deluge Valves & Accessories

Section 14  
Preaction Systems

Section 15  
General Purpose Valves

Section 8  
Wet System Valves

Section 9  
Water Motor Alarms

Section 10  
Dry Pipe Valves

Section 11  
Quick Opening Devices

Section 12  
Air Maintenance Devices

Section 13  
Deluge Valves & Accessories

Section 14  
Preaction Systems

Section 15  
General Purpose Valves

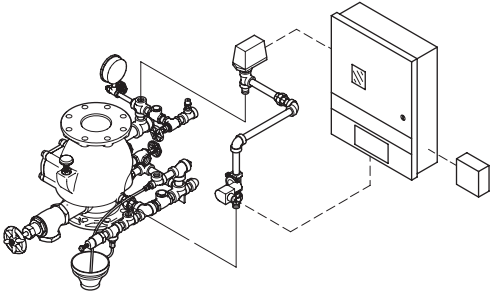
<b>QRS Electronic Accelerator</b>		
<i>Description</i>	<i>Part No.</i>	<i>List Price</i>
	<b>QRS Electronic Dry Pipe Valve Accelerator Package for Double Interlock Systems</b> Includes: 1-QRS Accelerator Trim, 1-24 VDC Solenoid Valve 1-PFC-4410 RC Releasing Panel, 2-BT-80 8.0 AH Battery	<b>52-312-2-102</b> \$5,613.00
	<b>QRS Electronic Dry Pipe Valve Accelerator Package for Dry Pipe Systems. (no Releasing Panel)</b> Includes: 1-QRS Accelerator Trim, 1-24 VDC Solenoid Valve	<b>52-312-2-001</b> \$2,914.00
QRS Switch Only	<b>92-312-1-001</b>	\$1,441.00
Replacement Battery (BT-80 8.0 AH Battery)	<b>2656</b>	\$79.50
<b>Technical Data Sheet - TFP1100</b>		

See latest Technical Data Sheets for specific Approvals, Listings, Design Parameters & available finishes on [www.tyco-fire.com](http://www.tyco-fire.com).

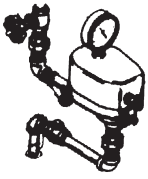

<b>Dry Pipe Valve Accelerator, Model ACC-1</b>			
<i>Description</i>		<i>Part No.</i>	<i>List Price</i>
	Accelerator Only	<b>52-311-1-001P</b>	\$1,624.00
	Accelerator Trim (Galvanized)	<b>52-311-2-010</b>	\$628.50
	Accelerator "Package"	<b>52-311-2-002</b>	\$2,332.00
<b>Repair Parts for Dry Pipe Valve Accelerator, Model ACC-1</b>			
<b>Replacement Kit A</b> (See Datasheet for Additional Information) Includes: 1-Plunger, 1-Exhaust Valve, 1-Cover Gasket, 1-O-Ring, 1-Restriction, 1-Latch, 1-O-Ring & 1.5 grams of FS3452 Fluorosilicone Grease		<b>92-311-1-116P</b>	\$656.50
<b>Replacement Kit B</b> (See Datasheet for Additional Information) Includes: 1-Pivot Plate Assembly, 4-Pan Head Machine Screws, 1-Cotter Pin, 1-Lever, 1-Retaining Ring, 1-Anti-Flood Valve, 1-Relief Valve, 1-Spring, 1-Relief Valve, 1-Spring, 1-Relief Valve Seat, 1-O-Ring, 1-Seal Washer, 1-Latch, 1-Anti-Flood Seat Assembly w/Ball Float & 1.5 grams of FS3452 Fluorosilicone Grease		<b>92-311-1-117P</b>	\$647.50
<b>Replacement Kit C</b> (See Datasheet for Additional Information) Includes: 1-Upper Diaphragm Plate, 6-Round Head Machine Screws, 1-Vent Plug, 1-Restriction Access Plate, 8-Fillerster Head Machine Screws, 1-Plug Seat, 1-O-Ring, 1-Reset Knob & 1.5 grams of FS3452 Fluorosilicone Grease		<b>92-311-1-118</b>	\$969.50
<b>Technical Data Sheet - TFP1112</b>			

Section 8	Wet System Valves
Section 9	Water Motor Alarms
Section 10	Dry Pipe Valves
Section 11	Quick Opening Devices
Section 12	Air Maintenance Devices
Section 13	Deluge Valves & Accessories
Section 14	Preaction Systems
Section 15	General Purpose Valves

See latest Technical Data Sheets for specific Approvals, Listings, Design Parameters & available finishes on [www.tyco-fire.com](http://www.tyco-fire.com).

Section 8 Wet System Valves
Section 9 Water Motor Alarms
Section 10 Dry Pipe Valves
Section 11 Quick Opening Devices
Section 12 Air Maintenance Devices
Section 13 Deluge Valves & Accessories
Section 14 Preaction Systems
Section 15 General Purpose Valves

See latest Technical Data Sheets for specific Approvals, Listings, Design Parameters & available finishes on [www.tyco-fire.com](http://www.tyco-fire.com).

**Air Maintenance Devices**

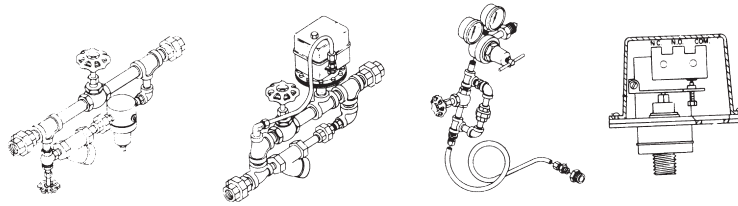

<i>Description</i>	<i>Part No.</i>	<i>List Price</i>
AMD-1 Air Maintenance Device	<b>52-324-2-002</b>	\$927.50
AMD-2 Air Maintenance Device	<b>52-326-2-001</b>	\$1,367.00
AMD-3 Nitrogen Maintenance Device	<b>52-328-2-001</b>	\$1,815.00
<b>Replacement Parts for Air Supply Controls</b>		
Pressure Regulator for Model AMD-1	<b>92-324-1-012</b>	\$709.50
Strainer 1/4", for Model AMD-1 and AMD-2	<b>92-322-1-001</b>	\$208.00
Pressure Switch for AMD-2 Device	<b>92-326-1-001</b>	\$1,338.00
Restrictor Check. Valve for AMD-1, AMD-2 and AMD-3 Device	<b>92-326-1-003</b>	\$179.50
<b>Technical Data Sheet - (AMD-1 - TFP1221), (AMD-2 - TFP1231) and (AMD-3 - TFP1241)</b>		

**Accessories for Air Maintenance Devices**

<i>Description</i>	<i>Part No.</i>	<i>List Price</i>
Low Pressure Alarm Switch PS40-1A	<b>2572</b>	\$194.00
Hi/Low Pressure Alarm Switch PS40-2A	<b>2573</b>	\$236.00

Section 8  
Wet System Valves

Section 9  
Water Motor Alarms

Section 10  
Dry Pipe Valves

Section 11  
Quick Opening Devices

Section 12  
Air Maintenance Devices

Section 13  
Deluge Valves & Accessories

Section 14  
Preaction Systems

Section 15  
General Purpose Valves

See latest Technical Data Sheets for specific Approvals, Listings, Design Parameters & available finishes on [www.tyco-fire.com](http://www.tyco-fire.com).

Section 8 Wet System Valves
Section 9 Water Motor Alarms
Section 10 Dry Pipe Valves
Section 11 Quick Opening Devices
<b>Section 12 Air Maintenance Devices</b>
Section 13 Deluge Valves & Accessories
Section 14 Preaction Systems
Section 15 General Purpose Valves

See latest Technical Data Sheets for specific Approvals, Listings, Design Parameters & available finishes on [www.tyco-fire.com](http://www.tyco-fire.com).

**Model DV-5 Deluge Valves, Diaphragm Style**

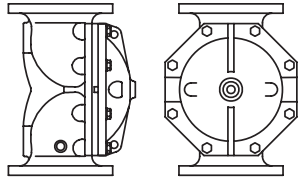
<i>Description</i>		<i>Part No.</i>	<i>List Price</i>
	1 1/2" Model DV-5 Groove x Groove, 250 PSI	<b>52-477-1-919</b>	\$2,058.00
	2" Model DV-5 Groove x Groove, 250 PSI	<b>52-477-1-910</b>	\$2,151.00
	3" Model DV-5 Groove x Groove, 250 PSI	<b>52-477-1-912</b>	\$2,338.00
	4" Model DV-5 Groove x Groove, 250 PSI	<b>52-477-1-913</b>	\$4,028.00
	6" Model DV-5 Groove x Groove, 250 PSI	<b>52-477-1-915</b>	\$4,911.00
	8" Model DV-5 Groove x Groove, 250 PSI	<b>52-477-1-916</b>	\$14,056.00
	1 1/2" Model DV-5 Thread x Thread, 250 PSI	<b>52-477-1-069</b>	\$2,058.00
	2" Model DV-5 Thread x Thread, 250 PSI	<b>52-477-1-060</b>	\$2,151.00
	3" Model DV-5 Flange x Groove, 250 PSI	<b>52-477-1-412</b>	\$2,338.00
	4" Model DV-5 Flange x Groove, 250 PSI	<b>52-477-4-613</b>	\$4,028.00
	6" Model DV-5 Flange x Groove, 250 PSI	<b>52-477-4-615</b>	\$4,911.00
	8" Model DV-5 Flange x Groove, 250 PSI	<b>52-477-1-416</b>	\$14,056.00
	3" Model DV-5 Flange x Flange, 250 PSI	<b>52-477-1-012</b>	\$2,338.00
	4" Model DV-5 Flange x Flange, 250 PSI	<b>52-477-1-013</b>	\$4,028.00
	6" Model DV-5 Flange x Flange, 250 PSI	<b>52-477-1-015</b>	\$4,911.00
	8" Model DV-5 Flange x Flange, 250 PSI	<b>52-477-1-016</b>	\$14,056.00
<b>Trim Kits for Model DV-5 Deluge Valves - 1 1/2" and 2"</b>			
1 1/2" and 2" Wet Pilot Actuation (Galvanized) (Standard Order)		<b>52-477-2-107</b>	\$2,807.00
1 1/2" and 2" Wet Pilot Actuation (Black)		<b>52-477-1-107</b>	\$2,807.00
1 1/2" and 2" Wet Pilot Actuation (Brass)		<b>52-477-3-107</b>	POA
1 1/2" and 2" Wet Pilot Actuation (Stainless Steel)		<b>52-477-4-107</b>	POA
1 1/2" and 2" Dry Pilot Actuation (Galvanized) (Standard Order)		<b>52-477-2-108</b>	\$3,740.00
1 1/2" and 2" Dry Pilot Actuation (Black)		<b>52-477-1-108</b>	\$3,740.00
1 1/2" and 2" Dry Pilot Actuation (Brass)		<b>52-477-3-108</b>	POA
1 1/2" and 2" Dry Pilot Actuation (Stainless Steel)		<b>52-477-4-108</b>	POA
1 1/2" and 2" Electric Actuation (Galvanized) (Standard Order)(Solenoid Valve Not Included)		<b>52-477-2-109</b>	\$2,807.00
1 1/2" and 2" Electric Actuation (Black) (Solenoid Valve Not Included)		<b>52-477-1-109</b>	\$2,807.00
1 1/2" and 2" Electric Actuation (Brass) (Solenoid Valve Not Included)		<b>52-477-3-109</b>	POA
1 1/2" and 2" Electric Actuation (Stainless Steel) (Solenoid Valve Not Included)		<b>52-477-4-109</b>	POA
<b>Trim Kits for Model DV-5 Deluge Valves - 3"</b>			
3" Wet Pilot Actuation (Galvanized) (Standard Order)		<b>52-477-2-104</b>	\$2,807.00
3" Wet Pilot Actuation (Black)		<b>52-477-1-104</b>	\$2,807.00
3" Wet Pilot Actuation (Brass)		<b>52-477-3-104</b>	POA
3" Wet Pilot Actuation (Stainless Steel)		<b>52-477-4-104</b>	POA
3" Dry Pilot Actuation (Galvanized) (Standard Order)		<b>52-477-2-105</b>	\$3,740.00
3" Dry Pilot Actuation (Black)		<b>52-477-1-105</b>	\$3,740.00
3" Dry Pilot Actuation (Brass)		<b>52-477-3-105</b>	POA
3" Dry Pilot Actuation (Stainless Steel)		<b>52-477-4-105</b>	POA
3" Electric Actuation (Galvanized) (Standard Order) (Solenoid Valve Not Included)		<b>52-477-2-106</b>	\$2,807.00
3" Electric Actuation (Black) (Solenoid Valve Not Included)		<b>52-477-1-106</b>	\$2,807.00
3" Electric Actuation (Brass) (Solenoid Valve Not Included)		<b>52-477-3-106</b>	POA
3" Electric Actuation (Stainless Steel) (Solenoid Valve Not Included)		<b>52-477-4-106</b>	POA

Section 8  
Wet System Valves

Section 9  
Water Motor Alarms

Section 10  
Dry Pipe Valves

Section 11  
Quick Opening Devices

Section 12  
Air Maintenance Devices

Section 13  
Deluge Valves & Accessories

Section 14  
Preaction Systems

Section 15  
General Purpose Valves

Refer to the latest technical data sheets for specific approvals, listings, design parameters, and available options on [www.tyco-fire.com](http://www.tyco-fire.com).

<b>Model DV-5 Deluge Valves, Diaphragm Style (cont.)</b>			
	<i>Description</i>	<i>Part No.</i>	<i>List Price</i>
Section 8 Wet System Valves	<b>Trim Kits for Model DV-5 Deluge Valves - 4", 6" and 8"</b>		
	4", 6" & 8" Wet Pilot Actuation (Galvanized) (Standard Order)	<b>52-477-2-101</b>	\$2,807.00
Section 9 Water Motor Alarms	4", 6" & 8" Wet Pilot Actuation (Black)	<b>52-477-1-101</b>	\$2,807.00
	4", 6" & 8" Wet Pilot Actuation (Brass)	<b>52-477-3-101</b>	P.O.A.
	4", 6" & 8" Wet Pilot Actuation (Stainless Steel)	<b>52-477-4-101</b>	P.O.A.
	4", 6" & 8" Dry Pilot Actuation (Galvanized) (Standard Order)	<b>52-477-2-102</b>	\$3,795.00
Section 10 Dry Pipe Valves	4", 6" & 8" Dry Pilot Actuation (Black)	<b>52-477-1-102</b>	\$3,795.00
	4", 6" & 8" Dry Pilot Actuation (Brass)	<b>52-477-3-102</b>	P.O.A.
	4", 6" & 8" Dry Pilot Actuation (Stainless Steel)	<b>52-477-4-102</b>	P.O.A.
	4", 6" & 8" Electric Actuation (Galvanized) (Standard Order) (Solenoid Valve Not Included)	<b>52-477-2-103</b>	\$2,807.00
Section 11 Quick Opening Devices	4", 6" & 8" Electric Actuation (Black) (Solenoid Valve Not Included)	<b>52-477-1-103</b>	\$2,807.00
	4", 6" & 8" Electric Actuation (Brass) (Solenoid Valve Not Included)	<b>52-477-3-103</b>	P.O.A.
	4", 6" & 8" Electric Actuation (Stainless Steel) (Solenoid Valve Not Included)	<b>52-477-4-103</b>	P.O.A.
	<b>Replacement Diaphragm Kits for the Model DV-5 Deluge Valve</b>		
Section 12 Air Maintenance Devices	1 1/2" DV-5 Deluge Valve Replacement Diaphragm	<b>92-477-1-105</b>	\$756.00
	2" DV-5 Deluge Valve Replacement Diaphragm	<b>92-477-1-107</b>	\$756.00
	3" DV-5 Deluge Valve Replacement Diaphragm	<b>92-477-1-109</b>	\$775.50
	4" DV-5 Deluge Valve Replacement Diaphragm	<b>92-477-1-101</b>	\$2,073.00
	6" DV-5 Deluge Valve Replacement Diaphragm	<b>92-477-1-103</b>	\$3,012.00
	8" DV-5 Deluge Valve Replacement Diaphragm	<b>92-477-1-111</b>	\$6,121.00
<b>Technical Data Sheets: DV-5 Valve - TFP1305, Wet Pilot - TFP1310, Dry Pilot - TFP1315, Electric Actuation - TFP1320</b>			
Section 13 Deluge Valves & Accessories			
Section 14 Preaction Systems			
Section 15 General Purpose Valves			

Refer to the latest technical data sheets for specific approvals, listings, design parameters, and available options on [www.tyco-fire.com](http://www.tyco-fire.com).

**Model DP-1, Dry Pilot Actuator**

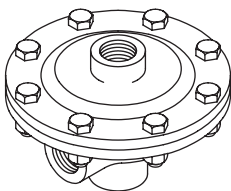
<i>Description</i>	<i>Part Number</i>	<i>List Price</i>
 Dry Pilot Actuator Model DP-1	<b>52-280-1-001P</b>	\$1,095.00
<b>Replacement Parts for DP-1 Dry Pilot Actuator</b>		
Diaphragm	<b>92-280-1-008</b>	\$48.25
Diaphragm, Plate, Sub Assembly	<b>92-280-1-012</b>	\$444.00
<b>Technical Data Sheet - TFP1380</b>		

**Deluge Valve Accessories**

<i>Description</i>	<i>Part No.</i>	<i>List Price</i>
24 VDC Solenoid Valve	<b>52-287-1-024</b>	\$1,147.00
DP-1 Dry Pilot Actuator	<b>52-280-1-001P</b>	\$1,095.00
PSI Alarm Switch Model PS40-2A	<b>2573</b>	\$236.00
Automatic Ball Drip Valve, Plunger Type (AD-1)	<b>51-793-1-004</b>	\$155.00
Manual Control Station (MC-1)	<b>52-289-1-001</b>	\$470.50
Model PS 10 - 2A Pressure Alarm Switch	<b>2571</b>	\$229.50
Model OSYSU-2 Monitor Switch	<b>2412</b>	\$195.50
Model WMA-1 Water Motor Alarm	<b>52-630-1-001</b>	\$725.50
Model PFC 4410 Fire Control Panel.	<b>20125</b>	\$2,515.00
Model ASV-1 Automatic Shut-Off Valve	<b>92-343-1-021</b>	\$364.50
Model ASV-1 Automatic Shut-Off Valve (Stainless Steel)	<b>92-343-4-021</b>	POA
<b>Batteries - Two Batteries are required for Stand-by power for each Control Panel. Consult TD Sheets for ratings</b>		
<i>Description</i>	<i>Part No.</i>	<i>List Price (each)</i>
Model BT-80 (8 amp) Stand by Batteries, (2 REQ'D)	<b>2656</b>	\$79.50
Model BT-120 (12 amp) Stand by Batteries, (2 REQ'D)	<b>20128</b>	\$141.00
<b>Notes</b>		
Heat Detectors, Manual Control Stations, Alarm Bells, Trouble Horns, Spray Nozzles, or Open Sprinklers are ordered separately. Contact your local TFP Distributor.		

Refer to the latest technical data sheets for specific approvals, listings, design parameters, and available options on [www.tyco-fire.com](http://www.tyco-fire.com).

Section 8  
Wet System Valves

Section 9  
Water Motor Alarms

Section 10  
Dry Pipe Valves

Section 11  
Quick Opening Devices

Section 12  
Air Maintenance Devices

Section 13  
Deluge Valves & Accessories

Section 14  
Preaction Systems

Section 15  
General Purpose Valves



**Model DV-5 Deluge Valves With Remote-Resetting Trim**

**P/N XX-X80-00-261**

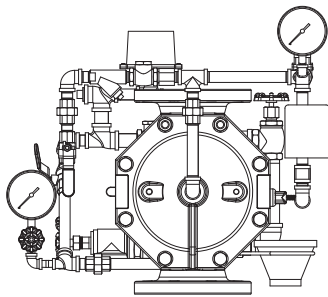
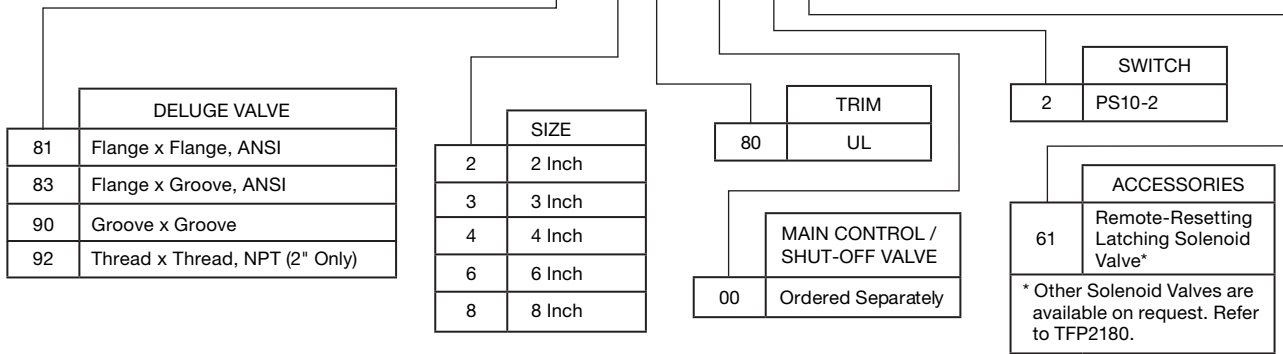

**Note: All quotes are FOB manufacturer, considered "Special Order", are Non-Returnable. Refer to "Terms & Conditions" in this document**

**2" Model DV-5 Deluge Valves with Remote-Resetting Trim, Fully Assembled with UL Trim (Valve Included)**

Description (All with Galvanized Trim)	Part No.	List Price
2" Groove x Groove, NPT Ports	<b>90-280-00-261</b>	\$8,502.00
2" Thread x Thread, NPT, NPT Ports	<b>92-280-00-261</b>	\$8,502.00

**3" Model DV-5 Deluge Valves with Remote-Resetting Trim, Fully Assembled with UL Trim (Valve Included)**

3" Flange x Groove, ANSI, NPT Ports	<b>83-380-00-261</b>	\$9,620.00
3" Groove x Groove, NPT Ports	<b>90-380-00-261</b>	\$9,620.00

**4" Model DV-5 Deluge Valves with Remote-Resetting Trim, Fully Assembled with UL Trim (Valve Included)**

4" Flange x Groove, ANSI, NPT Ports	<b>83-480-00-261</b>	\$11,596.00
4" Groove x Groove, NPT Ports	<b>90-480-00-261</b>	\$11,596.00

**6" Model DV-5 Deluge Valves with Remote-Resetting Trim, Fully Assembled with UL Trim (Valve Included)**

6" Flange x Groove, ANSI, NPT Ports	<b>83-680-00-261</b>	\$13,832.00
6" Groove x Groove, NPT Ports	<b>90-680-00-261</b>	\$13,832.00

**8" Model DV-5 Deluge Valves with Remote-Resetting Trim, Fully Assembled with UL Trim (Valve Included)**

8" Flange x Groove, ANSI, NPT Ports	<b>83-880-00-261</b>	\$19,344.00
8" Groove x Groove, NPT Ports	<b>90-880-00-261</b>	\$19,344.00

Refer to the latest technical data sheets for specific approvals, listings, design parameters, and available options on [www.tyco-fire.com](http://www.tyco-fire.com).

**Model DV-5 Deluge Valves With Remote-Resetting Trim**

**Required Equipment for Model DV-5 Deluge Valves with Remote-Resetting Trim (Ordered Separately)**

<i>Description</i>	<i>Part No.</i>	<i>List Price</i>
2", Semi-Preassembled Vertical Electric Actuation Trim Galvanized Trim (deluge valve, solenoid valve, pressure switch, and butterfly valves ordered separately)	<b>52-477-2-111</b>	\$2,808.00
3", Semi-Preassembled Vertical Electric Actuation Trim Galvanized Trim (deluge valve, solenoid valve, pressure switch, and butterfly valves ordered separately)	<b>52-477-2-112</b>	\$2,808.00
4", Semi-Preassembled Vertical Electric Actuation Trim Galvanized Trim (deluge valve, solenoid valve, pressure switch, and butterfly valves ordered separately)	<b>52-477-2-114</b>	\$2,808.00
6", Semi-Preassembled Vertical Electric Actuation Trim Galvanized Trim (deluge valve, solenoid valve, pressure switch, and butterfly valves ordered separately)	<b>52-477-2-115</b>	\$2,808.00
8", Semi-Preassembled Vertical Electric Actuation Trim Galvanized Trim (deluge valve, solenoid valve, pressure switch, and butterfly valves ordered separately)	<b>52-477-2-116</b>	\$2,808.00
24 VDC Latching Solenoid Valve	<b>2460566</b>	\$1,147.00
Model PS10-1 Waterflow Pressure Switch	<b>25700</b>	\$175.50
Model PS10-2 Dual-Contact Waterflow Pressure Switch	<b>25710</b>	\$184.00
Water Pressure Gauge, 600 psi	<b>92-343-1-004</b>	\$191.00
<b>Accessories for Model DV-5 Deluge Valves with Remote-Resetting Trim</b>		
Model AD-2 Automatic Drain Valve	<b>52-789-1-004</b>	\$76.25
Model WMA-1 Water Motor Alarm	<b>52-630-1-001</b>	\$725.50
<b>Replacement Parts for Model DV-5 Deluge Valves with Remote-Resetting Trim</b>		
2" Model DV-5 Deluge Valve with Remote-Resetting Trim, Replacement Diaphragm	<b>92-477-1-107</b>	\$756.00
3" Model DV-5 Deluge Valve with Remote-Resetting Trim, Replacement Diaphragm	<b>92-477-1-109</b>	\$775.50
4" Model DV-5 Deluge Valve with Remote-Resetting Trim, Replacement Diaphragm	<b>92-477-1-101</b>	\$2,073.00
6" Model DV-5 Deluge Valve with Remote-Resetting Trim, Replacement Diaphragm	<b>92-477-1-103</b>	\$3,012.00
8" Model DV-5 Deluge Valve with Remote-Resetting Trim, Replacement Diaphragm	<b>92-477-1-111</b>	\$6,121.00
Model AD-1 Automatic Drain Valve	<b>52-793-2-004</b>	\$155.00
Model MC-1 Manual Control Station (Galv. Ends) (TFP 1382)	<b>52-289-2-001</b>	\$470.50
24 VDC Impulse Solenoid Valve	<b>2460566</b>	\$1,147.00
Model PS10-1 Waterflow Pressure Switch	<b>25700</b>	\$175.50
Model PS10-2 Dual-Contact Waterflow Pressure Switch	<b>25710</b>	\$184.00
Water Pressure Gauge, 300 psi	<b>92-343-1-005</b>	\$83.75
½" Y Strainer	<b>52-353-1-005</b>	\$65.25

**Technical Data Sheet - TFP1331**

Section 8  
Wet System Valves

Section 9  
Water Motor Alarms

Section 10  
Dry Pipe Valves

Section 11  
Quick Opening Devices

Section 12  
Air Maintenance Devices

Section 13  
Deluge Valves & Accessories

Section 14  
Preaction Systems

Section 15  
General Purpose Valves

**Model DV-5 Deluge Valves With Remote-Resetting, Pressure-Reducing Trim**

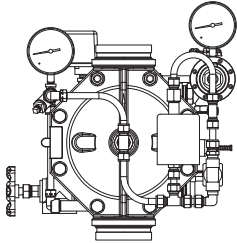
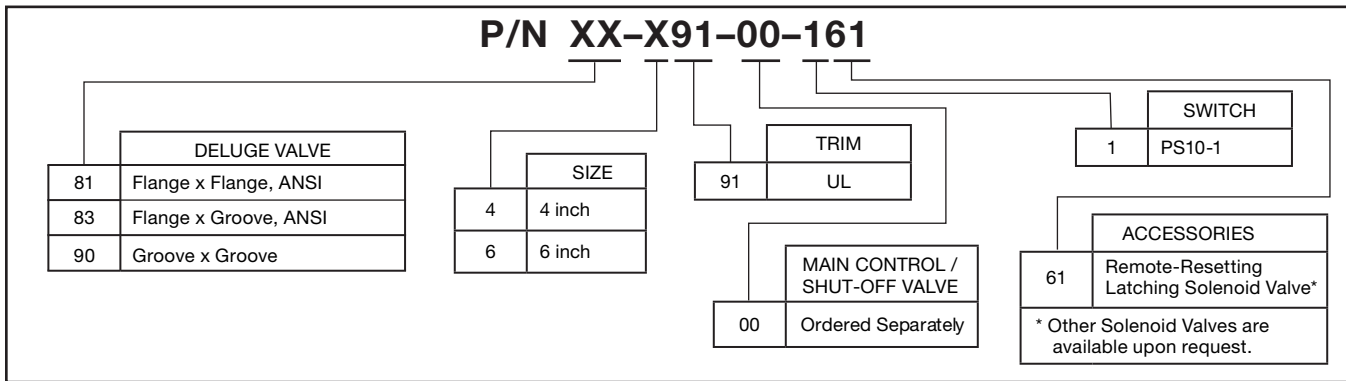

**4" Model DV-5 Deluge Valves with Remote-Resetting, Pressure-Reducing Trim Fully Assembled with UL Trim (Valve Included)**

<i>Description (All with Brass/Galvanized Trim)</i>	<i>Part No.</i>	<i>List Price</i>
4" Flange x Groove, ANSI, NPT Ports	<b>83-491-00-161</b>	\$12,075.00
4" Groove x Groove, NPT Ports	<b>90-491-00-161</b>	\$12,075.00
<b>6" Model DV-5 Deluge Valves with Remote-Resetting, Pressure-Reducing Trim Fully Assembled with UL Trim (Valve Included)</b>		
6" Flange x Groove, ANSI, NPT Ports	<b>83-691-00-161</b>	\$14,438.00
6" Groove x Groove, NPT Ports	<b>90-691-00-161</b>	\$14,438.00

**Note: All quotes are FOB manufacturer, considered "Special Order", are Non-Returnable. Refer to "Terms & Conditions" in this document**

Refer to the latest technical data sheets for specific approvals, listings, design parameters, and available options on [www.tyco-fire.com](http://www.tyco-fire.com).

Section 8 Wet System Valves

Section 9 Water Motor Alarms

Section 10 Dry Pipe Valves

Section 11 Quick Opening Devices

Section 12 Air Maintenance Devices

Section 13 Deluge Valves & Accessories

Section 14 Preaction Systems

Section 15 General Purpose Valves

<b>Model DV-5 Deluge Valves With Remote-Resetting, Pressure-Reducing Trim</b>		
<b>Required Equipment for Model DV-5 Deluge Valves with Remote-Resetting, Pressure-Reducing Trim (Ordered Separately)</b>		
<i>Description</i>	<i>Part No.</i>	<i>List Price</i>
4", Semi-Preassembled Vertical Electric Actuation Trim, Brass/Galvanized Trim (deluge valve, solenoid valve, pressure switch, and butterfly valves ordered separately)	<b>52-477-2-117</b>	\$3,016.00
6", Semi-Preassembled Vertical Electric Actuation Trim, Brass/Galvanized Trim (deluge valve, solenoid valve, pressure switch, and butterfly valves ordered separately)	<b>52-477-2-118</b>	\$3,016.00
24 VDC Latching Solenoid Valve	<b>2460566</b>	\$1,147.00
Model PS10-1 Waterflow Pressure Switch	<b>25700</b>	\$175.50
Model PS10-2 Dual-Contact Waterflow Pressure Switch	<b>25710</b>	\$184.00
4" Model BFV-N Butterfly Valve (2 required)	<b>59-300-F-040N</b>	See Section 18 for Valve pricing.
6" Model BFV-N Butterfly Valve (2 required)	<b>59-300-F-060N</b>	
<b>Accessories for Model DV-5 Deluge Valves with Remote-Resetting, Pressure-Reducing Trim</b>		
Model AD-2 Automatic Drain Valve	<b>52-789-1-004</b>	\$76.25
<b>Replacement Parts for Model DV-5 Deluge Valves with Remote-Resetting, Pressure-Reducing Trim</b>		
4" Model DV-5 Deluge Valve with Remote-Resetting, Pressure-Reducing Trim, Replacement Diaphragm	<b>92-477-1-101</b>	\$2,073.00
6" Model DV-5 Deluge Valve with Remote-Resetting, Pressure-Reducing Trim, Replacement Diaphragm	<b>92-477-1-103</b>	\$3,012.00
Model AD-1 Automatic Drain Valve	<b>52-793-2-004</b>	\$155.00
Model MC-1 Manual Control Station (Galv. Ends) (TFP1382)	<b>52-289-2-001</b>	\$470.50
Water Pressure Gauge, 300 psi (2,000 kPa)	<b>92-343-1-005</b>	\$83.75
24 VDC Impulse Solenoid Valve	<b>2460566</b>	\$1,147.00
Model PS10-1 Waterflow Pressure Switch	<b>25700</b>	\$175.50
Model PS10-2 Dual-Contact Waterflow Pressure Switch	<b>25710</b>	\$184.00
Pilot Valve	<b>92-570-2-200</b>	\$1,541.00
½" Spring-Loaded Check Valve (Circle Seal)	<b>92-322-1-002</b>	\$172.50
½" Y Strainer	<b>52-353-1-005</b>	\$65.25
<b>Technical Data Sheet - TFP1332</b>		

Section 8	Wet System Valves
Section 9	Water Motor Alarms
Section 10	Dry Pipe Valves
Section 11	Quick Opening Devices
Section 12	Air Maintenance Devices
Section 13	Deluge Valves & Accessories
Section 14	Preaction Systems
Section 15	General Purpose Valves

Refer to the latest technical data sheets for specific approvals, listings, design parameters, and available options on [www.tyco-fire.com](http://www.tyco-fire.com).

**Full Deluge Systems and Components**

The following tables will provide information on equipment, required or optional, needed to complete various system packages. Please see the applicable Technical data pages for more information.

**DV-5 Deluge, Wet Pilot Actuation, - 1 1/2" thru 8"**

Description	Part No.	List Price
<b>Required Equipment for Deluge Valve (Select One)</b>		
1 1/2 Inch DV-5 Deluge Valve, Groove x Groove	52-477-1-919	\$2,058.00
1 1/2 Inch DV-5 Deluge Valve, Thread x Thread	52-477-1-069	\$2,058.00
2 Inch DV-5 Deluge Valve, Groove x Groove	52-477-1-910	\$2,151.00
2 Inch DV-5 Deluge Valve, Thread x Thread	52-477-1-060	\$2,151.00
3 Inch DV-5 Deluge Valve, Groove x Groove	52-477-1-912	\$2,338.00
3 Inch DV-5 Deluge Valve, Flange x Flange	52-477-1-012	\$2,338.00
3 Inch DV-5 Deluge Valve, Flange x Groove	52-477-1-412	\$2,338.00
4 Inch DV-5 Deluge Valve, Groove x Groove	52-477-1-913	\$4,028.00
4 Inch DV-5 Deluge Valve, Flange x Flange	52-477-1-013	\$4,028.00
4 Inch DV-5 Deluge Valve, Flange x Groove	52-477-4-613	\$4,028.00
6 Inch DV-5 Deluge Valve, Groove x Groove	52-477-1-915	\$4,911.00
6 Inch DV-5 Deluge Valve, Flange x Flange	52-477-1-015	\$4,911.00
6 Inch DV-5 Deluge Valve, Flange x Groove	52-477-4-615	\$4,911.00
8" Model DV-5 Groove x Groove, 250 PSI	52-477-1-916	\$14,056.00
8" Model DV-5 Flange x Groove, 250 PSI	52-477-1-416	\$14,056.00
8" Model DV-5 Flange x Flange, 250 PSI	52-477-1-016	\$14,056.00
<b>Wet Pilot Deluge Trim (Select One) *Galvanized shown is standard</b>		
1 1/2" & 2" Galvanized	52-477-2-107	\$2,807.00
3" Galvanized	52-477-2-104	\$2,807.00
4", 6" & 8" Galvanized	51-477-2-101	\$2,807.00
<b>Water Flow Pressure Switch</b>		
Model PS10-2A	2571	\$229.50
<b>Optional Equipment for Deluge System, Wet Pilot Release</b>		
600 psi Water Pressure Gauge	92-343-1-004	\$191.00
Model WMA-1 Water Motor Alarm	52-630-1-001	\$725.50
Model OSYSU - 2 Monitor Switch	2412	\$195.50
Model MC-1 Manual Control Station (Galv. Ends) (TFP 1382)	52-289-2-001	\$470.50
<b>Note</b>		
Note: Heat Detectors, Alarm Bells, Trouble Horns, Spray Nozzles, or, Open Sprinklers are ordered separately.		
<b>Technical Data Sheet - TFP1310</b>		

Refer to the latest technical data sheets for specific approvals, listings, design parameters, and available options on [www.tyco-fire.com](http://www.tyco-fire.com).

**Full Deluge Systems and Components**

The following tables will provide information on equipment, required or optional, needed to complete various system packages. Please see the applicable Technical data pages for more information.

**DV-5 Deluge, Dry Pilot Actuation, - 1 1/2" thru 8"**

Description	Part No.	List Price
<b>Required Equipment for Deluge Valve (Select One)</b>		
1-1/2 Inch DV-5 Deluge Valve, Groove x Groove	<b>52-477-1-919</b>	\$2,058.00
1-1/2 Inch DV-5 Deluge Valve, Thread x Thread	<b>52-477-1-069</b>	\$2,058.00
2 Inch DV-5 Deluge Valve, Groove x Groove	<b>52-477-1-910</b>	\$2,151.00
2 Inch DV-5 Deluge Valve, Thread x Thread	<b>52-477-1-060</b>	\$2,151.00
3 Inch DV-5 Deluge Valve, Groove x Groove	<b>52-477-1-912</b>	\$2,338.00
3 Inch DV-5 Deluge Valve, Flange x Flange	<b>52-477-1-012</b>	\$2,338.00
3 Inch DV-5 Deluge Valve, Flange x Groove	<b>52-477-1-412</b>	\$2,338.00
4 Inch DV-5 Deluge Valve, Groove x Groove	<b>52-477-1-913</b>	\$4,028.00
4 Inch DV-5 Deluge Valve, Flange x Flange	<b>52-477-1-013</b>	\$4,028.00
4 Inch DV-5 Deluge Valve, Flange x Groove	<b>52-477-4-613</b>	\$4,028.00
6 Inch DV-5 Deluge Valve, Groove x Groove	<b>52-477-1-915</b>	\$4,911.00
6 Inch DV-5 Deluge Valve, Flange x Flange	<b>52-477-1-015</b>	\$4,911.00
6 Inch DV-5 Deluge Valve, Flange x Groove	<b>52-477-4-615</b>	\$4,911.00
8" Model DV-5 Groove x Groove, 250 PSI	<b>52-477-1-916</b>	\$14,056.00
8" Model DV-5 Flange x Groove, 250 PSI	<b>52-477-1-416</b>	\$14,056.00
8" Model DV-5 Flange x Flange, 250 PSI	<b>52-477-1-016</b>	\$14,056.00
<b>Dry Pilot Deluge Trim (Select One) *Galvanized shown is standard</b>		
1 1/2" & 2" Galvanized	<b>52-477-2-108</b>	\$3,740.00
3" Galvanized	<b>52-477-2-105</b>	\$3,740.00
4", 6" & 8" Galvanized	<b>52-477-2-102</b>	\$3,795.00
<b>Water Flow Pressure Switch</b>		
Model PS10-2A	<b>2571</b>	\$229.50
<b>Dry Pilot Low Air Pressure Switch</b>		
Model PS40-2A	<b>2573</b>	\$236.00
<b>Automatic System Air Supply (Select One)</b>		
Model AMD-1 Air Maintenance Device (TFP 1221)	<b>52-324-2-002</b>	\$927.50
Model AMD-2 Air Maintenance Device (TFP 1231)	<b>52-326-2-001</b>	\$1,367.00
Model AMD-3 Nitrogen Air Maintenance Device (TFP 1241)	<b>52-328-2-001</b>	\$1,815.00
<b>Optional Equipment for Deluge System, Dry Pilot Release</b>		
600 psi Water Pressure Gauge	<b>92-343-1-004</b>	\$191.00
Model WMA-1 Water Motor Alarm	<b>52-630-1-001</b>	\$725.50
Model OSYSU - 2 Monitor Switch	<b>2412</b>	\$195.50
Model MC-1 Manual Control Station (Galv. Ends) (TFP 1382)	<b>52-289-2-001</b>	\$470.50
<b>Note</b>		
Note: Heat Detectors, Alarm Bells, Trouble Horns, Spray Nozzles, or, Open Sprinklers are ordered separately.		
<b>Technical Data Sheet - TFP1315</b>		

Section 8  
Wet System Valves

Section 9  
Water Motor Alarms

Section 10  
Dry Pipe Valves

Section 11  
Quick Opening Devices

Section 12  
Air Maintenance Devices

Section 13  
Deluge Valves & Accessories

Section 14  
Preaction Systems

Section 15  
General Purpose Valves

Refer to the latest technical data sheets for specific approvals, listings, design parameters, and available options on [www.tyco-fire.com](http://www.tyco-fire.com).

**Full Deluge Systems and Components**

The following tables will provide information on equipment, required or optional, needed to complete various system packages. Please see the applicable Technical data pages for more information.

**DV-5 Deluge, Electric Actuation, - 1 1/2" thru 8"**

Description	Part No.	List Price
<b>Required Equipment for Deluge Valve (Select One)</b>		
1 1/2 Inch DV-5 Deluge Valve, Groove x Groove	52-477-1-919	\$2,058.00
1 1/2 Inch DV-5 Deluge Valve, Thread x Thread	52-477-1-069	\$2,058.00
2 Inch DV-5 Deluge Valve, Groove x Groove	52-477-1-910	\$2,151.00
2 Inch DV-5 Deluge Valve, Thread x Thread	52-477-1-060	\$2,151.00
3 Inch DV-5 Deluge Valve, Groove x Groove	52-477-1-912	\$2,338.00
3 Inch DV-5 Deluge Valve, Flange x Flange	52-477-1-012	\$2,338.00
3 Inch DV-5 Deluge Valve, Flange x Groove	52-477-1-412	\$2,338.00
4 Inch DV-5 Deluge Valve, Groove x Groove	52-477-1-913	\$4,028.00
4 Inch DV-5 Deluge Valve, Flange x Flange	52-477-1-013	\$4,028.00
4 Inch DV-5 Deluge Valve, Flange x Groove	52-477-4-613	\$4,028.00
6 Inch DV-5 Deluge Valve, Groove x Groove	52-477-1-915	\$4,911.00
6 Inch DV-5 Deluge Valve, Flange x Flange	52-477-1-015	\$4,911.00
6 Inch DV-5 Deluge Valve, Flange x Groove	52-477-4-615	\$4,911.00
8" Model DV-5 Groove x Groove, 250 PSI	52-477-1-916	\$14,056.00
8" Model DV-5 Flange x Groove, 250 PSI	52-477-1-416	\$14,056.00
8" Model DV-5 Flange x Flange, 250 PSI	52-477-1-016	\$14,056.00
<b>Electric Actuation Deluge Trim (Select One) *Galvanized shown is standard</b>		
1 1/2" & 2" Galvanized	52-477-2-109	\$2,807.00
3" Galvanized	52-477-2-106	\$2,807.00
4", 6" & 8" Galvanized	51-477-2-103	\$2,807.00
<b>Water Flow Pressure Switch</b>		
Model PS10-2A	2571	\$229.50
<b>Solenoid Valve 24VDC (Select One)</b>		
175 psi 24VDC Solenoid Valve	52-287-1-024	\$1,147.00
250 psi 24VDC Solenoid Valve	52-287-1-124	POA
<b>Optional Equipment for Deluge System, Electric Actuation</b>		
600 psi Water Pressure Gauge	92-343-1-004	\$191.00
Model WMA-1 Water Motor Alarm	52-630-1-001	\$725.50
Model OSYSU - 2 Monitor Switch	2412	\$195.50
Model MC-1 Manual Control Station (Galv. Ends) (TFP 1382)	52-289-2-001	\$470.50
<b>Note</b>		
Note: Heat Detectors, Alarm Bells, Trouble Horns, Spray Nozzles, or, Open Sprinklers are ordered separately.		
<b>Technical Data Sheet - TFP1320</b>		

Refer to the latest technical data sheets for specific approvals, listings, design parameters, and available options on [www.tyco-fire.com](http://www.tyco-fire.com).



**Red-E-Cabinet With DV-5 Deluge Valve  
Praction, Single Interlock, Double Interlock and Deluge Packages**

**P/N 5 2 - 8 X X - X - X X X**

Valve	DV-5 Style	Size	Actuation Device	Air Maintenance Device	Trim Type	US / Canada	Compressor
52	8	1 1/2" = 1	Deluge / Wet = 1	None = 0	Galvanized = 1	None = 0	None = 0
52	8	2" = 2	Deluge / Dry = 2	<b>Please Note:</b> All cabinets ordered with a riser mounted compressor will automatically come with an air maintenance device.	Black = 2	USA = A	1/3 hp 215 Gal = 2
52	8	3" = 3	Deluge / Elec = 3		Brass = 3	Canada = C	1/2 hp 335 Gal = 3
52	8	4" = 4	S/I Wet = 4		For Orders With No Control Panel, Deduct \$325 From The Price		3/4 hp 435 Gal = 4
52	8	6" = 6	S/I Dry = 5	1 hp 610 Gal = 5			
52	8		S/I Elec = 6	1 hp 900 Gal = 6			
52	8		D/I Elec / Pneu = 7	1 hp 1200 Gal = 7			
52	8		D/I Elec / Elec = 8	S/I Compressor = 8			

S/I = Single Interlock • D/I = Double Interlock

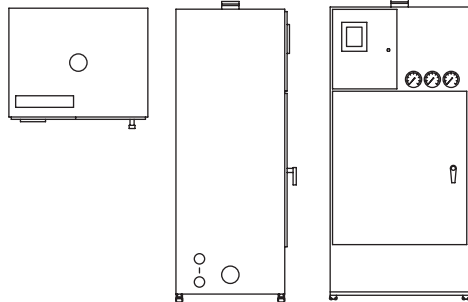

**Note:**  
All quotes are FOB manufacturer and are considered "Special Order" and are Non-Returnable.

For orders with no Control Panel, deduct \$325 from the price

Please see "Terms & Conditions"

**Deluge Valve**

Description	Canadian Part No.	Canadian List Price	U.S. Part No.	U.S. List Price
Red-E DV-5 1 1/2" Deluge with Electric Actuation, Galvanized Trim, US or Canadian Control Panel	52-813-0-1C0	\$20,438.00	52-813-0-1A0	\$19,378.00
Red-E DV-5 2" Deluge with Electric Actuation, Galvanized Trim, US or Canadian Control Panel	52-823-0-1C0	\$20,680.00	52-823-0-1A0	\$19,609.00
Red-E DV-5 3" Deluge with Electric Actuation, Galvanized Trim, US or Canadian Control Panel	52-833-0-1C0	\$20,867.00	52-833-0-1A0	\$19,787.00
Red-E DV-5 4" Deluge with Electric Actuation, Galvanized Trim, US or Canadian Control Panel	52-843-0-1C0	\$23,127.00	52-843-0-1A0	\$21,967.00
Red-E DV-5 6" Deluge with Electric Actuation, Galvanized Trim, US or Canadian Control Panel	52-863-0-1C0	\$24,288.00	52-863-0-1A0	\$23,085.00

**Single Interlock Praction**

Red-E DV-5 1 1/2" Single Interlock Praction with Electric Actuation, Galvanized Trim, US or Canadian Control Panel, Single Interlock Compressor	52-816-0-1C8	\$25,090.00	52-816-0-1A8	\$23,858.00
Red-E DV-5 2" Single Interlock Praction with Electric Actuation, Galvanized Trim, US or Canadian Control Panel, Single Interlock Compressor	52-826-0-1C8	\$25,074.00	52-826-0-1A8	\$23,842.00
Red-E DV-5 3" Single Interlock Praction with Electric Actuation, Galvanized Trim, US or Canadian Control Panel, Single Interlock Compressor	52-836-0-1C8	\$25,331.00	52-836-0-1A8	\$24,091.00
Red-E DV-5 4" Single Interlock Praction with Electric Actuation, Galvanized Trim, US or Canadian Control Panel, Single Interlock Compressor	52-846-0-1C8	\$28,457.00	52-846-0-1A8	\$27,104.00
Red-E DV-5 6" Single Interlock Praction with Electric Actuation, Galvanized Trim, US or Canadian Control Panel, Single Interlock Compressor	52-866-0-1C8	\$30,029.00	52-866-0-1A8	\$28,619.00

Refer to the latest technical data sheets for specific approvals, listings, design parameters, and available options on [www.tyco-fire.com](http://www.tyco-fire.com).

Section 8  
Wet System Valves

Section 9  
Water Motor Alarms

Section 10  
Dry Pipe Valves

Section 11  
Quick Opening Devices

Section 12  
Air Maintenance Devices

Section 13  
Deluge Valves & Accessories

Section 14  
Praction Systems

Section 15  
General Purpose Valves

<b>Red-E-Cabinet With DV-5 Deluge Valve Praction, Single Interlock, Double Interlock and Deluge Packages</b>					
<b>Double Interlock Praction Electric/Electric Actuation</b>					
	<i>Description</i>	<i>Canadian Part No.</i>	<i>Canadian List Price</i>	<i>U.S. Part No.</i>	<i>U.S. List Price</i>
Section 8 Wet System Valves	Red-E DV-5 1 1/2" Double Interlock Praction Electric-Electric Actuation, Galvanized Trim, US or Canadian Control Panel, 1/6 Hp OL110 Compressor	<b>52-818-0-1C1</b>	\$25,227.00	<b>52-818-0-1A1</b>	\$23,989.00
Section 9 Water Motor Alarms	Red-E DV-5 1 1/2" Double Interlock Praction Electric-Electric Actuation, Galvanized Trim, US or Canadian Control Panel, 1/3 Hp OL215 Compressor	<b>52-818-0-1C2</b>	\$25,731.00	<b>52-818-0-1A2</b>	\$24,477.00
	Red-E DV-5 1 1/2" Double Interlock Praction Electric-Electric Actuation, Galvanized Trim, US or Canadian Control Panel, 1/2 Hp OL335 Compressor	<b>52-818-0-1C3</b>	\$26,229.00	<b>52-818-0-1A3</b>	\$24,956.00
Section 10 Dry Pipe Valves	Red-E DV-5 2" Double Interlock Praction Electric-Electric Actuation, Galvanized Trim, US or Canadian Control Panel, 1/6 Hp OL110 Compressor	<b>52-828-0-1C1</b>	\$25,212.00	<b>52-828-0-1A1</b>	\$23,975.00
	Red-E DV-5 2" Double Interlock Praction Electric-Electric Actuation, Galvanized Trim, US or Canadian Control Panel, 1/3 Hp OL215 Compressor	<b>52-828-0-1C2</b>	\$25,715.00	<b>52-828-0-1A2</b>	\$24,461.00
	Red-E DV-5 2" Double Interlock Praction Electric-Electric Actuation, Galvanized Trim, US or Canadian Control Panel, 1/2 Hp OL335 Compressor	<b>52-828-0-1C3</b>	\$26,212.00	<b>52-828-0-1A3</b>	\$24,939.00
Section 11 Quick Opening Devices	Red-E DV-5 3" Double Interlock Praction Electric-Electric Actuation, Galvanized Trim, US or Canadian Control Panel, 1/6 Hp OL110 Compressor	<b>52-838-0-1C1</b>	\$25,419.00	<b>52-838-0-1A1</b>	\$24,177.00
	Red-E DV-5 3" Double Interlock Praction Electric-Electric Actuation, Galvanized Trim, US or Canadian Control Panel, 1/3 Hp OL215 Compressor	<b>52-838-0-1C2</b>	\$25,926.00	<b>52-838-0-1A2</b>	\$24,662.00
	Red-E DV-5 3" Double Interlock Praction Electric-Electric Actuation, Galvanized Trim, US or Canadian Control Panel, 1/2 Hp OL335 Compressor	<b>52-838-0-1C3</b>	\$26,413.00	<b>52-838-0-1A3</b>	\$25,134.00
	Red-E DV-5 4" Double Interlock Praction Electric-Electric Actuation, Galvanized Trim, UUS or Canadian Control Panel, 1/6 Hp OL110 Compressor	<b>52-848-0-1C1</b>	\$28,547.00	<b>52-848-0-1A1</b>	\$27,189.00
Section 12 Air Maintenance Devices	Red-E DV-5 4" Double Interlock Praction Electric-Electric Actuation, Galvanized Trim, US or Canadian Control Panel, 1/3 Hp OL215 Compressor	<b>52-848-0-1C2</b>	\$29,050.00	<b>52-848-0-1A2</b>	\$27,675.00
	Red-E DV-5 4" Double Interlock Praction Electric-Electric Actuation, Galvanized Trim, US or Canadian Control Panel, 1/2 Hp OL335 Compressor	<b>52-848-0-1C3</b>	\$29,549.00	<b>52-848-0-1A3</b>	\$28,155.00
	Red-E DV-5 4" Double Interlock Praction Electric-Electric Actuation, Galvanized Trim, US or Canadian Control Panel, 3/4 Hp OL435 Compressor	<b>52-848-0-1C4</b>	\$30,246.00	<b>52-848-0-1A4</b>	\$28,828.00
	Red-E DV-5 4" Double Interlock Praction Electric-Electric Actuation, Galvanized Trim, US or Canadian Control Panel, 1 Hp OL610 Compressor	<b>52-848-0-1C5</b>	\$30,319.00	<b>52-848-0-1A5</b>	\$28,895.00
	Red-E DV-5 4" Double Interlock Praction Electric-Electric Actuation, Galvanized Trim, US or Canadian Control Panel, 1 Hp OL900 Compressor	<b>52-848-0-1C6</b>	\$32,114.00	<b>52-848-0-1A6</b>	\$30,627.00
Section 13 Deluge Valves & Accessories	Red-E DV-5 4" Double Interlock Praction Electric-Electric Actuation, Galvanized Trim, US or Canadian Control Panel, 2 Hp OL1200 Compressor	<b>52-848-0-1C7</b>	\$32,596.00	<b>52-848-0-1A7</b>	\$31,091.00
	Red-E DV-5 6" Double Interlock Praction Electric-Electric Actuation, Galvanized Trim, US or Canadian Control Panel, 1/6 Hp OL110 Compressor	<b>52-868-0-1C1</b>	\$30,126.00	<b>52-868-0-1A1</b>	\$28,710.00
	Red-E DV-5 6" Double Interlock Praction Electric-Electric Actuation, Galvanized Trim, US or Canadian Control Panel, 1/3 Hp OL215 Compressor	<b>52-868-0-1C2</b>	\$30,622.00	<b>52-868-0-1A2</b>	\$29,190.00
	Red-E DV-5 6" Double Interlock Praction Electric-Electric Actuation, Galvanized Trim, US or Canadian Control Panel, 1/2 Hp OL335 Compressor	<b>52-868-0-1C3</b>	\$31,120.00	<b>52-868-0-1A3</b>	\$29,669.00
	Red-E DV-5 6" Double Interlock Praction Electric-Electric Actuation, Galvanized Trim, US or Canadian Control Panel, 3/4 Hp OL435 Compressor	<b>52-868-0-1C4</b>	\$31,819.00	<b>52-868-0-1A4</b>	\$30,341.00
	Red-E DV-5 6" Double Interlock Praction Electric-Electric Actuation, Galvanized Trim, US or Canadian Control Panel, 1 Hp OL610 Compressor	<b>52-868-0-1C5</b>	\$31,890.00	<b>52-868-0-1A5</b>	\$30,410.00
	Red-E DV-5 6" Double Interlock Praction Electric-Electric Actuation, Galvanized Trim, US or Canadian Control Panel, 1 Hp OL900 Compressor	<b>52-868-0-1C6</b>	\$33,696.00	<b>52-868-0-1A6</b>	\$32,150.00
Section 14 Praction Systems	Red-E DV-5 6" Double Interlock Praction Electric-Electric Actuation, Galvanized Trim, US or Canadian Control Panel, 2 Hp OL1200 Compressor	<b>52-868-0-1C7</b>	\$34,166.00	<b>52-868-0-1A7</b>	\$32,605.00
Section 15 General Purpose Valves					

Refer to the latest technical data sheets for specific approvals, listings, design parameters, and available options on [www.tyco-fire.com](http://www.tyco-fire.com).

**Red-E-Cabinet With DV-5 Deluge Valve**  
**Precision, Single Interlock, Double Interlock and Deluge Packages**

**Double Interlock Precision Electric/Pneumatic Actuation**

Description	Canadian Part No.	Canadian List Price	U.S. Part No.	U.S. List Price
Red-E DV-5 1-1/2" Double Interlock Precision Electric-Pneumatic Actuation, Galvanized Trim, US or Canadian Control Panel, 1/6 Hp OL110 Compressor	52-817-0-1C1	\$25,580.00	52-817-0-1A1	\$24,331.00
Red-E DV-5 1-1/2" Double Interlock Precision Electric-Pneumatic Actuation, Galvanized Trim, US or Canadian Control Panel, 1/3 Hp OL215 Compressor	52-817-0-1C2	\$26,084.00	52-817-0-1A2	\$24,818.00
Red-E DV-5 1-1/2" Double Interlock Precision Electric-Pneumatic Actuation, Galvanized Trim, US or Canadian Control Panel, 1/2 Hp OL335 Compressor	52-817-0-1C3	\$26,581.00	52-817-0-1A3	\$25,295.00
Red-E DV-5 2" Double Interlock Precision Electric-Pneumatic Actuation, Galvanized Trim, US or Canadian Control Panel, 1/6 Hp OL110 Compressor	52-827-0-1C1	\$25,572.00	52-827-0-1A1	\$24,322.00
Red-E DV-5 2" Double Interlock Precision Electric-Pneumatic Actuation, Galvanized Trim, US or Canadian Control Panel, 1/3 Hp OL215 Compressor	52-827-0-1C2	\$26,069.00	52-827-0-1A2	\$24,801.00
Red-E DV-5 2" Double Interlock Precision Electric-Pneumatic Actuation, Galvanized Trim, US or Canadian Control Panel, 1/2 Hp OL335 Compressor	52-827-0-1C3	\$26,566.00	52-827-0-1A3	\$25,282.00
Red-E DV-5 3" Double Interlock Precision Electric-Pneumatic Actuation, Galvanized Trim, US or Canadian Control Panel, 1/6 Hp OL110 Compressor	52-837-0-1C1	\$26,149.00	52-837-0-1A1	\$24,879.00
Red-E DV-5 3" Double Interlock Precision Electric-Pneumatic Actuation, Galvanized Trim, US or Canadian Control Panel, 1/3 Hp OL215 Compressor	52-837-0-1C2	\$26,654.00	52-837-0-1A2	\$25,364.00
Red-E DV-5 3" Double Interlock Precision Electric-Pneumatic Actuation, Galvanized Trim, US or Canadian Control Panel, 1/2 Hp OL335 Compressor	52-837-0-1C3	\$27,144.00	52-837-0-1A3	\$25,837.00
Red-E DV-5 4" Double Interlock Precision Electric-Pneumatic Actuation, Galvanized Trim, US or Canadian Control Panel, 1/6 Hp OL110 Compressor	52-847-0-1C1	\$29,275.00	52-847-0-1A1	\$27,891.00
Red-E DV-5 4" Double Interlock Precision Electric-Pneumatic Actuation, Galvanized Trim, US or Canadian Control Panel, 1/3 Hp OL215 Compressor	52-847-0-1C2	\$29,781.00	52-847-0-1A2	\$28,379.00
Red-E DV-5 4" Double Interlock Precision Electric-Pneumatic Actuation, Galvanized Trim, US or Canadian Control Panel, 1/2 Hp OL335 Compressor	52-847-0-1C3	\$30,278.00	52-847-0-1A3	\$28,859.00
Red-E DV-5 4" Double Interlock Precision Electric-Pneumatic Actuation, Galvanized Trim, US or Canadian Control Panel, 3/4 Hp OL435 Compressor	52-847-0-1C4	\$30,975.00	52-847-0-1A4	\$29,529.00
Red-E DV-5 4" Double Interlock Precision Electric-Pneumatic Actuation, Galvanized Trim, US or Canadian Control Panel, 1 Hp OL610 Compressor	52-847-0-1C5	\$31,049.00	52-847-0-1A5	\$29,600.00
Red-E DV-5 4" Double Interlock Precision Electric-Pneumatic Actuation, Galvanized Trim, US or Canadian Control Panel, 1 Hp OL900 Compressor	52-847-0-1C6	\$32,844.00	52-847-0-1A6	\$31,330.00
Red-E DV-5 4" Double Interlock Precision Electric-Pneumatic Actuation, Galvanized Trim, US or Canadian Control Panel, 2 Hp OL1200 Compressor	52-847-0-1C7	\$33,325.00	52-847-0-1A7	\$31,794.00
Red-E DV-5 6" Double Interlock Precision Electric-Pneumatic Actuation, Galvanized Trim, US or Canadian Control Panel, 1/6 Hp OL110 Compressor	52-867-0-1C1	\$29,884.00	52-867-0-1A1	\$28,478.00
Red-E DV-5 6" Double Interlock Precision Electric-Pneumatic Actuation, Galvanized Trim, US or Canadian Control Panel, 1/3 Hp OL215 Compressor	52-867-0-1C2	\$30,382.00	52-867-0-1A2	\$28,958.00
Red-E DV-5 6" Double Interlock Precision Electric-Pneumatic Actuation, Galvanized Trim, US or Canadian Control Panel, 1/2 Hp OL335 Compressor	52-867-0-1C3	\$30,879.00	52-867-0-1A3	\$29,437.00
Red-E DV-5 6" Double Interlock Precision Electric-Pneumatic Actuation, Galvanized Trim, US or Canadian Control Panel, 3/4 Hp OL435 Compressor	52-867-0-1C4	\$31,080.00	52-867-0-1A4	\$29,631.00
Red-E DV-5 6" Double Interlock Precision Electric-Pneumatic Actuation, Galvanized Trim, US or Canadian Control Panel, 1 Hp OL610 Compressor	52-867-0-1C5	\$31,649.00	52-867-0-1A5	\$30,178.00
Red-E DV-5 6" Double Interlock Precision Electric-Pneumatic Actuation, Galvanized Trim, US or Canadian Control Panel, 1 Hp OL900 Compressor	52-867-0-1C6	\$33,454.00	52-867-0-1A6	\$31,917.00
Red-E DV-5 6" Double Interlock Precision Electric-Pneumatic Actuation, Galvanized Trim, US or Canadian Control Panel, 2 Hp OL1200 Compressor	52-867-0-1C7	\$33,927.00	52-867-0-1A7	\$32,374.00

**Technical Data Sheet Deluge-TFP1300, Precision-TFP1400**

Section 8  
Wet System Valves

Section 9  
Water Motor Alarms

Section 10  
Dry Pipe Valves

Section 11  
Quick Opening Devices

Section 12  
Air Maintenance Devices

Section 13  
Deluge Valves & Accessories

Section 14  
Precision Systems

Section 15  
General Purpose Valves

Refer to the latest technical data sheets for specific approvals, listings, design parameters, and available options on [www.tyco-fire.com](http://www.tyco-fire.com).

**Red-E-Cabinet with "MCC" Mist Control Center  
Preassembled Fire Pump, Controller, Deluge Valve Cabinet & Releasing Panel**

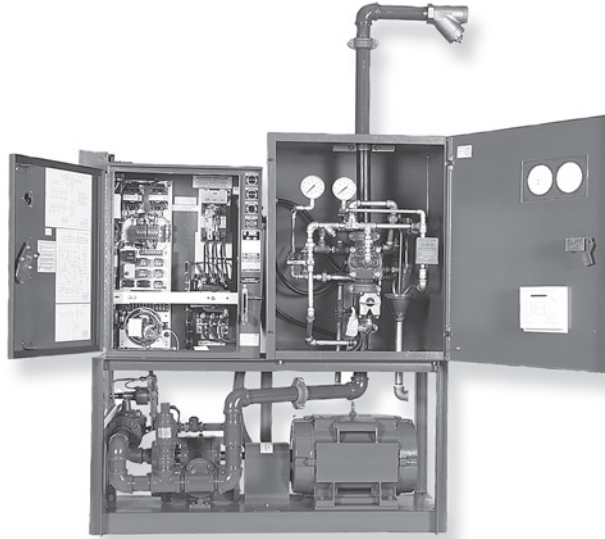

**Aquamist Control Center**

<i>Description</i>	<i>Part No.</i>	<i>List Price</i>
MCC-1 Mist Control Center, Provides 4-60 GPM	<b>52-811-1-111</b>	POA
MCC-2 Mist Control Center, Provides 60-120 GPM	<b>52-811-1-112</b>	POA

Section 8  
Wet System Valves

Section 9  
Water Motor Alarms

Section 10  
Dry Pipe Valves

Section 11  
Quick Opening Devices

Section 12  
Air Maintenance Devices

Section 13  
Deluge Valves & Accessories

Section 14  
Preaction Systems

Section 15  
General Purpose Valves

Refer to the latest technical data sheets for specific approvals, listings, design parameters, and available options on [www.tyco-fire.com](http://www.tyco-fire.com).

**DV-5 Pre-Trimmed Deluge & Preaction Systems,  
Wet Pilot, Dry Pilot, or Electric Actuation**

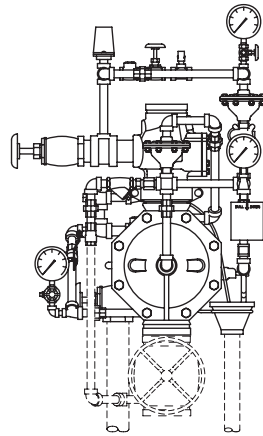

**Each Pre-Trimmed Valve Contains:**

- Deluge Valve
- Riser Check Valve
- Actuation Trim with Solenoid Valve
- Pneumatic Actuator (if Applicable)
- Pressure Switch
- All Connection Fittings and Devices

**Each Pre-Trimmed Valve System Is Individually Palletized and Packaged**

Description	Part No.	Average Wt. Ea.	List Price
<b>Pre-Trimmed, Deluge Wet Pilot Actuation, US Model, Groove x Groove</b>			
1 1/2" Pre-Trimmed DV-5 Deluge Valve with Wet Pilot Actuation with Galvanized Trim	52-811-01A-P	-	\$5,837.00
2" Pre-Trimmed DV-5 Deluge Valve with Wet Pilot Actuation with Galvanized Trim	52-821-01A-P	-	\$5,930.00
3" Pre-Trimmed DV-5 Deluge Valve with Wet Pilot Actuation with Galvanized Trim	52-831-01A-P	-	\$6,117.00
4" Pre-Trimmed DV-5 Deluge Valve with Wet Pilot Actuation with Galvanized Trim	52-841-01A-P	-	\$7,807.00
6" Pre-Trimmed DV-5 Deluge Valve with Wet Pilot Actuation with Galvanized Trim	52-861-01A-P	-	\$8,690.00
8" Pre-Trimmed DV-5 Deluge Valve with Wet Pilot Actuation with Galvanized Trim	52-881-01A-P	-	\$17,835.00
<b>Note:</b> For a Complete List of System Components, Please Refer to Page:13-8 Control Valve is Sold Separately, Please Refer to Pages 15-2 & 15-3			
<b>Pre-Trimmed, Deluge Dry Pilot Actuation, US Model, Groove x Groove</b>			
1 1/2" Pre-Trimmed DV-5 Deluge Valve with Dry Pilot Actuation with Galvanized Trim	52-812-01A-P	-	\$6,782.00
2" Pre-Trimmed DV-5 Deluge Valve with Dry Pilot Actuation with Galvanized Trim	52-822-01A-P	-	\$6,875.00
3" Pre-Trimmed DV-5 Deluge Valve with Dry Pilot Actuation with Galvanized Trim	52-832-01A-P	-	\$7,062.00
4" Pre-Trimmed DV-5 Deluge Valve with Dry Pilot Actuation with Galvanized Trim	52-842-01A-P	-	\$8,752.00
6" Pre-Trimmed DV-5 Deluge Valve with Dry Pilot Actuation with Galvanized Trim	52-862-01A-P	-	\$9,635.00
8" Pre-Trimmed DV-5 Deluge Valve with Dry Pilot Actuation with Galvanized Trim	52-882-01A-P	-	\$18,780.00
<b>Note:</b> For a Complete List of System Components, Please Refer to Page:13-9 Control Valve is Sold Separately, Please Refer to Pages 15-2 & 15-3			
<b>Pre-Trimmed, Deluge Electric Actuation, US Model, Groove x Groove</b>			
1 1/2" Pre-Trimmed DV-5 Deluge Valve with Electric Actuation with Galvanized Trim	52-813-01A-P	75 Lbs	\$5,837.00
2" Pre-Trimmed DV-5 Deluge Valve with Electric with Galvanized Trim	52-823-01A-P	75 Lbs	\$5,930.00
3" Pre-Trimmed DV-5 Deluge Valve with Electric with Galvanized Trim	52-833-01A-P	120 Lbs	\$6,117.00
4" Pre-Trimmed DV-5 Deluge Valve with Electric with Galvanized Trim	52-843-01A-P	160 Lbs	\$7,807.00
6" Pre-Trimmed DV-5 Deluge Valve with Electric with Galvanized Trim	52-863-01A-P	220 Lbs	\$8,690.00
8" Pre-Trimmed DV-5 Deluge Valve with Electric with Galvanized Trim	52-883-01A-P	280 Lbs	\$17,835.00
<b>Note:</b> For a Complete List of System Components, Please Refer to Page:13-10 Control Valve is Sold Separately, Please Refer to Pages 15-2 & 15-3			

Section 8 Wet System Valves  
 Section 9 Water Motor Alarms  
 Section 10 Dry Pipe Valves  
 Section 11 Quick Opening Devices  
 Section 12 Air Maintenance Devices  
 Section 13 Deluge Valves & Accessories  
 Section 14 Preaction Systems  
 Section 15 General Purpose Valves

Refer to the latest technical data sheets for specific approvals, listings, design parameters, and available options on [www.tyco-fire.com](http://www.tyco-fire.com).



**DV-5 Pre-Trimmed Deluge & Preaction Systems,  
Single or Double Interlock**

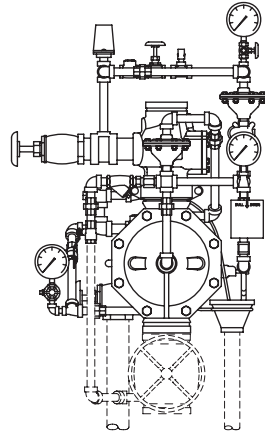

**Each Pre-Trimmed Valve  
Contains:**

- Deluge Valve
- Riser Check Valve
- Actuation Trim with Solenoid Valve
- Pneumatic Actuator (if Applicable)
- Pressure Switch
- All Connection Fittings and Devices

**Each Pre-Trimmed Valve  
System Is Individually  
Palletized and Packaged**

Description	Part No.	Average Wt. Ea.	List Price
<b>Pre-Trimmed, Double Interlock Electric-Pneumatic Actuation, US Model, Groove x Groove</b>			
1 1/2" Pre-Trimmed DV-5 Double Interlock "Electric-Pneumatic" Actuation with Galvanized Trim	<b>52-817-01A-P</b>	75 Lbs	\$9,013.00
2" Pre-Trimmed DV-5 Double Interlock "Electric-Pneumatic" Actuation with Galvanized Trim	<b>52-827-01A-P</b>	75 Lbs	\$9,013.00
3" Pre-Trimmed DV-5 Double Interlock "Electric-Pneumatic" Actuation with Galvanized Trim	<b>52-837-01A-P</b>	120 Lbs	\$9,084.00
4" Pre-Trimmed DV-5 Double Interlock "Electric-Pneumatic" Actuation with Galvanized Trim	<b>52-847-01A-P</b>	160 Lbs	\$10,934.00
6" Pre-Trimmed DV-5 Double Interlock "Electric-Pneumatic" Actuation with Galvanized Trim	<b>52-867-01A-P</b>	220 Lbs	\$11,938.00
8" Pre-Trimmed DV-5 Double Interlock "Electric-Pneumatic" Actuation with Galvanized Trim	<b>52-887-01A-P</b>	280 Lbs	POA
<b>Note:</b> For a Complete List of System Components, Please Refer to Page:14-4 Control Valve is Sold Separately, Please Refer to Pages 15-2 & 15-3			
<b>Pre-Trimmed, Double Interlock Electric-Electric Actuation, US Model, Groove x Groove</b>			
1 1/2" Pre-Trimmed DV-5 Double Interlock "Electric-Electric" Actuation with Galvanized Trim	<b>52-818-01A-P</b>	75 Lbs	\$6,861.00
2" Pre-Trimmed DV-5 Double Interlock "Electric-Electric" Actuation with Galvanized Trim	<b>52-828-01A-P</b>	75 Lbs	\$6,861.00
3" Pre-Trimmed DV-5 Double Interlock "Electric-Electric" Actuation with Galvanized Trim	<b>52-838-01A-P</b>	120 Lbs	\$6,933.00
4" Pre-Trimmed DV-5 Double Interlock "Electric-Electric" Actuation with Galvanized Trim	<b>52-848-01A-P</b>	160 Lbs	\$8,652.00
6" Pre-Trimmed DV-5 Double Interlock "Electric-Electric" Actuation with Galvanized Trim	<b>52-868-01A-P</b>	220 Lbs	\$9,748.00
8" Pre-Trimmed DV-5 Double Interlock "Electric-Electric" Actuation with Galvanized Trim	<b>52-888-01A-P</b>	280 Lbs	POA
<b>Note:</b> For a Complete List of System Components, Please Refer to Page:14-5, Control Valve is Sold Separately, Please Refer to Pages 15-2 & 15-3			
<b>Pre-Trimmed, Single Interlock Electric Actuation, US Model, Groove x Groove</b>			
1 1/2" Pre-Trimmed DV-5 Single Interlock Electric Actuation with Galvanized Trim	<b>52-816-01A-P</b>	75 Lbs	\$7,048.00
2" Pre-Trimmed DV-5 Single Interlock Electric Actuation with Galvanized Trim	<b>52-826-01A-P</b>	75 Lbs	\$7,048.00
3" Pre-Trimmed DV-5 Single Interlock Electric Actuation with Galvanized Trim	<b>52-836-01A-P</b>	120 Lbs	\$7,122.00
4" Pre-Trimmed DV-5 Single Interlock Electric Actuation with Galvanized Trim	<b>52-846-01A-P</b>	160 Lbs	\$9,445.00
6" Pre-Trimmed DV-5 Single Interlock Electric Actuation with Galvanized Trim	<b>52-866-01A-P</b>	220 Lbs	\$10,456.00
8" Pre-Trimmed DV-5 Single Interlock Electric Actuation with Galvanized Trim	<b>52-886-01A-P</b>	280 Lbs	POA
<b>Note:</b> For a Complete List of System Components, Please Refer to Page:14-3, Control Valve is Sold Separately, Please Refer to Pages 15-2 & 15-3			

Refer to the latest technical data sheets for specific approvals, listings, design parameters, and available options on [www.tyco-fire.com](http://www.tyco-fire.com).

**DV-5 Pre-Trimmed Deluge & Preaction Systems with Remote-Resetting or Remote-Resetting, Pressure Reducing Trim**

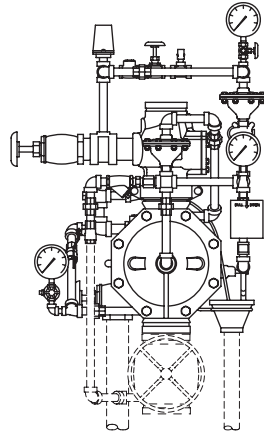

**Each Pre-Trimmed Valve Contains:**

- Deluge Valve
- Riser Check Valve
- Actuation Trim with Solenoid Valve
- Pneumatic Actuator (if Applicable)
- Pressure Switch
- All Connection Fittings and Devices

**Each Pre-Trimmed Valve System Is Individually Palletized and Packaged**

<i>Description</i>	<i>Part No.</i>	<i>List Price</i>
<b>Pre-Trimmed with Remote-Resetting Trim, US Model, Groove x Groove</b>		
2" Pre-Trimmed DV-5 Deluge Valve with Remote-Resetting Trim	<b>90-280-00-261</b>	\$8,502.00
3" Pre-Trimmed DV-5 Deluge Valve with Remote-Resetting Trim	<b>90-380-00-261</b>	\$9,620.00
4" Pre-Trimmed DV-5 Deluge Valve with Remote-Resetting Trim	<b>90-480-00-261</b>	\$11,596.00
6" Pre-Trimmed DV-5 Deluge Valve with Remote-Resetting Trim	<b>90-680-00-261</b>	\$13,832.00
8" Pre-Trimmed DV-5 Deluge Valve with Remote-Resetting Trim	<b>90-880-00-261</b>	\$19,344.00
<b>Note:</b> For a Complete List of System Components, Please Refer to Pages:13-4 & 13-5 Control Valve is Sold Separately, Please Refer to Pages 15-2 & 15-3		
<b>Pre-Trimmed with Remote-Resetting, Pressure Reducing Trim, US Model, Groove x Groove</b>		
4" Pre-Trimmed DV-5 Deluge Valve with Remote-Resetting, Pressure Reducing Trim	<b>90-491-00-161</b>	\$12,075.00
6" Pre-Trimmed DV-5 Deluge Valve with Remote-Resetting, Pressure Reducing Trim	<b>90-691-00-161</b>	\$14,438.00
<b>Note:</b> For a Complete List of System Components, Please Refer to Pages:13-6 & 13-7 Control Valve is Sold Separately, Please Refer to Pages 15-2 & 15-3		

Section 8	Wet System Valves
Section 9	Water Motor Alarms
Section 10	Dry Pipe Valves
Section 11	Quick Opening Devices
Section 12	Air Maintenance Devices
Section 13	Deluge Valves & Accessories
Section 14	Preaction Systems
Section 15	General Purpose Valves

Refer to the latest technical data sheets for specific approvals, listings, design parameters, and available options on [www.tyco-fire.com](http://www.tyco-fire.com).

Section 8 Wet System Valves
Section 9 Water Motor Alarms
Section 10 Dry Pipe Valves
Section 11 Quick Opening Devices
Section 12 Air Maintenance Devices
<b>Section 13 Deluge Valves &amp; Accessories</b>
Section 14 Preaction Systems
Section 15 General Purpose Valves

Refer to the latest technical data sheets for specific approvals, listings, design parameters, and available options on [www.tyco-fire.com](http://www.tyco-fire.com).



**Full Praction Systems and Components**

The following tables will provide information on equipment, required or optional, needed to complete various system packages. Please see the applicable Technical data pages for more information.

**DV-5 Single Interlock, Wet Pilot Actuation, - 1 1/2" thru 8"**

Description	Part No.	List Price
<b>Required Equipment for Deluge Valve (Select One) *P/N for GRXGR shown. (See data sheets for other end configurations)</b>		
1 1/2" DV-5 Deluge Valve, Groove x Groove	52-477-1-919	\$2,058.00
2" DV-5 Deluge Valve, Groove x Groove	52-477-1-910	\$2,151.00
3" DV-5 Deluge Valve, Groove x Groove	52-477-1-912	\$2,338.00
4" DV-5 Deluge Valve, Groove x Groove	52-477-1-913	\$4,028.00
6" DV-5 Deluge Valve, Groove x Groove	52-477-1-915	\$4,911.00
8" DV-5 Deluge Valve, Groove x Groove	52-477-1-916	\$14,056.00
<b>Riser Check Valve (Select One) *For 1 1/2" DV-5, use 2" Riser Check</b>		
2" CV-1FR Riser Check Valve	59-590-1-020	\$618.50
3" CV-1FR Riser Check Valve	59-590-1-030	\$618.50
4" CV-1FR Riser Check Valve	59-590-1-040	\$618.50
6" CV-1FR Riser Check Valve	59-590-1-060	\$1,148.00
8" CV-1FR Riser Check Valve	59-590-1-080	\$2,077.00
<b>Coupling (Select One)</b>		
2 x 1 1/2" Figure 716 Reducing Coupling (for 1 1/2" DV-5)	7162015ES	See Section 18 for current list prices
2" Figure 772 Rigid Coupling	77220ASC	
3" Figure 772 Rigid Coupling	77230ASC	
4" Figure 772 Rigid Coupling	77240ASC	
6" Figure 772 Rigid Coupling	77260ASC	
8" Figure 772 Rigid Coupling	77280ASC	
<b>Single Interlock Wet Pilot Praction Trim (Select One) *Galvanized shown is standard</b>		
1 1/2" & 2" Galvanized	52-478-2-117	\$3,880.00
3" Galvanized	52-478-2-114	\$4,023.00
4", 6" and 8" Galvanized	52-478-2-111	\$4,302.00
<b>Automatic System Air Supply (Select One)</b>		
Model AMD-1 Air Maintenance Device (TFP 1221)	52-324-2-002	\$927.50
Model AMD-2 Air Maintenance Device (TFP 1231)	52-326-2-001	\$1,367.00
Model G16AC812 Supervisory Air Supply (TD126)	52-150-1-001	\$2,706.00
<b>Optional Equipment for S/I Praction System, Wet Pilot Release</b>		
600 psi Water Pressure Gauge	92-343-1-004	\$191.00
Model WMA-1 Water Motor Alarm	52-630-1-001	\$725.50
Model OSYSU - 2 Monitor Switch	2412	\$195.50
Model MC-1 Manual Control Station (Galv. Ends) (TFP 1382)	52-289-2-001	\$470.50

**Note**

Note: Heat Detectors, Alarm Bells, Trouble Horns, Spray Nozzles, or, Open Sprinklers are ordered separately.

**Technical Data Sheet - TFP1410**

Section 8  
Wet System Valves

Section 9  
Water Motor Alarms

Section 10  
Dry Pipe Valves

Section 11  
Quick Opening Devices

Section 12  
Air Maintenance Devices

Section 13  
Deluge Valves & Accessories

Section 14  
Praction Systems

Section 15  
General Purpose Valves

**Full Preaction Systems and Components**

The following tables will provide information on equipment, required or optional, needed to complete various system packages. Please see the applicable Technical data pages for more information.

**DV-5 Single Interlock, Dry Pilot Actuation, - 1 1/2" thru 8"**

Description	Part No.	List Price
<b>Required Equipment for Deluge Valve (Select One) *P/N for GRXGR shown. See data sheets for other end configurations</b>		
1 1/2" DV-5 Deluge Valve, Groove x Groove	52-477-1-919	\$2,058.00
2" DV-5 Deluge Valve, Groove x Groove	52-477-1-910	\$2,151.00
3" DV-5 Deluge Valve, Groove x Groove	52-477-1-912	\$2,338.00
4" DV-5 Deluge Valve, Groove x Groove	52-477-1-913	\$4,028.00
6" DV-5 Deluge Valve, Groove x Groove	52-477-1-915	\$4,911.00
8" DV-5 Deluge Valve, Groove x Groove	52-477-1-916	\$14,056.00
<b>Riser Check Valve (Select One) *For 1 1/2" DV-5, use 2" Riser Check</b>		
2" CV-1FR Riser Check Valve	59-590-1-020	\$618.50
3" CV-1FR Riser Check Valve	59-590-1-030	\$618.50
4" CV-1FR Riser Check Valve	59-590-1-040	\$618.50
6" CV-1FR Riser Check Valve	59-590-1-060	\$1,148.00
8" CV-1FR Riser Check Valve	59-590-1-080	\$2,077.00
<b>Coupling (Select One)</b>		
2" x 1 1/2" Inch Figure 716 Reducing Coupling (for 1 1/2" DV-5)	7162015ES	See Section 18 for current list prices
2" Figure 772 Rigid Coupling	77220ASC	
3" Figure 772 Rigid Coupling	77230ASC	
4" Figure 772 Rigid Coupling	77240ASC	
6" Figure 772 Rigid Coupling	77260ASC	
8" Figure 772 Rigid Coupling	77280ASC	
<b>Single Interlock Dry Pilot Preaction Trim (Select One) *Galvanized shown is standard</b>		
1 1/2" & 2" Galvanized	52-478-2-118	\$5,097.00
3" Galvanized	52-478-2-115	\$5,238.00
4", 6" and 8" Galvanized	52-478-2-112	\$5,518.00
<b>Automatic System Air Supply (Select One)</b>		
Model AMD-1 Air Maintenance Device (TFP 1221)	52-324-2-002	\$927.50
Model AMD-3 Nitrogen Air Maintenance Device (TFP 1241)	52-328-2-001	\$1,815.00
Model G16AC812 Supervisory Air Supply (TD126)	52-150-1-001	\$2,706.00
<b>Dry Pilot Line Air Supply (Select One) *Must be ordered separately from Automatic System Air Supply</b>		
Model AMD-1 Air Maintenance Device (TFP 1221)	52-324-2-002	\$927.50
Model AMD-2 Air Maintenance Device (TFP 1231)	52-326-2-001	\$1,367.00
Model AMD-3 Nitrogen Air Maintenance Device (TFP 1241)	52-328-2-001	\$1,815.00
<b>Optional Equipment for S/I Preaction System, Dry Pilot Release</b>		
600 psi Water Pressure Gauge	92-343-1-004	\$191.00
Model WMA-1 Water Motor Alarm	52-630-1-001	\$725.50
Model OSYSU - 2 Monitor Switch	2412	\$195.50
Model MC-1 Manual Control Station (Galv. Ends) (TFP 1382)	52-289-2-001	\$470.50
<b>Note</b>		
Note: Heat Detectors, Alarm Bells, Trouble Horns, Spray Nozzles, or, Open Sprinklers are ordered separately.		
<b>Technical Data Sheet - TFP1415</b>		

Refer to the latest technical data sheets for specific approvals, listings, design parameters, and available options on [www.tyco-fire.com](http://www.tyco-fire.com).

**Full Praction Systems and Components**

The following tables will provide information on equipment, required or optional, needed to complete various system packages. Please see the applicable Technical data pages for more information.

**DV-5 Single Interlock, Electric Actuation, - 1 1/2" thru 8"**

Description	Part No.	List Price
<b>Required Equipment for Deluge Valve (Select One) *P/N for GRXGR shown. See data sheets for other end configurations</b>		
1 1/2" DV-5 Deluge Valve, Groove x Groove	52-477-1-919	\$2,058.00
2" DV-5 Deluge Valve, Groove x Groove	52-477-1-910	\$2,151.00
3" DV-5 Deluge Valve, Groove x Groove	52-477-1-912	\$2,338.00
4" DV-5 Deluge Valve, Groove x Groove	52-477-1-913	\$4,028.00
6" DV-5 Deluge Valve, Groove x Groove	52-477-1-915	\$4,911.00
8" DV-5 Deluge Valve, Groove x Groove	52-477-1-916	\$14,056.00
<b>Riser Check Valve (Select One) *For 1 1/2" DV-5, use 2" Riser Check</b>		
2" CV-1FR Riser Check Valve	59-590-1-020	\$618.50
3" CV-1FR Riser Check Valve	59-590-1-030	\$618.50
4" CV-1FR Riser Check Valve	59-590-1-040	\$618.50
6" CV-1FR Riser Check Valve	59-590-1-060	\$1,148.00
8" CV-1FR Riser Check Valve	59-590-1-080	\$2,077.00
<b>Coupling (Select One)</b>		
2" x 1 1/2" Figure 716 Reducing Coupling (for 1 1/2" DV-5)	7162015ES	See Section 18 for current list prices
2" Figure 772 Rigid Coupling	77220ASC	
3" Figure 772 Rigid Coupling	77230ASC	
4" Figure 772 Rigid Coupling	77240ASC	
6" Figure 772 Rigid Coupling	77260ASC	
8" Figure 772 Rigid Coupling	77280ASC	
<b>Single Interlock Electric Actuation Praction Trim (Select One) *Galvanized shown is standard</b>		
1 1/2" & 2" Galvanized	52-478-2-119	\$3,976.00
3" Galvanized	52-478-2-116	\$4,115.00
4", 6" and 8" Galvanized	52-478-2-113	\$4,396.00
<b>Automatic System Air Supply (Select One)</b>		
Model AMD-1 Air Maintenance Device (TFP 1221)	52-324-2-002	\$927.50
Model AMD-3 Nitrogen Air Maintenance Device (TFP 1241)	52-328-2-001	\$1,815.00
Model G16AC812 Supervisory Air Supply (TD126)	52-150-1-001	\$2,706.00
<b>Solenoid Valve 24VDC (Select One)</b>		
175 psi 24VDC Solenoid Valve	52-287-1-024	\$1,147.00
250 psi 24VDC Solenoid Valve	52-287-1-124	POA
<b>Optional Equipment for S/I Praction System, Electric Actuation</b>		
600 psi Water Pressure Gauge	92-343-1-004	\$191.00
Model WMA-1 Water Motor Alarm	52-630-1-001	\$725.50
Model OSYSU - 2 Monitor Switch	2412	\$195.50
Model PFC 4410 Fire Control Panel	20135	\$2,635.00
Batteries - Two Batteries are required for Stand-by power for each Control Panel. Refer to TD sheets.		
Model BT - 80 Stand by Batteries, (2 Required, Price shown is Each)	2656	\$79.50
Model BT - 120 Stand by Batteries, (2 Required, Price shown is Each)	20128	\$141.00
<b>Note</b>		
Note: Heat Detectors, Manual Control Stations, Alarm Bells, Trouble Horns, Spray Nozzles, or, Open Sprinklers are ordered separately.		
<b>Technical Data Sheet - TFP1420</b>		

Section 8  
Wet System Valves

Section 9  
Water Motor Alarms

Section 10  
Dry Pipe Valves

Section 11  
Quick Opening Devices

Section 12  
Air Maintenance Devices

Section 13  
Deluge Valves & Accessories

Section 14  
Praction Systems

Section 15  
General Purpose Valves

Refer to the latest technical data sheets for specific approvals, listings, design parameters, and available options on [www.tyco-fire.com](http://www.tyco-fire.com).

**Full Praction Systems and Components**

**The following tables will provide information on equipment, required or optional, needed to complete various system packages. Please see the applicable Technical data pages for more information.**

**DV-5 Double Interlock, Electric/Pneumatic Actuation, - 1 1/2" thru 8"**

<i>Description</i>	<i>Part No.</i>	<i>List Price</i>
<b>Deluge Valve (Select One) *P/N for GRXGR shown. See data sheets for other end configurations</b>		
1-1/2 Inch DV-5 Deluge Valve, Groove x Groove	<b>52-477-1-919</b>	\$2,058.00
2 Inch DV-5 Deluge Valve, Groove x Groove	<b>52-477-1-910</b>	\$2,151.00
3 Inch DV-5 Deluge Valve, Groove x Groove	<b>52-477-1-912</b>	\$2,338.00
4 Inch DV-5 Deluge Valve, Groove x Groove	<b>52-477-1-913</b>	\$4,028.00
6 Inch DV-5 Deluge Valve, Groove x Groove	<b>52-477-1-915</b>	\$4,911.00
8" DV-5 Deluge Valve, Groove x Groove	<b>52-477-1-916</b>	\$14,056.00
<b>Riser Check Valve (Select One) *For 1 1/2" DV-5, use 2" Riser Check</b>		
2" CV-1FR Riser Check Valve	<b>59-590-1-020</b>	\$618.50
3" CV-1FR Riser Check Valve	<b>59-590-1-030</b>	\$618.50
4" CV-1FR Riser Check Valve	<b>59-590-1-040</b>	\$618.50
6" CV-1FR Riser Check Valve	<b>59-590-1-060</b>	\$1,148.00
8" CV-1FR Riser Check Valve	<b>59-590-1-080</b>	\$2,077.00
<b>Coupling (Select One)</b>		
2" x 1 1/2" Figure 716 Reducing Coupling (for 1 1/2" DV-5)	<b>7162015ES</b>	See Section 18 for current list prices
2" Figure 772 Rigid Coupling	<b>77220ASC</b>	
3" Figure 772 Rigid Coupling	<b>77230ASC</b>	
4" Figure 772 Rigid Coupling	<b>77240ASC</b>	
6" Figure 772 Rigid Coupling	<b>77260ASC</b>	
8" Figure 772 Rigid Coupling	<b>77280ASC</b>	
<b>Double Interlock E/P Praction Trim (Select One) *Galvanized shown is standard</b>		
1 1/2" & 2" Galvanized	<b>52-478-2-127</b>	\$5,160.00
3" Galvanized	<b>52-478-2-124</b>	\$5,404.00
4" , 6" and 8" Galvanized	<b>52-478-2-121</b>	\$5,645.00
<b>Automatic System Air Supply (Select One)</b>		
Model AMD-1 Air Maintenance Device (TFP 1221)	<b>52-324-2-002</b>	\$927.50
Model AMD-2 Air Maintenance Device (TFP 1231)	<b>52-326-2-001</b>	\$1,367.00
Model AMD-3 Nitrogen Air Maintenance Device (TFP 1241)	<b>52-328-2-001</b>	\$1,815.00
<b>Solenoid Valve 24VDC (Select One)</b>		
175 psi 24VDC Solenoid Valve	<b>52-287-1-024</b>	\$1,147.00
250 psi 24VDC Solenoid Valve	<b>52-287-1-124</b>	POA
<b>Optional Equipment for D/I Praction System, Electric/Pneumatic Release</b>		
600 psi Water Pressure Gauge	<b>92-343-1-004</b>	\$191.00
Model WMA-1 Water Motor Alarm	<b>52-630-1-001</b>	\$725.50
Model OSYSU - 2 Monitor Switch	<b>2412</b>	\$195.50
Model PFC 4410 Fire Control Panel	<b>20135</b>	\$2,635.00
Batteries - Two Batteries are required for Stand-by power for each Control Panel. Refer to TD sheets.		
Model BT - 80 Stand by Batteries, (2 Required, Price shown is Each)	<b>2656</b>	\$79.50
Model BT - 120 Stand by Batteries, (2 Required, Price shown is Each)	<b>20128</b>	\$141.00
<b>Note</b>		
Note: Heat Detectors, Manual Control Stations, Alarm Bells, Trouble Horns, Spray Nozzles, or, Open Sprinklers are ordered separately.		
<b>Technical Data Sheet - TFP1460</b>		

Refer to the latest technical data sheets for specific approvals, listings, design parameters, and available options on [www.tyco-fire.com](http://www.tyco-fire.com).

**Full Praction Systems and Components**

The following tables will provide information on equipment, required or optional, needed to complete various system packages. Please see the applicable Technical data pages for more information.

**DV-5 Double Interlock, Electric/Electric Actuation, - 1 1/2" thru 8"**

Description	Part No.	List Price
<b>Required Equipment for Deluge Valve (Select One) *P/N for GRXGR shown. See data sheets for other end configurations</b>		
1-1/2 Inch DV-5 Deluge Valve, Groove x Groove	52-477-1-919	\$2,058.00
2 Inch DV-5 Deluge Valve, Groove x Groove	52-477-1-910	\$2,151.00
3 Inch DV-5 Deluge Valve, Groove x Groove	52-477-1-912	\$2,338.00
4 Inch DV-5 Deluge Valve, Groove x Groove	52-477-1-913	\$4,028.00
6 Inch DV-5 Deluge Valve, Groove x Groove	52-477-1-915	\$4,911.00
8" DV-5 Deluge Valve, Groove x Groove	52-477-1-916	\$14,056.00
<b>Riser Check Valve (Select One) *For 1 1/2" DV-5, use 2" Riser Check</b>		
2" CV-1FR Riser Check Valve	59-590-1-020	\$618.50
3" CV-1FR Riser Check Valve	59-590-1-030	\$618.50
4" CV-1FR Riser Check Valve	59-590-1-040	\$618.50
6" CV-1FR Riser Check Valve	59-590-1-060	\$1,148.00
8" CV-1FR Riser Check Valve	59-590-1-080	\$2,077.00
<b>Coupling (Select One)</b>		
2" x 1 1/2" Figure 716 Reducing Coupling (for 1 1/2" DV-5)	7162015ES	See Section 18 for current list prices
2" Figure 772 Rigid Coupling	77220ASC	
3" Figure 772 Rigid Coupling	77230ASC	
4" Figure 772 Rigid Coupling	77240ASC	
6" Figure 772 Rigid Coupling	77260ASC	
8" Figure 772 Rigid Coupling	77280ASC	
<b>Double Interlock E/E Praction Trim (Select One) *Galvanized shown is standard</b>		
1 1/2" & 2" Galvanized	52-478-2-128	\$3,740.00
3" Galvanized	52-478-2-125	\$3,833.00
4", 6" and 8" Galvanized	52-478-2-122	\$4,115.00
<b>Automatic System Air Supply (Select One)</b>		
Model AMD-1 Air Maintenance Device (TFP 1221)	52-324-2-002	\$927.50
Model AMD-3 Nitrogen Air Maintenance Device (TFP 1241)	52-328-2-001	\$1,815.00
<b>Solenoid Valve 24VDC (Select One)</b>		
175 psi 24VDC Solenoid Valve	52-287-1-024	\$1,147.00
250 psi 24VDC Solenoid Valve	52-287-1-124	POA
<b>Optional Equipment for D/I Praction System, Electric/Electric Release</b>		
600 psi Water Pressure Gauge	92-343-1-004	\$191.00
Model WMA-1 Water Motor Alarm	52-630-1-001	\$725.50
Model OSYSU - 2 Monitor Switch	2412	\$195.50
Model PFC 4410 Fire Control Panel	20135	\$2,635.00
Batteries - Two Batteries are required for Stand-by power for each Control Panel. Refer to TD sheets.		
Model BT - 80 Stand by Batteries, (2 Required, Price shown is Each)	2656	\$79.50
Model BT - 120 Stand by Batteries, (2 Required, Price shown is Each)	20128	\$141.00
<b>Note</b>		
Note: Heat Detectors, Manual Control Stations, Alarm Bells, Trouble Horns, Spray Nozzles, or, Open Sprinklers are ordered separately.		
<b>Technical Data Sheet - TFP1465</b>		

Section 8  
Wet System Valves

Section 9  
Water Motor Alarms

Section 10  
Dry Pipe Valves

Section 11  
Quick Opening Devices

Section 12  
Air Maintenance Devices

Section 13  
Deluge Valves & Accessories

Section 14  
Praction Systems

Section 15  
General Purpose Valves

Refer to the latest technical data sheets for specific approvals, listings, design parameters, and available options on www.tyco-fire.com.

Section 8 Wet System Valves
Section 9 Water Motor Alarms
Section 10 Dry Pipe Valves
Section 11 Quick Opening Devices
Section 12 Air Maintenance Devices
Section 13 Deluge Valves & Accessories
Section 14 Preaction Systems
Section 15 General Purpose Valves

<b>Optional Equipment for Single Interlock, Preaction Systems, Supervised</b>		
<i>Description</i>	<i>Part No.</i>	<i>List Price (Each)</i>
Low Pressure Alarm Switch for Dry Pilot Actuation (PS402A)	<b>2573</b>	\$236.00
Pressure Alarm Switch Model PS10 - 2A	<b>2571</b>	\$229.50
Model WMA-1 Water Motor Alarm	<b>52-630-1-001</b>	\$725.50
Model OSYSU - 2 Monitor Switch	<b>2412</b>	\$195.50
Model PFC 4410 Fire Control Panel	<b>20135</b>	\$2,635.00
<b>Batteries - Two Batteries are required for Stand-by power for each Control Panel. Consult TD Sheets for ratings</b>		
<i>Description</i>	<i>Part No.</i>	<i>List Price (Each)</i>
Model BT-80 (8 amp) Stand by Batteries, (2 REQ'D)	<b>2656</b>	\$79.50
Model BT-120 (12 amp) Stand by Batteries, (2 REQ'D)	<b>20128</b>	\$141.00
<b>Notes</b>		
Heat Detectors, Manual Control Stations, Alarm Bells, Trouble Horns, Compressors, Spray Nozzles, or, Open Sprinklers are ordered separately.		

Refer to the latest technical data sheets for specific approvals, listings, design parameters, and available options on [www.tyco-fire.com](http://www.tyco-fire.com).



<b>Praction Trim for Model DV-5</b>		
<i>Description</i>	<i>Part No.</i>	<i>List Price</i>
<b>Praction Trim Kits for Model DV-5 Deluge Valves - 1-1/2" and 2"</b>		
1 1/2" and 2" Supervised Single Interlock Praction Trim with Wet Pilot Actuation (Galvanized) (Standard Order)	<b>52-478-2-117</b>	\$3,880.00
1 1/2" and 2" Supervised Single Interlock Praction Trim with Wet Pilot Actuation (Black)	<b>52-478-1-117</b>	\$3,880.00
1 1/2" and 2" Supervised Single Interlock Praction Trim with Wet Pilot Actuation (Brass)	–	POA
1 1/2" and 2" Supervised Single Interlock Praction Trim with Dry Pilot Actuation (Galvanized) (Standard Order)	<b>52-478-2-118</b>	\$5,097.00
1 1/2" and 2" Supervised Single Interlock Praction Trim with Dry Pilot Actuation (Black)	<b>52-478-1-118</b>	\$5,097.00
1 1/2" and 2" Supervised Single Interlock Praction Trim with Dry Pilot Actuation (Brass)	–	POA
1 1/2" and 2" Supervised Single Interlock Praction Trim with Electric Actuation (Galvanized) (Standard Order) (Solenoid Valve Not Included)	<b>52-478-2-119</b>	\$3,976.00
1 1/2" and 2" Supervised Single Interlock Praction Trim with Electric Actuation (Black) (Solenoid Valve Not Included)	<b>52-478-1-119</b>	\$3,976.00
1 1/2" and 2" Supervised Single Interlock Praction Trim with Electric Actuation (Brass) (Solenoid Valve Not Included)	–	POA
1 1/2" and 2" Double Interlock Praction Trim with Electric/Pneumatic Release (Galvanized) (Standard Order)	<b>52-478-2-127</b>	\$5,160.00
1 1/2" and 2" Double Interlock Praction Trim with Electric/Pneumatic Release (Black)	<b>52-478-1-127</b>	\$6,265.00
1 1/2" and 2" Double Interlock Praction Trim with Electric/Pneumatic Release (Brass)	–	POA
1 1/2" and 2" Double Interlock Praction Trim with Electric/Electric Release (Galvanized) (Standard Order)	<b>52-478-2-128</b>	\$3,740.00
1 1/2" and 2" Double Interlock Praction Trim with Electric/Electric Release (Black)	<b>52-478-1-128</b>	\$3,740.00
1 1/2" and 2" Double Interlock Praction Trim with Electric/Electric Release (Brass)	–	POA
<b>Trim Kits for Model DV-5 Deluge Valves - 3"</b>		
3" Supervised Single Interlock Praction Trim with Wet Pilot Actuation (Galvanized) (Standard Order)	<b>52-478-2-114</b>	\$4,023.00
3" Supervised Single Interlock Praction Trim with Wet Pilot Actuation (Black)	<b>52-478-1-114</b>	\$4,023.00
3" Supervised Single Interlock Praction Trim with Wet Pilot Actuation (Brass)	–	POA
3" Supervised Single Interlock Praction Trim with Dry Pilot Actuation (Galvanized) (Standard Order)	<b>52-478-2-115</b>	\$5,238.00
3" Supervised Single Interlock Praction Trim with Dry Pilot Actuation (Black)	<b>52-478-1-115</b>	\$5,238.00
3" Supervised Single Interlock Praction Trim with Dry Pilot Actuation (Brass)	–	POA
3" Supervised Single Interlock Praction Trim with Electric Actuation (Galvanized) (Standard Order) (Solenoid Valve Not Included)	<b>52-478-2-116</b>	\$4,115.00
3" Supervised Single Interlock Praction Trim with Electric Actuation (Black) (Solenoid Valve Not Included)	<b>52-478-1-116</b>	\$4,115.00
3" Supervised Single Interlock Praction Trim with Electric Actuation (Brass) (Solenoid Valve Not Included)	–	POA
3" Double Interlock Praction Trim with Electric/Pneumatic Release (Galvanized) (Standard Order)	<b>52-478-2-124</b>	\$5,404.00
3" Double Interlock Praction Trim with Electric/Pneumatic Release (Black)	<b>52-478-1-124</b>	\$6,734.00
3" Double Interlock Praction Trim with Electric/Pneumatic Release (Brass)	–	POA
3" Double Interlock Praction Trim with Electric/Electric Release (Galvanized) (Standard Order)	<b>52-478-2-125</b>	\$3,833.00
3" Double Interlock Praction Trim with Electric/Electric Release (Black)	<b>52-478-1-125</b>	\$3,833.00
3" Double Interlock Praction Trim with Electric/Electric Release (Brass)	–	POA

Section 8  
Wet System Valves

Section 9  
Water Motor Alarms

Section 10  
Dry Pipe Valves

Section 11  
Quick Opening Devices

Section 12  
Air Maintenance Devices

Section 13  
Deluge Valves & Accessories

Section 14  
Praction Systems

Section 15  
General Purpose Valves

Refer to the latest technical data sheets for specific approvals, listings, design parameters, and available options on [www.tyco-fire.com](http://www.tyco-fire.com).



Section 8  
Wet System Valves

Section 9  
Water Motor Alarms

Section 10  
Dry Pipe Valves

Section 11  
Quick Opening Devices

Section 12  
Air Maintenance Devices

Section 13  
Deluge Valves & Accessories

Section 14  
Praction Systems

Section 15  
General Purpose Valves

<b>Praction Trim for Model DV-5</b>		
<b>Trim Kits for Model DV-5 Deluge Valves - 4", 6" and 8"</b>		
<i>Description</i>	<i>Part No.</i>	<i>List Price</i>
4", 6" and 8" Supervised Single Interlock Praction Trim with Wet Pilot Actuation (Galvanized) (Standard Order)	<b>52-478-2-111</b>	\$4,302.00
4", 6" and 8" Supervised Single Interlock Praction Trim with Wet Pilot Actuation (Black)	<b>52-478-1-111</b>	\$4,302.00
4" and 6" Supervised Single Interlock Praction Trim with Wet Pilot Actuation (Brass)	–	POA
4", 6" and 8" Supervised Single Interlock Praction Trim with Dry Pilot Actuation (Galvanized) (Standard Order)	<b>52-478-2-112</b>	\$5,518.00
4", 6" and 8" Supervised Single Interlock Praction Trim with Dry Pilot Actuation (Black)	<b>52-478-1-112</b>	\$5,518.00
4", 6" and 8" Supervised Single Interlock Praction Trim with Dry Pilot Actuation (Brass)	–	POA
4", 6" and 8" Supervised Single Interlock Praction Trim with Electric Actuation (Galvanized) (Standard Order) (Solenoid Valve Not Included)	<b>52-478-2-113</b>	\$4,396.00
4", 6" and 8" Supervised Single Interlock Praction Trim with Electric Actuation (Black) (Solenoid Valve Not Included)	<b>52-478-1-113</b>	\$4,396.00
4", 6" and 8" Supervised Single Interlock Praction Trim with Electric Actuation (Brass) (Solenoid Valve Not Included)	–	POA
4", 6" and 8" Double Interlock Praction Trim with Electric/Pneumatic Release (Galvanized) (Standard Order)	<b>52-478-2-121</b>	\$5,645.00
4", 6" and 8" Double Interlock Praction Trim with Electric/Pneumatic Release (Black)	<b>52-478-1-121</b>	\$7,015.00
4", 6" and 8" Double Interlock Praction Trim with Electric/Pneumatic Release (Brass)	–	POA
4", 6" and 8" Double Interlock Praction Trim with Electric/Electric Release (Galvanized) (Standard Order)	<b>52-478-2-122</b>	\$4,115.00
4", 6" and 8" Double Interlock Praction Trim with Electric/Electric Release (Black)	<b>52-478-1-122</b>	\$4,115.00
4", 6" and 8" Double Interlock Praction Trim with Electric/Electric Release (Brass)	–	POA
<b>Technical Data Sheets: Single Interlock: Wet Pilot - TFP1410, Dry Pilot - TFP1415, Electric Actuation - TFP1420 Double Interlock: Electric/Pneumatic - TFP1460, Electric/Electric - TFP1465</b>		

Refer to the latest technical data sheets for specific approvals, listings, design parameters, and available options on [www.tyco-fire.com](http://www.tyco-fire.com).

**CV-1F Grooved Check Valve**

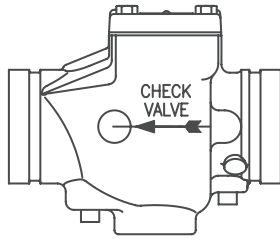

<i>Part Numbers</i> <b>CV-1F</b>	<i>Description</i>	<i>Price</i>
<b>59-590-0-020</b>	2" Grooved Check Valve	Refer to Section 18 for Valve pricing.
<b>59-590-0-025</b>	2½" Grooved Check Valve	
<b>59-590-0-030</b>	3" Grooved Check Valve	
<b>59-590-0-040</b>	4" Grooved Check Valve	
<b>59-590-0-050</b>	5" Grooved Check Valve	
<b>59-590-0-060</b>	6" Grooved Check Valve	
<b>59-590-0-080</b>	8" Grooved Check Valve	
<b>59-590-0-100</b>	10" Grooved Check Valve	
<b>Replacement Parts for Model CV-1F Check Valve, 2½" Grooved End</b>		
<b>59-592-1-025</b>	<b>Maintenance Kit</b> Includes: Cap, Gasket, Bolts, Warning Label and "Out of Service" Tag	\$749.50
<b>59025EPDME</b>	Clapper Gasket	\$131.00
<b>Replacement Parts for Model CV-1F Check Valve, 3" Grooved End</b>		
<b>59-592-1-030</b>	<b>Maintenance Kit</b> Includes: Cap, Gasket, Bolts, Warning Label and "Out of Service" Tag	\$749.50
<b>59030EPDME</b>	Clapper Gasket	\$131.00
<b>Replacement Parts for Model CV-1F Check Valve, 4" Grooved End</b>		
<b>59-592-1-040</b>	<b>Maintenance Kit</b> Includes: Cap, Gasket, Bolts, Warning Label and "Out of Service" Tag	\$749.50
<b>59040EPDME</b>	Clapper Gasket	\$131.00
<b>Replacement Parts for Model CV-1F Check Valve, 5" Grooved End</b>		
<b>59-592-1-050</b>	<b>Maintenance Kit</b> Includes: Cap, Gasket, Bolts, Warning Label and "Out of Service" Tag	\$749.50
<b>59050EPDME</b>	Clapper Gasket	\$131.00
<b>Replacement Parts for Model CV-1F Check Valve, 6" Grooved End</b>		
<b>59-592-1-060</b>	<b>Maintenance Kit</b> Includes: Cap, Gasket, Bolts, Warning Label and "Out of Service" Tag	\$749.50
<b>59060EPDME</b>	Clapper Gasket	\$131.00
<b>Replacement Parts for Model CV-1F Check Valve, 8" Grooved End</b>		
<b>59-592-1-080</b>	<b>Maintenance Kit</b> Includes: Cap, Gasket, Bolts, Warning Label and "Out of Service" Tag	\$749.50
<b>59080EPDME</b>	Clapper Gasket	\$131.00
<b>Replacement Parts for Model CV-1F Check Valve, 10" Grooved End</b>		
<b>59-592-1-100</b>	<b>Maintenance Kit</b> Includes: Cap, Gasket, Bolts, Warning Label and "Out of Service" Tag	\$749.50
<b>59100EPDME</b>	Clapper Gasket	\$131.00
<b>Technical Data Sheet: Check Valve TFP1550 and Maintenance Kit TFP1555</b>		

Section 8  
Wet System Valves

Section 9  
Water Motor Alarms

Section 10  
Dry Pipe Valves

Section 11  
Quick Opening Devices

Section 12  
Air Maintenance Devices

Section 13  
Deluge Valves & Accessories

Section 14  
Preaction Systems

Section 15  
General Purpose Valves

Section 8  
Wet System Valves

Section 9  
Water Motor Alarms

Section 10  
Dry Pipe Valves

Section 11  
Quick Opening Devices

Section 12  
Air Maintenance Devices

Section 13  
Deluge Valves & Accessories

Section 14  
Preaction Systems

Section 15  
General Purpose Valves

**Model BFV-N Butterfly Valves - Wafer Style w/ Supervisory Switches - 250 psi  
UL and C-UL Listed and FM Approved**

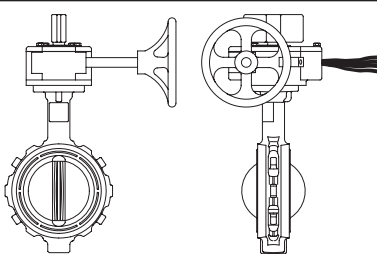
	<i>Nom. Size</i>	<i>Part Numbers</i>	<i>List Price</i>
	2" Model BFV-N Butterfly Valve - Wafer Style	<b>59-801-1-020N</b>	\$759.00
	2½" Model BFV-N Butterfly Valve - Wafer Style	<b>59-801-1-025N</b>	\$800.00
	3" Model BFV-N Butterfly Valve - Wafer Style	<b>59-801-1-030N</b>	\$896.00
	4" Model BFV-N Butterfly Valve - Wafer Style	<b>59-801-1-040N</b>	\$927.00
	5" Model BFV-N Butterfly Valve - Wafer Style	<b>59-801-1-050N</b>	\$1,200.00
	6" Model BFV-N Butterfly Valve - Wafer Style	<b>59-801-1-060N</b>	\$1,200.00
	8" Model BFV-N Butterfly Valve - Wafer Style	<b>59-801-1-080N</b>	\$1,777.00
	10" Model BFV-N Butterfly Valve - Wafer Style	<b>59-801-1-100N</b>	\$2,428.00
	12" Model BFV-N Butterfly Valve - Wafer Style	<b>59-801-1-120N</b>	\$2,950.00
<b>Technical Data Sheet - TFP1515</b>			

**Model BFV-N Butterfly Valves - Lug Style w/ Supervisory Switches - 250 psi  
UL and C-UL Listed and FM Approved**

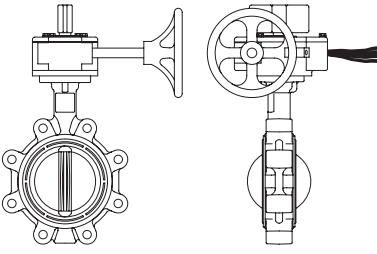
	<i>Nom. Size</i>	<i>Part Numbers</i>	<i>List Price</i>
	2" Model BFV-N Butterfly Valve - Lug Style	<b>59-802-1-020N</b>	\$873.00
	2½" Model BFV-N Butterfly Valve - Lug Style	<b>59-802-1-025N</b>	\$921.00
	3" Model BFV-N Butterfly Valve - Lug Style	<b>59-802-1-030N</b>	\$946.00
	4" Model BFV-N Butterfly Valve - Lug Style	<b>59-802-1-040N</b>	\$1,015.00
	5" Model BFV-N Butterfly Valve - Lug Style	<b>59-802-1-050N</b>	\$1,326.00
	6" Model BFV-N Butterfly Valve - Lug Style	<b>59-802-1-060N</b>	\$1,326.00
	8" Model BFV-N Butterfly Valve - Lug Style	<b>59-802-1-080N</b>	\$1,917.00
	10" Model BFV-N Butterfly Valve - Lug Style	<b>59-802-1-100N</b>	\$2,476.00
	12" Model BFV-N Butterfly Valve - Lug Style	<b>59-802-1-120N</b>	\$3,955.00
<b>Technical Data Sheet - TFP1520</b>			

**Additional Wafer and Lug Lengths, w/PIVA**

<b>Wafer 12" thru 36" Length, w/PIVA</b>		<b>Lug 12" thru 36" Length, w/PIVA</b>	
<i>Nom. Size</i>	<i>List Price</i>	<i>Nom. Size</i>	<i>List Price</i>
2"	\$2,467.00	2"	\$2,564.00
2½"	\$2,501.00	2½"	\$2,607.00
3"	\$2,598.00	3"	\$2,651.00
4"	\$2,630.00	4"	\$2,810.00
5"	\$2,897.00	5"	\$3,109.00
6"	\$2,897.00	6"	\$3,109.00
8"	\$3,686.00	8"	\$3,929.00
10"	\$4,269.00	10"	\$4,558.00
12"	\$5,094.00	12"	\$5,584.00

**Notes**

Wafer and Lug Lengths add . per foot increase in length after 36"

Refer to the latest technical data sheets for specific approvals, listings, design parameters, and available options on [www.tyco-fire.com](http://www.tyco-fire.com).

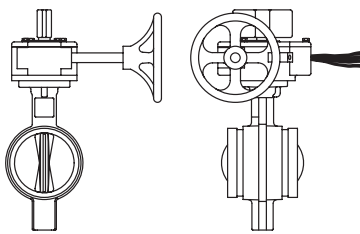
<b>Model BFV-N Butterfly Valves - G x G, Gear Operated w/ Tamper Switches-300psi UL and C-UL Listed and FM Approved</b>			
	<i>Nom. Size</i>	<i>Part Numbers</i>	<i>List Price</i>
	2" Butterfly Valve	Refer to page C-2 for 2" Valve Part Number and Pricing Information	
	2 1/2" Model BFV-N Butterfly Valve	<b>59-300-F-025N</b>	Refer to Section 18 for Valve pricing.
	3" Model BFV-N Butterfly Valve	<b>59-300-F-030N</b>	
	4" Model BFV-N Butterfly Valve	<b>59-300-F-040N</b>	
	5" Model BFV-N Butterfly Valve	<b>59-300-F-050N</b>	
	6" Model BFV-N Butterfly Valve	<b>59-300-F-060N</b>	
	8" Model BFV-N Butterfly Valve	<b>59-300-F-080N</b>	
	10" Model BFV-N Butterfly Valve	<b>59-300-F-100N</b>	
<b>Technical Data Sheet - TFP1510</b>			

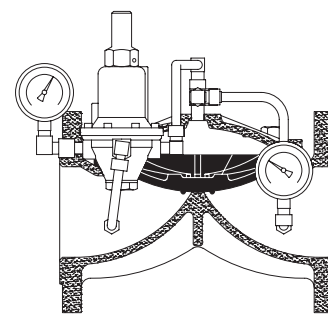
<b>Model PRV-1 Pressure Regulating Valve 2" thru 8", 250 psi, Pilot Operated</b>			
	<i>Nom. Size</i>	<i>UL &amp; FM Part Numbers</i>	<i>List Price</i>
	2" Model PRV-1 Pressure Regulating Valve, Groove x Groove	<b>52-570-8-920</b>	\$1,713.00
	2" Model PRV-1 Pressure Regulating Valve, Thread x Thread	<b>52-570-8-060</b>	\$1,713.00
	3" Model PRV-1 Pressure Regulating Valve, Groove x Groove	<b>52-570-8-922</b>	\$2,649.00
	4" Model PRV-1 Pressure Regulating Valve, Groove x Groove	<b>52-570-8-923</b>	\$3,189.00
	4" Model PRV-1 Pressure Regulating Valve, Flange x Flange	<b>52-570-8-023</b>	\$3,189.00
	6" Model PRV-1 Pressure Regulating Valve, Groove x Groove	<b>52-570-8-925</b>	\$5,816.00
	6" Model PRV-1 Pressure Regulating Valve, Flange x Flange	<b>52-570-8-025</b>	\$5,816.00
	8" Model PRV-1 Pressure Regulating Valve, Flange x Flange	<b>52-570-8-026</b>	\$8,883.00
<b>Technical Data Sheet - TFP1580</b>			

Refer to the latest technical data sheets for specific approvals, listings, design parameters, and available options on [www.tyco-fire.com](http://www.tyco-fire.com).

**Model RV-1 Pressure Relief Valves  
2" thru 8", 250 psi, Pilot Operated, Globe and Angle Body Styles**

**Model RV-1 Pressure Relief Valve - Globe Body Style**

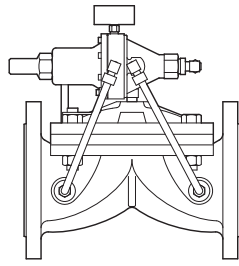

<i>Description</i>	<i>UL / FM Part Numbers</i>	<i>List Price</i>
2" Flange x Flange, ANSI	<b>52-572-8-010</b>	\$2,730.00
3" Flange x Flange, ANSI	<b>52-572-8-022</b>	\$2,966.00
4" Flange x Flange, ANSI	<b>52-572-8-023</b>	\$3,833.00
6" Flange x Flange, ANSI	<b>52-572-8-025</b>	\$6,563.00
8" Flange x Flange, ANSI	<b>52-572-8-026</b>	\$9,975.00

**Model RV-1 Pressure Relief Valve - Angle Body Style**

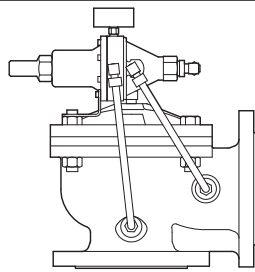

<i>Description</i>	<i>UL / FM Part Numbers</i>	<i>List Price</i>
2" Thread x Thread, NPT	<b>52-573-8-060</b>	\$2,730.00
3" Flange x Flange, ANSI	<b>52-573-8-022</b>	\$2,966.00
4" Flange x Flange, ANSI	<b>52-573-8-023</b>	\$3,833.00
6" Flange x Flange, ANSI	<b>52-573-8-025</b>	\$6,563.00
8" Flange x Flange, ANSI	<b>52-573-8-026</b>	\$9,975.00

**Replacement Parts for Model RV-1 Pressure Relief Valves**

<i>Description</i>	<i>Part Numbers</i>	<i>List Price</i>
2" Model RV-1 Pressure Relief Valve Replacement Diaphragm (Fits Either Body Style)	<b>92-570-2-011</b>	\$509.50
3" Model RV-1 Pressure Relief Valve Replacement Diaphragm (Fits Either Body Style)	<b>92-570-2-012</b>	\$522.00
4" Model RV-1 Pressure Relief Valve Replacement Diaphragm (Fits Either Body Style)	<b>92-570-2-013</b>	\$1,398.00
6" Model RV-1 Pressure Relief Valve Replacement Diaphragm (Fits Either Body Style)	<b>92-570-2-014</b>	\$2,033.00
8" Model RV-1 Pressure Relief Valve Replacement Diaphragm (Fits Either Body Style)	<b>92-570-2-015</b>	\$4,130.00
Pilot Valve	<b>92-570-3-001</b>	\$1,565.00
Water Pressure Gauge	<b>92-572-2-200</b>	\$126.50
2", 3" and 4" Valve Strainer	<b>92-570-2-202</b>	\$171.50
6" and 8" Valve Strainer	<b>92-570-2-209</b>	\$214.50
2" Tubing and Fitting Kit, Globe Body	<b>92-572-3-001</b>	\$599.00
2" Tubing and Fitting Kit, Angle Body	<b>92-573-3-001</b>	\$599.00
3" Tubing and Fitting Kit, Globe Body	<b>92-572-3-002</b>	\$599.00
3" Tubing and Fitting Kit, Angle Body	<b>92-573-3-002</b>	\$599.00
4" Tubing and Fitting Kit, Globe Body	<b>92-572-3-003</b>	\$599.00
4" Tubing and Fitting Kit, Angle Body	<b>92-573-3-003</b>	\$599.00
6" Tubing and Fitting Kit, Globe Body	<b>92-572-3-004</b>	\$704.00
6" Tubing and Fitting Kit, Angle Body	<b>92-573-3-004</b>	\$704.00
8" Tubing and Fitting Kit, Globe Body	<b>92-572-3-005</b>	\$704.00
8" Tubing and Fitting Kit, Angle Body	<b>92-573-3-005</b>	\$704.00

**Technical Data Sheet - TFP1585**

Refer to the latest technical data sheets for specific approvals, listings, design parameters, and available options on [www.tyco-fire.com](http://www.tyco-fire.com).

**Valve System Accessories**

Description	Part No.	List Price
1/2" Pressure Relief Valve	2283	\$184.00
1/4" Pressure Relief Valve	92-343-1-125	\$143.00
1/4" Air Pressure Regulator (Norgen)	12525000	\$264.00
1/4" Air Restrictor	2370	\$27.00
3/8" Furnas Pressure Switch	2433	\$471.00

**F350 Sectional Control Accessories**

Description	Part No.	List Price
1 1/4" Drain x 1/2" Test Orifice	54-350-1-001	\$648.00

Technical Data Sheet - TFP1650

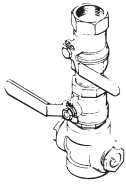

**F1321 Sight Flow Connection**

Description	Part No.	List Price
1" F1321 Sight Flow Connection	52-069-1-006	\$126.50
2" F1321 Sight Flow Connection	52-069-1-009	\$333.00

Technical Data Sheet - TFP1635

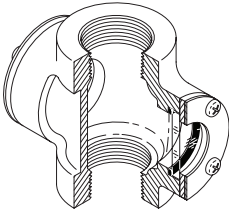

**Ball Drip Valves**

Description	Part Number	List Price
1/2" Ball Drip w/street ell	2282	\$50.00
1/2" AD-2 Automatic Drain Ball Drip (for FDC & Low Point Drains)	52-789-1-004	\$76.25
1/2" AD-1 Plunger Type, Automatic Drain Ball Drip	52-793-2-004	\$155.00

Technical Data Sheet - AD-1 TFP1630 & AD-2 TFP1632

**Fill or Drip Cups**

Description	Part No.	List Price
1/2" N.P.T.	1295	\$83.75
3/4" N.P.T.	129501	\$83.75

**DD-1 (Drum Drip) Wiliag Drain**

Description	Part No.	List Price
DD-1 (Drum Drip) Wiliag Drain Includes: Condensation Barrel, 2- 1" Shutoff Valves & 1-1" Plug	52-380-1-001	\$192.50

Refer to the latest technical data sheets for specific approvals, listings, design parameters, and available options on [www.tyco-fire.com](http://www.tyco-fire.com).

Section 16  
Specialty Items

Section 18  
Grooved Product

Section 19  
CPVC Pipe & Fittings

Section 20  
Miscellaneous

Section 21  
Electrical

Section C  
Valves & Hose Equipment

Section D  
Backflow

Section F  
Pipe & Accessories

Section H  
Hangers

Section J  
Lubricants

Section K  
Misc.

Section 16  
Specialty Items

Section 18  
Grooved Product

Section 19  
CPVC Pipe & Fittings

Section 20  
Miscellaneous

Section 21  
Electrical

Section C  
Valves & Hose Equipment

Section D  
Backflow

Section F  
Pipe & Accessories

Section H  
Hangers

Section J  
Lubricants

Section K  
Misc.

**Manual Control Stations**

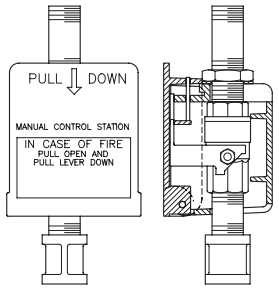
		<i>Description</i>	<i>Part No.</i>	<i>List Price</i>
		Hydraulic Break-Rod Station, Model MC-1	<b>52-289-1-001</b>	\$470.50
		Replacement Rod 1/8" x 1-3/16" Polystyrene	<b>92-289-1-008</b>	\$15.00
<b>Technical Data Sheet - TFP1382</b>				

**Model G16AC812 Automatic Supervisory Air Supply**

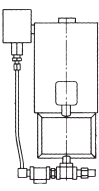
		<i>Description</i>	<i>Part No.</i>	<i>List Price</i>
		Automatic Air Supply Model G16AC812	<b>52-150-1-001</b>	\$2,706.00
		Universal Bracket Riser Mount	<b>52-150-1-000</b>	\$318.50
<b>Technical Data Sheet - TFP1620</b>				

**Water and Air Gauges**

<i>Description</i>	<i>Part No.</i>	<i>List Price</i>
Water Pressure Gauge.	<b>92-343-1-005</b>	\$83.75
Air Pressure Gauge. 250 psi	<b>92-343-1-012</b>	\$83.75
Air/Water Pressure Gauge. 0 - 300 psi, 1/4" NPT	<b>92-343-1-013</b>	\$83.75

**Fusible Links/Fire Door Links, Type C**

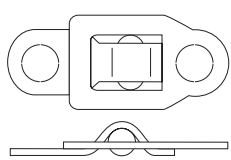
		<i>Description</i>	<i>Part Number</i>	<i>List Price</i>
		Fusible Link, Figure 1247B 135°F (57°C), Type C	<b>56-125-9-135</b>	\$20.75
		Fusible Link, Figure 1247B 165°F (74°C), Type C	<b>56-125-9-165</b>	\$20.75
		Fusible Link, Figure 1247B 212°F (100°C), Type C	<b>56-125-9-212</b>	\$20.75
		Fusible Link, Figure 1247B 286°F (141°C), Type C	<b>56-125-9-286</b>	\$20.75
		Fusible Link, Figure 1247B 360°F (182°C), Type C	<b>56-125-9-360</b>	\$22.50
		Fusible Link, Figure 1247B 500°F (260°C), Type C	<b>56-125-9-500</b>	\$28.75
<b>Technical Data Sheet - TFP1610</b>				

Refer to the latest technical data sheets for specific approvals, listings, design parameters, and available options on [www.tyco-fire.com](http://www.tyco-fire.com).

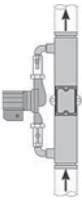

<b>Zonecheck - Flow Switch Tester</b>			
	<i>Description</i>	<i>Part Number</i>	<i>List Price</i>
 <p><b>Note: For Left Hand Option, Please add a "-L" to the part number and add \$175 to the price. (example 4320-L)</b></p>	2" Zonecheck Flow Tester	<b>4320</b>	\$3,936.00
	2 1/2" Zonecheck Flow Tester	<b>4325</b>	\$3,936.00
	3" Zonecheck Flow Tester	<b>4330</b>	\$3,936.00
	4" Zonecheck Flow Tester	<b>4340</b>	\$3,936.00
	6" Zonecheck Flow Tester	<b>4360</b>	\$3,936.00
	Retrofit Zonecheck Assembly	<b>43RT</b>	\$3,472.00
	2" Zonecheck Flow Tester - ULC	<b>43200</b>	\$3,861.00
	2 1/2" Zonecheck Flow Tester - ULC	<b>43250</b>	\$3,861.00
	3" Zonecheck Flow Tester - ULC	<b>43300</b>	\$3,861.00
	4" Zonecheck Flow Tester - ULC	<b>43400</b>	\$3,861.00
	Retrofit Zonecheck Assembly - ULC	<b>43RTC</b>	\$3,406.00
	Zonecheck Keyswitch	<b>43100 ZCK-1</b>	\$236.00

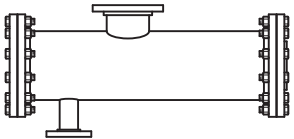
<b>Model "A" Strainers and SS Baskets</b>			
	<i>Description</i>	<i>Part No.</i>	<i>List Price</i>
	3" Model "A" Strainer, Fig. 1260, Galvanized Finish and SS Baskets	<b>52-270-1-011</b>	\$9,618.00
	4" Model "A" Strainer, Fig. 1260, Galvanized Finish and SS Baskets	<b>52-270-1-013</b>	\$11,679.00
	6" Model "A" Strainer, Fig. 1260, Galvanized Finish and SS Baskets	<b>52-270-1-015</b>	\$19,271.00
	8" Model "A" Strainer, Fig. 1260, Galvanized Finish and SS Baskets	<b>52-270-1-016</b>	\$25,245.00
	10" Model "A" Strainer, Fig. 1260, Galvanized Finish and SS Baskets	<b>52-270-1-017</b>	\$39,073.00
<b>Replacement Parts for Model "A" Strainers</b>			
	8" End Flange 19" Model A, Strainer	<b>92-270-1-024</b>	\$5,094.00
	End Flange 10" Model A, Strainer	<b>92-270-1-046</b>	\$5,779.00
	Stainless Steel Basket 4"	<b>92-270-1-213</b>	\$6,443.00
	Stainless Steel Basket 6"	<b>92-270-1-215</b>	\$7,332.00
	Stainless Steel Basket 8"	<b>92-270-1-216</b>	\$12,819.00
	Stainless Steel Basket 10"	<b>92-270-1-217</b>	\$14,706.00
<b>Notes</b>			
All Model "A" Strainers are special order and require 10 weeks for delivery.			
<b>Technical Data Sheet - TFP1640</b>			

Refer to the latest technical data sheets for specific approvals, listings, design parameters, and available options on [www.tyco-fire.com](http://www.tyco-fire.com).

Section 16  
Specialty Items

Section 18  
Grooved Product

Section 19  
CPVC Pipe & Fittings

Section 20  
Miscellaneous

Section 21  
Electrical

Section C  
Valves & Hose Equipment

Section D  
Backflow

Section F  
Pipe & Accessories

Section H  
Hangers

Section J  
Lubricants

Section K  
Misc.

Section 16  
Specialty Items

Section 18  
Grooved Product

Section 19  
CPVC Pipe & Fittings

Section 20  
Miscellaneous

Section 21  
Electrical

Section C  
Valves & Hose Equipment

Section D  
Backflow

Section F  
Pipe & Accessories

Section H  
Hangers

Section J  
Lubricants

Section K  
Misc.

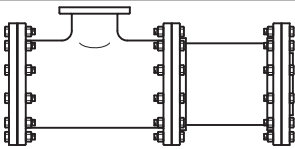
<b>Model "B-1" Strainer, Painted Finish and SS Baskets</b>			
	<i>Description</i>	<i>Part No.</i>	<i>List Price</i>
	3" No. 1	<b>52-370-1-010</b>	\$8,618.00
	3" No. 2*, No. 3	<b>52-370-1-011</b>	POA
	3" Galvanized Finish and SS Baskets	-	POA
	4" No. 6*	<b>52-370-1-013</b>	\$12,144.00
	4" No. 5, No. 7	<b>52-370-1-014</b>	POA
	4" Galvanized Finish and SS Baskets	-	POA
	6" No. 9*	<b>52-370-1-015</b>	\$18,483.00
	6" No. 8	<b>52-370-1-019</b>	POA
	6" Galvanized Finish and SS Baskets	-	POA
	8" No. 14, No. 15, No. 19*, No. 20	<b>52-370-1-016</b>	\$32,806.00
8" No. 16	<b>52-370-1-017</b>	POA	
8" Galvanized Finish and SS Baskets	-	POA	
<b>Replacement Parts for Model B-1, Strainer</b>			
	3" Basket Assembly	<b>92-370-1-102</b>	\$2,021.00
	4" Basket Assembly	<b>92-370-1-104</b>	\$2,126.00
	6" Basket Assembly	<b>92-370-1-106</b>	\$2,284.00
	8" Basket Assembly	<b>92-370-1-108</b>	\$3,365.00
	8" End Flange Plain	<b>92-370-1-007</b>	POA
	8" End Flange Galvanized	<b>92-370-2-007</b>	POA
	6" End Flange Plain	<b>92-370-1-005</b>	POA
	6" End Flange Galvanized	<b>92-370-2-005</b>	POA
	3" Ring Gasket	<b>92-370-1-015</b>	POA
	4" Ring Gasket	<b>92-370-1-016</b>	POA
	6" & 8" Ring Gasket	<b>92-370-1-018</b>	POA
<b>Notes</b>			
* These Model "B1" Strainers are available from stock. All other "B1" Strainers require 5 weeks for delivery.			
1 – Model "B1" Galvanized Strainers are special order and required 10 weeks for delivery.			
2 – All extra heavy strainers both Model "A" and "B" are discontinued.			
3 – All strainers with monel or bronze baskets are special order and require 8 weeks for delivery P.O.A.			
<b>Technical Data Sheet - TFP1642</b>			

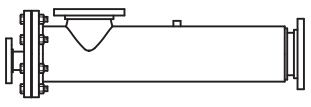
<b>Model "C" Strainer, Heavy Duty, Welded Body</b>			
	<i>Description</i>	<i>Part No.</i>	<i>List Price</i>
	6 x 6" Model "C" Strainer, Galvanized Finish and Stainless Steel Baskets	<b>52-390-1-013</b>	\$19,924.00
	8" x 8" Model "C" Strainer, Galvanized Finish and Stainless Steel Baskets	<b>52-390-1-016</b>	\$26,051.00
	8" with two 6" Outlets, Model "C" Strainer, Galvanized Finish and Stainless Steel Baskets	<b>52-390-1-017</b>	\$31,236.00
	10" with two 8" Outlets, Model "C" Strainer, Galvanized Finish and Stainless Steel Baskets	<b>52-390-1-019</b>	\$40,337.00
<b>Technical Data Sheet - TFP1644</b>			

Refer to the latest technical data sheets for specific approvals, listings, design parameters, and available options on [www.tyco-fire.com](http://www.tyco-fire.com).

<b>Sprinkler Identification Signs</b>			
	<i>Description</i>	<i>Part No.</i>	<i>List Price</i>
	Sign A - General Purpose, 9" x 7"	<b>2300A</b>	\$12.25
	Sign B "Alarm Test", 6" x 2"	<b>2304A</b>	\$7.00
	Sign B "Auxiliary Drain", 6" x 2"	<b>2307</b>	\$7.00
	Sign B "Control Valve", 6" x 2"	<b>2310</b>	\$7.00
	Sign B "Inspectors Test", 6" x 2"	<b>2313</b>	\$7.00
	Sign B "Main Control", 6" x 2"	<b>2319</b>	\$7.00
	Sign B "Main Drain", 6" x 2"	<b>2320</b>	\$7.00
	Sign B "Air Control", 6" x 2"	<b>2328</b>	\$7.00
	Sign B "Air Line", 6" x 2"	<b>2302</b>	\$7.00
	Sign B "Anti-Freeze System", 6" x 2"	<b>2306</b>	\$7.00
	Sign B "Drain", 6" x 2"	<b>2311</b>	\$7.00
	Sign B "Drain Valve", 6" x 2"	<b>2327</b>	\$7.00
	Sign D "When Bell Rings", 9" x 7"	<b>2329</b>	\$15.50
	Sign E - Hydraulic Calculations, 5" x 7"	<b>2317</b>	\$11.25
<b>Technical Data Sheet - TFP1615</b>			

<b>Restriction Unions</b>		
<i>Description</i>	<i>Part No.</i>	<i>List Price</i>
1/2" Brass Union 1/8" Orifice.	<b>52-363-1-001</b>	\$101.00
1/2" Brass Union 3/32" Orifice.	<b>52-363-1-002</b>	\$101.00
3/4" Brass Union K=5.6.	<b>52-363-1-005</b>	\$129.50
1" Brass Union K=5.6.	<b>52-363-1-006</b>	\$143.50
1" M.I. Union K=5.6.	<b>52-363-1-106</b>	\$82.50
1" Brass Union K=8.0.	<b>52-363-1-256</b>	\$143.50

Refer to the latest technical data sheets for specific approvals, listings, design parameters, and available options on [www.tyco-fire.com](http://www.tyco-fire.com).

Section 16  
Specialty Items

Section 18  
Grooved Product

Section 19  
CPVC Pipe & Fittings

Section 20  
Miscellaneous

Section 21  
Electrical

Section C  
Valves & Hose Equipment

Section D  
Backflow

Section F  
Pipe & Accessories

Section H  
Hangers

Section J  
Lubricants

Section K  
Misc.

Section 16 Specialty Items
Section 18 Grooved Product
Section 19 CPVC Pipe & Fittings
Section 20 Miscellaneous
Section 21 Electrical
Section C Valves & Hose Equipment
Section D Backflow
Section F Pipe & Accessories
Section H Hangers
Section J Lubricants
Section K Misc.

Refer to the latest technical data sheets for specific approvals, listings, design parameters, and available options on [www.tyco-fire.com](http://www.tyco-fire.com).

**G-FIRE #577 Global and Domestic – Rigid Coupling  
with Grade “A” EPDM Fire Protection Pre-Lubricated Gasket**

Nom. Size	Painted			Galvanized		
	Global Part Number	Domestic Part Number	List Price	Global Part Number	Domestic Part Number	List Price
1"	–	57701ASC	\$49.50	–	57701AGSC	\$62.50
1 1/4"	57713ACP	57713ASC	\$38.00	57713AGCP	57713AGSC	\$45.50
1 1/2"	57715ACP	57715ASC	\$39.00	57715AGCP	57715AGSC	\$46.50
2"	57720ACP	57720ASC	\$43.50	57720AGCP	57720AGSC	\$51.50
2 1/2"	57725ACP	57725ASC	\$50.50	57725AGCP	57725AGSC	\$60.50
3"	57730ACP	57730ASC	\$57.50	57730AGCP	57730AGSC	\$71.00
4"	57740ACP	57740ASC	\$81.00	57740AGCP	57740AGSC	\$97.50
5"	57750ACP	57750ASC	\$108.00	57750AGCP	57750AGSC	\$136.00
6"	57760ACP	57760ASC	\$129.50	57760AGCP	57760AGSC	\$157.00
8"	57780ACP	57780ASC	\$216.50	57780AGCP	57780AGSC	\$263.00
10"	57710ACP	57710ASC	\$452.50	57710AGCP	57710AGSC	\$604.50
12"	57712ACP	57712ASC	\$506.00	57712AGCP	57712AGSC	\$677.50

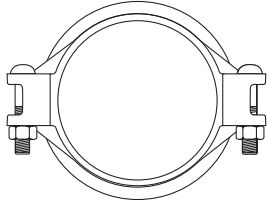

Technical Data Sheet: TFP1854

**G-FIRE #577 Global – Rigid Tri-Seal Coupling  
with Grade “E” EPDM Tri-Seal Gasket Recommended for  
Dry Pipe Systems and Freezer Applications – Use Silicone Lubricant**

Nom. Size	Painted		Galvanized	
	Global Part Number	List Price	Global Part Number	List Price
1"	57701E3S	\$70.00	57701E3GS	\$83.50
1 1/4"	57713E3S	\$38.00	57713E3GS	\$45.50
1 1/2"	57715E3S	\$39.00	57715E3GS	\$46.50
2"	57720E3S	\$43.50	57720E3GS	\$51.50
2 1/2"	57725E3S	\$50.50	57725E3GS	\$60.50
3"	57730E3S	\$57.50	57730E3GS	\$71.00
4"	57740E3S	\$81.00	57740E3GS	\$97.50
5"	57750E3S	\$186.00	57750E3GS	\$214.00
6"	57760E3S	\$205.00	57760E3GS	\$240.00
8"	57780E3S	\$332.00	57780E3GS	\$385.00
10"	57710E3S	\$544.00	57710E3GS	\$692.00
12"	57712E3S	\$619.00	57712E3GS	\$796.50

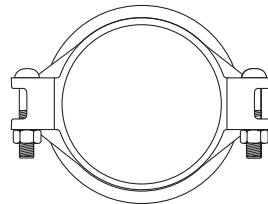

Technical Data Sheet: TFP1854

**#705 Global and Domestic – Flexible Coupling  
with Grade “A” EPDM Fire Protection Pre-Lubricated Gasket**

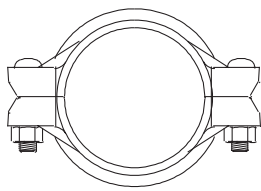
	Nom. Size	Painted			Galvanized		
		Global Part Number	Domestic Part Number	List Price	Global Part Number	Domestic Part Number	List Price
		1 1/4"	70513ACP	70513ASC	\$37.50	70513AGCP	70513AGSC
1 1/2"	70515ACP	70515ASC	\$45.50	70515AGCP	70515AGSC	\$56.50	
2"	70520ACP	70520ASC	\$55.50	70520AGCP	70520AGSC	\$73.50	
2 1/2"	70525ACP	70525ASC	\$64.50	70525AGCP	70525AGSC	\$90.50	
3"	70530ACP	70530ASC	\$72.00	70530AGCP	70530AGSC	\$100.00	
4"	70540ACP	70540ASC	\$103.50	70540AGCP	70540AGSC	\$146.50	
5"	–	70550ESC	\$157.00	–	70550EGSC	\$226.00	
6"	70560ACP	70560ASC	\$186.00	70560AGCP	70560AGSC	\$267.00	
8"	70580ACP	70580ASC	\$302.50	70580AGCP	70580AGSC	\$450.00	
10"	–	70510ESC	\$493.00	–	70510EGSC	\$706.50	
12"	–	70512ESC	\$560.50	–	70512EGSC	\$802.50	

Orders for items in shaded areas **cannot** be cancelled or returned.

**Technical Data Sheet: TFP1820**

**#705 Domestic – Flexible Tri-Seal Coupling  
with Grade “E” EPDM Tri-Seal Gasket Recommended for  
Dry Pipe Systems and Freezer Applications – Use Silicone Lubricant**

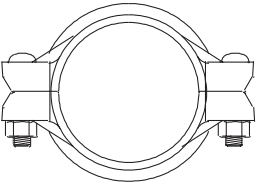
	Nom. Size	Painted		Galvanized	
		Domestic Part Number	List Price	Domestic Part Number	List Price
		1 1/4"	70513E3S	\$61.00	70513E3GS
1 1/2"	70515E3S	\$67.00	70515E3GS	\$80.00	
2"	70520E3S	\$68.50	70520E3GS	\$82.00	
2 1/2"	70525E3S	\$82.00	70525E3GS	\$96.50	
3"	70530E3S	\$87.00	70530E3GS	\$104.50	
4"	70540E3S	\$124.00	70540E3GS	\$151.50	
5"	70550E3S	\$211.50	70550E3GS	\$252.00	
6"	70560E3S	\$233.50	70560E3GS	\$283.50	
8"	70580E3S	\$388.50	70580E3GS	\$466.00	
10"	70510E3S	\$585.00	70510E3GS	\$786.50	
12"	70512E3S	\$687.00	70512E3GS	\$904.50	

Orders for items in shaded areas **cannot** be cancelled or returned.

**Technical Data Sheet: TFP1820**

**#707 Domestic Heavy-Duty Flexible Coupling  
with Grade "E" EPDM Gasket**

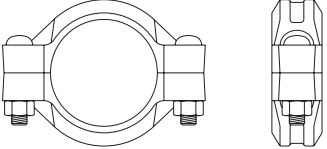
	Nominal Size	Painted		Galvanized	
		Domestic Part Number	List Price	Domestic Part Number	List Price
		1"	70701ES	\$36.00	70701EGS
1 1/2"	70715ES	\$51.50	70715EGS	\$67.50	
2"	70720ES	\$55.50	70720EGS	\$73.50	
2 1/2"	70725ES	\$64.50	70725EGS	\$90.50	
3"	70730ES	\$72.00	70730EGS	\$100.00	
4"	70740ES	\$103.50	70740EGS	\$146.50	
5"	70750ES	\$157.00	70750EGS	\$226.00	
6"	70760ES	\$186.00	70760EGS	\$267.00	
8"	70780ES	\$302.50	70780EGS	\$450.00	
10"	70710ES	\$493.00	70710EGS	\$706.50	
12"	70712ES	\$560.50	70712EGS	\$802.50	

Technical Data Sheet: TFP1840

**#707 Domestic Heavy-Duty Flexible Coupling  
with Grade "E" EPDM Tri-Seal Gasket Recommended for  
Dry Pipe Systems and Freezer Applications – Use Silicone Lubricant**

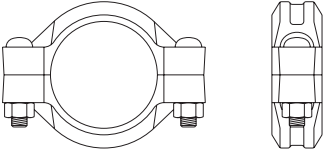
	Nominal Size	Painted		Galvanized	
		Domestic Part Number	List Price	Domestic Part Number	List Price
		1 1/2"	70715E3S	\$73.00	70715E3GS
2"	70720E3S	\$76.00	70720E3GS	\$95.50	
2 1/2"	70725E3S	\$93.00	70725E3GS	\$118.50	
3"	70730E3S	\$96.00	70730E3GS	\$125.00	
4"	70740E3S	\$139.00	70740E3GS	\$182.00	
5"	70750E3S	\$243.50	70750E3GS	\$316.00	
6"	70760E3S	\$269.50	70760E3GS	\$354.00	
8"	70780E3S	\$364.00	70780E3GS	\$499.50	
10"	70710E3S	\$585.00	70710E3GS	\$786.50	
12"	70712E3S	\$687.00	70712E3GS	\$904.50	

Orders for items in shaded areas **cannot** be cancelled or returned.

Technical Data Sheet: TFP1840



**#716 Domestic – Reducing Coupling  
with Grade “E” EPDM Non-Lubricated Gasket**

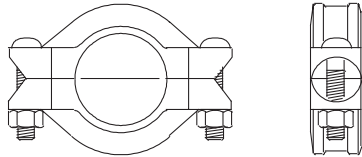

Nom. Size	Painted		Galvanized	
	Domestic Part Number	List Price	Domestic Part Number	List Price
2" x 1 1/2"	7162015ES	\$74.00	7162015EGS	\$89.00
2 1/2" x 2"	7162520ES	\$95.50	7162520EGS	\$119.50
3" x 2"	7163020ES	\$109.00	7163020EGS	\$137.50
3" x 2 1/2"	7163025ES	\$94.00	7163025EGS	\$119.50
4" x 2"	7164020ES	\$172.00	7164020EGS	\$217.00
4" x 2 1/2"	7164025ES	\$154.50	7164025EGS	\$203.00
4" x 3"	7164030ES	\$144.50	7164030EGS	\$187.00
5" x 4"	7165040ES	\$194.00	7165040EGS	\$255.00
6" x 4"	7166040ES	\$293.00	7166040EGS	\$369.00
6" x 5"	7166050ES	\$256.50	7166050EGS	\$332.50
8" x 6"	7168060ES	\$438.00	7168060EGS	\$554.50

Technical Data Sheet: TFP1830

**#716 Reducing Coupling Plate**

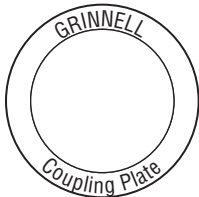

Nom. Size	Plate Part No.	List Price
2" x 1 1/2"	7162015W	POA
2 1/2" x 2"	7162520W	POA
3" x 2"	7163020W	POA
3" x 2 1/2"	7163025W	POA
4" x 2"	7164020W	POA
4" x 2 1/2"	7164025W	POA
4" x 3"	7164030W	POA
5" x 4"	7165040W	POA
6" x 4"	7166040W	POA
6" x 5"	7166050W	POA
8" x 6"	7168060W	POA

Orders for items in shaded areas **cannot** be cancelled or returned.

**Replacement Gaskets, Grade “E” EPDM Gasket for #716 Reducing Coupling**

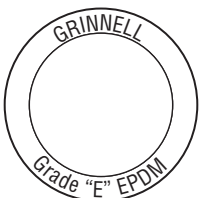

Nom. Size	Plate Part No.	List Price
2" x 1 1/2"	2015EPDME	\$27.50
2 1/2" x 2"	2520EPDME	\$36.00
3" x 2"	3020EPDME	\$41.00
3" x 2 1/2"	3025EPDME	\$41.00
4" x 2"	4020EPDME	\$47.50
4" x 2 1/2"	4025EPDME	\$48.00
4" x 3"	4030EPDME	\$50.00
5" x 4"	5040EPDME	\$58.00
6" x 4"	6040EPDME	\$66.00
6" x 5"	6050EPDME	\$72.00
8" x 6"	8060EPDME	\$80.00

Orders for items in shaded areas **cannot** be cancelled or returned.

See latest catalog or technical data sheets for specific approvals, listings, and design parameters.  
POA = Price on availability. Prices subject to change without notice.

**#71 Domestic – Grooved Flange Adapter  
with Grade “E” EPDM Non-Lubricated Gasket**

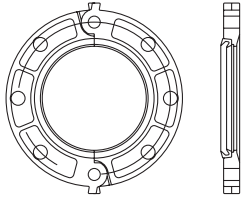
	Nom. Size	Painted		Galvanized	
		Domestic Part Number	List Price	Domestic Part Number	List Price
			2"	7120S	\$163.00
	2½"	7125S	\$190.00	7125GS	\$226.00
	3"	7130S	\$214.00	7130GS	\$256.50
	4"	7140S	\$278.50	7140GS	\$339.50
	5"	7150S	\$334.50	7150GS	\$407.50
	6"	7160S	\$364.50	7160GS	\$444.00
	8"	7180S	\$458.00	7180GS	\$573.00
	10"	7110S	\$881.00	7110GS	\$1,119.50
	12"	7112S	\$1,152.50	7112GS	\$1,481.00

Orders for items in shaded areas **cannot** be cancelled or returned.

Technical Data Sheet: TFP1880

**#71 Flange Adapter – Metal Washer**

	Nom. Size	Washer Part No.	List Price
	2"	7120FWC	\$76.50
	2½"	7125FWC	\$81.00
	3"	7130FWC	\$94.50
	4"	7140FWC	\$109.50
	5"	7150FWC	\$133.50
	6"	7160FWC	\$152.00
	8"	7180FWC	\$192.50
	10"	7110FWC	\$266.50
	12"	7112FWC	\$389.50

Orders for items in shaded areas **cannot** be cancelled or returned.

**#71 Flange Adapter – Gaskets or Nut, Bolt, & Gasket Kit**

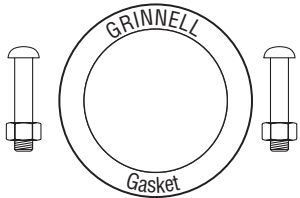
	Nom. Size	Gaskets		Nut, Bolt and Gasket Kit	
		Part Number	List Price	Part Number	List Price
	2"	7120EPDME	\$24.00	50240	POA
	2½"	7125EPDME	\$28.00	50241	POA
	3"	7130EPDME	\$30.50	50242	POA
	4"	7140EPDME	\$39.50	50243	POA
	5"	7150EPDME	\$47.50	50248	POA
	6"	7160EPDME	\$53.50	50244	POA
	8"	7180EPDME	\$72.00	50245	POA
	10"	7110EPDME	\$91.50	50246	POA
	12"	7112EPDME	\$106.50	50247	POA

Orders for items in shaded areas **cannot** be cancelled or returned.

**#702 Global – Outlet Coupling Grade “E” Gasket, Female Threaded End, Painted\***

Nominal Size	Coupling		Gasket Only	
	Global Part Number	List Price	Part Number	List Price
1½" x ½"	7021505FES	\$97.50	7021505EPDME	\$46.50
1½" x ¾"	7021575FES	\$97.50	7021575EPDME	\$46.50
1½" x 1"	7021501FES	\$97.50	7021501EPDME	\$46.50
2" x ½"	7022005FES	\$100.00	7022005EPDME	\$47.00
2" x ¾"	7022075FES	\$100.00	7022075EPDME	\$47.00
2" x 1"	7022001FES	\$100.00	7022001EPDME	\$47.00
2½" x ½"	7022505FES	\$153.50	7022505EPDME	\$96.50
2½" x ¾"	7022575FES	\$153.50	7022575EPDME	\$96.50
2½" x 1"	7022501FES	\$153.50	7022501EPDME	\$96.50
3" x ¾"	7023075FES	\$148.00	7023075EPDME	\$78.50
3" x 1"	7023001FES	\$195.50	7023001EPDME	\$111.50
4" x ¾"	7024075FES	\$217.00	7024075EPDME	\$111.50
4" x 1"	7024001FES	\$217.00	7024001EPDME	\$111.50
4" x 1½"	7024015FES	\$308.00	7024015EPDME	\$174.00
6" x 1"	7026001FES	\$435.00	7026001EPDME	\$227.00
6" x 1½"	7026015FES	\$435.00	7026015EPDME	\$227.00

Orders for items in shaded areas **cannot** be cancelled or returned.  
\* Galvanized available upon request.

**#702 Global – Outlet Coupling Grade “E” Gasket, Male Threaded End, Painted\***

Nominal Size	Coupling		Gasket Only	
	Global Part Number	List Price	Part Number	List Price
2" x 1"	7022001MES	\$99.50	7022001EPDME	\$47.00
2½" x 1¼"	7022513MES	\$173.00	7022513EPDME	\$108.50
2½" x 1½"	7022515MES	\$195.50	7022515EPDME	\$108.50
3" x 1"	7023001MES	\$195.50	7023001EPDME	\$111.50
3" x 1½"	7023015MES	\$224.00	7023015EPDME	\$111.50
4" x 1½"	7024015MES	\$307.50	7024015EPDME	\$174.00
4" x 2"	7024020MES	\$307.50	7024020EPDME	\$174.00
6" x 1½"	7026015MES	\$435.00	7026015EPDME	\$227.00
6" x 2"	7026020MES	\$435.00	7026020EPDME	\$227.00

Orders for items in shaded areas **cannot** be cancelled or returned.  
\* Galvanized available upon request.

**#702 Global – Outlet Coupling Grade “E” Gasket, Grooved End, Painted\***

Nominal Size	Coupling		Gasket Only	
	Global Part Number	List Price	Part Number	List Price
2" x 1"	7022001GRVES	\$99.50	7022001EPDME	\$47.00
2½" x 1¼"	7022513GRVES	\$173.00	7022513EPDME	\$108.50
2½" x 1½"	7022515GRVES	\$195.50	7022515EPDME	\$108.50
3" x 1"	7023001GRVES	\$195.50	7023001EPDME	\$111.50
3" x 1½"	7023015GRVES	\$224.00	7023015EPDME	\$111.50
4" x 1½"	7024015GRVES	\$307.50	7024015EPDME	\$174.00
4" x 2"	7024020GRVES	\$307.50	7024020EPDME	\$174.00
6" x 1½"	7026015GRVES	\$435.00	7026015EPDME	\$227.00
6" x 2"	7026020GRVES	\$435.00	7026020EPDME	\$227.00

Orders for items in shaded areas **cannot** be cancelled or returned.  
\* Galvanized available upon request.

See latest catalog or technical data sheets for specific approvals, listings, and design parameters.  
POA = Price on availability. Prices subject to change without notice.

**Replacement Gaskets**

Nominal Size	Grade "A" Pre-Lube Fire Protection Gasket (for #577, #705, )		Tri-Seal Grade "E" EPDM Gasket (for #577, #705)		Grade "E" EPDM Gasket (for #71)	
1"	01EPDMAC	\$26.00	01EPDME3	\$50.00	—	—
1 1/4"	13EPDMAC	\$34.50	13EPDME3	\$47.50	—	—
1 1/2"	15EPDMAC	\$37.50	15EPDME3	\$52.00	—	—
2"	20EPDMAC	\$40.00	20EPDME3	\$57.00	7120EPDME	\$24.00
2 1/2"	25EPDMAC	\$43.50	25EPDME3	\$59.00	7125EPDME	\$28.00
3"	30EPDMAC	\$50.00	30EPDME3	\$70.00	7130EPDME	\$30.50
4"	40EPDMAC	\$66.50	40EPDME3	\$93.50	7140EPDME	\$39.50
5"	50EPDMAC	\$67.00	50EPDME3	\$134.00	7150EPDME	\$47.50
6"	60EPDMAC	\$74.00	60EPDME3	\$171.50	7160EPDME	\$53.50
8"	80EPDMAC	\$106.00	80EPDME3	\$188.00	7180EPDME	\$72.00
10"	10EPDMAC	\$112.50	10EPDME3	\$216.00	7110EPDME	\$91.50
12"	12EPDMAC	\$131.00	12EPDME3	\$257.00	7112EPDME	\$106.50

Orders for items in shaded areas **cannot** be cancelled or returned.

**Technical Data Sheet: TFP1895**

**Coupling Nut and Bolt Kit**

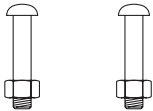
	Nominal Size	Qty/Kit	Part No.	List Price
	3/8" x 2 1/4"	2	NB37225	\$13.00
	1/2" x 3"	2	NB50300	\$13.50
	5/8" x 3 1/4"	2	NB62325	\$16.50
	5/8" x 4 3/4"	2	NB62475	\$27.50
	3/4" x 4 3/4"	2	NB75475	\$25.50
	7/8" x 6 1/2"	2	NB87650	\$43.00
	1" x 5 1/2"	3	NB10550	\$43.00
	1" x 6 1/2"	2	NB10650	\$45.50
	1 1/8" x 5 3/4"	4	NB12575	\$58.50

Orders for items in shaded areas **cannot** be cancelled or returned.

All standard couplings can be provided with stainless steel nuts and bolts upon request.

**GRINNELL Gasket Lubricant**

Size	Part Number	List Price
1 Quart	32005	\$31.50
<b>GRINNELL Silicone Gasket Lubricant</b>		
Recommended for use with Tri-Seal Gaskets. Dow Corning #DC No. 7. *		
Size	Part Number	List Price
5.30 oz. Tube	32037	\$103.80
8 lb. Can	32038	\$1,885.00

Orders for items in shaded areas **cannot** be cancelled or returned.

Silicone gasket lubricant is for use with Dry Pipe & Freezing Applications.

**Pipe Tape Chrome Plated with GRINNELL Logo**

Size	Part Number	List Price
1 Roll	PT1000	\$54.00

\* Dow Corning is a trademark of Dow Corning Corporation.

See latest catalog or technical data sheets for specific approvals, listings, and design parameters.

POA = Price on availability. Prices subject to change without notice.

Section 16  
Specialty Items

Section 18  
Grooved Products

Section 19  
CPVC Pipe & Fittings

Section 20  
Miscellaneous

Section 21  
Electrical

Section C  
Valves & Hose Equipment

Section D  
Backflow

Section F  
Pipe & Accessories

Section H  
Hangers

Section J  
Lubricants

Section K  
Misc.

**G-FIRE #510S Global and Domestic – Fire Protection Short Pattern Grooved 90° Elbow**

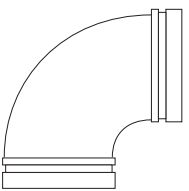
	Nom. Size	Painted			Galvanized		
		Global Part Number	Domestic Part Number	List Price	Global Part Number	Domestic Part Number	List Price
		2"	510S20P	510S20S	\$33.50	510S20GP	510S20GS
2 1/2"	510S25P	510S25S	\$44.50	510S25GP	510S25GS	\$60.50	
3"	510S30P	510S30S	\$59.00	510S30GP	510S30GS	\$78.50	
4"	510S40P	510S40S	\$84.50	510S40GP	510S40GS	\$117.50	
6"	510S60P	510S60S	\$235.00	510S60GP	510S60GS	\$323.50	
8"	510S80P	510S80S	\$459.50	510S80GP	510S80GS	\$655.00	

All elbows are cast fittings.

Technical Data Sheet: TFP1810

**G-FIRE #519S Global and Domestic – Fire Protection Short Pattern Grooved Tee**

	Nom. Size	Painted			Galvanized		
		Global Part Number	Domestic Part Number	List Price	Global Part Number	Domestic Part Number	List Price
		2"	519S20P	519S20S	\$51.00	519S20GP	519S20GS
2 1/2"	519S25P	519S25S	\$67.50	519S25GP	519S25GS	\$86.50	
3"	519S30P	519S30S	\$94.00	519S30GP	519S30GS	\$120.50	
4"	519S40P	519S40S	\$142.00	519S40GP	519S40GS	\$185.50	
6"	519S60P	519S60S	\$380.00	519S60GP	519S60GS	\$495.50	
8"	519S80P	519S80S	\$807.50	519S80GP	519S80GS	\$1,066.50	

All tees are cast fittings.

Technical Data Sheet: TFP1810

**G-FIRE #501 Global and Domestic – Fire Protection Standard Pattern Grooved 45° Elbow**

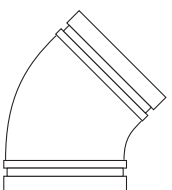
	Nom. Size	Painted			Galvanized		
		Global Part Number	Domestic Part Number	List Price	Global Part Number	Domestic Part Number	List Price
		1 1/4"	50113P	50113S	\$65.50	50113GP	50113GS
1 1/2"	50115P	50115S	\$65.50	50115GP	50115GS	\$82.50	
2"	50120P	50120S	\$33.50	50120GP	50120GS	\$43.00	
2 1/2"	50125P	50125S	\$44.50	50125GP	50125GS	\$56.00	
3"	50130P	50130S	\$59.00	50130GP	50130GS	\$74.50	
4"	50140P	50140S	\$84.50	50140GP	50140GS	\$112.50	
5"	-	20150S	\$301.00	-	20150GS	\$373.00	
6"	50160P	50160S	\$235.00	50160GP	50160GS	\$296.50	
8"	50180P	50180S	\$459.50	50180GP	50180GS	\$632.00	
10"	50110P	20110S	\$1,338.50	50110GP	20110GS	\$1,460.50	
12"	50112P	20112S	\$2,143.00	50112GP	20112GS	\$2,497.50	

All elbows are cast fittings.

Orders for items in shaded areas **cannot** be cancelled or returned.

Technical Data Sheet: TFP1810

**G-FIRE #510 Global and Domestic – Fire Protection Standard Pattern Grooved 90° Elbow**

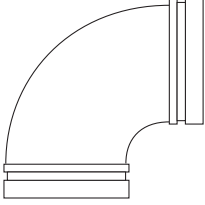
	Nom. Size	Painted			Galvanized		
		Global Part Number	Domestic Part Number	List Price	Global Part Number	Domestic Part Number	List Price
		1 1/4"	51013P	51013S	\$65.50	51013GP	51013GS
1 1/2"	51015P	51015S	\$65.50	51015GP	51015GS	\$87.00	
2"	51020P	51020S	\$65.50	51020GP	51020GS	\$87.00	
2 1/2"	51025P	51025S	\$65.50	51025GP	51025GS	\$87.00	
3"	51030P	51030S	\$116.00	51030GP	51030GS	\$144.50	
4"	51040P	51040S	\$126.00	51040GP	51040GS	\$176.50	
5"	–	21050S	\$301.00	–	21050GS	\$389.00	
6"	51060P	51060S	\$353.50	51060GP	51060GS	\$468.50	
8"	51080P	51080S	\$736.50	51080GP	51080GS	\$970.50	
10"	51010P	21010S	\$1,338.50	51010GP	21010GS	\$1,733.50	
12"	51012P	21012S	\$2,143.00	51012GP	21012GS	\$2,765.00	

All elbows are cast fittings.  
Technical Data Sheet: TFP1810

**G-FIRE #510DE Domestic – 90° Elbow with 1" Outlet**

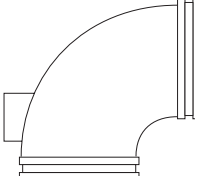
	Nom. Size	Painted		Galvanized	
		Domestic Part Number	List Price	Domestic Part Number	List Price
		2"	51020DS	\$153.50	51020DGS
2 1/2" *	51025DS	\$153.50	51025DGS	\$197.50	
3" *	51030DS	\$196.00	51030DGS	\$234.50	
4" *	51040DS	\$199.50	51040DGS	\$270.50	
6" *	51060DS	\$350.00	51060DGS	\$498.00	
8" *	51080DS	\$591.50	51080DGS	\$841.00	

Elbow is segmentally welded except where a \* indicates it is available as a cast fitting.  
Orders for items in shaded areas **cannot** be cancelled or returned.  
Technical Data Sheet: TFP1810

**G-FIRE #519 Global and Domestic – Fire Protection Standard Pattern Grooved Tee**

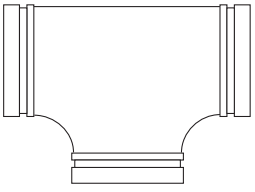
	Nom. Size	Painted			Galvanized		
		Global Part Number	Domestic Part Number	List Price	Global Part Number	Domestic Part Number	List Price
		1 1/4"	51913P	51913S	\$101.50	51913GP	51913GS
1 1/2"	51915P	51915S	\$101.50	51915GP	51915GS	\$133.00	
2"	51920P	51920S	\$101.50	51920GP	51920GS	\$133.00	
2 1/2"	51925P	51925S	\$101.50	51925GP	51925GS	\$133.00	
3"	51930P	51930S	\$139.50	51930GP	51930GS	\$191.00	
4"	51940P	51940S	\$212.50	51940GP	51940GS	\$288.50	
5"	–	21950S	\$496.00	–	21950GS	\$629.50	
6"	51960P	51960S	\$572.50	51960GP	51960GS	\$781.50	
8"	51980P	51980S	\$1,255.00	51980GP	51980GS	\$1,647.00	
10"	51910P	21910S	\$2,605.50	51910GP	21910GS	\$3,373.50	
12"	51912P	21912S	\$3,631.50	51912GP	21912GS	\$4,638.50	

All tees are cast fittings.  
Orders for items in shaded areas **cannot** be cancelled or returned.  
Technical Data Sheet: TFP1810



**#260 Domestic and Global – Grooved Cap**

Nom. Size	Painted			Galvanized		
	Global Part Number	Domestic Part Number	List Price	Global Part Number	Domestic Part Number	List Price
1"	–	26001S	\$55.50	–	26001GS	\$66.50
1 1/4"	26013P	26013S	\$17.50	26013GP	26013GS	\$27.50
1 1/2"	26015P	26015S	\$18.50	26015GP	26015GS	\$27.50
2"	26020P	26020S	\$22.00	26020GP	26020GS	\$30.50
2 1/2"	26025P	26025S	\$26.00	26025GP	26025GS	\$33.50
3"	26030P	26030S	\$31.00	26030GP	26030GS	\$40.50
4"	26040P	26040S	\$46.00	26040GP	26040GS	\$63.00
5"	26050P	26050S	\$139.50	26050GP	26050GS	\$187.00
6"	26060P	26060S	\$104.50	26060GP	26060GS	\$145.00
8"	26080P	26080S	\$199.50	26080GP	26080GS	\$273.00
10"	26010P	26010S	\$560.00	26010GP	26010GS	\$729.50
12"	26012P	26012S	\$916.00	26012GP	26012GS	\$1,166.00

All caps are cast fittings.

Orders for items in shaded areas **cannot** be cancelled or returned.

**Technical Data Sheet: TFP1810**

**#260 Domestic and Global – Grooved Cap with 1/2" Tap**

Nom. Size	Painted		
	Global Part Number	Domestic Part Number	List Price
2"	26020TP	26020TS	\$287.50
2 1/2"	26025TP	26025TS	\$290.50
3"	26030TP	26030TS	\$290.50
4"	26040TP	26040TS	\$295.50
5"	–	26050TS	POA
6"	26060TP	26060TS	\$406.50
8"	26080TP	26080TS	\$600.00

All caps are cast fittings.

**Technical Data Sheet: TFP1810**

**#260 Domestic and Global – Grooved Cap with 1" Tap**

Nom. Size	Painted		
	Global Part Number	Domestic Part Number	List Price
2"	26020T1P	26020T1S	\$287.50
2 1/2"	26025T1P	26025T1S	\$290.50
3"	26030T1P	26030T1S	\$383.50
4"	26040T1P	26040T1S	\$369.50
5"	–	26050T1S	POA
6"	26060T1P	26060T1S	\$406.50
8"	26080T1P	26080T1S	\$486.50

All caps are cast fittings.

**Technical Data Sheet: TFP1810**

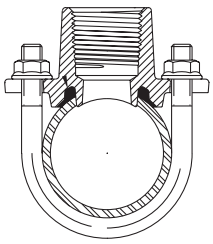

**#40-5 Domestic – Strap**

	<i>Nom. Size</i>	<i>Domestic Part Number with "E" Gasket</i>	<i>List Price</i>
	1 1/4" x 1/2"	STP1305ES	\$17.50
	1 1/4" x 3/4"	STP13075ES	\$17.50
	1 1/4" x 1"	STP1310ES	\$19.00
	1 1/2" x 1/2"	STP1505ES	\$19.00
	1 1/2" x 3/4"	STP15075ES	\$19.00
	1 1/2" x 1"	STP1510ES	\$19.00
	2" x 1/2"	STP2005ES	\$20.00
	2" x 3/4"	STP20075ES	\$20.00
	2" x 1"	STP2010ES	\$20.00
2 1/2" x 1/2"	STP2505ES	\$22.50	
2 1/2" x 3/4"	STP25075ES	\$22.50	
2 1/2" x 1"	STP2510ES	\$22.50	

**ADACAP #750 Domestic**

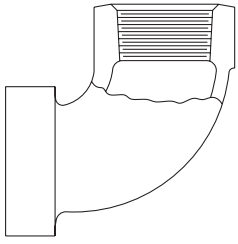
	<i>Nom. Size</i>	<i>Domestic Part Number</i>	<i>List Price</i>
	1 1/2" x 1/2"	7501505S	\$61.00
	1 1/2" x 3/4"	75015075S	\$61.00
	1 1/2" x 1"	7501510S	\$61.00
	2" x 1/2"	7502005S	\$65.50
	2" x 3/4"	75020075S	\$65.50
	2" x 1"	7502010S	\$65.50
	2 1/2" x 1/2"	7502505S	\$78.00
	2 1/2" x 3/4"	75025075S	\$78.00
	2 1/2" x 1"	7502510S	\$78.00

Technical Data Sheet: TFP1810

Section 16  
Specialty Items

Section 18  
Grooved Products

Section 19  
CPVC Pipe & Fittings

Section 20  
Miscellaneous

Section 21  
Electrical

Section C  
Valves & Hose Equipment

Section D  
Backflow

Section F  
Pipe & Accessories

Section H  
Hangers

Section J  
Lubricants

Section K  
Misc.

Section 16  
Specialty Items

Section 18  
Grooved Product

Section 19  
CPVC Pipe & Fittings

Section 20  
Miscellaneous

Section 21  
Electrical

Section C  
Valves & Hose Equipment

Section D  
Backflow

Section F  
Pipe & Accessories

Section H  
Hangers

Section J  
Lubricants

Section K  
Misc.

**#512 Domestic – Grooved 22<sup>1</sup>/<sub>2</sub>° Elbow**

Nom. Size	Painted		Galvanized	
	Domestic Part Number	List Price	Domestic Part Number	List Price
1 <sup>1</sup> / <sub>4</sub> "	51213S	\$71.50	51213GS	\$90.50
1 <sup>1</sup> / <sub>2</sub> "	51215S	\$71.50	51215GS	\$90.50
2"	51220S	\$71.50	51220GS	\$90.50
2 <sup>1</sup> / <sub>2</sub> "	51225S	\$71.50	51225GS	\$90.50
3"	51230S	\$102.50	51230GS	\$129.00
4"	51240S	\$136.00	51240GS	\$176.50
5"	51250S	\$417.50	51250GS	\$503.50
6"	51260S	\$381.50	51260GS	\$486.50
8"	51280S	\$796.00	51280GS	\$988.50
10" *	75559	\$1,090.50	75579	\$1,416.00
12" *	75560	\$1,474.00	75580	\$1,827.50

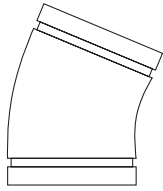

Elbow is Cast except where a \* indicates it is segmentally welded.  
Orders for items in shaded areas **cannot** be cancelled or returned.

**Technical Data Sheet: TFP1810**

**#511 Domestic – Grooved 11<sup>1</sup>/<sub>4</sub>° Elbow**

Nom. Size	Painted		Galvanized	
	Domestic Part Number	List Price	Domestic Part Number	List Price
1 <sup>1</sup> / <sub>4</sub> "	51113S	\$71.50	51113GS	\$90.50
1 <sup>1</sup> / <sub>2</sub> "	51115S	\$71.50	51115GS	\$90.50
2"	51120S	\$165.00	51120GS	\$193.00
2 <sup>1</sup> / <sub>2</sub> "	51125S	\$165.00	51125GS	\$193.00
3"	51130S	\$102.50	51130GS	\$128.00
4"	51140S	\$126.00	51140GS	\$167.50
5"	51150S	\$417.50	51150GS	\$491.00
6"	51160S	\$381.50	51160GS	\$461.50
8"	51180S	\$680.00	51180GS	\$808.00
10" *	75309	\$1,018.00	75315	\$1,215.00
12" *	75310	\$1,474.00	75323	\$1,785.00

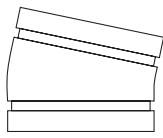

Elbow is Cast except where a \* indicates it is segmentally welded.  
Orders for items in shaded areas **cannot** be cancelled or returned.

**Technical Data Sheet: TFP1810**

See latest catalog or technical data sheets for specific approvals, listings, and design parameters.  
POA = Price on availability. Prices subject to change without notice.

## Price Book - Section 18 GRINNELL Grooved Products

### #321 Domestic – Grooved Reducing Tee

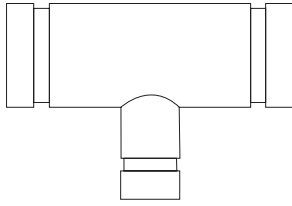

Nom. Size	Painted		Galvanized	
	Domestic Part Number	List Price	Domestic Part Number	List Price
2" x 1"	75410	\$215.00	75470	\$252.00
2" x 1 1/2"	75411	\$215.00	75471	\$256.00
2 1/2" x 1"	75412	\$215.00	–	\$252.00
2 1/2" x 1 1/4"	75413	\$324.00	73590	\$381.50
2 1/2" x 1 1/2"	75414	\$215.00	73591	\$256.00
2 1/2" x 2"	75415	\$215.00	75472	\$256.00
3" x 1"	75416	\$189.50	–	\$242.50
3" x 1 1/2"	75417	\$189.50	73592	\$244.50
3" x 2"	75418	\$189.50	75473	\$244.50
3" x 2 1/2"	75419	\$189.50	75474	\$244.50
4" x 1"	75420	\$256.00	–	\$319.50
4" x 1 1/2"	75421	\$256.00	73594	\$319.50
4" x 2"	75422	\$256.00	75475	\$336.00
4" x 2 1/2"	75423	\$256.00	75476	\$336.00
4" x 3"	75424	\$256.00	75477	\$336.00
5" x 2"	75425	\$620.50	73595	\$766.50
5" x 2 1/2"	75426	\$505.50	73596	\$636.50
5" x 3"	75427	\$505.50	75489	\$636.50
5" x 4"	75428	\$547.00	73597	\$691.00
6" x 2"	75429	\$602.00	75478	\$791.00
6" x 2 1/2"	75430	\$602.00	75479	\$791.00
6" x 3"	75431	\$602.00	75480	\$791.00
6" x 4"	75432	\$602.00	75481	\$791.00
6" x 5"	75433	\$602.00	–	\$796.00
8" x 3"	75435	\$935.00	75482	\$1,118.00
8" x 4"	75436	\$1,255.00	75483	\$1,621.50
8" x 5"	75437	\$1,255.00	75484	\$1,632.50
8" x 6"	75438	\$1,255.00	75485	\$1,639.50
10" x 3"	75439	\$1,512.00	73621	\$2,405.50
10" x 4"	75440	\$1,580.50	73622	\$2,020.00
10" x 5"	75441	\$1,615.50	73623	\$2,062.50
10" x 6"	75442	\$1,615.50	73624	\$2,623.00
10" x 8"	75443	\$1,645.00	73625	\$2,636.00
12" x 6"	75444	\$2,333.50	73629	\$3,423.00
12" x 8"	75445	\$2,398.00	73630	\$3,626.50
12" x 10"	75446	\$2,510.00	73631	\$3,903.00

Tee is segmentally welded except where a \* indicates it is available as a cast fitting.

Orders for items in shaded areas **cannot** be cancelled or returned.

**Technical Data Sheet: TFP1810**

Section 16  
Specialty Items  
  
 Section 18  
Grooved Products  
  
 Section 19  
CPVC Pipe & Fittings  
  
 Section 20  
Miscellaneous  
  
 Section 21  
Electrical  
  
 Section C  
Valves & Hose Equipment  
  
 Section D  
Backflow  
  
 Section F  
Pipe & Accessories  
  
 Section H  
Hangers  
  
 Section J  
Lubricants  
  
 Section K  
Misc.

Section 16  
Specialty Items

Section 18  
Grooved Product

Section 19  
CPVC Pipe & Fittings

Section 20  
Miscellaneous

Section 21  
Electrical

Section C  
Valves & Hose Equipment

Section D  
Backflow

Section F  
Pipe & Accessories

Section H  
Hangers

Section J  
Lubricants

Section K  
Misc.

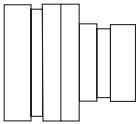
<b>#550 and #350 Domestic – Concentric Reducer</b>					
	<i>Nom. Size</i>	<i>Painted</i>		<i>Galvanized</i>	
		<i>Domestic Part Number</i>	<i>List Price</i>	<i>Domestic Part Number</i>	<i>List Price</i>
	1 1/2" x 1"	74328	\$76.50	73400	\$90.00
	1 1/2" x 1 1/4"	5501513S *	\$76.50	5501513GS *	\$90.00
	2" x 1/2"	72850	POA	73392	POA
	2" x 3/4"	72851	\$76.50	73401	\$90.00
	2" x 1"	72852	\$76.50	73402	\$90.00
	2" x 1 1/4"	72853	\$83.50	73403	\$98.50
	2" x 1 1/2"	72854	\$76.50	73404	\$90.00
	2 1/2" x 1"	72855	\$104.00	73393	\$120.00
	2 1/2" x 1 1/4"	5502513S *	\$76.50	5502513GS *	\$90.00
	2 1/2" x 1 1/2"	5502515S *	\$76.50	5502515GS *	\$90.00
	2 1/2" x 2"	5502520S *	\$76.50	5502520GS *	\$90.00
	3" x 1"	72860	\$83.50	73406	\$102.00
	3" x 1 1/4"	72861	\$134.50	73396	\$155.00
	3" x 1 1/2"	5503015S *	\$92.50	5503015GS *	\$112.50
	3" x 2"	5503020S *	\$67.50	5503020GS *	\$82.50
	3" x 2 1/2"	5503025S *	\$92.50	5503025GS *	\$111.50
	4" x 1"	72867	\$101.50	73409	\$125.00
	4" x 1 1/4"	72868	\$780.50	73756	\$874.50
	4" x 1 1/2"	72869	\$140.50	73410	\$185.50
	4" x 2"	5504020S *	\$90.00	5504020GS *	\$110.50
	4" x 2 1/2"	5504025S *	\$111.50	5504025GS *	\$135.50
	4" x 3"	5504030S *	\$111.50	5504030GS *	\$135.50
	4" x 3 1/2"	72875	\$111.50	73398	\$135.50
	5" x 2"	72876	\$1,098.00	73399	\$1,212.50
	5" x 2 1/2"	72877	\$227.00	73758	\$277.00
	5" x 3"	5505030S *	\$129.00	5505030GS *	\$160.00
	5" x 4"	5505040S *	\$154.00	5505040GS *	\$193.00
	6" x 2"	5506020S *	\$204.00	5506020GS *	\$254.50
	6" x 2 1/2"	5506025S *	\$227.00	5506025GS *	\$279.00
	6" x 3"	5506030S *	\$204.00	5506030GS *	\$254.50
	6" x 4"	5506040S *	\$178.50	5506040GS *	\$231.00
	6" x 5"	5506050S *	\$263.00	5506050GS *	\$327.00
	8" x 3"	5508030S *	\$363.50	5508030GS *	\$453.00
	8" x 4"	5508040S *	\$363.50	5508040GS *	\$455.50
	8" x 5"	5508050S *	\$363.50	5508050GS *	\$458.50
	8" x 6"	5508060S *	\$462.00	5508060GS *	\$578.50
	10" x 4"	72889	\$861.00	73764	\$1,060.00
	10" x 6"	5501060S *	\$941.50	73425	\$1,174.00
	10" x 8"	72891	\$941.50	73422	\$1,194.00
	12" x 4"	5501240S *	\$4,123.50	73766	\$4,907.50
	12" x 6"	5501260S *	\$1,123.00	73767	\$1,388.00
	12" x 8"	5501280S *	\$1,685.00	73423	\$1,989.50
	12" x 10"	5501210S *	\$1,685.00	73424	\$2,086.00

Reducer is segmentally welded except where a \* indicates it is available as a cast fitting.

Orders for items in shaded areas **cannot** be cancelled or returned.

**Technical Data Sheet: TFP1810**

**#341 Domestic – Grooved x Flanged Adapter 150 Lbs. – Schedule 40**

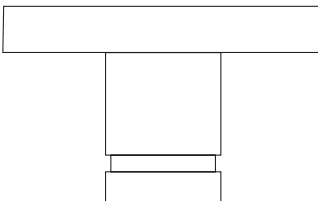
	Nom. Size	Painted		Galvanized	
		Domestic Part Number	List Price	Domestic Part Number	List Price
		2"	<b>73230</b>	\$277.50	<b>73250</b>
2 1/2"	<b>73231</b>	\$554.50	<b>73251</b>	\$653.00	
3"	<b>73232</b>	\$567.50	<b>73252</b>	\$674.50	
4"	<b>73233</b>	\$647.00	<b>73253</b>	\$943.00	
5"	<b>73234</b>	\$895.50	<b>73254</b>	\$1,240.50	
6"	<b>73235</b>	\$911.50	<b>73255</b>	\$1,257.50	
8"	<b>73236</b>	\$1,128.00	<b>73256</b>	\$1,680.00	
10"	<b>73237</b>	\$1,770.00	<b>74265</b>	\$2,653.50	
12"	<b>73238</b>	\$2,423.50	<b>74254</b>	\$3,499.00	

All adapters are segmentally welded.

Orders for items in shaded areas **cannot** be cancelled or returned.

**Technical Data Sheet: TFP1810**

**#342 Domestic – Grooved x Flanged Adapter 300 Lbs. – Schedule 40**

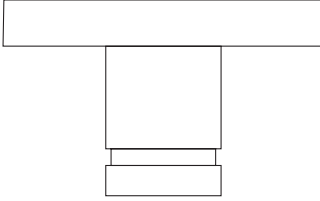
	Nom. Size	Painted		Galvanized	
		Domestic Part Number	List Price	Domestic Part Number	List Price
		4"	<b>73260</b>	\$890.50	<b>73263</b>
5"	<b>73261</b>	\$911.50	<b>73264</b>	POA	
6"	<b>73262</b>	\$911.50	<b>74283</b>	\$1,376.50	

All adapters are segmentally welded.

Orders for items in shaded areas **cannot** be cancelled or returned.

**#320 Domestic – Grooved x Male Thread Tee, Painted**

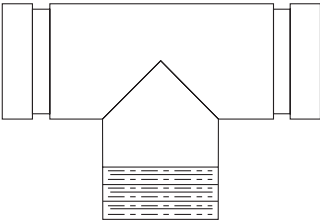
	Nom. Size	Painted		Galvanized	
		Domestic Part Number	List Price	Domestic Part Number	List Price
		1 1/2"	<b>75490</b>	\$332.50	<b>73553</b>
2"	<b>75491</b>	\$213.00	<b>73554</b>	\$250.50	
2 1/2"	<b>75492</b>	POA	<b>73555</b>	POA	
3"	<b>75493</b>	POA	<b>32030GS</b>	POA	
4"	<b>75465</b>	\$441.50	<b>73557</b>	\$607.00	
6"	<b>75466</b>	\$1,133.50	<b>73559</b>	\$1,334.00	

Adapter is segmentally welded.

Orders for items in shaded areas **cannot** be cancelled or returned.

Section 16  
Specialty Items

Section 18  
Grooved Products

Section 19  
CPVC Pipe & Fittings

Section 20  
Miscellaneous

Section 21  
Electrical

Section C  
Valves & Hose Equipment

Section D  
Backflow

Section F  
Pipe & Accessories

Section H  
Hangers

Section J  
Lubricants

Section K  
Misc.

**Standpipe Domestic – Tee**

Nom. Size	Painted		Galvanized	
	Domestic Part Number	List Price	Domestic Part Number	List Price
4" x 4" x 2 1/2"	76768	POA	76755	POA
6" x 6" x 2 1/2"	76769	POA	76771	POA

Orders for items in shaded areas **cannot** be cancelled or returned.

**#507/#50L Domestic – Bullhead Tee**

Nom. Size	Painted		Galvanized	
	Domestic Part Number	List Price	Domestic Part Number	List Price
5" x 5" x 8"	76772	POA	76774	POA
6" x 6" x 8"	76773	POA	76775	POA

Orders for items in shaded areas **cannot** be cancelled or returned.

**#323 Domestic – Reducing Tee with Threaded Branch**

Nom. Size	Painted		Galvanized	
	Domestic Part Number	List Price	Domestic Part Number	List Price
2" x 1"	75500	\$227.00	75520	\$266.50
2" x 1 1/2"	75501	\$227.00	75522	\$269.50
2 1/2" x 1 1/4"	75502	\$496.50	73608	\$510.50
2 1/2" x 1 1/2"	75503	\$227.00	73609	\$269.50
2 1/2" x 2"	75504	\$227.00	73610	\$272.00
3" x 1"	75505	\$227.00	75521	\$284.00
3" x 1 1/2"	75506	\$227.00	75546	\$286.00
3" x 2"	75507	\$227.00	75523	\$286.00
3" x 2 1/2"	75508	\$547.50	73611	\$593.00
4" x 1"	75509	\$284.00	75524	\$350.00
4" x 2"	75510	\$284.00	75525	\$356.00
4" x 2 1/2"	75511	\$284.00	73691	\$366.00
4" x 3"	75512	\$284.00	75526	\$367.50
5" x 2"	75513	\$607.50	75534	\$662.50
6" x 2"	75514	\$709.00	75527	\$883.50
6" x 2 1/2"	75590	\$709.00	75528	\$883.50
6" x 3"	75515	\$709.00	75529	\$883.50
6" x 4"	75516	\$896.50	73694	\$964.00
6" x 5"	75517	\$709.00	73695	\$883.50
8" x 2"	75518	\$868.00	73696	\$1,197.50
8" x 3"	75519	\$1,197.50	73697	\$1,553.00

All tees are segmentally welded.

Orders for items in shaded areas **cannot** be cancelled or returned.

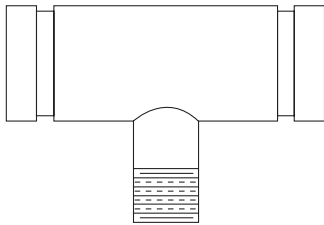

See latest catalog or technical data sheets for specific approvals, listings, and design parameters.  
POA = Price on availability. Prices subject to change without notice.

**#327 Domestic – Grooved Cross**

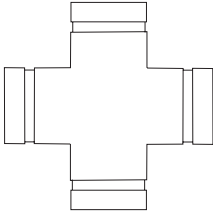
	Nom. Size	Painted		Galvanized	
		Domestic Part Number	List Price	Domestic Part Number	List Price
	2"	<b>75840</b>	\$181.50	<b>75849</b>	\$216.50
	2 1/2"	<b>75841</b>	\$181.50	<b>75850</b>	\$216.50
	3"	<b>75842</b>	\$323.50	<b>75851</b>	\$396.00
	4"	<b>75843</b>	\$537.00	<b>75852</b>	\$660.50
	6"	<b>75845</b>	\$1,405.00	<b>75853</b>	\$1,705.50
	8"	<b>75846</b>	\$1,851.00	<b>76757</b>	\$2,289.50
	10"	<b>75847</b>	\$3,153.50	<b>76758</b>	\$3,900.50
	12"	<b>75848</b>	\$4,550.50	<b>76759</b>	\$5,669.50

Orders for items in shaded areas **cannot** be cancelled or returned.

Technical Data Sheet: TFP1810

**#372 Domestic – Reducer Small End Threaded (Male)**

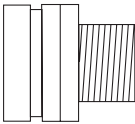
	Nom. Size	Painted		Galvanized	
		Domestic Part Number	List Price	Domestic Part Number	List Price
	1 1/2" x 1"	<b>76800</b>	\$80.00	<b>76825</b>	\$98.00
	2" x 3/4"	<b>76801</b>	\$80.00	<b>76826</b>	\$98.00
	2" x 1"	<b>76802</b>	\$80.00	<b>76827</b>	\$98.00
	2" x 1 1/4"	<b>76815</b>	\$80.00	<b>73794</b>	\$98.00
	2" x 1 1/2"	<b>76803</b>	\$80.00	<b>76828</b>	\$98.00
	2 1/2" x 1 1/4"	<b>76816</b>	\$113.00	<b>73795</b>	\$139.50
	2 1/2" x 1 1/2"	<b>76817</b>	\$118.50	<b>73796</b>	\$139.50
	2 1/2" x 2"	<b>76804</b>	\$80.00	<b>76829</b>	\$98.00
	3" x 1"	<b>76805</b>	\$87.00	<b>76830</b>	\$104.50
	3" x 1 1/4"	<b>76818</b>	\$274.50	—	POA
	3" x 1 1/2"	<b>76819</b>	\$98.00	<b>73797</b>	\$117.50
	3" x 2"	<b>76806</b>	\$98.00	<b>76831</b>	\$117.50
	3" x 2 1/2"	<b>76807</b>	\$118.50	<b>76832</b>	\$139.50
	4" x 1"	<b>76808</b>	\$112.00	<b>76833</b>	\$135.50
	4" x 1 1/4"	<b>76820</b>	POA	—	POA
	4" x 1 1/2"	<b>76821</b>	\$262.50	<b>73799</b>	\$343.50
	4" x 2"	<b>76809</b>	\$119.00	<b>76834</b>	\$143.00
	4" x 2 1/2"	<b>76810</b>	\$119.50	<b>76835</b>	\$147.00
	4" x 3"	<b>76811</b>	\$146.50	<b>76836</b>	\$173.50
	6" x 1"	<b>76812</b>	\$227.00	<b>76837</b>	\$279.00
6" x 2"	<b>76813</b>	\$227.00	<b>76838</b>	\$279.00	
6" x 3"	<b>76814</b>	\$227.00	<b>76839</b>	\$279.00	

All reducers are segmentally welded.

Orders for items in shaded areas **cannot** be cancelled or returned.



**#391 Domestic – Groove x Male Thread Adapter Nipple**

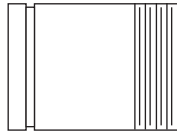

Nom. Size	Painted		Galvanized	
	Domestic Part Number	List Price	Domestic Part Number	List Price
1 <sup>1</sup> / <sub>4</sub> " x 4"	75121	\$39.50	74292	POA
1 <sup>1</sup> / <sub>2</sub> " x 4"	75122	\$39.50	74293	POA
2" x 4"	75123	\$39.50	74294	\$78.50
2 <sup>1</sup> / <sub>2</sub> " x 4"	75124	\$45.50	74295	\$134.50
3" x 4"	75125	\$55.50	74296	\$112.00
3" x 6"	74335	\$90.00	–	POA
4" x 6"	75126	\$91.00	74297	\$221.00
5" x 6"	75129	\$188.00	74298	POA
6" x 6"	75130	\$241.50	74299	\$431.00
8" x 6"	75131	\$270.50	74336	POA
10" x 8"	75132	\$393.50	74337	POA
12" x 8"	75133	\$493.50	74338	POA

All adapter nipples are segmentally welded.

Orders for items in shaded areas **cannot** be cancelled or returned.

**Technical Data Sheet: TFP1810**

**#392 Domestic – Groove x Groove Adapter Nipple**

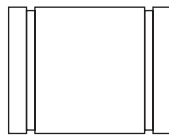

Nom. Size	Painted		Galvanized	
	Domestic Part Number	List Price	Domestic Part Number	List Price
1 <sup>1</sup> / <sub>4</sub> " x 4"	75098	\$39.50	74339	POA
1 <sup>1</sup> / <sub>2</sub> " x 4"	75099	\$39.50	74405	POA
2" x 4"	75100	\$39.50	74406	POA
2 <sup>1</sup> / <sub>2</sub> " x 4"	75101	\$45.50	74407	POA
3" x 4"	75102	\$55.50	74408	POA
4" x 6"	75103	\$91.00	74309	POA
5" x 6"	75104	\$188.00	74310	POA
6" x 6"	75105	\$241.50	74311	POA
8" x 6"	75106	\$270.50	74312	POA
10" x 8"	75107	\$393.50	74313	POA
12" x 8"	75108	\$493.50	74314	POA

All adapter nipples are segmentally welded.

Orders for items in shaded areas **cannot** be cancelled or returned.

**Technical Data Sheet: TFP1810**

**#393 Domestic – Groove x Plain Adapter Nipple**

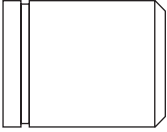
	Nom. Size	Painted		Galvanized	
		Domestic Part Number	List Price	Domestic Part Number	List Price
	1 1/4" x 4"	75148	\$39.50	74316	POA
	1 1/2" x 4"	74315	\$39.50	74317	POA
	2" x 4"	75150	\$39.50	74318	POA
	2 1/2" x 4"	75151	\$45.50	74319	POA
	3" x 4"	75152	\$55.50	74330	POA
	4" x 6"	75153	\$91.00	74331	POA
	5" x 6"	75158	\$188.00	74322	POA
	6" x 6"	75154	\$241.50	74323	POA
	8" x 6"	75155	\$270.50	74324	POA
	10" x 8"	75156	\$393.50	74325	POA
	12" x 8"	75157	\$493.50	74326	POA

All adapter nipples are segmentally welded.

Orders for items in shaded areas **cannot** be cancelled or returned.

**Technical Data Sheet: TFP1810**

Section 16  
Specialty Items

Section 18  
Grooved Products

Section 19  
CPVC Pipe & Fittings

Section 20  
Miscellaneous

Section 21  
Electrical

Section C  
Valves & Hose Equipment

Section D  
Backflow

Section F  
Pipe & Accessories

Section H  
Hangers

Section J  
Lubricants

Section K  
Misc.

**#730 Domestic – Female Threaded Mechanical Tee  
with Grade “E” EPDM Gasket Threaded Outlet**

Nom. Size	Painted		Galvanized		Gasket Only	
	Domestic Part Number	List Price	Domestic Part Number	List Price	Domestic Part Number	List Price
2" x 1/2"	7302005ES	\$61.00	7302005EGS	\$77.00	730EGS-1	\$12.50
2" x 3/4"	73020075ES	\$61.00	73020075EGS	\$77.00	730EGS-1	\$12.50
2" x 1"	7302010ES	\$61.00	7302010EGS	\$77.00	730EGS-1	\$12.50
2" x 1 1/4"	7302013ES	\$70.50	7302013EGS	\$88.00	730EGS-2	\$14.00
2" x 1 1/2"	7302015ES	\$70.50	7302015EGS	\$88.00	730EGS-2	\$14.00
2 1/2" x 1/2"	7302505ES	\$61.00	7302505EGS	\$77.00	730EGS-1	\$12.50
2 1/2" x 3/4"	73025075ES	\$61.00	73025075EGS	\$77.00	730EGS-1	\$12.50
2 1/2" x 1"	7302510ES	\$61.00	7302510EGS	\$77.00	730EGS-1	\$12.50
2 1/2" x 1 1/4"	7302513ES	\$86.50	7302513EGS	\$105.50	730EGS-3	\$14.00
2 1/2" x 1 1/2"	7302515ES	\$86.50	7302515EGS	\$105.50	730EGS-3	\$14.00
2 1/2" x 2"	7302520EP *	POA	7302520EGP *	POA	730EGS-4	\$14.00
3" x 1/2"	7303005ES	\$70.50	7303005EGS	\$86.50	730EGS-1	\$12.50
3" x 3/4"	73030075ES	\$70.50	73030075EGS	\$86.50	730EGS-1	\$12.50
3" x 1"	7303010ES	\$70.50	7303010EGS	\$86.50	730EGS-1	\$12.50
3" x 1 1/4"	7303013ES	\$89.50	7303013EGS	\$112.50	730EGS-2	\$14.00
3" x 1 1/2"	7303015ES	\$89.50	7303015EGS	\$112.50	730EGS-3	\$14.00
3" x 2"	7303020ES	\$103.00	7303020EGS	\$128.50	730EGS-4	\$14.00
4" x 1/2"	7304005ES	\$89.00	7304005EGS	\$106.50	730EGS-1	\$12.50
4" x 3/4"	73040075ES	\$89.00	73040075EGS	\$106.50	730EGS-1	\$12.50
4" x 1"	7304010ES	\$89.00	7304010EGS	\$106.50	730EGS-1	\$12.50
4" x 1 1/4"	7304013ES	\$104.50	7304013EGS	\$123.50	730EGS-2	\$14.00
4" x 1 1/2"	7304015ES	\$109.00	7304015EGS	\$137.00	730EGS-3	\$14.00
4" x 2"	7304020ES	\$109.00	7304020EGS	\$138.00	730EGS-4	\$14.00
4" x 2 1/2"	7304025ES	\$113.50	7304025EGS	\$147.50	730EGS-5	\$16.50
4" x 3"	7304030ES	\$121.00	7304030EGS	\$155.50	730EGS-7	\$18.00
5" x 1 1/2"	7305015EP *	\$133.00	7305015EGP *	\$168.50	730EGS-3	\$14.00
5" x 2"	7305020ES	\$133.00	7305020EGS	\$168.50	730EGS-4	\$14.00
5" x 2 1/2"	7305025ES	\$140.50	7305025EGS	\$179.00	730EGS-5	\$16.50
5" x 3"	7305030EP *	\$149.50	7305030EGP *	\$192.50	730EGS-7	\$18.00
6" x 1 1/4"	7306013EP *	POA	7306013EGP *	POA	730EGS-2	\$14.00
6" x 1 1/2"	7306015ES	\$136.50	7306015EGS	\$175.00	730EGS-3	\$14.00
6" x 2"	7306020ES	\$136.50	7306020EGS	\$175.00	730EGS-4	\$14.00
6" x 2 1/2"	7306025ES	\$147.00	7306025EGS	\$190.00	730EGS-6	\$17.00
6" x 3"	7306030ES	\$156.00	7306030EGS	\$201.00	730EGS-8	\$18.00
6" x 4"	7306040ES	\$173.00	7306040EGS	\$225.50	730EGS-9	\$24.50
8" x 2 1/2"	7308025ES	\$238.50	7308025EGS	\$301.50	730EGS-6	\$17.00
8" x 3"	7308030ES	\$252.00	7308030EGS	\$319.50	730EGS-8	\$18.00
8" x 4"	7308040ES	\$259.50	7308040EGS	\$335.50	730EGS-9	\$24.50

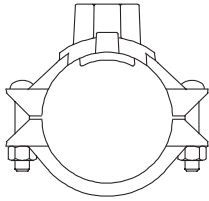

\* Only available as Global.

Orders for items in shaded areas **cannot** be cancelled or returned.

**Technical Data Sheet: TFP1860**

**#730 Domestic – Grooved Mechanical Tee  
with Grade “E” EPDM Gasket Grooved Outlet**

Nom. Size	Painted		Galvanized		Gasket Only	
	Domestic Part Number	List Price	Domestic Part Number	List Price	Domestic Part Number	List Price
2" x 1 1/4"	7302013ERS	\$70.50	7302013EGRS	\$88.00	730EGS-2	\$14.00
2" x 1 1/2"	7302015ERS	\$70.50	7302015EGRS	\$88.00	730EGS-2	\$14.00
2 1/2" x 1 1/4"	7302513ERS	\$86.50	7302513EGRS	\$105.50	730EGS-3	\$14.00
2 1/2" x 1 1/2"	7302515ERS	\$86.50	7302515EGRS	\$105.50	730EGS-3	\$14.00
2 1/2" x 2"	7302520ERP *	POA	7302520EGRP *	POA	730EGS-4	\$14.00
3" x 1 1/4"	7303013ERS	\$89.50	7303013EGRS	\$112.50	730EGS-2	\$14.00
3" x 1 1/2"	7303015ERS	\$89.50	7303015EGRS	\$112.50	730EGS-3	\$14.00
3" x 2"	7303020ERS	\$103.00	7303020EGRS	\$128.50	730EGS-4	\$14.00
4" x 1 1/4"	7304013ERS	\$104.50	7304013EGRS	\$123.50	730EGS-2	\$14.00
4" x 1 1/2"	7304015ERS	\$109.00	7304015EGRS	\$137.00	730EGS-3	\$14.00
4" x 2"	7304020ERS	\$109.00	7304020EGRS	\$138.00	730EGS-4	\$14.00
4" x 2 1/2"	7304025ERS	\$113.50	7304025EGRS	\$147.50	730EGS-5	\$16.50
4" x 3"	7304030ERS	\$121.00	7304030EGRS	\$155.50	730EGS-7	\$18.00
5" x 1 1/2"	7305015ERP *	\$133.00	7305015EGRP *	POA	730EGS-3	\$14.00
5" x 2"	7305020ERS	\$133.00	7305020EGRS	\$168.50	730EGS-4	\$14.00
5" x 2 1/2"	7305025ERS	\$140.50	7305025EGRS	POA	730EGS-5	\$16.50
5" x 3"	7305030ERP *	\$149.50	7305030EGRP *	\$192.50	730EGS-7	\$18.00
6" x 1 1/4"	7306013ERP *	\$136.50	7306013EGRP *	\$175.00	730EGS-2	\$14.00
6" x 1 1/2"	7306015ERS	\$136.50	7306015EGRS	\$175.00	730EGS-3	\$14.00
6" x 2"	7306020ERS	\$136.50	7306020EGRS	\$175.00	730EGS-4	\$14.00
6" x 2 1/2"	7306025ERS	\$149.50	7306025EGRS	\$190.00	730EGS-6	\$17.00
6" x 3"	7306030ERS	\$156.00	7306030EGRS	\$201.00	730EGS-8	\$18.00
6" x 4"	7306040ERS	\$173.00	7306040EGRS	\$225.50	730EGS-9	\$24.50
8" x 2 1/2"	7308025ERS	\$238.50	7308025EGRS	\$301.50	730EGS-6	\$17.00
8" x 3"	7308030ERS	\$252.00	7308030EGRS	\$319.50	730EGS-8	\$18.00
8" x 4"	7308040ERS	\$259.50	7308040EGRS	\$335.50	730EGS-9	\$24.50

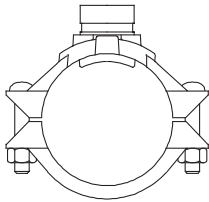

\* Only available as Global.

Orders for items in shaded areas **cannot** be cancelled or returned.

Technical Data Sheet: TFP1860

Section 16  
Specialty Items

Section 18  
Grooved Products

Section 19  
CPVC Pipe & Fittings

Section 20  
Miscellaneous

Section 21  
Electrical

Section C  
Valves & Hose Equipment

Section D  
Backflow

Section F  
Pipe & Accessories

Section H  
Hangers

Section J  
Lubricants

Section K  
Misc.

**#730 Domestic – Female Threaded Mechanical Cross  
with Grade “E” EPDM Gasket Threaded Outlet**

Nom. Size	Painted		Galvanized		Gasket Only (2 required for Cross)	
	Domestic Part Number	List Price	Domestic Part Number	List Price	Domestic Part Number	List Price
2" x 1 1/4"	7302013ECS	\$111.00	7302013EGCS	\$143.00	730EGS-2	\$14.00
2" x 1 1/2"	7302015ECS	\$111.00	7302015EGCS	\$143.00	730EGS-2	\$14.00
2 1/2" x 1 1/4"	7302513ECS	\$133.50	7302513EGCS	\$172.50	730EGS-3	\$14.00
2 1/2" x 1 1/2"	7302515ECS	\$133.50	7302515EGCS	\$184.50	730EGS-3	\$14.00
3" x 1 1/4"	7303013ECS	\$133.50	7303013EGCS	\$167.00	730EGS-2	\$14.00
3" x 1 1/2"	7303015ECS	\$133.50	7303015EGCS	\$167.00	730EGS-3	\$14.00
3" x 2"	7303020ECS	\$154.50	7303020EGCS	\$191.50	730EGS-4	\$14.00
4" x 1 1/4"	7304013ECS	\$162.00	7304013EGCS	\$203.50	730EGS-2	\$14.00
4" x 1 1/2"	7304015ECS	\$162.00	7304015EGCS	\$203.50	730EGS-3	\$14.00
4" x 2"	7304020ECS	\$173.50	7304020EGCS	\$205.00	730EGS-4	\$14.00
4" x 2 1/2"	7304025ECS	\$173.50	7304025EGCS	\$220.50	730EGS-5	\$16.50
4" x 3"	7304030ECS	\$181.00	7304030EGCS	\$234.00	730EGS-7	\$18.00
5" x 2"	7305020ECS	\$198.50	7305020EGCS	\$252.00	730EGS-4	\$14.00
5" x 2 1/2"	7305025ECS	\$209.00	7305025EGCS	\$267.00	730EGS-5	\$16.50
6" x 1 1/2"	7306015ECS	\$203.00	7306015EGCS	\$261.50	730EGS-3	\$14.00
6" x 2"	7306020ECS	\$212.00	7306020EGCS	\$282.50	730EGS-4	\$14.00
6" x 2 1/2"	7306025ECS	\$218.50	7306025EGCS	\$282.50	730EGS-6	\$17.00
6" x 3"	7306030ECS	\$233.00	7306030EGCS	\$299.50	730EGS-8	\$18.00
6" x 4"	7306040ECS	\$258.00	7306040EGCS	\$335.50	730EGS-9	\$24.50
8" x 2 1/2"	7308025ECS	\$357.00	7308025EGCS	\$451.00	730EGS-6	\$17.00
8" x 3"	7308030ECS	\$376.00	7308030EGCS	\$478.50	730EGS-8	\$18.00
8" x 4"	7308040ECS	\$388.50	7308040EGCS	\$502.50	730EGS-9	\$24.50

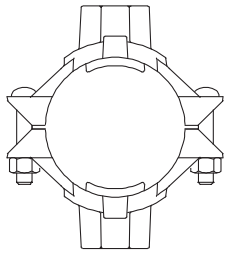

Orders for items in shaded areas **cannot** be cancelled or returned.

**Technical Data Sheet: TFP1860**

See latest catalog or technical data sheets for specific approvals, listings, and design parameters.  
POA = Price on availability. Prices subject to change without notice.

**#730 Domestic – Grooved Mechanical Cross  
with Grade “E” EPDM Gasket Grooved Outlet**

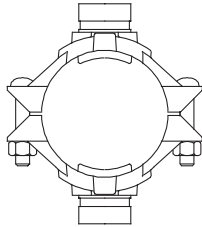

Nom. Size	Painted		Galvanized		Gasket Only (2 required for Cross)	
	Domestic Part Number	List Price	Domestic Part Number	List Price	Domestic Part Number	List Price
2" x 1 1/4"	7302013ERCS	\$111.00	7302013EGRCS	\$143.00	730EGS-2	\$14.00
2" x 1 1/2"	7302015ERCS	\$111.00	7302015EGRCS	\$143.00	730EGS-2	\$14.00
2 1/2" x 1 1/4"	7302513ERCS	\$133.50	7302513EGRCS	\$172.50	730EGS-3	\$14.00
2 1/2" x 1 1/2"	7302515ERCS	\$133.50	7302515EGRCS	\$184.50	730EGS-3	\$14.00
3" x 1 1/4"	7303013ERCS	\$133.50	7303013EGRCS	\$167.00	730EGS-2	\$14.00
3" x 1 1/2"	7303015ERCS	\$133.50	7303015EGRCS	\$167.00	730EGS-3	\$14.00
3" x 2"	7303020ERCS	\$154.50	7303020EGRCS	\$191.50	730EGS-4	\$14.00
4" x 1 1/4"	7304013ERCS	\$162.00	7304013EGRCS	\$203.50	730EGS-2	\$14.00
4" x 1 1/2"	7304015ERCS	\$162.00	7304015EGRCS	\$203.50	730EGS-3	\$14.00
4" x 2"	7304020ERCS	\$173.50	7304020EGRCS	\$205.00	730EGS-4	\$14.00
4" x 2 1/2"	7304025ERCS	\$173.50	7304025EGRCS	\$220.50	730EGS-5	\$16.50
4" x 3"	7304030ERCS	\$181.00	7304030EGRCS	\$234.00	730EGS-7	\$18.00
5" x 2"	7305020ERCS	\$198.50	7305020EGRCS	\$252.00	730EGS-4	\$14.00
5" x 2 1/2"	7305025ERCS	\$209.00	7305025EGRCS	\$267.00	730EGS-5	\$16.50
6" x 1 1/2"	7306015ERCS	\$203.00	7306015EGRCS	\$261.50	730EGS-3	\$14.00
6" x 2"	7306020ERCS	\$212.00	7306020EGRCS	\$282.50	730EGS-4	\$14.00
6" x 2 1/2"	7306025ERCS	\$218.50	7306025EGRCS	\$282.50	730EGS-6	\$17.00
6" x 3"	7306030ERCS	\$233.00	7306030EGRCS	\$299.50	730EGS-8	\$18.00
6" x 4"	7306040ERCS	\$258.00	7306040EGRCS	\$335.50	730EGS-9	\$24.50
8" x 2 1/2"	7308025ERCS	\$357.00	7308025EGRCS	\$451.00	730EGS-6	\$17.00
8" x 3"	7308030ERCS	\$376.00	7308030EGRCS	\$478.50	730EGS-8	\$18.00
8" x 4"	7308040ERCS	\$388.50	7308040EGRCS	\$502.50	730EGS-9	\$24.50

Orders for items in shaded areas **cannot** be cancelled or returned.

Technical Data Sheet: TFP1860

Section 16  
Specialty Items

Section 18  
Grooved Products

Section 19  
CPVC Pipe & Fittings

Section 20  
Miscellaneous

Section 21  
Electrical

Section C  
Valves & Hose Equipment

Section D  
Backflow

Section F  
Pipe & Accessories

Section H  
Hangers

Section J  
Lubricants

Section K  
Misc.

**G-FIRE #BFV-N Domestic – Grooved Butterfly Valves Fire Protection**

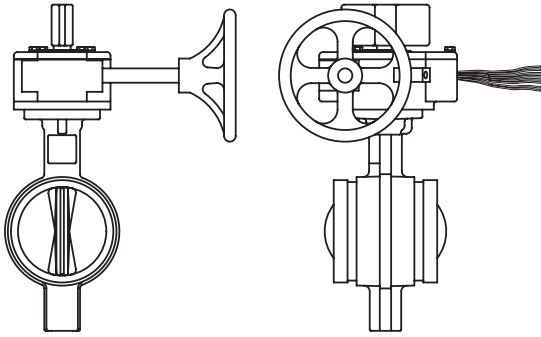

**Model BFV-N Grv x Grv, Gear Operated  
with Tamper Switches – 300psi**

<i>Nom. Size</i>	<i>Domestic Part Number - UL, FM &amp; ULC</i>	<i>List Price</i>
2 1/2"	59-300-F-025N	\$580.00
3"	59-300-F-030N	\$627.00
4"	59-300-F-040N	\$657.50
5"	59-300-F-050N	\$985.00
6"	59-300-F-060N	\$934.00
8"	59-300-F-080N	\$1,431.00
10"	59-300-F-100N	\$3,466.00

Orders for items in shaded areas **cannot** be cancelled or returned.

**Technical Data Sheet: TFP1510**

**G-FIRE #CV-1F Global – Grooved Check Valve**

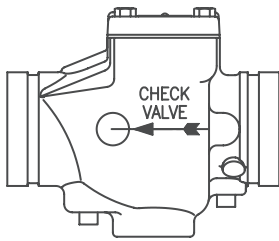

<i>Nom. Size</i>	<i>Global Part Number</i>	<i>List Price</i>
2"	59-590-0-020	\$314.50
2 1/2"	59-590-0-025	\$332.00
3"	59-590-0-030	\$332.00
4"	59-590-0-040	\$345.50
5"	59-590-0-050	\$840.50
6"	59-590-0-060	\$861.00
8"	59-590-0-080	\$1,496.00
10"	59-590-0-100	\$2,850.50

**Technical Data Sheet: TFP1550**

Section 16 Specialty Items  
Section 18 Grooved Product  
Section 19 CPVC Pipe & Fittings  
Section 20 Miscellaneous  
Section 21 Electrical  
Section C Valves & Hose Equipment  
Section D Backflow  
Section F Pipe & Accessories  
Section H Hangers  
Section J Lubricants  
Section K Misc.

See latest catalog or technical data sheets for specific approvals, listings, and design parameters.  
POA = Price on availability. Prices subject to change without notice.



**Roll Grooving Machine Selection Chart**

Machine Type	Pace Model	Size Range				Drive	Rolls Supplied			Part No.	List Price **
		Sch. 40	Sch. 10	Std. Wall	Copper		Size	Steel	Copper		
Portable with Electric Motor	1112	1" - 12"	-	-	2" - 8"	1½ HP, 110V	1" - 12"	■		41048	\$8,655.50
	1023	1¼" - 12"	-	12" - 24"	2" - 8"	1½ HP, 110V	1¼" - 12"	■		41029	\$12,800.50
							2" - 12"	■		41250	\$12,182.00
							1¼" - 24"	■		41251	\$14,260.00
							2" - 24"	■		41252	\$13,636.00
Portable for Ridgid® 300	1012	1" - 12"	-	-	2" - 8"	Ridgid® 300	1" - 12"	■		41041	\$4,803.50
	1022	1¼" - 12"	-	12" - 16"	2" - 8"	Ridgid® 300	1¼" - 16"	■		41027	\$10,812.50
	1041	1" - 6"	1" - 12"	-	2" - 8"	Ridgid® 300	1" - 12"	■		41018	\$3,364.00
Mini-Mites	1039-66	1¼" - 6"	-	-	2" - 8"	Ridgid® 300, Hand Crank	2" - 8" CTS		■	41047	\$1,326.00
	1039	1¼" - 6"	-	-	2" - 8"	Ridgid® 300, Hand Crank	1¼" - 6" IPS	■		41017	\$1,326.00
	1034	1¼" - 6"	-	-	-	Ridgid® 300	1¼" - 6" IPS	■		41015	\$1,256.50
	1066	-	-	-	2" - 8"	Ridgid® 300	2" - 8" CTS		■	41014	\$1,256.50
Automated	2021	1¼" - 12"	-	12" - 24"	2" - 8"	3 HP, 220V	1¼" - 12"	■		41257	\$22,496.00
							2" - 12"	■		41258	\$21,878.50
							1¼" - 24"	■		41032	\$23,957.50
							2" - 24"	■		41259	\$23,275.00
	2050	4" - 12"	4" - 30"	12" - 30"	-	5 HP, 220V	4" - 6"	■		41033	POA
2112	1" - 12"	-	-	2" - 8"	½ HP, 110V	1" - 12"	■		41210	POA	
Portable Cut Groover	1000	2" - 8"	-	-	-	1 HP, 115V	2" - 8"			41260	\$10,077.00
		2" - 12"					2" - 12"			41261	\$11,023.00

\*\* Accessories not included, refer to Accessory Table Below.

**Accessories**

Item	Pace Model	Size Range	Capacity	Part No.	List Price	
Pipe Stands	4031	1" - 4"	600 Lbs.	41037	\$514.00	
	4000	2" - 8"	900 Lbs.	41038	\$635.00	
	4033	2" - 14"	1,200 Lbs.	41039	\$795.00	
	4040	12" - 24"	4,000 Lbs.	41040	\$2,017.00	
Nipple Bracket	4037	Fits Model 1021 / 22 / 23 / 2021		-	41035	\$642.50
	4045	4" - 12" Fits Model 1012 / 1112		-	41512	\$534.50
Mounting Feet	4039	Fits Portable Roll Groovers and Model 1000		-	41034	\$162.00
	4046	PA Mounting Feet		-	41013	\$151.00
Porta-Bore	3013	Up to 4¼" Holes in Pipe 1¼" - 12"		-	41049	\$2,653.00

Section 16  
Specialty Items

Section 18  
Grooved Products

Section 19  
CPVC Pipe & Fittings

Section 20  
Miscellaneous

Section 21  
Electrical

Section C  
Valves & Hose Equipment

Section D  
Backflow

Section F  
Pipe & Accessories

Section H  
Hangers

Section J  
Lubricants

Section K  
Misc.

Section 16  
Specialty Items

Section 18  
Grooved Product

Section 19  
CPVC Pipe & Fittings

Section 20  
Miscellaneous

Section 21  
Electrical

Section C  
Valves & Hose Equipment

Section D  
Backflow

Section F  
Pipe & Accessories

Section H  
Hangers

Section J  
Lubricants

Section K  
Misc.

**Roll Selection Chart**

Machine	Pipe	Size	Top		Size	Bottom		Parts	Part Number	List Price
			Part No.	List Price		Part No.	List Price			
1021, 1023, 2021	Sch. 40	1 1/4" - 1 1/2"	41262	\$360.00	1 1/4" - 1 1/2"	41281	\$261.00			
		2" - 3 1/2"	41263	\$314.00	2" - 3 1/2"	41282	\$242.00			
		4" - 6"	41264	\$279.00	4" - 6"	41283	\$366.00			
		8" - 12"	41265	\$279.00	8" - 12"	41284	\$437.00			
	Std. Wall	14" - 16"	41266	\$262.00	14" - 16"	41285	\$480.50			
		18" - 24"	41267	\$262.00	18" - 24"	41286	\$480.50			
	Copper Tube	2" - 8"	41268	\$314.00	2" - 8"	41287	\$242.00	Depth Gauge 4043	41509	\$36.00
1010, 2010	Sch. 10, Sch. 40	1 1/2" - 6"	41269	\$262.00	1 1/2"	41288	\$242.00			
			-	-	2" - 3 1/2"	41289	\$242.00			
			-	-	4" - 6"	41290	\$352.00			
	Sch. 10	8" - 12"	41270	\$262.00	8" - 12"	41291	\$352.00			
1040, 2040	Sch. 40	1" - 1 1/2"	41271	\$215.00	1" - 1 1/2"	41292	\$215.00			
		1" - 6"	41272	\$190.00	1" - 6"	41293	\$180.00			
		2" - 6"	41273	\$215.00	-	-	-			
	Sch. 10	8" - 12"	41274	\$190.00	8" - 12"	41294	\$297.00			
	Copper Tube	2" - 8"	41275	\$191.50	2" - 8"	41295	\$184.00	Depth Gauge 4021	41510	\$36.00
1012, 1112, 2112	Sch. 40	1" - 1 1/2"	41276	\$215.00	1" - 1 1/2"	41296	\$215.00			
		2" - 6"	41277	\$215.00	2" - 6"	41297	\$180.00			
		8" - 12"	41278	\$215.00	8" - 12"	41298	\$299.50			
	Copper Tube	2" - 8"	41506	\$215.00	2" - 8"	41507	\$184.00	Depth Gauge 4021	41510	\$36.00
1021, 1022, 1023, 2021	SS 10 Ga.				2" - 3 1/2"	41299	\$264.50			
					4" - 6"	41500	\$403.00			
					8" - 12"	41501	\$480.50			
					14" - 16"	41504	\$528.00			
					18" - 24"	41505	\$528.00			
1040, 1041, 1112, 2112	SS 10 Ga.				2" - 6"	41502	\$199.00			
					8" - 12"	41503	\$356.00			
1034, 1039	Sch. 40	1 1/4" - 6", w/ brg.	41279	\$50.50				1034 Drive Shaft 1 1/4" - 6"	41511	\$79.00
								1039 Drive Shaft 1 1/4" - 6"	41513	\$100.00
								Depth Gauge 4021	41510	\$36.00
1039	Copper Tube	2" - 8", w/ brg.	41280	\$67.00				Depth Gauge 4021	41510	\$36.00
1066	Copper Tube	2" - 8", w/ brg.	41508	\$67.00				Drive Shaft 2" - 8"	41514	\$79.00
								Depth Gauge 4021	41510	\$36.00

See latest catalog or technical data sheets for specific approvals, listings, and design parameters.  
POA = Price on availability. Prices subject to change without notice.

**Domestic Grooved Couplings – Packaging Quantity**  
(Including Std. and Pre-Lubricated Gaskets)

Nom. Size	#577 Painted		#577 Galvanized & #577 Tri-Seal		#705 Painted		#705 Galvanized & Tri-Seal		#71 Flange Adapter		Size Range	#716 Reducing Coupling	
	Pieces / Carton	Pieces / Crate	Pieces / Carton	Pieces / Crate	Pieces / Carton	Pieces / Crate	Pieces / Carton	Pieces / Crate	Pieces / Carton	Pieces / Crate		Pieces / Carton	Pieces / Crate
1 1/4"	32	384	32	–	32	–	32	–	–	–	2" x 1 1/2"	20	–
1 1/2"	32	384	32	–	32	–	32	–	–	–	2 1/2" x 2"	36	–
2"	–	385	24	–	–	480	28	–	–	210	3" x 2"	12	–
2 1/2"	–	350	20	–	–	350	20	–	–	210	3" x 2 1/2"	9	–
3"	–	240	28	–	–	270	35	–	–	124	4" x 2"	6	–
4"	–	150	20	–	–	175	20	–	–	124	4" x 2 1/2"	6	–
5"	–	120	–	–	–	96	–	96	–	30	4" x 3"	6	–
6"	–	100	–	80	–	80	–	80	–	30	5" x 4"	–	80
8"	–	48	–	48	–	48	–	48	–	30	6" x 4"	–	64
10"	–	24	–	24	–	24	–	24	–	24	6" x 5"	–	64
12"	–	24	–	24	–	20	–	20	–	24	8" x 6"	–	36

**Domestic Grooved Fittings – Packaging Quantity**

Nom. Size	#510 90° Elbow		#501 45° Elbow		#519 Tee		#260 Cap		Nom. Size Range	ADACAP		#40-5 Strap	
	Pieces / Carton	Pieces / Crate	Pieces / Carton	Pieces / Crate	Pieces / Carton	Pieces / Crate	Pieces / Carton	Pieces / Crate		Pieces / Carton	Pieces / Crate	Pieces / Carton	Pieces / Crate
1 1/4"	40	–	45	–	28	–	287	–	1 1/4" x 1 1/2"	–	–	45	–
1 1/2"	27	–	39	–	28	–	210	–	1 1/4" x 3/4"	–	–	45	–
2"	18	–	24	–	24	–	140	–	1 1/4" x 1"	–	–	45	–
2 1/2"	8	–	15	–	10	–	84	–	1 1/2" x 1 1/2"	50	–	45	–
3"	12	–	18	–	12	–	56	–	1 1/2" x 3/4"	50	–	45	–
4"	–	168	–	96	–	46	30	–	1 1/2" x 1"	50	–	45	–
5"	–	105	–	140	–	75	–	392	2" x 1 1/2"	50	–	45	–
6"	–	63	–	90	–	48	–	288	2" x 3/4"	50	–	45	–
8"	–	28	–	48	–	24	–	160	2" x 1"	50	–	45	–
10"	–	15	–	–	–	–	–	96	2 1/2" x 1 1/2"	40	–	40	–
12"	–	8	–	–	–	–	–	63	2 1/2" x 3/4"	40	–	40	–
–	–	–	–	–	–	–	–	–	2 1/2" x 1"	40	–	40	–

Section 16  
Specialty Items

Section 18  
Grooved Products

Section 19  
CPVC Pipe & Fittings

Section 20  
Miscellaneous

Section 21  
Electrical

Section C  
Valves & Hose Equipment

Section D  
Backflow

Section F  
Pipe & Accessories

Section H  
Hangers

Section J  
Lubricants

Section K  
Misc.

Section 16  
Specialty Items

Section 18  
Grooved Product

Section 19  
CPVC Pipe & Fittings

Section 20  
Miscellaneous

Section 21  
Electrical

Section C  
Valves & Hose Equipment

Section D  
Backflow

Section F  
Pipe & Accessories

Section H  
Hangers

Section J  
Lubricants

Section K  
Misc.

Domestic Grooved Fittings – Packaging Quantity				
Nom. Size	#510S Short Pattern 90° Elbow	#519S Short Pattern Tee	Nom. Size Range	#550 Concentric Reducer
	Pieces/Carton	Pieces/Crate		Pieces/Carton
2"	18	30	2 1/2" x 1 1/4"	36
2 1/2"	8	20	2 1/2" x 1 1/2"	36
3"	12	12	2 1/2" x 2"	36
4"	210	46	3" x 1 1/2"	45
6"	78	48	3" x 2"	60
8"	28	24	3" x 2 1/2"	30
-	-	-	4" x 2"	243
-	-	-	4" x 2 1/2"	243
-	-	-	4" x 3"	243
-	-	-	5" x 3"	147
-	-	-	5" x 4"	147
-	-	-	6" x 2"	72
-	-	-	6" x 2 1/2"	72
-	-	-	6" x 3"	72
-	-	-	6" x 4"	216
-	-	-	6" x 5"	216
-	-	-	8" x 3"	80
-	-	-	8" x 4"	80
-	-	-	8" x 5"	1
-	-	-	8" x 6"	1

Grooved Fittings – Pieces Per Carton/Case			
Nom Size	#730 Mechanical Tee	Nom Size	#730 Mechanical Tee (cont.)
2" x 1 1/2"	15	4" x 1 1/2"	12
2" x 3/4"	15	4" x 3/4"	12
2" x 1"	15	4" x 1 1/2"	12
2" x 1 1/4"	26	4" x 1 1/4"	12
2" x 1 1/2"	12	4" x 1 1/2"	12
2 1/2" x 1 1/2"	14	4" x 2"	10
2 1/2" x 3/4"	14	4" x 2 1/2"	10
2 1/2" x 1"	14	4" x 3"	8
2 1/2" x 1 1/4"	32	5" x 2"	8
2 1/2" x 1 1/2"	20	5" x 2 1/2"	8
3" x 1 1/2"	16	6" x 1 1/2"	8
3" x 3/4"	16	6" x 2"	7
3" x 1"	16	6" x 2 1/2"	7
3" x 1 1/4"	18	6" x 3"	6
3" x 1 1/2"	16	6" x 4"	6
3" x 2"	12	8" x 2 1/2"	4
-	-	8" x 3"	4
-	-	8" x 4"	4

See latest catalog or technical data sheets for specific approvals, listings, and design parameters.  
POA = Price on availability. Prices subject to change without notice.

**Global Grooved Couplings – Packaging Quantity**

Nom. Size	#577				#705			
	Pieces / Carton	Cartons / Pallet	Pieces / Pallet	Crate Qty	Pieces / Carton	Pieces / Crate	Pieces / Carton	Pieces / Crate
1 1/4"	26	48	1,248	–	24	48	1,152	–
1 1/2"	32	12	–	384	20	48	960	–
2"	20	48	960	–	16	48	768	–
2 1/2"	16	48	768	–	12	48	576	–
3"	–	–	–	819	–	–	–	520
4"	–	–	–	546	–	–	–	324
5"	–	–	–	120	–	–	–	–
6"	–	–	–	100	–	–	–	165
8"	–	–	–	108	–	–	–	80
10"	–	–	–	24	–	–	–	–
12"	–	–	–	24	–	–	–	–

**Global Grooved Fittings – Packaging Quantity**

Nom. Size	#510 90° Elbow				#501 45° Elbow				#519 Tee				#260 Cap			
	Pieces / Carton	Cartons / Pallet	Pieces / Pallet	Crate Qty	Pieces / Carton	Cartons / Pallet	Pieces / Pallet	Crate Qty	Pieces / Carton	Cartons / Pallet	Pieces / Pallet	Crate Qty	Pieces / Carton	Cartons / Pallet	Pieces / Pallet	Crate Qty
1 1/4"	28	48	1,344	–	54	48	2,592	–	22	48	1,056	–	132	48	6,336	–
1 1/2"	24	48	1,152	–	40	48	1,920	–	18	48	864	–	100	48	4,800	–
2"	13	48	624	–	18	48	864	–	12	48	576	–	64	48	3,072	–
2 1/2"	6	48	288	–	12	48	576	–	4	48	192	–	42	48	2,016	–
3"	4	48	192	–	8	48	384	–	3	48	144	–	24	48	1,152	–
4"	–	–	–	195	–	–	–	315	–	–	–	120	12	48	576	–
6"	–	–	–	68	–	–	–	100	–	–	–	42	3	48	144	–
8"	–	–	–	32	–	–	–	44	–	–	–	18	3	48	144	–
10"	–	–	–	16	–	–	–	18	–	–	–	10	–	–	–	–
12"	–	–	–	8	–	–	–	15	–	–	–	–	–	–	–	–

**Global Grooved Fittings – Packaging Quantity**

Nom. Size	#510S Short Pattern 90° Elbow				#501 45° Elbow				#519S Short Pattern Tee			
	Pieces / Carton	Cartons / Pallet	Pieces / Pallet	Crate Qty	Pieces / Carton	Cartons / Pallet	Pieces / Pallet	Crate Qty	Pieces / Carton	Cartons / Pallet	Pieces / Pallet	Crate Qty
2"	15	48	720	–	12	48	576	–	33	48	1,584	–
2 1/2"	10	48	480	–	6	48	288	–	30	48	1,440	–
3"	8	48	288	–	4	48	192	–	24	48	1,152	–
4"	–	–	–	234	–	–	–	150	10	48	480	–
6"	–	–	–	72	–	–	–	56	3	48	144	–
8"	–	–	–	33	–	–	–	21	2	48	96	–

Section 16  
Specialty Items

Section 18  
Grooved Products

Section 19  
CPVC Pipe & Fittings

Section 20  
Miscellaneous

Section 21  
Electrical

Section C  
Valves & Hose Equipment

Section D  
Backflow

Section F  
Pipe & Accessories

Section H  
Hangers

Section J  
Lubricants

Section K  
Misc.

Section 16 Specialty Items
Section 18 Grooved Product
Section 19 CPVC Pipe & Fittings
Section 20 Miscellaneous
Section 21 Electrical
Section C Valves & Hose Equipment
Section D Backflow
Section F Pipe & Accessories
Section H Hangers
Section J Lubricants
Section K Misc.

See latest catalog or technical data sheets for specific approvals, listings, and design parameters.  
POA = Price on availability. Prices subject to change without notice.

**Customer Service: (800) 558-5236**  
**[www.tyco-fire.com](http://www.tyco-fire.com) & [www.grinnell.com](http://www.grinnell.com)**

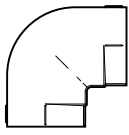
PATHFINDER - 90° Elbow (Slip x Slip)				
	box/bag	size	part no.	list price
	140/20	1"	80026PF	\$17.33

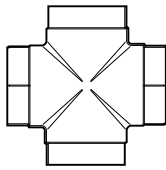
PATHFINDER - Cross (Slip x Slip x Slip x Slip)				
	box/bag	size	part no.	list price
	70/10	1"	80010PF	\$28.00

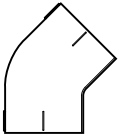
PATHFINDER - 45° Elbow (Slip x Slip)				
	box/bag	size	part no.	list price
	180/20	1"	80051PF	\$14.70

PATHFINDER - Reducing Bushing (Slip x Slip)				
	box/bag	size	part no.	list price
	200/20	1 1/4" x 1"	80202PF	\$11.50

PATHFINDER - Cap (Slip)				
	box/bag	size	part no.	list price
	300/20	1"	80101PF	\$6.35

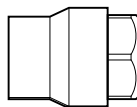
PATHFINDER - Female Adapter w/Brass (Slip x Female)				
	box/bag	size	part no.	list price
	30/6	1"	80145PF	\$71.00

PATHFINDER - Coupling (Slip x Slip)				
	box/bag	size	part no.	list price
	160/20	1"	80076PF	\$11.00

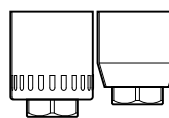
PATHFINDER - Sprinkler Adapter w/Brass (Slip x FIPT)				
	box/bag	size	part no.	list price
	70/10	1" x 1/2" - EAST	80176EPF	\$20.75
	90/10	1" x 1/2" - WEST	80176WPF	\$20.75

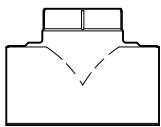
PATHFINDER - Tee (Slip x Slip x Slip)				
	box/bag	size	part no.	list price
	100/10	1"	80001PF	\$21.00

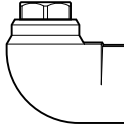
PATHFINDER - Sprinkler 90° Elbow w/Brass (Slip x FIPT)				
	box/bag	size	part no.	list price
	50/10	1" x 1/2"	80198PF	\$24.35

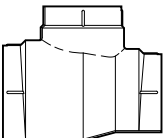
PATHFINDER - Reducing Tee (Slip x Slip x Slip)				
	box/bag	size	part no.	list price
	80/10	1 1/4" x 1" x 1"	80136PF	\$32.55
	60/10	1 1/4" x 1 1/4" x 1"	80262PF	\$32.55
	45/5	1 1/2" x 1 1/2" x 1"	80264PF	\$39.35

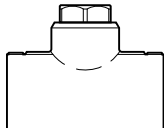
PATHFINDER - Sprinkler Head Tee w/Brass (Slip x FIPT)				
	box/bag	size	part no.	list price
	30/10	1" x 1" x 1 1/2"	80251PF	\$28.85

Refer to Addendum IH-1900B for installation instructions for all PATHFINDER Fittings.

Items shown on this sheet may not be stocked at all Tyco Fire Protection Products warehouses. Ask your local TFP representative for availability. Freight terms may vary for non commonly stocked items. Refer to latest Technical Data Sheets for specific Approvals and Listings, design parameters and available finishes. Prices subject to change without notice.

Section 16  
Specialty Items

Section 18  
Grooved Product

Section 19  
CPVC Pipe & Fittings

Section 20  
Miscellaneous

Section 21  
Electrical

Section C  
Valves & Hose Equipment

Section D  
Backflow

Section F  
Pipe & Accessories

Section H  
Hangers

Section J  
Lubricants

Section K  
Misc.



Section 16  
Specialty Items

Section 18  
Grooved Product

Section 19  
CPVC Pipe & Fittings

Section 20  
Miscellaneous

Section 21  
Electrical

Section C  
Valves & Hose Equipment

Section D  
Backflow

Section F  
Pipe & Accessories

Section H  
Hangers

Section J  
Lubricants

Section K  
Misc.

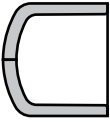
Cap (Slip)				
	box/bag	size	part no.	list price
	225/25	3/4"	<b>80100</b>	\$4.75
	300/20	1"	<b>80101</b>	\$6.05
	60/10	1 1/4"	<b>80102</b>	\$13.00
	30/10	1 1/2"	<b>80103</b>	\$17.75
	20/5	2"	<b>80104</b>	\$22.00
	10/5	2 1/2"	<b>80105</b>	\$60.00
	8/4	3"	<b>80106</b>	\$77.00

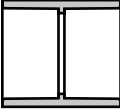
Coupling (Slip x Slip)				
	box/bag	size	part no.	list price
	300/25	3/4"	<b>80075</b>	\$7.10
	160/20	1"	<b>80076</b>	\$9.20
	150/10	1 1/4"	<b>80077</b>	\$13.75
	70/10	1 1/2"	<b>80078</b>	\$19.60
	40/5	2"	<b>80079</b>	\$32.00
	24/4	2 1/2"	<b>80080</b>	\$65.50
	14/2	3"	<b>80081</b>	\$52.10

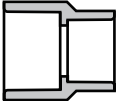
Reducing Coupling (Slip x Slip)				
	box/bag	size	part no.	list price
	280/20	1" x 3/4"	<b>80220</b>	\$30.00

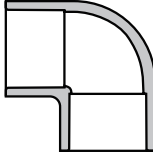
90° Elbow and Reducing Elbow (Slip x Slip)				
	box/bag	size	part no.	list price
	250/25	3/4"	<b>80025</b>	\$7.30
	140/20	1"	<b>80026</b>	\$16.50
	90/10	1 1/4"	<b>80027</b>	\$20.75
	45/5	1 1/2"	<b>80028</b>	\$28.95
	24/4	2"	<b>80029</b>	\$42.35
	15/na	2 1/2"	<b>80030</b>	\$106.00
	9/na	3"	<b>80031</b>	\$124.50
	40/20	1" x 3/4"	<b>80032</b>	\$18.00

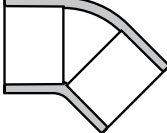
45° Elbow (Slip x Slip)				
	box/bag	size	part no.	list price
	100/25	3/4"	<b>80050</b>	\$9.85
	180/20	1"	<b>80051</b>	\$14.00
	90/15	1 1/4"	<b>80052</b>	\$17.25
	56/7	1 1/2"	<b>80053</b>	\$23.75
	28/4	2"	<b>80054</b>	\$84.50
		2 1/2"	<b>90055</b>	\$82.00
		3"	<b>90056</b>	\$113.00

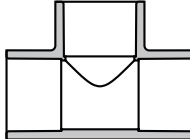
Tee (Slip x Slip x Slip)				
	box/bag	size	part no.	list price
	180/20	3/4"	<b>80000</b>	\$10.25
	100/10	1"	<b>80001</b>	\$20.00
	60/5	1 1/4"	<b>80002</b>	\$31.50
	30/5	1 1/2"	<b>80003</b>	\$43.50
	18/3	2"	<b>80004</b>	\$64.50
	12/na	2 1/2"	<b>80005</b>	\$120.50
	8/na	3"	<b>80006</b>	\$146.00

Refer to IH-1900 for installation instructions for all CPVC products.

Items shown on this sheet may not be stocked at all Tyco Fire Protection Products warehouses. Ask your local TFP representative for availability. Freight terms may vary for non commonly stocked items. Refer to latest Technical Data Sheets for specific Approvals and Listings, design parameters and available finishes. Prices subject to change without notice.

Supersedes 3/4/2011

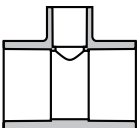
Reducing Tee (Slip x Slip x Slip)				
	box/bag	size	part no.	list price
	40/10	3/4" x 3/4" x 1"	80132	\$17.00
	40/10	1 x 3/4" x 3/4"	80133	\$17.00
	30/10	1 x 3/4" x 1"	80134	\$17.00
	110/10	1" x 1" x 3/4"	80260	\$19.50
	32/8	1 1/4" x 1" x 3/4"	80135	\$31.00
	80/10	1 1/4" x 1" x 1"	80136	\$31.00
	64/8	1 1/4" x 1" x 1 1/4"	80137	\$31.00
	75/5	1 1/4" x 1 1/4" x 3/4"	80261	\$31.00
	60/10	1 1/4" x 1 1/4" x 1"	80262	\$31.00
	12/6	1 1/4" x 1 1/4" x 1 1/2"	80138	\$37.50
	49/7	1 1/2" x 1 1/2" x 3/4"	80263	\$48.00
	45/5	1 1/2" x 1 1/2" x 1"	80264	\$37.50
	30/6	1 1/2" x 1 1/2" x 1 1/4"	80275	\$37.50
	14/7	1 1/2" x 1 1/4" x 3/4"	80140	\$37.50
	42/7	1 1/2" x 1 1/4" x 1"	80141	\$37.50
	24/3	2" x 2" x 3/4"	80265	\$59.25
	24/3	2" x 2" x 1"	80266	\$59.25
	24/3	2" x 2" x 1 1/4"	80274	\$59.25
	21/3	2" x 2" x 1 1/2"	80267	\$59.25
	13/na	2 1/2" x 2 1/2" x 1"	80271	\$115.00
	13/na	2 1/2" x 2 1/2" x 1 1/4"	80272	\$115.00
	13/na	2 1/2" x 2 1/2" x 1 1/2"	80273	\$115.00
	13/na	2 1/2" x 2 1/2" x 2"	80276	\$115.00
	8/na	3" x 3" x 1 1/2"	80270	\$139.00
	8/na	3" x 3" x 2"	80268	\$128.00
	8/na	3" x 3" x 2 1/2"	80269	\$128.00

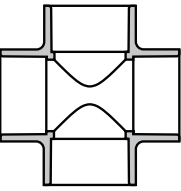
Cross (Slip x Slip x Slip x Slip)				
	box/bag	size	part no.	list price
	40/10	3/4"	80009	\$21.25
	70/10	1"	80010	\$26.00
	40/4	1 1/4"	80011	\$33.00
	20/4	1 1/2"	80012	\$56.00
	12/3	2"	80013	\$68.75
	8/na	2 1/2"	80014	\$133.00
	70/10	1" x 1" x 3/4" x 3/4"	80015	\$28.75

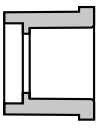
Reducer Bushing (Slip x Slip)				
	box/bag	size	part no.	list price
	150/25	1" x 3/4"	80200	\$5.55
	80/10	1 1/4" x 3/4"	80201	\$10.25
	200/20	1 1/4" x 1"	80202	\$11.00
	50/10	1 1/2" x 3/4"	80203	\$15.25
	180/20	1 1/2" x 1"	80204	\$9.85
	60/10	1 1/2" x 1 1/4"	80205	\$9.85
	30/10	2" x 3/4"	80206	\$25.50
	100/10	2" x 1"	80207	\$34.75
	100/10	2" x 1 1/4"	80208	\$40.00
	30/10	2" x 1 1/2"	80209	\$27.75
	16/4	2 1/2" x 1"	80215	\$58.00
	20/5	2 1/2" x 1 1/4"	80214	\$50.25
	15/5	2 1/2" x 1 1/2"	80213	\$62.50
	20/5	2 1/2" x 2"	80211	\$38.25
	36/4	3" x 2"	80210	\$73.50
	12/6	3" x 2 1/2"	80212	\$54.75

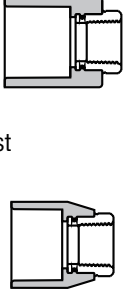
Female Sprinkler Head Adapter (Slip x FIPT) with Brass Threaded Insert				
	box/bag	size	part no.	list price
East	80/10	3/4" x 1/2"	80175E	\$18.80
	80/10	3/4" x 1/2"	80175W	\$18.80
	100/10	3/4" x 1/2"	80175WL	\$18.80
West	70/10	1" x 1/2"	80176E	\$19.75
	90/10	1" x 1/2"	80176W	\$19.75
	40/8	1" x 3/4"	80179	\$41.75

Refer to IH-1900 for installation instructions for all CPVC products.

Items shown on this sheet may not be stocked at all Tyco Fire Protection Products warehouses. Ask your local TFP representative for availability. Freight terms may vary for non commonly stocked items. Refer to latest Technical Data Sheets for specific Approvals and Listings, design parameters and available finishes. Prices subject to change without notice.

Section 16  
Specialty Items

Section 18  
Grooved Product

Section 19  
CPVC Pipe & Fittings

Section 20  
Miscellaneous

Section 21  
Electrical

Section C  
Valves & Hose Equipment

Section D  
Backflow

Section F  
Pipe & Accessories

Section H  
Hangers

Section J  
Lubricants

Section K  
Misc.

Section 16  
Specialty Items

Section 18  
Grooved Product

Section 19  
CPVC Pipe & Fittings

Section 20  
Miscellaneous

Section 21  
Electrical

Section C  
Valves & Hose Equipment

Section D  
Backflow

Section F  
Pipe & Accessories

Section H  
Hangers

Section J  
Lubricants

Section K  
Misc.

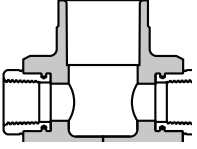
<b>Back-to-Back Tee, Sprinkler Head Adapter (FIPT x FIPT x Slip) with Brass Threaded Inserts</b>				
	box/ bag	size	part no.	list price
	48/6	Back-to-back, Tee, 1/2" x 1/2" x 1" 3-3/8" Takeout	<b>80460</b>	\$79.50
	48/6	Back-to-back, Tee, 1/2" x 1/2" x 1" 3-5/8" Takeout	<b>80459</b>	\$79.50

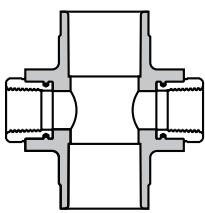
<b>Back-to-Back Cross Sprinkler Head Adapter (Slip x FIPT) with Brass Threaded Inserts</b>				
	box/ bag	size	part no.	list price
	20/5	Back-to-back, Cross, 1" Slip x 1/2" FIPT 3-3/8" Takeout	<b>80462</b>	\$79.50
	20/5	Back-to-back, Cross, 1" Slip x 1/2" FIPT 3-5/8" Takeout	<b>80463</b>	\$79.50

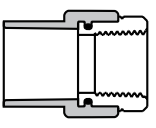
<b>Spigot Sprinkler Head Adapter (Slip x FIPT) with Brass Threaded Insert</b>				
	box/bag	size	part no.	list price
	120/10	3/4" x 1/2" LITE	<b>80177L</b>	\$18.00
	80/10	1" x 1/2"	<b>80178</b>	\$18.00
	56/-	1" x 3/4"	<b>80180</b>	\$41.00

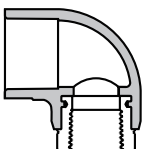
<b>Sprinkler Head 90° Elbow (Slip x FIPT) with Brass Threaded Insert</b>				
	box/bag	size	part no.	list price
	80/10	3/4" x 1/2"	<b>80199</b>	\$19.50
	50/10	1" x 1/2"	<b>80198</b>	\$26.00
	50/10	1" x 3/4"	<b>80196</b>	\$63.25

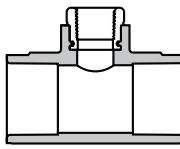
<b>Sprinkler Head Tee (Slip x Female) with Brass Threaded Insert</b>				
	box/bag	size	part no.	list price
	60/10	3/4" x 3/4" x 1/2"	<b>80250</b>	\$26.25
	30/10	1" x 1" x 1/2"	<b>80251</b>	\$34.50
	28/7	1 1/4" x 1 1/4" x 1/2"	<b>80252</b>	\$43.50
	28/7	1 1/4" x 1" x 1/2"	<b>80256</b>	\$44.25
	21/3	1" x 1" x 1"	<b>80249</b>	\$88.50
	24/-	1" x 1" x 1" - Used for Dry Sprinklers	<b>80259</b>	\$80.50
	15/5	1 1/2" x 1 1/4" x 1/2"	<b>80257</b>	\$58.25
	15/5	1 1/2" x 1 1/2" x 1/2"	<b>80254</b>	\$58.25
	12/4	2" x 1 1/2" x 1/2"	<b>80258</b>	\$79.25
	8/4	2" x 2" x 1/2"	<b>80253</b>	\$79.25

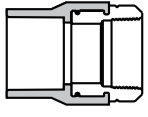
<b>CPVC to Female Adapter (slip x female) with Brass Threaded Insert</b>				
	box/bag	size	part no.	list price
	64/8	3/4"	<b>80142</b>	\$44.50
	30/6	1"	<b>80145</b>	\$67.75
	21/3	1 1/4"	<b>80146</b>	\$107.50
	18/3	1 1/2"	<b>80147</b>	\$139.50
	10/2	2"	<b>80148</b>	POA

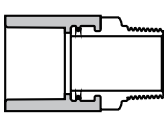
<b>Male Adapter (Slip x Male) with Brass Threaded Insert</b>				
	box/bag	size	part no.	list price
	80/10	3/4"	<b>80157</b>	\$44.25
	40/10	1"	<b>80158</b>	\$52.50

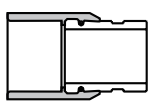
<b>Grooved Coupling Adapter (Groove x Slip)</b>				
	box/bag	size	part no.	list price
	28/4	1 1/4"	<b>80160</b>	\$127.50
	24/3	1 1/2"	<b>80161</b>	\$164.00
	15/3	2"	<b>80162</b>	\$197.50
	9/-	2 1/2"	<b>80163</b>	POA
	5/-	3"	<b>80164</b>	POA

Refer to IH-1900 for installation instructions for all CPVC products.

Items shown on this sheet may not be stocked at all Tyco Fire Protection Products warehouses. Ask your local TFP representative for availability. Freight terms may vary for non commonly stocked items. Refer to latest Technical Data Sheets for specific Approvals and Listings, design parameters and available finishes. Prices subject to change without notice.

Supersedes 3/4/2011

<b>CPVC Pipe</b>						
<i>ft./bundle</i>	<i>size</i>	<i>part no.</i>	<i>length</i>	<i>lift qty. (ft.)</i>	<i>lift wt. (lbs.)</i>	<i>list price/ft.</i>
375	3/4"	<b>80300</b>	15'	7875	1418	\$2.05
250	3/4"	<b>80300T</b>	10'*	5250	945	\$2.05
200	3/4"	<b>80307</b>	8'*	4200	756	\$2.05
240	1"	<b>80301</b>	15'	5040	1320	\$3.15
160	1"	<b>80301T</b>	10'*	3360	880	\$3.15
128	1"	<b>80308</b>	8'*	2688	705	\$3.15
135	1 1/4"	<b>80302</b>	15'	2835	1191	\$4.95
90	1 1/4"	<b>80302T</b>	10'*	1890	794	\$4.95
105	1 1/2"	<b>80303</b>	15'	2205	1186	\$6.85
70	1 1/2"	<b>80303T</b>	10'*	1470	791	\$6.85
60	2"	<b>80304</b>	15'	1260	1063	\$10.05
40	2"	<b>80304T</b>	10'*	840	709	\$10.05
45	2 1/2"	<b>80305</b>	15'	1215	1531	\$15.65
30	2 1/2"	<b>80305T</b>	10' *	810	1020	\$15.65
30	3"	<b>80306</b>	15'	720	1344	\$23.85
20	3"	<b>80306T</b>	10' *	480	896	\$23.85
<b>Technical Data Sheet - TFP1915</b>						

Section 16 Specialty Items
Section 18 Grooved Product
Section 19 CPVC Pipe & Fittings
Section 20 Miscellaneous
Section 21 Electrical
Section C Valves & Hose Equipment
Section D Backflow
Section F Pipe & Accessories
Section H Hangers
Section J Lubricants
Section K Misc.

Refer to IH-1900 for installation instructions for all CPVC products.

Items shown on this sheet may not be stocked at all Tyco Fire Protection Products warehouses. Ask your local TFP representative for availability. Freight terms may vary for non commonly stocked items. Refer to latest Technical Data Sheets for specific Approvals and Listings, design parameters and available finishes. Prices subject to change without notice.

Section 16  
Specialty Items

Section 18  
Grooved Product

Section 19  
CPVC Pipe & Fittings

Section 20  
Miscellaneous

Section 21  
Electrical

Section C  
Valves & Hose Equipment

Section D  
Backflow

Section F  
Pipe & Accessories

Section H  
Hangers

Section J  
Lubricants

Section K  
Misc.

Primers & Cements		
<i>description</i>	<i>part no.</i>	<i>list price</i>
TFP-500 Cement Pt. (one-step)	<b>90740</b>	\$22.50
TFP-500 Cement Qt. (one-step)	<b>90741</b>	\$44.00

Accessories		
<i>description</i>	<i>part no.</i>	<i>list price</i>
CPVC Dauber <sup>3</sup> / <sub>4</sub> "	<b>90401</b>	\$1.85
CPVC Dauber 1 <sup>1</sup> / <sub>2</sub> "	<b>90400</b>	\$1.65

Fire Stop		
<i>description</i>	<i>part no.</i>	<i>list price</i>
BlazeMaster™ Caulk & Walk (10.5 oz. tube)	<b>61126</b>	\$37.00

Rothenberger Tools			
<i>description</i>	<i>size</i>	<i>part no.</i>	<i>list price</i>
Plastic Wheel Cutter	<sup>1</sup> / <sub>4</sub> " - 2 <sup>5</sup> / <sub>8</sub> "	<b>52040</b>	\$255.50
Plastic Wheel Cutter	2" - 5"	<b>52041</b>	\$403.00
Replacement Cutter Wheel	<sup>1</sup> / <sub>2</sub> " - 2 <sup>5</sup> / <sub>8</sub> "	<b>52042</b>	\$62.75
Ratchet Hand Cutter	<sup>1</sup> / <sub>2</sub> " - 2"	<b>52045</b>	\$531.00
Replacement Blade	<sup>1</sup> / <sub>2</sub> " - 2"	<b>52047</b>	\$130.00

Tyco Fire Products CPVC Tools		
<i>description</i>	<i>part no.</i>	<i>list price</i>

Tyco Fire Products CPVC Tools		
Sprinkler Head Adapter Hold-Back Wrench (with two additional chains)	<b>3002</b>	\$198.00
Chain Kit for SHA Hold-Back Wrench (5 chains in Kit)	<b>3011</b>	\$90.25

McNulty Tools		
<i>description</i>	<i>part no.</i>	<i>list price</i>
CPVC Retrofit Pipe Cutting Tool	<b>2667</b>	\$828.50
CPVC Retrofit Deburring Tool	<b>2665</b>	\$314.50
CPVC Retrofit Deburring Tool	<b>2666</b>	\$320.50
CPVC Retrofit Cutting Head	<b>19071100</b>	\$342.00

Reed Tool Manufacturing		
<i>description</i>	<i>part no.</i>	<i>list price</i>
CPVC Tube Cutter, Up to 2" - Model #TC2QPVC	<b>90355</b>	\$293.50
Replacement Blades for CPVC Tube Cutter #TC2QPVC - Model #04184	<b>90356</b>	\$36.00
Deburring Tool, Up to 4" - Model #DEB4	<b>90357</b>	\$192.50
Deburring Tool, Up to 2" - Model #DEB2	<b>91346</b>	\$61.50

Refer to IH-1900 for installation instructions for all CPVC products.

Items shown on this sheet may not be stocked at all Tyco Fire Protection Products warehouses. Ask your local TFP representative for availability. Freight terms may vary for non commonly stocked items. Refer to latest Technical Data Sheets for specific Approvals and Listings, design parameters and available finishes. Prices subject to change without notice.

Supersedes 3/4/2011

**Discontinued Valve Replacement Parts**

The following repair parts are applicable to items that have been discontinued and are no longer available. Although the parts are shown in this catalog, TFPP does not guarantee the availability of the items. The parts shown in this section will be sold as long as they are available. TFPP does not have any plans to continue the production of these discontinued parts.

**Note: All Items Are Non-Returnable**

**Central - 4" Dry Pipe Valve Model "AF" or "AG" (2002)**

<i>Description</i>	<i>Part No.</i>	<i>List Price (each)</i>
Valve Cover	40002000	\$564.50
Cover Bolts (Purchase 6 Units Each)	60003000	\$15.50
Cover Gasket	40004000	\$139.00
Clapper Assembly	40018600	\$2,073.00
Clapper	40018200	\$959.00
Clapper Bushings (Purchase 2 Units Each)	80100800	\$38.50
Clapper Gasket	97602401	\$226.00
Latch	30010000	\$249.50
Latch Spring	30021000	\$43.75
Latch Pin	30023000	\$51.75
Retaining Rings (Purchase 2 Units Each)	30022000	\$38.50
Hex Head Clapper Bolts (Purchase 5 Units Each)	60080000	\$93.50
Hinge Pin	80101020	\$85.25
Clapper Bushings (Purchase 2 Units Each)	81808000	\$38.50
Retaining Plate	97602501	\$172.50

**Central - 6" Dry Pipe Valves Model "AF" or "AG" (2002)**

<i>Description</i>	<i>Part No.</i>	<i>List Price (each)</i>
Valve Cover	60002000	\$621.00
Cover Bolts (Purchase 8 Units Each)	60003000	\$15.50
Cover Gasket	60004000	\$139.00
Clapper	60018200	\$1,126.00
Clapper Bushings (Purchase 2 Units Each)	80100800	\$38.50
Clapper Gasket	60018000	\$249.50
Latch	30010000	\$249.50
Latch Spring	30021000	\$43.75
Latch Pin	30023000	\$51.75
Retaining Rings (Purchase 2 Units Each)	30022000	\$38.50
Hex Head Clapper Bolts (Purchase 6 Units Each)	60080000	\$93.50
Hinge Pin	80101010	\$85.25
Retaining Plate	60018100	\$311.00

**Central - 4" Dry Pipe Valve, Model "H & K" (1988)**

<i>Description</i>	<i>Part No.</i>	<i>List Price</i>
Clapper Gasket	40058000	\$262.00
Cover Gasket	40004000	\$139.00

**Central - 6" Dry Pipe Valve, Model "H & K" (1988)**

<i>Description</i>	<i>Part No.</i>	<i>List Price</i>
Clapper Gasket	60058000	\$262.00
Cover Gasket	60004000	\$139.00

Section 16  
Specialty Items

Section 18  
Grooved Product

Section 19  
CPVC Pipe & Fittings

Section 20  
Miscellaneous

Section 21  
Electrical

Section C  
Valves & Hose Equipment

Section D  
Backflow

Section F  
Pipe & Accessories

Section H  
Hangers

Section J  
Lubricants

Section K  
Misc.

See latest Technical Data Sheets for specific Approvals, Listings, Design Parameters & available finishes.

**Discontinued Valve Replacement Parts**

The following repair parts are applicable to items that have been discontinued and are no longer available. Although the parts are shown in this catalog, TFPP does not guarantee the availability of the items. The parts shown in this section will be sold as long as they are available. TFPP does not have any plans to continue the production of these discontinued parts.

**Note: All Items Are Non-Returnable**

**Central - 2" & 2<sup>1</sup>/<sub>2</sub>" Dry Pipe Valve, Model "D" (1988)**

Description	Part No.	List Price
Clapper Gasket	25058000	\$262.00
Cover Gasket	25004000	\$109.50

**Central - 3" Dry Pipe Valve, Model "D" (1988)**

Description	Part No.	List Price
Clapper Gasket	30058000	\$262.00
Cover Gasket	30004000	\$109.50

**Central - 4" Dry Pipe Valve, Model "D" (1988)**

Description	Part No.	List Price
Clapper Gasket	40058000	\$262.00
Cover Gasket	40004000	\$139.00

**Central - 4" Deluge Valve Model "A" (2001)**

Description	Part No.	List Price
Diaphragm	82401500	\$85.25
Clapper Seal	82402600	\$91.25
Cover Gasket	82400300	\$43.75
Clapper Pin	82402700	\$40.00
Nose Pin	82401200	\$40.00
Clapper Spring	82602400	\$28.75
Lever Spring	82403100	\$28.75
Cap Screw	81611000	\$26.25
Diaphragm Cover	82401600	\$218.50
Diaphragm Piston	82401400	\$205.00
Water Restrictor	82403300	\$629.50

**Central - 6" Deluge Valve Model "A" (2001)**

Description	Part No.	List Price
Diaphragm	82601200	\$85.25
Clapper Seal	82601500	\$91.25
Cover Gasket	82600300	\$43.75
Nose Pin	82600900	\$40.00
Clapper Spring	82602400	\$28.75
Cap Screw	81611000	\$26.25
Diaphragm Cover	82601300	\$218.50
Retaining Ring	82602500	\$128.00
Clapper	82600700	\$929.50
Diaphragm Piston	82601100	\$205.00

See latest Technical Data Sheets for specific Approvals, Listings, Design Parameters & available finishes.



**Discontinued Valve Replacement Parts**

The following repair parts are applicable to items that have been discontinued and are no longer available. Although the parts are shown in this catalog, TFPP does not guarantee the availability of the items. The parts shown in this section will be sold as long as they are available. TFPP does not have any plans to continue the production of these discontinued parts.

**Note: All Items Are Non-Returnable**

**Model DV-3 Deluge Valve (2007)**

Description	Part No.	List Price
<b>Replacement Parts for Model DV-3</b>		
Repair Parts Kit Includes: 1-Diaphragm & 1-Facing	92-445-1-020	\$120.00
Center Valve Assembly Includes: 1-Diaphragm, 1-Diaphragm Ring, 4-Hex Cap Screws, 1-Center Valve, 1-Facing, 1-Facing Retainer & 1-Retainer Screw	92-445-1-021	\$1,379.00
<b>Technical Data Sheet - TFP1350</b>		

**Central - Model F & G Alarm Valve (2003)**

Description	Flanged x Flanged	List Price (each)
<b>Replacement Parts for Model "F" &amp; "G" 2 1/2" and 3" Alarm Valves</b>		
Cover Gasket	81303000	\$43.75
Hinge Pin	81610200	\$85.25
Clapper Assembly	81304001	\$649.00
Clapper	81304000	\$425.50
Clapper Bushings (Purchase 2 Units Each)	81608000	\$33.50
Clapper Gasket	81305000	\$156.50
Inner Retaining Washer	25059000	\$63.25
<b>Replacement Parts for Model "F" &amp; "G" 6" Alarm Valves</b>		
Description	Flanged x Flanged	List Price (each)
Valve Cover	81602000	\$326.50
Cover Gasket	81603000	\$43.75
Clapper Assembly	81604001	\$986.50
Clapper	81604000	\$649.00
Clapper Bushings (Purchase 2 Units Each)	81608000	\$33.50
Clapper Gasket	81605000	\$186.00
Retaining Ring	81606000	\$143.50
Hex Head Cap Screw	81611000	\$26.25
<b>Replacement Parts for Model "F" &amp; "G" 8" Alarm Valves</b>		
Cover Gasket	81803000	\$43.75
Clapper	81804000	\$803.50
Clapper Bushings (Purchase 2 Units Each)	81808000	\$38.50
Clapper Gasket	81805000	\$186.00
Retaining Ring	81806000	\$143.50
Hex Head Cap Screws (Purchase 5 Units Each)	81811000	\$116.00
<b>Technical Data Sheet: Central 7-2.0 (2 1/2", 3"), Central 7-3.0 (4", 6", 8")</b>		

See latest Technical Data Sheets for specific Approvals, Listings, Design Parameters & available finishes.

Section 16  
Specialty Items

Section 18  
Grooved Product

Section 19  
CPVC Pipe & Fittings

Section 20  
Miscellaneous

Section 21  
Electrical

Section C  
Valves & Hose Equipment

Section D  
Backflow

Section F  
Pipe & Accessories

Section H  
Hangers

Section J  
Lubricants

Section K  
Misc.

**Discontinued Valve Replacement Parts**

The following repair parts are applicable to items that have been discontinued and are no longer available. Although the parts are shown in this catalog, TFPP does not guarantee the availability of the items. The parts shown in this section will be sold as long as they are available. TFPP does not have any plans to continue the production of these discontinued parts.

**Note: All Items Are Non-Returnable**

**Model "AF" 2", 2 1/2" and 3" Dry Pipe Valves/Trim (2007)**

Part Number	Size/Model	List Price
<b>Replacement Parts for Model "AF" Dry Pipe Valve</b>		
<b>30004000</b>	Cover Gasket	\$109.50
<b>30018600</b>	3" Clapper Assembly Replacement Kit Including: Clapper, Clapper Bushings (4 Units), Rubber Seal, Retaining Plate, Hex Head Clapper Bolts (5 Units), Latch, Latch Pin, Retaining Rings (2 Units), Latch Spring	\$2,030.00
<b>Technical Data Sheet - Central 10-2.0 (2", 2 1/2"), Central 10-3.2 (3")</b>		

**Gem - Model F-302 & F-3021, 4" Dry Pipe Valve Replacement Parts (2002)**

Description	Part Number	List Price
Auxiliary Clapper Assembly	<b>52-302-1-103</b>	\$788.00
<b>Repair Parts Kit,</b> Including: Clapper Facing, O-Ring #016, O-Ring #111, Auxiliary Clapper Facing, Auxiliary Clapper Spring, Auxiliary Clapper, Chamber Gasket, Handhole Cover Gasket, 1.5 gms of FS3452	<b>92-302-1-416</b>	\$387.50

**Gem - Model F-302 & F-3021, 6" Dry Pipe Valve Replacement Parts (2002)**

Description	Part Number	List Price
Auxiliary Clapper Assembly	<b>52-302-1-103</b>	\$788.00
<b>Repair Parts Kit,</b> Including Clapper Facing, O-Ring #016, O-Ring #111, Auxiliary Clapper Facing, Auxiliary Clapper Spring, Auxiliary Clapper Chamber Gasket, Handhole Cover Gasket, 1.5 gms of FS3452	<b>92-302-1-617</b>	\$414.00

**Gem - Model A-2, 2" Dry Pipe Valve Replacement Parts (1999)**

Description	Part Number	List Price
2" Center Valve Assembly	<b>92-414-1-218</b>	\$2,708.00
Cover O-Ring and Diaphragm Kit	<b>92-414-1-216</b>	\$139.00

See latest Technical Data Sheets for specific Approvals, Listings, Design Parameters & available finishes.

**Discontinued Valve Replacement Parts**

The following repair parts are applicable to items that have been discontinued and are no longer available. Although the parts are shown in this catalog, TFPP does not guarantee the availability of the items. The parts shown in this section will be sold as long as they are available. TFPP does not have any plans to continue the production of these discontinued parts.

**Note: All Items Are Non-Returnable**

**Model B Deluge Valve (2004)**

Description	Part No.	List Price
<b>Replacement Parts for Model "B" Deluge Valve</b>		
Cover	92-020-1-002	\$1,159.00
Center Valve Assembly	92-020-1-014	\$1,375.00
Guide Rod	92-020-1-005	\$165.50
Priming Supply Res. 1/2" w/.125	92-020-1-009	\$215.00
Repair Parts Kit Includes: 1-Body Gasket, 1-Diaphragm & 1-Facing	92-020-1-116	\$175.50
<b>Technical Data Sheet - Gem TD 117A</b>		

**Model DV-1 Deluge Valves (2007)**

Description	Part No.	List Price
<b>Replacement Part Kits for the 4" Model DV-1 Deluge Valve</b>		
(a) <b>Repair Parts Kit</b> Includes: 1-Clapper Facing, 1-Diaphragm, 1-Handhole Cover Gasket	92-470-1-101	\$116.00
(b) <b>Clapper Assembly</b> Includes: 1-Clapper, 1-Clapper Facing, 1-Clapper Facing Retainer, 1-Clapper Hex Bolt, 1-Clapper Hinge Pin	92-470-1-103	\$700.50
(c) <b>Reset Plunger Parts</b> Includes: 1-Reset Bushing O-Ring, 1-Reset Bushing, 1-Reset Plunger O-Ring, 1-Reset Plunger, 1-Reset Knob & 1.5 grams Dow Corning FS3452 Fluorosilicone Grease	92-470-1-105	\$198.50
(d) <b>Diaphragm &amp; Latch Parts Kit</b> Includes: 1-Clapper Latch, 1-Diaphragm Housing Hex Bolt, 1-Diaphragm Retainer, 1-Flange/Push Rod Assembly, 1-Diaphragm, 1-Diaphragm Housing & 1-Latch Hinge Pin	92-470-1-106	\$1,389.00
<b>Replacement Part Kits for the 6" Model DV-1 Deluge Valve</b>		
(a) <b>Repair Parts Kit</b> Includes: 1-Clapper Facing, 1-Diaphragm, 1-Handhole Cover Gasket	92-470-1-102	\$125.00
(b) <b>Clapper Assembly</b> Includes: 1-Clapper, 1-Clapper Facing, 1-Clapper Facing Retainer, 1-Clapper Hex Bolt, 1-Clapper Hinge Pin	92-470-1-104	\$777.00
(c) <b>Reset Plunger Parts</b> Includes: 1-Reset Bushing O-Ring, 1-Reset Bushing, 1-Reset Plunger O-Ring, 1-Reset Plunger, 1-Reset Knob & 1.5 grams Dow Corning FS3452 Fluorosilicone Grease	92-470-1-105	\$198.50
(d) <b>Diaphragm &amp; Latch Parts Kit</b> Includes: 1-Clapper Latch, 1-Diaphragm Housing Hex Bolt, 1-Diaphragm Retainer, 1-Flange/Push Rod Assembly, 1-Diaphragm, 1-Diaphragm Housing & 1-Latch Hinge Pin	92-470-1-107	\$1,434.00
<b>Technical Data Sheet - TFP1330</b>		

Section 16  
Specialty Items

Section 18  
Grooved Product

Section 19  
CPVC Pipe & Fittings

Section 20  
Miscellaneous

Section 21  
Electrical

Section C  
Valves & Hose Equipment

Section D  
Backflow

Section F  
Pipe & Accessories

Section H  
Hangers

Section J  
Lubricants

Section K  
Misc.

See latest Technical Data Sheets for specific Approvals, Listings, Design Parameters & available finishes.

Section 16  
Specialty Items

Section 18  
Grooved Product

Section 19  
CPVC Pipe & Fittings

Section 20  
Miscellaneous

Section 21  
Electrical

Section C  
Valves & Hose Equipment

Section D  
Backflow

Section F  
Pipe & Accessories

Section H  
Hangers

Section J  
Lubricants

Section K  
Misc.

**Discontinued Valve Replacement Parts**

The following repair parts are applicable to items that have been discontinued and are no longer available. Although the parts are shown in this catalog, TFPP does not guarantee the availability of the items. The parts shown in this section will be sold as long as they are available. TFPP does not have any plans to continue the production of these discontinued parts.

**Note: All Items Are Non-Returnable**

**Star - Model E Alarm Check Valve - (1999)**

Description	Part Number	List Price
<b>Star 8" Model E Check Valve Replacement Parts</b>		
<b>Complete Gasket Kit:</b> Including: Cover Gasket (Face Plate Gasket), Rubber Facing (Diaphragm Gasket)	<b>5809</b>	\$235.00

**Star - Model F Alarm Check Valves - (1999)**

Description	Part Number	List Price
<b>Star 4" Model F Check Valve Replacement Parts</b>		
<b>Complete Gasket Kit:</b> Including: Cover Gasket (Face Plate Gasket), Rubber Facing (Diaphragm Gasket), Seal Disc	<b>5807</b>	\$93.50
<b>Star 6" Model F Check Valve Replacement Parts</b>		
<b>Complete Gasket Kit:</b> Including: Cover Gasket (Face Plate Gasket), Rubber Facing (Diaphragm Gasket), Seal Disc	<b>5808</b>	\$235.00

**Star - Model A-1, Dry Pipe Valves (2002)**

Description	Part Number	List Price
<b>4" Model A-1 Dry Pipe Valve Replacement Parts, Flange x Flange</b>		
<b>Complete Gasket Kit:</b> Including: Cover Gasket, Clapper Diaphragm, Seat Ring Gasket	<b>1667-4</b>	\$450.00
<b>6" Model A Dry Pipe Valve Replacement Parts, Flange x Flange</b>		
<b>Complete Gasket Kit:</b> Including: Cover Gasket, Clapper Diaphragm, Seat Ring Gasket	<b>1667-6</b>	\$666.00
<b>Star 4" Model A-1 Dry Pipe Valve Replacement Parts, Flange x Groove</b>		
<b>Complete Kit:</b> Including: Cover Gasket, Clapper Diaphragm, Seat O-Ring (Inner), Seat O-Ring (Outer)	<b>1667-41</b>	\$450.00
<b>Star 6" Model A Dry Pipe Valve Replacement Parts, Flange x Groove</b>		
<b>Complete Kit:</b> Including: Cover Gasket, Clapper Diaphragm, Seat O-Ring (Inner), Seat O-Ring (Outer)	<b>1667-61</b>	\$666.00

See latest Technical Data Sheets for specific Approvals, Listings, Design Parameters & available finishes.

**Discontinued Valve Replacement Parts**

The following repair parts are applicable to items that have been discontinued and are no longer available. Although the parts are shown in this catalog, TFPP does not guarantee the availability of the items. The parts shown in this section will be sold as long as they are available. TFPP does not have any plans to continue the production of these discontinued parts.

**Note: All Items Are Non-Returnable**

**Star - Model F and Model G Dry Pipe Valves -(1985)**

Description	Part Number	List Price
<b>Star 3" Model F and Model G Dry Pipe Valve Replacement Parts</b>		
<b>Complete Gasket Kit:</b> Including: Cover Gasket, Air Seat Disc, Water Seat Disc, Differential Valve Spring, Housing Gaskets (2 Required), Disc Retaining Ring, Differential Valve Disc, O Ring Seal	<b>5801</b>	\$421.00
<b>Star 4" Model F and Model G Dry Pipe Valve Replacement Parts</b>		
<b>Complete Gasket Kit:</b> Including: Cover Gasket, Air Seat Disc, Water Seat Disc, Differential Valve Spring, Housing Gaskets (2 Required), Disc Retaining Ring, Differential Valve Disc, O Ring Seal	<b>5802</b>	\$496.50
<b>Star 6" Model F and Model G Dry Pipe Valve Replacement Parts</b>		
<b>Complete Gasket Kit:</b> Including: Cover Gasket, Air Seat Disc, Water Seat Disc, Differential Valve Spring, Housing Gaskets (2 Required), Disc Retaining Ring, Differential Valve Disc, O-Ring Seal	<b>5803</b>	\$634.00

**Star - Model "A-1" Preaction Valve (2003)**

Description	Part Number	List Price
<b>Replacement Parts - (3" Model "A-1" Preaction/ Water Control Valve)</b>		
<b>Complete Gasket Kit:</b> Including: Cover Gasket, Air Seat Disc, Water Seat Disc, Housing Gasket, Disc Retaining Ring, Differential Valve Disc, O Ring Seal	<b>5971</b>	\$358.50
Differential Plunger Spring	<b>5576</b>	\$30.25
<b>Replacement Parts - (4" Model "A-1" Preaction/ Water Control Valve)</b>		
<b>Complete Gasket Kit:</b> Including: Cover Gasket, Air Seat Disc, Water Seat Disc, Housing Gasket, Disc Retaining Ring, Differential Valve Disc, O Ring Seal	<b>5839</b>	\$460.00
Differential Plunger Spring	<b>5576</b>	\$30.25
<b>Replacement Parts - (6" Model "A-1" Preaction/ Water Control Valve)</b>		
<b>Complete Gasket Kit:</b> Including: Cover Gasket, Air Seat Disc, Water Seat Disc, Housing Gasket, Disc Retaining Ring, Differential Valve Disc, O Ring Seal	<b>5972</b>	\$553.00
Differential Plunger Spring	<b>5576</b>	\$30.25

Section 16	Specialty Items
Section 18	Grooved Product
Section 19	CPVC Pipe & Fittings
Section 20	Miscellaneous
Section 21	Electrical
Section C	Valves & Hose Equipment
Section D	Backflow
Section F	Pipe & Accessories
Section H	Hangers
Section J	Lubricants
Section K	Misc.

See latest Technical Data Sheets for specific Approvals, Listings, Design Parameters & available finishes.

Section 16  
Specialty Items

Section 18  
Grooved Product

Section 19  
CPVC Pipe & Fittings

Section 20  
Miscellaneous

Section 21  
Electrical

Section C  
Valves & Hose Equipment

Section D  
Backflow

Section F  
Pipe & Accessories

Section H  
Hangers

Section J  
Lubricants

Section K  
Misc.

**Discontinued Valve Replacement Parts**

The following repair parts are applicable to items that have been discontinued and are no longer available. Although the parts are shown in this catalog, TFPP does not guarantee the availability of the items. The parts shown in this section will be sold as long as they are available. TFPP does not have any plans to continue the production of these discontinued parts.

**Note: All Items Are Non-Returnable**

**Star - Deluge Valve - (Electromatic Model "D") (2002)**

<i>Description</i>	<i>Part Number</i>	<i>List Price</i>
<b>Replacement Parts - (3" Electromatic Model D Deluge Valve)</b>		
<b>Complete Gasket Kit:</b> Including: Water Seat Disc, Cover Plate Gasket	<b>5785</b>	\$139.00
<b>Replacement Parts - (6" Electromatic Model D Deluge Valve)</b>		
<b>Complete Gasket Kit:</b> Including: Water Seat Disc, Cover Plate Gasket	<b>5786</b>	\$326.50

**Exhauster - Model BB (2006)**

<i>Description</i>	<i>Part Number</i>	<i>List Price</i>
<b>Replacement Parts - Model BB Exhauster</b>		
<b>Complete Gasket Kit</b> Including: Cover Plate Gasket, Clean-Out Plate Gasket, Upper Valve O Ring, Auxiliary Valve Nozzle Gasket, Auxiliary Valve Clapper Disc, Restriction Tube Holder, O Ring, Restriction Tube Diaphragm, Exhauster Valve Disc, Restriction Tube O Ring	<b>5792-01</b>	\$1,323.00
<b>Technical Data Sheet: Star 2-5.2.10</b>		

See latest Technical Data Sheets for specific Approvals, Listings, Design Parameters & available finishes.

**Discontinued Sprinkler Accessories**

The following repair parts are applicable to items that have been discontinued and are no longer available. Although the parts are shown in this catalog, TFPP does not guarantee the availability of the items. The parts shown in this section will be sold as long as they are available. TFPP does not have any plans to continue the production of these discontinued parts.

**Note: All Items Are Non-Returnable**

**Central - A Royal Flush Concealed Ceiling Plate Assembly (2002)**

Description	Part No.	Finish	List Price
135°F or 165°F	833	Brass	\$50.50
135°F or 165°F	831	Chrome	\$50.50
135°F or 165°F	832	Grey White	\$50.50
135°F or 165°F	836	Signal (Bright) White	\$50.50

**Star - Starmist Escutcheons (2002)**

Part Number	Description	List Price
<b>Recessed Starmist Escutcheons, 3/4" NPT (Order Separately)</b>		
1954-02	Chrome	\$9.15
1954-04	White	\$9.15
<b>Recessed Starmist Escutcheons, 1/2" NPT (Order Separately)</b>		
2954-02	Chrome	\$9.15

Section 16  
Specialty Items

Section 18  
Grooved Product

Section 19  
CPVC Pipe & Fittings

Section 20  
Miscellaneous

Section 21  
Electrical

Section C  
Valves & Hose Equipment

Section D  
Backflow

Section F  
Pipe & Accessories

Section H  
Hangers

Section J  
Lubricants

Section K  
Misc.

See latest Technical Data Sheets for specific Approvals, Listings, Design Parameters & available finishes.



**Discontinued Sprinkler Accessories**

The following repair parts are applicable to items that have been discontinued and are no longer available. Although the parts are shown in this catalog, TFPF does not guarantee the availability of the items. The parts shown in this section will be sold as long as they are available. TFPF does not have any plans to continue the production of these discontinued parts.

**Note: All Items Are Non-Returnable**

**TFP PH2, K=5.6, Institutional Pendent, Standard Response Sprinkler (2005)**

50 Box Quantity (33 lbs/box) (SIN TY3290)

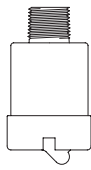
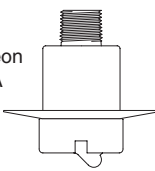
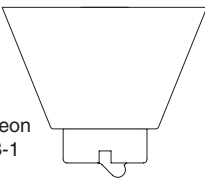
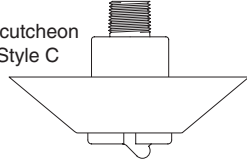
	<i>C.O.</i>	<i>Pendent</i>	<i>Finish</i>	<i>Temperature</i>	<i>Price</i>	
   		<b>51-104-9-165</b>	Chrome	165°F/74°C	\$58.00	
	<b>Order Escutcheon Separately</b>					
			<b>56-012-7-622</b>	Type A, Chrome		\$19.75
			<b>56-001-7-511</b>	Type B-1, Chrome		\$19.75
			<b>56-001-7-513</b>	Type C, Chrome		\$19.75
	<b>Accessories</b>					
			<b>56-000-1-781</b>	Centering Grommet – Model 1781		\$2.90
			<b>56-000-1-780</b>	Retaining Flange – Model 1780		\$34.75
			<b>56-000-1-752</b>	Spacers		\$0.40
	<b>Sprinkler Wrench</b>					
			<b>56-001-5-093</b>	Model 1509-3		\$141.50
	<b>Technical Data Sheet: TFP650</b>					

See latest Technical Data Sheets for specific Approvals, Listings, Design Parameters & available finishes.

Section 16 Specialty Items  
Section 18 Grooved Product  
Section 19 CPVC Pipe & Fittings  
Section 20 Miscellaneous  
Section 21 Electrical  
Section C Valves & Hose Equipment  
Section D Backflow  
Section F Pipe & Accessories  
Section H Hangers  
Section J Lubricants  
Section K Misc.

**Discontinued Sprinkler Accessories**

The following repair parts are applicable to items that have been discontinued and are no longer available. Although the parts are shown in this catalog, TFPP does not guarantee the availability of the items. The parts shown in this section will be sold as long as they are available. TFPP does not have any plans to continue the production of these discontinued parts.

**Note: All Items Are Non-Returnable**

**TFP PH5, K=5.6, Institutional Horizontal Sidewall, Standard Response Sprinkler (2005)**

50 Box Quantity (33 lbs/box) (SIN TY3390)

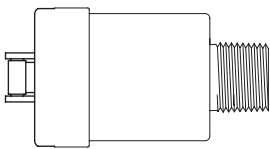
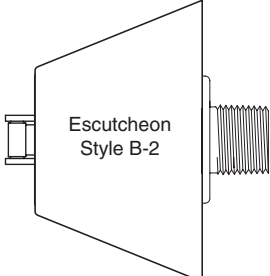
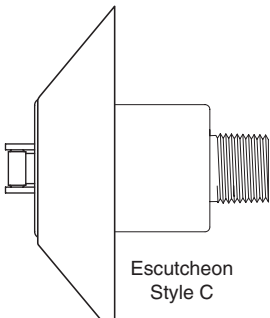
	<i>C.O.</i>	<i>Horizontal Sidewall</i>	<i>Finish</i>	<i>Temperature</i>	<i>Price</i>	
    		<b>51-106-9-165</b>	Chrome	165°F/74°C	\$64.00	
	<b>Order Escutcheon Separately</b>					
		<b>56-001-7-512</b>	Type B-2			\$19.75
		<b>56-001-7-513</b>	Type C, Chrome			\$19.75
	<b>Accessories</b>					
		<b>56-000-1-781</b>	Centering Grommet – Model 1781			\$2.90
		<b>56-000-1-780</b>	Retaining Flange – Model 1780			\$34.75
		<b>56-000-1-752</b>	Spacers			\$0.40
	<b>Sprinkler Wrench</b>					
		<b>56-001-5-093</b>	Model 1509-3			\$141.50
	<b>Technical Data Sheet: TFP654</b>					

Section 16  
Specialty Items

Section 18  
Grooved Product

Section 19  
CPVC Pipe & Fittings

Section 20  
Miscellaneous

Section 21  
Electrical

Section C  
Valves & Hose Equipment

Section D  
Backflow

Section F  
Pipe & Accessories

Section H  
Hangers

Section J  
Lubricants

Section K  
Misc.

See latest Technical Data Sheets for specific Approvals, Listings, Design Parameters & available finishes.

**Discontinued Sprinkler Accessories**

The following repair parts are applicable to items that have been discontinued and are no longer available. Although the parts are shown in this catalog, TFP does not guarantee the availability of the items. The parts shown in this section will be sold as long as they are available. TFP does not have any plans to continue the production of these discontinued parts.

**Note: All Items Are Non-Returnable**

**LFII - Residential Concealed Sprinkler, K=4.2, 1/2" N.P.T. (2010)**

(SIN TY2596)

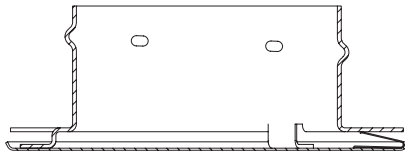
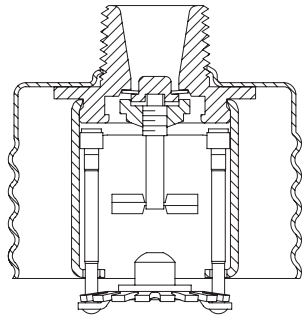

C.O.	Number	Model	Finish	Temperature	List Price
	<b>51-122-1-160</b>	LFII Pendent Sprinkler	Brass	160°F/71°C	POA
<b>Cover Plates (Order Separately)</b>					
▶	<b>56-122-9-135</b>	LFII Cover Plate	Chrome	135°F/57°C	\$22.25
	<b>56-122-0-135</b>	LFII Cover Plate	Grey White	135°F/57°C	\$22.25
▶	<b>56-122-4-135</b>	LFII Cover Plate	Signal (Bright) White	135°F/57°C	\$22.25
▶	<b>56-122-X-135</b>	LFII Cover Plate	Special Order*	135°F/57°C	\$22.25
<b>Sprinkler Wrench</b>					
	<b>56-000-1-265</b>	W-Type 18 Wrench			\$81.00
<b>Notes</b>					
	<b>6012</b>	*Special Order paint match subject to set-up charge. (Net Price)			\$376.50
<b>Technical Data Sheet: TFP412 Design Guide: TFP490</b>					

**LFII - Residential Concealed Sprinkler, K=4.9, 1/2" N.P.T. (2010)**

(SIN TY3596)

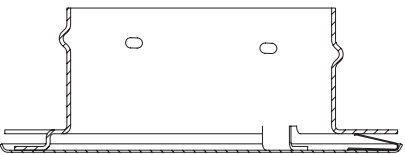
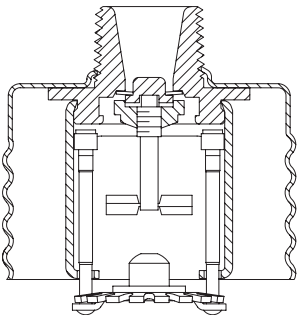

C.O.	Number	Model	Finish	Temperature	List Price
	<b>51-112-1-160</b>	LFII Pendent Sprinkler	Brass	160°F/71°C	POA
<b>Cover Plates (Order Separately)</b>					
▶	<b>56-122-9-135</b>	LFII Cover Plate	Chrome	135°F/57°C	\$22.25
	<b>56-122-0-135</b>	LFII Cover Plate	Grey White	135°F/57°C	\$22.25
▶	<b>56-122-4-135</b>	LFII Cover Plate	Signal (Bright) White	135°F/57°C	\$22.25
▶	<b>56-122-X-135</b>	LFII Cover Plate	Special Order*	135°F/57°C	\$22.25
<b>Sprinkler Wrench</b>					
	<b>56-000-1-265</b>	W-Type 18 Wrench			\$81.00
<b>Notes</b>					
	<b>6012</b>	*Special Order paint match subject to set-up charge. (Net Price).			\$376.50
<b>Technical Data Sheet: TFP442 Design Guide: TFP490</b>					

See latest Technical Data Sheets for specific Approvals, Listings, Design Parameters & available finishes.

Potter Electric		
Description	Part Number	List Price
<b>Waterflow Switches</b>		
VS-SP 1"-1-1/2" WFD (without retard)	2447	\$200.50
VSR-S 1"-2" WFS	24148	\$226.00
VSR-SG	26144	\$265.00
VSR-ST	26145	\$265.00
VSR-F 2" WFD	24110	\$236.50
VSR-F 2 1/2" WFD	24111	\$236.50
VSR-F 3" WFD	24112	\$236.50
VSR-F 3 1/2" WFD	24113	\$236.50
VSR-F 4" WFD	24114	\$236.50
VSR-F 5" WFD	24115	\$236.50
VSR-F 6" WFD	24116	\$236.50
VSR-F 8" WFD	24117	\$267.00
<b>Tamper Switches - OS&amp;Y</b>		
OSYSU-1	2414	\$147.50
OSYSU-2	2412	\$195.50
PTS-C (Plug type)	24100	\$295.50
RBVS Retrofit Ball Valve Switch less Tamper	24882	\$273.50
RBVS Retrofit Ball Valve Switch with Tamper	24883	\$295.50
<b>Tamper Switches - Butterfly/PIV</b>		
PCVS-2 Sets DPDT	2419	\$148.50
<b>Pressure Switches</b>		
PS10-1	25700	\$175.50
PS10-2	25710	\$184.00
PS40-1	25720	\$175.50
PS40-2	25730	\$184.00
<b>Explosion Proof Switches</b>		
VSRF-EX 2"	2489	\$3,163.00
VSRF-EX 2 1/2"	2426	\$3,163.00
VSRF-EX 3"	2396	\$3,163.00
VSRF-EX 4"	2472	\$3,163.00
VSRF-EX 6"	2477	\$3,163.00
VSRF-EX 8"	2478	\$3,422.00
PS10-2A-EX	2471	\$942.00
PS40-2A-EX	2473	\$942.00
OSYSU-EX	2486	\$1,106.00
PIVSU-EX	2487	\$1,106.00
<b>Switches for Copper Systems</b>		
2" VSR-CF	2458	\$398.50
2 1/2" VSR-CF	2459	\$398.50
3" VSR-CF	2394	\$398.50
4" VSR-CF	2484	\$398.50
<b>Electric Bells - 120 Volts A.C.</b>		
6" 120 Volts A.C.	2440	\$64.50
8" 120 Volts A.C.	2441	\$84.50
10" 120 Volts A.C.	2442	\$96.75
<b>Electric Bells - 24 Volts A.C.</b>		
6" 24 Volts A.C.	2387	\$64.50
10" 24 Volts A.C.	2382	\$96.75

Potter Electric		
Description	Part Number	List Price
<b>Weatherproof Back Box</b>		
Weather-proof Back Box	2443	\$34.50
<b>Electric Bells - 12 Volts D.C.</b>		
6" 12 Volts D.C.	2428	\$64.50
10" 12 Volts D.C.	2445	\$96.75
<b>Electric Bells - 24 Volts D.C.</b>		
6" 24 Volts D.C.	2446	\$64.50
10" 24 Volts D.C.	2444	\$96.75
<b>Horns</b>		
120 VAC Strobe Horn, 6117-L	2373	\$218.00
120 VAC, 60 Hz Horn 31T-115-R	2587	\$114.50
Outdoor Back (Box WBB-R); 4	2374	\$30.00
MH-120R 120VAC Mini-Horn Red	25870	\$69.00
MH-120W 120VAC Mini-Horn White	25880	\$69.00
<b>Release Panel</b>		
PFC 4410RC Red	20135	\$2,635.00
PFC 4410RC White	21126	\$1,708.00
<b>Batteries for Release Panel</b>		
8.0 Amp Hour Batteries BT-80	2656	\$79.50
12.0 Amp Hour Batteries BT-120	20128	\$141.00
<b>Corrosion Inhibiting Device</b>		
PAAR (Potter Automatic Air Release)	25100	\$1,889.00

Solenoid Valves		
Description	Part Number	List Price
<b>Ordinary Location</b>		
1/2" Solenoid Valve 110 VAC	52-287-1-110	\$741.50
1/2" Solenoid Valve 24 VDC	52-287-1-024	\$1,147.00
1/2" Solenoid Valve 125 VDC	52-287-1-125	\$770.50
<b>Hazardous Location</b>		
1/2" Explosion-proof Solenoid Valve 110 VAC	52-287-1-210	\$1,092.00
1/2" Explosion-proof Solenoid Valve 24 VDC	52-287-1-224	\$922.50

Potter Heat Detectors		
Description	Part Number	List Price
CR-200W Heat Detector	26590	\$32.50
CF-135W Heat Detector	26600	\$32.50

Horn Strobes		
Description	Part Number	List Price
12V/DC Horn Strobe	2344	\$191.00
120V/AC Horn Strobe	2373	\$218.00
120V/AC Red Mini-Horn Strobe	25870	\$69.00
24V/DC White Mini-Horn Strobe	25880	\$69.00

Section 16  
Specialty Items

Section 18  
Grooved Product

Section 19  
CPVC Pipe & Fittings

Section 20  
Miscellaneous

Section 21  
Electrical

Section C  
Valves & Hose Equipment

Section D  
Backflow

Section F  
Pipe & Accessories

Section H  
Hangers

Section J  
Lubricants

Section K  
Misc.

Section 16  
Specialty Items

Section 18  
Grooved Product

Section 19  
CPVC Pipe & Fittings

Section 20  
Miscellaneous

Section 21  
Electrical

Section C  
Valves & Hose Equipment

Section D  
Backflow

Section F  
Pipe & Accessories

Section H  
Hangers

Section J  
Lubricants

Section K  
Misc.

General Air Products		
Description	Part Number	List Price
<b>Air Compressors: Base Mount – Single Phase</b>		
L200-33-A	50024	\$1,473.00
L290-50-A	50232	\$1,526.00
L365-75-A	50233	\$1,641.00
L425-100-A	50027	\$1,685.00
L620-100-A	50234	\$1,977.00
L900-150-A	50235	\$2,045.00
L1300-300-A	60232	\$2,366.00
L1600-300-A	60234	\$3,724.00
L2000-500-A	60027	\$4,500.00
L2500-500-A	50238	\$4,828.00
<b>Air Compressors: Base Mount – Three Phase</b>		
L200-33-B	50034	\$1,457.00
L290-50-B	50237	\$1,515.00
L365-75-B	50036	\$1,570.00
L425-100-B	50037	\$1,593.00
L620-100-B	50038	\$1,854.00
L900-150-B	50239	\$1,912.00
L1300-300-B	60233	\$2,180.00
L1600-300-B	60235	\$3,879.00
L2000-500-B	60028	\$3,834.00
L2500-500-B	50043	\$4,324.00
<b>Air Compressors: Riser Mounted Oil-Less (Includes Stop - Start)</b>		
OL110-16AC (110 Gallon)	60001	\$1,189.00
OL215-33AC (215 Gallon)	60002	\$1,520.00
OL335-50AC (335 Gallon)	60003	\$1,867.00
OL425V-75AC (425 Gallon)	60004	\$2,082.00
OL610V-100AC (610 Gallon)	60281	\$2,336.00
OL900-150AC (900 Gallon)	60282	\$3,675.00
OL1200V-200AC (1,200 Gallon)	60283	\$4,013.00
<b>Air Compressors: Tank Mounted Oil-Less (Includes Stop - Start)</b>		
OL110-16ACT	60236	\$2,140.00
OL215-33ACT	60237	\$2,473.00
OL335-50ACT	60238	\$2,891.00
OL425V-75ACT	60239	\$3,121.00
OL610V-100ACT	60285	\$3,520.00
OL900-150ACT	60287	\$4,944.00
OL-1200V-200ACT	60288	\$5,330.00
<b>Air Compressors: Tank Mounted Single Phase (Includes Stop - Start)</b>		
LT200-33-A	50047	\$2,492.00
LT290-50-A	50251	\$2,642.00
LT365-75-A	50252	\$2,702.00
LT425-100-A	50050	\$2,738.00
LT620-100-A	50253	\$3,069.00
LT900-150-A	50254	\$3,268.00
LT1300-300-A	60251	\$3,552.00
LT1600-300-A	60253	\$5,537.00
LT2000-500-A	60029	\$5,754.00
LT-2500-500-A	50056	\$6,023.00

General Air Products		
Description	Part Number	List Price
<b>Air Compressors: Tank Mounted Three Phase (Includes Stop - Start)</b>		
LT200-33-B	50057	\$2,691.00
LT290-50-B	50258	\$2,702.00
LT365-75-B	50059	\$2,730.00
LT425-100-B	50060	\$2,724.00
LT620-100-B	50259	\$3,018.00
LT900-150-B	50260	\$3,182.00
LT1300-300-B	60252	\$3,279.00
LT1600-300-B	60254	\$5,410.00
LT2000-500-B	60038	\$5,484.00
LT2500-500-B	50261	\$5,718.00
<b>Magnetic Line Starter - Single Phase (Need HP and Voltage to Order)</b>		
MGOOA	50084	\$538.00
MGXOA	50086	\$603.50
MGO1A	50085	\$685.00
MG15A	50092	\$881.50
<b>Magnetic Line Starter - Three Phase (Need HP and Voltage to Order)</b>		
MGOOB	50075	\$596.50
MGXOB	50093	\$717.50
MGO1B	50094	\$807.50
<b>Riser Mount Kits - Universal Bracket</b>		
RMK 16150	50082	\$90.75
<b>Dry Air Pacs - F.O.B. Factory Direct (Need Voltage to Order)</b>		
DAP500A	50264	\$17,920.00
DAP500B	50265	\$17,697.00
DAP1000B	50267	\$19,256.00
DAP2000B	50269	\$20,702.00
<b>Dry Air Pacs - Maintenance Kits F.O.B. Factory Direct (Need Voltage to Order)</b>		
KSMB01	60243	\$349.50
KAMA01	60244	\$943.50
<b>Accessories</b>		
AD3400 Desiccant Dryer	50076	\$594.50
34006 Desiccant Replacement	60010	\$161.00
F3500 Coalescing Filter	50077	\$374.50
Vibration Pad (4 Pack)	50078	\$127.00
SWP60302 Pressure Switch	60245	\$196.00
DVA-2T Electric Drain Valve	60246	\$431.00
P1202MP Flex Hose	60247	\$153.00
VR3P25080 Relief Valve	60248	\$93.25
APC01Q Air Comp. Oil	60249	\$11.50

See latest Technical Data Sheets for specific Approvals, Listings, Design Parameters & available finishes.



**Thermocable LHD - Linear Heat Detection Wire  
PVC Jacket (Vinyl)**

Description	Part Number	List Price			
		100 -499 ft	500-4,999 ft ft	5,000-9,999	10,000
155°F / 68°C Red	<b>TC155</b>	\$3.70/ft	\$3.30/ft	\$3.15/ft	\$2.95/ft
155°F / 68°C Red with GuideWire*	<b>TC155G</b>	\$3.80/ft	\$3.70/ft	\$3.55/ft	\$3.25/ft
172°F / 78°C Red	<b>TC172</b>	\$3.70/ft	\$3.30/ft	\$3.15/ft	\$2.95/ft
172°F / 78°C Red with GuideWire*	<b>TC172G</b>	\$4.00/ft	\$3.70/ft	\$3.55/ft	\$3.25/ft

**Notes:**

\*GuideWire should be installed using eyebolts for support every 15 feet (4.5m) to 20 feet (6.0m).  
ThermoCable with GuideWire is only available in 500' spool lengths.

**Mounting Straps  
Temperatures -40°F to 185°F (-40°C to 85°C)**

Description	Part Number	List Price	Qty.
Single Loop	<b>TC1018C</b>	\$126.50	pack (100)
For use with Surface Mount TC1017C	<b>TC1018M</b>	\$882.50	pack (1000)
<b>Single Loop</b> , Fits 4" to 6" (10cm to 15cm) Sprinkler Pipe	<b>TC1029L</b>	\$158.00	pack (50)
<b>Double Loop</b> , Fits 3/4" to 2" (2cm to 5cm) Sprinkler Pipe	<b>TC1027C</b>	\$151.50	pack (100)
	<b>TC1027M</b>	\$945.50	pack (1000)
<b>Double Loop</b> , Fits 2-1/2" to 3-1/2" (6cm to 8.9cm) Sprinkler Pipe	<b>TC1028M</b>	\$1,260.00	pack (1000)

**Notes:**

ThermoCable must be secured every 3 to 5 feet (1 to 1.5m), or 15 to 20 feet (4.5 to 6m) for installations using GuideWire

Section 16  
Specialty Items

Section 18  
Grooved Product

Section 19  
CPVC Pipe & Fittings

Section 20  
Miscellaneous

Section 21  
Electrical

Section C  
Valves & Hose Equipment

Section D  
Backflow

Section F  
Pipe & Accessories

Section H  
Hangers

Section J  
Lubricants

Section K  
Misc.

Section 16  
Specialty Items

Section 18  
Grooved Product

Section 19  
CPVC Pipe & Fittings

Section 20  
Miscellaneous

Section 21  
Electrical

Section C  
Valves & Hose Equipment

Section D  
Backflow

Section F  
Pipe & Accessories

Section H  
Hangers

Section J  
Lubricants

Section K  
Misc.

<b>Mounting Clips and Clamps Temperatures -40°F to 185°F (-40°C to 85°C)</b>			
<i>Description</i>	<i>Part Number</i>	<i>List Price</i>	<i>Qty.</i>
<b>Cable Clip, Nylon 6.6</b> -3/16" (4.8mm) mounting hole	<b>TC1012C</b>	\$100.75	pack(100)
	<b>TC1012M</b>	\$756.50	pack(1000)
<b>Push Pin</b> -Secures through 3/16" (4.8mm) mounting hole Secures Cable Clip TC1012 to Beam Clamps and Cable Tray Mounting Clips	<b>TC1034Q</b>	\$31.50	pack(25)
<b>Cable Clip, Zinc Plated</b> , 1/4"± (6.4mm) mounting hole	<b>TC1013C</b>	\$31.50	pack(100)
Beam Clamp, Spring Steel Designed for material thickness up to 1/2" (12.7mm) TC1012 Cable Clip and TC1030 Push Pin required for installation	<b>TC1014C</b>	\$315.50	pack(100)
Beam Clamp, Zinc Plated Steel Designed for material thickness up to 7/8" (22mm) TC1012 Cable Clip and TC1030 Push Pin required for installation	<b>TC1015L</b>	\$189.50	pack(50)
L-Bracket Designed for floating roof tank applications TC1012 Cable Clip and TC1030 Push Pin required for installation	<b>TC1016</b>	\$8.80	each
<b>Cable Tray Mounting Clip</b> , For mounting to 3/16" (4.8mm) thick material	<b>TC1020C</b>	\$239.50	pack(100)
Cable Tray Mounting Clip For material thickness of 1/16" to 5/32" (1.6mm to 4mm) For material thickness of 5/32" to 1/4" (4mm to 6.4mm) TC1012 Cable Clip and TC1030 Push Pin required for installation	<b>TC1021C</b> <b>TC1022C</b>	\$252.50 \$252.50	pack(100) pack(100)
Universal Mounting Clip For material thickness 1/8" to 1/4" thick (3.2mm to 6.4mm) For material thickness 5/16" to 1/2" thick (7.9mm to 12.7mm) TC1012 Cable Clip and TC1030 Push Pin required for installation	<b>TC1023C</b> <b>TC1024C</b>	\$315.50 \$315.50	pack(100) pack(100)

<b>GuideWire Mounting Accessories</b>			
<i>Description</i>	<i>Part Number</i>	<i>List Price</i>	<i>Qty.</i>
<b>Threaded Eyebolt - Zinc Plated Steel</b> , 1/4"-20, with one nut (6.4mm) Use to support ThermoCable every 15 to 20 feet (4.5m to 6m) -250 ft. maximum TC1031ZC Lock Nut and TC1032C Insulated Grommet required for installation	<b>TC1030ZX</b>	\$25.25	pack(10)
Zinc Plated Lock Nut	<b>TC1031ZC</b>	\$19.00	pack(100)
<b>Threaded Eyebolt - Stainless Steel</b> , 1/4"-20 with one nut (6.4mm) Use to support ThermoCable every 15 to 20 feet (4.5m to 6m) -250 ft. maximum TC1031SSC Lock Nut and TC1032C Insulated Grommet required for installation	<b>TC1030SS</b>	\$6.30	each
Stainless Steel Lock Nut	<b>TC1031SSC</b>	\$50.50	pack(100)
<b>Insulating Grommet</b> , Black Rubber	<b>TC1032C</b>	\$40.50	pack(100)
Turnbuckle - Zinc For GuideWire installations	<b>TC1033Z</b>	\$6.95	each
<b>Turnbuckle - Stainless Steel</b> (Aluminum Body) For GuideWire installations	<b>TC1033SS</b>	\$15.25	each

See latest Technical Data Sheets for specific Approvals, Listings, Design Parameters & available finishes.



Surface Mounting			
DESCRIPTION	Part Number	List Price	Qty.
Surface Mount For use with TC1018 Cable Tie and TC1019 Adhesive	<b>TC1017C</b>	\$126.50	pack(100)
Surface Mount Adhesive For use with Surface Mount TC1017C	<b>TC1019</b>	\$25.25	each

Installation			
DESCRIPTION	Part Number	List Price	Qty.
Spare Installation Spool, 500' (150m)	<b>TC1100S</b>	\$15.25	each
Spare Installation Spool, 1500' (450m)	<b>TC1100L</b>	\$19.00	each
Cable Dispensing Reel	<b>TC1011</b>	\$252.50	each

Cable Connecting Accessories			
DESCRIPTION	Part Number	List Price	Qty.
<b>J -Box / ELR -Box</b> , Dim. 4" x 4" x 2" (10cm x 10cm x 5cm) NEMA 4X Moisture Proof Standard Junction Box End of line resistor supplied with panel by manufacturer Requires Screw Terminal (TC1005X)	<b>TC1000</b>	\$37.75	each
<b>HDJ -Box / HDEL R -Box</b> , Dim. 6" x 6" x 4" (15cm x 15cm x 10cm) NEMA 4X Moisture Proof Heavy Duty Junction Box End of line resistor supplied with panel by manufacturer Requires Screw Terminal (TC1005X)	<b>TC1002</b>	\$176.50	each
<b>Screw Terminal</b> , 2 Point, Must be used for all connections in TC1000 and TC1002	<b>TC1005X</b>	\$15.25	pack (10)
<b>Backplate</b> -Fits HDJ-Box / HDEL R-Box For mounting Test Switch and Screw Terminal.	<b>TC1003</b>	\$25.25	each
<b>Test Switch</b> -Attaches to Backplate (TC1003) in HDJ-Box/HDEL R-Box (TC1002) For end of line testing of linear heat detection systems.	<b>TC1004</b>	\$19.00	each
Cable Strain Relief Connector Required for securing ThermoCable penetrations through wall of J-Box/ELR-Box and HDJ-Box/HDEL R-Box.	<b>TC100</b>	\$12.75	each

Section 16	Specialty Items
Section 18	Grooved Product
Section 19	CPVC Pipe & Fittings
Section 20	Miscellaneous
Section 21	Electrical
Section C	Valves & Hose Equipment
Section D	Backflow
Section F	Pipe & Accessories
Section H	Hangers
Section J	Lubricants
Section K	Misc.

See latest Technical Data Sheets for specific Approvals, Listings, Design Parameters & available finishes.

Section 16 Specialty Items
Section 18 Grooved Product
Section 19 CPVC Pipe & Fittings
Section 20 Miscellaneous
Section 21 Electrical
Section C Valves & Hose Equipment
Section D Backflow
Section F Pipe & Accessories
Section H Hangers
Section J Lubricants
Section K Misc.

<b>Cable Splicing Accessories</b>			
<i>DESCRIPTION</i>	<i>Part Number</i>	<i>List Price</i>	<i>Qty.</i>
Screw Terminal, 2 Point, Must be used for all splices	<b>TC1005X</b>	\$15.25	pack (10)
Sealant Tape, Must be used for all splices	<b>TC1006</b>	\$22.75	Roll
Splicing Tape, White	<b>TC1007</b>	\$12.75	Roll
Splicing Tape, Red	<b>TC1008</b>	\$12.75	Roll
Splicing Tape, Blue	<b>TC1009</b>	\$12.75	Roll
Low Temperature Splicing Tape, Black	<b>TC1010</b>	\$12.75	Roll

<b>Fire Alarm Control / Releasing Panel - Modules</b>			
<i>DESCRIPTION</i>	<i>Part Number</i>	<i>List Price</i>	<i>Qty.</i>
Class A Initiating Device Module	<b>TC4402</b>	\$63.00	each
Converts 2 Class B Initiating Circuits to 2 Class A Initiating Circuits			
Class A Indicating Appliance Circuit Module	<b>TC4401</b>	\$139.00	each
Converts 1 Class B Annunciating Circuit to 1 Class A Annunciating Circuits			
<b>Auxiliary Relay Module</b> (24 VDC, DPST)	<b>TC4403</b>	\$170.50	each
<b>Auxiliary Relay Module</b> (24 VDC, DPDT)	<b>TC4404</b>	\$227.00	each
<b>Intrinsic Safety Barrier</b> , Special Hazard Applications	<b>TC4406</b>	\$731.00	each
1 per Zone, 35mm DIN Rail Mounting			

See latest Technical Data Sheets for specific Approvals, Listings, Design Parameters & available finishes.

<b>Kennedy Valves</b>		
<i>Description</i>	<i>Part Number</i>	<i>List Price</i>
<b>O.S.&amp;Y. Gate Valve UL/FM Resilient Wedge w/3/4" Tap and Plug - Model #4068A</b>		
2 1/2"	2265	\$795.00
3"	2266	\$919.00
4"	2267	\$1,066.00
6"	2269	\$1,550.00
8"	2268	\$2,546.00
10"	2264	\$4,163.00
12"	2259	\$5,387.00
<b>O.S.&amp;Y. Valve Flanged x Grooved - Model #7092A</b>		
2 1/2"	22650	\$795.00
3"	22660	\$919.00
4"	22670	\$1,066.00
6"	22690	\$1,550.00
8"	22680	\$2,544.00
<b>O.S.&amp;Y. Valve Grooved x Grooved - Model #7093A</b>		
2 1/2"	22651	\$795.00
3"	22661	\$919.00
4"	22671	\$1,066.00
6"	22691	\$1,550.00
8"	22681	\$2,544.00
<b>Grooved Check Valve - Model #426</b>		
2 1/2"	21215	\$655.00
3"	21216	\$719.00
4"	21218	\$876.00
6"	21217	\$1,281.00
8"	20592	\$1,818.00
<b>Iron Body Swing Check Valves UL/FM Flanged 175 PSI - Model 126A</b>		
2 1/2"	21221	\$1,146.00
3"	21223	\$1,293.00
4"	21224	\$1,716.00
6"	21226	\$2,743.00
8"	21227	\$4,572.00
10"	21228	\$7,540.00
12"	21229	\$10,820.00
<b>Wafer Check Valves UL/FM 300 PSI - Model 706</b>		
4"	21000	\$655.00
6"	21020	\$1,130.00
8"	21040	\$1,892.00
<b>Flanged PIV Non Rising Stem Gate Valve Resilient Wedge - Model 4701</b>		
4"	20504	\$826.00
6"	20506	\$1,287.00
8"	20508	\$2,091.00
10"	20509	\$3,556.00
<b>#01G - Grooved BFV</b>		
2 1/2"	322260	\$736.00
3"	322310	\$788.00
4"	322410	\$843.00
6"	322610	\$1,260.00
8"	322810	\$1,837.00

<b>Kennedy Valves</b>		
<b>#01G - Wafer BFV</b>		
2 1/2"	322110	\$691.00
3"	322130	\$763.00
4"	322140	\$850.00
6"	322160	\$1,117.00
8"	322180	\$1,645.00
<i>Description</i>	<i>Part Number</i>	<i>List Price</i>
<b>PIV, NRS Gate Valve UL/FM Mechanical Joint w/Accessories Resilient Wedge - Model 4071</b>		
4"	20514	\$904.00
6"	20516	\$1,331.00
8"	20518	\$2,792.00
10"	20520	\$3,618.00
12"	20521	\$5,960.00
<b>Wall Post Indicator Model 641-13 Includes Stem and Coupling</b>		
Wall Post Indicator	20810	\$1,081.00
Wall Post Handwheel	20809	\$427.00
<b>Vertical Post Indicator (Formerly Model #741)</b>		
Model #2945B	20811	\$1,608.00
Model #2945C	20820	\$1,608.00
P.I. Wrench	20510	\$193.00

<b>Babbitt Valve Chainwheels</b>			
<b>Cast Iron Standard Chainwheel</b>			
<i>Item No.</i>	<i>Size</i>	<i>Part Number</i>	<i>List Price</i>
0	2" to 4"	5036	\$172.00
1	4 1/4" to 5 3/4"	5037	\$250.00
1.5	6" to 7 1/2"	5031	\$303.00
2	7 3/4" to 9"	5038	\$400.00
2.5	9 1/4" to 12 1/2"	5039	\$574.00
3	12 3/4" to 15 1/2"	5040	\$667.00
3.5	15 3/4" to 19"	5041A	\$1,010.00
4	19 1/4" to 22"	5042	\$1,362.00
4.5	22 1/2" to 26"	5043	\$1,975.00
5	26 1/4" to 30"	5044	\$2,440.00

<b>Epoxy Coated Corrosion Resistant Chainwheel</b>			
<i>Item No.</i>	<i>Size</i>	<i>Part Number</i>	<i>List Price</i>
0	2" to 4"	5025	\$373.00
1	4 1/4" to 5 3/4"	5026	\$599.00
1.5	6" to 7 1/2"	5027	\$766.00
2	7 3/4" to 9"	5028	\$940.00
2.5	9 1/4" to 12 1/2"	5033	\$1,216.00
3	12 3/4" to 15 1/2"	5034	\$1,500.00
3.5	15 3/4" to 19"	5035	\$1,850.00

<b>Hot Dipped Galvanized Standard Chain</b>				
<i>Item No.</i>	<i>Chain Trade Size</i>	<i>Chain Operator Number</i>	<i>Part Number</i>	<i>List Price</i>
0	#2	#0	5029	\$4.00
1 to 2	#1/0	#1, 1 1/2, 2	5030	\$5.00
2.5 to 3.5	#4/0	#2 1/2, 3, 3 1/2	5032	\$7.00

Section 16  
Specialty Items

Section 18  
Grooved Product

Section 19  
CPVC Pipe & Fittings

Section 20  
Miscellaneous

Section 21  
Electrical

Section C  
Valves & Hose Equipment

Section D  
Backflow

Section F  
Pipe & Accessories

Section H  
Hangers

Section J  
Lubricants

Section K  
Misc.

See latest Technical Data Sheets for specific Approvals, Listings, Design Parameters & available finishes. Sprinkler heads & escutcheons are priced separately unless otherwise noted. Items marked "C.O." are made to order and may require longer delivery times.

Section 16	Specialty Items
Section 18	Grooved Product
Section 19	CPVC Pipe & Fittings
Section 20	Miscellaneous
Section 21	Electrical
Section C	Valves & Hose Equipment
Section D	Backflow
Section F	Pipe & Accessories
Section H	Hangers
Section J	Lubricants
Section K	Misc.

United Brass Bronze Valves		
Description	Part Number	List Price
<b>Globe Valves</b>		
3-Way 1/4"	2228	\$20.00
1/2" Globe	2222	\$30.00
3/4" Globe	2223	\$38.00
1" Globe	2224	\$51.00
1 1/4" Globe	2225	\$82.00
1 1/2" Globe	2226	\$118.00
2" Globe	2227	\$168.00
<b>Swing Checks</b>		
1/2"	2240	\$33.00
3/4"	2241	\$38.00
1"	2242	\$52.00
1 1/4"	2243	\$74.00
1 1/2"	2244	\$111.00
2"	2245	\$125.00
<b>Ball Valves</b>		
1/2"	2280	\$37.00
3/4"	2281	\$56.00
1"	2284	\$71.00
1 1/4"	2296	\$116.00
1 1/2"	2276	\$145.00
2"	2262	\$192.00
<b>Angle Valves</b>		
1/2"	2202	\$32.00
3/4"	2203A	\$36.00
1"	2204A	\$54.00
1 1/4"	2205A	\$88.00
1 1/2"	2206A	\$119.00
2"	2207	\$143.00
<b>OS&amp;Y Valves</b>		
1"	2272	\$227.00
1 1/4"	2273	\$258.00
1 1/2"	2274	\$335.00
2"	2275	\$438.00

Milwaukee Butterball Valves		
Description	Part Number	List Price
<b>Valve with two (2) tamper switches</b>		
1" BBSCS02	51009	\$328.00
1 1/4" BBSCS02	51010	\$349.00
1 1/2" BBSCS02	51011	\$417.00
2" BBSCS02	51012	\$500.00
2" BBVSCS02 Grooved	51021	\$536.00
2 1/2" BBSCS02	51013	\$649.00
2 1/2" BBVSCS02 Grooved	51018	\$667.00
Supervisory Switch Kit (2) Circuits	51015	\$170.00
<b>Valve only</b>		
1" BBSC100	51008	\$292.00
1 1/4" BBSC100	51006	\$296.00
1 1/2" BBSC100	51004	\$398.00
2" BBSC100	51002	\$504.00
2" BBVSC100 Grooved	51019	\$511.00
2 1/2" BBSC100	50999	\$825.00
2 1/2" BBVSC100 Grooved	51016	\$887.00

Trim Valves		
Description	Part Number	List Price
<b>Globe Valves</b>		
3-Way 1/4"	41320	\$14.00
1/2" Globe	41321	\$20.00
3/4" Globe	41322	\$24.00
1" Globe	41323	\$35.00
1 1/4" Globe	41324	\$52.00
1 1/2" Globe	41325	\$78.00
2" Globe	41326	\$115.00
<b>Swing Checks</b>		
1/2"	41333	\$25.00
3/4"	41334	\$30.00
1"	41335	\$50.00
1 1/4"	41336	\$72.00
1 1/2"	41337	\$102.00
2"	41338	\$124.00
<b>Ball Valves</b>		
1/2"	41302	\$12.00
3/4"	41303	\$18.00
1"	41304	\$29.00
1 1/4"	41305	\$48.00
1 1/2"	41306	\$65.00
2"	41307	\$91.00
<b>Angle Valves</b>		
1/2"	41327	\$25.00
3/4"	41328	\$30.00
1"	41329	\$53.00
1 1/4"	41330	\$75.00
1 1/2"	41331	\$97.00
2"	41332	\$133.00

\*See latest Technical Data Sheets for specific Approvals, Listings, Design Parameters & available finishes. Sprinkler heads & escutcheons are priced separately unless otherwise noted. Items marked "C.O." are made to order and may require longer delivery times.

<b>Hose Valves &amp; FDC's</b>		
<i>Description</i>	<i>Part Number</i>	<i>List Price</i>
<b>Hose Valves</b>		
1 1/2" FT X FT Angle	<b>22450</b>	\$106.50
1 1/2" FT X MT Angle	<b>22460</b>	\$106.50
2 1/2" FT X FT Angle	<b>22451</b>	\$233.50
2 1/2" FT X MT Angle	<b>22461</b>	\$230.50
1 1/2" Cap with Brass Chain	<b>41205</b>	\$23.25
2 1/2" Cap with Brass Chain	<b>41204</b>	\$29.25
2 1/2"x1 1/2" Brass Reducing Adapter	<b>41206</b>	\$43.50
<b>STORZ Equipment</b>		
STORZ 4" x 4" Straight FDC (import)	<b>61232</b>	\$178.00
STORZ 4" x 5" Straight FDC (import)	<b>61242</b>	\$316.00
STORZ 4" x 4" w/ 30-degree Elbow (import)	<b>61233</b>	\$316.00
STORZ 4" x 5" w/ 30-degree Elbow (import)	<b>61243</b>	\$364.50
STORZ 4" Cap with Chain (import)	<b>61234</b>	\$180.50
STORZ 5" Cap with Chain (import)	<b>61244</b>	\$250.00
STORZ 4" x 4" Straight Connection Kit (import)	<b>61231</b>	\$500.50
STORZ 4" x 5" Straight Connection Kit (import)	<b>61241</b>	\$607.50
STORZ 4" x 4" 30-degree Connection Kit (import)	<b>61251</b>	\$605.00
STORZ 4" x 5" 30-degree Connection Kit (import)	<b>61261</b>	\$675.00
<b>Fire Department Connections</b>		
Fire Dept (Alum.) Sign Round	<b>2503</b>	\$14.50
Fire Dept (Alum.) Sign Rect. 8" x 4" (straight) 4" x 2 1/2"	<b>22441</b>	\$16.75
(90° Angle) 4" x 2 1/2"	<b>2501</b>	\$209.50
Red Plastic Caps w/ Bolt & Nut (pair)	<b>2505</b>	\$223.50
Aluminum Caps w/ Bolt & Nut (pair)	<b>2502A</b>	\$17.00
	<b>2504</b>	\$9.80
<b>Residential Fire Dept Connections</b>		
1 1/2" Residential Fire Dept Connection	<b>2509</b>	\$79.75

<b>Crocker Standpipe and Hose Equipment</b>		
<i>Description</i>	<i>Part Number</i>	<i>List Price</i>
<b>Hose Rack Units</b>		
#3010 1 1/2" x 100' Less Nozzle	<b>51290</b>	\$695.50
<b>Adjustable Fog Nozzles</b>		
#3460 1 1/2" Brass	<b>2745</b>	\$72.50
#3464 2 1/2" Brass	<b>27450</b>	\$248.00

<b>Crocker Standpipe and Hose Equipment</b>		
<i>Description</i>	<i>Part Number</i>	<i>List Price</i>
<b>Fire Hose</b>		
#3401, 1 1/2" 500 PSI Rack Hose Coupled		
100'	<b>2760</b>	\$265.00
#3405, 1 1/2" 300 PSI Single Jacket Coupled		
75'	<b>27610</b>	\$336.50
100'	<b>27620</b>	\$407.50
Fire Hose Reel		P.O.A.
<b>Hose Valves</b>		
#5020 1 1/2" Angle Valve, Female x Female	<b>27910</b>	P.O.A.
#5010 1 1/2" Angle Valve, Female x Male	<b>27920</b>	P.O.A.
#5025 2 1/2" Angle Valve, Female x Female	<b>27930</b>	P.O.A.
#5015 2 1/2" Angle Valve, Female x Male	<b>27940</b>	P.O.A.
#5709 1 1/2" Cap & Chain	<b>27550</b>	\$16.50
#5713 2 1/2" Cap & Chain	<b>27560</b>	\$22.00
#7245 2 1/2" Female x 1 1/2" Male Reducer	<b>2755</b>	\$35.25
<b>Pressure Restricting Hose Valves</b>		
#5060 1 1/2" Angle, Female x Female	<b>27950</b>	P.O.A.
#5050 1 1/2" Angle, Female x Male	<b>27960</b>	\$200.00
#5055 2 1/2" Angle, Female x Male	<b>27980</b>	\$428.50
<b>Pressure Regulating Hose Valves (Factory Set)</b>		
#5580 2 1/2" Angle, Female x Male	<b>28030</b>	\$1,068.00
Tamper Switch Bracket Available		
Field Adjustable Pressure Regulating Valves		P.O.A.
Note: All valves listed with rough brass finish. Other finishes available.		

Section 16  
Specialty Items

Section 18  
Grooved Product

Section 19  
CPVC Pipe & Fittings

Section 20  
Miscellaneous

Section 21  
Electrical

Section C  
Valves & Hose Equipment

Section D  
Backflow

Section F  
Pipe & Accessories

Section H  
Hangers

Section J  
Lubricants

Section K  
Misc.

See latest Technical Data Sheets for specific Approvals, Listings, Design Parameters & available finishes. Sprinkler heads & escutcheons are priced separately unless otherwise noted. Items marked "C.O." are made to order and may require longer delivery times.

Section 16  
Specialty Items

Section 18  
Grooved Product

Section 19  
CPVC Pipe & Fittings

Section 20  
Miscellaneous

Section 21  
Electrical

Section C  
Valves & Hose Equipment

Section D  
Backflow

Section F  
Pipe & Accessories

Section H  
Hangers

Section J  
Lubricants

Section K  
Misc.

<b>Crocker Standpipe and Hose Equipment</b>		
Description	Part Number	List Price
<b>Fire Department Inlet Connections – Single Inlet</b>		
#6341 2 1/2" w/Plate & Plug		
Rough Brass	<b>28155</b>	\$171.50
Polished Brass	<b>28160</b>	\$319.50
Polished Chrome	<b>28165</b>	\$385.50
#6342 3" x 2 1/2" w/Plate & Plug		
Rough Brass	<b>28170</b>	\$275.50
<b>Fire Department Inlet Connections – Free Standing Type</b>		
(Complete with 18" sleeve, Plate & Plugs )		
#6510 4" x 2 1/2" x 2 1/2"		
Rough Brass	<b>28330</b>	\$1,157.00

<b>Crocker Standpipe and Hose Equipment</b>		
Description	Part Number	List Price
<b>Fire Department Inlet Connections – Projecting Type</b>		
#6407, 4"x 2 1/2"x 2 1/2", Single Clapper, Angle		
Rough Brass	<b>28190</b>	\$209.50
#6410, 4"x 2 1/2"x 2 1/2" Double Clapper, Straight		
Rough Brass	<b>28195</b>	\$496.00
Polished Chrome	<b>28205</b>	\$860.50
#6420 4"x 2 1/2"x 2 1/2" Double Clapper, Angle		
Rough Brass	<b>28225</b>	\$1,351.00
#6422 6"x 2 1/2"x 2 1/2" Double Clapper, Angle		
Polished Chrome	<b>28250</b>	P.O.A.
#6760 4" Round Wall Plate		
Rough Brass	<b>28255</b>	\$175.00
Polished Chrome	<b>28265</b>	\$571.00
#6764 6" Round Wall Plate,		
#6766 4" Round Wall Plate, Aluminum		
<b>28285</b>	<b>28285</b>	\$27.75
Note: Plates lettered Automatic Sprinkler, Standpipe, or Automatic Sprinkler and Standpipe.		
#6747 2 1/2" Plug & Chain,		
Rough Brass	<b>28295</b>	\$49.75
Polished Brass	<b>28300</b>	\$66.25
Polished Chrome	<b>28305</b>	\$77.25
#6780 1/2" Auto Ball Drip, Straight	<b>28320</b>	\$29.00

\*See latest Technical Data Sheets for specific Approvals, Listings, Design Parameters & available finishes. Sprinkler heads & escutcheons are priced separately unless otherwise noted. Items marked "C.O." are made to order and may require longer delivery times.

<b>Croker Standpipe and Hose Equipment</b>		
<i>Description</i>	<i>Part Number</i>	<i>List Price</i>
<b>Fire Department Inlet Connections – Flush Wall Type</b>		
#6010 4"x 2 1/2" x 2 1/2", Straight Body		
Rough Brass	<b>28050</b>	\$1,047.00
Polished Brass	<b>28055</b>	\$1,299.00
<b>Check Valves</b>		
#8470-G 4" Groove x Groove, Brass	<b>28360</b>	\$394.00
#8470-T 4" Thread x Thread, Brass	<b>28370</b>	\$394.00
<b>Storz Connections (with Plate &amp; Cap)</b>		
#6360 4" x 4" Aluminum, Straight	<b>28375</b>	\$2,233.00
#6363 6" x 4" Aluminum, 30°	<b>28400</b>	\$1,355.00

<b>Croker Standpipe and Hose Equipment</b>		
<i>Description</i>	<i>Part Number</i>	<i>List Price</i>
<b>Cabinets</b>		
#2700-A Fire department valve cabinet, Recessed, 18X18X8, Steel, Full glass door	<b>28415</b>	\$476.50
Complete line of cabinets available. Specify size, mounting style, finish, and door style. All hose threads shown are NST. Special threads available upon request.		

Section 16	Specialty Items
Section 18	Grooved Product
Section 19	CPVC Pipe & Fittings
Section 20	Miscellaneous
Section 21	Electrical
<b>Section C</b>	<b>Valves &amp; Hose Equipment</b>
Section D	Backflow
Section F	Pipe & Accessories
Section H	Hangers
Section J	Lubricants
Section K	Misc.

See latest Technical Data Sheets for specific Approvals, Listings, Design Parameters & available finishes. Sprinkler heads & escutcheons are priced separately unless otherwise noted. Items marked "C.O." are made to order and may require longer delivery times.



Section 16  
Specialty Items

Section 18  
Grooved Product

Section 19  
CPVC Pipe & Fittings

Section 20  
Miscellaneous

Section 21  
Electrical

Section C  
Valves & Hose Equipment

Section D  
Backflow

Section F  
Pipe & Accessories

Section H  
Hangers

Section J  
Lubricants

Section K  
Misc.

Guardian Standpipe and Hose Equipment		
Description	Part Number	List Price
<b>Hose Rack Units</b>		
#3007-LN 1 1/2" x 75' Fire Hose less Nozzle	<b>6128</b>	\$494.00
#3010-LN 1 1/2" x 100' Fire Hose less Nozzle	<b>6129</b>	\$546.50
#3107-LN 2 1/2" x 75' Fire Hose less Nozzle	<b>61280</b>	\$1,086.00
#3110-LN 2 1/2" x 100' Fire Hose less Nozzle	<b>61290</b>	\$1,242.00
<b>Adjustable Fog Nozzles</b>		
#3714 1 1/2" Polycarbonate Fog Nozzle	<b>61320</b>	\$29.75
#3704 1 1/2" Brass Fog Nozzle	<b>6132</b>	\$72.50
#3726 2 1/2" Brass Fog Nozzle	<b>61325</b>	\$232.50
<b>Fire Hose</b>		
500 PSI Rack Hose Coupled		
#3402-50 1 1/2" x 50' Coupled Fire Hose	<b>61330</b>	\$210.50
#3402-75 1 1/2" x 75' Coupled Fire Hose	<b>6134</b>	\$274.50
#3402-100 1 1/2" x 100' Coupled Fire Hose	<b>6133</b>	\$296.50
300 PSI Single Jacket Coupled		
#3412-50 1 1/2" x 50' Coupled Fire Hose	<b>61335</b>	\$216.50
#3412-75 1 1/2" x 75' Coupled Fire Hose	<b>61340</b>	\$304.00
#3412-100 1 1/2" x 100' Coupled Fire Hose	<b>61345</b>	\$378.50
300 PSI Single Jacket Coupled		
#3414-50 2 1/2" x 50' Coupled Fire Hose	<b>61350</b>	\$399.50
#3414-75 2 1/2" x 75' Coupled Fire Hose	<b>61355</b>	\$536.50
#3414-100 2 1/2" x 100' Coupled Fire Hose	<b>61360</b>	\$668.00
600 PSI Double Jacket Coupled		
#3442-50 1 1/2" x 50' Coupled Fire Hose	<b>61365</b>	\$416.50
#3442-75 1 1/2" x 75' Coupled Fire Hose	<b>61370</b>	\$572.00
#3442-100 1 1/2" x 100' Coupled Fire Hose	<b>61375</b>	\$586.00
600 PSI Double Jacket Coupled		
#3444-50 2 1/2" x 50' Coupled Fire Hose	<b>61380</b>	\$595.00
#3444-75 2 1/2" x 75' Coupled Fire Hose	<b>61385</b>	\$743.50
#3444-100 2 1/2" x 100' Coupled Fire Hose	<b>61390</b>	\$1,113.00
Fire Hose Reels		P.O.A.
<b>Hose Valves</b>		
#5020 1 1/2" FxF Angle Hose Valve	<b>6109</b>	\$108.00
#5010 1 1/2" FxM Angle Hose Valve	<b>6106</b>	\$108.00
#5025 2 1/2" FxF Angle Hose Valve	<b>6110</b>	\$201.00
#5015 2 1/2" FxM Angle Hose Valve	<b>6107</b>	\$172.50
#5515 1 1/2" Cap & Chain	<b>6111</b>	\$17.50
#5525 2 1/2" Cap & Chain	<b>6112</b>	\$28.75
<b>Reducer</b>		
#3315 2 1/2" Female x 1 1/2" Male Reducer	<b>6163</b>	\$33.25

Guardian Standpipe and Hose Equipment		
Description	Part Number	List Price
<b>Pressure Restricting Hose Valves</b>		
#5040 1 1/2" FxF Angle Press Restrict Valve	<b>61395</b>	\$175.50
#5030 1 1/2" FxM Angle Press Restrict Valve	<b>61405</b>	\$206.00
#5045 2 1/2" FxF Angle Press Restrict Valve	<b>61400</b>	\$376.00
#5035 2 1/2" FxM Angle Press Restrict Valve	<b>61410</b>	\$364.50
<b>Pressure Regulating Hose Valves (Factory Set)</b>		
#5250 1 1/2" FxF Angle Press Regul. Valve	<b>61415</b>	POA
#5240 1 1/2" FxM Angle Press Regul. Valve	<b>61425</b>	POA
#5255 2 1/2" FxF Angle Press Regul. Valve	<b>61420</b>	POA
#5245 2 1/2" FxM Angle Press Regul. Valve	<b>61430</b>	POA
#5260 2 1/2" FxF Inline Press Regul. Valve	<b>61435</b>	POA
Tamper Switch Bracket Available		
Field Adjustable Pressure Regulating Valves		POA
Note: All valves listed with rough brass finish. Other finishes available.		
<b>Fire Department Inlet Connections – Single Inlet</b>		
#6002 1 1/2" RB FDC w/ Plate & Plug	<b>61535</b>	\$79.50
#6002-B 1 1/2" PB FDC w/ Plate & Plug	<b>61540</b>	\$120.00
#6002-D 1 1/2" PC FDC w/ Plate & Plug	<b>61545</b>	\$183.50
#6014 2 1/2" RB FDC w/ Plate & Plug	<b>61550</b>	\$197.50
#6014-B 2 1/2" PB FDC w/ Plate & Plug	<b>61555</b>	\$311.00
#6014-D 2 1/2" PC FDC w/ Plate & Plug	<b>61560</b>	\$383.50
#6015 3" x 2 1/2" RB FDC w/ Plate & Plug	<b>61565</b>	\$275.50
#6015-B 3" x 2 1/2" PB FDC w/ Plate & Plug	<b>61570</b>	\$336.50
#6015-D 3" x 2 1/2" PC FDC w/ Plate & Plug	<b>61575</b>	\$549.50
<b>Fire Department Inlet Connections – Projecting Type</b>		
#6314 4" x 2 1/2" x 2 1/2" SC FDC Straight	<b>6153</b>	\$193.50
#6315 4" x 2 1/2" x 2 1/2" SC FDC Angle	<b>6154</b>	\$306.00
#6324 4" x 2 1/2" x 2 1/2" RB DC FDC Straight	<b>6155</b>	\$682.00
#6324-B 4" x 2 1/2" x 2 1/2" PB DC FDC Straight	<b>6157</b>	\$800.50
#6324-D 4" x 2 1/2" x 2 1/2" PC DC FDC Straight	<b>6158</b>	\$702.50
#6326 6" x 2 1/2" x 2 1/2" RB DC FDC Straight	<b>61580</b>	\$853.00
#6326-B 6" x 2 1/2" x 2 1/2" PB DC FDC Straight	<b>61585</b>	\$1,128.00
#6326-D 6" x 2 1/2" x 2 1/2" PC DC FDC Straight	<b>61590</b>	\$1,141.00

\*See latest Technical Data Sheets for specific Approvals, Listings, Design Parameters & available finishes. Sprinkler heads & escutcheons are priced separately unless otherwise noted. Items marked "C.O." are made to order and may require longer delivery times.

<b>Guardian Standpipe and Hose Equipment</b>		
Description	Part Number	List Price
#6325 4" x 2 1/2" x 2 1/2" RB DC FDC Angle	<b>6156</b>	\$527.50
#6325-B 4" x 2 1/2" x 2 1/2" PB DC FDC Angle	<b>6170</b>	\$820.00
#6325-D 4" x 2 1/2" x 2 1/2" PC DC FDC Angle	<b>6171</b>	\$1,040.00
#6327 6" x 2 1/2" x 2 1/2" RB DC FDC Angle	<b>61595</b>	\$897.00
#6327-B 6" x 2 1/2" x 2 1/2" PB DC FDC Angle	<b>61600</b>	\$2,107.00
#6327-D 6" x 2 1/2" x 2 1/2" PC DC FDC Angle	<b>61605</b>	\$1,451.00
#6464 RB 4" Round Wall Plate	<b>6137</b>	\$150.50
#6464-B PB 4" Round Wall Plate	<b>6138</b>	\$181.00
#6464-D PC 4" Round Wall Plate	<b>6150</b>	\$216.50
#6466 RB 6" Round Wall Plate	<b>61610</b>	\$175.50
#6466-B PB 6" Round Wall Plate	<b>61615</b>	\$306.00
#6466-D PC 6" Round Wall Plate	<b>61620</b>	\$337.50
#6454 Aluminum 4" Round Wall Plate	<b>61625</b>	\$31.50
Note: Plates lettered Automatic Sprinkler, Standpipe, or Automatic Sprinkler and Standpipe.		
#6404 2 1/2" RB Plug & Chain	<b>6115</b>	\$37.50
#6404-B 2 1/2" PB Plug & Chain	<b>6116</b>	\$57.50
#6404-D 2 1/2" PC Plug & Chain	<b>6117</b>	\$74.50
#6406-PR 2 1/2" Aluminum Breakable Cap	<b>61635</b>	\$9.85/Pair
#6407-PR 2 1/2" Plastic Breakable Cap	<b>61636</b>	\$3.30/Pair
#6430 1/2" Straight Auto Ball Drip	<b>6104</b>	\$25.50
#6431 1/2" Angle Auto Ball Drip	<b>61640</b>	\$47.75
<b>Fire Department Inlet Connections – Free Standing Type (Complete with 18" sleeve, Plate &amp; Plugs )</b>		
#6224 4" x 2 1/2" x 2 1/2" RB FDC w/Plt, Plug, Slv	<b>61645</b>	\$1,046.00
#6224-B 4" x 2 1/2" x 2 1/2" PB FDC w/Plt, Plug, Slv	<b>61650</b>	\$1,611.00
#6224-D 4" x 2 1/2" x 2 1/2" PC FDC w/Plt, Plug, Slv	<b>61655</b>	\$1,457.00
#6226 6" x 2 1/2" x 2 1/2" RB FDC w/Plt, Plug, Slv	<b>61660</b>	\$2,062.00
#6226-B 6" x 2 1/2" x 2 1/2" PB FDC w/Plt, Plug, Slv	<b>61665</b>	\$2,343.00
#6226-D 6" x 2 1/2" x 2 1/2" PC FDC w/Plt, Plug, Slv	<b>61670</b>	\$2,875.00

<b>Guardian Standpipe and Hose Equipment</b>		
Description	Part Number	List Price
<b>Fire Department Inlet Connections – Flush Wall Type</b>		
#6024 4" x 2 1/2" x 2 1/2" RB FDC FL Straight	<b>61445</b>	\$1,279.00
#6024-B 4" x 2 1/2" x 2 1/2" PB FDC FL Straight	<b>61450</b>	\$2,573.00
#6024-D 4" x 2 1/2" x 2 1/2" PC FDC FL Straight	<b>61455</b>	\$1,579.00
#6025 4" x 2 1/2" x 2 1/2" RB FDC FL Angle	<b>61475</b>	\$1,479.00
#6025-B 4" x 2 1/2" x 2 1/2" PB FDC FL Angle	<b>61480</b>	\$1,631.00
#6025-D 4" x 2 1/2" x 2 1/2" PC FDC FL Angle	<b>61485</b>	\$1,605.00
#6026 4" x 2 1/2" x 2 1/2" RB FDC Top Feed	<b>61505</b>	\$1,756.00
#6026-B 4" x 2 1/2" x 2 1/2" PB FDC Top Feed	<b>61510</b>	\$1,881.00
#6026-D 4" x 2 1/2" x 2 1/2" PC FDC Top Feed	<b>61515</b>	\$2,056.00
#6027 6" x 2 1/2" x 2 1/2" RB FDC FL Straight	<b>61460</b>	\$1,826.00
#6027-B 6" x 2 1/2" x 2 1/2" PB FDC FL Straight	<b>61465</b>	\$1,977.00
#6027-D 6" x 2 1/2" x 2 1/2" PC FDC FL Straight	<b>61470</b>	\$1,855.00
#6028 6" x 2 1/2" x 2 1/2" RB FDC FL Angle	<b>61490</b>	\$2,424.00
#6028-B 6" x 2 1/2" x 2 1/2" PB FDC FL Angle	<b>61495</b>	\$2,187.00
#6028-D 6" x 2 1/2" x 2 1/2" PC FDC FL Angle	<b>61500</b>	\$2,897.00
#6029 6" x 2 1/2" x 2 1/2" RB FDC Top Feed	<b>61520</b>	\$2,860.00
#6029-B 6" x 2 1/2" x 2 1/2" PB FDC Top Feed	<b>61525</b>	\$3,010.00
#6029-D 6" x 2 1/2" x 2 1/2" PC FDC Top Feed	<b>61530</b>	\$3,290.00
<b>Check Valves</b>		
#6420 GxG Check Valve 4" Brass	<b>61675</b>	\$336.50
#6421 GxT Check Valve 4" Brass	<b>61680</b>	\$336.50
#6422 TxT Check Valve 4" Brass	<b>61685</b>	\$1,111.00
<b>Storz Connections (with Plate &amp; Cap )</b>		
#6614-KIT 4"x4" Straight Aluminum Storz Conn.	<b>6123</b>	\$532.50
#6624-KIT 4"x4" 30-degree Aluminum Storz Conn.	<b>6125</b>	\$709.00
#6615-KIT 4"x5" Straight Aluminum Storz Conn.	<b>6124</b>	\$677.50
#6625-KIT 4"x5" 30-degree Aluminum Storz Conn.	<b>6126</b>	\$798.50
#6617-KIT 6"x4" Straight Aluminum Storz Conn.	<b>61230</b>	\$715.00
#6627-KIT 6"x4" 30-degree Aluminum Storz Conn.	<b>61250</b>	\$941.00
#6618-KIT 6"x5" Straight Aluminum Storz Conn.	<b>61240</b>	\$834.00
#6628-KIT 6"x5" 30-degree Aluminum Storz Conn.	<b>61260</b>	\$1,029.00

Section 16	Specialty Items
Section 18	Grooved Product
Section 19	CPVC Pipe & Fittings
Section 20	Miscellaneous
Section 21	Electrical
Section C	Valves & Hose Equipment
Section D	Backflow
Section F	Pipe & Accessories
Section H	Hangers
Section J	Lubricants
Section K	Misc.

See latest Technical Data Sheets for specific Approvals, Listings, Design Parameters & available finishes. Sprinkler heads & escutcheons are priced separately unless otherwise noted. Items marked "C.O." are made to order and may require longer delivery times.

Section 16  
Specialty Items

Section 18  
Grooved Product

Section 19  
CPVC Pipe & Fittings

Section 20  
Miscellaneous

Section 21  
Electrical

Section C  
Valves & Hose Equipment

Section D  
Backflow

Section F  
Pipe & Accessories

Section H  
Hangers

Section J  
Lubricants

Section K  
Misc.

<b>Guardian Standpipe and Hose Equipment</b>		
<i>Description</i>	<i>Part Number</i>	<i>List Price</i>
<b>Roof Manifolds (Body Only )</b>		
#6924 4" x 2 1/2" x 2 1/2" Straight Manifold Body	<b>6143</b>	\$186.00
#6925 4" x 2 1/2" x 2 1/2" Angle Manifold Body	<b>6145</b>	\$222.00
#6926 6" x 2 1/2" x 2 1/2" Straight Manifold Body	<b>6144</b>	\$450.50
#6927 6" x 2 1/2" x 2 1/2" Angle Manifold Body	<b>6146</b>	\$684.50
Note: Refer to page C-6 for appropriate valves, caps and chains		
<b>Cabinets</b>		
#2020-A Recessed Valve Cabinet Full Glass	<b>61690</b>	\$236.50
#2050-A Flush Valve Cabinet Full Glass	<b>61695</b>	\$317.50
Complete line of cabinets available. Specify size, mounting style, finish, and door style. All hose threads shown are NST. Special threads available upon request.		

\*See latest Technical Data Sheets for specific Approvals, Listings, Design Parameters & available finishes. Sprinkler heads & escutcheons are priced separately unless otherwise noted. Items marked "C.O." are made to order and may require longer delivery times.

Ames		
Description	Part Number	List Price
<b>Model Maxim M200 With FxG OS&amp;Y Valve</b>		
2 1/2"	205500	\$3,126.00
3"	205510	\$3,096.00
4"	205520	\$3,994.00
6"	205530	\$6,425.00
8"	207190	\$10,940.00
<b>Model Maxim M200 With Grooved Butterfly Valve</b>		
2 1/2"	205501	\$3,731.00
3"	205511	\$3,650.00
4"	205521	\$4,707.00
6"	205531	\$7,590.00
8"	207191	\$12,921.00
<b>Model Maxim M300 DCDA With FxG OS&amp;Y Valve (GPM Meter)</b>		
2 1/2"	205490	\$4,126.00
3"	205480	\$4,386.00
4"	205580	\$4,764.00
6"	205590	\$7,450.00
8"	205390	\$13,428.00
<b>Model Maxim M300 DCDA With FxG OS&amp;Y Valve (CFM Meter)</b>		
2 1/2"	205495	\$4,126.00
3"	205485	\$4,386.00
4"	205585	\$4,764.00
6"	205595	\$7,450.00
8"	205395	\$13,428.00
<b>Model Maxim M300 DCDA With Grooved Butterfly Valve (GPM Meter)</b>		
2 1/2"	205491	\$4,838.00
3"	205481	\$5,168.00
4"	205581	\$5,598.00
6"	205591	\$8,786.00
8"	205391	\$15,820.00
<b>Model Maxim M300 DCDA With Grooved Butterfly Valve (CFM Meter)</b>		
2 1/2"	205496	\$4,838.00
3"	205486	\$5,168.00
4"	205586	\$5,598.00
6"	205596	\$8,786.00
8"	205396	\$15,820.00
<b>Model Maxim M400 With FxG OS&amp;Y Valve</b>		
2 1/2"	207670	\$3,667.00
3"	207680	\$4,054.00
4"	207690	\$5,157.00
6"	207700	\$8,184.00
8"	207710	\$15,596.00
<b>Model Maxim M400N With Grooved Butterfly Valve</b>		
2 1/2"	207671	\$4,660.00
3"	207681	\$5,075.00
4"	207691	\$6,429.00
6"	207701	\$10,115.00

Ames		
Description	Part Number	List Price
<b>Model Maxim M500 RPDA With FxG OS&amp;Y Valve (GPM Meter)</b>		
2 1/2"	208320	\$6,067.00
3"	208330	\$6,241.00
4"	208340	\$6,341.00
6"	208360	\$10,000.00
8"	208380	\$17,712.00
<b>Model Maxim M500 RPDA With FxG OS&amp;Y Valve (CFM Meter)</b>		
2 1/2"	208325	\$6,067.00
3"	208335	\$6,241.00
4"	208345	\$6,341.00
6"	208365	\$10,000.00
8"	208385	\$19,336.00
<b>Model Maxim M500 RPDA With Grooved BFV's Valve (GPM Meter)</b>		
2 1/2"	208321	\$7,372.00
3"	208331	\$7,579.00
4"	208341	\$7,784.00
6"	208361	\$12,202.00
<b>Model Maxim M500 RPDA With Grooved BFV's Valve (CFM Meter)</b>		
2 1/2"	208326	\$7,372.00
3"	208336	\$7,579.00
4"	208346	\$7,784.00
6"	208366	\$12,202.00
<b>Model 1000 DCV Detector Check F x F (Less By-Pass)</b>		
4"	20849	\$1,823.00
6"	20851	\$2,606.00
8"	20853	\$4,366.00
10"	20855	\$7,975.00
<b>Model 1005 DCV Detector Check F x G (Less By-Pass)</b>		
4"	20858	\$1,747.00
6"	20854	\$2,493.00
<b>Model 2000B Brass Double Check Assembly (With Ball Valve)</b>		
1/2"	21010	\$299.50
3/4"	21011	\$288.50
1"	21012	\$335.50
1 1/4"	21013	\$611.50
1 1/2"	21014	\$653.50
2"	21015	\$770.00
<b>Model 2000B Brass Double Check Assembly (Less Ball Valve)</b>		
1/2"	21023	\$284.50
3/4"	21024	\$356.00
1"	21025	\$463.00
1 1/4"	21026	\$513.50
1 1/2"	21027	\$546.50
2"	21028A	\$589.50

Section 16  
Specialty Items

Section 18  
Grooved Product

Section 19  
CPVC Pipe & Fittings

Section 20  
Miscellaneous

Section 21  
Electrical

Section C  
Valves & Hose Equipment

Section D  
Backflow

Section F  
Pipe & Accessories

Section H  
Hangers

Section J  
Lubricants

Section K  
Misc.

Items shown on this sheet may not be stocked at all Tyco Fire Products warehouses. Please ask your local Tyco Fire Products location for availability. Freight terms may vary for non commonly stocked items. See latest Technical Data Sheets for specific Approvals, Listings, Design Parameters & available finishes. Prices subject to change without notice.

Section 16 Specialty Items  
Section 18 Grooved Product  
Section 19 CPVC Pipe & Fittings  
Section 20 Miscellaneous  
Section 21 Electrical  
Section C Valves & Hose Equipment  
Section D Backflow  
Section F Pipe & Accessories  
Section H Hangers  
Section J Lubricants  
Section K Misc.

<b>Ames</b>		
Description	Part Number	List Price
<b>Model 3000B Brass Assembly (w/O.S.&amp;Y. Valve)</b>		
2"	21549	\$5,271.00
<b>Model 4000B Brass Reduced Pressure Backflow Assembly (With Ball Valve)</b>		
1/2"	21016	\$493.50
3/4"	21017	\$520.50
1"	21018	\$548.50
1 1/4"	21019	\$998.00
1 1/2"	21021	\$1,056.00
2"	21022	\$1,148.00
<b>Model 4000B Brass Reduced Pressure Backflow Assembly (Less Ball Valve)</b>		
1/2"	21029	\$499.00
3/4"	21030	\$484.00
1"	21031	\$506.00
1 1/4"	21032	\$826.00
1 1/2"	21033	\$962.50
2"	21034	\$1,017.00
<b>Model 2000 SS Double Check Backflow Assembly (Less Gate Valves)</b>		
2 1/2"	20700	\$1,675.00
3"	20701	\$1,826.00
4"	20702	\$2,556.00
6"	20703	\$4,150.00
8"	20897	\$8,952.00
10"	20705	\$12,085.00
<b>Model 2000 SS Double Check Backflow Assembly (w/O.S.&amp;Y. Valves)</b>		
2 1/2"	20550	\$2,850.00
3"	20551	\$2,979.00
4"	20552	\$3,534.00
6"	20553	\$5,683.00
8"	20719	\$10,206.00
10"	20555	\$15,469.00
<b>Model 3000 SS Double Check Detector Backflow Assembly (Less Gate Valves)</b>		
2 1/2"	20729	\$3,291.00
3"	20730	\$3,455.00
4"	20731	\$3,527.00
6"	20732	\$5,513.00
8"	20898	\$10,463.00
10"	20734	\$12,773.00

<b>Ames</b>		
Description	Part Number	List Price
<b>Model 3000 SS Double Check Detector Backflow Assembly (w/O.S.&amp;Y. Valves)</b>		
2 1/2"	20549	\$3,785.00
3"	20548	\$4,027.00
4"	20558	\$4,332.00
6"	20559	\$6,589.00
8"	20539	\$12,141.00
10"	20561	\$17,531.00
<b>Model 4000 SS Reduced Pressure Backflow Prevention Assembly (Less Gate Valves)</b>		
2 1/2"	20757	\$2,825.00
3"	20758	\$2,935.00
4"	20759	\$3,824.00
6"	20760	\$6,197.00
8"	20761	\$11,884.00
10"	20762	\$17,738.00
<b>Model 4000 SS Reduced Pressure Backflow Prevention Assembly (w/O.S.&amp;Y. Valves)</b>		
2 1/2"	20767	\$3,579.00
3"	20768	\$3,796.00
4"	20769	\$4,555.00
6"	20770	\$7,354.00
8"	20771	\$14,416.00
10"	20772	\$20,928.00
<b>Model 5000 SS Reduced Pressure Detector Assembly (Less Gate Valves)</b>		
2 1/2"	20822	\$4,015.00
3"	20823	\$4,108.00
4"	20824	\$5,006.00
6"	20826	\$7,213.00
<b>Model 5000 SS Reduced Pressure Detector Assembly (w/O.S.&amp;Y. Valves)</b>		
2 1/2"	20832	\$5,362.00
3"	20833	\$5,534.00
4"	20834	\$5,867.00
6"	20836	\$8,750.00
<b>Air Gap Drains</b>		
Horiz.Air Gap Drain (A113-960)	20788	\$313.00
Silver Bullet Vertical (A113-963)	20839	\$1,230.00
Old Style (Non S.S) (3-1039)	20787	\$1,923.00
<b>Maxim/Colt Air Gap Drain</b>		
2 1/2" - 10"	207880	\$404.00

\*See latest Technical Data Sheets for specific Approvals, Listings, Design Parameters & available finishes. Sprinkler heads & escutcheons are priced separately unless otherwise noted. Items marked "C.O." are made to order and may require longer delivery times.

<b>Colt</b>		
Description	Part Number	List Price
<b>Model C200 Double Check Assembly (w/ FxG O.S.&amp;Y. Valves)</b>		
2 1/2"	205502	\$2,616.00
3"	205512	\$2,875.00
4"	205522	\$3,330.00
6"	205532	\$5,356.00
8"	207192	\$9,701.00
<b>Model C200 Double Check Assembly (w/ Grooved Butterfly Valves)</b>		
2 1/2"	205503	\$3,228.00
3"	205513	\$3,470.00
4"	205523	\$4,011.00
6"	205533	\$6,457.00
8"	207193	\$11,720.00
<b>Model C300 Double Check Detector Assembly (w/ FxG O.S.&amp;Y. Valves)</b>		
2 1/2"	205492	\$3,619.00
3"	205482	\$3,724.00
4"	205582	\$4,001.00
6"	205592	\$5,965.00
8"	205392	\$11,669.00
<b>Model C300 Double Check Detector Assembly (w/ Grooved Butterfly Valves)</b>		
2 1/2"	205493	\$4,455.00
3"	205483	\$4,552.00
4"	205583	\$4,933.00
6"	205593	\$7,491.00
8"	205393	\$14,508.00
<b>Model C400 Reduced Pressure Assembly (w/ FxG O.S.&amp;Y. Valves)</b>		
2 1/2"	207672	\$3,231.00
3"	207682	\$3,426.00
4"	207692	\$4,101.00
6"	207702	\$6,675.00
8"	207712	\$12,975.00
<b>Model C500 Reduced Pressure Detector Assembly (w/ FxG O.S.&amp;Y. Valves)</b>		
2 1/2"	208322	\$4,623.00
3"	208332	\$4,918.00
4"	208342	\$5,321.00
6"	208362	\$7,905.00
8"	208382	\$14,266.00

<b>Febco</b>		
Description	Part Number	List Price
<b>Model 850 Double Check Assembly (w/ O.S.&amp;Y. Valves)</b>		
2 1/2"	90610	\$3,381.00
3"	90611	\$3,473.00
4"	90612	\$4,301.00
6"	90613	\$6,396.00
8"	90614	\$12,043.00
<b>Model 870V (Vertical) Double Check Assembly (w/ O.S.&amp;Y. Valves)</b>		
2 1/2"	90620	\$3,878.00
3"	90621	\$3,992.00
4"	90622	\$5,229.00
6"	90623	\$7,449.00
8"	90624	\$13,392.00
10"	90625	\$19,856.00
<b>Model 856 Double Check Detector Assembly (w/ O.S.&amp;Y. Valves)</b>		
2 1/2"	90641	\$4,559.00
3"	90642	\$4,743.00
4"	90643	\$4,971.00
6"	90644	\$7,398.00
8"	90645	\$12,628.00

Section 16	Specialty Items
Section 18	Grooved Product
Section 19	CPVC Pipe & Fittings
Section 20	Miscellaneous
Section 21	Electrical
Section C	Valves & Hose Equipment
Section D	Backflow
Section F	Pipe & Accessories
Section H	Hangers
Section J	Lubricants
Section K	Misc.

Items shown on this sheet may not be stocked at all Tyco Fire Products warehouses. Please ask your local Tyco Fire Products location for availability. Freight terms may vary for non commonly stocked items. See latest Technical Data Sheets for specific Approvals, Listings, Design Parameters & available finishes. Prices subject to change without notice.



Section 16  
Specialty Items

Section 18  
Grooved Product

Section 19  
CPVC Pipe & Fittings

Section 20  
Miscellaneous

Section 21  
Electrical

Section C  
Valves & Hose Equipment

Section D  
Backflow

Section F  
Pipe & Accessories

Section H  
Hangers

Section J  
Lubricants

Section K  
Misc.

Febco		
Description	Part Number	List Price
<b>Model 876V (Vertical) Double Check Detector Assembly (w/ O.S.&amp;Y. Valves)</b>		
2 1/2"	90650	\$5,237.00
3"	90651	\$5,449.00
4"	90652	\$5,790.00
6"	90653	\$8,625.00
8"	90654	\$15,457.00
10"	90655	\$21,712.00
<b>Model 860 Reduced Pressure Assembly (w/ O.S.&amp;Y. Valves)</b>		
2 1/2"	90671	\$3,961.00
3"	90672	\$4,190.00
4"	90673	\$5,448.00
6"	90674	\$8,259.00
8"	90675	\$15,332.00
<b>Model 880V Reduced Pressure Assembly (w/ O.S.&amp;Y. Valves)</b>		
2 1/2"	90680	\$4,443.00
3"	90681	\$4,719.00
4"	90682	\$6,226.00
6"	90683	\$9,518.00
8"	90684	\$17,524.00
10"	90685	\$24,426.00
<b>Model 826 Reduced Pressure Detector Assembly (w/ O.S.&amp;Y. Valves)</b>		
2 1/2"	90695	\$5,597.00
3"	90696	\$5,929.00
4"	90697	\$6,957.00
6"	90698	\$9,836.00
8"	90699	\$17,229.00
10"	90701	\$22,975.00
<b>Model 850U Double Check Assembly (w/ Union End - Ball Valves)</b>		
1"	90733	\$365.50
1 1/4"	90734	\$730.00
1 1/2"	90735	\$767.00
2"	90736	\$880.00

Febco		
Description	Part Number	List Price
<b>Model 850 Double Check Assembly (w/ Ball Valves)</b>		
1"	92733	\$306.50
1 1/4"	92734	\$597.00
1 1/2"	92735	\$627.50
2"	92736	\$749.00
<b>Model 860 Reduced Pressure Assembly (w/ Union End - Ball Valves)</b>		
1"	91733	\$710.50
1 1/4"	91734	\$1,153.00
1 1/2"	91735	\$1,308.00
2"	91736	\$1,393.00
<b>Model 825Y Reduced Pressure Assembly</b>		
2"	90765	\$1,185.00
<b>Air Gap Drains</b>		
M 2 1/2"-10"	90725	\$452.00
AGD 2 1/2"-10"	90726	\$458.00
601 1 1/4"-2"	91725	\$70.25

\*See latest Technical Data Sheets for specific Approvals, Listings, Design Parameters & available finishes. Sprinkler heads & escutcheons are priced separately unless otherwise noted. Items marked "C.O." are made to order and may require longer delivery times.



Wilkins		
Description	Part Number	List Price
<b>Model 310 Single Check Valve Assembly (FxF)</b>		
310 DCV FxF 4"	3104000	\$1,237.00
310 DCV FxF 6"	3106000	\$1,706.00
310 DCV FxF 8"	3108000	\$3,315.00
<b>Model 310A Single Check Valve Assembly (w/ Metered Bypass Assembly)</b>		
310DA DCV W/BYPASS 4"	3104001	\$2,115.00
310DA DCV W/BYPASS 6"	3106001	\$2,719.00
310DA DCV W/BYPASS 8"	3108001	\$4,594.00
<b>Model 350AB Double Check Valve (w/ Grooved Butterfly Valves)</b>		
350AB DCV W/GR BFV 2-1/2"	3501250	\$3,101.00
350AB DCV W/GR BFV 3"	3501300	\$3,056.00
350AB DCV W/GR BFV 4"	3501400	\$3,638.00
350AB DCV W/GR BFV 6"	3501600	\$5,681.00
350AB DCV W/GR BFV 8"	3501800	\$10,639.00
<b>Model 350A Double Check Valve (w/ O.S.&amp;Y. Valves, FxF)</b>		
350A DC W/ OSY FxF 2-1/2"	350250	\$2,711.00
350A DC W/OSY FxF 3"	350300	\$2,824.00
350A DC W/OSY FxF 4"	350400	\$3,338.00
350A DC W/OSY FxF 6"	350600	\$5,216.00
350A DC W/OSY FxF 8"	350800	\$9,799.00
350A DC W/OSY FxF 10"	350100	\$14,805.00
<b>Model 350ADA Double Check Detector (w/ O.S.&amp;Y. Valves, FxG)</b>		
350ADAG DCDA W/FXG OSY 2.5 (CFM)	3501251	\$3,611.00
350ADAG DCDA W/FXG OSY 3(CFM)	3501301	\$3,817.00
350ADAG DCDA W/FXG OSY 4(CFM)	3501401	\$4,133.00
350ADAG DCDA W/FXG OSY 6(CFM)	3501601	\$6,188.00
350ADAG DCDA W/FXG OSY 8(CFM)	3501801	\$11,509.00
<b>Model 350ADA Double Check Detector (w/ Grooved Butterfly Valves)</b>		
350ADA DCDA W/BFV 2-1/2" (GPM)	3501252	\$3,937.00
350ADA DCDA W/BFV 3" (GPM)	3501302	\$4,166.00
350ADA DCDA W/BFV 4" (GPM)	3501402	\$4,470.00
350ADA DCDA W/BFV 6" (GPM)	3501602	\$6,720.00
350ADA DCDA W/BFV 8" (GPM)	3501802	\$12,904.00

Wilkins		
Description	Part Number	List Price
<b>Model 350ADA Double Check Detector (w/ Grooved Butterfly Valves)</b>		
350ADA DCDA W/BFV 2-1/2 (CFM)	3501253	\$3,937.00
350ADA DCDA W/BFV 3" (CFM)	3501303	\$4,166.00
350ADA DCDA W/BFV 4" (CFM)	3501403	\$4,470.00
350ADA DCDA W/BFV 6" (CFM)	3501603	\$6,720.00
350ADA DCDA W/BFV 8" (CFM)	3501803	\$12,904.00
<b>Model 350ADA Double Check Detector (w/ O.S.&amp;Y. Valves, FxF)</b>		
350ADA DCDA W/OSY FxF 2-1/2"	3501254	\$3,611.00
350ADA DCDA W/OSY FxF 3"	3501304	\$3,817.00
350ADA DCDA W/OSY FxF 4"	3501404	\$4,133.00
350ADA DCDA W/OSY FxF 6"	3501604	\$6,188.00
350ADA DCDA W/OSY FxF 8"	3501804	\$11,509.00
350ADA DCDA W/OSY FxF 10"	3501104	\$16,815.00
<b>Model 375 Reduced Pressure Principle (w/ O.S.&amp;Y. Valves, FxG)</b>		
375A RPA W/FXG OSY VLV 2-1/2"	3751250	\$3,364.00
375A RPA W/FXG OSY VLV 3"	3751300	\$3,499.00
375A RPA W/FXG OSY VLV 4"	3751400	\$4,268.00
375A RPA W/FXG OSY VLV 6"	3751600	\$6,907.00
375A RPA W/FXG OSY VLV 8"	3751800	\$13,545.00
<b>Model 375ADA Reduced Pressure Detector Assembly (w/ O.S.&amp;Y. Valves, FxG)</b>		
375ADA RPDA W/FXG OSY 2-1/2 (GPM)	3751251	\$4,785.00
375ADA RPDA W/FXG OSY 3 (GPM)	3751301	\$5,104.00
375ADA RPDA W/FXG OSY 4 (GPM)	3751401	\$5,486.00
375ADA RPDA W/FXG OSY 6 (GPM)	3751601	\$7,834.00
375ADA RPDA W/FXG OSY 8 (GPM)	3751801	\$14,895.00
<b>Model 375ADA Reduced Pressure Detector Assembly (w/ O.S.&amp;Y. Valves, FxG)</b>		
375ADA RPDA W/FXG OSY 2-1/2 (CFM)	3751252	\$4,785.00
375ADA RPDA W/FXG OSY 3 (CFM)	3751302	\$5,104.00
375ADA RPDA W/FXG OSY 4 (CFM)	3751402	\$5,486.00
375ADA RPDA W/FXG OSY 6 (CFM)	3751602	\$7,834.00
375ADA RPDA W/FXG OSY 8 (CFM)	3751802	\$14,895.00
<b>Model 375ADA Reduced Pressure Detector Assembly (w/ Grooved Butterfly Valves)</b>		
375ADA RPDA W/BFV 2-1/2 (GPM)	3751253	\$5,205.00
375ADA RPDA W/BFV 3 (GPM)	3751303	\$5,528.00
375ADA RPDA W/BFV 4 (GPM)	3751403	\$5,914.00
375ADA RPDA W/BFV 6 (GPM)	3751603	\$8,377.00
375ADA RPDA W/BFV 8 (GPM)	3751803	\$16,178.00

Section 16  
Specialty Items

Section 18  
Grooved Product

Section 19  
CPVC Pipe & Fittings

Section 20  
Miscellaneous

Section 21  
Electrical

Section C  
Valves & Hose Equipment

Section D  
Backflow

Section F  
Pipe & Accessories

Section H  
Hangers

Section J  
Lubricants

Section K  
Misc.

Items shown on this sheet may not be stocked at all Tyco Fire Products warehouses. Please ask your local Tyco Fire Products location for availability. Freight terms may vary for non commonly stocked items. See latest Technical Data Sheets for specific Approvals, Listings, Design Parameters & available finishes. Prices subject to change without notice.

Section 16  
Specialty Items

Section 18  
Grooved Product

Section 19  
CPVC Pipe & Fittings

Section 20  
Miscellaneous

Section 21  
Electrical

Section C  
Valves & Hose Equipment

Section D  
Backflow

Section F  
Pipe & Accessories

Section H  
Hangers

Section J  
Lubricants

Section K  
Misc.

<b>Wilkins</b>		
<i>Description</i>	<i>Part Number</i>	<i>List Price</i>
<b>Model 375ADA Reduced Pressure Detector Assembly (w/ Grooved Butterfly Valves)</b>		
375ADA RPDA W/BFV 2-1/2" (CFM)	<b>3751254</b>	\$5,205.00
375ADA RPDA W/BFV 3" (CFM)	<b>3751304</b>	\$5,528.00
375ADA RPDA W/BFV 4" (CFM)	<b>3751404</b>	\$5,914.00
375ADA RPDA W/BFV 6" (CFM)	<b>3751604</b>	\$8,377.00
375ADA RPDA W/BFV 8" (CFM)	<b>3751804</b>	\$16,178.00
<b>Model 375ADA Reduced Pressure Detector Assembly (w/ O.S.&amp;Y. Valves, FxF)</b>		
375ADA RPDA W/OSY FxF 2-1/2"	<b>3751256</b>	\$4,785.00
375ADA RPDA W/OSY FxF 3"	<b>3751306</b>	\$5,104.00
375ADA RPDA W/OSY FxF 4"	<b>3751406</b>	\$5,486.00
375ADA RPDA W/OSY FxF 6"	<b>3751606</b>	\$7,834.00
375ADA RPDA W/OSY FxF 8"	<b>3751806</b>	\$14,895.00
375ADA RPDA W/OSY FxF 10"	<b>3751106</b>	\$18,506.00
<b>Model 375DAL Reduced Pressure Detector Assembly (w/ O.S.&amp;Y. Valves, Flanged Body)</b>		
375DAL RPDA L/OSY 2-1/2"	<b>3751255</b>	\$3,724.00
375DAL RPDA L/OSY 3"	<b>3751305</b>	\$3,791.00
375DAL RPDA L/OSY 4"	<b>3751405</b>	\$4,538.00
375DAL RPDA L/OSY 6"	<b>3751605</b>	\$6,454.00
375DAL RPDA L/OSY 8"	<b>3751805</b>	\$11,989.00
375DAL RPDA L/OSY 10"	<b>3751105</b>	\$16,969.00
<b>Model 475 Reduced Pressure Principle (w/ Grooved Butterfly Valves)</b>		
475 RPA W/BFV 4	<b>475140</b>	\$5,201.00
475 RPA W/BFV 6	<b>475160</b>	\$8,377.00
475 RPA W;/BFV 8	<b>475180</b>	\$16,703.00

<b>Wilkins</b>		
<b>Model 950XL Double Check Valve Assembly (FNPT x FNPT Ends)</b>		
950XL DCV L/BV 3/4"	<b>73072</b>	\$256.00
950XL DCV L/BV 1"	<b>73073</b>	\$293.00
950XL DCV L/BV 1-1/4"	<b>73074</b>	\$495.00
950XL DCV L/BV 1-1/2"	<b>73075</b>	\$577.50
950XL DCV L/BV 2"	<b>73076</b>	\$619.00
<b>Model 975 Reduced Pressure Principle (FNPT x FNPT Ends)</b>		
975XL RP L/BV 1/2"	<b>73077</b>	POA
975XL RP L/BV 3/4"	<b>73078</b>	\$479.00
975XL RP L/BV 1"	<b>73079</b>	\$536.50
975XL RP L/BV 1-1/4"	<b>73080</b>	\$879.00
975XL RP L/BV 1-1/2"	<b>73081</b>	\$1,019.00
975XL RP L/BV 2"	<b>73082</b>	\$1,068.00

\*See latest Technical Data Sheets for specific Approvals, Listings, Design Parameters & available finishes. Sprinkler heads & escutcheons are priced separately unless otherwise noted. Items marked "C.O." are made to order and may require longer delivery times.

Watts Regulator		
Description	Part Number	List Price
<b>Small Backflow Preventors</b>		
<b>Model 007 LF Double Check Backflow (Less Ball Valve)</b>		
3/4"	20610	\$354.00
1"	20611	\$445.00
1 1/4"	206115	\$513.50
1 1/2"	20612	\$542.00
2"	20613	\$576.50
<b>Model 007 QT Double Check Backflow (w/Ball Valve)</b>		
3/4"	20614	\$308.50
1"	20615	\$345.50
1 1/4"	206155	\$582.50
1 1/2"	20616	\$651.00
2"	20617	\$766.00
<b>Model 009 LF Reduced Pressure Backflow (Less Ball Valve)</b>		
3/4"	20618	\$484.00
1"	20619	\$503.50
1 1/2"	20485	\$943.50
2"	20620	\$993.00
<b>Model 009 QT Reduced Pressure Backflow (w/Ball Valve)</b>		
3/4"	20621	\$512.50
1"	20449	\$548.50
1 1/4"	20450	\$838.50
1 1/2"	20451	\$1,041.00
2"	20452	\$1,124.00
<b>Air Gap Drains</b>		
909AGC	20473	\$121.00
909AGF	20438	\$672.50
<b>Backflow Repair Kits</b>		
RK009RT, 3/4" - 1	20478	\$119.00
RK009RT, 1 1/4" - 2"	20479	\$176.00
RK709RT, 3/4" - 1	20480	\$133.00
RK709RT, 1 1/2" - 3	20481	\$87.50
RK709RT, 2 1/2" - 3	20457	\$265.00
RK709RT, 6"	20430	\$505.00
RK709RT, 8"	20459	\$481.00
RK909RT, 2 1/2" - 3"	20460	\$709.50
RK909RT, 4"	20461	\$761.50
RK909RT, 6"	20813	\$2,187.00
RK909RT, 8"	20462	\$1,003.00

Watts Regulator		
Description	Part Number	List Price
<b>Model 709 Double Check Valve Backflow Assembly (Less Gates)</b>		
2 1/2"	20412	\$2,871.00
3"	20472	\$3,040.00
4"	20405	\$3,366.00
6"	20407	\$5,699.00
8"	20409	\$12,601.00
10"	20411A	\$14,453.00
<b>Model 709 Double Check Valve Backflow Assembly (w/ OS&amp;Y's)</b>		
2 1/2"	20427	\$4,992.00
3"	20428	\$5,382.00
4"	20404	\$5,034.00
6"	20406	\$8,054.00
8"	20408	\$15,020.00
10"	20410	\$19,988.00
<b>Model 007/709 Double Check Detector Assembly Backflow Preventor (Less Gates)</b>		
2 1/2"	20698	\$4,131.00
3"	20634	\$5,254.00
3"	20636	\$4,272.00
4"	20490	\$5,424.00
6"	20491	\$9,562.00
8"	20492	\$13,923.00
10"	20635	\$16,670.00
<b>Model 007/709 Double Check Detector Assembly Backflow Preventor (w/ OS&amp;Y's)</b>		
2 1/2"	20663	\$6,017.00
3"	20661	\$6,216.00
3"	20664	\$6,063.00
4"	20431	\$5,036.00
6"	20444	\$8,198.00
8"	20445	\$16,051.00
10"	20662	\$20,609.00
<b>Model 009/909 Reduced Pressure Zone Backflow Preventor (Less Gates)</b>		
2 1/2"	20641	\$3,833.00
2 1/2"	20471	\$4,533.00
3"	20642	\$4,014.00
3"	20470	\$4,970.00
4"	20415	\$5,423.00
6"	20417	\$7,565.00
8"	20419	\$13,353.00
10"	20422	\$20,204.00

Section 16	Specialty Items
Section 18	Grooved Product
Section 19	CPVC Pipe & Fittings
Section 20	Miscellaneous
Section 21	Electrical
Section C	Valves & Hose Equipment
Section D	Backflow
Section F	Pipe & Accessories
Section H	Hangers
Section J	Lubricants
Section K	Misc.

Items shown on this sheet may not be stocked at all Tyco Fire Products warehouses. Please ask your local Tyco Fire Products location for availability. Freight terms may vary for non commonly stocked items. See latest Technical Data Sheets for specific Approvals, Listings, Design Parameters & available finishes. Prices subject to change without notice.

Section 16	Specialty Items
Section 18	Grooved Product
Section 19	CPVC Pipe & Fittings
Section 20	Miscellaneous
Section 21	Electrical
Section C	Valves & Hose Equipment
Section D	Backflow
Section F	Pipe & Accessories
Section H	Hangers
Section J	Lubricants
Section K	Misc.

<b>Watts Regulator</b>		
<i>Description</i>	<i>Part Number</i>	<i>List Price</i>
<b>Model 009/909 Reduced Pressure Zone Backflow Preventor (w/ OS&amp;Y's)</b>		
2 <sup>1</sup> / <sub>2</sub> "	<b>20670</b>	\$4,804.00
2 <sup>1</sup> / <sub>2</sub> "	<b>20669</b>	\$5,849.00
3"	<b>20671</b>	\$5,033.00
3"	<b>20432</b>	\$6,420.00
4"	<b>20414</b>	\$5,721.00
6"	<b>20416</b>	\$9,209.00
8"	<b>20418</b>	\$17,549.00
10"	<b>20420</b>	\$24,818.00
<b>Model 909 Reduced Pressure Zone Backflow Detector Assembly (Less Gates)</b>		
2 <sup>1</sup> / <sub>2</sub> "	<b>206761</b>	\$4,906.00
3"	<b>20647</b>	\$5,477.00
4"	<b>20475</b>	\$5,915.00
6"	<b>20476</b>	\$8,573.00
8"	<b>20477</b>	\$16,053.00
10"	<b>20648</b>	\$20,465.00
<b>Model 909 Reduced Pressure Zone Backflow Detector Assembly (w/ OS&amp;Y's)</b>		
3"	<b>20676</b>	\$7,201.00
4"	<b>20677</b>	\$7,538.00
6"	<b>20678</b>	\$11,578.00
8"	<b>20679</b>	\$16,613.00
10"	<b>20680</b>	\$22,784.00

\*See latest Technical Data Sheets for specific Approvals, Listings, Design Parameters & available finishes. Sprinkler heads & escutcheons are priced separately unless otherwise noted. Items marked "C.O." are made to order and may require longer delivery times.

SCI Coop-Let F.T.		
Part No.	Size / Description	List Price
251100	SCI Coop-Let F.T. 1/2" x 1"-1 1/2	\$7.25
251120	SCI Coop-Let F.T. 1/2" x 2"-2 1/2	\$7.25
251130	SCI Coop-Let F.T. 1/2" x 3" - 8	\$7.25
251140	SCI Coop-Let F.T. 3/4" x 1"-1 1/2	\$7.25
251150	SCI Coop-Let F.T. 3/4" x 2"-2 1/2	\$7.25
251160	SCI Coop-Let F.T. 3/4" x 2 1/2	\$7.25
251170	SCI Coop-Let F.T. 3/4" x 3" - 8	\$7.25
251180	SCI Coop-Let F.T. 1" x 1 1/4"-1 1/2	\$10.25
251190	SCI Coop-Let F.T. 1" x 2"-2 1/2	\$10.25
251200	SCI Coop-Let F.T. 1" x 2 1/2	\$10.25
251210	SCI Coop-Let F.T. 1" x 3" - 4	\$10.25
251220	SCI Coop-Let F.T. 1" x 5" - 8	\$10.25
251230	SCI Coop-Let F.T. 1 1/4" x 1 1/2	\$16.00
251240	SCI Coop-Let F.T. 1 1/4" x 2	\$16.00
251250	SCI Coop-Let F.T. 1 1/4" x 2 1/2	\$16.00
251260	SCI Coop-Let F.T. 1 1/4" x 3" - 4	\$16.00
251270	SCI Coop-Let F.T. 1 1/4" x 5" - 8	\$16.00
251280	SCI Coop-Let F.T. 1 1/2" x 2	\$20.50
251290	SCI Coop-Let F.T. 1 1/2" x 2 1/2	\$20.50
251300	SCI Coop-Let F.T. 1 1/2" x 3	\$20.50
251310	SCI Coop-Let F.T. 1 1/2" x 4"- 5	\$20.50
251320	SCI Coop-Let F.T. 1 1/2" x 6"- 8	\$20.50
251330	SCI Coop-Let F.T. 2" x 2 1/2	\$27.75
251340	SCI Coop-Let F.T. 2" x 3	\$27.75
251350	SCI Coop-Let F.T. 2" x 4"- 5	\$27.75
251360	SCI Coop-Let F.T. 2" x 6"- 8	\$27.75
251370	SCI Coop-Let F.T. 2 1/2" x 3	\$46.75
251380	SCI Coop-Let F.T. 2 1/2" x 4	\$46.75
251390	SCI Coop-Let F.T. 2 1/2" x 6	\$46.75
251400	SCI Coop-Let F.T. 2 1/2" x 8	\$46.75
251410	SCI Coop-Let F.T. 3" x 4	\$90.75
251420	SCI Coop-Let F.T. 3" x 6	\$90.75
251430	SCI Coop-Let F.T. 3" x 8	\$90.75
251440	SCI Coop-Let F.T. 4" x 6	\$143.00
251450	SCI Coop-Let F.T. 4" x 8	\$143.00

SCI Coop-Let Grooved		
Part No.	Size / Description	List Price
251460	SCI Coop-Let Grvd 1 1/4" x 1 1/2	\$18.25
251470	SCI Coop-Let Grvd 1 1/4" x 2	\$18.25
251480	SCI Coop-Let Grvd 1 1/4" x 2 1/2	\$18.25
251490	SCI Coop-Let Grvd 1 1/4" x 3	\$18.25
251500	SCI Coop-Let Grvd 1 1/4" x 4"- 5	\$18.25
251510	SCI Coop-Let Grvd 1 1/4" x 6	\$18.25
251520	SCI Coop-Let Grvd 1 1/4" x 8	\$18.25
251530	SCI Coop-Let Grvd 1 1/2" x 2	\$20.75
251540	SCI Coop-Let Grvd 1 1/2" x 2 1/2	\$20.75
251550	SCI Coop-Let Grvd 1 1/2" x 3	\$20.75
251560	SCI Coop-Let Grvd 1 1/2" x 4"- 5	\$20.75
251570	SCI Coop-Let Grvd 1 1/2" x 6	\$20.75
251580	SCI Coop-Let Grvd 1 1/2" x 8	\$20.75
251590	SCI Coop-Let Grvd 2" x 2 1/2	\$22.50
251600	SCI Coop-Let Grvd 2" x 3	\$22.50
251610	SCI Coop-Let Grvd 2" x 4"- 5	\$22.50
251620	SCI Coop-Let Grvd 2" x 6	\$22.50
251630	SCI Coop-Let Grvd 2" x 8	\$22.50
251640	SCI Coop-Let Grvd 2 1/2" x 3	\$26.00
251650	SCI Coop-Let Grvd 2 1/2" x 4	\$26.00
251660	SCI Coop-Let Grvd 2 1/2" x 6	\$26.00
251670	SCI Coop-Let Grvd 2 1/2" x 8	\$26.00
251680	SCI Coop-Let Grvd 3" x 4	\$34.75
251690	SCI Coop-Let Grvd 3" x 6	\$34.75
251700	SCI Coop-Let Grvd 3" x 8	\$34.75
251710	SCI Coop-Let Grvd 4" x 6	\$62.25
251720	SCI Coop-Let Grvd 4" x 8	\$62.25
251730	SCI Coop-Let Grvd 6" x 8	\$145.00

Section 16	Specialty Items
Section 18	Grooved Product
Section 19	CPVC Pipe & Fittings
Section 20	Miscellaneous
Section 21	Electrical
Section C	Valves & Hose Equipment
Section D	Backflow
Section F	Pipe & Accessories
Section H	Hangers
Section J	Lubricants
Section K	Misc.

Items shown on this sheet may not be stocked at all Tyco Fire Products warehouses. Please ask your local Tyco Fire Products location for availability. Freight terms may vary for non commonly stocked items. See latest Technical Data Sheets for specific Approvals, Listings, Design Parameters & available finishes. Prices subject to change without notice.



Section 16  
Specialty Items

Section 18  
Grooved Product

Section 19  
CPVC Pipe & Fittings

Section 20  
Miscellaneous

Section 21  
Electrical

Section C  
Valves & Hose Equipment

Section D  
Backflow

Section F  
Pipe & Accessories

Section H  
Hangers

Section J  
Lubricants

Section K  
Misc.

<b>Merit</b>		
<i>Size/Description</i>	<i>Part No.</i>	<i>List Price</i>
<b>Grooved Outlets – Sch. 40</b>		
Tee-Let 1 <sup>1</sup> / <sub>4</sub> " x 1 <sup>1</sup> / <sub>4</sub> "	<b>15250</b>	\$21.00
Tee-Let 1 <sup>1</sup> / <sub>2</sub> " x 1 <sup>1</sup> / <sub>2</sub> "	<b>15500</b>	\$22.75
Tee-Let 2" x 2"	<b>15750</b>	\$24.75
Tee-Let 2 <sup>1</sup> / <sub>2</sub> " x 2 <sup>1</sup> / <sub>2</sub> "	<b>16100</b>	\$35.00
Tee-Let 3" x 3"	<b>16400</b>	\$45.75
Tee-Let 4" x 4"	<b>16700</b>	\$71.50
Tee-Let 6" x 6"	<b>16900</b>	\$144.50
Tee-Let 8" x 8"	<b>17000</b>	\$183.00
<b>Grooved Outlets – Sch. 10</b>		
Tee-Let 2 <sup>1</sup> / <sub>2</sub> " x 2 <sup>1</sup> / <sub>2</sub> ", Sch. 10	<b>17025</b>	\$30.50
Tee-Let 3" x 3", Sch. 10	<b>17031</b>	\$40.50
Tee-Let 4" x 4", Sch. 10	<b>17037</b>	\$60.25
Tee-Let 6" x 6", Sch. 10	<b>17044</b>	\$120.00
<b>Adjustable Drop Nipples</b>		
<i>Size/Description</i>	<i>Part No.</i>	<i>List Price</i>
1" x <sup>1</sup> / <sub>2</sub> ", 4.1" – 5.1", Model #M1.150	<b>3201</b>	\$29.25
1" x <sup>1</sup> / <sub>2</sub> ", 6.1" – 9.1", Model #M3.150	<b>3202</b>	\$38.75
1" x <sup>1</sup> / <sub>2</sub> ", 3.5" – 4.5", Model #F1.150	<b>3204</b>	\$30.00
1" x <sup>1</sup> / <sub>2</sub> ", 4.5" – 6.5", Model #F2.150	<b>3205</b>	\$30.00
1" x <sup>1</sup> / <sub>2</sub> ", 5.5" – 8.5", Model #F3.150	<b>3206</b>	\$33.75
1" x <sup>3</sup> / <sub>4</sub> ", 6.82" – 10", Model #F3.175	<b>3207</b>	\$38.75
<b>Welded Flange</b>		
<i>Size</i>	<i>Part No.</i>	<i>List Price</i>
2"	<b>41001</b>	\$74.00
2 <sup>1</sup> / <sub>2</sub> "	<b>41002</b>	\$101.50
3"	<b>41003</b>	\$124.00
4"	<b>41004</b>	\$150.00
6"	<b>41006</b>	\$224.00
8"	<b>41008</b>	\$345.00
10"	<b>41010</b>	\$587.00
12"	<b>41011</b>	\$804.00

<b>Flexhead</b>		
<b>Flexible Drop Nipples</b>		
<i>Size/Description</i>	<i>Part No.</i>	<i>Net Price</i>
#2024 1 <sup>1</sup> / <sub>2</sub> " x 24"	<b>88100</b>	\$28.25
#2024 3 <sup>3</sup> / <sub>4</sub> " x 24"	<b>88105</b>	\$28.25
#2036 1 <sup>1</sup> / <sub>2</sub> " x 36"	<b>88101</b>	\$32.50
#2036 3 <sup>3</sup> / <sub>4</sub> " x 36"	<b>88106</b>	\$32.50
#2048 1 <sup>1</sup> / <sub>2</sub> " x 48"	<b>88102</b>	\$36.75
#2048 3 <sup>3</sup> / <sub>4</sub> " x 48"	<b>88107</b>	\$36.75
#2060 1 <sup>1</sup> / <sub>2</sub> " x 60"	<b>88103</b>	\$40.75
#2060 3 <sup>3</sup> / <sub>4</sub> " x 60"	<b>88108</b>	\$40.75
#2072 1 <sup>1</sup> / <sub>2</sub> " x 72"	<b>88104</b>	\$45.25
#2072 3 <sup>3</sup> / <sub>4</sub> " x 72"	<b>88109</b>	\$45.25

<b>SprinkFlex</b>		
<b>Flexible Drop Nipples</b>		
<i>Size/Description</i>	<i>Part No.</i>	<i>Net Price</i>
SFN28H 1/2" NPT x 28" Unbraided	<b>88111N</b>	\$24.50
SFN28T 3/4" NPT x 28" Unbraided	<b>88112N</b>	\$24.50
SFN40H 1/2" NPT x 40" Unbraided	<b>88113N</b>	\$26.00
SFN40T 3/4" NPT x 40" Unbraided	<b>88114N</b>	\$26.00
SFN48H 1/2" NPT x 48" Unbraided	<b>88115N</b>	\$27.75
SFN48T 3/4" NPT x 48" Unbraided	<b>88116N</b>	\$27.75
SFN59H 1/2" NPT x 59" Unbraided	<b>88117N</b>	\$30.00
SFN59T 3/4" NPT x 59" Unbraided	<b>88118N</b>	\$30.00
SFN71H 1/2" NPT x 71" Unbraided	<b>88119N</b>	\$32.75
SFN71T 3/4" NPT x 71" Unbraided	<b>88120N</b>	\$32.75
SFB28H 1/2" NPT x 28 Braided	<b>88121B</b>	\$30.75
SFB28T 3/4" NPT x 28 Braided	<b>88122B</b>	\$30.75
SFB40H 1/2" NPT x 40" Braided	<b>88123B</b>	\$34.25
SFB40T 3/4" NPT x 40 Braided	<b>88124B</b>	\$34.25
SFB48H 1/2" NPT x 48 Braided	<b>88125B</b>	\$37.00
SFB48T 3/4" NPT x 48 Braided	<b>88126B</b>	\$37.00
SFB59H 1/2" NPT x 59" Braided	<b>88127B</b>	\$40.50
SFB59T 3/4" NPT x 59" Braided	<b>88128B</b>	\$40.50
SFB71H 1/2" NPT x 71" Braided	<b>88129B</b>	\$44.00
SFB71T 3/4" NPT x 71 Braided	<b>88130B</b>	\$44.00

\*See latest Technical Data Sheets for specific Approvals, Listings, Design Parameters & available finishes. Sprinkler heads & escutcheons are priced separately unless otherwise noted. Items marked "C.O." are made to order and may require longer delivery times.

Test/Drain Assemblies		
Size/Description	Part No.	List Price
1" "Sure Test"	2391	\$302.00
1 1/4" "Sure Test"	2399	\$363.50
1" #132 Inspection Test w/ Prv	21232	\$166.00

Sight Drains		
Size/Description	Part No.	List Price
1" Sight Drain	2285	\$72.25
1 1/4" Sight Drain	2286	\$86.25
1 1/2" Sight Drain	2287	\$70.00
2" Sight Drain	2288	\$125.00
1" Sight Drain w/ 1/2" orifice	2292	\$50.25
1" x 1/2" Orifice Union	2293	\$39.75

#71 Flange Adapter - Bolt, Nut, Gasket Kits		
Size	Part No.	List Price
2"	50240	See Section 18 for current list prices
2 1/2"	50241	
3"	50242	
4"	50243	
5"	50248	
6"	50244	
8"	50245	
10"	50246	
12"	50247	

Red Rubber Gaskets		
Size	Part No.	List Price
2"	50220	\$1.10
2 1/2"	50208	\$1.45
3"	50209	\$1.75
4"	50210	\$2.45
5"	50225	\$3.10
6"	50211	\$4.00
8"	50212	\$4.85
10"	50217	\$6.05
12"	50219	\$8.80

Split One			
Split Rings Plastic Floor and Ceiling Plates Chrome (Plastic)			
box qty.	Size	Part No.	List Price
12	1/2"	1430	\$1.20
12	1"	1432	\$1.30
12	1 1/4"	1433	\$1.90
12	1 1/2"	1434	\$2.05
12	2"	1435	\$2.25
12	2 1/2"	1436	\$5.35
12	3"	1437	\$5.50
6	6"	1440	\$12.00
6	8"	1441	\$21.50
Split Rings Plastic Floor and Ceiling Plates White (Plastic)			
box qty.	Size	Part No.	List Price
12	1"	1420	\$0.90
12	1 1/4"	1421	\$0.90
12	1 1/2"	1422	\$1.00
12	2"	1423	\$1.05
12	2 1/2"	1424	\$2.10
12	3"	1425	\$2.20
12	4"	1426A	\$2.30
6	6"	1428	\$7.30

Section 16	Specialty Items
Section 18	Grooved Product
Section 19	CPVC Pipe & Fittings
Section 20	Miscellaneous
Section 21	Electrical
Section C	Valves & Hose Equipment
Section D	Backflow
Section F	Pipe & Accessories
Section H	Hangers
Section J	Lubricants
Section K	Misc.

Items shown on this sheet may not be stocked at all Tyco Fire Products warehouses. Please ask your local Tyco Fire Products location for availability. Freight terms may vary for non commonly stocked items. See latest Technical Data Sheets for specific Approvals, Listings, Design Parameters & available finishes. Prices subject to change without notice.



Section 16	Specialty Items
Section 18	Grooved Product
Section 19	CPVC Pipe & Fittings
Section 20	Miscellaneous
Section 21	Electrical
Section C	Valves & Hose Equipment
Section D	Backflow
Section F	Pipe & Accessories
Section H	Hangers
Section J	Lubricants
Section K	Misc.

Flanged Fittings		
Flanged 90° Elbow		
Size	Part No.	List Price
2 1/2"	500000	\$272.50
3"	500001A	\$254.00
4"	500002A	\$335.00
6"	500003A	\$535.50
8"	500004A	\$793.00
10"	500005A	\$1,531.00
12"	500006	\$2,202.00
Flanged 45° Elbow		
Size	Part No.	List Price
2 1/2"	500007	\$304.00
3"	500008	\$482.00
4"	500009	\$506.00
6"	500010A	\$578.50
8"	500011A	\$1,243.00
10"	500012A	\$2,610.00
12"	500013A	\$3,989.00
Flanged Straight Tee		
Size	Part No.	List Price
2 1/2"	500014A	\$402.50
3"	500015A	\$397.00
4"	500016A	\$612.50
6"	500017	\$771.50
8"	500018	\$1,200.00
10"	500019	\$3,464.00
12"	500020	\$5,456.00
Flanged Reducing Tee		
Size	Part No.	List Price
4" x 2 1/2"	500083	\$623.00
4" x 3"	500036	\$701.00
6" x 3"	500037	\$959.00
6" x 4"	500038	\$892.50
8" x 4"	500041	\$1,502.00
8" x 6"	500042A	\$1,398.00
6" x 4" x 4"	500039	\$1,427.00
6" x 4" x 6"	500040	\$1,427.00
8" x 6" x 6"	500043A	\$2,261.00
8" x 6" x 8"	500044	\$2,295.00
10" x 4"	500045	\$2,121.00
10" x 6"	500046	\$4,234.00
10" x 8"	500047	\$2,313.00
12" x 4"	500048	\$3,534.00
12" x 6"	500049	\$3,534.00
12" x 8"	500050	\$3,534.00
12" x 10"	500051	\$6,375.00

Flanged Fittings		
Cast Iron Companion Flange		
Size	Part No.	List Price
2" x 6"	86710	\$42.25
2 1/2" x 7"	86711	\$61.50
3" x 7 1/2"	86712	\$78.75
4" x 9"	86713	\$116.50
6" x 11"	86714	\$167.00
8" x 13 1/2"	86715	\$264.00
Flanged Concentric Reducer		
Size	Part No.	List Price
4" x 2 1/2"	500086	\$560.00
4" x 2"	500126	\$560.00
4" x 3"	500052	\$567.00
6" x 3"	500053	\$1,035.00
6" x 4"	500054	\$862.50
8" x 4"	500055	\$1,073.00
8" x 6"	500056	\$940.00
10" x 4"	500057	\$1,035.00
10" x 6"	500058	\$1,008.00
10" x 8"	500059	\$2,391.00
12" x 4"	500060	\$5,287.00
12" x 6"	500061	\$4,769.00
12" x 8"	500062	\$4,609.00
12" x 10"	500063	\$4,160.00
Blind Flange		
Size	Part No.	List Price
2 1/2"	500021	\$77.25
3"	500022A	\$80.00
4"	500023A	\$118.00
6"	500024A	\$294.00
8"	500025A	\$457.50
10"	500026A	\$507.50
12"	500027A	\$709.00
Long Radius Flanged 90° Elbow		
Size	Part No.	List Price
4"	500028	\$494.50
6"	500029	\$829.00
8"	500030	\$2,231.00
10"	500031	\$3,567.00
12"	500032A	\$3,274.00
Floor Flange		
Size	Part No.	List Price
1"	500110	\$35.25
1 1/4"	500111A	\$42.00
1 1/2"	500112A	\$53.50
2"	500113A	\$55.00

\*See latest Technical Data Sheets for specific Approvals, Listings, Design Parameters & available finishes. Sprinkler heads & escutcheons are priced separately unless otherwise noted. Items marked "C.O." are made to order and may require longer delivery times.

Flanged Fittings		
Flanged Reducing 90° Elbow		
Size	Part No.	List Price
4" x 2 1/2"	500125A	\$901.50
4" x 3"	500064	\$762.00
6" x 4"	500065	\$878.50
8" x 6"	500066	\$1,294.00
Flanged Bull Tee		
4" x 4" x 6"	500067	\$2,278.00
Flanged Eccentric Reducer		
6" x 4"	500069	\$848.00
6" x 5"	500090	\$868.00
8" x 4"	500091	\$1,000.00
8" x 5"	500092	\$1,801.00
8" x 6"	500070	\$1,357.00

Ductile Iron Fittings			
#811 Ductile Iron 90° Elbows			
Size	Part No.	List Price	Box Qty.
1/2"	86206	\$4.30	240
3/4"	86205	\$4.40	120
1"	86200	\$5.60	70
1 1/4"	86201	\$7.75	40
1 1/2"	86202	\$11.75	30
2"	86203	\$19.00	20
2 1/2"	86204	\$37.75	10
#813 Ductile Iron 45° Elbows			
1/2"	86780	\$6.45	250
3/4"	86781	\$6.35	150
1"	86280	\$7.55	90
1 1/4"	86281	\$10.20	50
1 1/2"	86282	\$17.00	35
2"	86283	\$19.50	18
2 1/2"	86782	\$48.25	12
#814 Ductile Iron Tees			
1/2"	86340	\$6.40	150
3/4"	86341	\$7.65	90
1"	86230	\$7.05	60
1 1/4"	86231	\$13.00	35
1 1/2"	86232	\$16.75	24
2"	86233	\$23.00	12
2 1/2"	86234	\$56.75	8

Ductile Iron Fittings			
#818 Ductile Iron Couplings			
Size	Part No.	List Price	Box Qty.
1/2"	72779	\$2.90	360
3/4"	72778	\$3.50	200
1"	72755	\$4.60	110
1 1/4"	72754	\$6.80	75
1 1/2"	72753	\$9.60	60
2"	72752	\$14.25	30
2 1/2"	72758	\$27.50	18
#820 Ductile Iron Caps			
1/2"	72776	\$3.15	500
3/4"	72777	\$3.80	300
1"	72824	\$5.80	180
1 1/4"	72756	\$7.40	110
1 1/2"	72822	\$9.80	80
2"	72823	\$14.00	45
2 1/2"	72825	\$39.00	25
#817 Ductile Iron Crosses			
1"	86284	\$21.00	45
1 1/4"	86285	\$29.00	25
1 1/2"	86286	\$37.75	20
2"	86287	\$53.25	10
#719 Ductile Iron Plugs			
1/2"	86292	\$1.65	500
3/4"	86293	\$2.05	300
1"	86294	\$2.95	200
1 1/4"	86295	\$4.20	110
1 1/2"	86296	\$5.10	80
2"	86297	\$6.80	45
#825 Ductile Iron Extension Pieces			
1/2" x 1 1/2"	72751	\$6.85	300
1/2" x 2"	72980	\$6.80	250
3/4" x 1 1/2"	72981	\$10.00	250
3/4" x 2"	72982	\$10.20	200
#817 Ductile Iron Reducing Crosses			
1 1/4" x 1 1/4" x 1" x 1"	86289	\$29.00	30
1 1/2" x 1 1/2" x 1" x 1"	86322	\$37.75	24
2" x 2" x 1" x 1"	86291	\$54.75	10
#827 Ductile Iron Hex Bushings			
1" x 1/2"	72726	\$5.20	280
1" x 3/4"	72762	\$5.10	280
1 1/4" x 1"	72763	\$5.65	150
1 1/2" x 1"	72757	\$6.65	100
1 1/2" x 1 1/4"	72764	\$6.65	100
2" x 1"	72759	\$8.25	80
2" x 1 1/4"	72761	\$8.25	80
2" x 1 1/2"	72775	\$8.35	80

Section 16	Specialty Items
Section 18	Grooved Product
Section 19	CPVC Pipe & Fittings
Section 20	Miscellaneous
Section 21	Electrical
Section C	Valves & Hose Equipment
Section D	Backflow
Section F	Pipe & Accessories
Section H	Hangers
Section J	Lubricants
Section K	Misc.

Items shown on this sheet may not be stocked at all Tyco Fire Products warehouses. Please ask your local Tyco Fire Products location for availability. Freight terms may vary for non commonly stocked items. See latest Technical Data Sheets for specific Approvals, Listings, Design Parameters & available finishes. Prices subject to change without notice.

Section 16	Specialty Items
Section 18	Grooved Product
Section 19	CPVC Pipe & Fittings
Section 20	Miscellaneous
Section 21	Electrical
Section C	Valves & Hose Equipment
Section D	Backflow
Section F	Pipe & Accessories
Section H	Hangers
Section J	Lubricants
Section K	Misc.

Ductile Iron Fittings			
#816 Ductile Iron Reducing Couplings			
Size	Part No.	List Price	Box Qty.
3/4" x 1/2"	86772	\$4.00	150
1" x 1/2"	86228	\$5.90	140
1" x 3/4"	86229	\$8.05	120
#830 Ductile Iron Unions			
1/2"	86207	\$20.75	110
3/4"	86275	\$24.75	80
1"	86276	\$35.00	50
1 1/4"	86277	\$42.25	35
1 1/2"	86278	\$56.00	25
2"	86279	\$78.50	18
#812 Ductile Iron Reducing 90° Elbows			
3/4" x 1/2"	86342	\$4.45	160
1" x 1/2"	86210	\$6.10	110
1" x 3/4"	86211	\$6.00	90
1 1/4" x 1/2"	86212	\$12.50	75
1 1/4" x 3/4"	86213	\$10.60	60
1 1/4" x 1"	86214	\$9.55	55
1 1/2" x 3/4"	86221	\$15.25	45
1 1/2" x 1"	86215	\$13.50	40
1 1/2" x 1 1/4"	86216	\$13.50	35
2" x 3/4"	86217	\$22.25	30
2" x 1"	86218	\$22.25	25
2" x 1 1/2"	86220	\$23.25	20
2 1/2" x 2"	86762	\$53.25	15

Ductile Iron Fittings			
#815 Ductile Iron Reducing Tees			
Size	Part No.	List Price	Box Qty.
3/4" x 3/4" x 1/2"	86235	\$10.70	95
3/4" x 3/4" x 1"	86755	\$12.00	65
1" x 1/2" x 1"	86236	\$8.55	55
1" x 3/4" x 1/2"	86756	\$13.00	80
1" x 3/4" x 3/4"	86757	\$12.00	65
1" x 3/4" x 1"	86237	\$10.05	55
1" x 1" x 1/2"	86238	\$7.85	65
1" x 1" x 3/4"	86239	\$9.55	60
1" x 1" x 1 1/4"	86240	\$13.00	45
1" x 1" x 1 1/2"	86241	\$22.50	35
1 1/4" x 1" x 1/2"	86242	\$12.75	50
1 1/4" x 1" x 3/4"	86243	\$14.75	50
1 1/4" x 1" x 1"	86244	\$13.00	45
1 1/4" x 1" x 1 1/4"	86245	\$12.75	40
1 1/4" x 1" x 1 1/2"	86246	\$16.75	30
1 1/4" x 1 1/4" x 1/2"	86247	\$13.00	45
1 1/4" x 1 1/4" x 3/4"	86248	\$13.75	45
1 1/4" x 1 1/4" x 1"	86249	\$12.75	40
1 1/4" x 1 1/4" x 1 1/2"	86250	\$22.25	30
1 1/4" x 1 1/4" x 2"	86251	\$34.50	24
1 1/2" x 1" x 1/2"	86252	\$25.75	40
1 1/2" x 1" x 3/4"	86253	\$24.25	40
1 1/2" x 1" x 1"	86254	\$22.25	30
1 1/2" x 1" x 1 1/2"	86256	\$16.75	30
1 1/2" x 1 1/4" x 1/2"	86257	\$17.75	40
1 1/2" x 1 1/4" x 3/4"	86258	\$18.75	40
1 1/2" x 1 1/4" x 1"	86259	\$16.75	30
1 1/2" x 1 1/4" x 2"	86260	\$34.25	20
1 1/2" x 1 1/2" x 1/2"	86261	\$16.50	35
1 1/2" x 1 1/2" x 3/4"	86262	\$17.75	35
1 1/2" x 1 1/2" x 1"	86263	\$16.75	30
1 1/2" x 1 1/2" x 1 1/4"	86264	\$22.50	30
1 1/2" x 1 1/2" x 2"	86265	\$34.00	20
2" x 1" x 2"	86266	\$23.50	15
2" x 1 1/4" x 2"	86267	\$25.25	15
2" x 1 1/2" x 1/2"	86268	\$26.75	30
2" x 1 1/2" x 3/4"	86269	\$27.00	25
2" x 1 1/2" x 1"	86270	\$23.50	20
2" x 1 1/2" x 1 1/2"	86272	\$33.75	20
2" x 1 1/2" x 2"	86273	\$26.75	15
2" x 2" x 1/2"	86222	\$23.25	20
2" x 2" x 3/4"	86223	\$23.25	20
2" x 2" x 1"	86224	\$23.50	20
2" x 2" x 1 1/4"	86225	\$25.25	20
2" x 2" x 1 1/2"	86226	\$27.00	15
2" x 2" x 2 1/2"	86227	\$64.75	10
2 1/2" x 2" x 3/4"	86274	\$63.00	15

\*See latest Technical Data Sheets for specific Approvals, Listings, Design Parameters & available finishes. Sprinkler heads & escutcheons are priced separately unless otherwise noted. Items marked "C.O." are made to order and may require longer delivery times.

<b>Ductile Iron Fittings</b>			
<b>Central Sprinkler California Fittings</b>			
<i>Size</i>	<i>Part No.</i>	<i>List Price</i>	<i>Box Qty.</i>
<b>Male Outlet Red. Tee</b>			
1" x 1/2" x 1"	42000	\$13.50	50
<b>Male 90° Street Elbow</b>			
1" x 1"	42002	\$13.00	80
1" x 1/2"	42003	\$13.25	60

<b>Standard Black Nipple</b>		
<i>Size</i>	<i>Part No.</i>	<i>List Price</i>
1/4" x Close	60103	\$1.80
1/4" x 2"	60271	\$1.90
1/4" x 2 1/2"	60272	\$2.40
1/4" x 3"	60270	\$2.40
1/4" x 3 1/2"	60267	\$2.80
1/4" x 4"	60143	\$2.80
1/4" x 4 1/2"	60268	\$4.30
1/4" x 5"	60266	\$4.30
1/4" x 5 1/2"	60265	\$5.10
1/4" x 6"	60144	\$5.10
1/2" x Close	60145	\$1.60
1/2" x 1 1/2"	60146	\$1.60
1/2" x 2"	60147	\$1.60
1/2" x 2 1/2"	60148	\$1.90
1/2" x 3"	60175	\$1.90
1/2" x 3 1/2"	60176	\$2.25
1/2" x 4"	60149	\$2.25
1/2" x 4 1/2"	60177	\$2.60
1/2" x 5"	60178	\$2.60
1/2" x 5 1/2"	60179	\$2.90
1/2" x 6"	60180	\$2.90
3/4" x Close	60181	\$1.80
3/4" x 2"	60150	\$1.85
3/4" x 2 1/2"	60151	\$2.15
3/4" x 3"	60152	\$2.15
3/4" x 3 1/2"	60182	\$2.70
3/4" x 4"	60183	\$3.50
3/4" x 4 1/2"	60184	\$3.30
3/4" x 5"	60185	\$3.30
3/4" x 5 1/2"	60186	\$3.85
3/4" x 6"	60187	\$5.25
1" x Close	60104	\$2.60
1" x 2"	60105	\$2.80
1" x 2 1/2"	60106	\$3.00
1" x 3"	60107	\$3.00
1" x 3 1/2"	60108	\$3.75
1" x 4"	60109	\$3.75
1" x 4 1/2"	60110	\$4.40
1" x 5"	60111	\$4.40
1" x 5 1/2"	60112	\$5.25
1" x 6"	60113	\$5.25
1" x 7"	60196	\$8.45
1" x 8"	60198	\$8.45
1" x 9"	60200	\$10.05
1" x 10"	60202	\$10.05
1" x 11"	60204	\$11.50
1" x 12"	60206	\$11.50
1 1/4" x Close	60114	\$3.30
1 1/4" x 2"	60115	\$3.65
1 1/4" x 2 1/2"	60116	\$3.95
1 1/4" x 3"	60117	\$3.95

Section 16	Specialty Items
Section 18	Grooved Product
Section 19	CPVC Pipe & Fittings
Section 20	Miscellaneous
Section 21	Electrical
Section C	Valves & Hose Equipment
Section D	Backflow
Section F	Pipe & Accessories
Section H	Hangers
Section J	Lubricants
Section K	Misc.

Items shown on this sheet may not be stocked at all Tyco Fire Products warehouses. Please ask your local Tyco Fire Products location for availability. Freight terms may vary for non commonly stocked items. See latest Technical Data Sheets for specific Approvals, Listings, Design Parameters & available finishes. Prices subject to change without notice.

Section	Standard Black Nipple		
	Size	Part No.	List Price
Section 16 Specialty Items	1 1/4" x 3 1/2"	60118	\$4.55
	1 1/4" x 4"	60119	\$4.55
	1 1/4" x 4 1/2"	60120	\$5.60
Section 18 Grooved Product	1 1/4" x 5"	60121	\$5.60
	1 1/4" x 5 1/2"	60122	\$6.65
	1 1/4" x 6"	60123	\$6.65
	1 1/4" x 7"	60216	\$10.75
	1 1/4" x 8"	60291	\$10.75
	1 1/4" x 9"	60293	\$13.00
	1 1/4" x 10"	60294	\$13.00
	1 1/4" x 11"	60295	\$15.00
	1 1/4" x 12"	60296	\$14.75
Section 19 CPVC Pipe & Fittings	1 1/2" x Close	60124	\$4.10
	1 1/2" x 2"	60125	\$4.45
	1 1/2" x 2 1/2"	60126	\$4.95
	1 1/2" x 3"	60127	\$4.95
	1 1/2" x 3 1/2"	60128	\$5.55
Section 20 Miscellaneous	1 1/2" x 4"	60129	\$5.55
	1 1/2" x 4 1/2"	60130	\$6.80
	1 1/2" x 5"	60131	\$6.80
Section 21 Electrical	1 1/2" x 5 1/2"	60132	\$7.75
	1 1/2" x 6"	60133	\$7.75
	1 1/2" x 7"	60157	\$12.50
	1 1/2" x 8"	60159	\$12.50
	1 1/2" x 9"	60170	\$14.50
Section C Valves & Hose Equipment	1 1/2" x 10"	60171	\$14.50
	2" x Close	60134	\$5.55
	2" x 2 1/2"	60135	\$6.40
	2" x 3"	60136	\$6.40
	2" x 3 1/2"	60137	\$7.60
	2" x 4"	60138	\$7.65
	2" x 4 1/2"	60160	\$8.90
	2" x 5"	60139	\$8.90
	2" x 5 1/2"	60140	\$10.40
	2" x 6"	60141	\$10.40
Section D Backflow	2" x 7"	60173	\$16.25
	2" x 8"	60207	\$17.50
	2" x 9"	60208	\$20.50
	2" x 10"	60209	\$21.00
	2" x 11"	60210	\$24.00
	2" x 12"	60168	\$22.00
	2 1/2" x Close	60142	\$17.25
	2 1/2" x 3"	60161	\$17.75
	2 1/2" x 3 1/2"	60162	\$20.50
	2 1/2" x 4"	60163	\$20.50
Section F Pipe & Accessories	2 1/2" x 4 1/2"	60164	\$22.50
	2 1/2" x 5"	60165	\$22.50
	2 1/2" x 5 1/2"	60166	\$24.00
Section H Hangers	2 1/2" x 6"	60167	\$24.00
	4" x Close	60299	\$31.75

Extra Heavy Black Nipple		
Size	Part No.	List Price
1/2" x Close	60153	\$2.60
1/2" x 2"	60154	\$2.60
1/2" x 2 1/2"	60211	\$3.10
1/2" x 3"	60212	\$3.10
1/2" x 4"	60194	\$3.80
3/4" x Close	60213	\$3.00
3/4" x 1 1/2"	60192	\$3.00
3/4" x 2"	60286	\$2.80
3/4" x 2 1/2"	60190	\$3.65
3/4" x 3"	60191	\$3.65

Galvanized Nipple		
Size	Part No.	List Price
1/4" x 2 1/2"	60223	\$3.10
1/2" x Close	60226	\$1.80
1/2" x 2"	60227	\$1.90
1/2" x 3"	60228	\$2.25
1/2" x 4"	60229	\$2.80
1/2" x 5"	60230	\$3.30
1/2" x 6"	86323	\$3.75
3/4" x Close	86324	\$2.20
3/4" x 2"	60260	\$2.65
3/4" x 3"	60261	\$2.70
3/4" x 4"	86326	\$3.30
3/4" x 5"	60262	\$4.15
3/4" x 6"	60219	\$4.85
1" x Close	50142	\$3.30
1" x 2"	50143	\$3.50
1" x 2 1/2"	50144	\$4.20
1" x 3"	50145	\$3.85
1" x 4"	60221	\$4.60
1" x 5"	50149	\$6.25
1" x 6"	60222	\$6.30
1 1/2" x Close	50168	\$4.95
1 1/2" x 2"	50169	\$5.70
1 1/2" x 4"	50173	\$8.95
2" x 2 1/2"	50179	\$8.10
2" x 3"	50180	\$8.70
2 1/2" x 3"	50188	\$20.25

\*See latest Technical Data Sheets for specific Approvals, Listings, Design Parameters & available finishes. Sprinkler heads & escutcheons are priced separately unless otherwise noted. Items marked "C.O." are made to order and may require longer delivery times.

<b>Erico Hangers</b>			
<b>CPVC Hanger - One Hole Strap - #107</b>			
box qty.	Size	Part No.	List Price (ea.)
100	3/4"	90360	\$1.15
100	1"	90361	\$1.25
100	1 1/4"	90362	\$1.25
100	1 1/2"	90363	\$1.30
100	2"	90364	\$1.55
<b>CPVC Hanger - Two Hole Strap - #108</b>			
100	3/4"	90365	\$1.20
100	1"	90366	\$1.25
100	1 1/4"	90367	\$1.30
100	1 1/2"	90368	\$1.30
100	2"	90369	\$1.55
<b>CPVC Hanger - Side Mount Strap - #109</b>			
100	3/4"	90370	\$1.70
100	1"	90371	\$1.70
100	1 1/4"	90372	\$1.80
100	1 1/2"	90373	\$1.90
100	2"	90374	\$2.10
<b>CPVC Hanger - No-Block Hangers</b>			
100	3/4"	NB 75	\$2.10
100	1"	NB 1	\$2.10
100	1 1/4"	NB 125	\$2.25
100	1 1/2"	NB 15	\$2.50
100	2"	NB 2	\$2.70
<b>CPVC Hanger - Head-Set Bracket</b>			
100	HS1		\$3.55
<b>CPVC Surge Restraint</b>			
100	90375		\$2.40
<b>Heavy Duty Swivel Hanger - Model 115</b>			
100	1"	150100	\$0.80
100	1 1/4"	150125	\$0.70
100	1 1/2"	150150	\$0.70
100	2"	150200	\$0.90
50	2 1/2"	150250	\$1.85
50	3"	115300	\$1.85
25	4"	115400	\$2.95
25	5"	115500	\$5.10
20	6"	115600	\$5.20
15	8"	115800	\$6.05

<b>Erico Hangers</b>			
<b>Beam Clamps Universal/Reversible Double Rod Hole - Model 300</b>			
box qty.	Size	Part No.	List Price (ea.)
100	3/8"	300038	\$2.25
50	1/2"	300050	\$4.10
<b>Heavy Duty Beam Clamps - Model 547</b>			
-	3/8"	494470	\$8.95
<b>Beam Clamps Big Mouth Double Rod Hole - Model 310</b>			
5"	3/8"	310038	\$6.05
50	1/2"	310050	\$7.55
<b>Steel C-Clamp - Model 200</b>			
100	3/8"	200038	\$4.40
<b>Eye Sockets - Model 37</b>			
500	3/8"	370038	\$1.80
100	1/2"	370050	\$3.30
<b>300-C Retaining Strap (Bulk Units)</b>			
Size	Part No.	List Price (ea.)	
3/8" or x 6"	302001	\$3.45	
3/8" or x 8"	302002	\$3.90	
3/8" x 10	302003	\$4.50	
1/2" x 6	302005	\$3.45	
1/2" x 8	302006	\$3.90	
1/2" x 10	302007	\$4.50	
<b>Eye Socket Offset - Model 38</b>			
box qty.	Size	Part No.	List Price (ea.)
250	3/8"	380038	\$2.65
<b>Wide Flange Purlin Clamp - Model 315</b>			
25	3/8"	315438	\$22.75
<b>Steel Wood Drive Screw - Model 43</b>			
100	16" x 2"	430162	\$4.90
100	14" x 2"	430142	\$4.25

Section 16	Specialty Items
Section 18	Grooved Product
Section 19	CPVC Pipe & Fittings
Section 20	Miscellaneous
Section 21	Electrical
Section C	Valves & Hose Equipment
Section D	Backflow
Section F	Pipe & Accessories
Section H	Hangers
Section J	Lubricants
Section K	Misc.

Items shown on this sheet may not be stocked at all Tyco Fire Products warehouses. Please ask your local Tyco Fire Products location for availability. Freight terms may vary for non commonly stocked items. See latest Technical Data Sheets for specific Approvals, Listings, Design Parameters & available finishes. Prices subject to change without notice.



Section 16  
Specialty Items

Section 18  
Grooved Product

Section 19  
CPVC Pipe & Fittings

Section 20  
Miscellaneous

Section 21  
Electrical

Section C  
Valves & Hose Equipment

Section D  
Backflow

Section F  
Pipe & Accessories

Section H  
Hangers

Section J  
Lubricants

Section K  
Misc.

<b>Erico Hangers</b>			
<b>Steel Rod Coupling - Model 25</b>			
box qty.	Size	Part No.	List Price (ea.)
100	3/8	250038	\$2.30
100	1/2"	250050	\$3.45
100	5/8	250055A	\$6.05
100	3/4"	250051A	\$11.25
50	7/8	250060	\$34.00
<b>Steel Short Rod Coupling - Model 25S</b>			
Size	Part No.	List Price (ea.)	
3/8"	250039	\$2.80	
1/2"	250049	\$2.80	
<b>Knurled Hanger Inserts - Model 100A</b>			
box qty.	Size	Part No.	List Price (ea.)
Bulk	3/8	200036	\$0.70
Bulk	1/2"	200037	\$1.80
<b>Coach Screw Rod Machine Thread - Model 41</b>			
100	3/8" x 4	414038	\$1.45
100	3/8" x 6	416038	\$1.55
100	3/8" x 8	418038	\$2.15
100	3/8" x 10	419038	\$3.20
100	1/2" x 6	414039	\$5.25
<b>Lag Screw - Model 42</b>			
100	3/8" x 1 1/2"	420050	\$0.80
100	3/8" x 2"	420020	\$0.85
100	3/8" x 2 1/2"	420025	\$0.90
50	1/2" x 2 1/2"	420027	\$1.55
50	1/2" x 3	420028	\$1.75
50	1/2" x 4	420029	\$1.85
<b>Clevis Hanger Standard Model 400</b>			
50	1"	450188	\$2.65
50	1 1/4"	450189	\$4.05
50	1 1/2"	450190	\$3.50
50	2"	450191	\$4.30
50	2 1/2"	450192	\$6.80
50	3"	450195	\$5.80
50	3 1/2"	450202	\$8.20
30	4"	450197	\$10.45
25	5"	450203	\$14.25
20	6"	450199	\$18.25
10"	8"	450196	\$29.50
Bulk	10"	450194	\$52.25
Bulk	12"	450204	\$64.75

<b>Erico Hangers</b>			
<b>Steel Concrete Insert - Model 355</b>			
box qty.	Size	Part No.	List Price (ea.)
150		355000	\$4.25
<b>Concrete Insert Nut - Model 355N</b>			
100	3/8	355038	\$2.50
100	1/2"	355050	\$3.70
<b>Nail Plate - Model 30482</b>			
100		304001	\$11.50
<b>Plastic Rod Button - Model 15</b>			
Size	Part No.	List Price (ea.)	
3/8"	492150	\$2.30	
<b>Toggle - Model 148</b>			
3/8"	492990	\$3.70	
<b>Pipe Clamp Standard - Model 450</b>			
box qty.	Size	Part No.	List Price (ea.)
50	1"	450126	\$12.50
50	1 1/4"	450125	\$14.25
25	1 1/2"	450150	\$14.25
25	2"	450200	\$14.50
25	2 1/2"	450250	\$17.50
25	3"	450300	\$19.50
25	4"	450400	\$20.00
10	5"	450500	\$39.25
Bulk	6"	450600	\$44.25
Bulk	8"	450800	\$52.25
<b>Riser Clamp Galvanized - Model 510</b>			
25	1"	510101	\$8.75
25	1 1/4"	510126	\$10.80
25	1 1/2"	510151	\$11.25
25	2"	510201	\$12.00
25	2 1/2"	510251	\$12.50
20	3"	510301	\$16.25
15	4"	510401	\$19.00
Bulk	6"	510601	\$31.25
Bulk	8"	510801	\$86.00

\*See latest Technical Data Sheets for specific Approvals, Listings, Design Parameters & available finishes. Sprinkler heads & escutcheons are priced separately unless otherwise noted. Items marked "C.O." are made to order and may require longer delivery times.



<b>Erico Hangers</b>			
<b>Steel Side Beam Attachment - Model 325</b>			
<i>box qty.</i>	<i>Size</i>	<i>Part No.</i>	<i>List Price (ea.)</i>
100	3/8"	<b>325038</b>	\$4.15
	1/2"	<b>325050</b>	\$5.05
<b>Tapped Side Beam Steel Connector - Model 328</b>			
100	3/8"	<b>327038</b>	\$6.50
<b>Steel Wall Plate - Model 365</b>			
250	3/8"	<b>365038</b>	\$2.05
<b>Yook U Type Hanger - Model 135 (Fits 1" &amp; 1 1/4" Pipe)</b>			
50	6"	<b>13506A</b>	\$2.00
50	8"	<b>13508</b>	\$6.20
<b>Strut Clamp - Model RIGD</b>			
100	1/2"	<b>450172</b>	\$3.45
100	3/4"	<b>450173</b>	\$3.65
100	1"	<b>450174</b>	\$4.20
50	1 1/4"	<b>450151</b>	\$2.80
50	1 1/2"	<b>450152</b>	\$3.35
50	2"	<b>450153</b>	\$3.50
25	2 1/2"	<b>450154</b>	\$4.00
25	3"	<b>450155</b>	\$4.30
25	4"	<b>450156</b>	\$5.60
25	5"	<b>450175</b>	\$14.75
25	6"	<b>450176</b>	\$18.50
25	8"	<b>450177</b>	\$22.50

<b>Erico Hangers</b>			
<b>Multi-Flange Rod Hanger</b>			
<i>box qty.</i>	<i>Size</i>	<i>Part No.</i>	<i>List Price (ea.)</i>
25	3/8" - PHSW6FP	<b>327040</b>	\$15.25
25	3/8" - PH6FP	<b>327041</b>	\$6.65
	3/8" - PHSW6	<b>327042</b>	\$16.50

Section 16	Specialty Items
Section 18	Grooved Product
Section 19	CPVC Pipe & Fittings
Section 20	Miscellaneous
Section 21	Electrical
Section C	Valves & Hose Equipment
Section D	Backflow
Section F	Pipe & Accessories
Section H	Hangers
Section J	Lubricants
Section K	Misc.

Items shown on this sheet may not be stocked at all Tyco Fire Products warehouses. Please ask your local Tyco Fire Products location for availability. Freight terms may vary for non commonly stocked items. See latest Technical Data Sheets for specific Approvals, Listings, Design Parameters & available finishes. Prices subject to change without notice.

Section 16  
Specialty Items

Section 18  
Grooved Product

Section 19  
CPVC Pipe & Fittings

Section 20  
Miscellaneous

Section 21  
Electrical

Section C  
Valves & Hose Equipment

Section D  
Backflow

Section F  
Pipe & Accessories

Section H  
Hangers

Section J  
Lubricants

Section K  
Misc.

<b>Tolco for CPVC</b>			
<b>Hangers for CPVC Plastic Pipe Single Fastener Strap Type - Model 22</b>			
<i>box qty.</i>	<i>Size</i>	<i>Part No.</i>	<i>List Price (ea.)</i>
100	3/4"	<b>90180</b>	\$1.20
100	1"	<b>90181</b>	\$1.25
100	1 1/4"	<b>90182</b>	\$1.30
100	1 1/2"	<b>90183</b>	\$1.35
100	2"	<b>90184</b>	\$1.60
<b>Hangers for CPVC Plastic Pipe Double Fastener Strap Type - Model 23</b>			
100	3/4"	<b>90185</b>	\$1.30
100	1"	<b>90186</b>	\$1.35
100	1 1/4"	<b>90187</b>	\$1.40
100	1 1/2"	<b>90188</b>	\$1.45
100	2"	<b>90189</b>	\$1.70
100	2-1/2"	<b>91189</b>	\$5.00
<b>Hangers for CPVC Plastic Pipe Double Fastener Strap Type Side Mount - Model 24</b>			
100	3/4"	<b>90191</b>	\$1.75
100	1"	<b>90192</b>	\$1.90
100	1 1/4"	<b>90193</b>	\$1.95
100	1 1/2"	<b>90194</b>	\$2.25
100	2"	<b>90195</b>	\$2.45
<b>Ring Hangers - Model 200</b>			
100	3/4"	<b>80190</b>	\$0.90
100	1"	<b>80191</b>	\$0.90
100	1 1/4"	<b>80192</b>	\$0.90
100	1 1/2"	<b>80193</b>	\$0.90
100	2"	<b>80194</b>	\$0.95
100	2 1/2"	<b>80195</b>	\$1.95
75	3"	<b>81300</b>	\$2.10

<b>Tolco Earthquake Bracing</b>			
<b>Fast Clamp Sway Brace Attachment - #1000</b>			
<i>box qty.</i>	<i>Size</i>	<i>Part No.</i>	<i>List Price (ea.)</i>
25	1 x 1"	<b>200100</b>	\$15.75
25	1 x 1 1/4"	<b>200101</b>	\$19.00
25	1 1/4 x 1"	<b>200102</b>	\$15.75
25	1 1/4 x 1 1/4"	<b>200103</b>	\$19.00
25	1 1/2 x 1"	<b>200104</b>	\$15.75
25	1 1/2 x 1 1/4"	<b>200105</b>	\$19.00
25	2 x 1"	<b>200106</b>	\$15.75
25	2 x 1 1/4"	<b>200107</b>	\$19.00
20	2 1/2 x 1"	<b>200108</b>	\$30.25
25	2 1/2 x 1 1/4"	<b>200109</b>	\$19.75
20	3 x 1"	<b>200110</b>	\$16.75
20	3 x 1 1/4"	<b>200111</b>	\$19.75
20	4 x 1"	<b>200112</b>	\$20.00
20	4 x 1 1/4"	<b>200113</b>	\$24.25
20	6 x 1"	<b>200114</b>	\$27.75
20	6 x 1 1/4"	<b>200115</b>	\$45.25
20	8 x 1"	<b>200116</b>	\$31.00
<b>Fast Clamp Sway Brace Attachment - #1001</b>			
10"	8 x 1 1/4"	<b>201117</b>	\$52.75
<b>Longitudinal 4-way Brace Attachment - #907</b>			
<i>Size</i>		<i>Part No.</i>	<i>List Price (ea.)</i>
1 x 1"		<b>200120</b>	\$18.75
1 1/4 x 1"		<b>200121</b>	\$19.25
1 1/4 x 1 1/4"		<b>200122</b>	\$19.50
<b>Non-Threaded Structural Attachment - #909</b>			
1"		<b>200126</b>	\$18.50
<b>Threaded Structural Attachment - #910</b>			
1"		<b>200128</b>	\$17.50
1 1/4"		<b>200129</b>	\$19.75
<b>Threaded Straight Fittings - #975</b>			
1"		<b>200130</b>	\$17.50
<b>Pipe Clamp for Sway Bracing - #4A</b>			
4"		<b>200135</b>	\$11.00
6"		<b>200136</b>	\$28.00
8"		<b>200137</b>	\$33.25
<b>Beam Clamp Retaining Straps - #69</b>			
3/8 x 4		<b>200140</b>	\$1.95
3/8 x 6		<b>200141</b>	\$1.95
3/8 x 8		<b>200142</b>	\$1.95
3/8 x 10		<b>200143</b>	\$2.15
3/8 x 12"		<b>200144</b>	\$2.35
1/2 x 4		<b>200150</b>	\$1.95
1/2 x 6		<b>200151</b>	\$1.95
1/2 x 8		<b>200152</b>	\$1.95
1/2 x 10		<b>200153</b>	\$2.15

\*See latest Technical Data Sheets for specific Approvals, Listings, Design Parameters & available finishes. Sprinkler heads & escutcheons are priced separately unless otherwise noted. Items marked "C.O." are made to order and may require longer delivery times.

<b>Threaded Rod Company</b>		
<b>Black All Thread Rod</b>		
<i>Size</i>	<i>Part No.</i>	<i>List Price/Foot</i>
3/8" x 6'	<b>41050</b>	\$0.75
3/8" x 10'	<b>41052</b>	\$0.75
3/8" x 12'	<b>41053</b>	\$0.75
1/2" x 6'	<b>41060</b>	\$1.40
1/2" x 10'	<b>41061</b>	\$1.40
1/2" x 12'	<b>41062</b>	\$1.40
5/8" x 6'	<b>41064</b>	\$2.40
5/8" x 10'	<b>41063</b>	\$2.40
3/4" x 10'	<b>41065</b>	\$3.65
7/8" x 10'	<b>41066</b>	\$6.05
<b>Galv All Thread Rod</b>		
3/8" x 6'	<b>41058</b>	\$0.90
3/8" x 10'	<b>41056</b>	\$0.90
1/2" x 6'	<b>41059</b>	\$1.75
1/2" x 10'	<b>41057</b>	\$1.75
<b>All Thread Stud</b>		
3/8" x 2"	<b>41080</b>	\$0.35
3/8" x 3"	<b>41081</b>	\$0.35
3/8" x 4"	<b>41082</b>	\$0.40
3/8" x 5"	<b>41083</b>	\$0.45
3/8" x 6"	<b>41084</b>	\$0.65
3/8" x 7"	<b>41085</b>	\$0.75
3/8" x 8"	<b>41086</b>	\$0.80
3/8" x 9"	<b>41087</b>	\$0.90
3/8" x 10"	<b>41088</b>	\$1.05
3/8" x 11"	<b>41089</b>	\$1.10
3/8" x 12"	<b>41090</b>	\$1.20
3/8" x 13"	<b>41091</b>	\$1.30
3/8" x 14"	<b>41092</b>	\$1.35
3/8" x 15"	<b>41093</b>	\$1.50
3/8" x 16"	<b>41094</b>	\$1.70
3/8" x 17"	<b>41095</b>	\$1.75
3/8" x 18"	<b>41096</b>	\$1.85
3/8" x 20"	<b>41099</b>	\$2.00
3/8" x 21"	<b>41124</b>	\$2.10
3/8" x 23"	<b>41098</b>	\$2.30
3/8" x 24"	<b>41097</b>	\$2.35

<b>Elco Ind. - Hanger Mate</b>		
<b>Wood Screw</b>		
<i>Size</i>	<i>Part No.</i>	<i>List Price (ea.)</i>
ZG650	<b>21112</b>	\$1.75
EZH665	<b>21145</b>	\$1.90
<b>Steel Screw</b>		
EZG550	<b>21113</b>	\$28.00
EZG510	<b>21148</b>	\$2.10
<b>Steel Screw w/Nuts</b>		
EZH476	<b>21149</b>	\$2.05
EZG471	<b>21140</b>	\$1.85
<b>Concrete Screw</b>		
EZG730	<b>21114</b>	\$1.60
<b>Drill Bit Adapter</b>		
EZE240	<b>21116</b>	\$25.75
<b>Masonry Bit</b>		
EZE340	<b>21117</b>	\$6.85
<b>Drive Sockets</b>		
Wood/Metal	<b>20113</b>	\$42.75
Concrete	<b>20114</b>	\$51.00

Section 16	Specialty Items
Section 18	Grooved Product
Section 19	CPVC Pipe & Fittings
Section 20	Miscellaneous
Section 21	Electrical
Section C	Valves & Hose Equipment
Section D	Backflow
Section F	Pipe & Accessories
Section H	Hangers
Section J	Lubricants
Section K	Misc.

Items shown on this sheet may not be stocked at all Tyco Fire Products warehouses. Please ask your local Tyco Fire Products location for availability. Freight terms may vary for non commonly stocked items. See latest Technical Data Sheets for specific Approvals, Listings, Design Parameters & available finishes. Prices subject to change without notice.

Section 16  
Specialty Items

Section 18  
Grooved Product

Section 19  
CPVC Pipe & Fittings

Section 20  
Miscellaneous

Section 21  
Electrical

Section C  
Valves & Hose Equipment

Section D  
Backflow

Section F  
Pipe & Accessories

Section H  
Hangers

Section J  
Lubricants

Section K  
Misc.

<b>Sammy Super Screw</b>		
<b>Steel</b>		
<i>Size</i>	<i>Part No.</i>	<i>List Price (ea.)</i>
DST 10 Sam Screw 3/8" x 1"	<b>20081</b>	\$2.10
DST 15 Sam Screw 3/8" x 1 1/2"	<b>20082</b>	\$2.15
DST 20 Sam Screw 3/8" x 2	<b>20083</b>	\$2.20
DST 25 Sam Screw 3/8" x 2 1/2"	<b>20084</b>	\$2.20
DST 30 Sam Screw 3/8" x 3	<b>20085</b>	\$2.35
DSTR 1 Sam Screw 1 1/4" X 1"	<b>21189</b>	\$2.10
DSTR 516 Sam Screw 5/16" x 1 1/4"	<b>21190</b>	\$2.45
<b>Concrete</b>		
SWC 20 Sam Screw 3/8" x 2	<b>21192</b>	\$3.15
<b>Wood</b>		
GST .75 Sam Screw 3/8" x 1"	<b>20193</b>	\$3.15
GST 10 Sam Screw 3/8" x 1"	<b>20089</b>	\$2.10
GST 20 Sam Screw 3/8" x 2	<b>20090</b>	\$2.00
GST 30 Sam Screw 3/8" x 3	<b>20091</b>	\$2.10
SST 30 Sam Screw 3/8" x 3	<b>20092</b>	\$2.60
Sammy Screw 1/4" x 1 1/2"	<b>21191</b>	\$2.85
Sidewinder Screw 1/4" x 1"	<b>21181</b>	\$2.70
Sidewinder Screw 5/16" x 1 1/4"	<b>21182</b>	\$3.10
Sidewinder Screw 1/4" x 1"	<b>21183</b>	\$3.50
Sidewinder Screw 1/4" x 1 1/2"	<b>21184</b>	\$2.60
Sidewinder Screw 5/16" x 1 1/4"	<b>21185</b>	\$3.20
Sidewinder Screw 1/4" x 1 1/2"	<b>21186</b>	\$3.15
Sidewinder Screw 1/4" x 1"	<b>21187</b>	\$2.90
Sidewinder Screw 1/4" x 2	<b>21188</b>	\$2.90
Sidewinder Screw 3/8" x 2 1/2"	<b>21195</b>	\$2.70
<b>Nut Drivers</b>		
<i>Description</i>	<i>Part No.</i>	<i>List Price (ea.)</i>
Sammy Screw Nut Driver	<b>20086</b>	\$29.75
<b>Sammy Screw Sidewinder</b>		
Nut Driver 16mm	<b>20087</b>	\$29.75
<b>Sammy Screw X-Press Anchor</b>		
XP-20 X-Press Anchor 20	<b>21196</b>	\$10.05
XP-35 X-Press Anchor 35	<b>21197</b>	\$10.05
<b>Sammy Screw X-Press Install Tool</b>		
XPIT X-Press Install tool	<b>21198</b>	\$358.50
<b>X-Press Drill Bit</b>		
X-Press Drill bit	<b>21199</b>	\$31.50

<b>Sammy Super Screw</b>		
<b>Swivel-Head Wood Sammy Screw</b>		
<i>Description</i>	<i>Part No.</i>	<i>List Price (ea.)</i>
SH-GST 20	<b>20190</b>	\$2.20
SH-GST 30	<b>20191</b>	\$2.40
<b>Swivel-Head Steel Sammy Screw</b>		
SH-DSTR1	<b>21289</b>	\$3.40

\*See latest Technical Data Sheets for specific Approvals, Listings, Design Parameters & available finishes. Sprinkler heads & escutcheons are priced separately unless otherwise noted. Items marked "C.O." are made to order and may require longer delivery times.

Afcon for CPVC		
Description	Part No.	List Price (ea.)
Model #509 CPVC Nail Plate Protector [Stud Guards]	81301	\$1.40

Afcon			
Sway Brace Clamp Model E-001			
box qty.	Size	Part No.	List Price (ea.)
25	1"	150014	\$20.00
25	1 1/4"	150018	\$20.00
25	1 1/2"	150013	\$20.00
25	2"	150001	\$20.00
10"	2 1/2"	150002	\$20.50
10"	3"	150003	\$20.75
10"	4"	150004	\$25.25
Sway Brace Clamp Model 410			
10"	4"	150174	\$16.00
	6"	150175	\$31.25
1 1/4" Pipe Sway Brace Clamp Model E-020			
25	1 1/4"	150020	\$23.75
25	1 1/2"	150121	\$23.75
25	2"	150007	\$23.75
10"	2 1/2"	150008	\$24.50
10"	3"	150009	\$25.00
10"	4"	150010	\$26.75
Threaded Attachment End - Model-070			
50	1"	150015	\$32.25
Locking Attachment - Model 077			
50	1"	150021	\$19.00
50	1 1/4"	150022	\$24.25

Afcon			
Surge Restrainer - Model 310			
box qty.	Size	Part No.	List Price (ea.)
	1" - 2"	302026	\$1.05
CPVC Offset Hanger - Model 514			
	3/4"	90235	\$2.05
	1"	90236	\$2.00
	1 1/4"	90237	\$2.20
	1 1/2"	90238	\$2.20
	2"	90239	\$2.95
Double Offset CPVC Hanger - Model 515			
	3/4"	90245	\$4.40
	1"	90246	\$4.40

Section 16	Specialty Items
Section 18	Grooved Product
Section 19	CPVC Pipe & Fittings
Section 20	Miscellaneous
Section 21	Electrical
Section C	Valves & Hose Equipment
Section D	Backflow
Section F	Pipe & Accessories
Section H	Hangers
Section J	Lubricants
Section K	Misc.

Items shown on this sheet may not be stocked at all Tyco Fire Products warehouses. Please ask your local Tyco Fire Products location for availability. Freight terms may vary for non commonly stocked items. See latest Technical Data Sheets for specific Approvals, Listings, Design Parameters & available finishes. Prices subject to change without notice.

Section 16 Specialty Items
Section 18 Grooved Product
Section 19 CPVC Pipe & Fittings
Section 20 Miscellaneous
Section 21 Electrical
Section C Valves & Hose Equipment
Section D Backflow
Section F Pipe & Accessories
<b>Section H Hangers</b>
Section J Lubricants
Section K Misc.

*\*See latest Technical Data Sheets for specific Approvals, Listings, Design Parameters & available finishes. Sprinkler heads & escutcheons are priced separately unless otherwise noted. Items marked "C.O." are made to order and may require longer delivery times.*

**Supersedes 3/4/2011**

<b>LA-CO Industries</b>		
<b>Thread Sealant Paste</b>		
<i>Description</i>	<i>Part No.</i>	<i>List Price</i>
Slic-Tite Qt	<b>32004</b>	\$55.50
Slic-Tite Qt BIC*	<b>32025</b>	\$64.50
* BIC - Brush In Can		
<b>Gasket Lubricant</b>		
Lubri-Joint Qt	<b>32005</b>	See Section 18 for list prices
Lubri-Joint Gal	<b>32006</b>	
<b>Tape</b>		
Tefl-Tape <sup>1/2</sup> x 520	<b>32014</b>	\$0.90
Tefl-Tape <sup>3/4</sup> x 520	<b>32015</b>	\$1.65
Acid Brush <sup>1/2</sup> "	<b>32016</b>	\$0.60
<b>Pipe Markers (Valve Action)</b>		
White	<b>32017</b>	\$4.60
Yellow	<b>32018</b>	\$4.60
Red	<b>32019</b>	\$4.60
Blue	<b>32020</b>	\$4.60

<b>Noble Company "Fire Fighter"</b>		
<b>Anti-Freeze - Glycol for Steel Pipe (pre-mix)</b>		
<i>Description</i>	<i>Part No.</i>	<i>List Price</i>
1 Gallon	<b>54010</b>	\$26.25
5 Gallon	<b>54011</b>	\$132.00
55 Gallon	<b>54012</b>	\$1,390.00
<b>Anti-Freeze - Glycol for Steel Pipe (concentrate)</b>		
5 Gallon	<b>54014</b>	\$269.00
55 Gallon	<b>54015</b>	\$2,941.00

<b>Gasket Lubricant</b>		
<b>Silicone Gasket Lubricant</b>		
<b>(for use with Dry Pipe &amp; Freezer Applications)</b>		
<b>Dow Corning * #DC No. 7</b>		
<b>Recommended for Tri-Seal Gaskets</b>		
<i>Description</i>	<i>Part No.</i>	<i>List Price</i>
5.30 oz. Tube	<b>32037</b>	See Section 18 for current list prices
8 lb Can	<b>32038</b>	

Section 16	Specialty Items
Section 18	Grooved Product
Section 19	CPVC Pipe & Fittings
Section 20	Miscellaneous
Section 21	Electrical
Section C	Valves & Hose Equipment
Section D	Backflow
Section F	Pipe & Accessories
Section H	Hangers
Section J	Lubricants
Section K	Misc.

\* Dow Corning is a trademark of Dow Corning Corporation.

Items shown on this sheet may not be stocked at all Tyco Fire Products warehouses. Please ask your local Tyco Fire Products location for availability. Freight terms may vary for non commonly stocked items. See latest Technical Data Sheets for specific Approvals, Listings, Design Parameters & available finishes. Prices subject to change without notice.



Section 16 Specialty Items
Section 18 Grooved Product
Section 19 CPVC Pipe & Fittings
Section 20 Miscellaneous
Section 21 Electrical
Section C Valves & Hose Equipment
Section D Backflow
Section F Pipe & Accessories
Section H Hangers
Section J Lubricants
Section K Misc.

<b>Sealant</b>		
<b>FPPI Thread-Fit Cutting Oil</b>		
<i>Description</i>	<i>Part No.</i>	<i>List Price</i>
1-gallon	<b>320040</b>	\$41.75
5-gallon	<b>320041</b>	\$195.50
55-gallon	<b>320042</b>	\$1,974.00
<b>FPPI PipeFit Thread Sealant</b>		
1-pint Can BIC	<b>320030</b>	\$15.75
1-quart Can	<b>320031</b>	\$25.75
1-gallon Can	<b>320032</b>	\$107.50
5-gallon Can	<b>320033</b>	\$398.50
<b>Oatey Great White Thread Sealant</b>		
4-ounce	<b>31230</b>	\$5.85
8-ounce	<b>31231</b>	\$9.30
1-pint	<b>31232</b>	\$16.50
1-quart	<b>31233</b>	\$29.75
<b>FPPI LubeFit Gasket Lubricant</b>		
2-Lb	<b>320043</b>	\$11.25

\*See latest Technical Data Sheets for specific Approvals, Listings, Design Parameters & available finishes. Sprinkler heads & escutcheons are priced separately unless otherwise noted. Items marked "C.O." are made to order and may require longer delivery times.

<b>MIFAB / PMR</b>		
<b>Access Doors</b>		
<i>Description</i>	<i>Part No.</i>	<i>List Price</i>
VA, 12" x 24" - Drywall	<b>21070</b>	\$94.50
VA, 14" x 14" - Drywall	<b>21071</b>	\$46.25
VA, 16" x 16" - Drywall	<b>21072</b>	\$50.50
UA, 12" x 12" - Drywall	<b>21075</b>	\$69.25
UA, 24" x 24" - Drywall	<b>21076</b>	\$146.00
UA 8" x 8" Drywall	<b>21078</b>	\$39.00
UA 16" x 20" Drywall	<b>21083</b>	\$68.25
UA 16" x 24" Drywall	<b>21084</b>	\$75.75
UA 18" x 18" Drywall	<b>21085</b>	\$99.75

<b>Acudor Products</b>		
<b>Access Door, Flush, Prime coated steel, UF5000</b>		
<i>Description</i>	<i>Part No.</i>	<i>List Price</i>
6" x 6"	<b>22100</b>	\$50.50
8" x 8"	<b>22101</b>	\$51.50
12" x 12"	<b>22102</b>	\$60.00
12" x 18"	<b>22103</b>	\$94.00
16" x 16"	<b>22104</b>	\$94.00
18" x 18"	<b>22105</b>	\$95.50
18" x 24"	<b>22106</b>	\$126.50
18" x 24" with drip edge	<b>22107</b>	\$179.00
24" x 36"	<b>22108</b>	\$234.00

Section 16 Specialty Items
Section 18 Grooved Product
Section 19 CPVC Pipe & Fittings
Section 20 Miscellaneous
Section 21 Electrical
Section C Valves & Hose Equipment
Section D Backflow
Section F Pipe & Accessories
Section H Hangers
Section J Lubricants
<b>Section K Misc.</b>

Items shown on this sheet may not be stocked at all Tyco Fire Products warehouses. Please ask your local Tyco Fire Products location for availability. Freight terms may vary for non commonly stocked items. See latest Technical Data Sheets for specific Approvals, Listings, Design Parameters & available finishes. Prices subject to change without notice.

Section 16 Specialty Items
Section 18 Grooved Product
Section 19 CPVC Pipe & Fittings
Section 20 Miscellaneous
Section 21 Electrical
Section C Valves & Hose Equipment
Section D Backflow
Section F Pipe & Accessories
Section H Hangers
Section J Lubricants
Section K Misc.

*\*See latest Technical Data Sheets for specific Approvals, Listings, Design Parameters & available finishes. Sprinkler heads & escutcheons are priced separately unless otherwise noted. Items marked "C.O." are made to order and may require longer delivery times.*

**Supersedes 3/4/2011**

01EPDMAC.....	18-7	205480 thru 205481.....	D-1	208342.....	D-3
01EPDME3.....	18-7	205482 thru 205483.....	D-3	208345 thru 208346.....	D-1
100-25-700.....	7-11	205485 thru 205486.....	D-1	20836.....	D-2
10908100.....	7-13	20549.....	D-2	208360 thru 208361.....	D-1
10EPDMAC.....	18-7	205490 thru 205491.....	D-1	208362.....	D-3
10EPDME3.....	18-7	205492 thru 205493.....	D-3	208365 thru 208380.....	D-1
1111 thru 1124.....	7-12	205495 thru 205496.....	D-1	208382.....	D-3
1150 thru 1153.....	7-10	20550.....	D-2	208385.....	D-1
115300 thru 115800.....	H-1	205500 thru 205501.....	D-1	20839.....	D-2
1174 thru 1175.....	7-10	205502 thru 205503.....	D-3	20849 thru 20858.....	D-1
1177.....	7-12	20551.....	D-2	20897 thru 20898.....	D-2
1184 thru 1200.....	7-10	205510 thru 205511.....	D-1	20EPDMAC.....	18-7
12525000.....	16-1	205512 thru 205513.....	D-3	20EPDME3.....	18-7
12EPDMAC.....	18-7	20552.....	D-2	21000.....	C-1
12EPDME3.....	18-7	205520 thru 205521.....	D-1	21010.....	D-1
13524A.....	H-3	205522 thru 205523.....	D-3	21010GS.....	18-9
13EPDMAC.....	18-7	20553.....	D-2	21010S.....	18-9
13EPDME3.....	18-7	205530 thru 205531.....	D-1	21011 thru 21012.....	D-1
1420 thru 1441.....	F-3	205532 thru 205533.....	D-3	21012GS.....	18-9
150001 thru 150022.....	H-7	20555 thru 20558.....	D-2	21012S.....	18-9
150100.....	H-1	205580 thru 205581.....	D-1	21013 thru 21015.....	D-1
150121.....	H-7	205582 thru 205583.....	D-3	21016 thru 21019.....	D-2
150125 thru 150150.....	H-1	205585 thru 205586.....	D-1	21020.....	C-1
150174 thru 150175.....	H-7	20559.....	D-2	21021 thru 21022.....	D-2
150200 thru 150250.....	H-1	205590 thru 205591.....	D-1	21023 thru 21028A.....	D-1
15250 thru 15750.....	F-2	205592 thru 205593.....	D-3	21029 thru 21034.....	D-2
15EPDMAC.....	18-7	205595 thru 205596.....	D-1	21040.....	C-1
15EPDME3.....	18-7	20561.....	D-2	21050GS.....	18-9
16100 thru 16400.....	F-2	20592.....	C-1	21050S.....	18-9
1667-4 thru 1667-61.....	20-6	20610 thru 20642.....	D-7	21070 thru 21085.....	K-1
16700 thru 17044.....	F-2	20647 thru 20648.....	D-8	21112 thru 21117.....	H-5
19071100.....	19-6	20661 thru 20664.....	D-7	21126.....	21-1
1954-02 thru 1954-04.....	20-9	20669 thru 20680.....	D-8	21140 thru 21149.....	H-5
200036 thru 200037.....	H-2	20698.....	D-7	21181 thru 21199.....	H-6
200038.....	H-1	20700 thru 20719.....	D-2	21215 thru 21229.....	C-1
200100 thru 200153.....	H-4	207190 thru 207191.....	D-1	21232.....	F-3
20081 thru 20092.....	H-6	207192 thru 207193.....	D-3	21289.....	H-6
20110GS.....	18-8	20729 thru 20767.....	D-2	21549.....	D-2
20110S.....	18-8	207670 thru 207671.....	D-1	21910GS.....	18-9
201117.....	H-4	207672.....	D-3	21910S.....	18-9
20112GS.....	18-8	20768.....	D-2	21912GS.....	18-9
20112S.....	18-8	207680 thru 207681.....	D-1	21912S.....	18-9
20113 thru 20114.....	H-5	207682.....	D-3	21950GS.....	18-9
20125.....	13-3, 14-3 thru	20769.....	D-2	21950S.....	18-9
20128 thru 20135.....	21-1	207690 thru 207691.....	D-1	2202 thru 2207.....	C-2
20150GS.....	18-8	207692.....	D-3	22100 thru 22108.....	K-1
20150S.....	18-8	20770.....	D-2	2222 thru 2244.....	C-2
2015EPDME.....	18-4	207700 thru 207701.....	D-1	22441.....	C-3
20190 thru 20193.....	H-6	207702.....	D-3	2245.....	C-2
20404 thru 20412.....	D-7	20771.....	D-2	22450 thru 22461.....	C-3
20414.....	D-8	207710.....	D-1	2259.....	C-1
20415.....	D-7	207712.....	D-3	2262.....	C-2
20416.....	D-8	20772 thru 207880.....	D-2	2264 thru 22690.....	C-1
20417.....	D-7	20809 thru 20810.....	C-1	2272 thru 2281.....	C-2
20418.....	D-8	208102 thru 208107.....	2-2, 2-3, 7-11	2282 thru 2283.....	16-1
20419.....	D-7	20811.....	C-1	2284.....	C-2
20420.....	D-8	20813.....	D-7	2285 thru 2293.....	F-3
20422 thru 20431.....	D-7	20820.....	C-1	2296.....	C-2
20432.....	D-8	20822 thru 20832.....	D-2	2300A thru 2329.....	16-5
20438 thru 20473.....	D-7	208320 thru 208321.....	D-1	2344.....	21-1
20475 thru 20477.....	D-8	208322.....	D-3	2360 thru 2370.....	16-1
20478 thru 20492.....	D-7	208325 thru 208326.....	D-1	2373 thru 2387.....	21-1
20504 thru 20521.....	C-1	20833.....	D-2	2391.....	F-3
20539.....	D-2	208330 thru 208331.....	D-1	2394 thru 2396.....	21-1
205390 thru 205391.....	D-1	208332.....	D-3	2399.....	F-3
205392 thru 205393.....	D-3	208335 thru 208336.....	D-1	24100 thru 2428.....	21-1
205395 thru 205396.....	D-1	20834.....	D-2	2433.....	16-1
20548.....	D-2	208340 thru 208341.....	D-1	2440 thru 2489.....	21-1

2460566.....	13-5, 13-7	26040T1S.....	18-10	32014 thru 32019.....	J-1
250038 thru 250039.....	H-2	26040TP.....	18-10	3202.....	F-2
25004000.....	20-2	26040TS.....	18-10	32020 thru 32025.....	J-1
250049 thru 250060.....	H-2	26050GP.....	18-10	32030GS.....	18-15
2501 thru 2505.....	C-3	26050GS.....	18-10	32037.....	18-7
25058000.....	20-2	26050P.....	18-10	32038.....	18-7
25059000.....	20-3	26050S.....	18-10	3204 thru 3207.....	F-2
2509.....	C-3	26050T1S.....	18-10	322110 thru 322810.....	C-1
25100.....	21-1	26050TS.....	18-10	325038 thru 327042.....	H-3
251100 thru 251730.....	F-1	26060GP.....	18-10	350100 thru 350800.....	D-5
2520EPDME.....	18-4	26060GS.....	18-10	355000 thru 355050.....	H-2
25700.....	13-5, 13-7, 21-1	26060P.....	18-10	365038.....	H-3
2571.....	13-3 thru 13-10, 14-6	26060S.....	18-10	370038 thru 370050.....	H-1
25710.....	13-5, 13-7, 21-1	26060T1P.....	18-10	3751105 thru 3751106.....	D-6
2572.....	12-1	26060T1S.....	18-10	3751250 thru 3751253.....	D-5
25720.....	21-1	26060TP.....	18-10	3751254 thru 3751256.....	D-6
2573.....	12-1, 13-3, 13-9, 14-6	26060TS.....	18-10	3751300 thru 3751303.....	D-5
25730 thru 25880.....	21-1	26080GP.....	18-10	3751304 thru 3751306.....	D-6
25EPDMAC.....	18-7	26080GS.....	18-10	3751400 thru 3751403.....	D-5
25EPDME3.....	18-7	26080P.....	18-10	3751404 thru 3751406.....	D-6
26001GS.....	18-10	26080S.....	18-10	3751600 thru 3751603.....	D-5
26001S.....	18-10	26080T1P.....	18-10	3751604 thru 3751606.....	D-6
26010GP.....	18-10	26080T1S.....	18-10	3751800 thru 3751803.....	D-5
26010GS.....	18-10	26080TP.....	18-10	3751804 thru 3751806.....	D-6
26010P.....	18-10	26080TS.....	18-10	380038.....	H-1
26010S.....	18-10	26144 thru 26145.....	21-1	40002000.....	20-1
26012GP.....	18-10	2653 thru 2655.....	11-1	40004000.....	20-1, 20-2
26012GS.....	18-10	2656.....	4-8, 11-2, 13-3, 14-3 thru 14-6, 21-1	40018200 thru 40018600.....	20-1
26012P.....	18-10	2657.....	11-1	40058000.....	20-1, 20-2
26012S.....	18-10	26590 thru 26600.....	21-1	4020EPDME.....	18-4
26013GP.....	18-10	2665 thru 2667.....	19-6	4025EPDME.....	18-4
26013GS.....	18-10	2745 thru 27690.....	C-3	4030EPDME.....	18-4
26013P.....	18-10	2770.....	C-5	4055 thru 4096.....	8-3
26013S.....	18-10	27700.....	C-3	40EPDMAC.....	18-7
26015GP.....	18-10	2771.....	C-5	40EPDME3.....	18-7
26015GS.....	18-10	27710.....	C-3	41001 thru 41011.....	F-2
26015P.....	18-10	27711 thru 2772.....	C-5	41013 thru 41049.....	18-25
26015S.....	18-10	27900 thru 28040.....	C-3	41050 thru 41124.....	H-5
26020GP.....	18-10	28050 thru 28135.....	C-5	41204 thru 41206.....	C-3
26020GS.....	18-10	28140 thru 28355.....	C-4	41210 thru 41261.....	18-25
26020P.....	18-10	28360 thru 28420.....	C-5	41262 thru 41299.....	18-26
26020S.....	18-10	2954-02.....	20-9	41302 thru 41338.....	C-2
26020T1P.....	18-10	300038.....	H-1	414038 thru 414039.....	H-2
26020T1S.....	18-10	30004000.....	20-2, 20-4	41500 thru 41514.....	18-26
26020TP.....	18-10	300050.....	H-1	416038 thru 419038.....	H-2
26020TS.....	18-10	30010000.....	20-1	42000 thru 42002.....	F-7
26025GP.....	18-10	30018600.....	20-4	420020 thru 420029.....	H-2
26025GS.....	18-10	3002.....	19-6	42003.....	F-7
26025P.....	18-10	30021000 thru 30023000.....	20-1	420050.....	H-2
26025S.....	18-10	30058000.....	20-2	430142 thru 430162.....	H-1
26025T1P.....	18-10	3011.....	19-6	43100ZCK-1 thru 43RTC.....	16-3
26025T1S.....	18-10	302001 thru 302007.....	H-1	450125 thru 450150.....	H-2
26025TP.....	18-10	302026.....	H-7	450151 thru 450177.....	H-3
26025TS.....	18-10	3020EPDME.....	18-4	450188 thru 45866.....	H-2
26030GP.....	18-10	3025EPDME.....	18-4	475140 thru 475180.....	D-6
26030GS.....	18-10	304001.....	H-2	47616.....	H-2
26030P.....	18-10	30EPDMAC.....	18-7	49-014 thru 49-060.....	7-3
26030S.....	18-10	30EPDME3.....	18-7	49-200 thru 49-201.....	7-4
26030T1P.....	18-10	310038 thru 310050.....	H-1	49-204.....	7-6
26030T1S.....	18-10	3104000 thru 3108001.....	D-5	49-206 thru 49-207.....	7-7
26030TP.....	18-10	31230 thru 31233.....	J-2	49-208 thru 49-209.....	7-8
26030TS.....	18-10	315438.....	H-1	49-210.....	7-5, 7-9
26040GP.....	18-10	320030 thru 320033.....	J-2	49-211.....	7-5
26040GS.....	18-10	32004.....	J-1	49-316 thru 49-3XX.....	7-1
26040P.....	18-10	320040 thru 320043.....	J-2	49-4XX.....	7-6
26040S.....	18-10	32005.....	18-7	49-554 thru 49-556.....	7-5
26040T1P.....	18-10	3201.....	F-2	49-7XX.....	7-2

49-800 thru 49-802.....	7-3	51-201.....	4-2	510601.....	H-2
49-8XX thru 49-9XX.....	7-2	51-211.....	4-1	51060DGS.....	18-9
492150 thru 492990.....	H-2	51-215.....	4-2	51060DS.....	18-9
494470.....	H-1	51-301.....	6-1	51060GP.....	18-9
50-081.....	7-4	51-311.....	6-2	51060GS.....	18-9
50-082.....	7-4	51-396.....	2-8	51060P.....	18-9
50-110.....	3-4	51-477.....	13-8, 13-9, 13-10	51060S.....	18-9
50-112.....	3-4	51-524 thru 51-534.....	4-5	510801.....	H-2
50-210.....	3-4	51-620 thru 51-623.....	6-3	51080DGS.....	18-9
50-300 thru 50-305.....	6-2	51-790.....	1-16	51080DS.....	18-9
50-314 thru 50-317.....	6-8	51-792.....	1-17	51080GP.....	18-9
50-400.....	3-5	51-793.....	13-3	51080GS.....	18-9
50-500.....	3-5	51-794.....	2-7	51080P.....	18-9
50-501.....	3-4	51-873.....	4-3	51080S.....	18-9
50-502.....	3-5	51-887 thru 51-889.....	3-3	510S20GP thru 510S80GP.....	18-8
50-510 thru 50-512.....	3-4	51-893 thru 51-894.....	2-3	510S20GS thru 510S80GS.....	18-8
50-601 thru 50-625.....	6-3	51-895.....	2-2	510S20P thru 510S80P.....	18-8
50-701.....	2-6	51-896.....	2-1	510S20S thru 510S80S.....	18-8
50-711.....	6-1	51002 thru 51010.....	C-2	51113GS 51180GS.....	18-12
50-801.....	2-9	510101.....	H-2	51113S thru 51180S.....	18-12
500000 thru 500063.....	F-4	51010GP.....	18-9	51213GS thru 51280GS.....	18-12
500064 thru 500070.....	F-5	51010P.....	18-9	51213S thru 51280S.....	18-12
500083 thru 500086.....	F-4	51011 thru 51012.....	C-2	51280.....	C-3
500090 thru 500092.....	F-5	510126.....	H-2	51290 thru 51300.....	C-3
500110 thru 500113A.....	F-4	51012GP.....	18-9	51310.....	C-3
500125A.....	F-5	51012P.....	18-9	51910GP thru 51912GP.....	18-9
500126.....	F-4	51013.....	C-2	51910P thru 51912P.....	18-9
50024 thru 50078.....	21-2	51013GP.....	18-9	519S20GP thru 519S80GS.....	18-8
50082.....	21-2	51013GS.....	18-9	519S20GS thru 519S80GS.....	18-8
50084 thru 50094.....	21-2	51013P.....	18-9	519S20P thru 519S80P.....	18-8
50110GP thru 50180GP.....	18-8	51013S.....	18-9	519S20S thru 519S80S.....	18-8
50110P thru 50180P.....	18-8	51015.....	C-2	52-069.....	16-1
50113GS thru 50180GS.....	18-8	510151.....	H-2	52-150.....	14-1, 14-2, 14-3, 16-2
50113S thru 50180S.....	18-8	51015GP.....	18-9	52-201 thru 52-204.....	8-1
50142 thru 50149.....	F-8	51015GS.....	18-9	52-211.....	8-1, 8-4
50160GS.....	18-8	51015P.....	18-9	52-270.....	16-3
50168 thru 50180.....	F-8	51015S.....	18-9	52-271.....	9-1
50188.....	F-8	51016 thru 51019.....	C-2	52-280.....	11-3, 13-3
50208 thru 50210.....	F-3	510201.....	H-2	52-287.....	13-3, 13-10, 14-3, 14-4, 14-5, 21-1
50211 thru 50225.....	F-3	51020DGS.....	18-9	52-289.....	13-3 thru 13-10, 14-1, 14-2, 16-2
50232 thru 50239.....	21-2	51020DS.....	18-9	52-302.....	20-4
50240 thru 50248.....	18-5	51020GP.....	18-9	52-309.....	10-1
5025.....	C-1	51020GS.....	18-9	52-310.....	10-1, 4-8
50251 thru 50259.....	21-2	51020P.....	18-9	52-311 thru 52-312.....	11-1, 11-2
5026.....	C-1	51020S.....	18-9	52-324.....	12-1, 13-9, 14-1 thru 14-5
50260 thru 50269.....	21-2	51021.....	C-2	52-326.....	12-1, 13-9, 14-1, 14-2, 14-4
5027 thru 5030.....	C-1	510251.....	H-2	52-328.....	12-1, 13-9, 14-2, 14-3, 14-4, 14-5
5031.....	C-1	51025DGS.....	18-9	52-353.....	13-7
5032 thru 5040.....	C-1	51025DS.....	18-9	52-363.....	16-5
5040EPDME.....	18-4	51025GP.....	18-9	52-370.....	16-4
5041A thru 5044.....	C-1	51025GS.....	18-9	52-380.....	16-1
50999.....	C-2	51025P.....	18-9	52-390.....	16-4
50EPDMAC.....	18-7	51025S.....	18-9	52-403.....	9-1
50EPDME3.....	18-7	510301.....	H-2	52-477.....	13-1, 13-2, 13-5, 13-7, 13-8, 13-9, 13-10, 14-1 thru 14-5
51-010.....	4-1	51030DGS.....	18-9	52-478.....	14-1 thru 14-8
51-036 thru 51-040.....	6-13	51030DS.....	18-9	52-540.....	4-9, 8-3
51-041.....	7-9	51030GP.....	18-9	52-570.....	15-3
51-051 thru 51-053.....	2-10	51030GS.....	18-9	52-630.....	13-3, 13-5, 13-8, 13-9, 13-10, 14-1 thru 14-6, 9-1
51-068 thru 51-069.....	4-6	51030P.....	18-9	52-789 thru 52-793.....	13-5, 13-7, 16-1
51-072 thru 51-073.....	2-6	51030S.....	18-9	52-811.....	13-14, 13-15
51-104.....	20-10	510401.....	H-2	52-812.....	13-15
51-106.....	20-11	51040DGS.....	18-9	52-813 thru 52-816.....	13-16, 13-11
51-112.....	20-12	51040DS.....	18-9	52-817.....	13-16, 13-13
51-114.....	4-3	51040GP.....	18-9	52-818.....	13-16, 13-12
51-122.....	20-12	51040GS.....	18-9	52-821 & 52-822.....	13-15
51-123 thru 51-124.....	4-4	51040P.....	18-9		
51-136 thru 51-140.....	6-14	51040S.....	18-9		

52-823 thru 52-826	13-16, 13-11	5506050S	18-14	58-445	3-2
52-827	13-16, 13-13	5508030GS	18-14	58-447 thru 58-450	3-1
52-828	13-16, 13-12	5508030S	18-14	58-946	1-6
52-831 & 52-832	13-15	5508040GS	18-14	58-970	2-7
52-833 thru 52-836	13-16, 13-11	5508040S	18-14	58-973	1-4
52-837	13-16, 13-13	5508050GS	18-14	58-974	1-5
52-838	13-16, 13-12	5508050S	18-14	58-981	1-4
52-841 & 52-842	13-15	5508060GS	18-14	58-982	1-5
52-843 thru 52-846	13-16, 13-11	5508060S	18-14	58-986	3-12
52-847	13-16, 13-13	5576	20-7	5801 thru 5803	20-7
52-848	13-16, 13-12	56-000	1- thru 1-18, 2-4 thru 2-10, 3-6 thru 3-12, 4-1 thru 4-7, 5-10, 5-11, 5-12, 6-1 thru 6-12, 7-9 thru 7-14, 20-10, 20-11, 20-12	5807 thru 5809	20-6
52-861 & 52-862	13-15	56-001 thru 56-010	5-6, 5-7, 5-8, 7-14	5839	20-7
52-863 thru 52-866	13-16, 13-11	56-012	20-10	59-300	13-7, 15-3, 18-23
52-867	13-16, 13-13	56-015	3-10, 3-11	59-300-F-025N	18-24
52-868	13-15, 13-12	56-017	3-6 thru 3-9	59-300-F-030N	18-24
52-881 & 52-882	13-15	56-122	20-12	59-300-F-040N	18-24
52-883 thru 52-888	13-15, 13-16	56-123 thru 56-124	4-4	59-300-F-050N	18-24
52040 thru 52047	19-6	56-125	16-2	59-300-F-060N	18-24
53-101 thru 53-102	1-2	56-152	3-13	59-300-F-080N	18-24
53-106 thru 53-107	1-3	56-201	4-3	59-300-F-100N	18-24
53-111 thru 53-112	1-1	56-312	6-8	59-590 thru 59-591	8-2
53-113	1-3	56-314	6-8, 7-14	59-590-0-020 thru 59-590-0-100	18-24
53-153	3-11	56-320	7-10	59-592	15-1
53-253	3-10	56-396	2-8	59-801 thru 59-802	15-2
53-261	1-18	56-452	6-13, 6-14, 7-14, 7-4	59025EPDME thru 59100EPDME	15-1
54-350	16-1	56-665	2-2, 2-3, 7-14	5971 thru 5972	20-7
54-360	8-4	56-700 thru 56-711	2-10, 7-11	60-351	5-3
54-812	5-6, 5-7, 5-8, 5-9	56-792	1-16, 1-17, 2-7, 5-10, 5-11, 5-12	60-361	5-2
54010 thru 54015	J-1	56-798	1-4, 1-5, 7-14	60-451	5-12
5501060S	18-14	56-802	7-10	60-461	5-11
5501210S	18-14	56-850 thru 56-872	3-1, 3-2, 7-14	60-861	5-10
5501240S	18-14	56-873	4-3, 4-6	60-961	5-1
5501260S	18-14	56-880	7-10	60001 thru 60002	21-2
5501280S	18-14	56-885	7-10, 7-6, 7-7	60002000	20-1
5501513GS	18-14	56-892 thru 56-895	2-1, 2-2, 2-3, 2-6, 2-9, 3-4, 3-5, 6-3, 7-14	60003	21-2
5501513S	18-14	56-908	1-16, 1-17, 2-6, 2-7, 6-1, 7-13	60003000	20-1
5502513GS	18-14	56-937 thru 56-938	7-12	60004	21-2
5502513S	18-14	56-952	3-12	60004000	20-1
5502515GS	18-14	57-330 thru 57-331	1-11	60010	21-2
5502520GS	18-14	57-333	3-8	60018000 thru 60018200	20-1
5503015GS	18-14	57-340 thru 57-341	1-12	60027 thru 60038	21-2
5503015S	18-14	57-343	3-9	60058000 thru 60080000	20-1
5503020GS	18-14	57-370 thru 57-373	6-11, 6-6	60103 thru 60117	F-7
5503020S	18-14	57-375	1-15, 6-7	60118 thru 60119	F-8
5503025GS	18-14	57-376	2-4	6012...1-16, 1-17, 2-6, 2-7, 2-8, 4-3, 4-6, 5-10, 5-11, 5-12, 6-1, 7-1, 7-2, 7-4, 7-6, 20-12	F-8
5504020GS	18-14	57-378	1-15, 6-7	60120 thru 60142	F-8
5504020S	18-14	57-390 thru 57-393	6-12, 6-6	60143 thru 60152	F-7
5504025S	18-14	57-396	2-5	60153 thru 60173	F-8
5504030GS	18-14	57-533	3-6	60175 thru 60187	F-7
5504030S	18-14	57-543	3-7	60190 thru 60194	F-8
5505030GS	18-14	57-560 thru 57-561	1-8	60196 thru 60206	F-7
5505030S	18-14	57-570 thru 57-571	1-7, 6-4	60207 thru 60230	F-8
5505040GS	18-14	57-573	6-4, 6-9	60232 thru 60254	21-2
5505040S	18-14	57-575 thru 57-578	1-10, 6-5	60260 thru 60262	F-8
5506020GS	18-14	57-590 thru 57-593	6-10, 6-4	60265 thru 60272	F-7
5506020S	18-14	57-XXX	6-4 thru 6-7	60281 thru 60285	21-2
5506025GS	18-14	57701ASC thru 57780E3S	18-1	60286	F-8
5506025S	18-14	5785 thru 5792-01	20-8	60287 thru 60288	21-2
5506030GS	18-14	58-153	3-13	60291 thru 60299	F-8
5506030S	18-14	58-170	2-8	6040EPDME	18-4
5506040GS	18-14	58-172 thru 58-174	1-6	6050EPDME	18-4
5506040S	18-14	58-440	3-2	60EPDME	18-7
5506050GS	18-14	58-441	3-1	60EPDME3	18-7
				61-121	5-6
				61-171	5-9
				61-321	5-7



61-421	5-8	7130FWC	18-5	7302013EGRCS	18-23
6104	C-7	7130GS	18-5	7302013EGRS	18-21
6106 thru 6112	C-6	7130S	18-5	7302013EGS	18-20
61126	19-6	7140EPDME	18-5	7302013ERCS	18-23
6115 thru 6117	C-7	7140EPDME	18-7	7302013ERS	18-21
6123 thru 61230	C-7	7140FWC	18-5	7302013ES	18-20
61231 thru 61234	C-3	7140GS	18-5	7302015ECS	18-22
6124 thru 61240	C-7	7140S	18-5	7302015EGCS	18-22
61241 thru 61244	C-3	7150EPDME	18-5	7302015EGRCS	18-23
6125 thru 61250	C-7	7150EPDME	18-7	7302015EGRS	18-21
61251	C-3	7150FWC	18-5	7302015EGS	18-20
6126 thru 61260	C-7	7150GS	18-5	7302015ERCS	18-23
61261 thru 61262	C-3	7150S	18-5	7302015ERS	18-21
6128 thru 61320	C-6	7160EPDME	18-5	7302015ES	18-20
61325 thru 61365	C-6	7160EPDME	18-7	7302505EGS	18-20
6137	C-7	7160FWC	18-5	7302505ES	18-20
61370 thru 61375	C-6	7160GS	18-5	73025075EGS	18-20
6138	C-7	7160S	18-5	73025075ES	18-20
61380 thru 61420	C-6	7162015EGS	18-4	7302510EGS	18-20
61425	C-6	7162015ES	18-4	7302510ES	18-20
6143	C-8	7162015W	18-4	7302513ECS	18-22
61430 thru 61435	C-6	7162520EGS	18-4	7302513EGCS	18-22
6144	C-8	7162520ES	18-4	7302513EGRCS	18-23
61445	C-7	7162520W	18-4	7302513EGRS	18-21
6145	C-8	7163020EGS	18-4	7302513EGS	18-20
61450 thru 61455	C-7	7163020ES	18-4	7302513ERCS	18-23
6146	C-8	7163020W	18-4	7302513ERS	18-21
61460 thru 61525	C-7	7163025EGS	18-4	7302513ES	18-20
6153	C-6	7163025ES	18-4	7302515ECS	18-22
61530	C-7	7163025W	18-4	7302515EGCS	18-22
61535 thru 61555	C-6	7164020EGS	18-4	7302515EGRCS	18-23
6156	C-7	7164020ES	18-4	7302515EGRS	18-21
61560 thru 61590	C-6	7164020W	18-4	7302515EGS	18-20
61595 thru 61625	C-7	7164025EGS	18-4	7302515ERCS	18-23
6163	C-6	7164025ES	18-4	7302515ERS	18-21
61635 thru 61685	C-7	7164025W	18-4	7302515ES	18-20
61690 thru 61695	C-8	7164030EGS	18-4	7302520EGP	18-20
6170 thru 6171	C-7	7164030ES	18-4	7302520EGRP	18-21
63-000	5-1 thru 5-12	7164030W	18-4	7302520EP	18-20
7021501EPDME thru 7026020EPDME	18-6	7165040EGS	18-4	7302520ERP	18-21
7021501FES thru 7026015FES	18-6	7165040ES	18-4	7303005EGS	18-20
7022001GRVES thru 7026020GRVES	18-6	7165040W	18-4	7303005ES	18-20
7022001MES thru 7026020MES	18-6	7166040EGS	18-4	73030075EGS	18-20
70510E3S thru 70580E3S	18-2	7166040ES	18-4	73030075ES	18-20
70701ES thru 70780ES	18-3	7166040W	18-4	7303010EGS	18-20
7110EPDME	18-5	7166050EGS	18-4	7303010ES	18-20
7110EPDME	18-7	7166050ES	18-4	7303013ECS	18-22
7110FWC	18-5	7166050W	18-4	7303013EGCS	18-22
7110GS	18-5	7168060EGS	18-4	7303013EGRCS	18-23
7110S	18-5	7168060ES	18-4	7303013EGRS	18-21
7112EPDME	18-5	7168060W	18-4	7303013EGS	18-20
7112EPDME	18-7	7180EPDME	18-5	7303013ERCS	18-23
7112FWC	18-5	7180EPDME	18-7	7303013ERS	18-21
7112GS	18-5	7180FWC	18-5	7303013ES	18-20
7120EPDME	18-5	7180GS	18-5	7303015ECS	18-22
7120EPDME	18-7	7180S	18-5	7303015EGCS	18-22
7120FWC	18-5	72726 thru 72825	F-5	7303015EGRCS	18-23
7120GS	18-5	72850 thru 72891	18-14	7303015EGRS	18-21
7120S	18-5	72980 thru 72982	F-5	7303015EGS	18-20
7125EPDME	18-5	7302005EGS	18-20	7303015ERCS	18-23
7125EPDME	18-7	7302005ES	18-20	7303015ERS	18-21
7125FWC	18-5	73020075EGS	18-20	7303015ES	18-20
7125GS	18-5	73020075ES	18-20	7303020ECS	18-22
7125S	18-5	7302010EGS	18-20	7303020EGCS	18-22
7130EPDME	18-5	7302010ES	18-20	7303020EGRCS	18-23
7130EPDME	18-7	7302013ECS	18-22	7303020EGRS	18-21
		7302013EGCS	18-22	7303020EGS	18-20

7303020ERCS.....	18-23	7305025ERS.....	18-21	7308040ECS.....	18-22
7303020ERS.....	18-21	7305025ES.....	18-20	7308040EGCS.....	18-22
7303020ES.....	18-20	7305030EGP.....	18-20	7308040EGRCS.....	18-23
7304005EGS.....	18-20	7305030EGRP.....	18-21	7308040EGRS.....	18-21
7304005ES.....	18-20	7305030EP.....	18-20	7308040EGS.....	18-20
73040075EGS.....	18-20	7305030ERP.....	18-21	7308040ERCS.....	18-23
73040075ES.....	18-20	7306013EGP.....	18-20	7308040ERS.....	18-21
7304010EGS.....	18-20	7306013EGRP.....	18-21	7308040ES.....	18-20
7304010ES.....	18-20	7306013EP.....	18-20	73081 thru 73082.....	D-6
7304013ECS.....	18-22	7306013ERP.....	18-21	730EGS-1.....	18-20
7304013EGCS.....	18-22	7306015ECS.....	18-22	730EGS-2.....	18-20 thru 18-23
7304013EGRCS.....	18-23	7306015EGCS.....	18-22	730EGS-3.....	18-20 thru 18-23
7304013EGRS.....	18-21	7306015EGRCS.....	18-23	730EGS-4.....	18-20 thru 18-23
7304013EGS.....	18-20	7306015EGRS.....	18-21	730EGS-5.....	18-20 thru 18-23
7304013ERCS.....	18-23	7306015EGS.....	18-20	730EGS-6.....	18-20 thru 18-23
7304013ERS.....	18-21	7306015ERCS.....	18-23	730EGS-7.....	18-20 thru 18-23
7304013ES.....	18-20	7306015ERS.....	18-21	730EGS-8.....	18-20 thru 18-23
7304015ECS.....	18-22	7306015ES.....	18-20	730EGS-9.....	18-20 thru 18-23
7304015EGCS.....	18-22	7306020ECS.....	18-22	73230.....	18-15
7304015EGRCS.....	18-23	7306020EGCS.....	18-22	73231.....	18-15
7304015EGRS.....	18-21	7306020EGRCS.....	18-23	73232.....	18-15
7304015EGS.....	18-20	7306020EGRS.....	18-21	73233.....	18-15
7304015ERCS.....	18-23	7306020EGS.....	18-20	73234.....	18-15
7304015ERS.....	18-21	7306020ERCS.....	18-23	73235.....	18-15
7304015ES.....	18-20	7306020ERS.....	18-21	73236.....	18-15
7304020ECS.....	18-22	7306020ES.....	18-20	73237.....	18-15
7304020EGCS.....	18-22	7306025ECS.....	18-22	73238.....	18-15
7304020EGRCS.....	18-23	7306025EGCS.....	18-22	73250.....	18-15
7304020EGRS.....	18-21	7306025EGRCS.....	18-23	73251.....	18-15
7304020EGS.....	18-20	7306025EGRS.....	18-21	73252.....	18-15
7304020ERCS.....	18-23	7306025EGS.....	18-20	73253.....	18-15
7304020ERS.....	18-21	7306025ERCS.....	18-23	73254.....	18-15
7304020ES.....	18-20	7306025ERS.....	18-21	73255.....	18-15
7304025ECS.....	18-22	7306025ES.....	18-20	73256.....	18-15
7304025EGCS.....	18-22	7306030ECS.....	18-22	73260.....	18-15
7304025EGRCS.....	18-23	7306030EGCS.....	18-22	73261.....	18-15
7304025EGRS.....	18-21	7306030EGRCS.....	18-23	73262.....	18-15
7304025EGS.....	18-20	7306030EGRS.....	18-21	73263.....	18-15
7304025ERCS.....	18-23	7306030EGS.....	18-20	73264.....	18-15
7304025ERS.....	18-21	7306030ERCS.....	18-23	73392.....	18-14
7304025ES.....	18-20	7306030ERS.....	18-21	73393.....	18-14
7304030ECS.....	18-22	7306030ES.....	18-20	73396.....	18-14
7304030EGCS.....	18-22	7306040ECS.....	18-22	73398.....	18-14
7304030EGRCS.....	18-23	7306040EGCS.....	18-22	73399.....	18-14
7304030EGRS.....	18-21	7306040EGRCS.....	18-23	73400.....	18-14
7304030EGS.....	18-20	7306040EGRS.....	18-21	73401.....	18-14
7304030ERCS.....	18-23	7306040EGS.....	18-20	73402.....	18-14
7304030ERS.....	18-21	7306040ERCS.....	18-23	73403.....	18-14
7304030ES.....	18-20	7306040ERS.....	18-21	73404.....	18-14
7305015EGP.....	18-20	7306040ES.....	18-20	73406.....	18-14
7305015EGRP.....	18-21	73072 thru 73080.....	D-6	73409.....	18-14
7305015EP.....	18-20	7308025ECS.....	18-22	73410.....	18-14
7305015ERP.....	18-21	7308025EGCS.....	18-22	73422.....	18-14
7305020ECS.....	18-22	7308025EGRCS.....	18-23	73423.....	18-14
7305020EGCS.....	18-22	7308025EGRS.....	18-21	73424.....	18-14
7305020EGRCS.....	18-23	7308025EGS.....	18-20	73425.....	18-14
7305020EGRS.....	18-21	7308025ERCS.....	18-23	73553 thru 73559.....	18-15
7305020EGS.....	18-20	7308025ERS.....	18-21	73590.....	18-13
7305020ERCS.....	18-23	7308025ES.....	18-20	73591.....	18-13
7305020ERS.....	18-21	7308030ECS.....	18-22	73592.....	18-13
7305020ES.....	18-20	7308030EGCS.....	18-22	73594.....	18-13
7305025ECS.....	18-22	7308030EGRCS.....	18-23	73595.....	18-13
7305025EGCS.....	18-22	7308030EGRS.....	18-21	73596.....	18-13
7305025EGRCS.....	18-23	7308030EGS.....	18-20	73597.....	18-13
7305025EGRS.....	18-21	7308030ERCS.....	18-23	73608.....	18-16
7305025EGS.....	18-20	7308030ERS.....	18-21	73609.....	18-16
7305025ERCS.....	18-23	7308030ES.....	18-20	73610.....	18-16

73611.....	18-16	75025075S .....	18-11	75440.....	18-13
73621.....	18-13	7502510S .....	18-11	75441.....	18-13
73622.....	18-13	75098.....	18-18	75442.....	18-13
73623.....	18-13	75099.....	18-18	75443.....	18-13
73624.....	18-13	75100.....	18-18	75444.....	18-13
73625.....	18-13	75101.....	18-18	75445.....	18-13
73629.....	18-13	75102.....	18-18	75446.....	18-13
73630.....	18-13	75103.....	18-18	75465.....	18-15
73631.....	18-13	75104.....	18-18	75466.....	18-15
73691.....	18-16	75105.....	18-18	75470.....	18-13
73694.....	18-16	75106.....	18-18	75471.....	18-13
73695.....	18-16	75107.....	18-18	75472.....	18-13
73696.....	18-16	75108.....	18-18	75473.....	18-13
73697.....	18-16	75121.....	18-18	75474.....	18-13
73756.....	18-14	75122.....	18-18	75475.....	18-13
73758.....	18-14	75123.....	18-18	75476.....	18-13
73764.....	18-14	75124.....	18-18	75477.....	18-13
73766.....	18-14	75125.....	18-18	75478.....	18-13
73767.....	18-14	75126.....	18-18	75479.....	18-13
73794.....	18-17	75129.....	18-18	75480.....	18-13
73795.....	18-17	75130.....	18-18	75481.....	18-13
73796.....	18-17	75131.....	18-18	75482.....	18-13
73797.....	18-17	75132.....	18-18	75483.....	18-13
73799.....	18-17	75133.....	18-18	75484.....	18-13
74254.....	18-15	75148.....	18-19	75485.....	18-13
74265.....	18-15	75150.....	18-19	75489.....	18-13
74283.....	18-15	75151.....	18-19	75490.....	18-15
74292.....	18-18	75152.....	18-19	75491.....	18-15
74293.....	18-18	75153.....	18-19	75492.....	18-15
74294.....	18-18	75154.....	18-19	75493.....	18-15
74295.....	18-18	75155.....	18-19	75500.....	18-16
74296.....	18-18	75156.....	18-19	75501.....	18-16
74297.....	18-18	75157.....	18-19	75502.....	18-16
74298.....	18-18	75158.....	18-19	75503.....	18-16
74299.....	18-18	75309.....	18-12	75504.....	18-16
74309.....	18-18	75310.....	18-12	75505.....	18-16
74310.....	18-18	75315.....	18-12	75506.....	18-16
74311.....	18-18	75323.....	18-12	75507.....	18-16
74312.....	18-18	75410.....	18-13	75508.....	18-16
74313.....	18-18	75411.....	18-13	75509.....	18-16
74314.....	18-18	75412.....	18-13	75510.....	18-16
74315.....	18-19	75413.....	18-13	75511.....	18-16
74316.....	18-19	75414.....	18-13	75512.....	18-16
74317.....	18-19	75415.....	18-13	75513.....	18-16
74318.....	18-19	75416.....	18-13	75514.....	18-16
74319.....	18-19	75417.....	18-13	75515.....	18-16
74322.....	18-19	75418.....	18-13	75516.....	18-16
74323.....	18-19	75419.....	18-13	75517.....	18-16
74324.....	18-19	75420.....	18-13	75518.....	18-16
74325.....	18-19	75421.....	18-13	75519.....	18-16
74326.....	18-19	75422.....	18-13	75520.....	18-16
74328.....	18-14	75423.....	18-13	75521.....	18-16
74330.....	18-19	75424.....	18-13	75522.....	18-16
74331.....	18-19	75425.....	18-13	75523.....	18-16
74335.....	18-18	75426.....	18-13	75524.....	18-16
74336.....	18-18	75427.....	18-13	75525.....	18-16
74337.....	18-18	75428.....	18-13	75526.....	18-16
74338.....	18-18	75429.....	18-13	75527.....	18-16
74339.....	18-18	75430.....	18-13	75528.....	18-16
74405 thru 74408.....	18-18	75431.....	18-13	75529.....	18-16
7501505S .....	18-11	75432.....	18-13	75534.....	18-16
75015075S .....	18-11	75433.....	18-13	75546.....	18-16
7501510S .....	18-11	75435.....	18-13	75559.....	18-12
7502005S .....	18-11	75436.....	18-13	75560.....	18-12
75020075S .....	18-11	75437.....	18-13	75579.....	18-12
7502010S .....	18-11	75438.....	18-13	75580.....	18-12
7502505S .....	18-11	75439.....	18-13	75590.....	18-16

75840.....	18-17	80025 thru 80026.....	19-2	86780 thru 86782.....	F-5
75841.....	18-17	80026PF.....	19-1	88100 thru 88130B.....	F-2
75842.....	18-17	80027 thru 80051.....	19-2	90-280.....	13-4, 13-17
75843.....	18-17	80051PF.....	19-1	90-380.....	13-4, 13-17
75845.....	18-17	80052 thru 80076.....	19-2	90-480.....	13-4, 13-17
75846.....	18-17	80076PF.....	19-1	90-491.....	13-6, 13-17
75847.....	18-17	80077 thru 80100.....	19-2	90-680.....	13-4, 13-17
75848.....	18-17	80100800.....	20-1	90-691.....	13-6, 13-17
75849.....	18-17	80101.....	19-2	90-880.....	13-4, 13-17
75850.....	18-17	80101010 thru 80101020.....	20-1	90055 thru 90056.....	19-2
75851.....	18-17	80101PF.....	19-1	90180 thru 90195.....	H-4
75852.....	18-17	80102 thru 80106.....	19-2	90235 thru 90246.....	H-7
75853.....	18-17	80132 thru 80136.....	19-3	90355 thru 90357.....	19-6
76755.....	18-16	80136PF.....	19-1	90360 thru 90375.....	H-1
76757.....	18-17	80137 thru 80141.....	19-3	90400 thru 90401.....	19-6
76758.....	18-17	80142 thru 80145.....	19-4	90610 thru 90645.....	D-3
76759.....	18-17	80145PF.....	19-1	90650 thru 90736.....	D-4
76768.....	18-16	80146 thru 80164.....	19-4	90740 thru 90761.....	19-6
76769.....	18-16	80175E thru 80176E.....	19-3	90765.....	D-4
76771.....	18-16	80176EPF.....	19-1	91-106.....	5-1, 5-2, 5-3
76772.....	18-16	80176W.....	19-3	91-556.....	7-5
76773.....	18-16	80176WPF.....	19-1	91189.....	H-4
76774.....	18-16	80177L thru 80178.....	19-4	91346.....	19-6
76775.....	18-16	80179.....	19-3	91725 thru 91736.....	D-4
76800.....	18-17	80180.....	19-4	92-000.....	4-1, 4-2, 7-13
76801.....	18-17	80190 thru 80195.....	H-4	92-020.....	20-5
76802.....	18-17	80196 thru 80198.....	19-4	92-200.....	8-2
76803.....	18-17	80198PF.....	19-1	92-210.....	8-4
76804.....	18-17	80199.....	19-4	92-270.....	16-3
76805.....	18-17	80200 thru 80202.....	19-3	92-280.....	11-3, 13-3, 13-4
76806.....	18-17	80202PF.....	19-1	92-289.....	16-2
76807.....	18-17	80203 thru 80215.....	19-3	92-302.....	20-4
76808.....	18-17	80220.....	19-2	92-309.....	10-1
76809.....	18-17	80249 thru 80251.....	19-4	92-311 thru 92-312.....	11-2
76810.....	18-17	80251PF.....	19-1	92-322 thru 92-326.....	12-1, 13-7
76811.....	18-17	80252 thru 80259.....	19-4	92-343 .13-3 thru 13-10, 14-1 thru 14-5, 16-1, 16-2, 8-1	
76812.....	18-17	80260 thru 80262.....	19-3	92-370.....	16-4
76813.....	18-17	80262PF.....	19-1	92-414.....	20-4
76814.....	18-17	80263 thru 80264.....	19-3	92-445.....	20-3
76815.....	18-17	80264PF.....	19-1	92-470.....	20-5
76816.....	18-17	80265 thru 80276.....	19-3	92-477.....	13-2, 13-5, 13-7
76817.....	18-17	80300 thru 80308.....	19-5	92-570.....	13-7
76818.....	18-17	80462 thru 80463.....	19-4	92-630.....	9-1
76819.....	18-17	8060EPDME.....	18-4	92733 thru 92736.....	D-4
76820.....	18-17	80EPDMAC.....	18-7	97602401 thru 97602501.....	20-1
76821.....	18-17	80EPDME3.....	18-7	HS1 thru NB1.....	H-1
76825.....	18-17	81300.....	H-4	NB10550.....	18-7
76826.....	18-17	81301.....	H-7	NB10650.....	18-7
76827.....	18-17	81303000 thru 81811000.....	20-3	NB125.....	H-1
76828.....	18-17	82400300 thru 82602500.....	20-2	NB12575.....	18-7
76829.....	18-17	83-380.....	13-4	NB15 thru NB2.....	H-1
76830.....	18-17	83-480.....	13-4	NB37225.....	18-7
76831.....	18-17	83-491.....	13-6	NB50300.....	18-7
76832.....	18-17	83-680.....	13-4	NB62325.....	18-7
76833.....	18-17	83-880.....	13-4	NB62475.....	18-7
76834.....	18-17	831 thru 836.....	20-9	NB75.....	H-1
76835.....	18-17	8549-02 thru 8549-22.....	5-6 thru 5-9	NB75475.....	18-7
76836.....	18-17	86200 thru 86206.....	F-5	NB87650.....	18-7
76837.....	18-17	86207 thru 86229.....	F-6	PT1000.....	18-7
76838.....	18-17	86230 thru 86234.....	F-5	STP1305ES.....	18-11
76839.....	18-17	86235 thru 86279.....	F-6	STP13075ES.....	18-11
80000 thru 80001.....	19-2	86280 thru 86322.....	F-5	STP1310ES.....	18-11
80001PF.....	19-1	86323 thru 86326.....	F-8	STP1505ES.....	18-11
80002 thru 80006.....	19-2	86340 thru 86341.....	F-5	STP15075ES.....	18-11
80008 thru 80010.....	19-3	86342.....	F-6	STP1510ES.....	18-11
80010PF.....	19-1	86710 thru 86715.....	F-4	STP2005ES.....	18-11
80011 thru 80015.....	19-3	86755 thru 86772.....	F-6		

STP20075ES.....	18-11
STP2010ES.....	18-11
STP2505ES.....	18-11
STP25075ES.....	18-11
STP2510ES.....	18-11
TC100 thru TC1004.....	21-5
TC1005X thru TC1010.....	21-6
TC1011.....	21-5
TC1012C thru TC1016.....	21-4
TC1017C.....	21-5
TC1018C thru TC1018M.....	21-3
TC1019.....	21-5
TC1020C thru TC1024C.....	21-4
TC1027C thru TC1029L.....	21-3
TC1030SS thru TC1034Q.....	21-4
TC1100L thru TC1100S.....	21-5
TC155 thru TC172G.....	21-3
TC4401 thru TC4406.....	21-6

# tyco

## Fire Protection Products



### WORLDWIDE HEADQUARTERS

Tyco Fire & Building Products  
1400 Pennbrook Parkway  
Lansdale, PA 19446  
Tel: 215-362-0700, 800-523-6512  
Fax: 215-362-5385  
www.Tyco-Fire.com

### UNITED STATES

Central Sprinkler Company  
451 N. Cannon Avenue  
Lansdale, PA 19446  
Tel: 215-362-0700, Fax: 215-362-5385

#### Brea, CA:

Tel: 714-993-6111, Fax 714-993-6043

#### Decatur, GA:

Tel: 404-243-7336, Fax 404-244-7375

#### Norristown, PA:

Tel: 610-239-9925, Fax 610-239-9936

#### Jessup, MD:

Tel: 301-604-7133, Fax 301-604-7138

#### Carol Stream, IL:

Tel: 630-871-7700, Fax 630-871-7464

#### Coppell, TX:

Tel: 972-745-0043, Fax 972-745-8594

#### Kent, WA:

Tel: 253-872-6030, Fax 253-872-6547

#### Avon, MA:

Tel: 508-583-8447, Fax 508-583-0034

#### Pompano Beach, FL:

Tel: 954-781-0866, Fax 954-781-1475

#### Murray UT:

Tel: 801-269-0688, Fax 801-269-0733

#### Tigard, OR:

Tel: 503-620-4203, Fax 503-620-3817

#### Parma, OH:

Tel: 216-265-0505, Fax 216-265-8354

#### Kansas City, MO:

Tel: 816-842-2424, Fax 816-842-4433

National Distribution Facility  
PO Box 2806  
Lubbock, TX 79408-2806

### UNITED STATES (cont.)

Gem Sprinkler & Star Sprinkler  
7071 S. 13th Street, Ste. 103  
Oak Creek, WI 53154  
Tel: 877-436-8926, Fax: 877-866-9250

### CANADA

Regional Headquarters  
12-16715 Yonge Street, Suite 316  
Newmarket, Ontario L3X 1X4  
Tel: 866-688-9707, 705-422-0010  
Fax 705-422-1396

### EUROPE & MIDDLE EAST

Regional Headquarters  
Kopersteden 1, NL-7547 TJ Enschede  
P.O. Box 198, 7500 AD  
Enschede, The Netherlands  
Tel: 31-53-428-4444, Fax: 31-53-428-3377

#### Stockport, UK:

Tel: 44-161-477-1886, Fax 44-161-477-6729

#### Paris Nord II, France:

Tel: 33-1-48-178-727, Fax 33-1-48-178-720

#### Rodgau Germany:

Tel: 49-6106-84455, Fax 49-6106-18177

#### Costlada Madrid, Spain:

Tel: 34-1-669-3906, Fax 34-1-669-2018

#### Lørenskog, Norway:

Tel: 47-67-91-77-00, Fax 47-67-91-77-15

#### Lammhult, Sweden:

Tel: 46-472-269-980, Fax 46-472-269-989

#### Dublin, Ireland:

Tel: 353-166-839-82, Fax 353-166-822-54

#### Bolzano, Italy:

Tel: 39-0471-252-091, Fax 39-0471-254-058

#### Milano, Italy:

Tel: 39-0293-548-736, Fax 39-0293-548-690

#### Dubai, United Arab Emirates:

Tel: 971-488-38689, Fax 971-488-38674

#### Budapest, Hungary:

Tel: 36-148-11-383, Fax 36-120-34-427

#### Wels/Thalheim, Austria:

Tel: 43-072-42-65-054, Fax 43-072-42-74-393

### LATIN AMERICA

Regional Headquarters  
South America, Central America & Caribbean  
1802 S.W. 2nd St.  
Pompano Beach, FL 33069  
Tel: 954-781-0866, Fax 954-781-9330

#### Regional Headquarters - Mexico

Hamburgo 231A Piso 2  
Colonia Juarez  
Mexico, D.F. 06600 Mexico  
Tel: 525-55-2075766, Fax: 525-55-2077566

### ASIA

#### Regional Headquarters

No.45 Tuas Avenue 9,  
Singapore 639189

#### Central Sprinkler Company

##### Singapore:

Tel: 65-6743-3212, Fax 65-6743-9181

##### Shanghai, China:

Tel: 86-21-5868-3300, Fax 86-21-5868-1160

##### Beijing, China:

Tel: 86-10-6515-6191, Fax 86-10-6515-6157

##### Chengdu, China:

Tel: 86-28-689-9440, Fax 86-28-666-2538

#### Gem Sprinkler Company & Star Sprinkler Inc.

##### Singapore:

Tel: 65-6861-1655, Fax 65-6861-1312

##### Kuala Lumpur, Malaysia:

Tel: 60-3-8024-6773, Fax 60-3-8024-2180

##### Hong Kong:

Tel: 852-2595-0686, Fax 852-2505-5826

***www.tyco-fire.com***

© Copyright 2012 Tyco Fire Protection Products  
Updated 1/2011

***Distributed by:***

