

The MUELLER 300 Ball Valve is an optimized design combining a strong, reliable ball/stem connection with other desired features, including a blow-

out-proof stem, double O-rings and a 300 psig working pressure rating. The design offers true bi-directional (two way) flow.

MUELLER 300 Ball Curb Valve

❑ **BLOW-OUT-PROOF STEM DESIGN** - prevents separation and assures dependable, safe operation.

❑ **OPTIMIZED KEY TO BALL CONNECTION** provides strong, reliable performance and resists breakage.

❑ **FULL THREAD DEPTH** - and drill depth on F.I.P. thread ends (meets ANSI/ AWWA C800 Standard).

❑ **FULL ROUNDWAY** provides straight - through flow (reduced port available).

❑ **END PIECES O-RING SEALED** - to provide additional protection against leaking.

❑ **MANUFACTURED AND TESTED** - to ANSI/AWWA C800 Standard.

❑ **DOUBLE O-RING SEALS** - are supported in precision machined grooves and provide secure, leak - tight sealing.

❑ **300 PSIG** - maximum working pressure.

❑ **QUARTER TURN CHECK** - is integrally cast on body to assure positive action. Checkless 360° turn is optional.

❑ **FLUOROCARBON COATED BALL** - ensures smooth, easy turning operation.

❑ **STAINLESS STEEL REINFORCED SEAT** assures reliable seal under full flow and pressure.

❑ **END CONNECTIONS** include copper flare, MUELLER 110® Compression Connection, Pack Joint Connection, Copper Flare, M.I.P and F.I.P. thread.

❑ **HEAVY BRASS COMPONENTS** - constructed of solid 85-5-5-5 ASTM B62 brass for strength and durability.

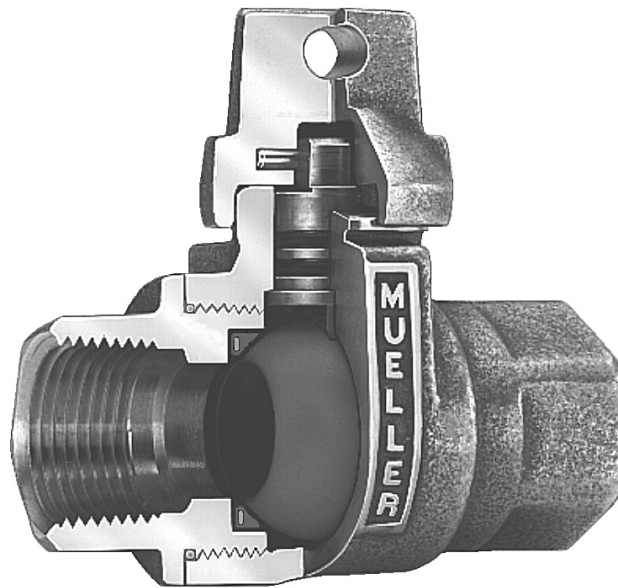

❑ **SUITABLE** - for use as test valves on Backflow Preventers (complies with Notice 89-001 of F.C.C.C. and H.R.).

7.32

Mueller Co.

Rev. 9-09



www.muellercompany.com

moreinfo@muellercompany.com

Repair Lids



H-10373

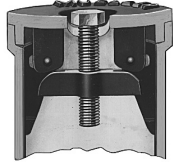

H-10373

H-10373 Repair lid for new style Buffalo type curb boxes
Size: 2-1/2"



H-10374



H-10374

H-10374 Repair lid for old style Buffalo type curb boxes
Sizes: 2-1/2", 3"

Size of lid	Minimum diameter	Maximum diameter
2-1/2"	2-13/16"	3-3/4"
3"	3-3/8"	4-1/8"

The sizes (size of lid) refer to the Buffalo box size at the base, not the upper section. Both types of repair lids are heavily constructed of gray iron, have a stainless steel standard pentagon screw*, and the word "WATER" in raised letters.

Note: When the top section of the box is broken off completely, whether old or new style, always use the old style (H-10374) repair lid.

* Repair lids only.

Curb Box Sleeve

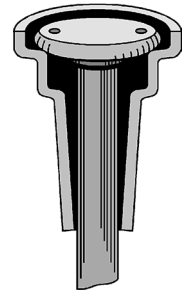

Curb Box Sleeve Installed

H-10342 curb boxes having a 1" upper section.

This cast iron curb box sleeve provides a convenient method of setting a curb box in cement. It prevents cement from adhering to the lid, a condition which could make it difficult or even impossible to remove the lid. To install the sleeve, the lid is first removed from the box, the sleeve is slipped over the upper section, and the lid is replaced. The sliding upper section of the curb box is raised or lowered, along with the sleeve, to the level of the concrete as it is poured.

Curb box adapter



H-10344 Curb box adapter
Sizes: 2-1/2"x2", 3"x2", 3"x2-1/2", 3-1/2"x2", 3-1/2"x2-1/2"

Sizes	2-1/2"x2"	3"x2"	3"x2-1/2"	3-1/2"x2"	3-1/2"x2-1/2"
Size of male Minneapolis thread	2"	2"	2-1/2"	2"	2-1/2"
Size of female Minneapolis thread	2-1/2"	3"	3"	3-1/2"	3-1/2"

This cast iron curb box adapter allows a Minneapolis pattern curb box to be used on 1-1/4", 1-1/2", and 2" Minneapolis pattern curb valves and stops. The adapter will add 5" to the length of the box. These adapters are not recommended for boxes with 1" upper section.

Standard pentagon screw



This screw is used in Buffalo type curb box lids, is made of red brass, and has a standard pentagon head.

H-10324 Standard pentagon screw

Rev. 9-09

**H-10321 Shut-off rod****Lengths: 2', 3', 4', 5', 6', 7' and 8'**

For use with all Buffalo type boxes and the following curb boxes: H-10300, H-10302, H-10304, H-10306, H-10308, H-10310, H-10316, H-10336, H-10385, H-10386, H-10387, H-10388 will fit stops and valves to 2" in size. One end is flattened like a chisel and the other end is pointed for digging ice or dirt away from lid of box. Made of steel.

**H-10322 Curb box key****Lengths: 2', 3', 4', 5' and 6'**

Designed especially for use with H-10312, H-10314, H-10332, and H-10334 Curb boxes. One end of the crossbar handle has a curved point for digging ice or dirt away from lid of box. Other end has a spanner wrench for removing lids from the H-10312 or H-10314 boxes. Made of steel.

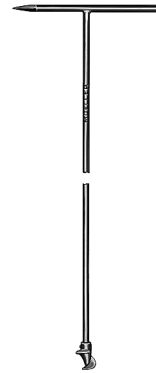
**H-10330 Clean-out auger for 2-1/2" Buffalo boxes****Lengths: 4', 5' and 6'****H-10331 Clean-out auger for 3" Buffalo boxes**

Used to open clogged Buffalo type curb boxes quickly and easily. Eliminates digging up box to reach the curb stop. One end of the handle is pointed for digging ice or dirt away from lid of box. Rod and crossbar handle are made of steel and auger spiral is made of malleable iron.

**H-10356 Combination key****Lengths: 18", 27", 36", and 48"**

For use with Buffalo type curb boxes to remove screw in lid and operate stationary shut-off rods. Will not fit tee head of curb valves or stops.

**H-10323 Pentagon key - Ductile iron**

Used for operating the screws of MUELLER and Buffalo type curb boxes or repair lids. One end is pointed for digging ice or dirt away from lid of box. Other end is a hammer head. Fits standard water works pentagon.

CURB BOXES - EXTENSION TYPE WITH MINNEAPOLIS PATTERN BASE

Dimensions and Optional Stationary Rod

H-10300, H-10302 and H-10304 Curb boxes

Curb box catalog number	Box length extended		Box length fully retracted		Weight		Optional stationary rod	
	Inch	mm	Inch	mm	lbs.	kg.	Part No.	L'gth inches
H-10300 1-1/4" upper section	24	610	18.00	457.0	12.0	5.4	84774	12.75
	30	762	18.00	457.0	14.0	6.4	84346	15.0
	36	914	24.00	610.0	15.0	6.8	84275	21.0
	42	1067	30.00	762.0	16.0	7.3	84233	27.0
	48	1219	36.00	914.0	17.0	7.7	84245	33.0
	54	1372	42.00	1067.0	18.0	8.2	84247	39.0
	60	1524	48.00	1219.0	19.0	8.6	84154	45.0
	66	1676	54.00	1372.0	20.0	9.1	84261	51.0
	72	1829	60.00	1524.0	22.0	10.0	84341	57.0
	78	1981	66.00	1676.0	23.0	10.4	84297	63.0
	84	2134	72.00	1829.0	24.0	10.9	84152	69.0
	90	2286	78.00	1981.0	25.0	11.3	88703	75.0
96	2438	84.00	2134.0	26.0	11.8	84274	81.0	
H-10302 1-1/2" upper section	24	610	21.44	544.5	13.0	5.9	-	-
	30	762	21.44	544.5	15.0	6.8	84742	15.0
	36	914	24.00	610.0	16.0	7.3	84256	21.0
	42	1067	30.00	762.0	17.0	7.7	84326	27.0
	48	1219	36.00	914.0	18.0	8.2	84305	33.0
	54	1372	42.00	1067.0	20.0	9.1	84338	39.0
	60	1524	48.00	1219.0	21.0	9.5	84353	45.0
	66	1676	54.00	1372.0	22.0	10.0	88702	51.0
	72	1829	60.00	1524.0	23.0	10.4	84255	57.0
	78	1981	66.00	1676.0	25.0	11.3	83299	63.0
	84	2134	72.00	1829.0	25.5	11.8	80643	69.0
	90	2286	78.00	1981.0	26.3	12.2	84832	75.0
96	2438	84.00	2134.0	27.0	12.7	88139	81.0	
H-10304 2" upper section	24	610	21.44	544.5	21.0	9.5	-	-
	30	762	21.44	544.5	23.0	10.4	84146	15.0
	36	914	24.00	610.0	25.0	11.3	84162	21.0
	42	1067	30.00	762.0	27.0	12.2	84147	27.0
	48	1219	36.00	914.0	28.0	12.7	84176	33.0
	54	1372	42.00	1067.0	30.0	13.6	84139	39.0
	60	1524	48.00	1219.0	32.0	14.5	84140	45.0
	66	1676	54.00	1372.0	34.0	15.4	84128	51.0
	72	1829	60.00	1524.0	35.0	15.9	84143	57.0
	78	1981	66.00	1676.0	37.0	16.8	84222	63.0
	84	2134	72.00	1829.0	39.0	17.7	84169	69.0
	90	2286	78.00	1981.0	41.0	18.6	-	-
96	2438	84.00	2134.0	43.0	19.5	-	-	

H-10312, H-10332, and H-10388 Curb

Curb box catalog number	Box length extended		Box length fully retracted		Weight		Optional stationary rod*	
	Inch	mm	Inch	mm	lbs.	kg.	Part Number	Length inches
H-10312** H-10332** 1" upper section	24	610	18.00	305.0	9.5	4.3	84525	11.25
	30	762	18.00	457.0	10.0	4.5	82892	16.75
	36	914	24.00	610.0	11.0	5.0	82862	21.00
	42	1067	30.00	762.0	12.0	5.4	82863	27.00
	48	1219	36.00	914.0	14.0	6.4	82864	33.00
	54	1372	42.00	1067.0	15.0	6.8	82865	39.00
	60	1524	48.00	1219.0	16.0	7.3	82866	45.00
	66	1676	54.00	1372.0	17.0	7.7	82867	51.00
	72	1829	60.00	1524.0	18.0	8.2	82868	57.00
	78	1981	66.00	1676.0	19.0	8.6	82869	63.00
	84	2134	72.00	1829.0	20.0	9.1	82870	69.00
	90	2286	78.00	1981.0	21.0	9.5	82871	75.00
96	2438	84.00	2134.0	22.0	10.0	82872	81.00	
H-10388 1-1/4" upper section	24	610	18.00	305.0	9.5	4.3	84525	11.25
	30	762	18.00	457.0	10.0	4.5	82892	16.75
	36	914	26.50	673.1	14.5	6.6	84275	21.00
	42	1067	32.50	825.5	15.5	7.0	84233	27.00
	48	1219	38.50	977.9	16.5	7.5	84245	33.00
	54	1372	44.50	1130.3	17.5	7.9	84247	39.00
	60	1524	50.50	1282.7	18.5	8.4	84154	45.00
	66	1676	56.50	1435.1	19.5	8.8	84261	51.00
	72	1829	62.50	1587.5	21.5	9.8	84341	57.00
	78	1981	68.50	1739.9	22.5	10.2	84297	63.00
	84	2134	74.50	1892.3	23.5	10.7	84152	69.00
	90	2286	80.50	2044.7	24.5	11.1	88703	75.00

Extra lids and plug



Lid with Plug

Plug only

One piece lid

Curb box catalog number	One piece lid part number	Quantity per carton	Lid with plug part number	Quantity per carton	Plug part number only
H-10300	-	-	89375	10	58039
H-10302	-	-	89980	10	58116
H-10304	-	-	89981	10	59478
H-10312	89982	10	-	-	-
H-10332	-	-	89376	10	36571

Optional reducing

Bushing part number	Bushing size	Minneapolis thread size
H-10343	2"x1-1/2"	2"
	2-1/2"x1-1/2"	2-1/2"
	2-1/2"x2"	2-1/2"
	3-1/2"x3"	3-1/2"

*Stationary rods are supplied with H-10312 and H-10332 only. Stationary rods are optional with all other boxes within these pages and must be ordered separately.

** The H-10312 and H-10332 are the same except that the H-10312 has a one piece lid and the H-10332 has a combination lid and pentagon plug.

TO ORDER BOXES SPECIFY EXTENDED LENGTH, SIZE OF MINNEAPOLIS THREAD AND CATALOG NUMBER



Extension type curb box with Minneapolis pattern base - for 1/2" through 2" curb valves

The base is tapped to attach to the threaded top of the Minneapolis pattern curb valves. This arrangement helps to prevent frost heave from separating the box from the valve, and excludes dirt and debris. The box is cast iron and is furnished with a cast iron lid and pentagon plug (the H-10312 is furnished with a one piece lid that requires a spanner wrench to remove –wrench ordered separately). The upper part of the box is spring loaded and telescopes into the base to allow for grade adjustments within the range given in the dimension charts. Stationary rods, shut-off rods, and pentagon keys are optional and are ordered separately.

Box Selection

Curb Valve & Size	Box		
	Catalog Number	Inside Diameter	Base Tapping
300™ Ball			
3/4"	H-10300	1-1/4"	1-1/2"
	H-10302	1-1/2"	2-1/2" (1-1/2" bushing)
	H-10312**	1"	1-1/2"
	H-10332**	1"	1-1/2"
	H-10300-99008	1-1/4"	2" (1-1/2" bushing)
	H-10302-99004	1-1/2"	2" (1-1/2" bushing)
1"	H-10300	1-1/4"	1-1/2"
	H-10302	1-1/2"	2-1/2" (1-1/2" bushing)
	H-10312**	1"	1-1/2"
	H-10332**	1"	1-1/2"
	H-10300-99008	1-1/4"	2" (1-1/2" bushing)
	H-10302-99004	1-1/2"	2" (1-1/2" bushing)
1-1/2"	H-10300-99002	1-1/4"	2"
	H-10302-99005	1-1/2"	2"
	H-10302-99007	1-1/2"	2-1/2" (2" bushing)
	H-10312-99000	1"	2"
2"	H-10332-99000	1"	2"
	H-10300-99002	1-1/4"	2"
	H-10302-99005	1-1/2"	2"
	H-10302-99007	1-1/2"	2-1/2" (2" bushing)
H-10312-99000	H-10312-99000	1"	2"
	H-10332-99000	1"	2"
	H-10300-99002	1-1/4"	2"
	H-10302-99005	1-1/2"	2"
	H-10302-99007	1-1/2"	2-1/2" (2" bushing)
	H-10312-99000	1"	2"
H-10332-99000	H-10332-99000	1"	2"
	H-10300-99002	1-1/4"	2"
	H-10302-99005	1-1/2"	2"
	H-10302-99007	1-1/2"	2-1/2" (2" bushing)
	H-10312-99000	1"	2"
	H-10332-99000	1"	2"
MARK II®			
3/4"	H-10300	1-1/4"	1-1/2"
	H-10302	1-1/2"	2-1/2" (1-1/2" bushing)
	H-10312**	1"	1-1/2"
	H-10332**	1"	1-1/2"
	H-10300-99008	1-1/4"	2" (1-1/2" bushing)
	H-10302-99004	1-1/2"	2" (1-1/2" bushing)
1"	H-10300-99002	1-1/4"	2"
	H-10302-99005	1-1/2"	2"
	H-10312-99000	1"	2"
	H-10332-99000	1"	2"
1-1/4"	H-10302-99006	1-1/2"	2-1/2"
	H-10304	2"	2-1/2"
	H-10388	1-1/4"	2-1/2"
1-1/2"	H-10304-99000	2"	3"
	H-10304-99007	2"	3-1/2" (3" bushing)
2"	H-10304-99002	2"	3-1/2"
ORISEAL®			
3/4"	H-10300-99002	1-1/4"	2"
	H-10302-99005	1-1/2"	2"
	H-10312-99000	1"	2"
1"	H-10332-99000	1"	2"
	H-10302-99006	1-1/2"	2-1/2"
	H-10304	2"	2-1/2"
	H-10388	1-1/4"	2-1/2"

** The H-10312 and H-10332 are the same except that the H-10312 has a one piece lid and the H-10332 has a combination lid and pentagon plug.

CURB BOXES - EXTENSION TYPE WITH ARCH PATTERN BASE

Dimensions and Optional Stationary Rod

H-10306 and H-10308 Curb Boxes

H-10310, H-10314 and H-10334 Curb boxes

Curb box catalog number	Box length extended		Box length fully retracted		Weight		Optional stationary rod	
	Inch	mm	Inch	mm	lbs.	kg.	Part No.	L'gth inch
H-10306	24	610	18.00	457.0	12.0	5.4	84774	12.75
	30	762	18.00	457.0	14.0	6.4	84346	15.0
	36	914	24.00	610.0	15.0	6.8	84275	21.0
	42	1067	30.00	762.0	16.0	7.3	84233	27.0
	48	1219	36.00	914.0	17.0	7.7	84245	33.0
	54	1372	42.00	1067.0	18.0	8.2	84247	39.0
	60	1524	48.00	1219.0	19.0	8.6	84154	45.0
	66	1676	54.00	1372.0	20.0	9.1	84261	51.0
	72	1829	60.00	1524.0	22.0	10.0	84341	57.0
	78	1981	66.00	1676.0	23.0	10.4	84297	63.0
	84	2134	72.00	1829.0	24.0	10.9	84152	69.0
	90	2286	78.00	1981.0	25.0	11.3	88703	75.0
96	2438	84.00	2143.0	26.0	11.8	84274	81.0	
H-10308	24	610	20.44	519.2	13.0	5.9		
	30	762	20.44	519.2	15.0	6.8	84742	15.0
	36	914	24.00	610.0	16.0	7.3	84256	21.0
	42	1067	30.00	762.0	17.0	7.7	84326	27.0
	48	1219	36.00	914.0	18.0	8.2	84305	33.0
	54	1372	42.00	1067.0	20.0	9.1	84338	39.0
	60	1524	48.00	1219.0	21.0	9.5	84353	45.0
	66	1676	54.00	1372.0	22.0	10.0	88702	51.0
	72	1829	60.00	1524.0	23.0	10.4	84255	57.0
	78	1981	66.00	1676.0	25.0	11.3	83299	63.0
	84	2134	72.00	1829.0	26.0	11.8	80643	69.0
	90	2286	78.00	1981.0	27.0	12.2	84832	75.0
96	2438	84.00	2143.0	28.0	12.7	88139	81.0	

Curb box catalog number	Box length extended		Box length fully retracted		Weight		Optional stationary rod*	
	Inch	mm	Inch	mm	lbs.	kg.	Part No	L'gth inches
H-10310	24	610	21.44	544.5	21.0	9.5		
	30	762	21.44	544.5	23.0	10.4	84146	15.0
	36	914	24.00	610.0	25.0	11.3	84162	21.0
	42	1067	30.00	762.0	27.0	12.2	84147	27.0
	48	1219	36.00	914.0	28.0	12.7	84176	33.0
	54	1372	42.00	1067.0	30.0	13.6	84139	39.0
	60	1524	48.00	1219.0	32.0	14.5	84140	45.0
	66	1676	54.00	1372.0	34.0	15.4	84128	51.0
	72	1829	60.00	1524.0	35.0	15.9	84143	57.0
	78	1981	66.00	1676.0	37.0	16.8	84222	63.0
	84	2134	72.00	1829.0	39.0	17.7	84169	69.0
	90	2286	78.00	1981.0	41.0	18.6		
96	2438	84.00	2134.0	43.0	19.5			
H-10314**	24	610	18.00	305.0	9.5	4.3	82875	11.25
H-10334**	30	762	18.00	457.0	10.0	4.5	82892	16.75
H-10314** H-10334**	36	914	24.00	610.0	11.0	5.0	82862	21.0
	42	1067	30.00	762.0	12.0	5.4	82863	27.0
	48	1219	36.00	914.0	14.0	6.4	82864	33.0
	54	1372	42.00	1067.0	15.0	6.8	82865	39.0
	60	1524	48.00	1219.0	16.0	7.3	82866	45.0
	66	1676	54.00	1372.0	17.0	7.7	82867	51.0
	72	1829	60.00	1524.0	18.0	8.2	82868	57.0
	78	1981	66.00	1676.0	19.0	8.6	82869	63.0
	84	2134	72.00	1829.0	20.0	9.1	82870	69.0
	90	2286	78.00	1981.0	21.0	9.5	82871	75.0

Extra lids and plug

Lids are cast iron with an integrally cast brass bushing which allows for easy removal of pentagon plug.



Curb Box Catalog number	One piece lid part number	Lid with brass pentagon plug - part number	Lid with brass bushing and cast iron plug	Plug only part number	
				Cast Iron	Brass
H-10306	-	89369	89375	58039	63670
H-10308	-	581642	89980	58116	63683
H-10310	89982	681714	89981	59478	63684
H-10314	-	-	-	-	-
H-10334		89376	89376	-	36571

* Stationary rods are supplied with H-10314 and H-10334 only. Stationary rods are optional with all other boxes shown on this page and must be ordered separately.

** The H-10314 and H-10334 boxes are the same except the H-10314 is furnished with a one piece lid, the H-10334 has a combination lid and pentagon plug.

TO ORDER BOXES SPECIFY EXTENDED LENGTH AND CATALOG NUMBER



Extension type curb box with arch pattern base-for 1/2" through 2" curb valves

The arched base rests on top of the valve and extends down around the valve head to help exclude dirt and debris. The box is cast iron and is furnished with a cast iron lid and brass pentagon plug (the H-10314 is furnished with a one piece lid that requires a spanner wrench to remove – wrench ordered separately). The upper part of the box is spring loaded and telescopes into the base to allow for grade adjustment within the range given in the dimension charts. Stationery rods, shut-off rods, and pentagon keys are optional and are ordered separately.

Box Selection

Curb Valve & Size	Box	
	Catalog Number	Inside Diameter
300™ Ball		
3/4"	H-10306	1-1/4"
	H-10308	1-1/2"
	H-10314	1"
	H10334	1"
1"	H-10306	1-1/4"
	H-10308	1-1/2"
	H-10314	1"
	H10334	1"
1-1/2"	H-10310	2"
MARKII®		
3/4"	H-10306	1-1/4"
	H-10308	1-1/2"
1"	H-10306	1-1/4"
	H-10308	1-1/2"
1-1/4"	H-10310	2"
	H-10314**	1"
	H-10334**	1"
1-1/2"	H-10310	2"
2"	H-10310	2"
ORISEALIII®		
3/4"	H-10306	1-1/4"
	H-10308	1-1/2"
	H-10314**	1"
	H-10334**	1"
1"	H-10306	1-1/4"
	H-10308	1-1/2"
	H-10314**	1"
	H-10334**	1"
Inverted Key Curb Valve		
3/4"	H-10306	1-1/4"
	H-10308	1-1/2"
	H-10314**	1"
	H-10334**	1"
1"	H-10306	1-1/4"
	H-10308	1-1/2"
	H-10314**	1"
	H-10334**	1"

**The H-10314 and H-10334 boxes are the same except the H-10314 is furnished with a one piece lid, the H10334 has a combination lid and pentagon plug.

TO ORDER BOXES SPECIFY EXTENDED LENGTH AND CATALOG NUMBER

CURB BOXES - IMPROVED EXTENSION TYPE WITH ARCH PATTERN BASE

Mueller Co.

7.25

Shaded area indicates change Rev. 9-09

Dimensions and Optional Stationary Rod

H-10385 and H-10386 Curb Boxes

Curb box catalog number	Box length extended		Box length fully retracted		Weight		Optional stationary rod	
	Inch	mm	Inch	mm	lbs.	kg.	Part No.	L'gth inch
H-10385	24	610	17.75	450.8	13.8	6.2	84774	12-3/4
	30	762	20.50	520.7	14.8	6.7	84346	15
	36	914	26.50	673.1	16.0	7.3	84275	21
	42	1067	32.50	825.5	17.0	7.7	84233	27
	48	1219	38.50	977.9	18.3	8.3	84245	33
	54	1372	44.50	1130.3	19.3	8.7	84247	39
	60	1524	50.50	1282.7	20.3	9.2	84154	45
	66	1676	56.50	1435.1	21.5	9.8	84261	51
	72	1829	62.50	1587.5	22.8	10.3	84341	57
	78	1981	68.50	1739.9	24.0	10.9	84297	63
	84	2134	74.50	1892.3	25.0	11.3	84152	69
	90	2286	80.50	2044.7	26.0	11.8	88703	75
	96	2438	86.50	2197.1	27.0	12.2	84274	81
H-10386	24	610	21.00	533.0	18.5	8.4	580558	14
	30	762	21.00	533.0	19.8	9.0	580559	16
	36	914	26.50	673.1	21.0	9.5	580560	18
	42	1067	32.50	825.5	22.0	10.0	580561	24
	48	1219	38.50	977.9	23.3	10.5	580562	30
	54	1372	44.50	1130.3	24.3	11.0	580563	36
	60	1524	50.50	1282.7	25.5	11.6	580564	42
	66	1676	56.50	1435.1	26.5	12.0	580565	48
	72	1829	62.50	1587.5	27.8	12.6	580566	54
	78	1981	68.50	1739.9	29.0	13.2	580648	60
	84	2134	74.50	1892.3	30.0	13.6	580649	66
	90	2286	80.50	2044.7	31.0	14.1	580650	72
	96	2438	86.50	2197.1	32.0	14.5	580859	78

H-10316 and H-10336 Curb boxes

Curb box catalog number	Box length extended		Box length fully retracted		Weight	
	Inch	mm	Inch	mm	lbs.	kg.
H-10316	24	610	19.50	495.3	15.3	6.9
	30	762	21.00	533.0	16.0	7.3
	36	914	27.00	686.0	16.8	7.6
	42	1067	33.00	838.0	17.5	7.9
	48	1219	39.00	991.0	18.3	8.3
	54	1372	45.00	1143.0	19.0	8.6
	60	1524	51.00	1295.0	19.8	9.0
	66	1676	57.00	1448.0	20.3	9.2
	72	1829	63.00	1600.0	21.3	9.6
	78	1981	69.00	1753.0	22.0	10.0
	84	2134	75.00	1905.0	22.8	10.3
	90	2286	81.00	2057.0	23.5	10.7
	96	2438	87.00	2210.0	24.3	11.0
H-10336	24	610	21.25	539.8	18.0	8.2
	30	762	21.25	539.8	18.8	8.5
	36	914	27.00	686.0	19.5	8.8
	42	1067	33.00	838.0	20.3	9.2
	48	1219	39.00	991.0	21.0	9.5
	54	1372	45.00	1143.0	21.8	9.9
	60	1524	51.00	1295.0	22.5	10.2
	66	1676	57.00	1448.0	23.3	10.5
	72	1829	63.00	1600.0	24.0	10.9
	78	1981	69.00	1753.0	24.8	11.2
	84	2134	75.00	1905.0	25.5	11.6
	90	2286	81.00	2057.0	26.3	11.9
	96	2438	87.00	2210.0	27.0	12.2

Extra lids and plugs

Lids are cast iron with an integrally cast brass bushing which allows for easy removal of pentagon plug.



Plug Only



Lid with Plug

Curb Box Catalog number	Lid with plug part number	Plug only part number	
		Cast Iron	Brass
H-10316	89981	59478	63684
H-10336	89981	59478	63684
H-10385	89375	58039	63670
H-10386	89375	58039	63670

TO ORDER BOXES SPECIFY EXTENDED LENGTH AND CATALOG NUMBER



Improved extension type curb box with arch pattern base - for 1/2" through 2" curb valves

The arch extends around the curb valve and has a large foot surface to transmit loads into the ground beneath the curb valve, rather than to the curb valve itself. The box is cast iron and is furnished with a cast iron lid and brass pentagon plug. The upper part of the box is spring loaded and telescopes into the base to allow for grade adjustment within the range given in the dimensions charts. Stationary rods, shut-off rods and pentagon keys are optional and are ordered separately.

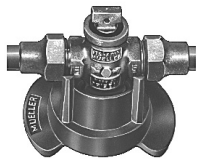

Foot piece
(valve not included)

Optional foot pieces

Optional foot pieces provide a firm base for the curb valve and helps to prevent the curb valve from moving when the valve is operated. This is especially important when a plastic service line is used.

Box Selection

Curb Valve & Size	Box		Optional Foot Piece
	Catalog Number	Inside Diameter	
300™ Ball			
3/4"	H-10385	1-1/4"	H-10396
	H-10316	2"	H-10391
1"	H-10385	1-1/4"	H-10397
	H-10316	2"	H-10401**
1-1/2"	H-10386	1-1/4"	H-10400
	H-10336	2"	–
2"	H-10336	2"	–
MARKII®			
3/4"	H-10385	1-1/4"	H-10396
	H-10316	2"	H-10391
1"	H-10385	1-1/4"	H-10397
	H-10316	2"	H-10401**
1-1/4"	H-10336	2"	–
1-1/2"	H-10386	1-1/4"	H-10400
	H-10336	2"	–
2"	H-10336	2"	–
ORISEALIII®			
3/4"	H-10385	1-1/4"	H-10396
	H-10316	2"	H-10391
1"	H-10385	1-1/4"	H-10397
	H-10316	2"	H-10401**
ORISEAL® (GreenKey)			
3/4"	H-10385	1-1/4"	H-10396
1"	H-10385	1-1/4"	H-10397
1-1/2"	H-10386	1-1/4"	H-10400
2"	H-10386	1-1/4"	H-10400

** Foot piece not useable with valves having IPS PE MUELLER 110® Compression connections.

Polyethylene PE Tubing and pipe used with MUELLER INSTA-TITE Connections

Nominal size of connection	Material	Tubing or pipe O.D. range - inches	Tubing or pipe wall thickness range - inches	Tubing or pipe I.D. range - inches
3/4" CTS	Polyethylene PE	0.871 - 0.879	0.097 - 0.107	0.657 - 0.685
1" CTS	Polyethylene PE	1.120 - 1.130	0.125 - 0.137	0.846 - 0.880
3/4" IPS	Polyethylene PE	1.045 - 1.110	0.118 - 0.138	0.809 - 0.834
1" IPS	Polyethylene PE	1.329 - 1.399	0.150 - 0.170	1.029 - 1.059

CTS polyethylene (PE) per ASTM D-2737 SDR-9
 IPS polyethylene (PE) per ASTM D-2239 PE SIDR-7

MUELLER INSTA-TITE Connection replacement parts

Size	Gripper ring part number†	O-Ring part number
3/4" CTS PE (red gripper)	506325	506324
1" CTS PE (red gripper)	506327	506326
3/4" IPS PE (white gripper)	505885	505883
1" IPS PE (white gripper)	505886	505884



Optional tools for use with MUELLER INSTA-TITE Connections

Pipe beveling tool

To assure proper installation, the end of the pipe or tubing must be properly beveled before it is inserted into the MUELLER INSTA-TITE Connection. MUELLER CO. offers a special beveling tool for both CTS PE tubing and IPS PE pipe.



PART NUMBER: **H-18015** for 3/4" and 1" CTS tubing
 PART NUMBER: **H-18017** for 3/4" and 1" IPS pipe

Pipe removal tool

Pipe or tubing may be removed from the MUELLER INSTA-TITE Connection using special removal tools. Use one tool for 3/4" size connection and two tools for 1" size.



PART NUMBER: **506336**

Rev. 9-09

Copper flare connection optional equipment

Copper flare nut

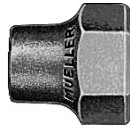

CATALOG NUMBER: **H-15430**

1/2"	3/4"	1"	1-1/4"	1-1/2"	2"
------	------	----	--------	--------	----

Solid copper disc



Used with regular copper flare nut to shut off line.

CATALOG NUMBER: **H-15535**

1/2"	5/8"	3/4"	1"	1-1/4"	1-1/2"	2"
------	------	------	----	--------	--------	----

Brass cap



Fits on copper flare spud to cap off line.

CATALOG NUMBER: **H-15540**

1/2"	3/4"	1"	1-1/4"	1-1/2"	2"
------	------	----	--------	--------	----

Flaring tool



Used to make 45° flare on type "K" copper tubing.

CATALOG NUMBER: **H-18000**

3/4"	1"
------	----

Drilled flaring tool



Used to make 45° flare on type "K" copper tubing without shutting off water-drilled to exhaust water at right angle to tubing.

CATALOG NUMBER: **H-18005**

3/4"	1"
------	----

Reamer

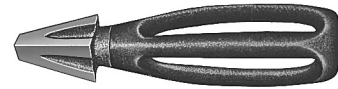

Used to ream the inside of type "K" copper tubing to remove burrs prior to flaring.

CATALOG NUMBER: **H-18010**

3/4"

Brass Hammer



Solid brass head with 10" wooden handle. Weight 2-3/4 lb.

CATALOG NUMBER: **H-18025**

Note: When using any striking tool, safety eye protection must be worn. Inspect hammer and tools for any damage after each use and repair or replace if mushrooming or chipping is evident.

PACK JOINT CONNECTION INFORMATION

Tubing, pipe and liners used with MUELLER® Pack Joint Connections

Nominal size of connection	Material*	Tubing or pipe O.D. range - inches	Tubing or pipe O.D. range - inches	Tubing or pipe I.D. range - inches	Liner part number
3/4" CTS	Type "K" copper	0.872 - 0.878	0.061 - 0.069	-	-
	Polyethylene	0.871 - 0.879	0.097 - 0.107	0.657 - 0.685	528704
1" CTS	Type "K" copper	1.121 - 1.129	0.061 - 0.069	-	-
	Polyethylene	1.120 - 1.130	0.125 - 0.137	0.846 - 0.880	528705
1-1/2" CTS	Type "K" copper	1.621 - 1.630	0.067 - 0.077	-	-
	Polyethylene	1.619 - 1.631	0.181 - 0.199	1.221 - 1.269	528706
2" CTS	Type "K" copper	2.120 - 2.130	0.076 - 0.090	-	-
	Polyethylene	2.119 - 2.131	0.236 - 0.260	1.599 - 1.659	528707
3/4" IPS	Polyethylene	1.045 - 1.110	0.118 - 0.138	0.809 - 0.834	505141
	3/4" Sch. 40 PVC	1.046 - 1.054	0.113 - 0.133	0.780 - 0.828	509759
	3/4" Sch. 80 PVC	1.046 - 1.054	0.154 - 0.174	0.698 - 0.746	509760
1" IPS	Polyethylene	1.329 - 1.399	0.150 - 0.170	1.029 - 1.059	505142
	1" Sch. 40 PVC	1.310 - 1.320	0.133 - 0.153	-	-
	1" Sch. 80 PVC	1.310 - 1.320	0.179 - 0.200	-	-
1-1/4" IPS	Polyethylene	1.754 - 1.832	0.197 - 0.221	1.360 - 1.390	312787
1-1/2" IPS	Polyethylene	2.05 - 2.141	0.230 - 0.258	1.590 - 1.625	529116
	1-1/2" Sch. 40 PVC	1.894 - 1.906	0.145 - 0.165	-	-
	1-1/2" Sch. 80 PVC	1.894 - 1.906	0.200 - 0.224	-	-
2" IPS	Polyethylene	2.637 - 2.742	0.295 - 0.330	2.047 - 2.082	529117
	2" Sch. 40 PVC	2.369 - 2.381	0.154 - 0.174	-	-
	2" Sch. 80 PVC	2.369 - 2.381	0.218 - 0.244	-	-

*Type "K" soft copper tubing per ASTM B88; CTS polyethylene (PE) per ASTM D-2737 - SDR-9; IPS polyethylene (PE) per ASTM D-2239 - PE SDR-7 ;IPS polyvinylchloride (PVC) per ASTM D1785



Liner

MUELLER Pack Joint Connection Kit

Size	Connection Kit
3/4" CTS	681921
1" CTS	681922
1-1/2" CTS	681923
2" CTS	681924
3/4" IPS PE	682377
1" IPS PE	682556
1-1/2" IPS PE	682557
2" IPS PE	682558
3/4" IPS PVC	682377
1" IPS PVC	682553
1-1/2" IPS PVC	682554
2" IPS PVC	682555



**Connection Kit
(includes Pack Joint,)**

Rev. 9-09 Shaded area indicates change

Tubing, pipe and liners used with MUELLER 110 Compression Connection

Nominal size of connection	Material*	Tubing or pipe O.D. range - inches	Tubing or pipe O.D. range - inches	Tubing or pipe I.D. range - inches	Liner part number
1/2" CTS	Type "K" copper	0.622 - 0.628	0.045 - 0.053	-	-
3/4" CTS	Type "K" copper	0.872 - 0.878	0.061 - 0.069	-	-
	Polyethylene	0.871 - 0.879	0.097 - 0.107	0.657 - 0.685	504281
1" CTS	Type "K" copper	1.121 - 1.129	0.061 - 0.069	-	-
	Polyethylene	1.120 - 1.130	0.125 - 0.137	0.846 - 0.880	504385
1-1/4" CTS	Type "K" copper	1.371 - 1.379	0.060 - 0.070	-	-
	Polyethylene	1.370 - 1.380	0.153 - 0.168	1.034 - 1.074	505142
1-1/2" CTS	Type "K" copper	1.621 - 1.630	0.067 - 0.077	-	-
	Polyethylene	1.619 - 1.631	0.181 - 0.199	1.221 - 1.269	506139
2" CTS	Type "K" copper	2.120 - 2.130	0.076 - 0.090	-	-
	Polyethylene	2.119 - 2.131	0.236 - 0.260	1.599 - 1.659	506141
3/4" IPS	Polyethylene	1.045 - 1.110	0.118 - 0.138	0.809 - 0.834	505141
	3/4" Sch. 40 PVC	1.046 - 1.054	0.113 - 0.133	0.780 - 0.828	509759
	3/4" Sch. 80 PVC	1.046 - 1.054	0.154 - 0.174	0.698 - 0.746	509760
1" IPS	Polyethylene	1.329 - 1.399	0.150 - 0.170	1.029 - 1.059	505142
	1" Sch. 40 PVC	1.310-1.320	0.133-0.153	-	-
	1" Sch. 80 PVC	1.310-1.320	0.179-0.200	-	-

*Type "K" soft copper tubing per ASTM B88; CTS polyethylene (PE) per ASTM D-2737 - SDR-9; IPS polyethylene (PE) per ASTM D-2239 - PE SIDR-7; IPS polyvinylchloride (PVC) per ASTM D1785



Liner

MUELLER 110 Compression Connection replacement parts

Size	Kit	Gasket part number†	Connection nut
1/2" CTS		681516	147542
3/4" CTS	682600	581949	507831
1" CTS	682601	581951	507835
1-1/2" CTS		581955	507847
2" CTS		581957	507851
3/4" IPS PE		89599	508826
1" IPS PE		89788	508827

†Gasket and gripper band assembly



Gasket



Nut

Adapter Nut for pre-1976 style Mueller 110 Compression Connection for CTS tubing

Kit includes one standard Gasket (same used with current style 110 connections) and a special Nut that adapts to the older style connection threads on the fittings. It is installed in the same way as the current style connection (Gasket conductor spring should be toward fitting body).

Size	Connection kit
3/4" CTS	682552
1" CTS	682551

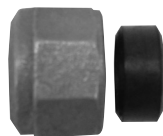



Brass straight lever handle
 For use on MUELLER®
 MARK II ORISEAL® Curb
 Valves and MUELLER
 ORISEAL III® Curb Valves.

H-10298

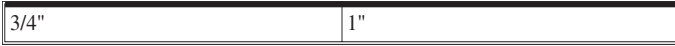

1" H-10298 can be use on 1-1/2" & 2" Ball Curb Valves



Brass angle lever handle
 For use on MUELLER®
 MARK II ORISEAL® Curb
 Valves and MUELLER
 ORISEAL III® Curb Valves.

H-14339

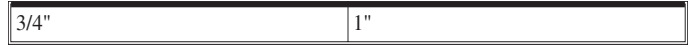

1" H-14339 can be use on 1-1/2" & 2" Ball Curb Valves



Brass straight lever handle
 For use on MUELLER® 300™
 Ball Curb Valves - one size fits
 both 3/4" and 1" valves. 4.25"
 overall handle length.

B-20298



Brass angle lever handle
 For use on MUELLER® 300™
 Ball Curb Valves - one size fits
 both 3/4" and 1" valves.

B-24339



Brass straight lever handle
 For use on MUELLER® 300™
 Ball Curb Valves - one size fits
 both 3/4" and 1" valves. 3.21"
 overall handle length for use in
 confined areas where longer
 handle will not work.

B-20298-99000



**"RECLAIMED WATER"
 straight lever handle**
 Provided with marking and
 purple sleeve color for posi-
 tive identification. For use on
 MUELLER® 300™ Ball Valves
 - one size fits both 3/4" and 1"
 valves. 3.21" overall handle
 length for use in confined areas.

B-20298-99001

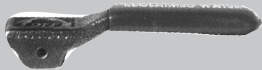

**"RECLAIMED WATER"
 straight lever handle**
 Provided with marking and
 purple sleeve color for posi-
 tive identification. For use on
 MUELLER® 300™ Ball Valves
 - one size fits both 1-1/2" and
 2" valves. 3.21" overall handle
 length for use in confined areas.

H-10298-99001

7.18



CURB VALVES MISCELLANEOUS

Rev. 9-09 Shaded area indicates change



Bronze gate valve solid wedge
F.I.P. thread - both ends
200 psig maximum working
pressure, cold water
non-shock service and wheel
handle

H-10914

3/4"	1"	1-1/4"	1-1/2"	2"	2-1/2"	3"
------	----	--------	--------	----	--------	----

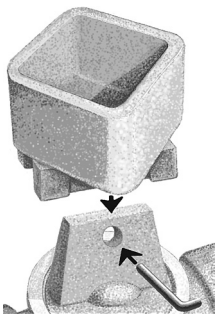

**2" Brass square wrench
nut adapter**
For use on MUELLER® 300™
Ball Valves - one size fits both
1-1/2" and 2" valves.

B-20299



Brass locking device
(padlock and stop not included)
For use on MUELLER®
MARK II ORISEAL® Curb
Valves - cannot be used on
valves with angle lever handles.

H-14338

3/4"	1"
------	----

INVERTED KEY AND SOLID TEE HEAD CURB VALVES



Inverted key curb stop MUELLER 110® Conductive Compression Connection for CTS O.D.* tubing-**both ends**
Quarter turn check

H-15207

1/2"	3/4"
------	------

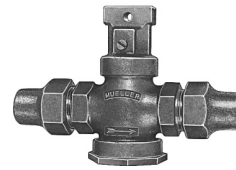

Inverted key curb stop
Copper flare nut - **both ends**
Quarter turn check

H-15200

3/4"	1"
------	----

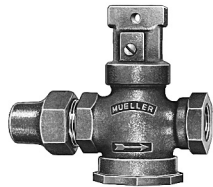

Inverted key curb stop
Inlet: Copper flare nut
Outlet: F.I.P. thread
Quarter turn check

H-15175

1/2"	3/4"	1"
------	------	----

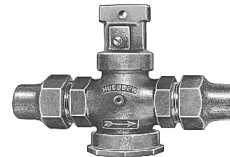

Inverted key curb stop
Copper flare nut - **both ends**
Quarter turn check and drain

H-15210

3/4"



Inverted key curb stop
F.I.P. thread - **both ends**
Quarter turn check

H-10201

1/2"	3/4"	1"
------	------	----

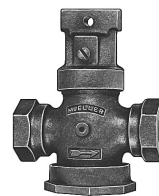

Inverted key curb stop
F.I.P. thread - **both ends**
Quarter turn check and drain

H-10202

3/4"	1"
------	----

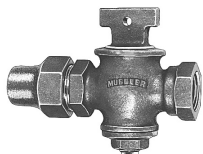

Solid tee head curb stop
Inlet: Copper flare nut
Outlet: F.I.P. thread
Checkless - 360° turn

H-15275

3/4"	1"
------	----

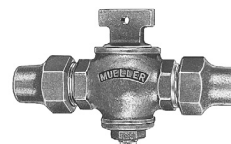

Solid tee head curb stop
Copper flare nut - **both ends**
Checkless - 360° turn

H-15300

3/4"	1"
------	----

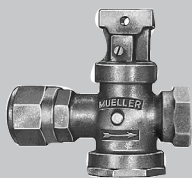

Inverted key curb stop
Inlet: MUELLER 110® Conductive Compression Connection for CTS O.D.* tubing-
Outlet: F.I.P. thread
Quarter turn check

H-12918

3/4"	1"
------	----

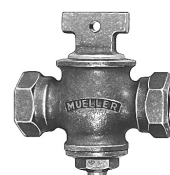

Solid tee head curb stop
F.I.P. thread - **both ends**
Checkless - 360° turn

H-10203

1/2"	3/4"
------	------

‡Requires minimum ordering quantity. Contact MUELLER Customer Service Center for minimum ordering requirements and availability.

NOTE: Sizes shown above represent nominal size of valve.

MUELLER Curb Valves are manufactured and tested in accordance with ANSI/AWWA C800.

7.16



MUELLER® ORISEAL® CURB VALVES (ORIGINAL STYLE - "GREEN KEY")

Rev. 9-09 Shaded area indicates change



MUELLER ORISEAL
Curb Valve
Copper flare nut - **both ends**
Quarter turn check

H-15201

3/4"	1"	1-1/2"	2"
------	----	--------	----



MUELLER ORISEAL
Curb Valve
Copper flare nut - **both ends**
Quarter turn check and
Minneapolis top thread

H-15151

3/4"	1"		
------	----	--	--



MUELLER ORISEAL
Curb Valve
Inlet: Copper flare nut
Outlet: F.I.P. thread
Quarter turn check

H-15176

3/4"	1"	2"	
------	----	----	--



MUELLER ORISEAL
Curb Valve
F.I.P. thread - **both ends**
Quarter turn check

H-10291

3/4"	1"	1-1/2"	2"
------	----	--------	----



MUELLER ORISEAL
Curb Valve
F.I.P. thread - **both ends**
Quarter turn check
Minneapolis top thread

H-10297

3/4" ‡			
--------	--	--	--

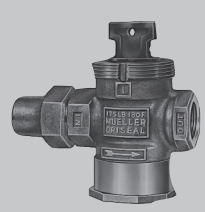

MUELLER ORISEAL
Curb Valve
Inlet: Copper flare nut
Outlet: F.I.P. thread
Quarter turn check
Minneapolis top thread

H-15126

3/4"			
------	--	--	--

‡Requires minimum ordering quantity. Contact MUELLER Customer Service Center for minimum ordering requirements and availability.

NOTE: Sizes shown above represent nominal size of valve.

MUELLER Curb Valves are manufactured and tested in accordance with ANSI/AWWA C800.



H-1504-1

MUELLER ORISEAL III Curb Valve MUELLER 110® Conductive Compression Connection for CTS O.D.* tubing-**both ends**

Checkless - 360° turn

3/4"	1"
------	----



P-1504-1

MUELLER ORISEAL III Curb Valve MUELLER Pack Joint Connection for CTS O.D.* tubing-**both ends** Checkless - 360° turn

3/4"	1"
------	----



H-1504-2

MUELLER ORISEAL III Curb Valve MUELLER 110 Conductive Compression Connection for CTS O.D.* tubing-**both ends**

Quarter turn check

3/4"	1"
------	----



P-1504-2

MUELLER ORISEAL III Curb Valve MUELLER Pack Joint Connection for CTS O.D.* tubing-**both ends** Quarter turn check

3/4"	1"
------	----



H-1503-1

MUELLER ORISEAL III Curb Valve **Inlet:** MUELLER 110 Conductive Compression Connection for CTS O.D.* tubing

Outlet: F.I.P. thread Checkless-360° turn

3/4"	1"
------	----



P-1503-1

MUELLER ORISEAL III Curb Valve **Inlet:** MUELLER Pack Joint Compression Connection for CTS O.D.* tubing

Outlet: F.I.P. thread Checkless-360° turn

3/4"	1"
------	----



H-1503-2

MUELLER ORISEAL III Curb Valve **Inlet:** MUELLER 110 Conductive Compression Connection for CTS O.D.* tubing

Outlet: F.I.P. thread Quarter turn check

3/4"	1"
------	----

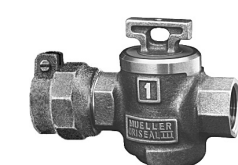

P-1503-2

MUELLER ORISEAL III Curb Valve **Inlet:** MUELLER Pack Joint Compression Connection for CTS O.D.* tubing

Outlet: F.I.P. thread Quarter turn check

3/4"	1"
------	----



H-1502-1

MUELLER ORISEAL III Curb Valve Copper flare nut - **both ends**

Checkless-360° turn

3/4"	1"
------	----



H-1500-1

MUELLER ORISEAL III Curb Valve F.I.P. thread-**both ends** Checkless - 360° turn

3/4"	1"
------	----



H-1502-2

MUELLER ORISEAL III Curb Valve Copper flare nut - **both ends**

Quarter turn check

3/4"	1"
------	----



H-1500-2

MUELLER ORISEAL III Curb Valve F.I.P. thread - **both ends**

Quarter turn check

3/4"	1"
------	----

NOTE: Sizes shown above represent nominal size of valve. Unless otherwise noted, checks on MUELLER ORISEAL III valves allow 90 degree turn.

MUELLER Curb Valves are manufactured and tested in accordance with ANSI/AWWA C800.

MUELLER® MARK II ORISEAL® CURB VALVES WITH F.I.P. CONNECTION

Rev. 9-09



MUELLER MARK II ORISEAL Curb Valve F.I.P. thread - **both ends**
Quarter turn check

H-10283

3/4"	1"	1-1/4"	1-1/2"	2"
------	----	--------	--------	----

NOTE: 3/4" and 1" sizes are bi-directional and can be installed with flow from either direction. Sizes larger than 1" are one way flow and must be installed with flow as indicated by arrow and in/out lettering cast on valve body.



MUELLER MARK II ORISEAL Curb Valve F.I.P. thread - **both ends**
Quarter turn check and drain

H-10284

3/4"	1"	1-1/4"	1-1/2"	2"
------	----	--------	--------	----



ORISEAL Curb Valve F.I.P. thread - **both ends**
Quarter turn check and Minneapolis top thread

H-10287

3/4"	1"	1-1/4"	1-1/2"	2"
------	----	--------	--------	----

NOTE: 3/4" and 1" sizes are bi-directional and can be installed with flow from either direction. Sizes larger than 1" are one way flow and must be installed with flow as indicated by arrow and in/out lettering cast on valve body.



MUELLER MARK II ORISEAL Curb Valve F.I.P. thread - **both ends**
Quarter turn check, drain and Minneapolis top thread

H-10288

3/4"	1"	1-1/4"	1-1/2"	2"
------	----	--------	--------	----

† Requires minimum ordering quantity. Contact MUELLER® Customer Service Center for minimum ordering requirements and availability.

NOTE: Sizes shown above represent nominal size of valve.

MUELLER Curb Valves are manufactured and tested in accordance with ANSI/AWWA C800.

MUELLER® MARK II ORISEAL® CURB VALVES WITH COPPER FLARE CONNECTION

Mueller Co.

7.13

Rev. 9-09



MUELLER MARK II
ORISEAL Curb Valve
Copper flare nut - **both ends**
Quarter turn check

H-15204

3/4"	1"	1-1/4"	1-1/2"	2"
------	----	--------	--------	----

NOTE: 3/4" and 1" sizes are bi-directional and can be installed with flow from either direction. Sizes larger than 1" are one way flow and must be installed with flow as indicated by arrow and in/out lettering cast on valve body.



MUELLER MARK II
ORISEAL Curb Valve
Copper flare nut - **both ends**
Quarter turn check and drain

H-15214

3/4"	1"	1-1/4"	1-1/2"	2"
------	----	--------	--------	----



MUELLER MARK II
ORISEAL Curb Valve Copper
flare nut - **both ends**
Quarter turn check and
Minneapolis thread top

H-15154

3/4"	1"	1-1/4"	1-1/2"	2"
------	----	--------	--------	----

NOTE: 3/4" and 1" sizes are bi-directional and can be installed with flow from either direction. Sizes larger than 1" are one way flow and must be installed with flow as indicated by arrow and in/out lettering cast on valve body.

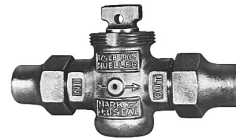

MUELLER MARK II
ORISEAL Curb Valve
Copper flare nut - **both ends**
Quarter turn check,
Minneapolis thread top and drain

H-15164

3/4"	1"	1-1/4"	1-1/2"	2"
------	----	--------	--------	----

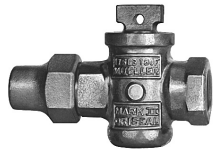

MUELLER MARK II
ORISEAL Curb Valve
Inlet: Copper flare nut
Outlet: F.I.P. thread
Quarter turn check

H-15174

3/4"	1"	1-1/4"	1-1/2"	2"
------	----	--------	--------	----

NOTE: 3/4" and 1" sizes are bi-directional and can be installed with flow from either direction. Sizes larger than 1" are one way flow and must be installed with flow as indicated by arrow and in/out lettering cast on valve body.

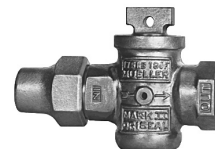

MUELLER MARK II
ORISEAL Curb Valve
Inlet: Copper flare nut
Outlet: F.I.P. thread
Quarter turn check with drain

H-15184

3/4"	1"	1-1/2" ‡	2" ‡
------	----	----------	------



MUELLER MARK II
ORISEAL Curb Valve
Inlet: Copper flare nut
Outlet: F.I.P. thread
Quarter turn check and
Minneapolis top thread

H-15124

3/4"	1" ‡
------	------

NOTE: Sizes shown above represent nominal size of valve.
‡Requires minimum ordering quantity. Contact MUELLER Customer Service Center for minimum ordering requirements and availability.
MUELLER Curb Valves are manufactured and tested in accordance with ANSI/AWWA C800.

7.12



MUELLER® MARK II ORISEAL® CURB VALVES WITH MUELLER INSTA-TITE® CONNECTIONS

Rev. 9-09



MUELLER MARK II ORISEAL Curb Valve
MUELLER INSTA-TITE
 Connection for CTS PE*
 tubing - **both ends**
 Quarter turn check

H-15215

3/4" ‡	1" ‡
--------	------

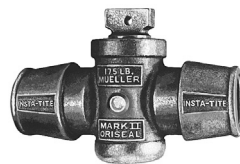

MUELLER MARK II ORISEAL Curb Valve
MUELLER INSTA-TITE
 Connection for IPS PE*
 pipe - **both ends**
 Quarter turn check

H-15213

3/4"	1"
------	----

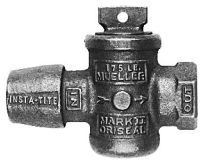

MUELLER MARK II ORISEAL Curb Valve
Inlet: MUELLER INSTA-TITE
 Connection for CTS PE* tubing
Outlet: F.I.P. thread
 Quarter turn check

H-15192

3/4"	1"
------	----

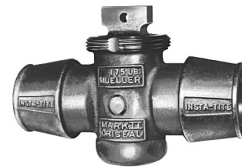

MUELLER MARK II ORISEAL Curb Valve
MUELLER INSTA-TITE
 Connection for IPS PE*
 pipe - **both ends**
 Quarter turn check and
 Minneapolis top thread

H-15156

3/4"	1"
------	----

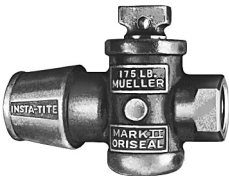

MUELLER MARK II ORISEAL Curb Valve
Inlet: MUELLER INSTA-TITE
 Connection for IPS PE* pipe
Outlet: F.I.P. thread
 Quarter turn check

H-15191

3/4"	1"
------	----

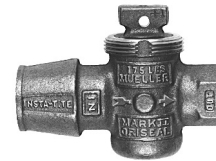

MUELLER MARK II ORISEAL Curb Valve
Inlet: MUELLER INSTA-TITE
 Connection for IPS PE* pipe
Outlet: F.I.P. thread
 Quarter turn check and
 Minneapolis top thread

H-15128

3/4" ‡	
--------	--



MUELLER MARK II ORISEAL Curb Valve
MUELLER INSTA-TITE
 Connection for IPS PE*
 pipe with drain - **both ends**
 Quarter turn check and
 Minneapolis top thread

H-15158

3/4"	1"
------	----

NOTE: Sizes shown above represent nominal size of valve.

* See page 7.22 for tubing and pipe that can be used with this connection.

‡ Requires minimum ordering quantity. Contact MUELLER Customer Service Center for minimum ordering requirements and availability.

MUELLER Curb Valves are manufactured and tested in accordance with ANSI/AWWA C800.

MUELLER® MARK II ORISEAL® CURB VALVES WITH PACK JOINT CONNECTIONS



7.11

Rev. 9-09

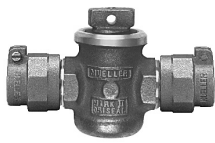

MUELLER MARK II ORISEAL Curb Valve. MUELLER Pack Joint Connection for CTS O.D.* tubing-**both ends**
Quarter turn check

P-15209

3/4"	1"	1-1/2"	2"
------	----	--------	----



MUELLER MARK II ORISEAL Curb Valve. MUELLER Pack Joint Connection for CTS O.D.* tubing-**both ends**
Quarter turn check with drain

P-15219

3/4"	1"
------	----



MUELLER MARK II ORISEAL Curb Valve. MUELLER Pack Joint Connection for CTS O.D.* tubing-**both ends**
Quarter turn check and Minneapolis top thread

P-15155

3/4"	1"
------	----



MUELLER MARK II ORISEAL Curb Valve
Inlet: MUELLER Pack Joint Connection for CTS O.D. tubing
Outlet: F.I.P. thread
Quarter turn check

P-15172

3/4"	1"	1-1/2"	2"
------	----	--------	----



MUELLER MARK II ORISEAL Curb Valve. MUELLER Pack Joint Connection for IPS PE* tubing-**both ends**
Quarter turn check

E-15211

**Note: 3/4" size only may also be used on PVC

3/4"***

*See page 7.20 for tubing and pipe that can be used with this connection.

**Note: 3/4" size only may also be used on PVC

NOTE: Sizes shown above represent nominal size of valve. Unless otherwise noted, checks on MUELLER MARK II ORISEAL valves allow 90 degree turn.

MUELLER Curb Valves are manufactured and tested in accordance with ANSI/AWWA C800.

MUELLER® MARK II ORISEAL® CURB VALVES WITH MUELLER 110®

Rev. 9-09 Shaded area indicates change



MUELLER MARK II ORISEAL
Curb Valve. MUELLER 110
Conductive Compression
Connection for CTS O.D.*
tubing-**both ends** Quarter turn check

H-15209

3/4"	1"	1-1/2"	2"
------	----	--------	----



MUELLER MARK II ORISEAL
Curb Valve MUELLER 110
Conductive Compression
Connection for CTS O.D.*
tubing-**both ends**
Quarter turn check with drain

H-15219

3/4"	1"	1-1/2"	2"
------	----	--------	----



MUELLER MARK II ORISEAL
Curb Valve. MUELLER 110
Compression Connection for
IPS PE* pipe - **both ends**
Quarter turn check and
Minneapolis top thread

H-15159

3/4"	1"
------	----



MUELLER MARK II ORISEAL
Curb Valve
Inlet: MUELLER 110 Compression
Connection for IPS PE* pipe
Outlet: F.I.P. thread
Quarter turn check

H-15171

3/4"	1"
------	----

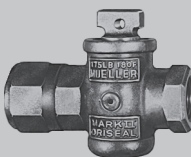

MUELLER MARK II ORISEAL
Curb Valve
Inlet: MUELLER 110 Conductive
Compression Connection for CTS
O.D. tubing
Outlet: F.I.P. thread
Quarter turn check
Minneapolis top thread

H-15127

3/4"	1"
------	----



MUELLER MARK II ORISEAL
Curb Valve. MUELLER 110
Compression Connection for
IPS PE* pipe- **both ends**
Quarter turn check

H-15211

3/4"	1"
------	----



MUELLER MARK II ORISEAL
Curb Valve. MUELLER 110
Conductive Compression
Connection for CTS O.D.*
tubing-**both ends**
Quarter turn check and
Minneapolis top thread

H-15155

3/4"	1"
------	----

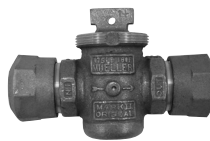

MUELLER MARK II ORISEAL
Curb Valve. MUELLER 110
Compression Connection for
CTS O.D.* pipe - **both ends**
Quarter turn check with drain and
Minneapolis top thread

H-15165

3/4"	1"
------	----



MUELLER MARK II ORISEAL
Curb Valve
Inlet: MUELLER 110
Conductive Compression
Connection for CTS O.D. tubing
Outlet: F.I.P. thread
Quarter turn check

H-15172

3/4"	1"	1-1/2"	2"
------	----	--------	----



MUELLER MARK II ORISEAL
Curb Valve
Inlet: MUELLER 110
Conductive Compression
Connection for CTS O.D. tubing
Outlet: F.I.P. thread
Quarter turn check and drain

H-15182

3/4"	1"
------	----

*See page 7.19 for tubing and pipe that can be used with this connection.

NOTE: Sizes shown above represent nominal size of valve. Unless otherwise noted, checks on MUELLER MARK II ORISEAL valves allow 90 degree turn.
MUELLER Curb Valves are manufactured and tested in accordance with ANSI/AWWA C800.

MUELLER® 300™ BALL CURB VALVES WITH COPPER FLARE, F.I.P. & M.I.P. CONNECTION



7.9

Shaded area indicates change Rev. 9-09

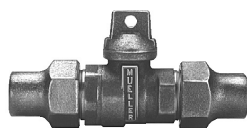

B-25204

MUELLER 300 Ball Curb Valve
Copper flare nut - **both ends**.
Quarter turn check.
This valve may be ordered with
checkless 360° turn option by
adding -3 to end of catalog
number (B-25204-3).

3/4" R	3/4"	1" R	1"	1-1/2"	2"
--------	------	------	----	--------	----



B-25154

MUELLER 300 Ball Curb Valve
Copper flare nut - **both ends**
Quarter turn check and
Minneapolis thread top.
This valve may be ordered with
checkless 360° turn option by
adding -3 to end of catalog
number (B-25154-3).

3/4"	1"	1-1/2"	2"
------	----	--------	----



B-25174

MUELLER 300 Ball Curb Valve
Inlet: Copper flare nut
Outlet: F.I.P. thread
Quarter turn check.
This valve may be ordered with
checkless 360° turn option by
adding -3 to end of catalog num-
ber (B-25174-3).

3/4" R	3/4"	3/4" x 1"	1" R	1"
1" x 3/4 R"	1" x 3/4"	1-1/2"	2"	



B-25124

MUELLER 300 Ball Curb Valve
Inlet: Copper flare nut
Outlet: F.I.P. thread
Quarter turn check and Minne-
apolis thread top.
This valve may be ordered with
checkless 360° turn option by
adding -3 to end of catalog num-
ber (B- 25174-3).

3/4"	1"	1-1/2"	2"
------	----	--------	----

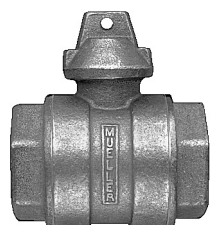

B-20283

MUELLER 300 Ball Curb Valve
F.I.P. thread - **both ends**
Quarter turn check.
This valve may be ordered
with 360° turn option by
adding -3 to end of catalog num-
ber (B-20283-3)

3/4" R	3/4"	1" R	1"	1-1/2"	2"
--------	------	------	----	--------	----



B-20287

MUELLER 300 Ball Curb Valve
F.I.P. thread - **both ends**.
Quarter turn check -
Minneapolis top thread.
This valve may be ordered
with 360° turn option by
adding -3 to end of catalog num-
ber (B-20287-3)

3/4"	1"	1-1/2"	2"
------	----	--------	----

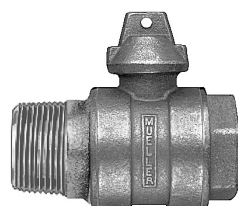

B-20285

MUELLER 300 Ball Curb Valve
Inlet: M.I.P thread
Outlet: F.I.P. thread
Quarter turn check.
This valve may be ordered
with 360° turn option by
adding -3 to end of catalog num-
ber (B- 20285-3)

3/4" R	3/4"	1"	1-1/2"	2"
--------	------	----	--------	----

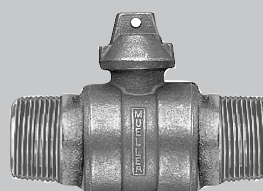

B-20276

MUELLER 300 Ball Curb Valve
Inlet: M.I.P thread
Outlet: M.I.P. thread
Quarter turn check.
This valve may be ordered
with 360° turn option by
adding -3 to end of catalog
number (B-20276-3)

3/4"	1"	1-1/2"	2"
------	----	--------	----

NOTE: Sizes shown above represent nominal size of valve. When two sizes are given, the first is size of inlet and the second is size of outlet.

"R" means Reduced port. Ball waterway is one nominal size smaller than inlet/outlet.

MUELLER Curb Valves are manufactured and tested in accordance with ANSI/AWWA C800.

7.8



MUELLER® 300™ BALL CURB VALVES WITH PACK JOINT CONNECTION

Rev. 9-09 Shaded area indicates change



V-25109

MUELLER 300 Ball Curb Valve
MUELLER Pack Joint Connection for
IPS* PVC tubing- **both ends**
Quarter turn check and Minneapolis top
thread - this valve may be ordered with
360° turn option by adding -3 to end of
(V-25109-3)

1-1/2"

2"

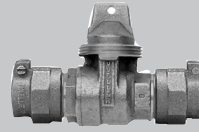

E-25142

MUELLER 300 Ball Curb Valve
MUELLER Pack Joint Connection for
IPS* PE tubing- **both ends**
Quarter turn check and Minneapolis top
thread - this valve may be ordered with
360° turn option by adding -3 to end of
(E-25142-3)

1-1/2"

2"

MUELLER® 300™ BALL CURB VALVES WITH PACK JOINT CONNECTION

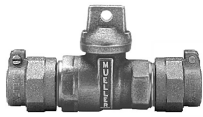

P-25209

MUELLER 300 Ball Curb Valve
 MUELLER Pack Joint Connection for
 CTS O.D.* tubing - **both ends.**
 Quarter turn check - this valve may be
 ordered with 360° turn option by adding
 -3 to end of catalog number
 (P-25209-3)

3/4" R	3/4"	1" R	1"	1-1/2"	2"
--------	------	------	----	--------	----



P-25122

MUELLER 300 Ball Curb Valve
Inlet: MUELLER Pack Joint
 Connection for CTS O.D.* tubing
Outlet: M.I.P. thread
 Quarter turn check-this valve may be
 ordered with 360° turn option by adding -3
 to end of catalog number (P-25122-3)

3/4" R	3/4"	1" R	1"	1-1/2"	2"
--------	------	------	----	--------	----

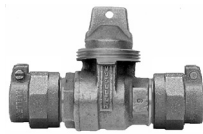

P-25155

MUELLER 300 Ball Curb Valve
 MUELLER Pack Joint Connection for
 CTS O.D.* tubing- **both ends**
 Quarter turn check and Minneapolis top
 thread - this valve may be ordered with
 360° turn option by adding -3 to end of
 (P-25155-3)

3/4"	1"	1-1/2"	2"
------	----	--------	----

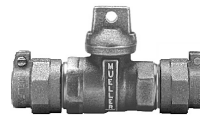

V-25226

MUELLER 300 Ball Curb Valve
 MUELLER Pack Joint Connection for
 IPS PVC* - **both ends.**
 Quarter turn check - this valve may be
 ordered with 360° turn option by adding
 -3 to end of catalog number (V-25226-3)

1"***	1-1/2"	2"
-------	--------	----

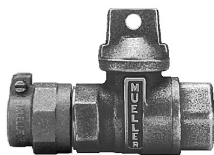

P-25172

MUELLER 300 Ball Curb Valve
Inlet: MUELLER Pack Joint
 Connection for CTS O.D.* tubing
Outlet: F.I.P. thread
 Quarter turn check-this valve may be
 ordered with 360° turn option by adding -3 to
 end of catalog number
 (P-25172-3)

3/4" R	3/4"	1" R	1"	1-1/2"	2"
--------	------	------	----	--------	----

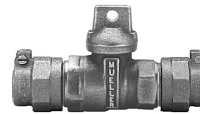

E-25211

MUELLER 300 Ball Curb Valve
 MUELLER Pack Joint Connection for
 IPS PE* - **both ends.**
 Quarter turn check - this valve may be
 ordered with 360° turn option by
 adding -3 to end of catalog number
 (E-25211-3)

3/4"	1-1/2"	2"
------	--------	----



V-25100

MUELLER 300 Ball Curb Valve
Inlet: MUELLER Pack Joint
 Connection for IPS PVC tubing
Outlet: F.I.P. thread
 Quarter turn check-this valve may be
 ordered with 360° turn option by adding -3 to
 end of catalog number
 (V-25100-3)

1"	1-1/2"	2"
----	--------	----



E-25171

MUELLER 300 Curb Valve
Inlet: MUELLER Pack Joint
 Compression Connection for IPS
 PE* pipe
Outlet: F.I.P. thread
 Quarter turn check - this valve may be
 ordered with 360° turn option by adding
 -3 to end of catalog number (E-25171-3)
 **Note: 3/4" size only may also be used on PVC

3/4"	1"	1-1/2"	2"
------	----	--------	----



V-25101

MUELLER 300 Ball Curb Valve
Inlet: MUELLER Pack Joint
 Connection for PVC pipe
Outlet: M.I.P. thread
 Quarter turn check-this valve may be ordered
 with 360° turn option by adding -3 to end of
 catalog number (V-25101-3)

1-1/2"	2"
--------	----

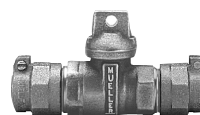

V-25226

MUELLER 300 Ball Curb Valve
Inlet: MUELLER Pack Joint
 Connection for PVC pipe - **both ends.**
 2 pc. construction assembled wrench tight.

1"***	1-1/2"	2"
-------	--------	----

*See page 7.19 for tubing and pipe that can be used with this connection.

**2-piece construction assembled wrench tight.

NOTE: Sizes shown above represent nominal size of valve.

"R" means Reduced port. Ball waterway is one nominal size smaller than inlet/outlet.

MUELLER Curb Valves are manufactured and tested in accordance with ANSI/AWWA C800.

7.6



MUELLER® 300™ BALL CURB VALVES WITH MUELLER 110® CONNECTION

Rev. 9-09 Shaded area indicates change



B-25132

MUELLER 300 Ball Curb Valve

Inlet: MUELLER 110 Conductive Compression Connection for CTS O.D.* tubing

Outlet: Copper Flare. Quarter turn check
- this valve may be ordered with 360° turn option by adding -3 to end of catalog number (B-25132-3)

3/4"

RECLAIMED WATER STYLE:

All ball curb valves are available marked for "reclaimed water" by adding "-20" to the catalog number. Example: B-25132-20.

*See page 7.18 for tubing and pipe that can be used with this connection.

NOTE: Sizes shown above represent nominal size of valve.

"R" means Reduced port. Ball waterway is one nominal size smaller than inlet/outlet.

MUELLER Curb Valves are manufactured and tested in accordance with ANSI/AWWA C800.

MUELLER® 300™ BALL CURB VALVES WITH MUELLER 110® CONNECTION

Mueller Co.

7.5

Shaded area indicates change Rev. 9-09



B-25209

MUELLER 300 Ball Curb Valve
MUELLER 110 Conductive
Compression Connection for CTS O.D.*
tubing - **both ends**. Quarter turn check - this
valve may be ordered with 360° turn option by
adding -3 to end of catalog number (B-25209-3)

3/4" R	3/4"	1" R	1"	1-1/2"	1-1/2"x2"
2"					



B-25122

MUELLER 300 Ball Curb Valve
Inlet: MUELLER 110 Conductive
Compression Connection for CTS
O.D.* tubing
Outlet: M.I.P. thread. Quarter turn
check - this valve may be ordered with 360°
turn option by adding -3 to end of catalog
number (B-25122-3)

3/4"R	3/4"	3/4"x1"	1"R	1"	1-1/2"	2"
-------	------	---------	-----	----	--------	----



B-25155

MUELLER 300 Ball Curb Valve
MUELLER 110 Conductive Com-
pression Connection for CTS O.D.*
tubing - **both ends**. Quarter turn check
and Minneapolis top thread - this valve may be
ordered with 360° turn option by adding -3 to
end of catalog number (B-25155-3)

3/4"	1"	1-1/2"	2"
------	----	--------	----



B-25171

MUELLER 300 Curb Valve
Inlet: MUELLER 110 Compression
Connection for IPS PE* pipe
Outlet: F.I.P. thread
Quarter turn check - this valve may be ordered with
360° turn option by adding -3 to end of catalog
number (B-25171-3)

3/4"	1"
------	----

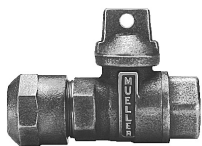

B-25172

MUELLER 300 Ball Curb Valve
Inlet: MUELLER 110 Conductive
Compression Connection for CTS
O.D.* tubing
Outlet: F.I.P. thread. Quarter turn check
this valve may be ordered with 360° turn option
by adding -3 to end of catalog number (B-
25172-3)

3/4"R	3/4"	3/4"x1"	1"R	1"	1-1/2"	2"
-------	------	---------	-----	----	--------	----



B-25152

MUELLER 300 Ball Curb Valve
Inlet: MUELLER 110 Conductive
Compression Connection for CTS
O.D.* tubing
Outlet: MUELLER 110 Compression
Connection for IPS PE* pipe
Minneapolis top thread - this valve may be or-
dered with 360° turn option by adding -3 to end
of catalog number (B-25152-3)

3/4"	1"
------	----



B-25210

MUELLER 300 Ball Curb Valve
Inlet: MUELLER 110 Conductive
Compression Connection for CTS O.D.*
tubing
Outlet: MUELLER 110 Compression
Connection for IPS PE* pipe
Quarter turn check - this valve may be ordered
with 360° turn option by adding -3 to end of
catalog number (B-25210-3)

3/4"	1"
------	----

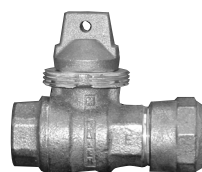

B-25163

MUELLER 300 Ball Curb Valve
Inlet: MUELLER 110 Conductive
Compression Connection for CTS
O.D.* tubing
Outlet: F.I.P. thread
Minneapolis top thread - this valve may be
ordered with 360° turn option by adding -3
to end of catalog number (B-25163-3)

3/4"	1"	1-1/2"	2"
------	----	--------	----



B-25211

MUELLER 300 Ball Curb Valve
MUELLER 110 Conductive Compres-
sion Connection for IPS PE* pipe -
both ends.
Minneapolis top thread - this valve may be or-
dered with 360° turn option by adding -3 to end
of catalog number (B-25211-3)

3/4"	1"
------	----



B-25219

MUELLER 300 Ball Curb Valve
MUELLER 110 Conductive Compres-
sion Connection for CTS O.D.* tubing
with drain - **both ends**.
Minneapolis top thread - this valve may be or-
dered with 360° turn option by adding -3 to end
of catalog number (B-25219-3)

3/4"

*See page 7.18 for tubing and pipe that can be used with this connection.

NOTE: Sizes shown above represent nominal size of valve.

"R" means Reduced port. Ball waterway is one nominal size smaller than inlet/outlet.

MUELLER Curb Valves are manufactured and tested in accordance with ANSI/AWWA C800.

MUELLER® Inverted Key Curb Valve

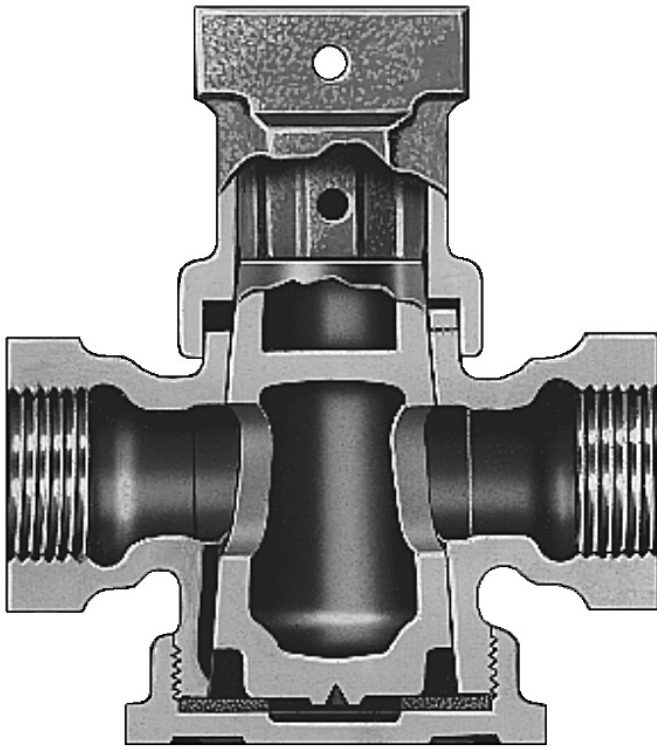

- ❑ Strong operating head to key attachment.
- ❑ Heavy brass components constructed of 85-5-5-5 ASTM B62 brass for strength and durability.
- ❑ Manufactured and tested in accordance with ANSI/AWWA C800 standard.
- ❑ Strong checks provide positive quarter turn operation.
- ❑ End connections include copper flare connection, MUELLER 110® Compression Connection, Pack Joint Connection and F.I.P. thread.
- ❑ Elongated round way port.
- ❑ 100 psig (690 kPa) maximum working pressure (through 1" size).

As the name implies, the large diameter of the Inverted key is on the bottom. The key is held in place by a bronze base cap. Water pressure from the inlet side of the body exerts an upward force on the bottom of the key, providing additional seating action. The stop is operated by tapping on the combined cap and tee head to unseat the key; the water pressure will reseat the key.

MUELLER Solid Tee Head Curb



- ❑ Key nut is designed so overtightening will strip threads instead of breaking stem.
- ❑ Heavy brass components constructed of 85-5-5-5 ASTM B62 brass for strength and durability.
- ❑ Manufactured and tested in accordance with ANSI/AWWA C800 standard.
- ❑ 100 psig (690 kPa) maximum working pressure through 1" size - (larger valves rated 80 psig, 552 kPa, maximum working pressure).

MUELLER ORISEAL III Curb Valve

- ❑ MANUFACTURED AND TESTED - to ANSI/AWWA C800 standard.
- ❑ HEAVY BRASS COMPONENTS constructed of 85-5-5-5 ASTM B62 brass for strength and durability.
- ❑ END CONNECTIONS include copper flare, MUELLER 110® Compression Connection, MUELLER INSTA-TITE Connection, and F.I.P. thread.
- ❑ INTEGRAL TEE HEAD AND PLUG for solid one-piece strength.
- ❑ LOW FRICTION THRUST WASHER reduces friction for easy turning.
- ❑ 175 PSIG maximum working pressure.
- ❑ TOP O-RING provides pressure sealing to outside.
- ❑ PORT O-RING provides effective sealing regardless of flow direction.
- ❑ FULL ROUND PORT OPENING for maximum flow and minimum pressure loss.
- ❑ HIGH STRENGTH INTEGRAL CHECKS assure positive quarter turn operation. Checkless 360° turn design also available.
- ❑ CLOSED BOTTOM minimizes exposed moving parts.



MUELLER ORISEAL Curb Valve

- ❑ HEAVY BRASS COMPONENTS constructed of 85-5-5-5 ASTM B62 brass for strength and durability.
- ❑ MANUFACTURED AND TESTED - to ANSI/AWWA C800 standard.
- ❑ END CONNECTIONS include copper flare and F.I.P. thread.
- ❑ HIGH STRENGTH INTEGRAL CHECKS assure positive quarter turn operation.
- ❑ INTEGRAL TEE HEAD AND PLUG - for solid one-piece strength.
- ❑ FLUOROCARBON COATED PLUG - assures easy turning.
- ❑ TOP AND BOTTOM O-RINGS - for positive pressure sealing, easy turning.
- ❑ 175 PSIG - maximum working pressure.
- ❑ PORT O-RING assures positive shut-off and easy turning.
- ❑ FULL OPENING ROUND PORT- for maximum flow and minimum pressure loss.

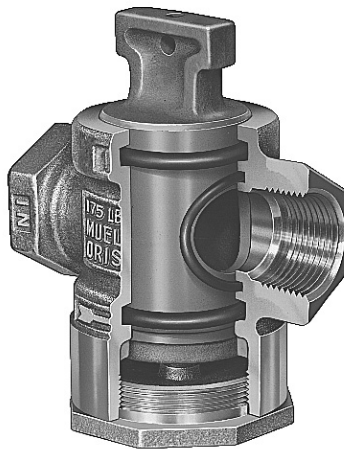

MUELLER® MARK II ORISEAL® CURB VALVES

The MUELLER® MARK II ORISEAL® Curb Valve has a sturdy one-piece, closed-bottom body that differs from other designs by reducing the number of potential leakage points. The closed bottom design minimizes exposed moving parts. The large tee head and plug are integrally cast as one strong piece to resist twisting and breaking. In addition, the O-ring

sealed design allows the plug to turn easily in the body, with a minimum of torque. The top and port O-rings are fully supported in machined grooves to provide positive sealing. All of these features combine in the MUELLER MARK II ORISEAL Curb Valve to provide reliable performance and long-term reliability.

MUELLER MARK II ORISEAL Curb Valve

- ❑ TOP SEALING O-RING - seals top of valve.
- ❑ FREE TURNING PLUG - eliminates metal-to-metal seating for easy turning.
- ❑ ENGINEERED ENTRY ANGLE provides smooth transition to flow passage with minimum flow loss.
- ❑ PORT SEALING O-RING - assures positive shut-off and easy turning.

- ❑ LARGE TEE HEAD is an integral part of the plug. The tee head also indicates if the valve is opened or closed.

- ❑ LOW FRICTION THRUST WASHER reduces friction between plug and snap ring for easy turning.

- ❑ PROTECTIVE TOP - has diameter larger than body and tee head to prevent a curb box from interfering with the tee head operation.

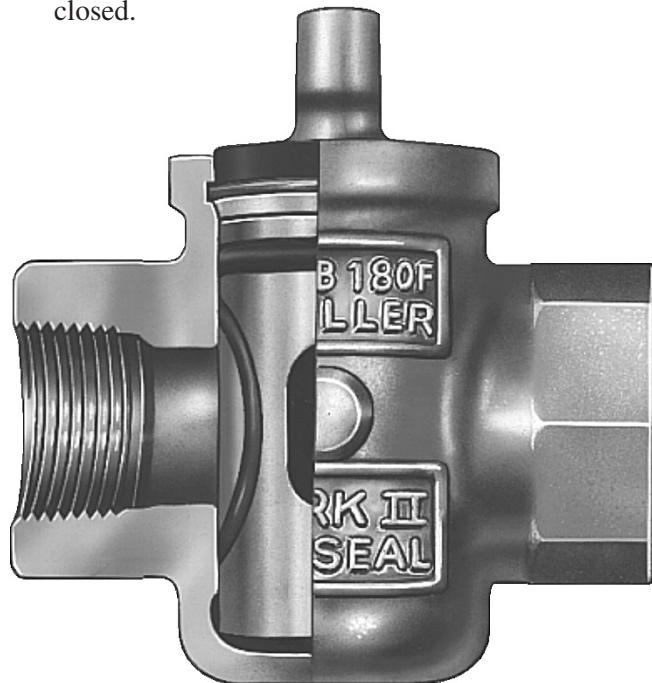

- ❑ 175 PSIG - maximum working pressure.
- ❑ ELONGATED ROUND WAY - provides straight through flow passage with low pressure loss.
- ❑ HEAVY BRASS COMPONENTS constructed of 85-5-5 ASTM B62 brass for strength and durability.

- ❑ HIGH STRENGTH INTEGRAL CHECKS - assure positive quarter turn operation and are equal in strength to the tee head.
- ❑ CLOSED BOTTOM minimizes exposed moving parts.
- ❑ MANUFACTURED AND TESTED - to ANSI/AWWA C800 standard.
- ❑ END CONNECTIONS include copper flare, MUELLER 110® Compression Connection, MUELLER INSTA-TITE® Connection, Mueller Pack Joint and F.I.P. thread.