

Simmons

Manufacturing Company
Water Well Supplies



MADE IN U.S.A.

McDonough, Georgia

June 2002

Simmons Manufacturing Company

P.O. Box 1509
1608 Conyers Road
McDonough, GA 30253

www.simmonsmfg.com

simmonssales@simmonsmfg.com

770-957-3976

Fax: 770-957-3979

**Sales Order Desk:
800-241-1935**



SIMMONS SUPERIOR COATING



Blue Powder Polyester high-tech finish on cast parts and components has super smoothness, hardness, adhesion and durability. Cured at more than 400° F. for long life, less oxidation and greater UV resistance.

Limited Warranty

Simmons Manufacturing Company will replace or refund purchase price to the original purchaser of this product if it is determined that the same is defective. This warranty is limited to replacement of the product or refund of the purchase price.

EXCLUSIONS OF WARRANTY:

Simmons makes no warranty, express or implied, with respect to its products, other than the limited warranty described above. Implied warranties of merchantability and fitness for a particular purpose are hereby disclaimed by Simmons unless such disclaimers are prohibited by applicable state law. There are no warranties that extend beyond the description on the face hereof.

EXCLUSION OF INCIDENTAL AND CONSEQUENTIAL DAMAGES:

In no event shall Simmons be liable for incidental or consequential damages, including, but without limitation, damages for personal injury or property damage, it being intended that purchaser's exclusive remedy is limited to replacement of defective products or refund of purchase price.

EXCLUSIONS FOR IMPROPER USE OR INSTALLATION BY UNQUALIFIED PERSONS:

The limited warranty provided by Simmons will not apply if a Simmons product is used for a purpose other than the purpose for which it was manufactured, which is as a component in cold water systems only. The limited warranty provided by Simmons also will not apply if a Simmons product is improperly installed or is installed by an unqualified person. Simmons products should be installed only by

licensed contractors or by persons having proper training and experience in the installation of water systems and water system components. Simmons products should not be used in water systems which may exceed the maximum working pressure indicated on the product or product literature. It is the installers responsibility to make sure the product and product installation meet all local, state, and federal code regulations.

WARNINGS:

Improper use or installation of Simmons products may cause property damage or personal injury. Simmons products should be used in cold water systems only. Simmons products should not be used in water systems which may exceed the maximum pressure indicated on the product. Simmons products should be installed only by licensed and qualified persons.

Simmons Superior Packaging

- Valves are individually boxed and color coded for ease of handling and identification.
- Valves are boxed for individual purchase.



- Carton and master carton quantities are offered to expedite handling and purchasing.

- Yard hydrants are individually boxed in self-selling display cartons!



Index

Contents	Page
Air Valves	41
Air Volume Controls	40
Bleeder Orifice.	42
Cable Guard	42
Caps, Drive	35
Caps, Well	28
Check Valves, Stainless Steel	5
Check Valves, Bronze	6-8
Check Valves, Ductile Iron	9
Couplings, Drive and Turned	35
Foot Valves, Stainless Steel	5
Foot Valves, Bronze	4
Foot Valves, Cast Iron	10
Frost Proof Yard Hydrants	24-27
Insert Fittings	38-39
Lighting Arrestor	42
Pitcher Pump & Parts	41
Pitless Adapters	12
Pressure Gauges	41
Pressure Switches	43
Relief Valves	42
Splicing Kits	42
Submersible Rope	41
Tank Crosses, Tank Tees	29-33
Torque Arrestor	42
Well Points	34-36
Well Screens	37
Well Seals	13-23
Dimensions, Check Valves	11
Dimensions, Foot Valves	11
Dimensions, Well Points	36
Dimensions, Hydrant Lengths	47
Pressure Data, Check Valves.	44-45
Specifications, Sanitary Hydrants.	46
Freight Policy (See Back Cover)	48

LEAD FREE*

400 SB Series

Foot Valve



- Silicon bronze cast body.
- Silicon bronze cast poppet.
- Stainless Steel Perforated Strainer.
- Female threads.

Part No.	Size	Weight Each lbs.	Carton Quantity	List Price Each
452SB	3/4	.50	1	18.40
453SB	1	.75	1	20.43
404SB**	1 1/4	1.00	1	23.98
454SB	1 1/4	1.00	1	22.32
455SB	1 1/4	1.25	1	24.65
456SB	1 1/2	1.50	1	39.80
457SB	2	2.75	1	63.14
458SB	2 1/2	7.00	1	209.96
459SB	3	9.00	1	288.50
460SB	4	16.50	1	480.02
461SB	6	35.00	1	1,053.46

**404SB enters 2" pipe

LEAD FREE *



- Silicon bronze cast body.
- Silicon bronze cast poppet.
- Stainless Steel Perforated Strainer.
- Dual purpose threads.

Part No.	Size FxM	Weight Each lbs.	Carton Quantity	List Price Each
465SB	3/4 x 1	.50	1	21.95
466SB	1 x 1 1/4	.75	1	22.93
467SB	1 1/4 x 1 1/2	1.00	1	27.29

LEAD FREE *



- Silicon bronze cast body.
- Silicon bronze cast poppet.
- ABS plastic strainer.
- Female threads.
- Dual threads on 487SB.

Part No.	Size	Weight Each lbs.	Carton Quantity	List Price Each
483SB	1	.75	1	20.43
487SB	1 x 1 1/4	.75	1	22.93

LEAD FREE *

Suction Strainer



- Silicon bronze cast body.
- Stainless Steel Perforated Strainer.
- Female threads.

Part No.	Size	Weight Each lbs.	Carton Quantity	List Price Each
490SB	3/4	.50	1	18.40
491SB	1	.75	1	21.29
492SB	1 1/4	1.00	1	28.37
493SB	1 1/2	1.25	1	39.90
494SB	2	2.50	1	61.17
495SB	2 1/2	5.75	1	147.01
496SB	3	7.50	1	195.81
497SB	4	12.25	1	303.55
489SB	6	32.00	1	913.54

*Silicon bronze components contain less than .05% (1/20 of 1%) Lead.

All foot valves furnished with Buna-N O-Ring, stainless steel spring and stainless steel locknut.

All foot valves have a working pressure of 400 psi.

MADE IN U.S.A.

Stainless Steel Series



Foot Valve

- Stainless Steel cast body.
- Stainless Steel cast poppet.
- Stainless Steel perforated strainer.
- Female threads.

Part No.	Size	Weight Each lbs.	Carton Quantity	List Price Each
454SS	1 1/4	1.00	1	25.98



Stemless Foot Valve

- Stainless Steel cast body.
- Stainless Steel cast poppet.
- Stainless Steel perforated strainer.
- Female threads.
- Fits in 2" diameter pipe.

Part No.	Size	Weight Each lbs.	Carton Quantity	List Price Each
2404SS	1 1/4	1.00	1	30.18



Check Valve

- Stainless Steel cast body.
- Stainless Steel cast poppet.
- Female/Male Threads.

Part No.	Size FxM	Weight Each lbs.	Carton Quantity	List Price Each
617SS	1 x 1 1/4	1.00	1	24.75
618SS	1 1/4 x 1 1/4	1.75	1	30.94

Plastic Series



Brady Foot Valve

- Sizes -- 3/4" through 1 1/2."
- Spring loaded.
- Acetal polymer material.

Part No.	Size	Weight Each lbs.	Carton Quantity	List Price Each
445	3/4	.20	1	17.25
446	1	.20	1	19.85
447	1 1/4	.30	1	28.15
448	1 1/2	.60	1	34.10

Brady Check Valve

- Sizes -- 3/4" through 1 1/2."
- Spring loaded.
- Acetal polymer material.

Part No.	Size	Weight Each lbs.	Carton Quantity	List Price Each
645	3/4	.10	1	14.75
646	1	.20	1	17.20
647	1 1/4	.30	1	25.50
648	1 1/2	.40	1	30.50

MADE IN U.S.A.

LEAD FREE*

500 SB Series



Check Valve

- Silicon bronze cast body.
- Silicon bronze cast poppet.
- Female threads.

Part No.	Size	Weight Each lbs.	Carton Quantity	List Price Each
501SB	1/2	.50	1	20.63
502SB	3/4	.75	1	20.87
503SB	1	1.00	1	21.98
513SB*	1	1.25	1	22.94
504SB	1 1/4	1.50	1	30.13
514SB**	1 1/4	1.50	1	32.21
505SB	1 1/2	2.00	1	42.13
506SB	2	3.75	1	68.14
507SB	2 1/2	9.50	1	290.73
508SB	3	9.75	1	350.38
509SB	4	24.00	1	609.12
510SB***	5	26.00	1	819.14
511SB	6	37.00	1	1,113.20

513SB* has longer threads.

514SB** has longer threads.

510SB*** has 5" male threads both ends.



LEAD FREE* Single Tap

- Silicon bronze cast body.
- Silicon bronze cast poppet.
- Female threads.

Part No.	Size	Tapped Inlet	Tapped Outlet	Weight Each lbs.	Carton Quantity	List Price Each
521SB	3/4	1/8		.75	1	23.82
550SB	3/4	1/4		.75	1	23.82
551SB	3/4		1/8	.75	1	23.82
552SB	3/4		1/4	.75	1	23.82
522SB	1	1/8		1.25	1	28.04
553SB	1	1/4		1.00	1	28.04
554SB	1		1/8	1.25	1	28.04
555SB	1		1/4	1.00	1	28.04
523SB	1 1/4	1/8		1.75	1	37.42
556SB	1 1/4	1/4		1.50	1	37.42
558SB	1 1/4		1/4	1.50	1	37.42
524SB	1 1/2	1/8		2.00	1	46.27
559SB	1 1/2	1/4		1.75	1	46.27
560SB	1 1/2		1/8	1.75	1	46.27
561SB	1 1/2		1/4	1.75	1	46.27
525SB	2	1/8		3.75	1	73.27
562SB	2	1/4		3.50	1	73.27
563SB	2		1/8	3.75	1	73.27
564SB	2		1/4	3.50	1	73.27
526SB	2 1/2	1/8		9.50	1	345.55
527SB	3	1/8		9.50	1	504.07
528SB	4	1/8		23.00	1	666.39

*Silicon bronze components contain less than .05% (1/20 of 1%) Lead.

Check Valves furnished with Buna-N O-Ring, stainless steel spring, stainless steel washer, and stainless steel locknut.

All check valves have a working pressure of 400 psi.

MADE IN U.S.A.



LEAD FREE*
Double Tapped

- Silicon bronze cast body.
- Silicon bronze cast poppet.
- Female threads.

Part No.	Size	Tapped Inlet	Tapped Outlet	Weight Each lbs.	Carton Quantity	List Price Each
541SB	3/4	1/8	1/4	.75	1	25.08
580SB	3/4	1/4	1/4	.75	1	25.08
542SB	1	1/8	1/4	1.00	1	30.11
581SB	1	1/4	1/4	1.00	1	30.11
588SB	1	1/8	1/8	1.00	1	30.11
543SB	1 1/4	1/8	1/4	1.50	1	37.05
582SB	1 1/4	1/4	1/4	1.50	1	37.05
589SB	1 1/4	1/8	1/8	1.50	1	37.05
544SB	1 1/2	1/8	1/4	1.75	1	47.99
583SB	1 1/2	1/4	1/4	1.75	1	47.99
533SB	1 1/2	1/8	1/8	1.75	1	47.99
545SB	2	1/8	1/4	3.50	1	74.38
584SB	2	1/4	1/4	3.50	1	74.38
546SB	2 1/2	1/8	1/4	9.00	1	363.32
547SB	3	1/8	1/4	10.00	1	513.01
548SB	4	1/8	1/4	23.00	1	670.86



2500 SB Series

LEAD FREE*
Stemless Check Valve

- Silicon bronze cast body.
- Silicon bronze stemless poppet.
- Female threads.

Part No.	Size	Weight Each lbs.	Carton Quantity	List Price Each
2503SB	1	1.00	1	25.16
2504SB	1 1/4	1.50	1	34.31
2505SB	1 1/2	1.75	1	46.18
2506SB	2	3.50	1	71.97



LEAD FREE*
Submersible Check Valve

- Silicon bronze cast body.
- Silicon bronze cast poppet.
- Female-Male threads.

Part No.	Size FxM	Weight Each lbs.	Carton Quantity	List Price Each
610SB**	1 x 1	1.50	1	23.98
611SB**	1 1/4 x 1 1/4	2.00	1	30.86
616SB	1 x 1	1.25	1	21.70
617SB	1 x 1 1/4	1.25	1	20.98
618SB	1 1/4 x 1 1/4	1.75	1	27.86
622SB	2 x 2	4.00	1	72.03
623SB	3 x 3	11.00	1	345.81
624SB	4 x 4	23.00	1	601.79
625SB	6 x 6	40.00	1	1,095.13

**Extended male and female threads

*Silicon bronze components contain less than .05% (1/20 of 1%) Lead.

Check Valves furnished with Buna-N O-Ring, stainless steel spring, stainless steel washer, and stainless steel locknut. All check valves have a working pressure of 400 psi.

MADE IN U.S.A.

Control Center

LEAD FREE* Check Valve



- Silicon bronze cast body.
- Silicon bronze cast poppet.
- Four tappings.
- Female threads.

601-604 have these tappings:

One 1/8" inlet,
Two 1/4" outlets,
One 1/8" outlet.

606-607 have these tappings:

Two 1/4" outlets.

Part No.	Size	Weight Each lbs.	Carton Quantity	List Price Each
601SB	1	1.33	1	30.18
602SB	1 1/4	2.00	1	39.07
603SB	1 1/2	2.00	1	49.79
604SB	2	4.00	1	88.87

For Diaphragm Tanks

606SB	1	1.33	1	30.18
607SB	1 1/4	2.00	1	39.07



LEAD FREE* Dual Purpose Check Valve

- Silicon bronze cast body.
- Silicon bronze cast poppet.
- Female-Male threads both ends.

Part No.	Size FxM	Size FxM	Weight Each lbs.	Carton Quantity	List Price Each
641SB	1 x 1 1/4	1 x 1 1/4	1.00	1	26.35



LEAD FREE* Pressure Regulator Valve

- Silicon bronze cast body.
- Adjustable bronze cylinder control.
- For deep well pumps.
- Positive O-Ring seat.

Part No.	Size	Pressure Line Tapping	Weight Each lbs.	List Price Each
729SB	3/4 x 3/4 x 3/4	1/4	.75	34.87
730SB	3/4 x 3/4 x 3/4	-	.75	34.87
731SB	1 x 1 x 1	1/8	1.30	39.68
732SB	1 x 1 x 1	1/4	1.30	39.68

*Silicon bronze components contain less than .05% (1/20 of 1%) Lead.

Check Valves furnished with Buna-N O-Ring, stainless steel spring, stainless steel washer, and stainless steel locknut.
All check valves have a working pressure of 400 psi.

MADE IN U.S.A.



LEAD FREE* Ductile Iron Check Valve

- Ductile iron body.
- Silicon bronze poppet.
- Stainless steel spring and nut.
- Non-toxic polyester powder coat paint.

Stemless Ductile Iron Check Valve

Part No.	Size	Weight Each lbs.	Carton Quantity	List Price Each
680SB	2	3.5	1	53.97
670SB	3	9.5	1	203.83
681SB	3*	10.5	1	230.53
671SB	4	24.0	1	318.73
674SB	5	33.5	1	501.56
672SB	6	39.5	1	614.66
683SB	6*	40.5	1	891.63
673SB	8	55.0	1	1,556.00
2680SB	2	3.5	1	59.70
2681SB	3*	10.0	1	255.25
2671SB	4	24.5	1	392.56
2674SB	5	33.0	1	729.50
2683SB	6*	40.5	1	982.60

* High Flow Design



Check Valve
(with Break-off Plug)



STEMLESS Check Valve
(with Break-off Plug)

LEAD FREE* Ductile Iron Check Valve with Break-off Plug

- 1/2" Break-off plug standard.
- 3/8" Break-off plug optional.

Stemless Ductile Iron Check Valve with Break-off Plug

Part No.	Size	Weight Each lbs.	Carton Quantity	List Price Each
675SB	3	10.0	1	248.39
685SB	3*	10.5	1	275.09
676SB	4	24.0	1	364.28
679SB	5	34.0	1	541.90
677SB	6	40.5	1	654.28
687SB	6*	40.5	1	931.25
678SB	8	55.0	1	1,598.00
2685SB	3*	10.5	1	299.81
2676SB	4	24.5	1	438.11
2679SB	5	34.0	1	769.84
2687SB	6*	40.5	1	1,022.22

* High Flow Design

Break-off Plug Only



- Stainless steel.
- The break-off plug, when manually broken, allows water to drain from drop pipe before removal of pump.

Part No.	Size	Weight Each lbs.	List Price Each
4061	1/2	.50	40.34
4068	3/8	.40	40.34



LEAD FREE* Ductile Iron Submersible Check Valve

- Ductile iron body.
- Silicon bronze poppet.
- Stainless steel spring and nut.
- Non-toxic polyester powder coat paint.
- Female-Male threads.

Part No.	Size FxM	Weight Each lbs.	Carton Quantity	List Price Each
658SB	2 x 2	3.5	1	71.70
660SB	3 x 3	10.0	1	203.68
661SB	4 x 4	21.0	1	314.88
662SB	6 x 6	49.0	1	617.19

*Silicon bronze components contain less than .05% (1/20 of 1%) Lead.

Check Valves furnished with Buna-N O-Ring, stainless steel spring, stainless steel washer, and stainless steel locknut.
All check valves have a working pressure of 400 psi.

MADE IN U.S.A.

Valve Parts

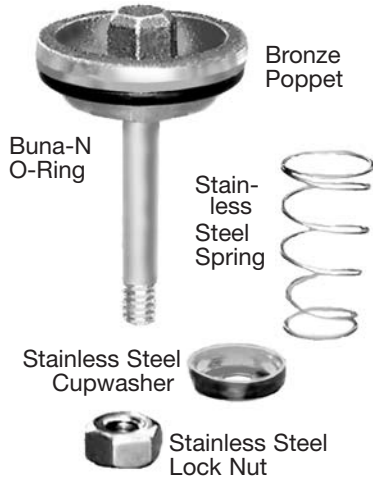

Complete Poppet, Foot Valve

Part No.	Size	List Price
980SB	1/2"	4.90
981SB	3/4"	5.89
982SB	1"	6.28
983SB	1 1/4"	7.73
984SB	1 1/2"	10.42
985SB	2"	11.18
986SB	2 1/2"	31.39
987SB	3"	34.21
988SB	4"	53.25
989SB	6"	74.38



Complete Poppet, Check Valve

Part No.	Size	List Price
959SB	1/2"	4.90
960SB	3/4"	5.89
961SB	1"	6.28
962SB	1 1/4"	7.73
963SB	1 1/2"	10.42
964SB	2"	11.18
965SB	2 1/2"	31.39
966SB	3"	34.21
967SB	4"	53.25
968SB	5"	54.74
969SB	6"	74.38
990SB	8"	91.23

Strainer with Bottom Plate & Screw

Part No.	Size	List Price
950SB	1/2"	3.84
951SB	3/4"	3.84
952SB	1"	4.93
953SB	1 1/4"	6.91
954SB	1 1/2"	7.73
955SB	2"	9.31
956SB	2 1/2"	22.33
957SB	3"	27.29
958SB	4"	38.43
999SB	6"	102.38

O Ring, Check and Foot Valve

Part No.	Size	List Price
8100	1/2"	.46
8101	3/4"	.54
8102	1"	.61
8103	1 1/4"	.87
8104	1 1/2"	1.37
8105	2"	1.56
8106	2 1/2"	4.33
8107	3" F.V.	5.41
8108	4" F.V.	8.93
8109	4" - 5" C.V.	8.93
8110	6"	9.85
8106	3" check only	4.33
8112	8" check only	13.98

Poppet Spring, Foot Valve

Part No.	Size	List Price
8201	1/2" & 3/4"	.46
8202	1"	.54
8203	1 1/4"	.76
8208	1 1/2" & 2"	1.36
8204	2 1/2" & 3"	2.11
8205	4"	3.66
8209	6"	4.93

Poppet Spring, Check Valve

Part No.	Size	List Price
8211	1/2"	.46
8202	3/4"	.46
8206	1" & 1 1/4"	.76
8207	1 1/2" & 2"	1.31
8204	2 1/2" & 3"	2.11
8210	4" & 5"	4.93
8209	6"	4.93
8212	8"	18.38



Cast Iron Foot Valve

- Painted cast iron.
- Weighted leather flapper.

Part No.	Size	Weight Each lbs.	Carton Quantity	List Price Each
470	1	2.5	1	72.61
471	1 1/4	3.5	1	79.73
472	1 1/2	3.5	1	83.81
473	2	6.5	1	81.03
474	2 1/2	14.5	1	159.65
475	3	14.5	1	151.50
476	4	24.0	1	209.56
477	5	33.0	1	346.25
478	6	43.0	1	340.83
479	8	95.0	1	781.75

Cast Iron Foot Valve Parts

- Leather flapper replacements.



Part No.	Valve Size	List Price Each
192460	1 1/4" - 1 1/2"	14.26
192470	2"	14.26
192480	2 1/2" - 3"	21.50
192490	4"	37.85
192500	5"	152.73
192510	6"	67.60
192525	8"	191.29

MADE IN U.S.A.

Dimensions

Foot Valves

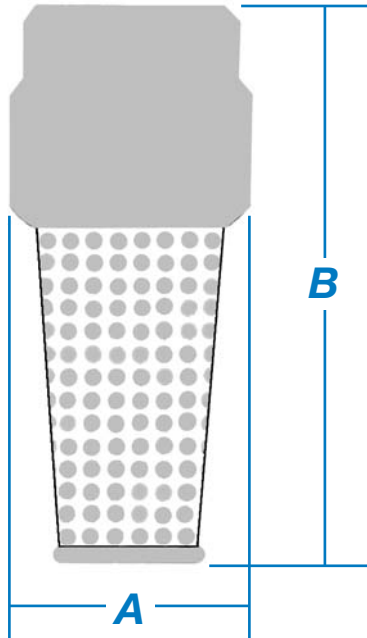

Part No.	A Diameter Inches	B Length Inches
404SB	1 15/16	5
452SB	1 3/8	3 3/4
453SB	1 3/4	4 3/4
454SB	2 1/8	5
455SB	2 5/16	5 1/4
456SB	2 1/2	6 5/16
457SB	3 1/8	7 3/16
458SB	4	9 3/8
459SB	4 5/8	9 1/2
460SB	6	13 7/8
461SB	7 1/2	15 3/4
465SB	1 5/16	3 3/4
466SB	1 5/8	5
467SB	1 15/16	5

Check Valves

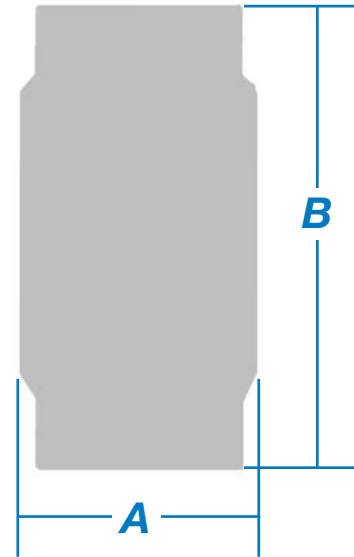

Part No.	A Diameter Inches	B Length Inches
501SB	1 3/8	2 5/8
502SB	1 5/8	3 3/8
503SB	1 7/8	3 5/8
504SB	2 1/4	3 3/4
505SB	2 5/8	4 1/8
506SB	3 1/4	5 1/8
507SB	4	7 3/8
508SB	4 1/16	7 1/4
509SB	5 1/2	10 1/2
510SB	5 5/8	10 5/8
511SB	7 5/8	10 5/8
513SB	1 7/8	3 7/8
514SB	2 1/4	4 1/8
542SB	1 7/8	3 3/4
601SB	2 3/16	3 5/8
602SB	2 1/4	4 1/4
603SB	2 9/16	4 1/16
604SB	3 3/16	5 1/16
617SB	1 7/8	3 3/4
618SB	2 1/4	4 3/8
622SB	3 1/4	5
623SB	4 1/8	7 3/8
624SB	5 9/16	10 1/2
625SB	7 3/4	11
641SB	1 3/4	4 3/4
658SB	3 1/4	5
660SB	4 1/8	7 3/8
661SB	5 9/16	10 1/2
662SB	7 3/4	11
670SB	4 1/16	7 1/4
671SB	5 5/8	10 1/2
672SB	7 5/8	10 11/16
673SB	9 5/8	12
674SB	6 3/4	11
680SB	3 3/16	5 1/16
681SB	4 7/8	8



Pitless Adapter **

- Bronze body.
- Buna-N O-Ring.
- Vertical position indicator.
- Factory tested to 250 psi.
- Supports 5000 pounds.
- Fits 5"-12" casing.



Compact Pitless Adapter **

- Bronze body.
- Buna-N O-Ring.
- Vertical position indicator.
- Factory tested to 250 psi.
- Supports 2,500 pounds.
- Fits 5"-12" casing.



Pitless Adapter **

- Bronze body.
- Two pipe.
- Fits 4"-12" casing.
- Buna-N O-Ring.



MADE IN U.S.A.

LEAD FREE Compact Pitless Adapter*

- Silicon bronze body.
- Buna-N O-Ring.
- Vertical position indicator.
- Factory tested to 250 psi.
- Supports 2,500 pounds.
- Fits 5"-12" casing.



All Simmons Pitless Adapters are **CERTIFIED WATER TIGHT** by the Water Systems Council Pitless Adapter Division.

Part No	Size	Hole Size Required	Weight Each lbs.	Carton Quantity	List Price Each
1820	1	1 3/4	4.5	6	69.23
1822	1 1/4	2 1/8	6.0	6	100.38
*Pressurized					
1821	1	1 3/4	4.5	6	70.83
1823	1 1/4	2 1/8	6.0	6	102.57

*For Installations requiring a pressurized point of attachment, a small hole between the internal and external seals maintains positive pressure at seal.

Part No	Size	Hole Size Required	Weight Each lbs.	Carton Quantity	List Price Each
1840	1	1 5/8	3	6	45.70
*Pressurized					
1841	1	1 5/8	3	6	47.18

*For Installations requiring a pressurized point of attachment, a small hole between the internal and external seals maintains positive pressure at seal.

Part No	Supply Size	Discharge Size	Weight Each lbs.	Carton Quantity	List Price Each
1830	1 - 1 1/4	1 - 1 1/4	11.5	1	274.43

Part No	Size	Weight Each lbs.	Carton Quantity	List Price Each
1822SB	1 1/4	6	1	120.31
1840SB	1	3	6	59.80
*Pressurized				
1841SB	1	3	6	61.30

*For Installations requiring a pressurized point of attachment, a small hole between the internal and external seals maintains positive pressure at seal.



IMPORT Pitless Adapter **

- Bronze body.
- Buna-N O-Ring.
- Vertical position indicator.

Part No.	Size	Hole Size Required	Weight Each lbs.	Carton Quantity	List Price Each
1850	1	1 5/8	3.00	6	28.90

**Contains Lead, Not for sale in California.

*Silicon bronze components contain less than .05% (1/20 of 1%) Lead.

Well Seal

- Single Drop Pipe - Split Top Plate - Submersible Pump

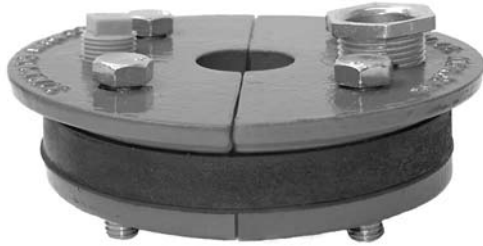

- Class 25 Non-toxic lead free painted cast iron.
- Zinc plated steel bolts.
- Single hole.
- 3/4" molded rubber.

Packaging - All Seals

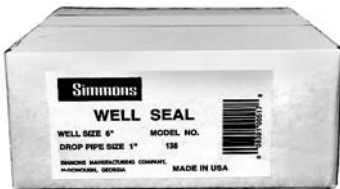

All well seals are individually boxed...

...then packed 6 per master carton.

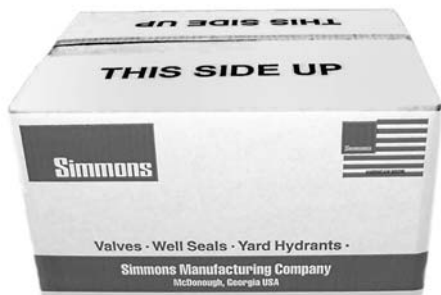

Part No.	Well Size I.D.	Drop Pipe Size	Cable Hole Tapping	Vent Tapping	Weight Each lbs.	Carton Quantity	List Price Each
106	2	3/4	1/8	1/8	.75	1	20.09
107	2	1	1/8	1/8	.75	1	20.09
108	3	1	3/8	1/8	2.0	6	23.91
109*	3	1 1/4	3/8	3/8	2.0	6	23.91
110	4	3/4	3/4	1/2	3.5	6	23.69
111	4	1	3/4	1/2	3.5	6	22.28
112	4	1 1/4	3/4	1/4	3.5	6	22.28
113	4	1 1/2	3/4	1/4	3.0	6	22.84
114	4	2	1/2	1/4	3.0	6	22.84
115	4 1/4	3/4	3/4	1/2	3.5	6	23.69
116	4 1/4	1	3/4	1/2	3.5	6	22.28
117	4 1/4	1 1/4	3/4	1/4	3.5	6	22.28
118	4 1/4	1 1/2	3/4	1/4	3.0	6	22.84
119	4 1/4	2	1/2	1/4	3.0	6	22.84
164	4 1/2	3/4	3/4	1/2	4.5	6	32.54
165	4 1/2	1	3/4	1/2	4.5	6	32.54
166	4 1/2	1 1/4	3/4	1/2	4.5	6	32.54
167	4 1/2	1 1/2	3/4	1/2	4.5	6	32.54
168	4 1/2	2	3/4	1/2	4.5	6	32.54
120	5	3/4	1	1/2	6.0	6	34.12
121	5	1	1	1/2	6.0	6	34.12
122	5	1 1/4	1	1/2	6.0	6	34.12
123	5	1 1/2	1	1/2	5.0	6	34.12
124	5	2	3/4	1/2	5.0	6	34.12
130	5 5/8	3/4	3/4	1/2	7.5	6	36.18
131	5 5/8	1	3/4	1/2	7.5	6	36.18
132	5 5/8	1 1/4	3/4	1/2	7.5	6	36.18
133	5 5/8	1 1/2	3/4	1/2	7.0	6	36.18
134	5 5/8	2	3/4	1/2	7.0	6	36.18
135	6	3/4	1	1/2	7.5	6	36.57
136	6	1	1	1/2	7.5	6	36.20
137	6	1 1/4	1	1/2	7.0	6	36.20
138	6	1 1/2	1	1/2	7.0	6	36.57
139	6	2	1	1/2	6.5	6	36.57
020	6	2 1/2	1	1/2	6.5	6	36.57

*-Two 3/8" Drilled holes - no threads.

Sizes 6 1/4" through 12" Continued on page 14...

MADE IN U.S.A.

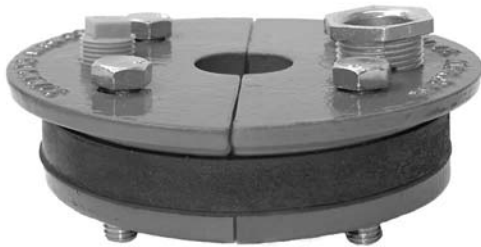

Well Seal

Single Drop Pipe - Split Top Plate - Submersible Pump

- Class 25 Non-toxic lead free painted cast iron.
- Zinc plated steel bolts.
- Single hole.
- 3/4" molded rubber.

Packaging - All Seals

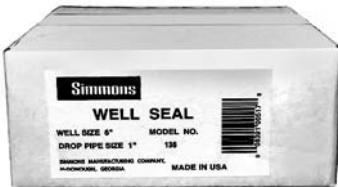

All well seals are individually boxed.



Part No.	Well Size I.D.	Drop Pipe Size	Cable Hole Tapping	Vent Tapping	Weight Each lbs.	Carton Quantity	List Price Each
140	6 1/4	3/4	1	1/2	7.50	6	36.57
141	6 1/4	1	1	1/2	7.50	6	36.20
142	6 1/4	1 1/4	1	1/2	7.00	6	36.20
143	6 1/4	1 1/2	1	1/2	7.00	6	36.57
144	6 1/4	2	1	1/2	6.50	6	36.57
026	6 1/4	2 1/2	1	1/2	6.50	6	36.57
145	6 5/8	1	3/4	1/2	10.00	6	46.97
146	6 5/8	1 1/4	3/4	1/2	10.00	6	46.97
147	6 5/8	1 1/2	3/4	1/2	10.00	6	46.97
148	6 5/8	2	3/4	1/2	10.00	6	46.97
032	6 5/8	2 1/2	3/4	1/2	10.00	6	46.97
033	6 5/8	3	3/4	1/2	8.00	6	46.97
196	8	1	1	1/2	16.00	1	94.23
197	8	1 1/4	1	1/2	16.00	1	94.23
198	8	1 1/2	1	1/2	16.00	1	94.23
199	8	2	1	1/2	16.00	1	94.23
040	8	2 1/2	1	1/2	16.00	1	94.23
041	8	3	1	1/2	14.00	1	94.23
042	8	4	1	1/2	14.00	1	94.23
001	10	1	1	1/2	32.00	1	138.83
002	10	1 1/4	1	1/2	32.00	1	138.83
003	10	1 1/2	1	1/2	32.00	1	138.83
004	10	2	1	1/2	32.00	1	138.83
005	10	2 1/2	1	1/2	30.00	1	138.83
006	10	3	1	1/2	30.00	1	138.83
007	10	4	1	1/2	30.00	1	138.83
008	10	5	1	1/2	30.00	1	138.83
009	10	6	1	1/2	30.00	1	154.44
010	12	1	1	1/2	46.00	1	174.75
011	12	1 1/4	1	1/2	46.00	1	174.75
012	12	1 1/2	1	1/2	46.00	1	174.75
013	12	2	1	1/2	46.00	1	174.75
014	12	2 1/2	1	1/2	43.00	1	174.75
015	12	3	1	1/2	43.00	1	174.75
016	12	4	1	1/2	43.00	1	174.75
017	12	5	1	1/2	43.00	1	174.75
018	12	6	1	1/2	43.00	1	190.87

MADE IN U.S.A.

Well Seal

Single Drop Pipe - Solid Top Plate - Submersible Pump

- Class 25 Non-toxic lead free painted cast iron.
- Zinc plated steel bolts.
- Single hole.
- 3/4" molded rubber.



Part No.	Well Size I.D.	Drop Pipe Size	Cable Hole Tapping	Vent Tapping	Weight Each lbs.	Carton Quantity	List Price Each
300	4	3/4	3/4	1/2	4.00	6	24.63
301	4	1	3/4	1/2	4.00	6	24.47
305	4 1/4	3/4	3/4	1/2	4.00	6	24.63
306	4 1/4	1	3/4	1/2	4.00	6	24.47
322	5	3/4	3/4	1/2	6.00	6	34.52
323	5	1	3/4	1/2	6.00	6	34.52
324	5	1 1/4	3/4	1/2	6.00	6	34.52
325	5	1 1/2	3/4	1/2	6.00	6	34.52
326	5 5/8	3/4	3/4	1/2	7.50	6	37.70
327	5 5/8	1	3/4	1/2	7.50	6	37.70
328	5 5/8	1 1/4	3/4	1/2	7.50	6	37.70
329	5 5/8	1 1/2	3/4	1/2	7.50	6	37.70
312	6	3/4	1	1/2	8.50	6	38.01
313	6	1	1	1/2	8.50	6	37.59
314	6	1 1/4	1	1/2	8.50	6	37.59
315	6	1 1/2	1	1/2	8.00	6	38.01
316	6	2	1	1/2	7.50	6	38.01
*021	6	3	1	1/2	5.75	6	38.01
**022	6	4	-	1/2	3.75	6	38.01
317	6 1/4	3/4	1	1/2	8.75	6	38.01
318	6 1/4	1	1	1/2	8.75	6	37.59
319	6 1/4	1 1/4	1	1/2	8.75	6	37.59
320	6 1/4	1 1/2	1	1/2	8.00	6	38.01
321	6 1/4	2	1	1/2	8.00	6	38.01
*027	6 1/4	3	1	1/2	6.00	6	38.01
**028	6 1/4	4	-	1/2	4.00	6	38.01

*Offset Drop Pipe.

**Two - 1/2 cable holes offset drop pipe.

Blank Well Seals available upon request.

- Designed to fit outside of well casing.



Part No.	Well Size I.D.	Drop Pipe Size	Vent Tapping	Weight Each lbs.	Carton Quantity	List Price Each
045	2	1 1/4	1/8	3.00	6	23.93
046	3	1 1/2	1/8	5.00	6	30.25
050	3	2	1/8	5.00	6	33.45

- Offset drop pipe.



Part No.	Well Size I.D.	Drop Pipe Size	Cable Hole Tapping	Vent Tapping	Weight Each lbs.	Carton Quantity	List Price Each
Split 047	4	1	3/4	1/2	3.50	6	24.92
Solid 048	4	1	3/4	1/2	3.50	6	24.92
Solid 049	4	1 1/4	3/4	1/2	3.50	6	24.92

MADE IN U.S.A.



Well Seal

Double Drop Pipe - Split Top Plate - Jet Pump

- Class 25 Non-toxic lead free painted cast iron.
- Zinc plated steel bolts.
- Double hole.
- 3/4" molded rubber.

Packaging - All Seals



All well seals are individually boxed...

...then packed 6 per master carton.

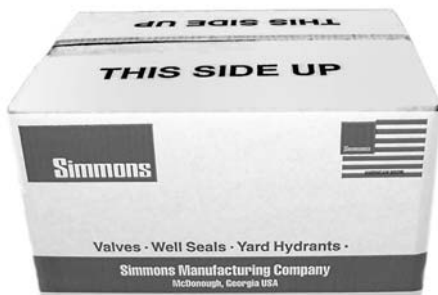

Part No.	Well Size I.D.	Drop Pipe Size	Vent Tapping	Weight Each lbs.	Carton Quantity	List Price Each
149	3	1 x 3/4	1/4	2.0	1	23.46
150	4	1 x 3/4	1/2	3.0	6	22.58
151	4	1 x 1	1/2	3.0	6	22.10
152	4	1 1/4 x 1	1/2	3.0	6	21.95
153	4	1 1/4 x 1 1/4	1/2	3.0	6	22.10
154	4 1/4	1 x 3/4	1/2	3.5	6	22.58
155	4 1/4	1 x 1	1/2	3.5	6	22.10
156	4 1/4	1 1/4 x 1	1/2	3.5	6	21.95
157	4 1/4	1 1/4 x 1 1/4	1/2	3.0	6	22.10
160	5	1 x 3/4	1/2	5.0	6	33.95
161	5	1 1/4 x 1	1/2	5.0	6	33.95
162	5	1 1/4 x 1 1/4	1/2	5.0	6	33.95
170	5 5/8	1 x 3/4	1/2	7.0	6	34.22
171	5 5/8	1 1/4 x 1	1/2	7.0	6	34.22
172	5 5/8	1 1/4 x 1 1/4	1/2	7.0	6	34.22
173	5 5/8	1 1/2 x 1 1/4	1/2	6.5	6	34.22
174	5 5/8	2 x 1 1/2	1/2	6.5	6	34.22
175	6	1 x 3/4	1/2	8.0	6	34.94
176	6	1 x 1	1/2	8.0	6	34.94
177	6	1 1/4 x 1	1/2	8.0	6	34.94
178	6	1 1/4 x 1 1/4	1/2	8.0	6	34.94
179	6	1 1/2 x 1 1/4	1/2	8.0	6	34.94
180	6	2 x 1 1/2	1/2	8.0	6	34.94
181	6 1/4	1 x 3/4	1/2	8.0	6	34.94
182	6 1/4	1 x 1	1/2	8.0	6	34.94
183	6 1/4	1 1/4 x 1	1/2	8.0	6	34.94
184	6 1/4	1 1/4 x 1 1/4	1/2	8.0	6	34.94
185	6 1/4	1 1/2 x 1 1/4	1/2	8.0	6	34.94
186	6 1/4	2 x 1 1/2	1/2	8.0	6	34.94
187	6 5/8	1 1/4 x 1	1/2	9.0	6	48.59
188	6 5/8	1 1/4 x 1 1/4	1/2	9.0	6	48.59
189	6 5/8	1 1/2 x 1 1/4	1/2	9.0	6	48.59
190	6 5/8	2 x 1 1/2	1/2	9.0	6	48.59
191	8	1 1/4 x 1	1/2	16.0	1	91.62
192	8	1 1/4 x 1 1/4	1/2	16.0	1	91.62
193	8	1 1/2 x 1 1/4	1/2	16.0	1	91.62
194	8	2 x 1 1/2	1/2	16.0	1	91.62

MADE IN U.S.A.

Well Seal

Double Drop Pipe - Solid Top Plate - Jet Pump

- Class 25 Non toxic lead free painted cast iron.
- Zinc plated steel bolts.
- Double hole.
- 3/4" molded rubber.



Part No	Well Size I.D.	Drop Pipe Size	Vent Tapping	Weight Each lbs.	Carton Quantity	List Price Each
331	4	1 x 3/4	1/2	3.0	6	24.44
332	4	1 x 1	1/2	3.0	6	24.44
333	4	1 1/4 x 1	1/2	3.0	6	24.44
335	4 1/4	1 x 3/4	1/2	3.2	6	24.44
336	4 1/4	1 x 1	1/2	3.2	6	24.44
337	4 1/4	1 1/4 x 1	1/2	3.2	6	24.44
382	5	1 x 3/4	1/2	5.0	6	38.36
383	5	1 1/4 x 1	1/2	5.0	6	38.36
384	5	1 1/4 x 1 1/4	1/2	5.0	6	38.36
385	5 5/8	1 x 3/4	1/2	7.0	6	34.91
386	5 5/8	1 1/4 x 1	1/2	7.0	6	34.91
387	5 5/8	1 1/4 x 1 1/4	1/2	6.5	6	34.91
388	5 5/8	1 1/2 x 1 1/4	1/2	6.5	6	34.91
342	6	1 x 3/4	1/2	8.0	6	35.77
343	6	1 x 1	1/2	8.0	6	35.77
344	6	1 1/4 x 1	1/2	8.0	6	35.77
345	6	1 1/4 x 1 1/4	1/2	8.0	6	35.77
346	6	1 1/2 x 1 1/4	1/2	7.5	6	35.77
347	6	2 x 1 1/2	1/2	7.5	6	35.77
348	6 1/4	1 x 3/4	1/2	8.0	6	35.77
349	6 1/4	1 x 1	1/2	8.0	6	35.77
350	6 1/4	1 1/4 x 1	1/2	8.0	6	35.77
351	6 1/4	1 1/4 x 1 1/4	1/2	7.5	6	35.77
352	6 1/4	1 1/2 x 1 1/4	1/2	7.5	6	35.77
353	6 1/4	2 x 1 1/2	1/2	7.5	6	35.77



Top Guide

- 3/4" molded rubber.

Well I.D.	List Price Each
2	4.15
3	4.15
4	4.15
4 1/4	4.96
4 1/2	4.96
5	4.96
5 5/8	6.71
6	6.71
6 1/4	6.71
6 5/8	6.71
8	20.09
10	24.12
12	24.12

Specify Drop Pipe Size



Well Seal Vent

- PVC.

Part No.	Thread Size	Weight Each lbs.	List Price Each
750	1/2	.12	3.98

MADE IN U.S.A.



Well Seal

Single Drop Pipe - Split Top Plate

- Class 25 Non-toxic lead free painted cast iron.
- Zinc plated steel bolts.
- Single hole.
- 3/4" molded rubber.
- With eye bolt.

Packaging - All Seals

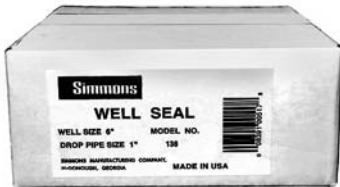

All well seals are individually boxed...

...then packed 6 per master carton.

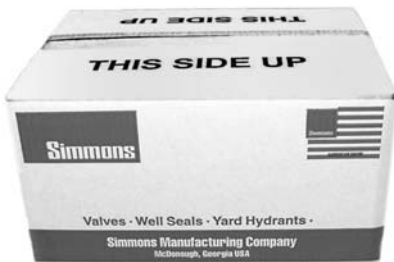

Part No.	Well Size I.D.	Drop Pipe Size	Cable Hole Tapping	Vent Tapping	Weight Each lbs.	Carton Quantity	List Price Each
208	3	1	3/8	1/8	2.0	1	25.06
210	4	3/4	3/4	1/2	3.5	6	27.76
211	4	1	3/4	1/2	3.5	6	26.14
212	4	1 1/4	3/4	1/4	3.5	6	26.14
215	4 1/4	3/4	3/4	1/2	3.5	6	27.76
216	4 1/4	1	3/4	1/2	3.5	6	26.14
217	4 1/4	1 1/4	3/4	1/4	3.5	6	26.14
220	5	3/4	1	1/2	6.0	6	40.64
221	5	1	1	1/2	6.0	6	40.64
222	5	1 1/4	1	1/2	6.0	6	40.64
223	5	1 1/2	1	1/2	5.0	6	40.64
224	5	2	3/4	1/2	5.0	6	40.64
230	5 5/8	3/4	3/4	1/2	7.5	6	39.27
231	5 5/8	1	3/4	1/2	7.5	6	39.27
232	5 5/8	1 1/4	3/4	1/2	7.0	6	39.27
233	5 5/8	1 1/2	3/4	1/2	7.0	6	39.27
234	5 5/8	2	3/4	1/2	7.0	6	39.27
235	6	3/4	1	1/2	8.0	6	39.85
236	6	1	1	1/2	8.0	6	39.85
237	6	1 1/4	1	1/2	8.0	6	39.85
238	6	1 1/2	1	1/2	8.0	6	39.85
239	6	2	1	1/2	8.0	6	39.85
240	6 1/4	3/4	1	1/2	8.0	6	39.85
241	6 1/4	1	1	1/2	8.0	6	39.85
242	6 1/4	1 1/4	1	1/2	8.0	6	39.85
243	6 1/4	1 1/2	1	1/2	8.0	6	39.85
244	6 1/4	2	1	1/2	8.0	6	39.85
245	6 5/8	1	3/4	1/2	10.0	6	48.23
246	6 5/8	1 1/4	3/4	1/2	10.0	6	48.23
247	6 5/8	1 1/2	3/4	1/2	10.0	6	48.23
248	6 5/8	2	3/4	1/2	10.0	6	48.23
296	8	1	1	1/2	16.0	1	95.68
297	8	1 1/4	1	1/2	16.0	1	95.68
298	8	1 1/2	1	1/2	16.0	1	95.68
299	8	2	1	1/2	16.0	1	95.68

MADE IN U.S.A.



ABS Well Seals - Single Hole - Solid Top

- ABS material.
- Zinc plated steel bolts.
- 3/4" molded rubber.
- 1" cable hole, except as noted.*
- Individually boxed.

Packaging - All Seals

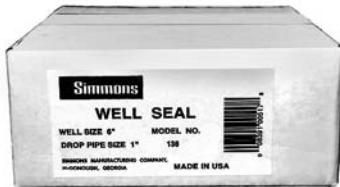

All well seals are individually boxed...

...then packed 6 per master carton.

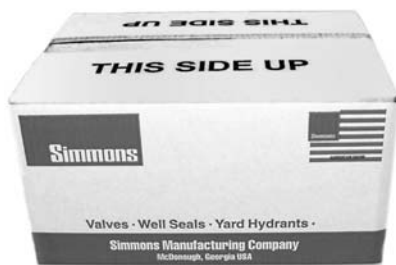

Part No.	Well Size I.D.	Drop Pipe Size	Vent Tapping	Weight Each lbs.	Carton Quantity	List Price Each
1900	4	3/4	1/2	1.50	6	19.53
1901	4	1	1/2	1.50	6	19.17
1902	4	1 1/4	1/4	1.50	6	19.17
1903	4	1 1/2	1/4	1.50	6	19.17
*1904	4	2	1/4	1.50	6	19.17
1910	4 1/4	3/4	1/2	1.75	6	20.28
1911	4 1/4	1	1/2	1.75	6	19.91
1912	4 1/4	1 1/4	1/4	1.75	6	19.91
1913	4 1/4	1 1/2	1/4	1.75	6	19.91
*1914	4 1/4	2	1/4	1.75	6	19.91
1920	5	3/4	1/2	2.75	6	26.30
1921	5	1	1/2	2.75	6	26.30
1922	5	1 1/4	1/2	2.75	6	26.30
1923	5	1 1/2	1/4	2.75	6	26.30
1924	5	2	1/4	2.75	6	26.30
1930	5 5/8	3/4	1/2	3.00	6	28.23
1931	5 5/8	1	1/2	3.00	6	28.23
1932	5 5/8	1 1/4	1/2	3.00	6	28.23
1933	5 5/8	1 1/2	1/4	3.00	6	28.23
1934	5 5/8	2	1/4	3.00	6	28.23
1940	6	3/4	1/2	3.00	6	28.56
1941	6	1	1/2	3.00	6	28.56
1942	6	1 1/4	1/2	3.00	6	28.56
1943	6	1 1/2	1/2	3.00	6	28.56
1944	6	2	1/2	3.00	6	28.56
1950	6 1/4	3/4	1/2	3.25	6	28.56
1951	6 1/4	1	1/2	3.25	6	28.56
1952	6 1/4	1 1/4	1/2	3.25	6	28.56
1953	6 1/4	1 1/2	1/2	3.25	6	28.56
1954	6 1/4	2	1/2	3.25	6	28.56

*1/2" cable hole.

MADE IN U.S.A.

ABS Well Seals - Double Hole - Solid Top

- ABS material.
- Zinc plated steel bolts.
- 3/4" molded rubber.
- Individually boxed.



Part No.	Well Size I.D.	Drop Pipe Size	Vent Tapping	Weight Each lbs.	Carton Quantity	List Price Each
1905	4	1 1/4 x 1	1/2	1.50	6	18.33
1915	4 1/4	1 1/4 x 1	1/2	1.50	6	18.66
1925	5	1 1/4 x 1	1/2	2.00	6	26.17
1935	5 5/8	1 1/4 x 1	1/2	2.25	6	27.96
1936	5 5/8	1 1/4 x 1 1/4	1/2	2.25	6	27.96
1945	6	1 1/4 x 1	1/2	2.25	6	28.23
1946	6	1 1/4 x 1 1/4	1/2	2.25	6	28.23
1955	6 1/4	1 1/4 x 1	1/2	2.25	6	28.23
1956	6 1/4	1 1/4 x 1 1/4	1/2	2.25	6	28.23

Well Seal - Single Drop Pipe - Slotted Cable Hole

- Class 25 Non-toxic lead free painted cast iron.
- Zinc plated steel bolts.
- Single Hole.
- 3/4" molded rubber.
- 3/8" x 1 1/8" slotted cable hole.



Part No.	Well Size I.D.	Drop Pipe Size	Vent Tapping	Weight Each lbs.	Carton Quantity	List Price Each
111-S	4	1	1/2	3.50	6	23.38
112-S	4	1 1/4	1/4	3.50	6	23.38
113-S	4	1 1/2	1/4	3.00	6	24.31
114-S	4	2	1/4	3.00	6	24.31

MADE IN U.S.A.



Heavy Duty Well Seals

- Heavy duty Class 25 Non-toxic lead free painted cast iron.
- Recommended for very deep settings where extra strength may be required.
- Individually boxed.
- 3/4" molded rubber.
- Zinc plated steel bolts.

Packaging - All Seals

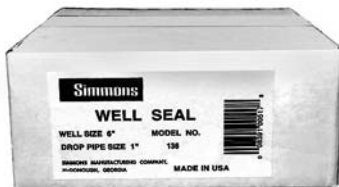

All well seals are individually boxed.



Parts No.	Well Size I.D.	Drop Pipe Size	Cable Hole Tapping	Vent Tapping	Weight Each lbs.	Carton Quantity	List Price Each
060	6	2	1	1/2	11.0	1	86.14
*061	6	3	1	1/2	9.0	1	86.14
**062	6	4		1/2	8.5	1	86.14
063	6 1/4	2	1	1/2	11.0	1	86.14
*064	6 1/4	3	1	1/2	9.0	1	86.14
**065	6 1/4	4		1/2	8.5	1	86.14
069	8	2	1	1/2	20.0	1	214.09
070	8	3	1	1/2	19.0	1	214.09
071	8	4	1	1/2	18.0	1	214.09
072	8	5	1	1/2	17.0	1	214.09
080	10	3	1	1/2	42.0	1	246.06
081	10	4	1	1/2	40.5	1	246.06
082	10	5	1	1/2	39.0	1	246.06
083	10	6	1	1/2	37.5	1	246.06
090	12	3	1	1/2	59.0	1	260.84
091	12	4	1	1/2	57.0	1	260.84
092	12	5	1	1/2	55.0	1	260.84
093	12	6	1	1/2	53.0	1	260.84

*Offset Drop Pipe.

**Two - 1/2" Cable Holes / Offset Drop Pipe.

MADE IN U.S.A.

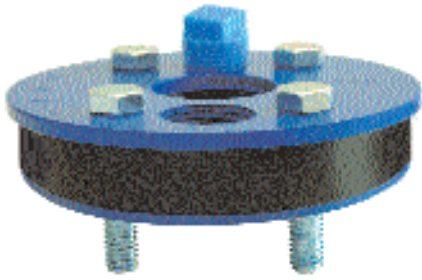

Steel Well Seal

Single Drop Pipe - Solid Top - Submersible Pump

- A36 hot roll steel.
- Zinc plated steel bolts.
- Single Hole.
- 3/4" molded rubber.
- Powder coated polyester finish.
- Individually boxed.

Part Number	Well Size I.D.	Drop Pipe Size	Cable Hole Tapping	Vent Tapping	Top Plate	Max. Load	Weight Each lbs.	Carton Quantity	List Price Each
3501	4	1	3/4	1/2	3/16	2,100	2.00	6	27.80
3502	4	1 1/4	3/4	1/2	3/16	2,100	2.00	6	27.80
3503	4	Offset 1 1/4	1	1/2	3/16	2,100	2.00	6	27.80
3504	4	1 1/2	3/4	1/2	3/16	2,100	2.00	6	27.80
3505	4	2	1/2	1/4	3/16	2,100	2.00	6	33.75
3511	4 1/4	1	3/4	1/2	3/16	2,100	2.00	6	27.80
3512	4 1/4	1 1/4	3/4	1/2	3/16	2,100	2.00	6	27.80
3513	4 1/4	Offset 1 1/4	1	1/2	3/16	2,100	2.00	6	27.80
3514	4 1/4	1 1/2	3/4	1/2	3/16	2,100	2.00	6	27.80
3515	4 1/4	2	1/2	1/4	3/16	2,100	2.00	6	33.75
3521	5	1	1	1/2	3/16	1,500	2.75	6	34.12
3522	5	1 1/4	1	1/2	3/16	1,500	2.75	6	34.12
3523	5	1 1/2	3/4	1/2	3/16	1,500	2.75	6	34.12
3524	5	2	3/4	1/2	3/16	1,500	2.75	6	38.30
3531	6	1	1	1/2	3/16	1,100	4.00	6	39.20
3532	6	1 1/4	1	1/2	3/16	1,100	4.00	6	39.20
3533	6	1 1/2	1	1/2	3/16	1,100	4.00	6	39.20
3534	6	1	1	1/2	3/8	9,000	4.00	1	74.50
3535	6	1 1/4	1	1/2	3/8	9,000	4.00	1	74.50
3536	6	1 1/2	1	1/2	3/8	9,000	4.00	1	74.50
3537	6	2	1	1/2	3/8	9,000	4.00	1	74.50
3538	6	3	1	1/2	3/8	9,000	4.00	1	74.50
3539	6	4	2 - 1/2	1/2	3/8	9,000	4.00	1	74.50
3541	6 1/4	1	1	1/2	3/16	1,100	4.00	6	39.20
3542	6 1/4	1 1/4	1	1/2	3/16	1,100	4.00	6	39.20
3543	6 1/4	1 1/2	1	1/2	3/16	1,100	4.00	6	39.20
3544	6 1/4	1	1	1/2	3/8	9,000	4.00	1	74.50
3545	6 1/4	1 1/4	1	1/2	3/8	9,000	4.00	1	74.50
3546	6 1/4	1 1/2	1	1/2	3/8	9,000	4.00	1	74.50
3547	6 1/4	2	1	1/2	3/8	9,000	4.00	1	74.50
3548	6 1/4	3	1	1/2	3/8	9,000	4.00	1	74.50
3549	6 1/4	4	2 - 1/2	1/2	3/8	9,000	4.00	1	74.50

MADE IN U.S.A.

Steel Well Seal

Single Drop Pipe - Solid Top - Submersible Pump

- A36 hot roll steel.
- Zinc plated steel bolts.
- Single Hole.
- 3/4" molded rubber.
- Powder coated polyester finish.
- Individually boxed.
- 8", 10", and 12" seals are heavy duty.

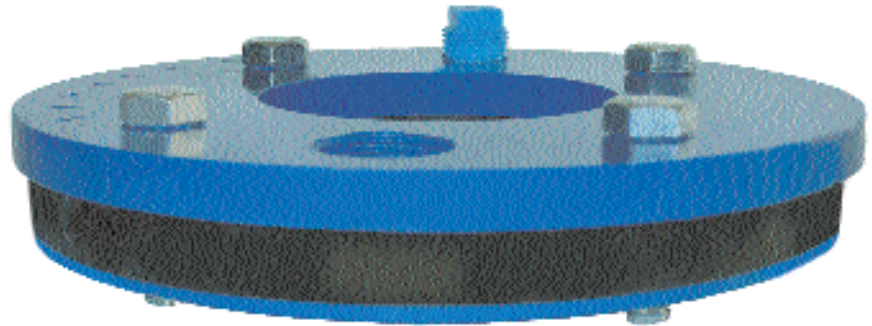

Part Number	Well Size I.D.	Drop Pipe Size	Cable Hole Tapping	Vent Tapping	Top Plate	Max. Load	Weight Each lbs.	Carton Quantity	List Price Each
3551	8	1	1	1/2	3/8	6,900	7.25	1	85.10
3552	8	1 1/4	1	1/2	3/8	6,900	7.25	1	85.10
3553	8	1 1/2	1	1/2	3/8	6,900	7.25	1	85.10
3554	8	2	1	1/2	3/8	6,900	7.25	1	85.10
3555	8	3	1	1/2	1/2	12,000	7.25	1	115.23
3556	8	4	1	1/2	5/8	27,000	7.25	1	115.23
3561	10	1	1	1/2	3/8	3,800	17.00	1	125.34
3562	10	1 1/4	1	1/2	3/8	3,800	17.00	1	125.34
3563	10	1 1/2	1	1/2	3/8	3,800	17.00	1	135.50
3564	10	2	1	1/2	3/8	3,800	17.00	1	135.50
3565	10	3	1	1/2	5/8	16,500	17.00	1	153.32
3566	10	4	1	1/2	5/8	16,500	17.00	1	161.06
3567	10	5	1	1/2	3/4	32,000	17.00	1	175.76
3568	10	6	1	1/2	3/4	34,000	17.00	1	175.76
3571	12	1	1	1/2	3/8	2,800	26.00	1	153.78
3572	12	1 1/4	1	1/2	3/8	2,800	26.00	1	165.38
3573	12	1 1/2	1	1/2	3/8	2,800	26.00	1	165.38
3574	12	2	1	1/2	1/2	6,600	26.00	1	175.81
3575	12	3	1	1/2	5/8	12,000	26.00	1	228.94
3576	12	4	1	1/2	5/8	12,000	26.00	1	228.94
3577	12	5	1	1/2	3/4	22,000	26.00	1	260.50
3578	12	6	1	1/2	3/4	22,000	26.00	1	260.50

MADE IN U.S.A.

Deluxe Frost-Proof Yard Hydrant **



All Simmons Yard Hydrants are Individually Boxed.

- All Simmons Yard Hydrants have Cast Iron Head and Handle...with Blue Polyester Powder Coated Finish.
- All Simmons Yard Hydrants are Individually Boxed.
- Many Parts and Accessories are Common for all Models.
- Refer to 3/4" Flow Rate Chart...Page 26.

Part No.	Bury Depth	Weight Each lbs.	List Price Each
800	1	12.5	82.57
801	1 1/2	14.5	84.33
802	2	15.5	86.11
803	3	18.5	92.00
804	4	21.5	97.91
805	5	23.5	103.58
806	6	25.5	110.03
807	7	27.5	117.56
808	8	28.5	123.55

**** Contains Lead, Not for sale in California.**

Yard Hydrant Accessories

Part No.	Size	Name of Part	List Price Each
860	-	Support Bar	5.27
870	3/4"	Brass 90° Ell 3/4" MPT x 3/4" Insert	10.43
880	3/4"	Brass Backflow Preventer	13.65



880 Backflow Preventer is approved by ASSE Standard 1011 and listed by IAPMO.

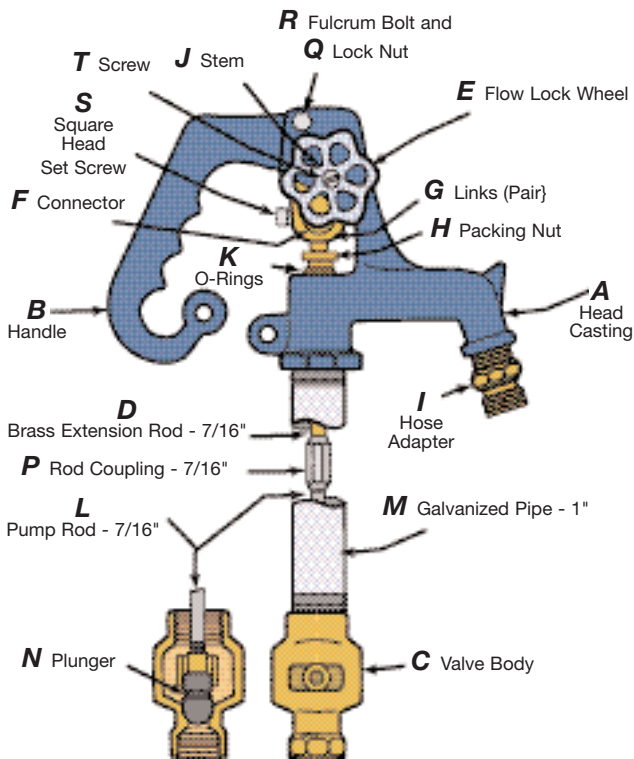

Yard Hydrant Parts

Ref.	Part No.	Name of Part	List Price Each
	850	Parts Kit	17.25
	840	Head Complete	38.08
A	8820	Head	27.88
B	8821	Handle	9.07
C	8822	Valve Body	27.11
D	8823	Brass Extension Rod, 7/16"	5.10
E	8824*	Flow Lock Wheel	1.74
F	8825•	Brass Connector	13.53
G	8826•	Brass Links (Price per Pair)	7.18
H	8847•	Brass Packing Nut	4.77
I	8828	Brass Hose Adapter	5.10
J	8829*	Brass Stem, Square Head	1.99
K	8839•	Buna-N "O" Rings (Price per Pair)	1.74
L	8814	Pump Rod, 7/16"	**
M	8815	Galvanized Pipe Casing, 1"	**
N	8833•	Plunger (One Piece)	5.81
P	8834	Rod Coupling, 7/16"	2.64
Q	8301•	Stainless Steel Lock Nut	.56
R	8836•	Fulcrum Bolt Stainless Steel	1.94
S	8837•	Square Head Set Screw St. Steel	1.02
T	8610*	Screw for Flow Lock Wheel	.62

Parts Kit...

(Same for all Simmons Yard Hydrants).



• Included in Parts Kit. Refer to Parts Kit photo at left.
 *These parts make up the flow lock wheel assembly.
 **Price on Request, Consult Factory.

MADE IN U.S.A.

Premier Frost-Proof Yard Hydrant **

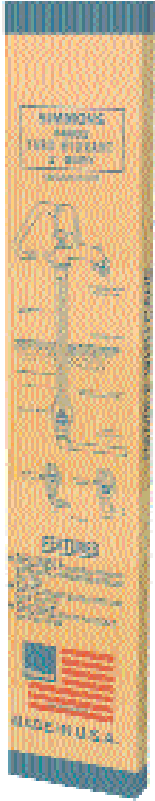

- All components are identical to 800 Series except head casting, handle and flow lock wheel.
- Polyester powder coated finish.
- Individually boxed.
- Refer to 3/4" Flow Rate Chart...Page 26.

**SIMMONS
SUPERIOR PACKAGING**

Part No.	Bury Depth	Weight Each lbs.	List Price Each
4800	1	11.5	78.32
4801	1 1/2	14.0	80.14
4802	2	14.5	81.81
4803	3	17.0	87.29
4804	4	20.0	93.02
4805	5	22.5	98.44
4806	6	24.0	104.48
4807	7	25.5	111.68
4808	8	27.0	117.24

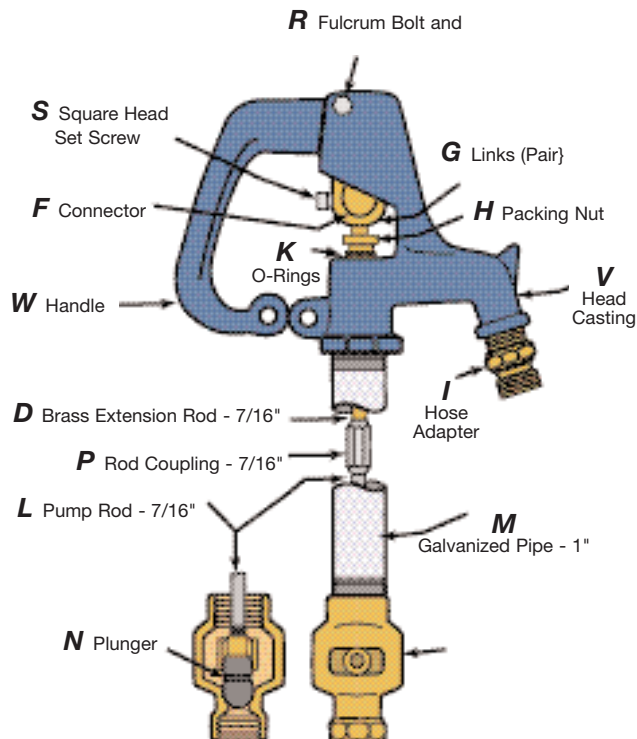

Premier Yard Hydrant Parts

Ref.	Part No.	Name of Part	List Price Each
	850	Parts Kit	17.25
	890	Head Complete	37.06
V	8891	Head	26.53
W	8892	Handle	8.37
C	8822	Valve Body	27.11
D	8823	Brass Extension Rod 7/16"	5.10
F	8825•	Brass Connector	13.53
G	8826•	Brass Links (Price per Pair)	7.18
H	8847•	Brass Packing Nut	4.77
I	8828	Brass Hose Adapter	5.10
K	8839•	Buna-N "O" Rings (Price per Pair)	1.74
L	8814	Pump Rod, 7/16"	**
M	8815	Galvanized Pipe Casing, 1"	**
N	8833•	Plunger (One Piece)	5.81
P	8834	Rod Coupling, 7/16"	2.64
Q	8301•	Stainless Steel Lock Nut	.56
R	8836•	Fulcrum Bolt Stainless Steel	1.94
S	8837•	Square Head Set Screw St. Steel	1.02

•Included in Parts Kit.

** Price on Request, Consult Factory.

MADE IN U.S.A.

****Contains Lead, Not for sale in California.**

LEAD FREE* Deluxe Frost-Proof Yard Hydrant



**SIMMONS
SUPERIOR PACKAGING**

- Cast iron head and handle.
 - Galvanized pipe.
 - Silicon bronze by-pass valve.
 - Stainless steel extension rod.
 - Aluminum hose adapter.
 - Polyester powder coated finish.
 - Individually Boxed.
- | Part No. | Bury Depth | Weight Each lbs. | List Price Each |
|----------|------------|------------------|-----------------|
| 800SB | 1 | 12.5 | 94.00 |
| 801SB | 1 1/2 | 14.5 | 96.98 |
| 802SB | 2 | 15.5 | 98.98 |
| 803SB | 3 | 18.5 | 107.00 |
| 804SB | 4 | 21.5 | 114.00 |
| 805SB | 5 | 23.5 | 119.00 |
| 806SB | 6 | 25.5 | 126.50 |
| 807SB | 7 | 27.5 | 136.50 |
| 808SB | 8 | 28.5 | 147.50 |

3/4" Flow Rates: (For All Simmons Yard Hydrant Models)

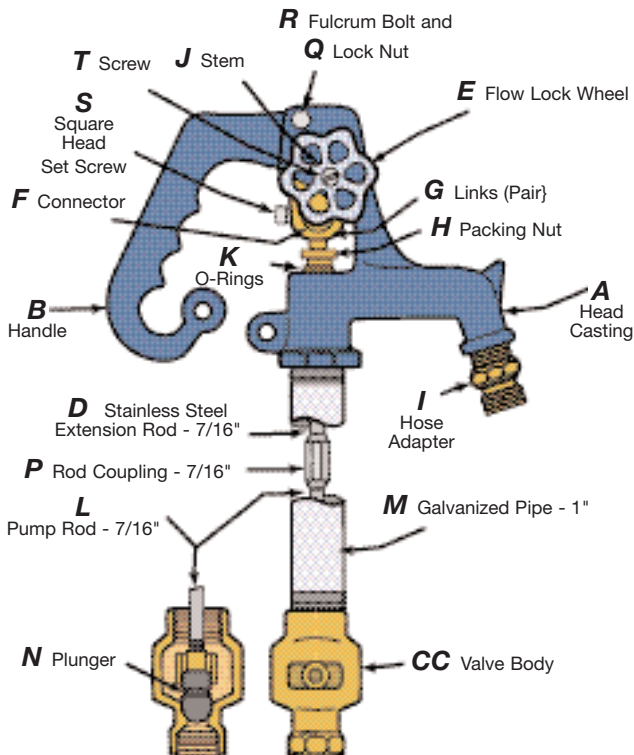
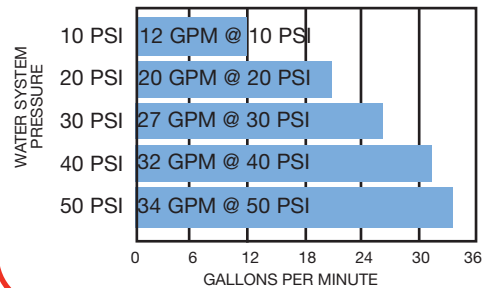

Lead Free Hydrant - Parts

Ref.	Part No.	Name of Part	List Price Each
	850SB	Parts Kit	18.50
	840	Head Complete	38.08
A	8820	Head	27.88
B	8821	Handle	9.07
CC	8822SB	Silicon Bronze Valve Body	28.98
D	8843	Stainless Steel Extension Rod 7/16"	5.98
E	8824*	Flow Lock Wheel	1.74
F	8825•	Brass Connector	13.53
G	8826•	Brass Links (Price per Pair)	7.18
H	8847•	Brass Packing Nut	4.77
I	8844	Aluminum Hose Adapter	5.40
J	8829*	Brass Stem, Square Head	1.99
K	8839•	Buna-N "O" Rings (Price per Pair)	1.74
L	8814	Pump Rod, 7/16"	**
M	8815	Galvanized Pipe Casing, 1"	**
N	8842•	Plunger (One Piece)	6.98
P	8834	Rod Coupling, 7/16"	2.64
Q	8301•	Stainless Steel Lock Nut	.56
R	8836•	Fulcrum Bolt Stainless Steel	1.94
S	8837•	Square Head Set Screw St. Steel	1.02
T	8610*	Screw for Flow Lock Wheel	.62

• Included in Parts Kit.

* These parts make up the flow lock wheel assembly.

**Prices on Request, Consult Factory.

***Silicon bronze components contain less than .05% (1/20 of 1%) Lead.**

MADE IN U.S.A.

Sanitary Frost-Proof Yard Hydrant **

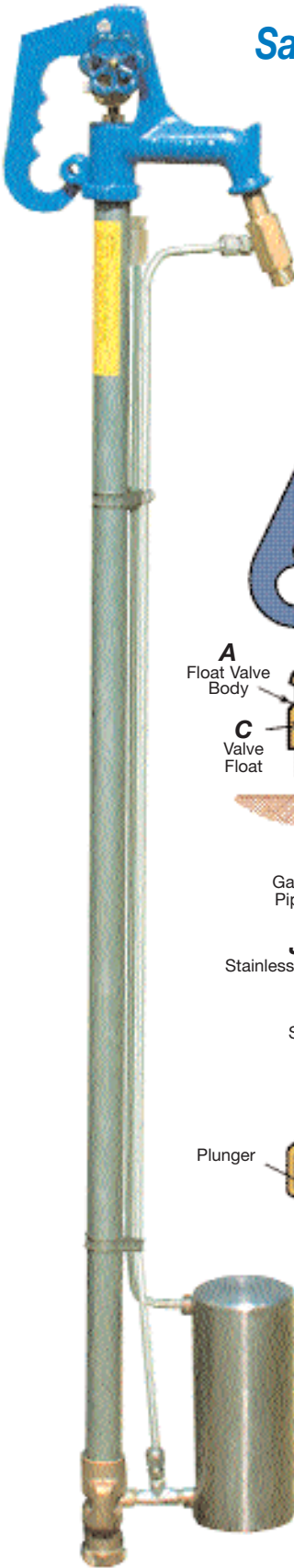

- Cast Iron Head & Handle.
- Stainless Steel Cannister.
- Fully Self-Contained.
- Sanitary - Prevents Cross Contamination.
- Individually Boxed.

Part No.	Bury Depth	Weight	List Price Each
6800	1 ft.	16 lb.	552.85
6802	2 ft.	18 lb.	562.22
6803	3 ft.	20 lb.	571.59
6804	4 ft.	22 lb.	580.96
6805	5 ft.	24 lb.	590.33
6806	6 ft.	26 lb.	599.70
6807	7 ft.	28 lb.	609.07
6808	8 ft.	30 lb.	618.44

See Page 46 for additional Sanitary Yard Hydrant specifications and details.

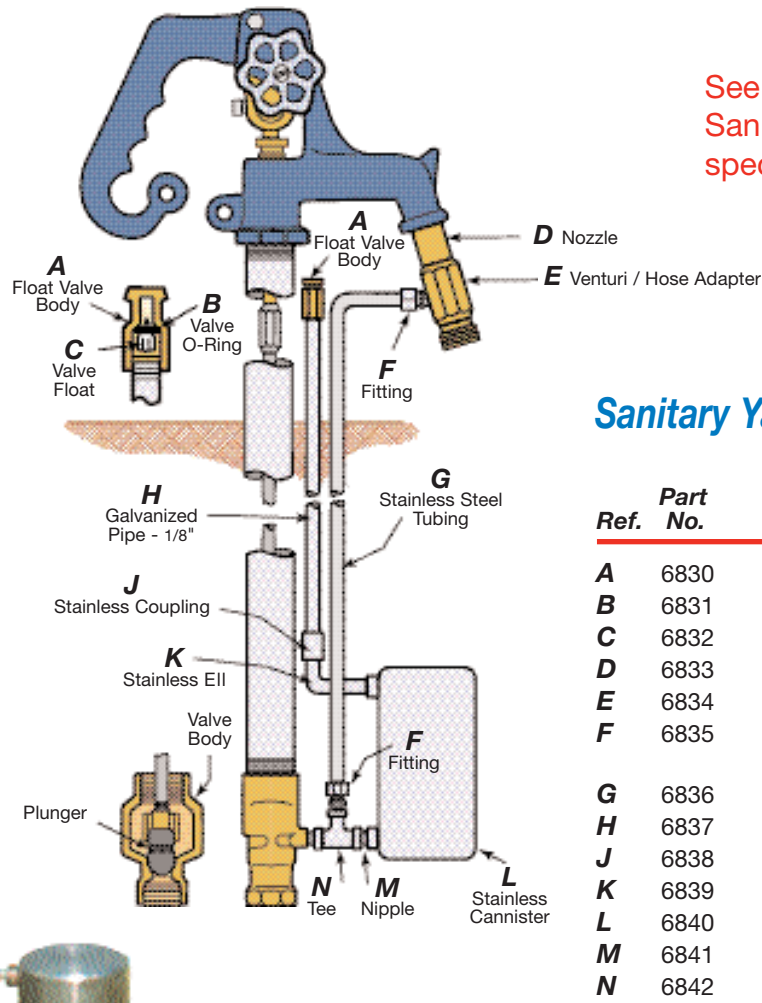

Sanitary Yard Hydrant Parts

Ref.	Part No.	Name of Part
A	6830	Valve Float Body
B	6831	O-Ring for Valve
C	6832	Valve Float
D	6833	Nozzle
E	6834	Venturi / Hose Adapter
F	6835	3/8 x 1/8 NPT 3-Piece Compression Fitting
G	6836	3/8" Stainless Steel Tubing
H	6837	1/8" Galvanized Pipe
J	6838	1/8" Stainless Steel Coupling
K	6839	1/8" Stainless Steel Ell
L	6840	Stainless Steel Cannister
M	6841	1/8" Stainless Steel Nipple
N	6842	1/8" Stainless Steel Tee

Consult factory for parts pricing.

Consult 800 Series parts list for any parts not listed in the diagram above.

****Contains Lead, Not for sale in California.**

MADE IN U.S.A.



754



760-1

MADE IN U.S.A.

Well Cap --- Painted

- Painted cast iron.
- Conduit type.
- Individually boxed.
- Non Toxic Lead Free Paint.

Part No.	Well Casing I.D.	Weight Each lbs.	Carton Quantity	List Price Each
751	4	2.25	1	14.64
752	5	3.50	1	19.97
753	5 5/8	3.75	1	19.78
754	6 - 6 1/4	4.00	1	20.45
755	6 5/8	4.50	1	24.34
756	8	5.50	1	29.53
757	10	7.75	1	33.52
760-1	5 5/8 - 6 1/4	4.33	1	17.07



763

MADE IN U.S.A.

Well Cap --- Galvanized

- Galvanized cast iron.
- Conduit type.
- Individually boxed.

Part No.	Well Casing I.D.	Weight Each lbs.	Carton Quantity	List Price Each
760	4	2.25	1	17.85
761	5	3.50	1	23.26
762	5 5/8	3.75	1	23.03
763	6 - 6 1/4	4.00	1	22.18
764	6 5/8	4.75	1	25.86
765	8	6.00	1	32.01
766	10	7.00	1	37.67



758

Watertight Well Cap --- Import

- Heavy Duty Cast Iron.
- 5 Bolt Construction.
- 1/4" Grounding Lug.
- 9/16" Screened Vent.
- Non Toxic Lead Free Paint.
- Individually boxed.
- 1" NPT Conduit Connection.

Part No.	Nominal Well Size	Weight Each lbs.	Casing I.D.	List Price Each
758	6" & 6 1/4"	11.60	6 5/8"	54.68

702



Tank Tee **

- Bronze.

Part No.	Tank Leg Length Inches	Tapping Each Leg FxM	Tank Connection Tapping FxM	Female Tapping Top of Cross	Three Female Tappings on Side	Weight Each lbs.	Carton Quantity	List Price Each
702	3	1x1 1/4	1x1 1/4	-	1/4 each	1.75	12	25.52

700



Tank Cross **

- Bronze.

Part No.	Tank Leg Length Inches	Tapping Each Leg FxM	Tank Connection Tapping FxM	Female Tapping Top of Cross	Female Tappings on Side	Weight Each lbs.	Carton Quantity	List Price Each
700	3	3/4x1	1x1 1/4	one-1/2	three-1/4	1.25	12	25.71
701	3	1x1 1/4	1x1 1/4	one-3/4	three-1/4	1.75	12	31.25
710	4	3/4x1	1	two-1/2	two-1/4	1.50	12	24.25
711	4	1x1 1/4	1x1 1/4	two-3/4	two-1/4	1.50	12	32.96
712	4	3/4x1	1x1 1/4	two-3/4	two-1/4	1.25	12	27.23
* 7010	4	3/4x1	1	two-3/4	two-1/4	1.25	12	27.40
** 7011	4	3/4x1	1 1/4	two-3/4	two-1/4	1.25	12	27.98

710



712



*Fits 1" Flexcon on-line Tank.
**Fits 1 1/4" Flexcon on-line Tank.

Short Tank Cross - Cast **

- Bronze.

Part No.	Tank Leg Length Inches	Tapping Each Leg FxM	Tank Connection Tapping FxM	Female Tapping Top of Cross	Two Female Tappings on Side	Weight Each lbs.	Carton Quantity	List Price Each
735	1	3/4x1	1x-	one-1/2	1/4	1.25	12	17.13
736	1	3/4x1	1x-	two-1/2	1/4	1.25	12	17.62

735



703



Long Tank Cross - Cast **

- Bronze.

Part No.	Tank Leg Length Inches	Tapping Each Leg FxM	Tank Connection Tapping FxM	Female Tapping Top of Cross	Two Female Tappings on Side	Weight Each lbs.	Carton Quantity	List Price Each
703	10	3/4x1	-x1	one-1/2	1/4	2.50	12	29.54
708	10	3/4x1	-x1	two-1/2	1/4	2.50	12	30.87

708



**** Contains Lead,
Not for sale in California.**

MADE IN U.S.A.

Long Tank Cross - Fabricated **

- Bronze cross.
- Copper pipe.
- Lead-free solder.



709



704



715



4711



745

Part No.	Tank Leg Length	Tapping Each Leg FxM	Tank Connection Tapping FxM	Female Tapping Top of Cross	Two Female Tappings on Side	Weight Each lbs.	Carton Quantity	List Price Each
705	10	3/4 x 1	-x 1	one-1/2	1/4	1.75	12	31.16
709	10	3/4 x 1	-x 1	two-1/2	1/4	2.00	12	30.90
717	13	3/4 x 1	-x 1	one-1/2	1/4	2.50	12	35.51
707	13	3/4 x 1	-x 1	two-1/2	1/4	2.50	12	35.51
7000	16	3/4 x 1	-x 1 1/4	two-1/2	1/4	2.50	6	41.30
704	13	1 x 1 1/4	-x 1 1/4	one-3/4	1/4	2.50	12	38.89
713	13	1 x 1 1/4	-x 1 1/4	two-3/4	1/4	2.50	12	37.98
706	16	1 x 1 1/4	-x 1 1/4	one-3/4	1/4	2.75	6	41.30
714	16	1 x 1 1/4	-x 1 1/4	two-3/4	1/4	2.75	6	39.60
*715	5 1/4	3/4 x 1	1x-	two-1/2	1/4	2.00	12	30.37
*716	5 1/4	3/4 x 1	1x-	one-1/2	1/4	2.00	12	31.08
*719	4 1/2	1 x 1 1/4	1 1/4x-	two-3/4	1/4	2.25	12	42.88
*737	2 1/2	1 x 1 1/4	1 1/4x-	one-3/4	1/4	2.00	12	40.01
*738	2 1/2	1 x 1 1/4	1 1/4x-	two-3/4	1/4	2.00	12	40.01

*Female fitting at tank connection

Tank Cross - Cast **

- Tank head only.
- Sweat connection on tank side.
- Bronze cross.

Part No.	Tank Leg Length Inches	Tapping Each Leg FxM	Tank Connection Tapping FxM	Female Tapping Top of Cross	Two Female Tappings on Side	Weight Each lbs.	Carton Quantity	List Price Each
4711	1	3/4 x 1	1 Sweat	one-1/2	1/4	.75	1	16.91
4713	1	1 x 1 1/4	1 1/4 Sweat	one-3/4	1/4	1.25	1	19.51
4716	1	3/4 x 1	1 Sweat	two-1/2	1/4	.75	1	17.41
4717	1	1 x 1 1/4	1 1/4 Sweat	two-3/4	1/4	1.25	1	19.71

Tank Cross - Fabricated - with Union **

- Bronze Cross.
- Copper pipe.
- Lead-free solder.

Part No.	Tank Leg Length	Tapping Each Leg FxM	Tank Connection Tapping FxM	Female Tapping Top of Cross	Two Female Tappings on Side	Weight Each lbs.	Carton Quantity	List Price Each
748	13	3/4 x 1	-x1	one-1/2	1/4	2.25	12	43.67
745	13	3/4 x 1	-x1	two-1/2	1/4	2.25	12	43.67
749	13	1 x 1 1/4	-x1 1/4	one-3/4	1/4	3.50	6	71.55
746	13	1 x 1 1/4	-x1 1/4	two-3/4	1/4	3.50	6	71.55
7040	16	1 x 1 1/4	-x1 1/4	one-3/4	1/4	3.50	6	74.20
747	16	1 x 1 1/4	-x1 1/4	two-3/4	1/4	3.50	6	74.20

Fabricated Tank Crosses available in LEAD FREE SILICON BRONZE upon request.

**** Contains Lead, Not for sale in California.**

MADE IN U.S.A.

Elevated Tank Cross - Fabricated - with Union **

- Bronze cross.
- Copper pipe.
- Lead-free solder.

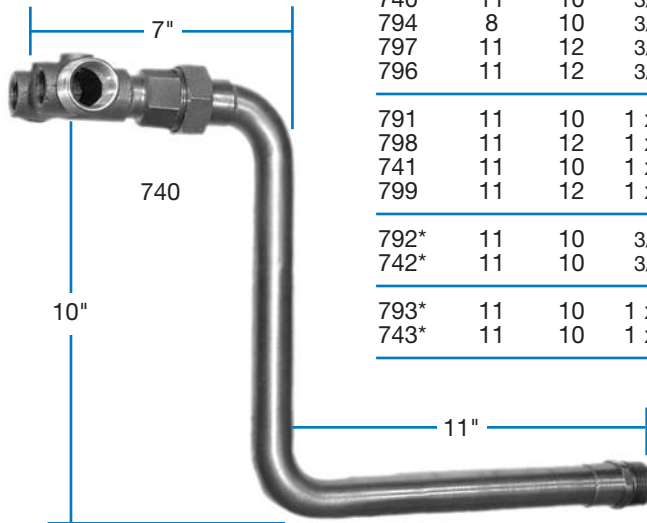

Part No.	Tank Leg Length	Height	Tapping Each Leg FxM	Tank Connection Tapping FxM	Female Tapping Top of Cross	Two Female Tappings On Side	Weight Each lbs.	Carton Quantity	List Price Each
790	11	10	3/4 x 1	-x1	one-1/2	1/4	3.00	9	51.30
740	11	10	3/4 x 1	-x1	two-1/2	1/4	3.00	9	51.30
794	8	10	3/4 x 1	-x1	one-1/2	1/4	3.00	9	51.30
797	11	12	3/4 x 1	-x1	one-1/2	1/4	3.00	9	53.38
796	11	12	3/4 x 1	-x1	two-1/2	1/4	3.00	9	53.38
791	11	10	1 x 1 1/4	-x1 1/4	one-3/4	1/4	4.75	6	82.35
798	11	12	1 x 1 1/4	-x1 1/4	one-3/4	1/4	4.75	6	84.43
741	11	10	1 x 1 1/4	-x1 1/4	two-3/4	1/4	4.75	6	82.35
799	11	12	1 x 1 1/4	-x1 1/4	two-3/4	1/4	4.75	6	84.43
792*	11	10	3/4 x 1	1x-	one-1/2	1/4	3.00	9	53.73
742*	11	10	3/4 x 1	1x-	two-1/2	1/4	3.00	9	53.73
793*	11	10	1 x 1 1/4	1 1/4x-	one-3/4	1/4	4.75	6	84.85
743*	11	10	1 x 1 1/4	1 1/4x-	two-3/4	1/4	4.75	6	84.85

*Female fitting at tank connection

Elevated Tank Cross - Fabricated - with Union on Rise **

- Bronze cross.
- Copper pipe.
- Lead-free solder.

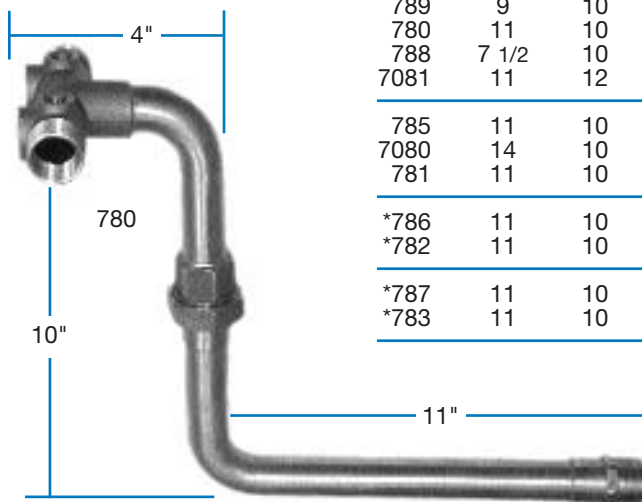

Part No.	Tank Leg Length	Height	Tapping Each Leg FxM	Tank Connection Tapping FxM	Female Tapping Top of Cross	Two Female Tappings on Side	Weight Each lbs.	Carton Quantity	List Price Each
784	11	10	3/4 x 1	-x1	one-1/2	1/4	3.00	9	51.30
789	9	10	3/4 x 1	-x1	one-1/2	1/4	3.00	9	51.30
780	11	10	3/4 x 1	-x1	two-1/2	1/4	3.00	9	51.30
788	7 1/2	10	3/4 x 1	-x1	two-1/2	1/4	3.00	9	51.30
7081	11	12	3/4 x 1	-x1	two-1/2	1/4	3.00	9	53.47
785	11	10	1 x 1 1/4	-x1 1/4	one-3/4	1/4	4.75	6	82.35
7080	14	10	1 x 1 1/4	-x1 1/4	one-3/4	1/4	4.75	6	84.82
781	11	10	1 x 1 1/4	-x1 1/4	two-3/4	1/4	4.75	6	82.35
*786	11	10	3/4 x 1	1x-	one-1/2	1/4	3.00	9	53.73
*782	11	10	3/4 x 1	1x-	two-1/2	1/4	3.00	9	53.73
*787	11	10	1 x 1 1/4	1 1/4x-	one-3/4	1/4	4.75	6	84.85
*783	11	10	1 x 1 1/4	1 1/4x-	two-3/4	1/4	4.75	6	84.85

*Female fitting at tank connection

**** Contains Lead,
Not for sale in California.**

MADE IN U.S.A.

Short Elevated Tank Cross - Fabricated - with Union on Rise **

- Bronze cross.
- Copper pipe.
- Lead-free solder.

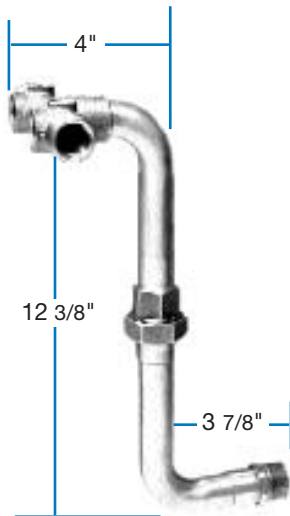

774

Part No.	Tank Leg Length	Height	Tapping Each Leg FxM	Tank Connection Tapping FxM	Female Tapping Top of Cross	Two Female Tappings on Side	Weight Each lbs.	Carton Quantity	List Price Each
*772	3 7/8	12 3/8	3/4 x 1	1x-	one-1/2	1/4	3.00	9	51.30
*770	3 7/8	12 3/8	3/4 x 1	1x-	two-1/2	1/4	3.00	9	51.30
*795	3 7/8	10	3/4 x 1	1x-	two-1/2	1/4	3.00	9	51.30
*773	3 7/8	12 3/8	1 x 1 1/4	1 1/4x-	one-3/4	1/4	4.75	6	82.35
*771	3 7/8	12 3/8	1 x 1 1/4	1 1/4x-	two-3/4	1/4	4.75	6	82.35
775	3 7/8	12 3/8	3/4 x 1	-x1	one-1/2	1/4	3.00	9	51.30
774	3 7/8	12 3/8	3/4 x 1	-x1	two-1/2	1/4	3.00	9	51.30
7070	3 7/8	10	3/4 x 1	-x1	two-1/2	1/4	3.00	9	51.30
**7012	3 7/8	12 3/8	3/4 x 1	1	two-1/2	1/4	2.75	9	34.79
***7013	3 7/8	12 3/8	1 x 1 1/4	1 1/4	two-3/4	1/4	4.50	9	45.83

*Female fitting at tank connection.

**Fits 1" Flexcon on-line Tank.

***Fits 1 1/4 Flexcon on-line Tank.

Tank Packages **



709TP

Package Part No.	Tee	0-100 2" Pressure Gauge	1/2" Boiler Drain	3/4" Boiler Drain	1/4x3 Brass Nipple	30-50* FSG-2 Switch	Relief Valve	Weight Each lbs.	List Price Each
703TP	703	•	•		•	•		4.50	82.44
704TP	704	•		•	•	•		5.50	90.38
705TP	705	•	•		•	•		3.50	83.89
708TP	708	•	•		•	•	•	4.75	95.55
709TP	709	•	•		•	•	•	4.00	94.84
710TP	710	•	•		•	•	•	3.75	88.08
712TP	712	•		•	•	•	•	3.75	83.92
735TP	735	•	•		•	•		3.00	77.70
736TP	736	•	•		•	•	•	3.00	85.13
707TP	707	•	•		•	•	•	4.00	91.12
713TP	713	•		•	•	•	•	6.00	99.23
706TP	706	•		•	•	•		5.50	87.44

- Included in each package



608SB

Package Part No.	Check Valve Included	0-100 2" Gauge	1/4x3 Brass Nipple	1/8" Air Valve	Sq.D* 30-50 Switch	Weight Each lbs.	List Price Each
608SB	601-1"	•	•	•	•	2.75	74.49
609SB	602-1 1/4"	•	•	•	•	3.25	81.10

* 20/40 pressure switches available on request. Packages come unassembled.

**** Contains Lead, Not for sale in California.**

MADE IN U.S.A.

Tank Cross - Cast - Import **

• Bronze.



7203



7208



7245

Part No.	Tank Leg Length Inches	Tapping Each Leg FxM	Tank Connection Tapping FxM	Female Tapping Top of Cross	Two Female Tappings on Side	Weight Each lbs.	Carton Quantity	List Price Each
7203	11	3/4 x 1	-x1	one-1/2	1/4	2.00	24	19.53
7204	14	1 x 1 1/4	-x1 1/4	two-3/4	1/4	3.50	16	35.78
7207	14	3/4 x 1	-x1	two-1/2	1/4	2.00	20	23.05
7208	11	3/4 x 1	-x1	two-1/2	1/4	2.00	24	20.00
7210	4 1/2	3/4 x 1	1	two-1/2	1/4	1.10	40	13.07
7211	4 1/2	3/4 x 1	1 1/4	two-3/4	1/4	1.10	32	16.50
7235*	5 1/2	3/4 x 1	1	two-1/2	1/4	1.70	24	22.03
7237*	5 1/2	1 x 1 1/4	1 x 1 1/4	two-3/4	1/4	2.25	24	29.97
7245*	11	3/4 x 1	-x1	two-1/2	1/4	2.00	20	30.90
7247*	14	1 x 1 1/4	-x1 1/4	two-3/4	1/4	4.00	12	48.25

*With Union



7210



7211



7237

** **Contains Lead, Not for sale in California.**

Tank Cross - Cast - Import

• Galvanized.



720

Part No.	Galvanized Nipple	Female Tapping Each Leg	Female Tapping Top of Cross	Two Female Tappings on Side	Weight Each lbs.	Carton Quantity	List Price Each
720	none	1	3/4	1/4	1.50	1	11.98
725	none	1 1/4	3/4	1/4	2.00	1	21.98
721	1 x 8 & 1/4 x 3	1	3/4	1/4	3.00	1	15.90
726	1 1/4 x 11 & 1/4 x 3	1 1/4	3/4	1/4	2.50	1	26.20

Drive Well Point

- Heavy duty galvanized inner pipe.
- Cast iron point.
- Stainless steel gauze and screen.
- Individually Boxed.



	Stainless Steel Part No.	Gauze	Pipe Length	Pipe Size	Weight Each lbs.	List Price Each
1"	1710-1	60	24	1	4.0	71.03
	1711-1	60	30	1	5.0	77.22
	1712-1	60	36	1	6.0	83.41
	1713-1	80	24	1	4.0	71.03
	1714-1	80	30	1	5.0	77.22
	1715-1	80	36	1	6.0	83.41
1 1/4"	1720-1	60	24	1 1/4	6.0	73.84
	1721-1	60	30	1 1/4	8.0	79.97
	1722-1	60	36	1 1/4	9.5	86.15
	1723-1	60	42	1 1/4	10.0	93.02
	1724-1	60	48	1 1/4	11.0	105.34
	1725-1	60	60	1 1/4	14.0	120.29
	1726-1	80	24	1 1/4	6.0	73.84
	1727-1	80	30	1 1/4	8.0	79.97
	1728-1	80	36	1 1/4	9.0	86.15
	1729-1	80	42	1 1/4	10.0	93.02
	1730-1	80	48	1 1/4	11.0	105.34
	1731-1	80	60	1 1/4	14.0	120.29
	1732-1	100	24	1 1/4	6.0	73.84
	1733-1	100	30	1 1/4	8.0	79.97
	1734-1	100	36	1 1/4	9.0	86.15
	1735-1	100	42	1 1/4	10.0	93.02
	1736-1	100	48	1 1/4	11.0	105.34
	1737-1	100	60	1 1/4	14.0	120.29
1 1/2"	1740-1	60	24	1 1/2	7.0	87.28
	1741-1	60	30	1 1/2	8.0	98.42
	1742-1	60	36	1 1/2	10.0	108.72
	1770-1	60	48	1 1/2	14.0	169.95
	1775-1	60	60	1 1/2	17.0	212.63
	1745-1	80	24	1 1/2	7.0	87.28
1746-1	80	30	1 1/2	8.0	98.42	
1747-1	80	36	1 1/2	10.0	108.72	
2"	1750-1	60	24	2	10.0	112.82
	1751-1	60	30	2	12.0	125.13
	1752-1	60	36	2	14.0	131.21
	1753-1	60	48	2	18.0	169.56
	1754-1	60	60	2	21.0	207.85
	1756-1	80	24	2	10.0	112.82
	1757-1	80	30	2	12.0	125.13
	1758-1	80	36	2	14.0	131.21
	1759-1	80	48	2	18.0	169.56
	1760-1	80	60	2	21.0	207.85

MADE IN U.S.A.

40, 50, 90, and 100 gauze available upon request

Drive Well Point ---- Inside Gauze



	Stainless Part No.	Gauze	Length	Size	Weight lbs.	List Each
1 1/4"	1721	60	30	1 1/4	8.0	80.03
	1722	60	36	1 1/4	9.0	86.22
	1724	60	48	1 1/4	11.0	105.34
	1725	60	60	1 1/4	14.0	120.35
	1727	80	30	1 1/4	8.0	80.03
	1728	80	36	1 1/4	9.0	86.22
	1730	80	48	1 1/4	11.0	105.34
	1731	80	60	1 1/4	14.0	120.35
2"	1752	60	36	2	15.0	131.26
	1753	60	48	2	19.0	169.56
	1754	60	60	2	23.0	207.85
	1758	80	36	2	15.0	131.26
	1759	80	48	2	19.0	169.56
	1760	80	60	2	23.0	207.85

Galvanized Steel Coupling Standard

Part No.	Pipe Size Ins.	Outside Diameter Ins.	Weight Each lbs.	List Price Each
941	1 1/4	1 15/16	.50	3.33

Galvanized Steel Coupling Turned O.D.

*942	1 1/4	1 13/16	.50	5.54
------	-------	---------	-----	------

Galvanized Steel Coupling Drive

946	1 1/4		1.00	18.52
947	1 1/2		1.75	24.73
948	2		2.00	36.41

*942 enters 2" Pipe.



Drive Point Head Female Thread



Part No.	Size	Weight Each lbs.	List Price Each
1690	1 1/4	1.50	11.14
1693	1 1/2	1.90	16.09
1694	2	3.75	19.72

Flush Point Head



1692	1	1.25	11.14
1691	1 1/4	1.50	13.89



Drive Cap

1695	1 1/4	1.33	14.86
1697	2	3.00	37.99

MADE IN U.S.A.

Flush Well Point



1 1/4"

Stainless Steel Part No.	Gauze	Pipe Length	Pipe Size	Weight Each lbs.	List Price Each
1720-2	60	24	1 1/4	6.0	76.26
1721-2	60	30	1 1/4	8.0	82.00
1722-2	60	36	1 1/4	9.0	88.24
1723-2	60	42	1 1/4	10.0	95.10
1724-2	60	48	1 1/4	11.0	102.07
1725-2	60	60	1 1/4	14.0	123.96
1726-2	80	24	1 1/4	6.0	76.26
1727-2	80	30	1 1/4	8.0	82.00
1728-2	80	36	1 1/4	9.0	88.24
1729-2	80	42	1 1/4	10.0	95.10
1730-2	80	48	1 1/4	11.0	102.07
1731-2	80	60	1 1/4	14.0	123.96

40, 50, 90, and 100 gauze available upon request.

MADE IN U.S.A.

Well Point Dimensions

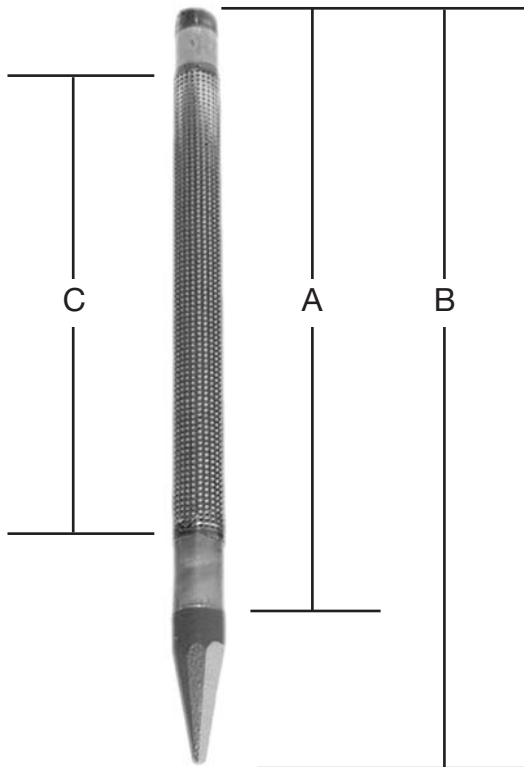

Well Point Lengths

A Pipe Length	B Overall Length	C Jacket Length
24"	30"	18 7/8"
30"	36"	23 7/8"
36"	42"	30 1/4"
42"	48"	35 3/8"
48"	54"	41 1/8"
60"	66"	52 7/8"
66"	72"	59 3/4"
96"	102"	88 3/4"

Slot Size

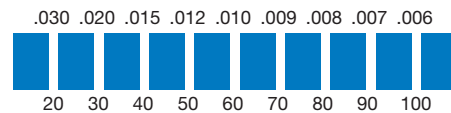

Gauze/Mesh Equivalent



Well Screen

	Stainless Steel Part No.	Gauze	Pipe Length	Pipe Size	Weight Each lbs.	List Price Each	
1 1/4"	1720-3	60	24	1 1/4	4.0	65.62	
	1721-3	60	30	1 1/4	6.0	71.09	
	1722-3	60	36	1 1/4	7.0	77.94	
	1723-3	60	42	1 1/4	8.0	84.75	
	1724-3	60	48	1 1/4	9.0	92.69	
	1725-3	60	60	1 1/4	12.0	114.11	
	1726-3	80	24	1 1/4	4.0	65.62	
	1727-3	80	30	1 1/4	6.0	71.09	
	1728-3	80	36	1 1/4	7.0	77.94	
	1729-3	80	42	1 1/4	8.0	84.75	
	1730-3	80	48	1 1/4	9.0	92.69	
	1731-3	80	60	1 1/4	12.0	114.11	
	1 1/2"	1742-3	60	36	1 1/2	8.0	92.91
		1770-3	60	48	1 1/2	12.0	155.78
		1775-3	60	60	1 1/2	15.0	195.32
2"	1750-3	60	24	2	9.0	99.15	
	1751-3	60	30	2	9.5	111.40	
	1752-3	60	36	2	12.5	119.45	
	1753-3	60	48	2	15.0	155.89	
	1754-3	60	60	2	18.0	194.20	
	1756-3	80	24	2	9.0	99.15	
	1757-3	80	30	2	9.5	111.40	
	1758-3	80	36	2	12.5	119.45	
	1759-3	80	48	2	15.0	155.89	
1760-3	80	60	2	18.0	194.20		

40, 50, 90, and 100 gauze available upon request

Male Adapter

Galvanized Steel Part No.	Red Brass Part No.	Size Inches	Carton Quantity	Weight Each lbs.	List Price Each	
					Steel	Brass
MAS-2	MAB-2	1/2	25	.16	2.16	5.49
MAS-3	MAB-3	3/4	25	.20	2.34	6.98
MAS-4	MAB-4	1	20	.40	3.07	9.98
MAS-5	MAB-5	1 1/4	20	.55	3.65	15.98
MAS-6	MAB-6	1 1/2	10	.70	4.73	19.75
MAS-8	MAB-8	2	10	1.00	7.19	26.70
MAS-12	----	3	Bulk	3.00	25.73	---



MAS



FAS

Female Adapter

Galvanized Steel Part No.	Red Brass Part No.	Size Inches	Carton Quantity	Weight Each lbs.	List Price Each	
					Steel	Brass
----	FAB-2	1/2	Bulk	.25	---	12.30
FAS-3	FAB-3	3/4	Bulk	.33	8.76	14.20
FAS-4	FAB-4	1	Bulk	.33	11.31	17.50
FAS-5	FAB-5	1 1/4	Bulk	.50	14.32	25.16



XS



RAS

Long Adapter

Galvanized Steel Part No.	Red Brass Part No.	Size Inches	Carton Quantity	Weight Each lbs.	List Price Each	
					Steel	Brass
XS-4	XB-4	1	Bulk	.50	6.39	18.25
XS-5	XB-5	1 1/4	Bulk	.75	8.45	26.98



ZAB

Reducing Adapter • Galvanized Steel.

Galvanized Steel Part No.	Red Brass Part No.	NPT x Insert Size Inches	Carton Quantity	Weight Each lbs.	List Price Each	
					Steel	Brass
RAS-3-2	----	3/4 x 1/2	Bulk	.22	10.73	---
RAS-4-3	----	1 x 3/4	Bulk	.35	11.58	---
RAS-5-4	RAB-5-4	1 1/4 x 1	Bulk	.58	13.27	32.90

Venturi Male Adapter w/Lug • Bronze.

Part No.	Size Inches	Carton Quantity	Weight Each lbs.	List Price Each
ZAB-4	1	Bulk	1.00	38.39

Male Adapter w/Lug • Bronze.

Part No.	Size Inches	Carton Quantity	Weight Each lbs.	List Price Each
ZBB-4	1	Bulk	1.00	28.85

Rope Adapter • Bronze.

Part No.	Size Inches	Carton Quantity	Weight Each lbs.	List Price Each
9485	1	1	1.00	9.76



ZBB



9485

MADE IN U.S.A.

All Steel Fittings are A53 Galvanized Grade B Hot Roll Electric Weld.

Venturi Male Adapter



VMAS

VFAB



RCS-3



CS-2



NS-3-2



WSL-3A

Galvanized Steel Part No.	Red Brass Part No.	Size Inches	Carton Quantity	Weight Each lbs.	List Price Each	
					Steel	Brass
VMAS-4x6	VMAB-4x6	1	Bulk	.75	6.13	19.10
VMAS-4x8	VMAB-4x8	1	Bulk	1.00	7.42	24.15
VMAS-4x10	-----	1	Bulk	1.33	8.45	--
VMAS-5x6	VMAB-5x6	1 1/4	Bulk	1.00	7.83	28.30
VMAS-5x8	VMAB-5x8	1 1/4	Bulk	1.50	9.58	37.28
VMAS-5x10	-----	1 1/4	Bulk	1.75	11.07	--

Venturi Female Adapter • Bronze.

Galvanized Steel Part No.	Red Brass Part No.	Size Inches	Carton Quantity	Weight Each lbs.	List Price Each	
					Steel	Brass
----	VFAB-4x6	1	Bulk	1.50	--	20.37
----	VFAB-5x6	1 1/4	Bulk	1.75	--	25.28

Coupling

Galvanized Steel Part No.	Red Brass Part No.	Size Inches	Carton Quantity	Weight Each lbs.	List Price Each	
					Steel	Brass
CS-2	CB-2	1/2	25	.12	1.95	7.68
CS-3	CB-3	3/4	25	.16	2.35	8.58
CS-4	CB-4	1	20	.25	3.07	12.65
CS-5	CB-5	1 1/4	20	.40	4.61	19.98
CS-6	----	1 1/2	10	.50	5.03	--
CS-8	----	2	10	1.40	9.25	--

Reducing Coupling • Galvanized Steel

Part No.	Size Inches	Carton Quantity	Weight Each lbs.	List Price Each
RCS-3-2	3/4 x 1/2	Bulk	.23	3.73
RCS-4-3	1 x 3/4	Bulk	.47	7.19
RCS-5-4	1 1/4 x 1	Bulk	.70	9.99

Swaged Nipple

Galvanized Steel Part No.	Red Brass Part No.	Size Inches	Carton Quantity	Weight Each lbs.	List Price Each
NS-3-2	----	3/4 x 1/2	Bulk	.33	5.95
NS-4-3	----	1 x 3/4	Bulk	.50	6.70
NS-5-4	----	1 1/4 x 1	Bulk	.50	7.19
NS-6-5	----	1 1/2 x 1 1/4	Bulk	.75	8.45

Well Seal Ell • Insert X Insert.

Galvanized Steel Part No.	Red Brass Part No.	Size Inches	Carton Quantity	Weight Each lbs.	List Price Each
WSL-3A	----	3/4	Bulk	1.25	8.28
WSL-4A	----	1	Bulk	1.75	11.85
WSL-5A	----	1 1/4	Bulk	3.00	19.06

MADE IN U.S.A.

Air Volume Controls



1233

- Deep well.
- Steel case.



1231

- Shallow well.
- Steel case.

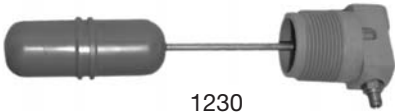

1230



1236

- Optional Fittings Package includes: 1/4" compression fitting for plastic tube and tubing.



1234

- Brady.



1184

- Brady.
- Non-Repairable.



1190

- Brady.
- Repairable.
- With 1/4" Gauge Tap.

Part No.	Type	Description	Weight Each lbs.	List Price Each
1233	WJ	Deep Well	1.0	38.94
1231	F93B	Deep Well	1.0	25.75
1230	L	Shallow Well w/30" Tube Less Gauge	1.0	38.33
1236	Jet Pump	Plastic	.25	17.88
1237	Kit	see note	.10	8.98
1239	Package	Includes 1236 and 1237	1.00	26.86
1234	Deep Well	Plastic	.50	30.50

Part No.	Model No.	Maximum Tank Size	Weight Each lbs	List Price Each
1184	AV 45	thru 80	.75	24.20
1185	AV 100	thru 100	.75	26.70
*1186	AV 45F	thru 80	.75	24.80
*1187	AV 100F	thru 100	.75	27.60

*Female threads

1190	AV 30	42	.50	25.48
1191	AV 42	70	.75	34.82
1192	AV 80	120	1.50	43.46
1193	AV 120	220	2.00	57.59

Repair Kits

Part No.	Model No.	Description	List Price Each
1196	AV - 30 - 3A	repair kits	10.66
1197	AV - 42 - 3A	repair kits	12.08
1198	AV - 80 - 3A	repair kits	14.46
1199	AV-120 - 3A	repair kits	23.13



1240

Air Valves **

- 1/8" Steel.
- 1/4" Brass.

Part No.	Size Inches	Description	Weight Each lbs.	List Price Each
1240	1/8	Shallow and Deep Well Pumps	.10	2.58
1241	1/4	Shallow and Deep Well Pumps	.12	2.97
1242	-	Core Only	-	1.63



970

Pressure Gauges **

- Steel case.
- Glass face.
- Brass mount.

Part No.	Size Inches	Range	Connection	Weight Each lbs.	List Price Each
970	2	0-100 lbs.	1/4 L.M.	.25	12.45
972	2	0-100 lbs.	1/8 L.M.	.25	12.45
973	2	0-200 lbs.	1/8 L.M.	.25	12.45
974	2	0-100 lbs.	1/8 C.B.M.	.25	14.82
975	2	0-100 lbs.	1/4 C.B.M.	.25	14.82

Packaged 100 per carton.



1300

Pressure Gauges ** --- Import

- Steel case.
- Glass face.
- Brass mount.

Part No.	Size Inches	Range	Connection	Weight Each lbs.	List Price Each
1300	2	0-100 lbs.	1/4 L.M.	.25	5.65
1301	2	0-200 lbs.	1/4 L.M.	.25	6.00
1302	2	0-100 lbs.	1/8 C.B.M.	.25	7.98

Packaged 100 per carton.

**** Contains Lead, Not for sale in California.**



1360

Submersible Rope

- Rated in excess of 1000 pounds.
- Individually boxed.
- Hollowbraid.

Part No.	Size	Material	Weight Each lbs.	List Price Each
1360	500'	Polypropylene fibre	8.0	34.56
1361	1000'	Polypropylene fibre	16.0	67.96
1362	3000'	Polypropylene fibre	48.0	203.94



Pitcher Pump and Parts

- Painted Cast Iron.
- Leather plunger cup.
- Individually boxed.

Part No.	Pipe Connection	Weight Each lbs.	List Price Each
1160	1 1/4	16.0	99.98

Description

1161	Complete Plunger Assembly	-	21.83
1162	Flat Leather for Base Valve	-	2.78
1163	Weight and Screw for Flat Leather	-	4.07
1164	Pump Base with Bolts	-	20.06
1165	Pump Cylinder	-	27.29
1166	Pump Top with Set Screw	-	12.79
1167	Pump Handle with Bolts	-	17.38
1168	Flat Valve Leather and Weight	-	9.84
1169	Plunger Cup Leather	-	7.38





Brass Relief Valve **

- Cast brass finish.
- Pressure only relief valve.
- Factory preset at 75 psi.

Part No	Size Inches	Weight Each lbs.	Carton Quantity	Master Carton Quantity	List Price Each
451-5	1/2	.35	1	50	11.33
451-75	3/4	.35	1	50	11.51

** Contains Lead, Not for sale in California.



Torque Arrestor

- Fits 4-8" well casing.
- Supplied with two stainless steel clamps.
- Packed 18 per carton.

Part No	Size	Material	Weight Each lbs.	List Price Each
1350	Fits 1" or 1 1/4" Drop Pipe	Rubber	2.0	11.88
1352	1" Spider Style	Rubber	1.0	15.04



Cable Guard

- Plastic.
- 1" - 1 1/4" pipe size.

Part No	Description	Carton Quantity	Weight Each lbs.	List Price Each
1358	With Split Wire Hole	100	1.6	1.30

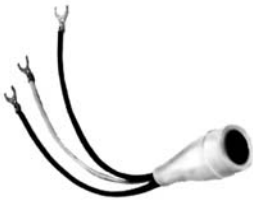

Lightning Arrestor

- 500 volt surge protection.

Part No	Description	Carton Quantity	List Price Each
1365	Lightning Protection	1	19.45



Splicing Kits

- Individually packaged.
- With crimp connectors.



Part No.	Sleeve Size Inches	Material	Tubes Per Kit	Weight lbs. per 100	List Price Each
1370	3/8" x 3"	2-wire, 10-12-14	2	2.0	4.13
1371	3/8" x 3"	3-wire, 10-12-14	3	3.0	5.95
1372	3/8" x 3"	4-wire, 10-12-14	4	4.0	6.98
1373	3/4" x 6"	#8	3	4.0	25.69
1225	Compression	2-wire, 10-12-14	2	10.0	4.44
1235	Compression	3-wire, 10-12-14	3	12.0	6.48



Solderless Crimp Connectors

Part No.	Wire Sizes	Quantity per bag	Weight lbs. per bag	List Price Each
1376	10-12-14	50	.25	18.03
1377	8	25	.25	24.46



Bleeder Orifice

- One piece.

Part No.	Size	Description	Weight Each lbs.	List Price Each
1353	1" mpt	Rubber	.25	4.30

Pressure Switches

- Square D.
- Class 9013.
- Individually Boxed.



Part No.	Type	Pressure Connection IPS	Pressure Range	Weight Each lbs.	List Price Each
1001	FSG1	1/8	20-65	1.0	31.73
1002	FSG2	1/4	20-65	1.0	29.62
1004	FSG2P	1/4	20-65	1.0	30.43
1006	FSG2M1	1/4	20-65	1.0	35.53
1007	FSG2M1P	1/4	20-65	1.0	35.87
1008	FSG2M4	1/4	20-65	1.0	38.82
1009	FYG2	1/4	20-80	1.0	43.27
1010	FYG2P	1/4	20-80	1.0	43.95
1032	PC-10 repair kit for FSG-2 switch			0.5	16.13

The "P" at the end of the switch type designates that it is equipped with a pulsation plug. M1 has manual cut out. M4 has automatic low pressure cutoff.

Above switches available in 20 Pound increments.

Part No.	Type	Pressure Connection IPS	Pressure Range	Weight Each lbs.	List Price Each
1011	GSG1	1/8	20-60	2.00	98.48
1012	GSG2	1/4	20-60	2.00	98.48
1013	GSG3	3/8	20-60	2.00	98.48
1016	GHG1	1/8	60-200	2.25	101.67
1017	GHG2	1/4	60-200	2.25	101.67
1018	GHG3	3/8	60-200	2.25	101.67

Important: Specify pressure setting when ordering.

MADE IN U.S.A.

500 SB Series Check Valves Pressure and Head Loss

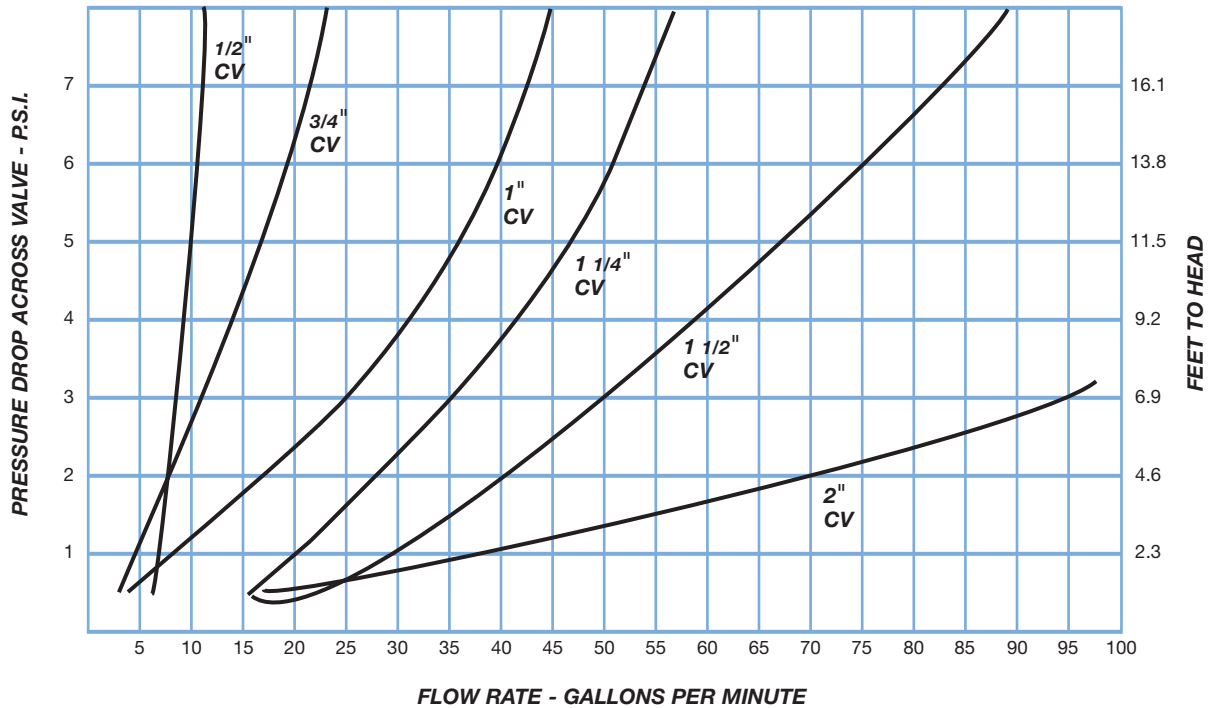

2500 SB Series Check Valves Pressure and Head Loss

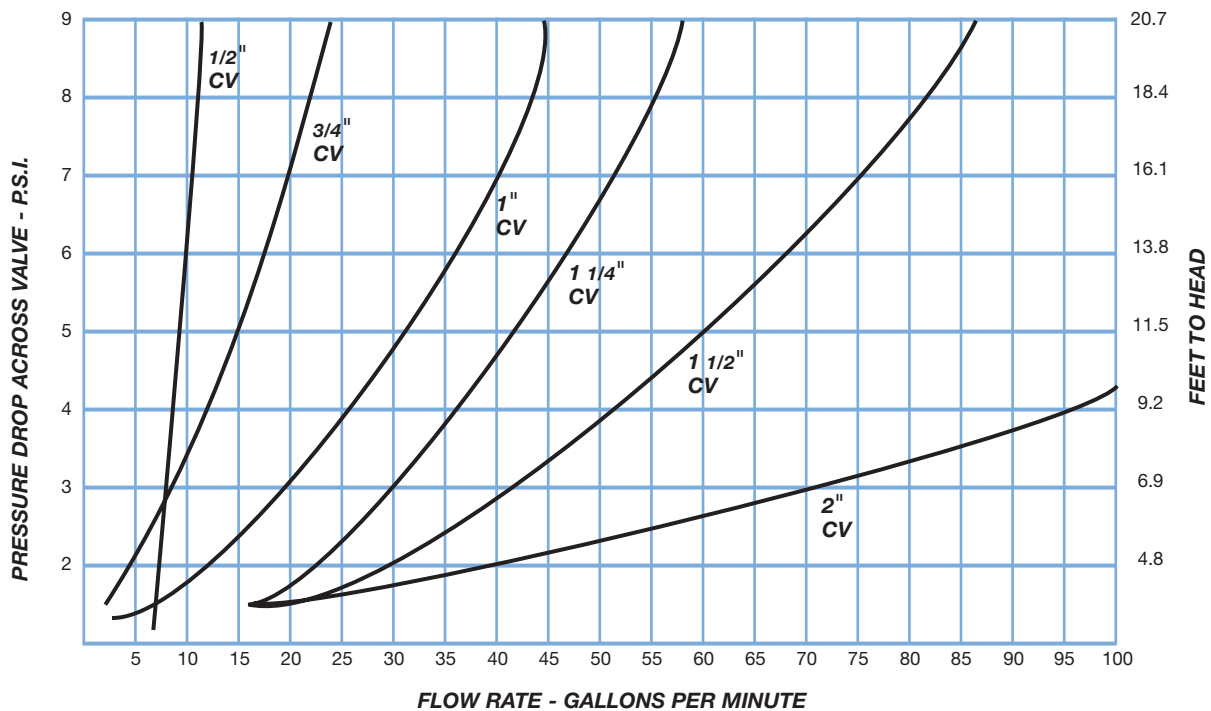

Silicon Bronze and Ductile Iron Check Valves

Pressure and Head Loss

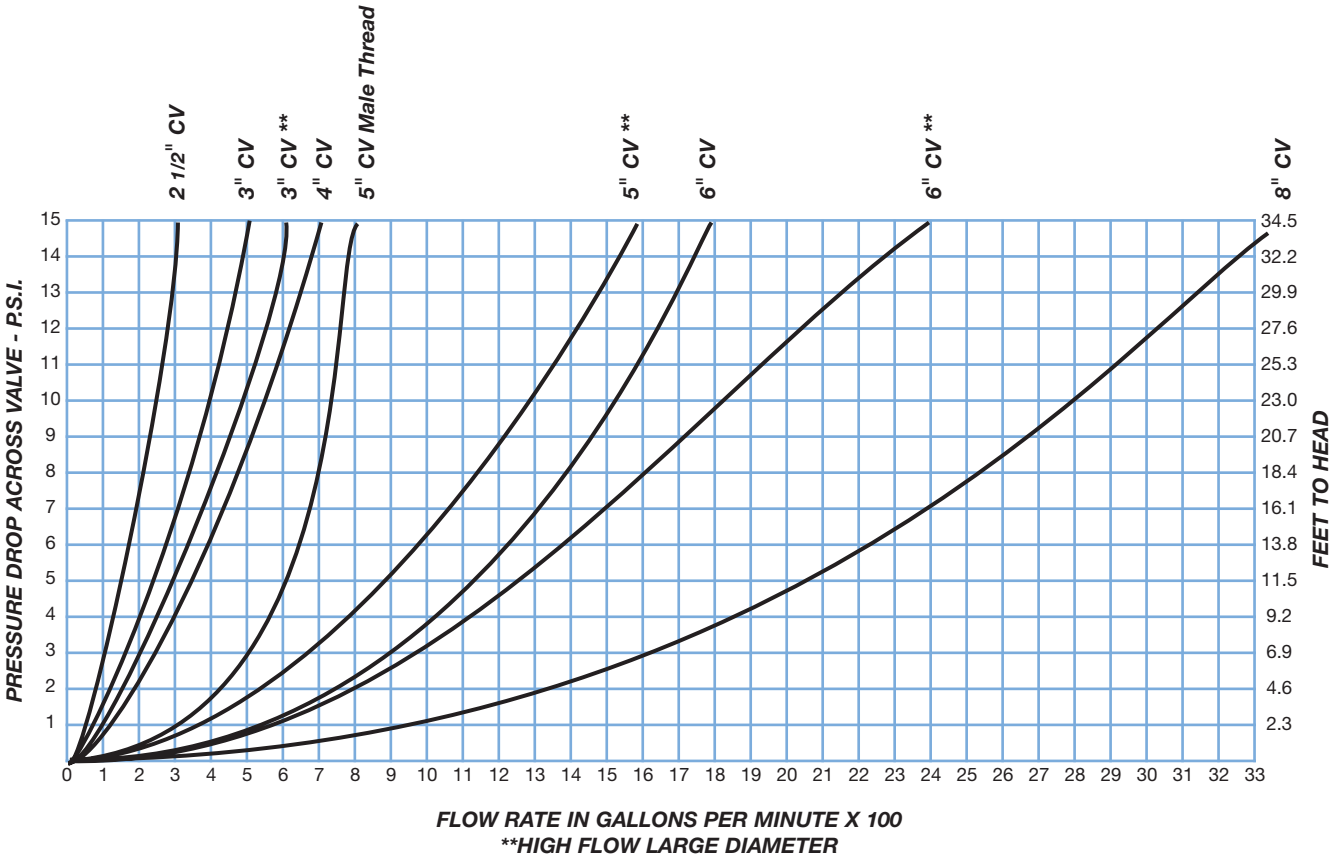

Typical Simmons Check Valves. (Specifications on pages 4 through 9.)

Sanitary Yard Hydrants - Specifications

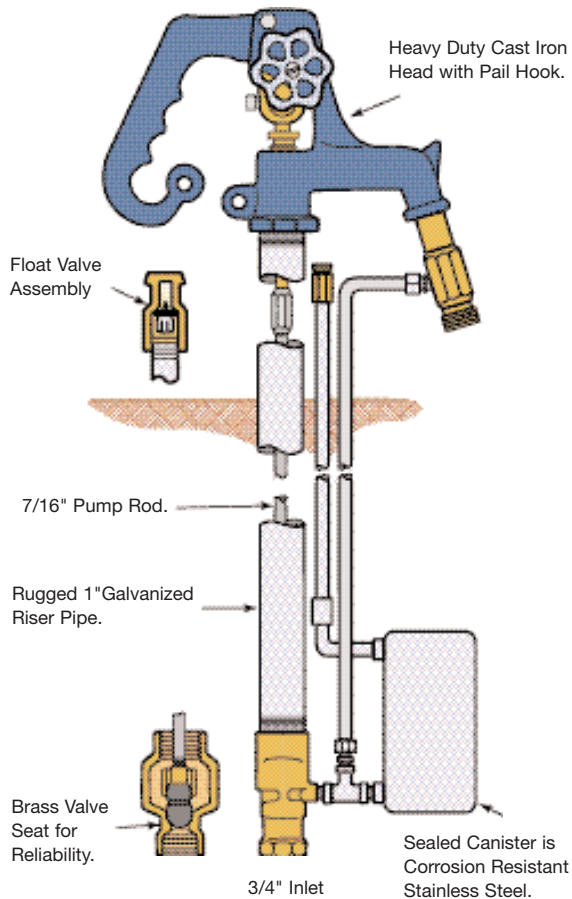

Sanitary Hydrant Part No.	Bury Depth	Overall Length	Weight
6800	1 ft.	45 in.	16 lb.
6802	2 ft.	57 in.	18 lb.
6803	3 ft.	69 in.	20 lb.
6804	4 ft.	81 in.	22 lb.
6805	5 ft.	93 in.	24 lb.
6806	6 ft.	105 in.	26 lb.
6807	7 ft.	117 in.	28 lb.
6808	8 ft.	129 in.	30 lb.

The SIMMONS SANITARY YARD HYDRANT is engineered to be fully self-contained and easily serviced in the field. It permits water flow year-around, even in freezing weather, yet there is no ground contamination nor contamination of the water supply. This hydrant drains back into the stainless steel canister.

FUNCTION

Simmons Sanitary Hydrant incorporates a nozzle-venturi adapter (located above-ground for serviceability), and a stainless steel underground canister with the time proved, dependable, basic Simmons yard hydrant design. When the hydrant is off, plunger seals against the valve seat and stops the flow. Water remaining in riser pipe drains back into the canister which is buried below the frost level.

When the hydrant is on, flow through the nozzle creates a vacuum which empties the canister through the hose bibb.

Because the hydrant drains into a sealed canister and not into the ground through a "drain outlet," the water never comes in contact with the soil. This conserves water and avoids possible contamination of your water supply.

The Brass Packing Nut located on the head of the Simmons Sanitary Yard Hydrant has been factory adjusted. If leakage should occur upon installation or after usage, you may find it necessary to slightly tighten the Brass Packing Nut.

CAUTION: Do not overtighten Brass Packing Nut. Damage will occur to inner O rings. Do not leave hose attached in freezing temperatures as it may prevent proper drainage of the riser pipe water into the canister.

To prevent unauthorized use, handle can be padlocked by inserting padlock into holes provided in handle and head.

Yard Hydrants - LENGTHS

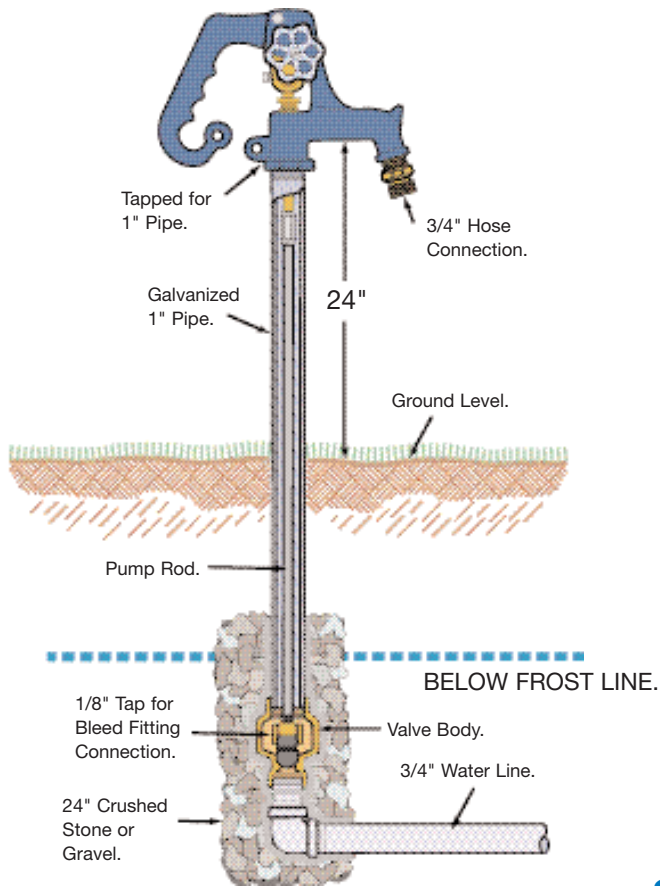

The Frost Proof Yard Hydrant provides running water for lawn and garden, live-stock and fire protection all year even in sub-zero temperatures. The shut-off valve operates below the frost line. Hydrant cannot freeze because when it is closed, all water in the standpipe drains out a hole in the valve which is set in the ground below the frost line. Hydrant spout operates at a convenient height (24 inches) from the ground level so that it can spill into a stock tank. Adapter (No. 8828) is threaded for 3/4" hose. Hydrant can be easily installed anywhere water is supplied under pressure.

To prevent unauthorized use, handle can be padlocked by inserting padlock into holes provided in handle and head.

800 Series

Model	Bury Depth	Pipe Length	Overall Length
800	1 ft.	33"	39 1/2"
801	1 1/2 ft.	41"	47 1/2"
802	2 ft.	47"	53 1/2"
803	3 ft.	59"	65 1/2"
804	4 ft.	71"	77 1/2"
805	5 ft.	83"	89 1/2"
806	6 ft.	95"	101 1/2"
807	7 ft.	107"	113 1/2"
808	8 ft.	119"	125 1/2"

4800 Series

Model	Bury Depth	Pipe Length	Overall Length
4800	1 ft.	33"	38 3/4"
4801	1 1/2 ft.	41"	46 3/4"
4802	2 ft.	47"	52 3/4"
4803	3 ft.	59"	64 3/4"
4804	4 ft.	71"	76 3/4"
4805	5 ft.	83"	88 3/4"
4806	6 ft.	95"	100 3/4"
4807	7 ft.	107"	112 3/4"
4808	8 ft.	119"	124 3/4"

SPECIAL INSTRUCTIONS

The Brass Packing Nut located on the head of the Simmons Frost-Proof Yard Hydrant has been factory adjusted. If leakage should occur upon installation or after usage, you may find it necessary to slightly tighten the Brass Packing Nut.

CAUTION: Do not overtighten Brass Packing Nut. Damage will occur to inner O rings. Do not leave hose attached in freezing temperature as it may prevent proper drainage of the riser pipe via shut-off valve drain hole.

If hydrant will not shut off completely, the plunger in the bottom of the hydrant can be lowered by raising the point of contact of the square head set screw on the brass rod.

Freight Policy

**With minimum order volume listed for your Zone,
Full Freight is allowed ... F.O.B. McDonough, Georgia**

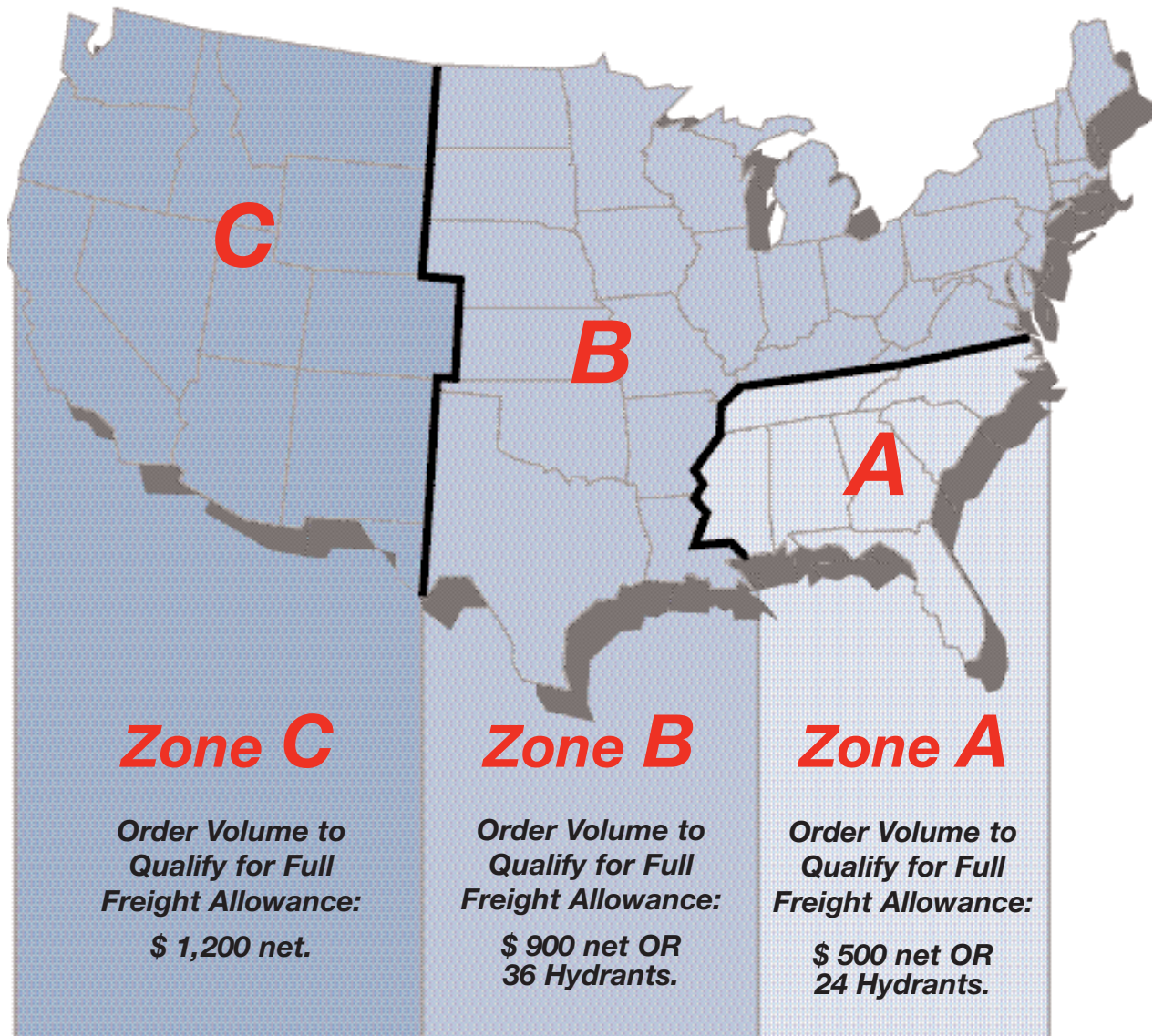

Simmons Manufacturing Company, Inc.

P.O. Box 1509,
1608 Conyers Road,
McDonough, Georgia 30253



Sales Order Desk:
800-241-1935
770-957-3976
Fax: 770-957-3979

www.simmonsmfg.com
simmonssales@simmonsmfg.com