



# Fantech

Your Ventilation Solutions Company

## VHR704R Heat Recovery Ventilator

### Installation Manual

**IMPORTANT - PLEASE READ THIS MANUAL  
BEFORE INSTALLING UNIT**



**CAUTION** - Before installation, careful consideration must be given to how this system will operate if connected to any other piece of mechanical equipment, i.e. a forced air furnace or air handler, operating at a higher static. After installation, the compatibility of the two pieces of equipment should be confirmed by measuring the airflow of the Heat Recovery or Energy Recovery Ventilators.

It is always important to assess how the operation of any HRV/ERV may interact with vented combustion equipment (i.e. Gas Furnaces, Oil Furnaces, Wood Stoves, etc.).

**NEVER** - install a ventilator in a situation where its normal operation, lack of operation or partial failure may result in the backdrafting or improper functioning of vented combustion equipment!!!



Your ventilation system should be installed in conformance with the appropriate provincial or state requirements or in the absence of such requirements with the current edition of the National Building Code, and / or ASHRAE's " Good Engineering Practices".

## The Best Limited Warranty in the Business

- The heat recovery aluminum core has a limited lifetime warranty.
- The motors found in all Fantech HRV's require no lubrication, and are factory balanced to prevent vibration and promote silent operation.
- The limited warranty covers normal use. It does not apply to any defects, malfunctions or failures resulting from improper installation, abuse, mishandling, misapplication, fortuitous occurrence or any other circumstances outside Fantech's control.
- Inappropriate installation or maintenance may result in the cancellation of the warranty.
- Any unauthorized work will result in the cancellation of the warranty.
- Fantech is not responsible for any incidental or consequential damages incurred in the use of the ventilation system.
- Fantech is not responsible for providing an authorized service center near the purchaser or in the general area.
- Fantech reserves the right to supply refurbished parts as replacements.
- Transportation, removal and installation fees are the responsibility of the purchaser.
- The purchaser is responsible for ensuring that applicable local and national codes are observed.
- The warranty is limited to 5 years on parts and 7 years on the motor from the date of purchase, including parts replaced during this time period. If there is no proof of purchase available, the date associated with the serial number will be used for the beginning of the warranty period.

\* This warranty is the exclusive and only warranty in effect relative to the ventilation system and all other warranties either expressed or implied are invalid.

**\*\*\*Illustrations & images in this manual may not be exactly like unit purchased, these illustrations & images are for examples only.\*\*\***

1 cfm = 0.47189 l/s
1 l/s = 3.6 m <sup>3</sup> /hr

# TABLE OF CONTENTS

TECHNICAL DATA	
VHR 704R	3
INSTALLATION	5
Mounting the Unit	5
Location & Ducting	6
Examples	8
Air Flow Balancing	10
OPERATION	11
Modes Of Operation	11
Optional Remote Controls	12
MAINTENANCE	13
TROUBLESHOOTING	14
ELECTRICAL CONNECTIONS	15

## Sizing (Example) for maximum airflow normally required.

HRVs are typically sized to ventilate the whole house at a minimum of 0.35 air changes per hour. To calculate, simply take the square footage of the house (including basement) and multiply by the height of the ceiling to get cubic volume. Then, divide by 60 and multiply by 0.35.

Example:	SQFT of House	1100
	Basement	1100
	Total SQFT	2200
	Height of ceiling	x 8
	Cubic volume	17600
		/ 60
	Maximum airflow required (CFM)	293
		x 0.35
		103

\* Always consult your local code for sizing requirements in your area.

## Alternate Method

Room classification	Number of rooms	CFM (L/s)	CFM Required
Master bedroom		x 20 cfm (10 l/s)	=
Basement	yes or no	if yes add 20 cfm / 10 l/s if no = 0	=
Bedrooms		x 10 cfm (5 l/s)	=
Living room		x 10 cfm (5 l/s)	=
Others		x 10 cfm (5 l/s)	=
Kitchen		x 10 cfm (5 l/s)	=
Bathroom		x 10 cfm (5 l/s)	=
Laundry room		x 10 cfm (5 l/s)	=
Utility room		x 10 cfm (5 l/s)	=
<b>Total Ventilation Requirements (add last column )</b>			<b>=</b>



# VHR 704R

## SPECIFICATIONS

**CASE** 24 gauge galvanized steel. Baked powder-coated paint, antique white. Cabinet fully insulated with 1" (25 mm) aluminum foil-face high density polystyrene foam to prevent condensation and meet the requirements of the UL 94HF.

**MOTORS** Two (2) German-manufactured, factory-balanced ebm™ motors with backward curved blades. Motors come with permanently lubricated, sealed ball-bearings to guarantee long life and maintenance-free operation. Seven (7) year warranty.

**CORE** Aluminum heat recovery core configured for efficient cross-flow ventilation. Core is 8.5" x 8.5" (216 x 216 mm) with a 8" (205 mm) depth. Cores are designed and manufactured by Fantech to withstand extreme temperature variations.

**FILTERS** Two (2) Washable Electrostatic Panel Type Air Filters, 8.5" (216mm) x 8" (203mm) x 0.125" (3mm).

**CONTROLS** Unit is designed to accommodate the whole series of Fantech HRV controls.

**DEFROST** A preset defrost sequence is activated at an outdoor temperature of 23° F (-5°C) and lower. During the defrost sequence, the fresh air is interrupted momentarily and indoor air is allowed to recirculate in the exchanger to maximize the effectiveness of the defrost strategy. The unit then returns to normal operation until the next defrost sequence.

**SERVICEABILITY** Core, filters, motors and drain pan can be easily accessed through latched door. Core conveniently slides out on our new easy glide core guides. 10" (250mm) of clearance is recommended for removal of core.

**DUCT CONNECTION** 5" (125mm) Oval plastic duct connections integrated with balancing damper and balancing port.

**DRAIN** 1/2" (13mm) OD (outside diameter) drain spout provided, entire bottom of unit covered by pan.

**WARRANTY** Limited lifetime on aluminum core, 7 year on motors, and 5 year on parts.

Compact top port design HRV with easy-mount wall bracket. Brings a continuous supply of fresh air into a home while exhausting an equal amount of contaminated air. HRVs use what is called a "sensible" heat recovery core. This special core transfers heat from the exhaust air stream to the incoming air stream. Fresh incoming air is tempered by the heat that is transferred from the outgoing air to save on energy costs. The VHR 704R is equipped with automatic defrost mechanisms so even if you live in the coldest climates you can use your HRV all year long.

## FEATURES

- Super Compact Size
- Top Port Design Fits in Tight Spaces
- Includes Easy-Mount Wall Bracket
- Aluminum Heat Recovery Core
- 5" (125mm) Oval Duct Connections
- Easy Access Service Door
- 3' (914mm) Plug-in Power Cord
- Only 30 lbs (13.5 kg)
- Electrostatic Filters (washable)
- Easy Core Guide Channels For Removing Core
- Multiple Speed Operation

## ACCESSORIES

- EDF1 – Multi-function control
- RTS3 – 20/40/60 minute over-ride
- RTS2 – 20 minute over-ride
- EDF5 – Multi-function control
- MDEH1 – Dehumidistat
- EDF1R – Triple function wall control

**Dimensions & Airflow** - All units feature three foot plug-in power cord with 3-prong plug.

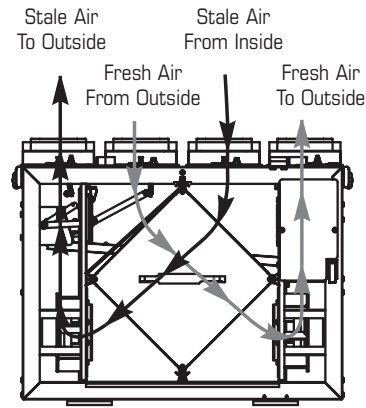
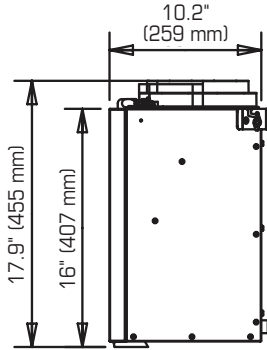
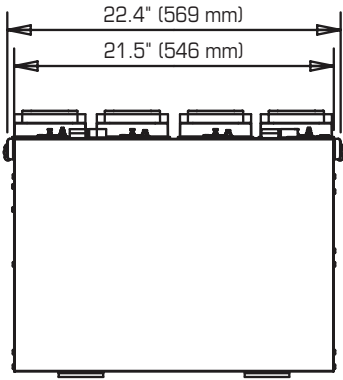

- Continuous ventilation mode of supply and exhaust airstreams
- 10" (254mm) of clearance is recommended for removal of core

**Ventilation Performance**

EXT. STATIC PRESSURE		NET SUPPLY AIR FLOW		GROSS AIR FLOW SUPPLY				EXHAUST	
Pa	in wg	L/s	cfm	L/s	cfm	L/s	cfm	L/s	cfm
25	0.1	40	84	41	86	43	91		
50	0.2	35	76	36	77	38	81		
75	0.3	30	64	31	66	33	70		
100	0.4	26	55	26	56	27	58		
125	0.5	21	44	21	45	20	43		

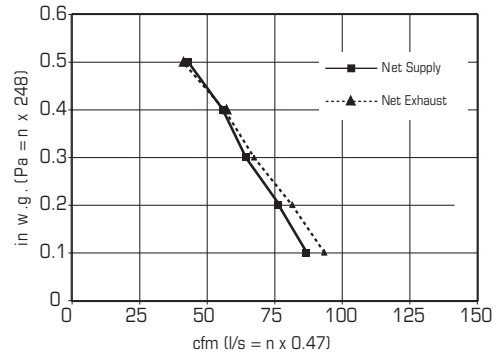

**Energy Performance**

	SUPPLY TEMPERATURE		NET AIRFLOW		POWER CONSUMED WATTS	SENSIBLE RECOVERY EFFICIENCY	APPARENT SENSIBLE EFFECTIVENESS
	°C	°F	L/s	cfm			
Heating	0	32	25	52	34	61	69
	0	32	30	64	44	59	67
	0	32	35	75	44	59	66
	-25	-13	30	63	42	61	73

**Specifications and Ratings**

- Model: VHR 704R
- Total assembled weight: 30 lbs (13.5 kg)
- Cabinet: 24 ga. steel w/powder coat finish
- Motors: ebm motors w/backward curved blades
- Filters: 2 washable electrostatic filters 8.5" (216mm) x 8" (205mm) x 0.125" (3mm)
- Insulated with 1" (25 mm) aluminum foil-face high density polystyrene foam to prevent condensation and meet the requirements of the UL 94HF.
- Core: Aluminum 8.5" (216mm) x 8.5" (216mm) x 8" (205mm)
- Supply & exhaust ducts: 5" (125mm) oval
- Mounting: Wall bracket included
- Electrical requirements:
 

Volts	Frequency	Amps	Watts
115V	60Hz	0.40A	40W

 3' plug-in power cord w/ 3-prong plug

**Contacts**

Submitted by:	Date:
Qty:	Model #:
Comments:	
Project #:	
Location:	
Architect:	
Engineer:	
Contractor:	



## INSTALLATION

### PRACTICAL TIPS

- Install the unit close to the outside wall on which the supply and exhaust hoods will be mounted.
- Have a nearby power supply 120 Volts, 60Hz. (power cord is 3 feet long)
- Mount the unit as level as possible in order to allow proper condensate drainage.
- Have access to a water drain for the condensate of the unit during defrost.
- Have a certain amount of heat around the unit (attic installation is not recommended).
- Installations close to the living space, such as closets, should be designed to minimize noise or vibration transfers.
- Have access for future maintenance. (10" is recommended for removal of core)

### ELECTRICAL

3 prong plug-in power cord.

### LOCATION

The HRV must be located in a heated space where it will be possible to conveniently service the unit. Typically the HRV would be located in the mechanical room or an area close to the outside wall where the weatherhoods will be mounted. If a basement area is not convenient or does not exist, a utility room or laundry or closet may be used.

Attic installations are not normally recommended due to:

- the complexity of work to install
- freezing conditions in the attic
- difficulty of access for service and cleaning

**Connecting the following appliances to the HRV is not recommended**, including:

- clothes dryer
- range top
- stovetop fan
- central vacuum system

These appliance may cause lint, dust or grease to collect in the HRV, damaging the unit.

**NOTE:** Connecting any of these type of appliances to the HRV will invalidate your warranty

### MOUNTING - EASY WALL MOUNT

Attach bracket to wall, lift unit (30 lbs/13.5 kg) & slide nuts into slots on bracket, tighten screws to secure unit to bracket. Insert the safety screws & place wall bumpers to level off the unit.

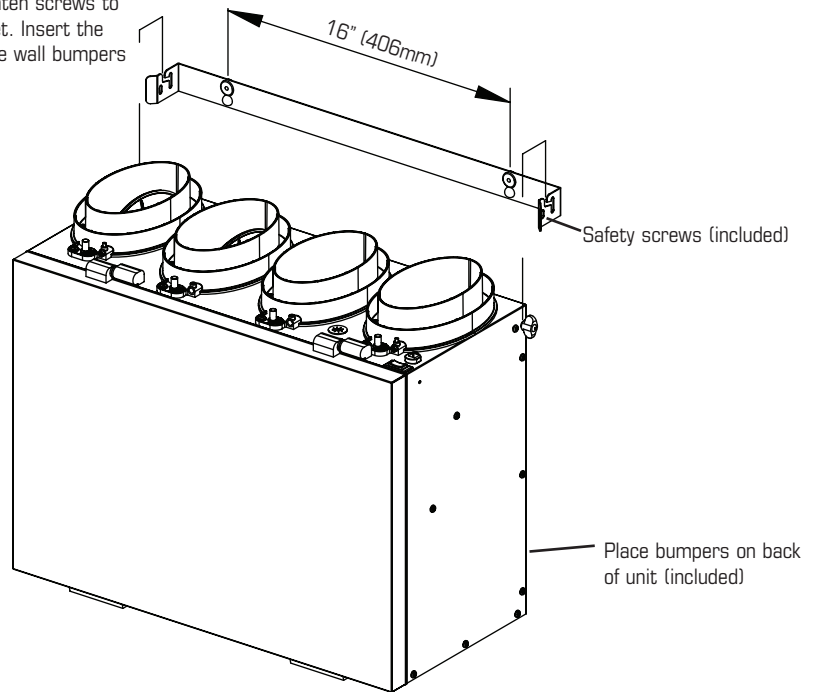

### INSTALLING DRAIN LINE - Drainline not included in kit

Through normal operation and during its defrost mode, the HRV may produce some condensation. This water should flow into a nearby drain, or be taken away by a condensate pump. The HRV and all condensate lines must be installed in a space where the temperature is maintained above the freezing point. A "P" trap should be made in the drain line. This will prevent odors from being drawn back up into the unit.

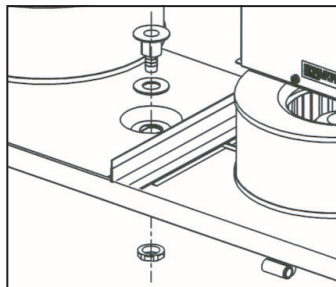

1 Install the drain nipple.

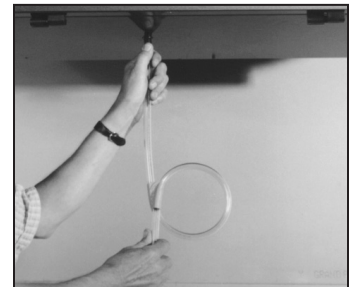

2 Install the drain hose, making a "P" trap

# INSTALLING DUCTS GOING TO / FROM OUTSIDE

## PRACTICAL TIPS

- Decide where your intake and exhaust hoods will be located.

### Locating the Intake Weatherhood

- Should be located upstream (if there are prevailing winds) from the exhaust outlet
- At least 6' (2m) away from dryer vents and furnace exhaust (medium or high efficiency furnaces)
- A minimum of 6' (2m) from driveways, oil fill pipes, gas meters, or garbage containers
- At least 18" (457mm) above the ground, or above the depth of expected snow accumulation
- At least 3' (1m) from the corner of the building
- Do not locate in a garage, attic or crawl space

### Locating the Exhaust Weatherhood

- At least 18" (457mm) above ground or above the depth of expected snow accumulation
- At least 3' (1m) away from the corner of the building
- Not near a gas meter, electric meter or a walkway where fog or ice could create a hazard
- Not into a garage, workshop or other unheated space

When installing the weatherhood, its outside perimeter must be sealed with exterior caulking.

A well designed and installed ducting system will allow the HRV to operate at its maximum efficiency. Always try to keep duct runs as short and straight as possible.

**See Installation Diagrams for installation examples.**

## INSTALLING THE DUCTING TO THE WEATHERHOODS

The inner liner of the flexible insulated duct must be clamped to the sleeve of the weatherhoods (as close to the outside as possible) and to the appropriate port on the HRV. The insulation should remain full and not be compressed. The outer liner, which acts as a vapor barrier must be completely sealed to outer wall and the HRV using tape and or caulking. A good bead of high quality caulking (preferably acoustical sealant) will seal the inner flexible duct to both the HRV port and the weatherhood prior to clamping.

To minimize air flow restriction, the flexible insulated duct that connects the two outside weatherhoods to the HRV should be stretched tightly and be as short as possible. Twisting or folding the duct will severely restrict air flow.

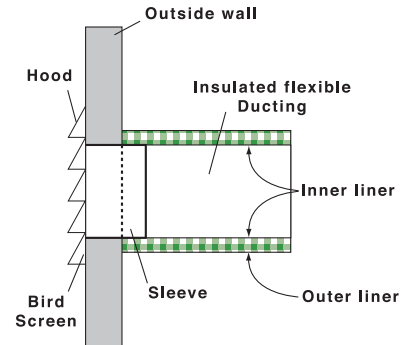

**1** Using the collar of the outside hood, outline the intake & exhaust holes to be cut. The holes should be slightly larger than the collar to allow for the thickness of the insulated flexible duct. Cut a hole for both the intake and exhaust hoods.



**2** Pull the insulated flexible duct through the opening until it is well extended and straight. Slide the duct's inner vinyl sleeve over the hood collar and secure, pull the insulation over the duct and then the vapor barrier over the sleeve and secure with duct tape.



**3** Push the hood into the opening. Attach the hood to the outside wall with mounting screws. Repeat the installation procedure for both the Supply and Exhaust hood.



**4** Using a caulking gun, seal around both hoods to prevent any leaks.

## INSTALLING DUCTS TO / FROM INSIDE

To maximize airflow in the ductwork system, all ducts should be kept short and have as few bends or elbows as possible. 45° elbows are preferred to 90° elbows. Use “Y” tees instead of 90° tees whenever possible.

All duct joints must be fastened with screws or duct sealant and wrapped with a quality tape to prevent leakage. Aluminum foil duct tape is recommended. Galvanized ducting from the HRV/ERV to the living areas in the house is recommended whenever possible, although flexible duct can be used in moderation when necessary.

**Warning:** The VHR 704R should be installed with a 5" (125mm) duct system that has less than 80 ft (25m) of equivalent duct length on the supply and on the exhaust side. If longer runs are required, increasing the duct diameter or following the instructions below might help.

It is the responsibility of the installer to ensure all ductwork is sized and installed as designed to ensure the system will perform as intended. All air movement devices have a performance curve. The amount of air (CFM) that an HRV will deliver is directly related to the total external static pressure (E.S.P.) of the system. Static pressure is a measure of resistance imposed on the blower by length of duct work/number of fittings used in duct work, duct heater etc.

## SUPPLY AIR DUCTING

In homes without a forced air furnace, fresh air should be supplied to all habitable rooms including, bedrooms and living areas. It should be supplied from high wall or ceiling locations. Grilles that diffuse the air comfortably such as Fantech Contour Grilles are recommended. To avoid possible noise transfer through the ductwork system, a short length (approximately 12", 300 mm) of nonmetallic flexible insulated duct should be connected between the HRV and the supply/exhaust ductwork system.

If the floor is the only option available, then special care should be taken in locating grilles. Areas such as under baseboard heaters will help to temper the air. Also, optional inline duct heaters are available for mounting in the supply duct work to add heat if required. In homes with a forced air furnace, you may want to connect the HRV to the furnace ductwork (see information below).

## PRACTICAL TIPS

- Building Codes and Combustion Appliance Installation Codes do not allow location of return air grilles or any opening such as a “breathing tee” in an enclosed room with spillage susceptible combustion appliances.
- The fresh air inlet from the HRV needs to respect a minimum distance from the furnace return drop to ensure proper air mixing and temperature at the furnace core. See furnace manufacturer for appropriate specifications.

## Exhaust Air Ducting

The stale air exhaust system is used to draw air from the points in the house where the worst air quality problems occur. Due to its lower capacity, the VHR 704R is designed to vent from a single source point only and to the bathroom that is closest to the unit or directly out of the furnace return. Additional source points may be drained from if designed properly or installed on a separate Fantech fan bath kit to ventilate additional areas. Fantech bath kits are listed below and are ideal for both new construction and retro fit.

Fantech bathroom kits for supplemental exhaust:

- PB100 (H/F) 100cfm per fan
- PB190 190cfm per fan
- PB230-2 230cfm per fan
- PB230 (H/F-2) 230cfm per fan
- PB230 (HV/FV-2) 230cfm per fan
- PB370-2 370cfm per fan
- PBW110 (H/F) 110cfm per fan

# INSTALLATION EXAMPLES

## Fully Dedicated System

**(suggested for new construction)**

Stale air drawn from key areas of home

(bathroom, kitchen, laundry)

Fresh air supplied to main living areas

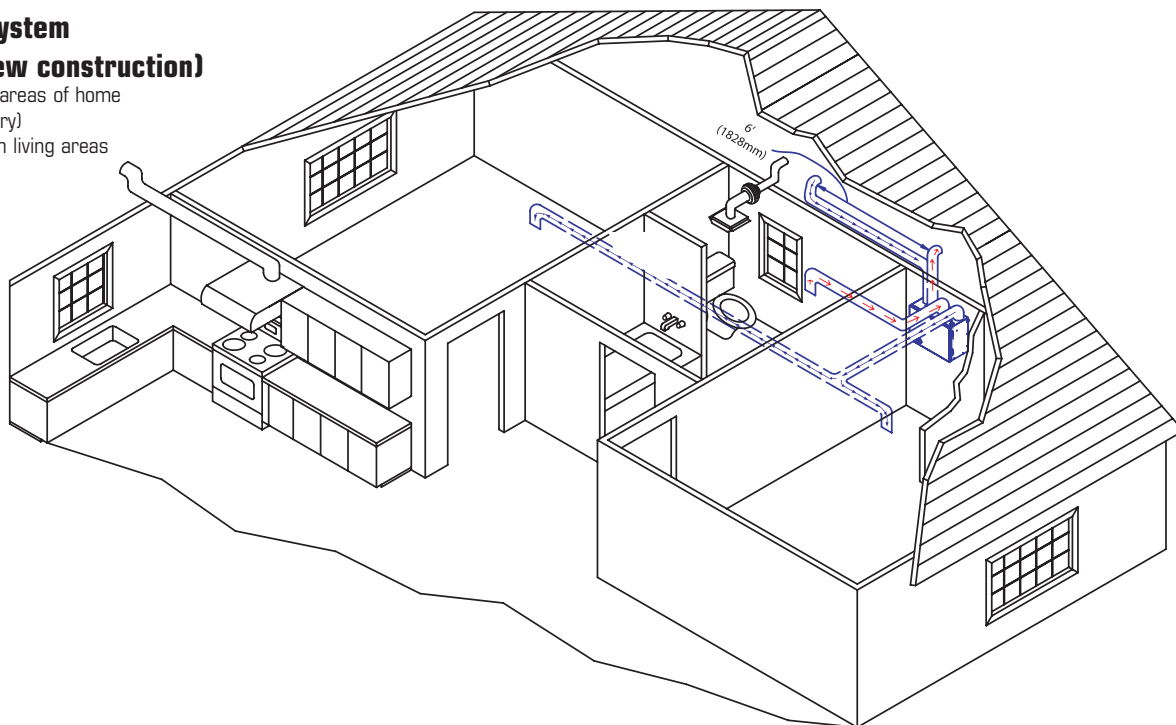

DIRECT CONNECTION of the SUPPLY AIR STREAM to the FURNACE COLD AIR RETURN  
(Stale air drawn from key areas of home)

## Partially Dedicated System

Stale air drawn from key areas of home (bathroom)

Fresh air supplied to main living areas via the forced air system.

### NOTES:

1. Furnace blower may be required to operate when HRV/ERV is on to provide good air distribution.
2. Weatherhood arrangement is for drawing purposes only.
3. Due to the differences in pressure between the HRV/ERV and the equipment it is being connected to, the HRV/ERV's airflow should be confirmed on site, using the balancing procedure found in the installation manual. If a release is required due to the furnace pulling too much air from the HRV/ERV, special care and attention is needed to its design.

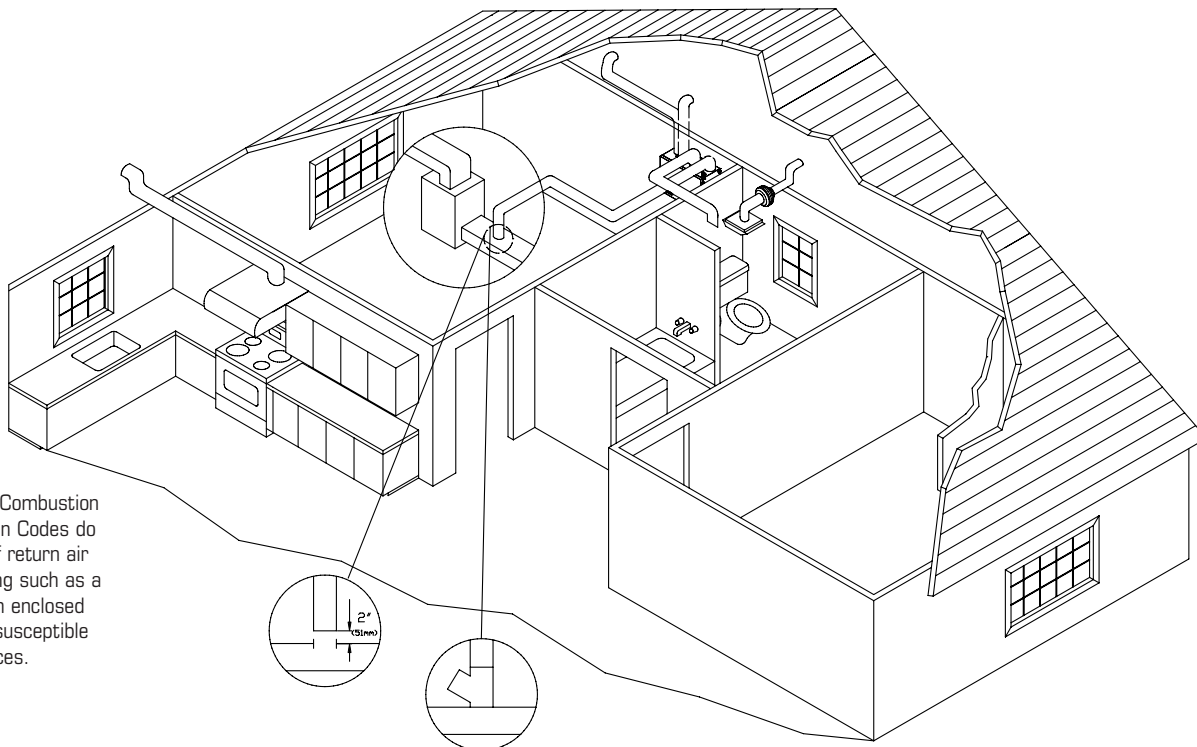

Building Codes and Combustion Appliance Installation Codes do not allow location of return air grilles or any opening such as a "breathing tee" in an enclosed room with spillage susceptible combustion appliances.



# AIRFLOW BALANCING

\* Fantech's superior design and use of EBM motors results in a steep fan curve that usually does not require balancing. Commissioning the system after installation is recommended which includes confirming the proper operation of the system and how it interacts with other components within the home.

## AIRFLOW STATION (GRID) METHOD

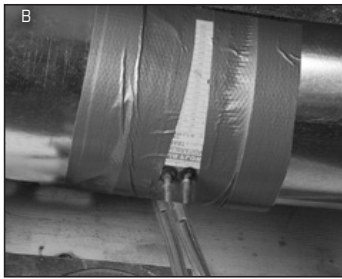

**1** For this flow measuring station, cut the duct and place the flow measuring station between each section of duct. Make sure that the flow measuring station's air direction arrow points in the direction of the airflow. Secure the flow measuring station with duct tape.



**2** Before taking the reading, make sure that the magnehelic gauge is level and at 0. Refer to the flow measuring station's chart to determine your unit's airflow velocity.



**3** Adjust the "Supply Air Out" damper until you reach the desired velocity. Follow the previous steps to adjust the "Exhaust Air Out" damper, if needed.

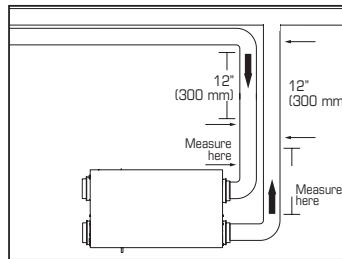

To avoid airflow turbulence and incorrect readings, the airflow velocity should be measured on steel ducting a minimum of 12" (300 mm) from the unit or elbow and before any transition.

## Measuring and Balancing Airflow with a Measurement and Balancing System

The following procedure is designed for measuring airflow and balancing an HRV based ventilation system.

### Step 1: Prepare the house

- Air/vapor barriers must be complete.
- Fireplace dampers, windows and doors closed.
- Clothes dryers and other large exhaust devices must be off.

### Step 2: Prepare the system

- Ventilation system must be complete, including grilles and registers.
- Check that filters are installed and clean.
- All system dampers set to operating positions (fully open for new installations).
- Check that intake and exhaust hoods are clear.
- Check that the HRV drain trap is full of water.
- In cold weather, check that HRV is defrosted and not in defrost mode.
- Turn HRV (fans) on high speed.

### Step 3: Taking measurements

- Ensure measuring gauge is level and secure. Magnehelic or slope manometer cannot be hand held.
- "Zero" gauge as required.
- Connect hoses to high and low ports of gauge and MBS. High to high and low to low.
- Read pressure from gauge and convert it to cfm using the chart for the unit's MBS. Record reading.
- This process must be done twice, once for the supply duct system and once for the exhaust duct system.

### Step 4: Balancing the airflow

Both the supply and exhaust measurements taken in step 3 must be greater than or equal to the Total Ventilation Capacity. An HRV is deemed balanced if the supply and exhaust flow are within  $\pm 10\%$  of each other.

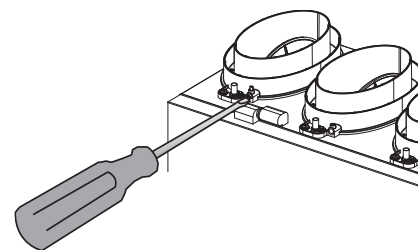
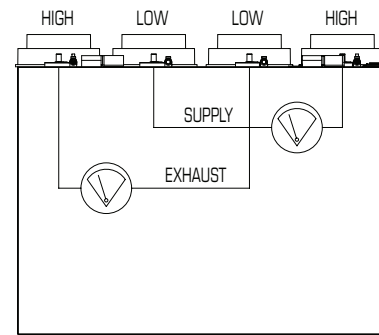

From the chart on the MBS, determine the pressure reading which corresponds to the ventilation rate required (TV). With the measuring gauge attached to the MBS, slowly close volume damper until gauge reads the correct pressure.

- Lock volume damper in position.

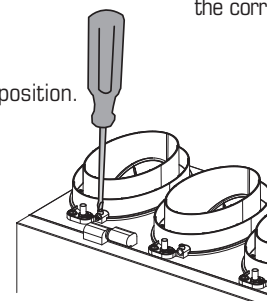

- Repeat the above procedure for the second duct system. It does not matter whether the supply or exhaust is adjusted first.

# MAINTENANCE

## CAUTION MAKE SURE UNIT IS UNPLUGGED BEFORE ATTEMPTING ANY MAINTENANCE WORK

The following components should also be inspected regularly and well maintained.

### PRACTICAL TIPS

- To prevent electrical shock, check that the unit is unplugged before doing any repairs or maintenance.
- A yearly inspection is recommended to ensure the efficiency and trouble-free use of your system. Run through the system and verify the different operating modes.

**The motor** - The motors are factory balanced and lubricated for life. They require no maintenance.

**The unit** - The inside of the unit should be vacuumed yearly. Be careful not to damage any of the mechanical components and electrical connections.

**Outside hoods** - The outside hoods need to be checked every season to make sure there are no leaves or insects blocking the airflow. Check regularly that there are no pollutants near the intake hood. Make sure they are clear of any snow accumulation during the winter months.

## FILTERS

The filters (2) need to be checked and cleaned every three months or when they appear dirty. Wash in warm soapy water (mild detergent) or use a soft brush vacuum. The filters should be replaced when they can no longer be cleaned properly.

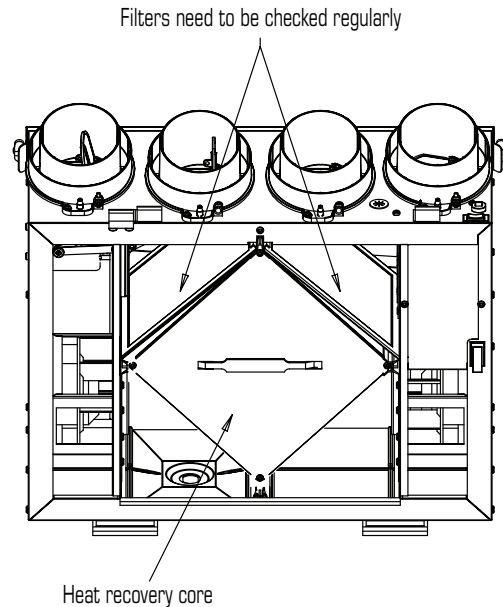

## HEAT RECOVERY CORE

The heat recovery core needs to be checked and cleaned every six months. The core can be cleaned using a mild soap and water. Rinse thoroughly. Handle with care. Hot water and a strong detergent will damage the heat recovery core.

**The drain pan and drain line** - Units with drain lines should have their line and connection checked regularly.

### Clean Core and Filters Every 3-6 Months.

Unplug unit before doing any repairs or maintenance

- Open access door.
- Carefully grip handle of core and pull out. Core will slide out of the channel.
- Once removed from the cabinet, remove filters.
- Wash core in warm soapy water (do not use dishwasher).
- Install clean core by:
  - First mounting the bottom flange of the core guide into the bottom channel approximately 1/4" (6mm).
  - Mount the left or right side flange of the core guide approximately 1/4" (6mm) followed by the other side.
  - Mount the top flange of the core guide into the top channel approximately 1/4" (6mm).
  - With all four corners in place and the core straight and even, push hard in the center of the core until the core stops on the back of the cabinet.
- Install the clean filters.

# OPERATION

A Heat Recovery Ventilator (HRV) is designed to bring fresh air into a building while exhausting an equal amount of stale air. During the winter months, the incoming cold fresh air is warmed by utilizing the heat recovered from the stale air before it is exhausted to the outdoors. During summer months when the indoor space is air conditioned, the HRV will help in cooling the incoming fresh air with the stale air that is being exhausted.

The VHR 704R is designed to run continuously or on intermittently, giving the homeowner complete control over their air quality. Continuous low speed ventilation is recommended, which will help eliminate carbon dioxide, voc's and other gases as well as freshen up the home. Intermittent high speed ventilation can be obtained through a variety of optional remote controls found in this manual. Below are some examples of seasonal operation of an HRV.



## Winter:

Humidity control is very important during the winter months. This is when problems will be most apparent since condensation on the windows will often occur. The colder the outside temperature, the greater the risk of condensation in the home. The average relative humidity should be maintained between (30% and 60%) to avoid condensation. Low speed continuous ventilation with high speed override is recommended.

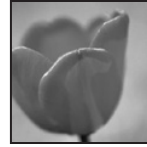

## Spring:

Temperatures are more moderate and become warmer each day. To keep the humidity and temperature uniform, set the dehumidistat higher (if installed). You may also switch the HRV to standby mode if desired.



## Summer:

The air is sometimes hot and humid. To stop the warm humid air from entering, set the dehumidistat at its highest level. If the Intellitek series controller is installed, the air exchanger can be set to cycle the unit on and off as desired from that wall control. However, continuous ventilation is recommended.

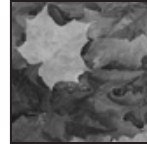

## Fall:

Rain and rapid temperature changes make it difficult to control the internal humidity level and may result in condensation on the windows. A remote dehumidistat may help give greater control over the inside environment.

# MODES OF OPERATION

The entire line of SHR/VHR series Heat Recovery Ventilators comes equipped with Fantech's new electronic uni-control board which offers a wide variety of features making it the ultimate ventilation control system. Fantech engineers have used the latest technology to provide solid, trouble free operation under any conditions.

The Fantech uni-control board offers stand alone operating capabilities as well as an exclusive 2 wire communication to most external controls. The trouble-free optional controls include: two different rotary dial dehumidistats, an air quality sensor (3 wire communication required), a 15 minute remote push-button timer, as well as the most sophisticated line of remote wall mounted controls, the Intellitek 5MR.

An on-board diagnostic LED helps find problems quickly and efficiently. For example the LED can be used to signal a broken or shorted electronic wall control wire. Electronic air temperature probe gives this board accurate readings in order to minimize unnecessary defrost operation, and the on-board jumpers provide the user with the option of adjusting defrost time and sequence to optimize performance under abnormal conditions. The defrost operation is automatic and is usually never adjusted.

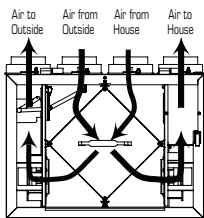

## 1. Continuous / Ventilation Mode

In this mode of operation both fans are operating and exchanging air with the outside. The heat recovery ventilator (HRV) constantly exchanges the air at the rate you select, either at low or medium speed, and switches to high speed when activated by an optional remote control. The "Low" and "Med" fan speed selection will cause the unit to operate

in continuous exchange mode at an exchange rate of 35% and 50% maximum airflow rating respectively. Continuous mode is recommended, since pollutants are slowly but constantly being generated in your house.

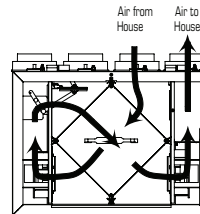

## 2. Defrost

The automatic defrost sequence is activated at an outdoor temperature of 23°F (-5°C) and lower. During the defrost sequence, the fresh air is interrupted momentarily and indoor air is allowed to recirculate in the exchanger to maximize the effectiveness of the defrost strategy. The unit then returns to normal operation until

the next defrost sequence.

# OPERATION (CONT'D)

## PRACTICAL TIPS

To avoid window condensation:

- It is not necessary to change the humidity control every day. Monitor the average weekly temperature or experiment with various settings until you find a level that is comfortable for you. Adjust the control when needed.

NOTE:

A dehumidistat is ideal for use in energy efficient houses where indoor humidity (during the heating season) is higher than outdoor levels. High humidity is a major cause of structure damage and IAQ problems such as mold and mildew.

## PRACTICAL TIPS

NOTE:

When an Intellitek control is installed, the rocker switch located on the right hand side of the HRV will be automatically deactivated giving the user complete control from wherever he/she wishes to mount the control pad.

NOTE:

The override speed cannot be set at a fan speed lower or equal to the normal operating fan speed. For example, if the unit is normally operating at a medium fan speed, the override fan speed will be automatically set to high.

NOTE:

EDF5 model, changing the override speed will change default override speed for other external controls.

EXAMPLES:

If on the EDF5 control, you have set the override control at medium, and you start an external remote control (15 min. timer), the unit will run at medium speed for 15 min.

# OPTIONAL REMOTE CONTROLS

\* All controls are low voltage. 18 to 24 gauge wire is recommended.



2 wire installation

**Dehumidistat I** - The wall mount dehumidistat monitors the humidity level in the area it is installed. When the humidity level rises above the desired set-point, the HRV will activate to high speed/override mode. Once the humidity level returns to desired condition, the unit will return to the normal mode.



4 wire installation

**Dehumidistat II** - The wall mount dehumidistat II offers the same features of the dehumidistat I plus additional off/on control for the HRV. Dial illuminates when in override mode.



3 wire installation

**RTS 3** - The RTS 3 is designed to provide an intermittent boost to the Heat/Energy recovery ventilator. Depressing the fan control button will energize the HRV/ERV system into high speed from a low or standby mode. The ventilator can be set to continue on high for 20, 40, or 60 minutes by pressing the control button one, two or three times. Pressing the button a fourth time will cancel the timing function.



2 wire installation

**EDF 1** - The EDF 1 is designed to provide 3 modes of operation to the Heat/Energy recovery ventilator. Pressing the "Push" button once initiates the unit to run at a continuous low speed of operation (green). Depressing the button twice allows the ventilator to run for 20 minutes and then turns off for 40 minutes (yellow). Touch the button a third time and the system will run continuous on high (red). The ventilation system will stay on the last function selected until it is changed.



2 wire installation

**20-min Timer** - The 20-minute remote timer is typically installed in areas where contaminated such as moisture and odors, are produced. Simply push the button and the HRV will activate to high speed for 20 minutes. Up to 5 electronic timers can be installed throughout the building at a distance of up to 500 feet (152 meters) from the HRV.

# OPTIONAL CONTROL

## DIGITAL DISPLAY

Shows Indoor Humidity Level  
This control will not read below 29% RH

## DEHUMIDISTAT CONTROL

(see description on top of this page)

## OVERRIDE TIMER

When pressed, unit will provide high speed ventilation for one 15, 30 or 60 minute period.

## MAINTENANCE LIGHT

Light comes on when it's time to clean unit.

## POWER

On/Off and Reset

## MODES

Select Intermittent, Recirculation or Continuous Ventilation Modes

## MODE SPEED

Set Unit to Low, Medium or High Speed

## CYCLE CONTROL

Set unit to cycle on 15, 20, or 30 minutes every hour

## OVERRIDE SPEED CONTROL

Push to select override speed of unit.

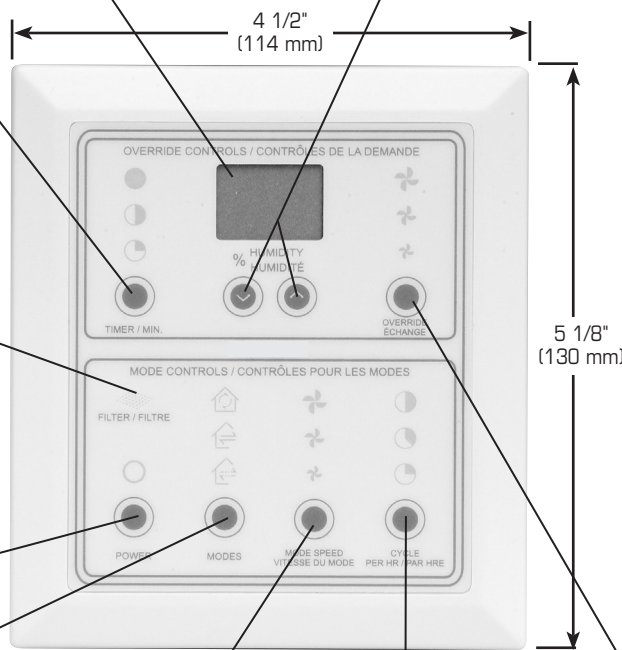

## EDF5 MULTI-FUNCTION WALL CONTROL

Control multiple functions of your HRV with one slimline wall control. Two wire connection simplifies installation. Use one EDF5 per HRV installed.

# TROUBLESHOOTING

Problem	Causes	Solutions
Air is too dry	Dehumidistat control is set too low HRV out of balance	Increase the desired level of humidity. Change ventilation mode from continuous mode to standby. Balance HRV
Air is too humid	Dehumidistat control is set too high Sudden change in temperature Storing too much wood for heating Dryer vent exhaust is inside home Poor air circulating near windows HRV out of balance Well sealed basement door is closed	Reduce the desired level of humidity. Combine this step with use of continuous exchange mode. Wait until outside temperature stabilizes (winter). Heating will also improve situation. Store a majority of your wood outside. Even dried, a cord of wood contains more than 20 gallons of water. Arrange outside vent for dryer. Open curtains or blinds. Bay or bow windows may require mechanical method. Balance HRV Open the door or install a grill on the door.
Persistent condensation on window	Improper adjustment of dehumidistat control HRV out of balance	Reduce the desired level of humidity. Combine this with the use of continuous exchange mode. Balance HRV
Poor Air Flows	-1/4" (6mm) mesh on the outside hoods is plugged -Filters plugged -Core obstructed -House grilles closed or blocked -Dampers are closed if installed -Poor power supply at site -Ductwork is restricting HRV -Improper speed control setting -HRV airflow improperly balanced	-Clean exterior hoods or vents -Remove and clean filter -Remove and clean core -Check and open grilles -Have electrician check supply voltage at house -Check duct installation -Increase the speed of the HRV -Have contractor balance HRV
Supply air feels cold	-Poor location of supply grilles, the airflow may irritate the occupant -Outdoor temperature extremely cold	-Locate the grilles high on the walls or under the baseboards, install ceiling mounted diffuser or grilles so as not to directly spill the supply air on the occupant (eg. Over a sofa) -Turn down the HRV supply speed. A small duct heater (1kw) could be used to temper the supply air -Placement of furniture or closed doors is restricting the movement of air in the home -If supply air is ducted into furnace return, the furnace fan may need to run continuously to distribute ventilation air comfortably -Balanced HRV
HRV and / or Ducts Frosting up	-HRV air flows are improperly balanced -Malfunction of the HRV defrost system	-Note: minimal frost build-up is expected on cores before unit initiates defrost cycle functions -Have HVAC contractor balance the HRV
Condensation or Ice Build Up in Insulated Duct to the Outside	-Incomplete vapor barrier around insulated duct -A hole or tear in outer duct covering	-Tape and seal all joints -Tape any holes or tears made in the outer duct covering -Ensure that the vapor barrier is completely sealed.

# ELECTRICAL CONNECTIONS

Observe polarity on all accessory controls where applicable.

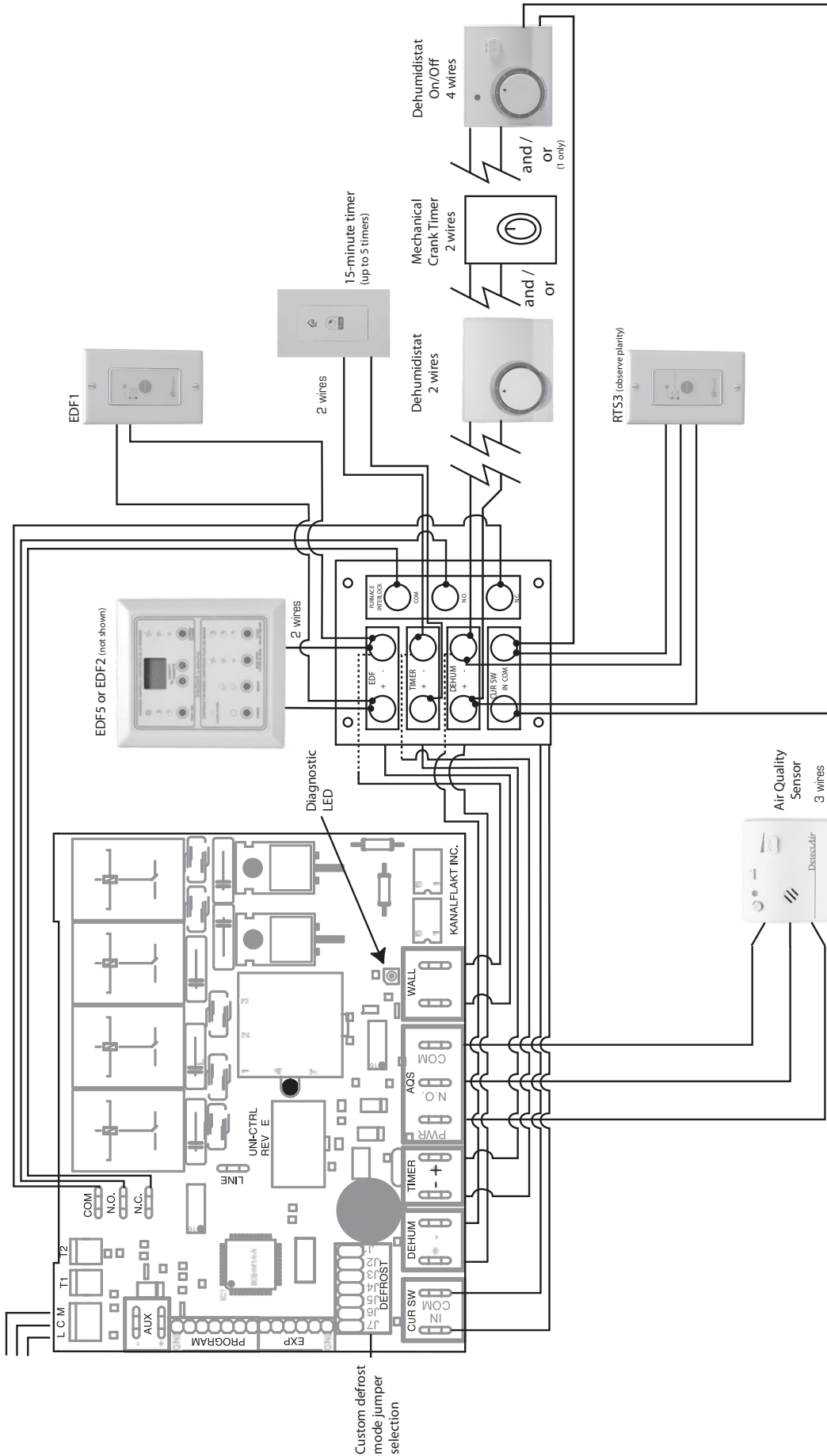

\* Wiring diagram of complete unit inside of access panel

# ELECTRICAL CONNECTIONS

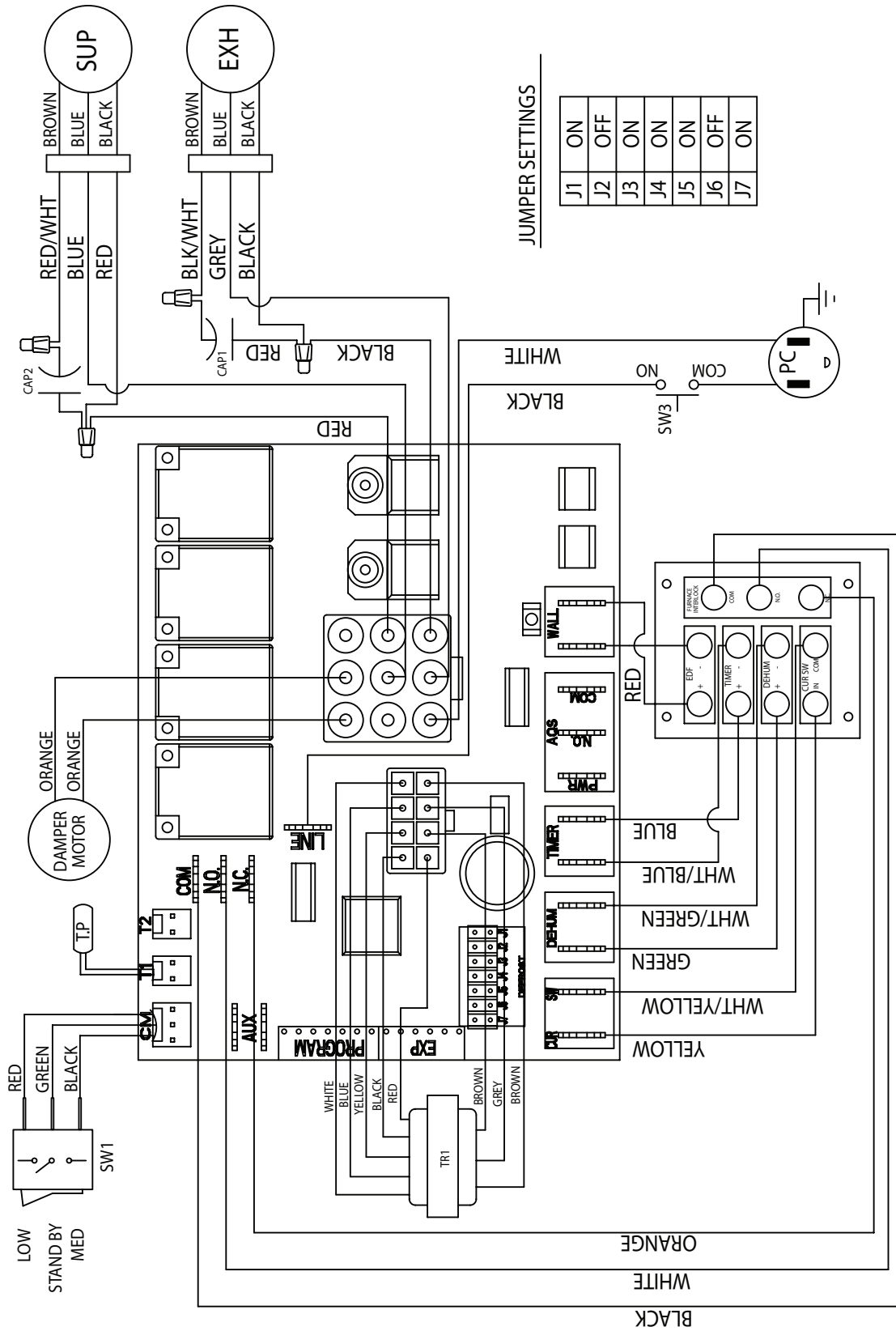

# ELECTRICAL CONNECTIONS (CONT'D)

## ELECTRICAL CONNECTION TO A FURNACE

### PRACTICAL TIPS

**Caution:**

- Never connect a 120 volt AC circuit to the terminals of the Accessory Control Contacts. Only use the low voltage class 2 circuit of the furnace blower control.

**For a Furnace Connected to a Cooling System:**

- On some older thermostats, energizing the R and G terminals at the furnace has the effect of energizing Y at the thermostat and thereby turning on the cooling system. If you identify this type of thermostat, you must use the "Alternate Furnace Interlock Wiring".

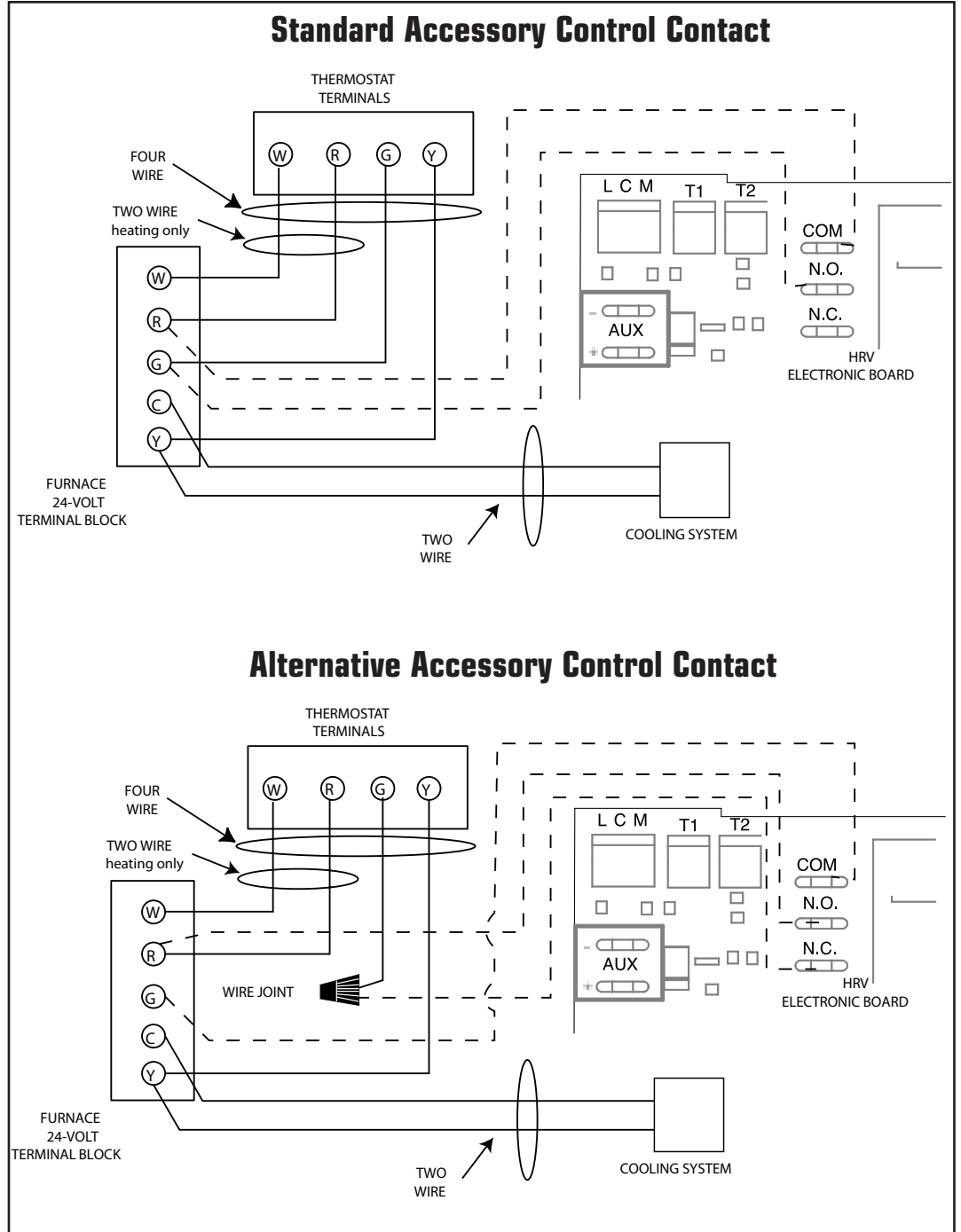

**United States**

10048 Industrial Blvd.  
 Lenexa, KS 66215  
 Phone: 800.747.1762; 913.752.6000  
 Fax: 800.487.9915; 913.752.6466  
 www.fantech.net; info@fantech.net

**Canada**

50 Kanalfakt Way,  
 Bouctouche, NB E4S 3M5  
 Phone: 800.565.3548; 506.743.9500  
 Fax: 877.747.8116; 506.743.9600

Distributed by:

Fantech, reserves the right to modify, at any time and without notice, any or all of its products' features, designs, components and specifications to maintain their technological leadership position.

Item #: 404663  
 Rev Date: 110909