



Instruction Sheet

102-067A

Timer and Aquastat

SUPERSEDES: May 1, 2010

EFFECTIVE: October 1, 2010

Plant ID# 001-3969

Application:

The Taco Clock Timer/Temperature Aquastat combination is designed to cycle the circulator during peak demand periods. The Analog Timer (No. 265-1) is adjustable to 15 minute intervals within a 24 hour time frame. The Digital Timer (No. 265-3) can be programmed for 7 day operation. The Temperature Aquastat (No. 563-2) automatically switches the circulator ON at 95°F and OFF at 115°F. The two can be used in combination, or they can be used separately. When the Clock Timer/Temperature Aquastat are used together, the Timer switches ON sending power to the unit. The Temperature Aquastat measures the temperature, and cycles the circulator as long as the Timer is switched to the ON mode.

If used separately, the Clock Timer operates the circulator during the chosen number of ON/OFF intervals. When using only the Temperature Aquastat, the circulator cycles intermittently to maintain a temperature between 95°F and 115°F.

The Clock Timer and Temperature Aquastat are easy to retrofit to any "00" Series Circulator. The user-friendly 24 hour analog clock has an hour hand, raised minute hand for ease of adjustment, two directional arrows, and AM/PM time settings. Our easy to program digital timer provides maximum convenience, comfort and energy savings. The Clock Timer can be mounted in any direction by just attaching it to the capacitor box electrical connection hole.

Installation: FOLLOW ALL INSTRUCTIONS IN THE SEQUENCE THAT THEY APPEAR.

Analog Timer Installation Instructions:

1. Disconnect the electrical supply. Remove circulator terminal box screw and cover.
2. Loosen Timer box cover screw and remove cover.
3. Assemble the back portion of the Timer to the "00" terminal box as shown in the Timer installation diagram (006 circulator pictured). Make sure that the protruding tang on the back of the Timer box fits under the circulator's terminal box base. Adjust until the two terminal box openings are aligned.
4. Secure the locknuts. Feed the yellow and white circulator lead wires into the Timer through the bushing. Reassemble circulator terminal box cover and secure with the screw.
5. See electrical hook-up for Timer wiring.

Aquastat Installation Instructions:

1. Disconnect the electrical supply. Securely fasten the Aquastat clip to 3/4" pipe or to the circulator casing for 1/2" pipe applications. The Aquastat must be properly fastened to insure a good reading.
2. See electrical hook-up for Aquastat wiring.

Electrical Hook-Up:



1. All electrical work must be performed by an electrician in accordance with the latest edition of the National Electrical Codes and Local Codes and Regulations.
2. Verify that the voltage, phase and frequency are correct for the Circulator, Timer and Aquastat prior to connection.
3. Follow the appropriate wiring diagram

NOTE: To run Digital Timer in Manual **ON** (I) mode, press the (R) Reset key first.

Analog 24 Hour Timer Programming:

1. Set clock to the exact time of day by turning the outer black ring clockwise to move the hour/minute hands to the correct position. Pay special attention to the white arrow pointing to the correct **AM/PM** time in the 24 hour outer ring.
2. Set the desired **ON/OFF** times by pushing the trippers away from the clock face for **ON** operation. Leave the trippers toward the clock face for **OFF** operation. Each tripper represents a 15 minute interval.
3. Set switch in the middle position for  automatic operation.

Analog Timer Manual Switch Settings:

1. Up = On, Constant Circulation 
2. Middle = Automatic operation 
3. Down = Off 

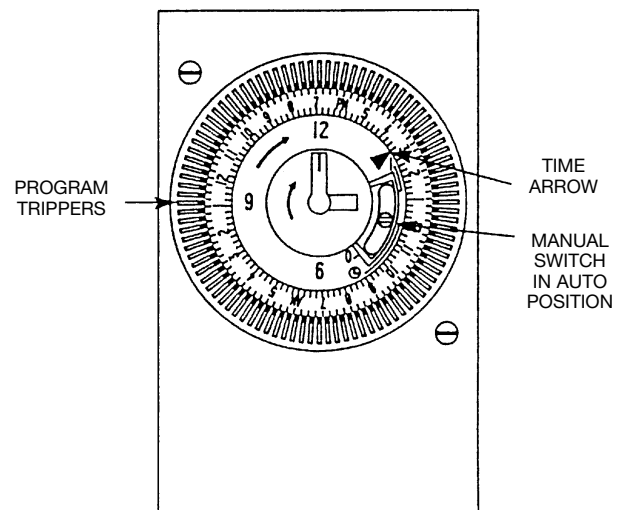

Analog Timer Clock Face



Digital 7 Day Programmable Timer:

The Plumb n' Plug (PNP) digital timer features a large LCD display with user friendly keys for setting time and run programs. An internal re-chargeable battery holds programmed settings for up to 4 days during power outages.

Note: Although the Plumb n' Plug digital timer contains some degree of spike and electrical noise protection, as with all electronic devices, these units can be affected by electrical noise. It is recommended that they be powered from a voltage source that has no switching devices or inductive loads connected.

Technical Data:

- Programs: 8 ON settings, odd numbered 1-15
- 8 OFF settings, even numbered 2-16
- Daylight time changeover: Manual
- Manual 3-way override switch: On-Auto-Off
- Reserve Battery Charge: - 4 days
- Full recharge in 48 hours
- Input Voltage rating: 125V, 60Hz, 15A

Clock Face Description:

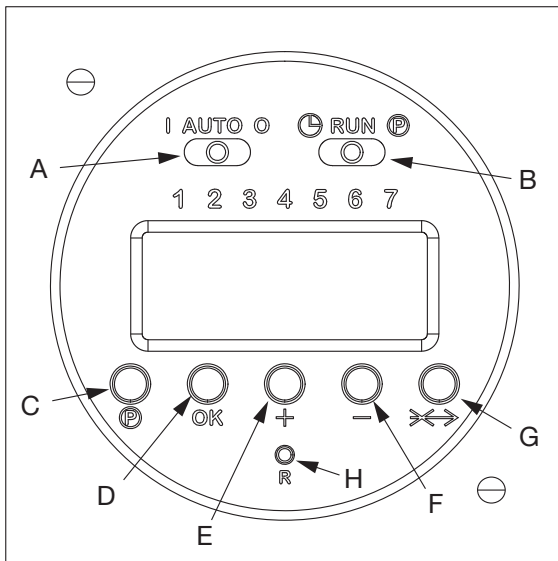

Function Switches:

- A. Manual Operation Switch: (I) ON, (AUTO) Automatic, (O) OFF
- B. Programming Switch: \odot to set current time, (RUN) run mode, (P) to program timer

Key Pad Selectors:

- C. (P) Program Selection
- D. (OK) to confirm setting and advance to next program
- E. (+) Week, Hr, Minute, Second – forward 1 unit at a time, press & hold to scroll rapidly
- F. (-) Week, Hr, Minute, Second – reverse 1 unit at a time, press & hold to scroll rapidly
- G. (\rightleftarrows) Skip key, to change to next screen
- H. (R) To RESET timer and erase all programs

Programs:

The PNP digital timer will accept up to 16 programs. A program consists of:

- 1- ON or OFF setting
- 1- Time of Day setting (Hour, Minute & Second)
- 1- Day(s) of Operation setting

Note: Each ON setting must be matched with a corresponding OFF setting.

Programming your Digital Timer:

A. Setting the current time on the LCD display

1. Move Programming Switch to \odot
2. Press the (R) Reset key. Clock face will display "AM 12:00".

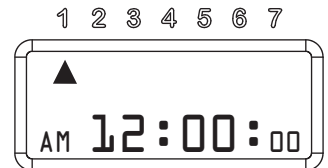

3. DAY arrow will flash below the number 1 (Monday). Press the (+) or (-) key to move arrow to the correct day (1= Mon, 2= Tues, 7= Sun, etc), then press (OK). HOUR will flash.
4. Press (+) or (-) to change HOUR to current time, be sure the AM/PM symbol is correct, then press (OK). MINUTE will flash.
5. Press(+) or (-) to change MINUTES to correct time, then press (OK). SECONDS will flash.
6. Since SECONDS will not be used, simply press (OK). Your current time is set.
7. Move Programming Switch to RUN.

B. Programming the Digital Timer ON/OFF settings

NOTE: It is helpful to write out the program timer schedules before beginning programming. See last page for an example.

To program timer for ON operation

1. Move Programming Switch to (P), display will show "-01-". This is your first ON setting.
2. Press (P) Program Selection Key. Display will read "--:--".

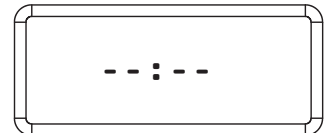
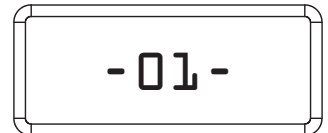

3. Press (+) key. Display will show a flashing arrow below the numbers 1-7 (Monday-Sunday), the time will read "AM 12:00:00" and a light bulb will appear to the right of the time, signifying an ON time setting. Press the (+) or (-) key to move the arrow through the DAY selection options:

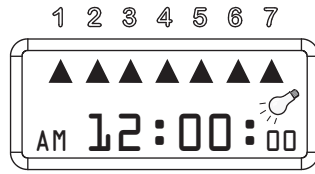

DISPLAY ARROW INDICATOR	DAYS
1	MONDAY
2	TUESDAY
3	WEDNESDAY
4	THURSDAY
5	FRIDAY
6	SATURDAY
7	SUNDAY
1 2 3 4 5	MON - FRI
6 7	SAT - SUN
1 2 3 4 5 6	MON - SAT
1 2 3 4 5 6 7	MON - SUN

4. When correct DAY(S) setting is selected, press (OK), HOUR time will flash.
5. Press (+) or (-) key to set HOUR to the desired time. Be sure the "AM/PM" symbol is correct. Then press (OK), MINUTES time will flash.
6. Press (+) or (-) key to set MINUTES to desired time. Then press (OK), SECONDS will flash.
7. Since SECONDS are not necessary, simply press (OK). Your first ON time is set.
8. Press (P) Program Selection key to finish. Display will show "-02-". Timer is now ready for an OFF timer program.



To program timer for OFF operation

- Repeat steps 2 thru 8 to complete OFF time setting. For OFF settings, no light bulb will appear on the clock face.

Repeat the above procedure to program each ON (odd number) and OFF (even number) desired time setting, in sequential order. Refer to Timer Schedule below.

To finish and set digital timer to AUTO operation

- When all programs are completed, move Programming Switch (P) to RUN position.
- Move Manual Operation switch to AUTO. Timer will now operate ON/OFF according to programmed settings.

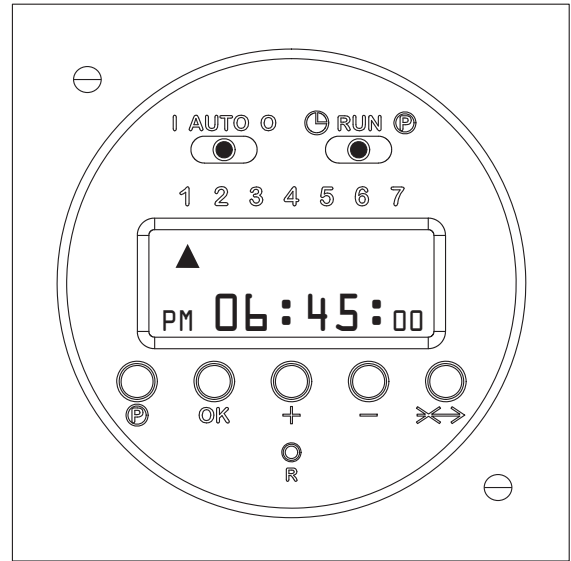

PNP Digital Timer Program Schedules (Example)

PROGRAM	ON/OFF	DAYS	HOUR	MINUTE
01	ON	MON, TUE, WED, THURS, FRI	6 AM	00
02	OFF	MON, TUE, WED, THURS, FRI	8 AM	00
03	ON	MON, TUE, WED, THURS, FRI	4 PM	30
04	OFF	MON, TUE, WED, THURS, FRI	8 PM	00
05	ON	SATURDAY and SUNDAY	7 AM	00
06	OFF	SATURDAY and SUNDAY	9 AM	00
07	ON	SATURDAY and SUNDAY	4 PM	30
08	OFF	SATURDAY and SUNDAY	7 PM	30

**Timer Installation Diagram
(006 Circulator Shown)**

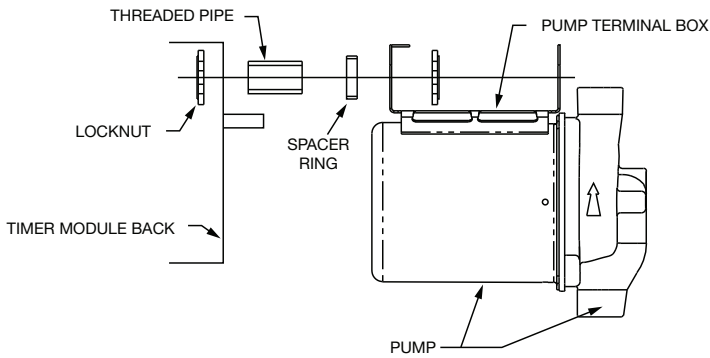

Aquastat Only Wiring Diagram

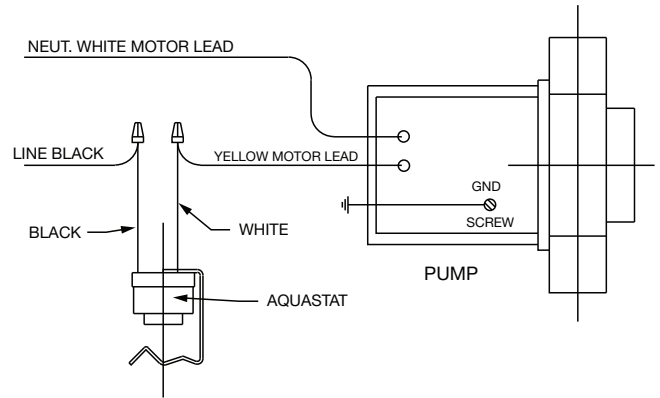

Timer and Aquastat Wiring Diagram

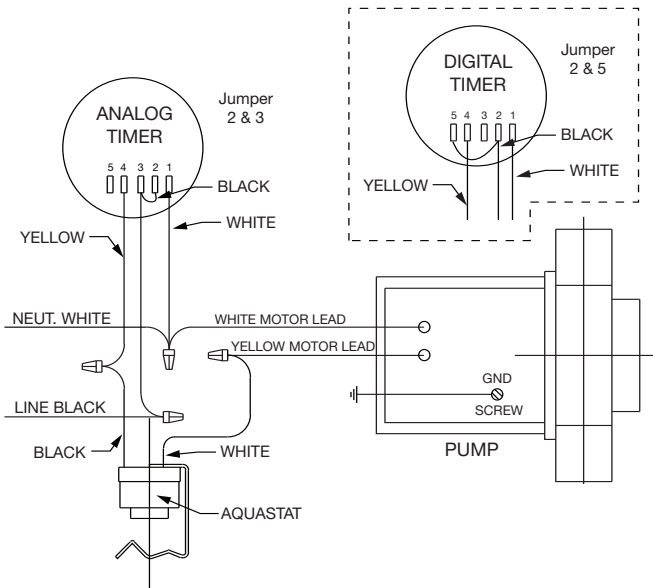

Timer Only Wiring Diagram

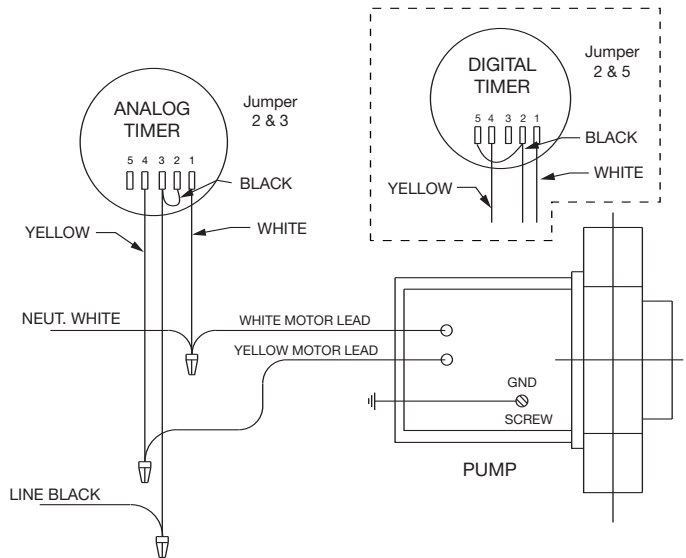

LIMITED WARRANTY STATEMENT

Taco, Inc. will repair or replace without charge (at the company's option) any Taco 00 Series circulator or circulator part which is proven defective under normal use within three (3) years from the date of manufacture.

In order to obtain service under this warranty, it is the responsibility of the purchaser to promptly notify the local Taco stocking distributor or Taco in writing and promptly deliver the subject product or part, delivery prepaid, to the stocking distributor. For assistance on warranty returns, the purchaser may either contact the local Taco stocking distributor or Taco. If the subject product or part contains no defect as covered in this warranty, the purchaser will be billed for parts and labor charges in effect at time of factory examination and repair.

Any Taco product or part not installed or operated in conformity with Taco instructions or which has been subject to misuse, misapplication, the

addition of petroleum-based fluids or certain chemical additives to the systems, or other abuse, will not be covered by this warranty.

If in doubt as to whether a particular substance is suitable for use with a Taco product or part, or for any application restrictions, consult the applicable Taco instruction sheets or contact Taco at (401-942-8000).

Taco reserves the right to provide replacement products and parts which are substantially similar in design and functionally equivalent to the defective product or part. Taco reserves the right to make changes in details of design, construction, or arrangement of materials of its products without notification.

TACO OFFERS THIS WARRANTY IN LIEU OF ALL OTHER EXPRESS WARRANTIES. ANY WARRANTY IMPLIED BY LAW INCLUDING WARRANTIES OF MERCHANTABILITY OR FITNESS IS IN EFFECT ONLY FOR THE DURA-

TION OF THE EXPRESS WARRANTY SET FORTH IN THE FIRST PARAGRAPH ABOVE.

THE ABOVE WARRANTIES ARE IN LIEU OF ALL OTHER WARRANTIES, EXPRESS OR STATUTORY, OR ANY OTHER WARRANTY OBLIGATION ON THE PART OF TACO.

TACO WILL NOT BE LIABLE FOR ANY SPECIAL, INCIDENTAL, INDIRECT OR CONSEQUENTIAL DAMAGES RESULTING FROM THE USE OF ITS PRODUCTS OR ANY INCIDENTAL COSTS OF REMOVING OR REPLACING DEFECTIVE PRODUCTS.

This warranty gives the purchaser specific rights, and the purchaser may have other rights which vary from state to state. Some states do not allow limitations on how long an implied warranty lasts or on the exclusion of incidental or consequential damages, so these limitations or exclusions may not apply to you.

COMFORT MADE EASY®

TACO, INC., 1160 Cranston Street, Cranston, RI 02920 Telephone: (401) 942-8000 FAX: (401) 942-2360.

TACO (Canada), Ltd., 8450 Lawson Road, Unit #3, Milton, Ontario L9T 0J8. Telephone: 905/564-9422. FAX: 905/564-9436.

Visit our web site at: <http://www.taco-hvac.com>

Printed in USA

Copyright 2010

TACO, Inc.