

Features

- Brass construction.
- Brass valve bodies.
- Cast brass waterway.
- Quarter-turn washerless ceramic disc valves.
- 4-7/8" (124 mm) spout reach.
- Stationary spout.
- Metal pop-up drain with lift rod and tailpiece.
- ADA compliant ceramic lever handles.
- Single-hole or 6" (152 mm) escutcheon plate for 3-hole installation.
- 1.5 gal/min (5.7 l/min) maximum flow rate [max at 60 psi (4.14 bar)].



ADA **CSA B651** **OBC**

Codes/Standards

ASME A112.18.1/CSA B125.1

NSF 61

NSF 372

DOE - Energy Policy Act 1992

EPA WaterSense®

ADA

ICC/ANSI A117.1

CSA B651

OBC







All applicable US Federal and State material regulations

KOHLER® Faucet Lifetime Limited Warranty

See website for detailed warranty information.

Available Color/Finishes

Color tiles intended for reference only.

Color	Code	Description
	CP	Polished Chrome
	SN	Vibrant® Polished Nickel
	AF	Vibrant® French Gold
	G	Brushed Chrome
	BN	Vibrant® Brushed Nickel
	BV	Vibrant® Brushed Bronze

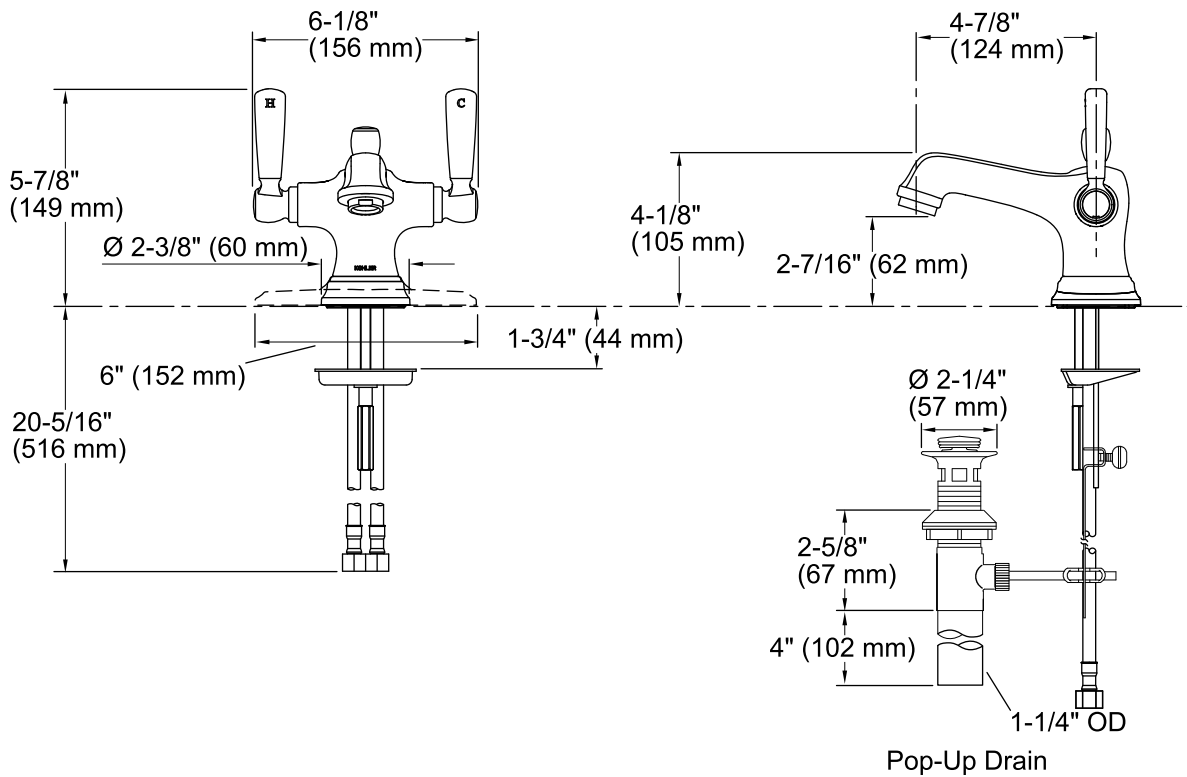

Technical Information

All product dimensions are nominal.

Spout reach: 4-7/8" (124 mm)

Drain included: YES

Drain tailpiece included: YES

Faucet:

Flow rate: 1.5 gal/min (5.7 l/min)

Pressure: 60 psi (4.1 bar)

Notes

Install this product according to the installation guide.

ADA, OBC, CSA B651 compliant when installed to the specific requirements of these regulations.