



Specified Fittings

"The PVC and HDPE Fittings Experts"



PVC
FITTINGS
2019

Contact Us Today!: (360) 398-7700



PVC FITTINGS 2019

PIP: Gasketed 3

PIP: Solvent Weld 17

PIP: Lowhead 31

Surface 41

Heat & Air 45

IPS for Agriculture 49

IPS Pressure 63

C-900 Gasketed Pressure 71

Spec-Loc: C-900 & IPS 99

SCH40/80 Pressure 105

C-900 Gasketed Non-Pressure 111

SCH40 Non-Pressure Gasketed 119

Sewer/Profile 125

CSA Approved Sewer 145

Duct: PVC & CPVC 161

Drain Basins 169



**Specified
Fittings**

Threaded Fittings

Threaded fittings through 48" are available from Specified. We thread in male/female, straight, NST, or any other thread type. Our machine shops in Bellingham and Stevensville have broad capabilities in this area. Whether a one-off or multiples, we can handle the request! ■

Dissimilar Outlets

All tees, crosses, and wyes made by Specified Fittings in any of our products groups can be made with dissimilar outlets. For example, an 8x8x4 tee with gasketed SDR35 bells on the run and corrugated ADS on the outlet, or an 8x8x8 cross with gasketed C-900 bells on the run and solid wall HDPE on the outlet. There is no limit other than imagination to the permutations we can do! ■

Perforating

Do not forget Specified Fittings for perforated pipe in PVC and HDPE. Whether a little or a lot, we will give you a quote on your perforating specs no matter how unusual. ■



PVC FITTINGS

PIP: GASKETED SDR81 - SDR32.5



Specified Fittings

ADAPTER

PIP X IPS

FEMALE X FEMALE



Size	PartNumber	SDR 51: 80	SDR 41:	SDR 32.5:
		PSI (14)	100 PSI (15)	125 PSI (16)
6x2	__1056-2IPS	\$84.68	\$94.09	\$117.61
6x3	__1056-3IPS	\$86.40	\$96.00	\$120.00
6x4	__1056-4IPS	\$52.37	\$53.99	\$69.21
6	__1056-IPS	\$64.39	\$66.38	\$83.87
8x2	__1058-2IPS	\$107.21	\$119.12	\$148.90
8x3	__1058-3IPS	\$109.39	\$121.55	\$151.93
8x4	__1058-4IPS	\$110.50	\$122.78	\$163.14
8x6	__1058-6IPS	\$75.24	\$77.57	\$99.45
8	__1058-IPS	\$87.61	\$90.31	\$115.03
10x2	__10510-2IPS	\$174.52	\$193.91	\$242.39
10x3	__10510-3IPS	\$178.06	\$197.85	\$247.31
10x4	__10510-4IPS	\$179.86	\$199.85	\$249.81
10x8	__10510-8IPS	\$106.97	\$110.28	\$141.39
10	__10510-IPS	\$128.02	\$131.98	\$167.74
12x2	__10512-2IPS	\$238.37	\$264.86	\$331.07
12x3	__10512-3IPS	\$243.21	\$270.24	\$337.80
12x4	__10512-4IPS	\$245.67	\$272.97	\$341.21
12x10	__10512-10IPS	\$169.13	\$174.36	\$223.54
12	__10512-IPS	\$213.20	\$219.80	\$279.35
15x3	__10515-3IPS	\$351.22	\$390.24	\$487.80
15x4	__10515-4IPS	\$358.38	\$398.20	\$497.75
15x12	__10515-12IPS	\$346.46	\$357.18	\$446.31
15 x 16	__10515-16IPS	\$540.78	\$567.82	\$628.55
16x3	__10516-3IPS	\$556.59	\$618.44	\$773.05
16x4	__10516-4IPS	\$539.41	\$599.35	\$749.21
18.7x3	__10518.7-3IPS	\$761.97	\$846.63	\$1,015.96
18.7x4	__10518.7-4IPS	\$720.44	\$800.49	\$960.59
21x3	__10521-3IPS	\$1,056.16	\$1,173.51	\$1,408.22
21x4	__10521-4IPS	\$1,078.66	\$1,198.51	\$1,438.21
24x3	__10524-3IPS	\$1,608.93	\$1,787.70	\$2,145.24
24x4	__10524-4IPS	\$1,625.17	\$1,805.74	\$2,166.89
24x24	__10524-24IPS	\$866.72	\$893.53	\$1,145.55
27x3	__10527-3IPS	\$2,055.71	\$2,284.12	\$2,740.95
27x4	__10527-4IPS	\$2,097.67	\$2,330.75	\$2,796.90

CAP

FEMALE



Size	PartNumber	SDR 51: 80	SDR 41:	SDR 32.5:
		PSI (14)	100 PSI (15)	125 PSI (16)
6	__1906	\$78.42	\$80.85	\$90.31
8	__1908	\$115.40	\$118.97	\$143.29
10	__19010	\$186.17	\$191.93	\$224.14
12	__19012	\$249.43	\$257.14	\$323.13
15	__19015	\$358.07	\$369.15	\$522.17
18.7	__19018.7	\$673.30	\$694.12	\$847.93
21	__19021	\$974.87	\$1,005.02	\$1,343.80
24	__19024	\$1,364.19	\$1,406.38	\$1,701.64
27	__19027	\$1,525.12	\$1,572.29	\$1,791.17

PLUG

MALE



Size	PartNumber	SDR 51: 80	SDR 41:	SDR 32.5:
		PSI (14)	100 PSI (15)	125 PSI (16)
6	__5606	\$34.36	\$35.06	\$44.17
8	__5608	\$78.85	\$80.45	\$106.48
10	__56010	\$127.54	\$130.15	\$170.77
12	__56012	\$148.15	\$151.17	\$198.89
15	__56015	\$247.48	\$252.53	\$331.54
16	__56016	\$300.04	\$306.17	\$401.88
18.7	__56018.7	\$352.61	\$359.80	\$472.20
21	__56021	\$536.33	\$547.27	\$719.36
24	__56024	\$671.35	\$685.05	\$904.19
27	__56027	\$857.90	\$875.40	\$1,131.23

A WORD ABOUT OUR HOURS

We try to have hours that work for our East Coast customers:
Stevensville opens at 7:30 AM (9:30 AM ET) and closes at 5PM (7PM ET).

Bellingham opens at 6AM (9AM ET) and closes at 5PM (8PM ET).

The importance of these hours other than early access to our sales force is the late night shipping possibilities. If you need something shipped for next day delivery, and you are in an Eastern Time Zone, you could order up to 7:30 your time, and still expect it the next day. In the emergency, "I don't care what the freight costs. My customer needs it here tomorrow" scenarios we will ship from stock up until 4PM or later from Stevensville or Bellingham. Because we have no minimum purchase requirement, whether you need a \$.50 PVC nipple or a \$500.00 stainless steel back up ring we will ship in-stock orders if you need it.

FEMALE X MALE



Size	PartNumber	SDR 51: 80	SDR 41:	SDR 32.5:
		PSI (14)	100 PSI (15)	125 PSI (16)
6	__1716	\$43.96	\$45.08	\$57.05
8	__1718	\$68.06	\$69.81	\$90.83
10	__17110	\$96.23	\$102.15	\$134.88
12	__17112	\$118.44	\$138.82	\$177.34
15	__17115	\$183.12	\$276.86	\$321.94
16	__17116	\$245.31	\$325.83	\$372.82
18.7	__17118.7	\$307.49	\$374.79	\$423.69
21	__17121	\$449.72	\$555.56	\$645.61
24	__17124	\$557.92	\$860.08	\$736.84
27	__17127	\$713.57	\$891.71	\$1,114.80

PVC GASKETED PIP FITTINGS

COUPLING

REPAIR

FEMALE X FEMALE



Size	PartNumber	SDR 51: 80	SDR 41:	SDR 32.5:
		PSI (14)	100 PSI (15)	125 PSI (16)
6	2206	\$74.81	\$78.74	\$101.19
8	2208	\$106.03	\$111.61	\$143.24
10	22010	\$167.74	\$179.05	\$230.69
12	22012	\$232.69	\$245.70	\$318.97
15	22015	\$348.50	\$365.86	\$474.52
16	22016	\$491.75	\$517.63	CF
18.7	22018.7	\$580.40	\$669.40	\$870.93
21	22021	\$802.58	\$1,070.76	\$1,392.84
24	22024	\$1,114.80	\$1,338.02	\$1,752.73
27	22027	\$1,427.02	\$1,783.42	\$2,322.77

STOP

FEMALE X FEMALE



Size	PartNumber	SDR 51: 80	SDR 41:	SDR 32.5:
		PSI (14)	100 PSI (15)	125 PSI (16)
6	2406	\$47.24	\$56.91	\$74.66
8	2408	\$77.68	\$93.59	\$122.52
10	24010	\$103.72	\$134.35	\$180.75
12	24012	\$150.52	\$166.69	\$239.79
15	24015	\$242.41	\$361.52	\$384.00
16	24016	\$327.23	\$394.25	\$471.69
18.7	24018.7	\$404.90	\$426.99	\$559.36
21	24021	\$506.12	\$690.30	\$809.54
24	24024	\$760.11	\$920.76	\$1,150.94
27	24027	\$980.70	\$1,111.51	\$1,439.38

REPAIR, BOLTED

FEMALE X FEMALE

12" OAL with Stainless Steel Bolts



Size	PartNumber	SDR 41: 100 PSI (15)
6	2076-12SS	\$242.75
8	2078-12SS	\$328.33
10	20710-12SS	\$332.88
12	20712-12SS	\$517.62
15	20715-12SS	\$585.15
16	20716-12SS	CF
18.7	20718.7-12SS	CF
21	20721-12SS	CF
24	20724-12SS	CF
27	20727-12SS	CF

12" OAL with Zinc Plated Bolts



Size	PartNumber	SDR 41: 100 PSI (15)
6	2076-12Z	\$116.66
8	2078-12Z	\$146.61
10	20710-12Z	\$176.70
12	20712-12Z	\$203.49
15	20715-12Z	\$369.47
16	20716-12Z	CF
18.7	20718.7-12Z	CF
21	20721-12Z	CF
24	20724-12Z	CF
27	20727-12Z	CF

18" OAL with Stainless Steel Bolts



Size	PartNumber	SDR 41: 100 PSI (15)
6	2076-18SS	\$296.57
8	2078-18SS	\$328.01
10	20710-18SS	\$433.87
12	20712-18SS	\$484.69
15	20715-18SS	\$699.36
16	20716-18SS	CF
18.7	20718.7-18SS	CF
21	20721-18SS	CF
24	20724-18SS	CF
27	20727-18SS	CF

18" OAL with Zinc Plated Bolts



Size	PartNumber	SDR 41: 100 PSI (15)
6	2076-18Z	\$132.99
8	2078-18Z	\$167.63
10	20710-18Z	\$230.79
12	20712-18Z	\$240.93
15	20715-18Z	\$421.54
16	20716-18Z	CF
18.7	20718.7-18Z	CF
21	20721-18Z	CF
24	20724-18Z	CF
27	20727-18Z	CF

PVC GASKETED PIP FITTINGS

CROSS

FEMALE X FEMALE X FEMALE X FEMALE



Size	PartNumber	SDR 51: 80	SDR 41:	SDR 32.5:
		PSI (14)	100 PSI (15)	125 PSI (16)
6x2	__2606-2IPS	\$142.77	\$158.63	\$210.80
6x3	__2606-3IPS	\$148.66	\$165.17	\$220.52
6x4	__2606-4IPS	\$151.70	\$168.55	\$225.93
6	__2606	\$157.95	\$175.50	\$236.79
8x2	__2608-2IPS	\$201.66	\$224.06	\$299.43
8x3	__2608-3IPS	\$209.97	\$233.30	\$312.41
8x4	__2608-4IPS	\$214.26	\$238.06	\$318.94
8x6	__26086	\$223.09	\$247.87	\$334.03
8	__2608	\$227.63	\$252.93	\$341.31
10x2	__26010-2IPS	\$304.84	\$319.75	\$427.06
10x3	__26010-3IPS	\$317.81	\$332.92	\$446.45
10x4	__26010-4IPS	\$324.91	\$339.72	\$456.18
10x6	__260106	\$339.43	\$353.73	\$475.66
10x8	__260108	\$347.00	\$360.95	\$485.36
10	__26010	\$354.54	\$368.32	\$496.28
12x2	__26012-2IPS	\$349.16	\$358.20	\$490.77
12x3	__26012-3IPS	\$364.29	\$372.97	\$513.56
12x4	__26012-4IPS	\$371.86	\$380.58	\$524.30
12x6	__260126	\$389.19	\$396.28	\$546.98
12x8	__260128	\$397.80	\$404.36	\$558.87
12x10	__2601210	\$406.40	\$412.62	\$570.96
12	__26012	\$508.42	\$529.00	\$714.64
15x3	__26015-3IPS	\$558.09	\$620.10	\$855.06
15x4	__26015-4IPS	\$569.48	\$632.75	\$873.44
15x6	__260156	\$592.96	\$658.84	\$910.19
15x8	__260158	\$605.06	\$672.29	\$929.67
15x10	__2601510	\$617.41	\$686.01	\$949.11
15x12	__2601512	\$630.01	\$700.01	\$968.57
15	__26015	\$793.90	\$915.77	\$1,236.43
18.7x3	__26018.7-3IPS	\$749.99	\$833.32	\$1,293.96
18.7x4	__26018.7-4IPS	\$765.29	\$850.33	\$1,320.97
18.7x6	__26018.76	\$796.85	\$885.39	\$1,376.10
18.7x8	__26018.78	\$813.11	\$903.46	\$1,404.21
18.7x10	__26018.710	\$829.71	\$921.90	\$1,433.39
18.7x12	__26018.712	\$846.64	\$940.71	\$1,463.66
18.7x15	__26018.715	\$881.55	\$979.50	\$1,525.28
18.7	__26018.7	\$1,220.63	\$1,383.37	\$1,870.15
21x3	__26021-3IPS	\$1,264.78	\$2,065.77	\$2,791.12
21x4	__26021-4IPS	\$1,290.70	\$2,108.42	\$2,848.42
21x6	__260216	\$1,344.75	\$2,195.49	\$2,966.24
21x8	__260218	\$1,372.93	\$2,240.89	\$3,027.31
21x10	__2602110	\$1,400.96	\$2,287.38	\$3,089.47
21x12	__2602112	\$1,430.15	\$2,335.03	\$3,153.25
21x15	__2602115	\$1,490.69	\$2,433.31	\$3,284.05
21x18.7	__2602118.7	\$1,585.81	\$2,585.73	\$3,491.72
21	__26021	\$2,020.57	\$3,293.26	\$4,116.57
24x3	__26024-3IPS	\$2,839.76	\$3,396.47	\$4,588.88
24x4	__26024-4IPS	\$2,898.13	CF	\$4,682.85
24x6	__260246	\$3,018.12	\$3,610.53	\$4,877.43
24x8	__260248	\$3,079.74	\$3,685.10	\$4,977.99
24x10	__2602410	\$3,143.52	\$3,760.76	\$5,079.57
24x12	__2602412	\$3,208.38	\$3,838.60	\$5,183.36
24x15	__2602415	\$3,341.34	\$3,997.50	\$5,397.38
24x18.7	__2602418.7	\$3,552.14	\$4,249.37	\$5,735.73
24x21	__2602421	\$3,700.68	\$4,425.84	\$5,973.41
24	__26024	\$4,344.17	\$5,194.47	\$7,028.11
27x3	__26027-3IPS	\$3,875.38	\$5,570.34	\$7,522.61
27x4	__26027-4IPS	\$3,955.34	\$5,684.93	\$7,677.19
27x6	__260276	\$4,119.65	\$5,920.58	\$7,993.94
27x8	__260278	\$4,203.97	\$6,041.65	\$8,157.15
27x10	__2602710	\$4,290.45	\$6,165.97	\$8,323.87
27x12	__2602712	\$4,378.47	\$6,292.44	\$8,494.42
27x15	__2602715	\$4,559.62	\$6,552.96	\$8,845.74
27x18.7	__2602718.7	\$4,846.08	\$6,963.74	\$9,400.29
27x21	__2602721	\$5,047.14	\$7,252.36	\$9,789.45
27x24	__2602724	\$5,150.49	\$7,401.41	\$9,990.06
27	__26027	\$6,044.89	\$8,687.29	\$11,753.92

ELBOW

11-1/4 DEGREE

FEMALE X FEMALE



Size	PartNumber	SDR 51: 80	SDR 41:	SDR 32.5:
		PSI (14)	100 PSI (15)	125 PSI (16)
6	__3106	\$75.13	\$83.47	\$98.20
8	__3108	\$111.20	\$123.57	\$146.84
10	__31010	\$166.16	\$183.12	\$215.46
12	__31012	\$225.71	\$264.10	\$311.82
15	__31015	\$397.80	\$436.19	\$516.25
16	__31016	\$514.08	\$579.29	\$855.71
18.7	__31018.7	\$630.35	\$722.38	\$865.58
21	__31021	\$931.01	\$1,001.74	\$1,302.52
24	__31024	\$1,540.99	\$1,751.20	\$2,188.97
27	__31027	\$1,993.49	\$2,254.97	\$2,737.17

15 DEGREE

FEMALE X FEMALE

Size	PartNumber	SDR 51: 80	SDR 41:	SDR 32.5:
		PSI (14)	100 PSI (15)	125 PSI (16)
6	__3206	\$75.13	\$83.47	\$98.20
8	__3208	\$111.21	\$123.57	\$146.84
10	__32010	\$166.16	\$183.12	\$215.46
12	__32012	\$225.71	\$264.10	\$311.82
15	__32015	\$397.80	\$436.19	\$516.25
16	__32016	\$521.36	\$579.29	\$695.15
18.7	__32018.7	\$630.35	\$722.38	\$858.70
21	__32021	\$955.66	\$1,001.74	\$1,302.52
24	__32024	\$1,540.99	\$1,751.20	\$2,188.97
27	__32027	\$1,993.49	\$2,258.98	\$2,737.17

PVC GASKETED PIP FITTINGS

ELBOW

22-1/2 DEGREE

FEMALE X FEMALE



Size	PartNumber	SDR 51: 80 PSI (14)	SDR 41: 100 PSI (15)	SDR 32.5: 125 PSI (16)
6	__3306	\$75.13	\$83.47	\$98.20
8	__3308	\$111.21	\$123.57	\$146.84
10	__33010	\$166.16	\$183.12	\$215.46
12	__33012	\$225.71	\$264.10	\$311.82
15	__33015	\$397.80	\$436.19	\$516.25
16	__33016	\$521.36	\$579.29	\$695.15
18.7	__33018.7	\$630.35	\$722.38	\$858.70
21	__33021	\$955.66	\$1,001.74	\$1,302.52
24	__33024	\$1,540.99	\$1,751.20	\$2,188.97
27	__33027	\$1,993.49	\$2,259.23	\$2,737.17

30 DEGREE

FEMALE X FEMALE

Size	PartNumber	SDR 51: 80 PSI (14)	SDR 41: 100 PSI (15)	SDR 32.5: 125 PSI (16)
6	__3406	\$88.13	\$97.93	\$118.97
8	__3408	\$124.95	\$138.82	\$167.61
10	__34010	\$179.70	\$199.29	\$237.15
12	__34012	\$241.88	\$283.69	\$338.78
15	__34015	\$492.32	\$574.09	\$641.40
16	__34016	\$591.97	\$693.79	\$829.26
18.7	__34018.7	\$691.62	\$813.48	\$1,017.12
21	__34021	\$1,030.66	\$1,225.75	\$1,448.19
24	__34024	\$1,653.92	\$1,879.77	\$2,348.83
27	__34027	\$2,234.20	\$2,541.69	\$3,053.10

45 DEGREE

FEMALE X FEMALE



Size	PartNumber	SDR 51: 80 PSI (14)	SDR 41: 100 PSI (15)	SDR 32.5: 125 PSI (16)
6	__3496	\$88.13	\$97.93	\$118.97
8	__3498	\$124.95	\$138.82	\$167.61
10	__34910	\$179.70	\$199.29	\$237.15
12	__34912	\$241.88	\$283.69	\$338.78
15	__35015	\$492.32	\$574.09	\$641.40
16	__35016	\$591.97	\$693.79	\$829.26
18.7	__35018.7	\$691.62	\$813.48	\$1,017.12
21	__35021	\$1,030.66	\$1,225.75	\$1,448.19
24	__35024	\$1,653.92	\$1,879.77	\$2,348.83
27	__35027	\$2,234.20	\$2,541.69	\$3,052.97

60 DEGREE

FEMALE X FEMALE

Size	PartNumber	SDR 51: 80 PSI (14)	SDR 41: 100 PSI (15)	SDR 32.5: 125 PSI (16)
6	__3606	\$98.92	\$110.69	\$139.74
8	__3608	\$159.48	\$177.20	\$215.46
10	__36010	\$241.09	\$273.43	\$333.52
12	__36012	\$327.99	\$388.47	\$478.65
15	__36015	\$628.65	\$793.90	\$895.26
16	__36016	\$841.62	\$1,007.26	\$1,068.20
18.7	__36018.7	\$1,054.59	\$1,220.63	\$1,241.14
21	__36021	\$1,528.25	\$1,832.32	\$2,213.03
24	__36024	\$2,439.15	\$2,771.88	\$3,589.12
27	__36027	\$3,309.56	\$3,833.31	\$4,556.87

90 DEGREE

FEMALE X FEMALE



Size	PartNumber	SDR 51: 80 PSI (14)	SDR 41: 100 PSI (15)	SDR 32.5: 125 PSI (16)
6	__3696	\$98.92	\$110.69	\$139.74
8	__3698	\$159.48	\$177.20	\$215.46
10	__36910	\$241.09	\$273.43	\$333.52
12	__36912	\$327.99	\$388.47	\$478.65
15	__36915	\$628.65	\$793.90	\$895.26
16	__37016	\$841.62	\$1,007.26	\$1,068.20
18.7	__37018.7	\$1,054.59	\$1,220.63	\$1,241.14
21	__37021	\$1,528.25	\$1,832.32	\$2,213.03
24	__37024	\$2,439.15	\$2,771.88	\$3,589.12
27	__37027	\$3,309.56	\$3,833.31	\$4,556.87

FLANGE

IPS X PIP

FLANGE X FEMALE



Size	PartNumber	SDR 51: 80 PSI (14)	SDR 41: 100 PSI (15)	SDR 32.5: 125 PSI (16)
6	__5306	\$125.88	\$128.45	\$160.56
8	__5308	\$184.76	\$188.53	\$235.66
10	__53010	\$273.21	\$278.78	\$348.48
12	__53012	\$410.06	\$418.43	\$523.04
16x15	__5301615	\$991.02	\$1,011.25	\$1,264.06
16	__53016	\$1,189.38	\$1,213.65	\$1,517.07
18x18.7	__5301818.7	\$1,537.52	\$1,568.90	\$1,961.12
20x21	__5302021	\$2,358.38	\$2,406.51	\$3,008.14
22X21	__5302221	\$2,891.26	\$2,950.26	\$3,687.83
24	__53024	\$3,424.13	\$3,494.01	\$4,367.51
24x27	__5302427	\$3,854.48	\$4,009.40	\$5,011.15

EXPANSION JOINT

FEMALE X FEMALE



§ Available in Larger Sizes.

Size	PartNumber	SDR 51: 80 PSI (14)	SDR 41: 100 PSI (15)	SDR 32.5: 125 PSI (16)
6x18	480618	\$83.29	\$87.68	\$116.61
6x31	480631	\$85.42	\$89.92	\$119.59
6x48	480648	\$106.78	\$134.04	\$174.44
8x18	480818	\$124.20	\$130.74	\$173.88
8x31	480831	\$127.39	\$134.09	\$178.34
8x48	480848	\$159.35	\$198.73	\$262.15
10x18	4801018	\$165.85	\$174.58	\$232.19
10x31	4801031	\$170.10	\$179.05	\$238.14
10x48	4801048	\$212.62	\$269.06	\$348.02
12x18	4801218	\$206.63	\$217.50	\$289.28
12x31	4801231	\$211.93	\$223.09	\$296.71
12x48	4801248	\$264.91	\$333.33	\$434.80
15x18	4801518	\$289.20	\$304.42	\$404.88
15x31	4801531	\$296.61	\$312.22	\$415.25
15x48	4801548	\$370.76	\$467.51	\$607.47
18.7x18	48018.718	\$382.47	\$402.60	\$535.45
18.7x31	48018.731	\$392.28	\$412.92	\$549.19
18x7x48	48018.748	\$490.35	\$618.33	\$806.05
21x18	4802118	\$478.09	\$503.25	\$669.32
21x31	4802131	\$490.35	\$570.85	\$642.27
21x48	4802148	\$612.93	\$857.96	\$964.57
24x18	4802418	\$597.61	\$629.06	\$836.65
24x31	4802431	\$612.93	\$706.14	\$810.31
24x48	4802448	\$766.17	\$1,057.98	\$1,216.50
27x18	4802718	\$747.01	\$786.32	\$1,045.81
27x31	4802731	\$766.17	\$920.31	\$1,126.08
27x48	4802748	\$957.72	\$1,381.08	\$1,689.82

PVC GASKETED PIP FITTINGS



Yes, Specified Fittings is your source for a variety of valve products: PVC end flap gates, backwater valves, sheer gates, PVC butterfly and HDPE backwater valves are just a sample of styles and types we fabricate. We also stock gate, ball, butterfly, diaphragm, check, and needle valves that are manufactured by other companies. These valves are available in 1/4" through 48" diameter in a variety of trim and end configurations. Valves for IPS, PIP, Sewer, C-900, C-905, and all profile pipes as well as HDPE solid wall are all produced at Specified Fittings. Speaking of valves, Specified Fittings

also makes adapter flanges in glue bell, spigot end, and gasket bell to adapt to any type of pipe from a flanged end valve. With these adapter flanges, it is no longer a problem to place a flanged valve into a line at any point. Flanges of this type are available in 1/2" through 60" diameter, in a Van Stone style for easy installation. Because the majority of our valves are made completely from plastic material, the non-corrosive benefits of our valves are evident. Our uniquely designed PVC sheer gate is a great example. These sheer gates are commonly used in flow control devices because of the potential corrosion associated with these installations. Our PVC construction is a perfect example of the superiority of the PVC product. So for your specialty valving needs, all you need to remember is: Specified Fittings!

REDUCER

CONCENTRIC

FEMALE X FEMALE



Size	PartNumber	SDR 51: 80 PSI (14)	SDR 41: 100 PSI (15)	SDR 32.5: 125 PSI (16)
8x6	60086	\$98.91	\$109.90	\$142.19
10x6	600106	\$183.51	\$203.90	\$254.90
10x8	600108	\$157.22	\$176.29	\$224.14
12x6	600126	\$250.66	\$278.51	\$348.13
12x8	600128	\$253.19	\$281.32	\$339.04
12x10	6001210	\$212.83	\$241.88	\$309.20
15x6	600156	\$373.16	\$414.62	\$518.28
15x8	600158	\$380.78	\$423.08	\$528.85
15x10	6001510	\$388.55	\$431.72	\$540.31
15x12	6001512	\$313.54	\$351.79	\$439.61
18.7x6	60018.76	\$757.15	\$841.28	\$1,009.54
18.7x8	60018.78	\$740.74	\$823.05	\$987.66
18.7x10	60018.710	\$616.55	\$685.05	\$822.06
18.7x12	60018.712	\$617.58	\$683.00	\$820.58
18.7x15	60018.715	\$560.29	\$614.97	\$702.80
18.7x16	60018.716	\$553.48	\$614.97	\$737.97
21x6	600216	\$1,115.11	\$1,239.01	\$1,486.81
21x8	600218	\$1,143.43	\$1,270.48	\$1,524.57
21x10	6002110	\$1,185.97	\$1,317.74	\$1,581.29
21x12	6002112	\$1,281.08	\$1,423.42	\$1,708.11
21x15	6002115	\$969.60	\$1,077.33	\$1,347.09
21x18.7	6002118.7	\$856.23	\$966.77	\$1,075.89
24x6	600246	\$1,647.40	\$1,830.45	\$2,196.54
24x8	600248	\$1,675.69	\$1,861.88	\$2,234.26
24x10	6002410	\$1,700.01	\$1,888.89	\$2,266.67
24x12	6002412	\$1,734.44	\$1,927.16	\$2,312.59
24x15	6002415	\$1,778.97	\$1,976.63	\$2,371.96
24x18.7	6002418.7	\$1,604.73	\$1,783.02	\$2,216.85
24x21	6002421	\$1,458.84	\$1,620.93	\$2,015.32
27x6	600276	\$2,117.98	\$2,353.31	\$2,823.97
27x8	600278	\$2,142.43	\$2,380.48	\$2,856.58
27x10	6002710	\$2,185.03	\$2,427.81	\$2,913.37
27x12	6002712	\$2,242.02	\$2,491.13	\$2,989.35
27x15	6002715	\$2,367.99	\$2,631.10	\$3,157.32
27x18.7	6002718.7	\$2,500.13	\$2,777.92	\$3,333.51
27x21	6002721	\$2,597.69	\$2,886.33	\$3,463.59
27x24	6002724	\$1,836.27	\$2,037.92	\$2,597.30

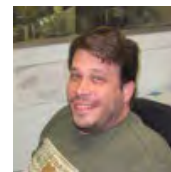

Many times when considering a special product or determining whether a certain fittings can fit a particular dimensional configuration, it is helpful to have a drawing prior to purchase. Our CAD operators, Brad Sukolsky (bsukolsky@specfit.com) and Derek Eirish (deirish@specfit.com), can provide you with such a service. If you need a drawing please call, fax, or email Brad, and he or Derek will respond promptly. Also, if you are designing a product and need technical data such as flow characteristics, impact information, dimensional sizing, or any other professional help, Brad Sukolsky and our friendly staff are here to assist you.

REDUCER

CONCENTRIC

LARGE END BELL (LEB)

FEMALE X MALE



Size	PartNumber	SDR 51: 80 PSI (14)	SDR 41: 100 PSI (15)	SDR 32.5: 125 PSI (16)
6x2	6406-2IPS	\$121.94	\$135.48	\$169.35
6x3	6406-3IPS	\$124.41	\$138.23	\$172.79
6x4	6406-4IPS	\$108.18	\$62.18	\$89.27
8x2	6408-2IPS	\$154.38	\$171.53	\$214.41
8x3	6408-3IPS	\$88.74	\$98.60	\$120.55
8x4	6408-4IPS	\$88.74	\$98.60	\$127.87
8x6	64086	\$79.74	\$88.60	\$116.85
10x2	64010-2IPS	\$251.31	\$279.23	\$349.04
10x3	64010-3IPS	\$256.41	\$284.90	\$356.13
10x4	64010-4IPS	\$259.00	\$287.78	\$359.72
10x6	640106	\$128.49	\$142.77	\$203.63
10x8	640108	\$121.08	\$127.78	\$177.75
12x2	64012-2IPS	\$343.26	\$381.40	\$476.74
12x3	64012-3IPS	\$350.23	\$389.14	\$486.42
12x4	64012-4IPS	\$353.76	\$393.07	\$491.34
12x6	640126	\$360.95	\$401.05	\$501.31
12x8	640128	\$188.36	\$209.28	\$255.40
12x10	6401210	\$169.69	\$187.46	\$228.47
15x3	64015-3IPS	\$505.75	\$561.94	\$702.43
15x4	64015-4IPS	\$516.07	\$573.41	\$716.77
15x6	640156	\$537.35	\$597.06	\$746.32
15x8	640158	\$548.32	\$609.24	\$761.55
15x10	6401510	\$313.65	\$348.50	\$392.67
15x12	6401512	\$268.18	\$311.82	\$351.79
18.7x3	64018.7-3IPS	\$1,097.24	\$1,219.15	\$1,462.98
18.7x4	64018.7-4IPS	\$1,037.43	\$1,152.71	\$1,383.25
18.7x6	64018.76	\$1,090.30	\$1,211.45	\$1,453.73
18.7x8	64018.78	\$1,066.67	\$1,185.19	\$1,422.23
18.7x10	64018.710	\$887.83	\$986.47	\$1,183.77
18.7x12	64018.712	\$595.96	\$662.18	\$686.75
18.7x15	64018.715	\$512.83	\$592.89	\$614.97
21x3	64021-3IPS	\$1,520.87	\$1,689.86	\$2,027.83
21x4	64021-4IPS	\$1,553.27	\$1,725.85	\$2,071.02
21x6	640216	\$1,605.76	\$1,784.18	\$2,141.01
21x8	640218	\$1,646.54	\$1,829.49	\$2,195.39
21x10	6402110	\$1,707.80	\$1,897.55	\$2,277.06
21x12	6402112	\$1,844.76	\$2,049.73	\$2,459.68
21x15	6402115	\$927.36	\$1,030.40	\$1,111.25
21x18.7	6402118.7	\$759.63	\$922.76	\$1,011.96
24x3	64024-3IPS	\$2,316.86	\$2,574.29	\$3,089.15
24x4	64024-4IPS	\$2,340.24	\$2,600.27	\$3,120.32
24x6	640246	\$2,372.26	\$2,635.84	\$3,163.01
24x8	640248	\$2,413.00	\$2,681.11	\$3,217.33
24x10	6402410	\$2,448.01	\$2,720.01	\$3,264.01
24x12	6402412	\$2,497.59	\$2,775.10	\$3,330.12
24x15	6402415	\$2,561.71	\$2,846.35	\$3,415.62
24x18.7	6402418.7	\$1,322.11	\$1,545.07	\$1,863.74
24x21	6402421	\$1,114.80	\$1,404.54	\$1,694.29
27x3	64027-3IPS	\$2,960.23	\$3,289.14	\$3,946.97
27x4	64027-4IPS	\$3,020.65	\$3,356.28	\$4,027.53
27x6	640276	\$3,049.89	\$3,388.76	\$4,066.52
27x8	640278	\$3,085.10	\$3,427.89	\$4,113.47
27x10	6402710	\$3,146.44	\$3,496.05	\$4,195.26
27x12	6402712	\$3,228.50	\$3,587.23	\$4,304.67
27x15	6402715	\$3,409.90	\$3,788.78	\$4,546.53
27x18.7	6402718.7	\$3,536.77	\$3,929.75	\$4,715.70
27x21	6402721	\$3,670.45	\$4,078.28	\$4,893.94
27x24	6402724	\$1,561.11	\$1,962.47	\$2,341.20

SMALL END BELL (SEB)

MALE X FEMALE



Size	PartNumber	SDR 51: 80 PSI (14)	SDR 41: 100 PSI (15)	SDR 32.5: 125 PSI (16)
6x2	6206-2IPS	\$101.61	\$112.90	\$141.13
6x3	6206-3IPS	\$103.68	\$115.20	\$143.99
6x4	6206-4IPS	\$59.74	\$66.38	\$78.21
8x2	6208-2IPS	\$128.65	\$142.94	\$178.68
8x3	6208-3IPS	\$131.27	\$145.85	\$182.32
8x4	6208-4IPS	\$106.37	\$118.18	\$120.55
8x6	62086	\$75.13	\$83.47	\$90.31
10x2	62010-2IPS	\$209.42	\$232.69	\$290.87
10x3	62010-3IPS	\$213.68	\$237.42	\$296.77
10x4	62010-4IPS	\$215.83	\$239.82	\$299.77
10x6	620106	\$220.21	\$183.91	\$203.63
10x8	620108	\$112.01	\$131.98	\$161.56
12x2	62012-2IPS	\$286.05	\$317.83	\$397.29
12x3	62012-3IPS	\$291.85	\$324.28	\$405.35
12x4	62012-4IPS	\$294.80	\$327.56	\$409.45
12x6	620126	\$300.79	\$334.21	\$417.76
12x8	620128	\$234.85	\$260.95	\$288.03
12x10	6201210	\$161.56	\$176.29	\$228.47
15x3	62015-3IPS	\$421.46	\$468.29	\$585.36
15x4	62015-4IPS	\$430.06	\$477.84	\$597.30
15x6	620156	\$447.79	\$497.55	\$621.93
15x8	620158	\$456.93	\$507.70	\$634.63
15x10	6201510	\$339.09	\$376.76	\$451.30
15x12	6201512	\$238.07	\$272.64	\$386.76
18.7x3	62018.7-3IPS	\$914.36	\$1,015.96	\$1,219.15
18.7x4	62018.7-4IPS	\$864.53	\$960.59	\$1,152.71
18.7x6	62018.76	\$908.58	\$1,009.54	\$1,211.45
18.7x8	62018.78	\$888.89	\$987.66	\$1,185.19
18.7x10	62018.710	\$739.85	\$822.06	\$986.47
18.7x12	62018.712	\$540.81	\$600.91	\$718.97
18.7x15	62018.715	\$466.42	\$527.30	\$614.97
21x3	62021-3IPS	\$1,267.39	\$1,408.22	\$1,689.86
21x4	62021-4IPS	\$1,294.39	\$1,438.21	\$1,725.85
21x6	620216	\$1,338.13	\$1,486.81	\$1,784.18
21x8	620218	\$1,372.12	\$1,524.57	\$1,829.49
21x10	6202110	\$1,423.16	\$1,581.29	\$1,897.55
21x12	6202112	\$1,537.30	\$1,708.11	\$2,049.73
21x15	6202115	\$842.89	\$936.53	\$1,170.66
21x18.7	6202118.7	\$313.53	\$794.81	\$922.59
24x3	62024-3IPS	\$1,930.72	\$2,145.24	\$2,574.29
24x4	62024-4IPS	\$1,950.20	\$2,166.89	\$2,600.27
24x6	620246	\$1,976.88	\$2,196.54	\$2,635.84
24x8	620248	\$2,010.83	\$2,234.26	\$2,681.11
24x10	6202410	\$2,040.01	\$2,266.67	\$2,720.01
24x12	6202412	\$2,081.33	\$2,312.59	\$2,775.10
24x15	6202415	\$2,134.76	\$2,371.96	\$2,846.35
24x18.7	6202418.7	\$1,101.76	\$1,455.41	\$1,618.92
24x21	6202421	\$1,097.05	\$1,324.92	\$1,471.38
27x3	62027-3IPS	\$2,466.85	\$2,740.95	\$3,289.14
27x4	62027-4IPS	\$2,517.21	\$2,796.90	\$3,356.28
27x6	620276	\$2,541.57	\$2,823.97	\$3,388.76
27x8	620278	\$2,570.92	\$2,856.58	\$3,427.89
27x10	6202710	\$2,622.03	\$2,913.37	\$3,496.05
27x12	6202712	\$2,690.42	\$2,989.35	\$3,587.23
27x15	6202715	\$2,841.58	\$3,157.32	\$3,788.78
27x18.7	6202718.7	\$3,000.16	\$3,333.51	\$4,000.21
27x21	6202721	\$3,117.23	\$3,463.59	\$4,156.31
27x24	6202724	\$1,533.24	\$2,445.51	\$2,996.32

PVC GASKETED PIP FITTINGS

REDUCER

CONCENTRIC

SURFACE STYLE

FEMALE X FEMALE

Size	PartNumber	SDR 51: 80 PSI (14)	SDR 41: 100 PSI (15)	SDR 32.5: 125 PSI (16)
6x2	__6616-2IPS	\$76.21	\$84.68	\$105.85
6x3	__6616-3IPS	\$77.76	\$86.40	\$108.00
6x4	__6616-4IPS	\$67.61	\$75.13	\$96.90
8x2	__6618-2IPS	\$96.48	\$107.21	\$134.01
8x3	__6618-3IPS	\$98.45	\$109.39	\$136.74
8x4	__6618-4IPS	\$99.45	\$110.50	\$146.83
8x6	__66186	\$89.02	\$98.91	\$127.97
10x2	__66110-2IPS	\$157.07	\$174.52	\$218.15
10x3	__66110-3IPS	\$160.26	\$178.06	\$222.58
10x4	__66110-4IPS	\$161.88	\$179.86	\$224.83
10x6	__661106	\$165.16	\$183.51	\$229.41
10x8	__661108	\$141.50	\$158.66	\$201.72
12x2	__66112-2IPS	\$214.54	\$238.37	\$297.97
12x3	__66112-3IPS	\$218.89	\$243.21	\$304.02
12x4	__66112-4IPS	\$221.10	\$245.67	\$307.09
12x6	__661126	\$225.59	\$250.66	\$313.32
12x8	__661128	\$227.87	\$253.19	\$305.13
12x10	__6611210	\$191.55	\$217.69	\$278.28
15x3	__66115-3IPS	\$316.09	\$351.22	\$439.02
15x4	__66115-4IPS	\$322.54	\$358.38	\$447.98
15x6	__661156	\$335.84	\$373.16	\$466.45
15x8	__661158	\$342.70	\$380.78	\$475.97
15x10	__6611510	\$349.69	\$388.55	\$486.28
15x12	__6611512	\$282.18	\$316.61	\$395.65
18.7x3	__66118.7-3IPS	\$685.77	\$761.97	\$914.36
18.7x4	__66118.7-4IPS	\$648.40	\$720.44	\$864.53
18.7x6	__66118.76	\$681.44	\$757.15	\$908.58
18.7x8	__66118.78	\$666.67	\$740.74	\$888.89
18.7x10	__66118.710	\$554.89	\$616.55	\$739.85
18.7x12	__66118.712	\$498.13	\$553.48	\$738.53
18.7x15	__66118.715	\$504.26	\$553.48	\$632.52
21x3	__66121-3IPS	\$950.55	\$1,056.16	\$1,267.39
21x4	__66121-4IPS	\$970.79	\$1,078.66	\$1,294.39
21x6	__661216	\$1,003.60	\$1,115.11	\$1,338.13
21x8	__661218	\$1,029.09	\$1,143.43	\$1,372.12
21x10	__6612110	\$1,067.37	\$1,185.97	\$1,423.16
21x12	__6612112	\$1,152.97	\$1,281.08	\$1,537.30
21x15	__6612115	\$872.64	\$969.60	\$1,212.38
21x18.7	__6612118.7	\$770.60	\$870.09	\$968.30
24x3	__66124-3IPS	\$1,448.04	\$1,608.93	\$1,930.72
24x4	__66124-4IPS	\$1,462.65	\$1,625.17	\$1,950.20
24x6	__661246	\$1,482.66	\$1,647.40	\$1,976.88
24x8	__661248	\$1,508.12	\$1,675.69	\$2,010.83
24x10	__6612410	\$1,530.00	\$1,700.01	\$2,040.01
24x12	__6612412	\$1,561.00	\$1,734.44	\$2,081.33
24x15	__6612415	\$1,601.07	\$1,778.97	\$2,134.76
24x18.7	__6612418.7	\$1,444.25	\$1,604.72	\$1,995.16
24x21	__6612421	\$1,312.95	\$1,458.84	\$1,813.79
27x3	__66127-3IPS	\$1,850.14	\$2,055.71	\$2,466.85
27x4	__66127-4IPS	\$1,887.91	\$2,097.67	\$2,517.21
27x6	__661276	\$1,906.18	\$2,117.98	\$2,541.57
27x8	__661278	\$1,928.19	\$2,142.43	\$2,570.92
27x10	__6612710	\$1,966.53	\$2,185.03	\$2,622.03
27x12	__6612712	\$2,017.81	\$2,242.02	\$2,690.42
27x15	__6612715	\$2,131.19	\$2,367.99	\$2,841.58
27x18.7	__6612718.7	\$2,250.12	\$2,500.13	\$3,000.16
27x24	__6612724	\$2,337.92	\$2,597.69	\$3,117.23

REDUCER

ECCENTRIC

FEMALE X FEMALE



Size	PartNumber	SDR 51: 80 PSI (14)	SDR 41: 100 PSI (15)	SDR 32.5: 125 PSI (16)
6x2	__6106-2IPS	\$84.68	\$94.09	\$117.61
6x3	__6106-3IPS	\$86.40	\$96.00	\$119.99
6x4	__6106-4IPS	\$75.13	\$83.48	\$107.67
8x2	__6108-2IPS	\$107.21	\$119.12	\$148.90
8x3	__6108-3IPS	\$109.39	\$121.55	\$151.93
8x4	__6108-4IPS	\$110.50	\$122.78	\$163.14
8x6	__61086	\$98.91	\$109.90	\$142.19
10x2	__61010-2IPS	\$174.52	\$193.91	\$242.38
10x3	__61010-3IPS	\$178.07	\$197.84	\$247.30
10x4	__61010-4IPS	\$179.86	\$199.85	\$249.81
10x6	__610106	\$183.50	\$203.90	\$254.89
10x8	__610108	\$157.23	\$176.29	\$224.14
12x2	__61012-2IPS	\$238.37	\$264.85	\$331.07
12x3	__61012-3IPS	\$243.21	\$270.24	\$337.80
12x4	__61012-4IPS	\$245.67	\$272.96	\$341.21
12x6	__610126	\$250.66	\$278.51	\$348.13
12x8	__610128	\$253.19	\$281.32	\$339.03
12x10	__6101210	\$212.83	\$241.88	\$309.20
15x3	__61015-3IPS	\$351.21	\$390.24	\$487.80
15x4	__61015-4IPS	\$358.38	\$398.20	\$497.75
15x6	__610156	\$373.16	\$414.63	\$518.28
15x8	__610158	\$380.77	\$423.09	\$528.86
15x10	__6101510	\$388.55	\$431.72	\$540.31
15x12	__6101512	\$313.54	\$351.80	\$439.61
18.7x3	__61018.7-3IPS	\$761.98	\$846.64	\$1,015.95
18.7x4	__61018.7-4IPS	\$720.45	\$800.50	\$960.59
18.7x6	__61018.76	\$757.16	\$841.29	\$1,009.53
18.7x8	__61018.78	\$740.74	\$823.05	\$987.66
18.7x10	__61018.710	\$616.55	\$685.05	\$822.06
18.7x12	__61018.712	\$617.58	\$683.00	\$820.58
18.7x15	__61018.715	\$553.48	\$614.97	\$702.80
21x3	__61021-3IPS	\$1,056.16	\$1,173.51	\$1,408.22
21x4	__61021-4IPS	\$1,078.65	\$1,198.51	\$1,438.21
21x6	__610216	\$1,115.11	\$1,239.01	\$1,486.81
21x8	__610218	\$1,143.43	\$1,270.48	\$1,524.57
21x10	__6102110	\$1,185.97	\$1,317.75	\$1,581.29
21x12	__6102112	\$1,281.08	\$1,423.42	\$1,708.11
21x15	__6102115	\$969.59	\$1,077.33	\$1,347.09
21x18.7	__6102118.7	\$855.12	\$966.77	\$1,075.88
24x3	__61024-3IPS	\$1,608.93	\$1,787.70	\$2,145.24
24x4	__61024-4IPS	\$1,625.17	\$1,805.74	\$2,166.89
24x6	__610246	\$1,647.41	\$1,830.45	\$2,196.54
24x8	__610248	\$1,675.69	\$1,861.88	\$2,234.26
24x10	__6102410	\$1,700.00	\$1,888.90	\$2,266.67
24x12	__6102412	\$1,734.44	\$1,927.15	\$2,312.59
24x15	__6102415	\$1,778.97	\$1,976.63	\$2,371.96
24x18.7	__6102418.7	\$1,604.73	\$1,783.03	\$2,216.85
24x21	__6102421	\$1,458.84	\$1,620.93	\$2,015.32
27x3	__61027-3IPS	\$2,055.71	CF	\$2,740.95
27x4	__61027-4IPS	\$2,097.67	\$2,330.75	\$2,796.90
27x6	__610276	\$2,117.98	\$2,353.30	\$2,823.97
27x8	__610278	\$2,142.43	\$2,380.48	\$2,856.58
27x10	__6102710	\$2,185.03	\$2,427.80	\$2,913.37
27x12	__6102712	\$2,242.02	\$2,491.13	\$2,989.36
27x15	__6102715	\$2,367.99	\$2,631.10	\$3,157.32
27x18.7	__6102718.7	\$2,500.13	\$2,777.97	\$3,333.51
27x21	__6102721	\$2,597.70	\$2,886.33	\$3,463.59
27x24	__6102724	\$1,836.27	\$2,037.92	\$2,597.30

PVC GASKETED PIP FITTINGS

REDUCER

ECCENTRIC

SMALL END BELL (SEB)

MALE X FEMALE



Size	PartNumber	SDR 51:80 PSI (14)	SDR 41: 100 PSI (15)	SDR 32.5: 125 PSI (16)
6x2	__6306-2IPS	\$111.77	\$124.19	\$155.24
6x3	__6306-3IPS	\$114.04	\$126.72	\$158.39
6x4	__6306-4IPS	\$99.17	\$110.18	\$142.12
8x2	__6308-2IPS	\$141.51	\$157.23	\$196.54
8x3	__6308-3IPS	\$144.40	\$160.44	\$200.55
8x4	__6308-4IPS	\$145.86	\$162.06	\$202.58
8x6	__63086	\$130.56	\$145.06	\$181.33
10x2	__63010-2IPS	\$230.37	\$255.96	\$319.95
10x3	__63010-3IPS	\$235.04	\$261.16	\$326.45
10x4	__63010-4IPS	\$237.42	\$263.80	\$329.75
10x6	__630106	\$242.23	\$269.28	\$337.13
10x8	__630108	\$123.21	\$145.18	\$177.72
12x2	__63012-2IPS	\$314.65	\$349.61	\$437.02
12x3	__63012-3IPS	\$321.04	\$356.71	\$445.89
12x4	__63012-4IPS	\$324.28	\$360.31	\$450.39
12x6	__630126	\$330.87	\$367.63	\$459.54
12x8	__630128	\$334.21	\$371.35	\$464.20
12x10	__6301210	\$177.72	\$193.92	\$251.32
15x3	__63015-3IPS	\$463.60	\$515.12	\$643.89
15x4	__63015-4IPS	\$473.07	\$525.63	\$657.04
15x6	__630156	\$492.57	\$547.30	\$684.13
15x8	__630158	\$502.62	\$558.47	\$698.09
15x10	__6301510	\$512.88	\$569.87	\$712.34
15x12	__6301512	\$261.88	\$299.91	\$425.43
18.7x3	__63018.7-3IPS	\$1,005.80	\$1,117.56	\$1,341.07
18.7x4	__63018.7-4IPS	\$950.98	\$1,056.65	\$1,267.98
18.7x6	__63018.76	\$999.44	\$1,110.49	\$1,332.59
18.7x8	__63018.78	\$977.78	\$1,086.42	\$1,303.71
18.7x10	__63018.710	\$813.84	\$904.27	\$1,085.12
18.7x12	__63018.712	\$730.59	\$811.76	\$1,014.76
18.7x15	__63018.715	\$513.07	\$580.03	\$676.47
21x3	__63021-3IPS	\$1,394.13	\$1,549.04	\$1,858.85
21x4	__63021-4IPS	\$1,423.83	\$1,582.03	\$1,898.44
21x6	__630216	\$1,471.95	\$1,635.49	\$1,962.59
21x8	__630218	\$1,509.33	\$1,677.03	\$2,012.44
21x10	__6302110	\$1,565.48	\$1,739.42	\$2,087.31
21x12	__6302112	\$1,691.03	\$1,878.92	\$2,254.70
21x15	__6302115	\$1,279.87	\$1,422.08	\$1,777.60
21x18.7	__6302118.7	\$788.26	\$874.29	\$1,014.85
24x3	__63024-3IPS	\$2,123.79	\$2,359.76	\$2,831.72
24x4	__63024-4IPS	\$2,145.22	\$2,383.58	\$2,860.29
24x6	__630246	\$2,174.57	\$2,416.19	\$2,899.43
24x8	__630248	\$2,211.92	\$2,457.68	\$2,949.22
24x10	__6302410	\$2,244.01	\$2,493.34	\$2,992.01
24x12	__6302412	\$2,289.46	\$2,543.84	\$3,052.61
24x15	__6302415	\$2,348.24	\$2,609.15	\$3,130.98
24x18.7	__6302418.7	\$1,211.94	\$2,353.59	\$2,926.24
24x21	__6302421	\$1,206.75	\$2,139.63	\$2,660.22
27x3	__63027-3IPS	\$2,713.54	\$3,015.04	\$3,618.05
27x4	__63027-4IPS	\$2,768.93	\$3,076.59	\$3,691.91
27x6	__630276	\$2,795.73	\$3,106.37	\$3,727.64
27x8	__630278	\$2,828.01	\$3,142.23	\$3,770.68
27x10	__6302710	\$2,884.24	\$3,204.71	\$3,845.65
27x12	__6302712	\$2,959.46	\$3,288.29	\$3,945.95
27x15	__6302715	\$3,125.74	\$3,473.05	\$4,167.66
27x18.7	__6302718.7	\$3,300.17	\$3,666.86	\$4,400.23
27x21	__6302721	\$3,428.96	\$3,809.95	\$4,571.94
27x24	__6302724	\$1,686.57	\$2,690.06	\$3,428.43

SADDLE TEE

STUB STYLE

SLIP X FEMALE



Size	PartNumber	SDR 51:80 PSI (14)	SDR 41: 100 PSI (15)	SDR 32.5: 125 PSI (16)
6x2	__7016-2IPS	\$65.87	\$73.19	\$91.48
6x3	__7016-3IPS	\$93.50	\$103.88	\$129.86
6x4	__7016-4IPS	\$86.71	\$96.34	\$120.42
8x2	__7018-2IPS	\$69.19	\$76.87	\$96.09
8x3	__7018-3IPS	\$93.50	\$103.88	\$129.86
8x4	__7018-4IPS	\$108.05	\$120.05	\$150.07
8x6	__70186	\$133.56	\$148.40	\$185.50
10x2	__70110-2IPS	\$84.98	\$94.42	\$118.03
10x3	__70110-3IPS	\$93.50	\$103.88	\$129.86
10x4	__70110-4IPS	\$108.05	\$120.05	\$150.07
10x6	__701106	\$133.56	\$148.40	\$185.50
10x8	__701108	\$174.87	\$194.30	\$242.87
12x2	__70112-2IPS	\$84.98	\$94.42	\$118.03
12x3	__70112-3IPS	\$93.50	\$103.88	\$129.86
12x4	__70112-4IPS	\$108.05	\$120.05	\$150.07
12x6	__701126	\$133.56	\$148.40	\$185.50
12x8	__701128	\$174.87	\$194.30	\$242.87
12x10	__7011210	\$189.42	\$210.46	\$263.08
15x3	__70115-3IPS	\$135.99	\$151.09	\$188.87
15x4	__70115-4IPS	\$142.08	\$157.86	\$197.33
15x6	__701156	\$146.91	\$163.23	\$204.04
15x8	__701158	\$174.87	\$194.30	\$242.87
15x10	__7011510	\$201.58	\$223.98	\$279.97
15x12	__7011512	\$265.94	\$295.49	\$369.36
18.7x3	__70118.7-3IPS	\$205.23	\$228.03	\$285.04
18.7x4	__70118.7-4IPS	\$247.72	\$275.24	\$344.05
18.7x6	__70118.76	\$315.76	\$350.84	\$438.56
18.7x8	__70118.78	\$337.59	\$375.10	\$468.87
18.7x10	__70118.710	\$388.61	\$431.79	\$539.74
18.7x12	__70118.712	\$448.14	\$497.93	\$622.41
18.7x15	__70118.715	\$626.86	\$696.52	\$870.64
21x3	__70121-3IPS	\$607.23	\$674.70	\$843.37
21x4	__70121-4IPS	\$618.13	\$686.81	\$858.52
21x6	__701216	\$650.77	\$723.07	\$903.84
21x8	__701218	\$752.37	\$835.97	\$1,044.96
21x10	__7012110	\$785.04	\$872.27	\$1,090.34
21x12	__7012112	\$817.72	\$908.57	\$1,135.72
21x15	__7012115	\$938.67	\$1,042.96	\$1,303.70
21x18.7	__7012118.7	\$1,070.52	\$1,189.47	\$1,486.83
24x3	__70124-3IPS	\$804.41	\$893.79	\$1,117.23
24x4	__70124-4IPS	\$864.90	\$961.00	\$1,201.25
24x6	__701246	\$927.80	\$1,030.89	\$1,288.61
24x8	__701248	\$988.29	\$1,098.11	\$1,372.63
24x10	__7012410	\$1,070.54	\$1,189.49	\$1,486.86
24x12	__7012412	\$1,152.80	\$1,280.89	\$1,601.11
24x15	__7012415	\$1,256.83	\$1,396.48	\$1,745.60
24x18.7	__7012418.7	\$1,350.27	\$1,500.30	\$1,875.37
24x21	__7012421	\$1,522.94	\$1,692.16	\$2,115.20
27x3	__70127-3IPS	\$1,007.62	\$1,119.58	\$1,399.47
27x4	__70127-4IPS	\$1,081.40	\$1,201.56	\$1,501.95
27x6	__701276	\$1,161.24	\$1,290.27	\$1,612.83
27x8	__701278	\$1,235.04	\$1,372.27	\$1,715.34
27x10	__7012710	\$1,339.09	\$1,487.88	\$1,859.85
27x12	__7012712	\$1,440.70	\$1,600.78	\$2,000.97
27x15	__7012715	\$1,572.53	\$1,747.26	\$2,184.07
27x18.7	__7012718.7	\$1,772.13	\$1,969.03	\$2,461.29
27x21	__7012721	\$1,905.19	\$2,116.88	\$2,646.10
27x24	__7012724	\$1,983.83	\$2,204.25	\$2,755.31

PVC GASKETED PIP FITTINGS

SADDLE WYE

STUB STYLE

SLIP X FEMALE



Size	PartNumber	SDR 51: 80	SDR 41:	SDR 32.5:
		PSI (14)	100 PSI (15)	125 PSI (16)
6x2	__7416-2IPS	\$82.34	\$91.48	\$114.35
6x3	__7416-3IPS	\$116.87	\$129.86	\$162.32
6x4	__7416-4IPS	\$108.38	\$120.42	\$150.53
8x2	__7418-2IPS	\$86.48	\$96.09	\$120.11
8x3	__7418-3IPS	\$116.87	\$129.86	\$162.32
8x4	__7418-4IPS	\$135.06	\$150.07	\$187.58
8x6	__74186	\$166.95	\$185.50	\$231.88
10x2	__74110-2IPS	\$106.22	\$118.03	\$147.53
10x3	__74110-3IPS	\$116.87	\$129.86	\$162.32
10x4	__74110-4IPS	\$135.06	\$150.07	\$187.58
10x6	__741106	\$166.95	\$185.50	\$231.88
10x8	__741108	\$218.58	\$242.87	\$303.59
12x2	__74112-2IPS	\$106.22	\$118.03	\$147.53
12x3	__74112-3IPS	\$116.87	\$129.86	\$162.32
12x4	__74112-4IPS	\$135.06	\$150.07	\$187.58
12x6	__741126	\$166.95	\$185.50	\$231.88
12x8	__741128	\$218.58	\$242.87	\$303.59
12x10	__7411210	\$236.77	\$263.08	\$328.85
15x3	__74115-3IPS	\$169.98	\$188.87	\$236.09
15x4	__74115-4IPS	\$394.79	\$438.66	\$548.33
15x6	__741156	\$416.34	\$462.60	\$578.25
15x8	__741158	\$501.21	\$556.89	\$696.15
15x10	__7411510	\$556.49	\$618.32	\$772.90
15x12	__7411512	\$618.46	\$687.18	\$858.97
18.7x3	__74118.7-3IPS	\$256.54	\$285.04	\$356.30
18.7x4	__74118.7-4IPS	\$703.34	\$781.49	\$976.86
18.7x6	__74118.76	\$765.33	\$850.37	\$1,062.96
18.7x8	__74118.78	\$825.98	\$917.75	\$1,147.20
18.7x10	__74118.710	\$896.02	\$995.58	\$1,244.48
18.7x12	__74118.712	\$968.79	\$1,076.44	\$1,345.55
18.7x15	__74118.715	\$979.58	\$1,088.42	\$1,360.53
21x3	__74121-3IPS	\$740.14	\$822.38	\$1,027.98
21x4	__74121-4IPS	\$759.04	\$843.37	\$1,054.22
21x6	__741216	\$793.06	\$881.18	\$1,101.48
21x8	__741218	\$813.46	\$903.84	\$1,129.80
21x10	__7412110	\$940.47	\$1,044.96	\$1,306.20
21x12	__7412112	\$981.31	\$1,090.34	\$1,362.92
21x15	__7412115	\$1,097.74	\$1,219.71	\$1,524.64
21x18.7	__7412118.7	\$1,338.15	\$1,486.83	\$1,858.54
24x3	__74124-3IPS	\$1,005.51	\$1,117.23	\$1,396.54
24x4	__74124-4IPS	\$1,081.13	\$1,201.25	\$1,501.56
24x6	__741246	\$1,159.75	\$1,288.61	\$1,610.77
24x8	__741248	\$1,235.37	\$1,372.63	\$1,715.79
24x10	__7412410	\$1,338.17	\$1,486.86	\$1,858.57
24x12	__7412412	\$1,441.00	\$1,601.11	\$2,001.39
24x15	__7412415	\$1,571.04	\$1,745.60	\$2,182.00
24x18.7	__7412418.7	\$1,687.84	\$1,875.37	\$2,344.22
24x21	__7412421	\$1,903.68	\$2,115.20	\$2,644.00
27x3	__74127-3IPS	\$1,259.52	\$1,399.47	\$1,749.34
27x4	__74127-4IPS	\$1,351.75	\$1,501.95	\$1,877.44
27x6	__741276	\$1,451.55	\$1,612.83	\$2,016.04
27x8	__741278	\$1,543.80	\$1,715.34	\$2,144.17
27x10	__7412710	\$1,673.87	\$1,859.85	\$2,324.82
27x12	__7412712	\$1,800.87	\$2,000.97	\$2,501.22
27x15	__7412715	\$1,965.67	\$2,184.07	\$2,730.09
27x18.7	__7412718.7	\$2,215.16	\$2,461.29	\$3,076.61
27x21	__7412721	\$2,381.49	\$2,646.10	\$3,307.63
27x24	__7412724	\$2,479.78	\$2,755.31	\$3,444.14

STRAPS

STAINLESS STEEL

Size	PartNumber	(81)
4	__7554	CF
8	__7558	CF
10	__75510	CF
12	__75512	CF
15	__75515	CF
18	__75518	CF
20-21	__7552021	CF



For our customer North of the Border we are please to announce the completion of our CSA certification for SDR35/F679 sewer fittings 4"-48". Our fittings, whether sold in Canada or the US, will

bear the certification to CSA specifications. As an aside, every test performed to fulfill these requirements was passed on the first attempt. It mattered not whether tee, wye, coupling, or cap—to name a few configurations; all tests without incidence or problem at the first slap of the puck.

We are now working on our C900/C905 certification, which will be forthcoming soon. Presently, our Canadian basket of approved products are: sewer fittings, HDPE fittings, PIP fittings, molded Sch40 and Sch80, and C900/ C905 fittings in the province of Quebec.

PVC GASKETED PIP FITTINGS

TEE

FEMALE X FEMALE X FEMALE



Size	PartNumber	SDR 51: 80	SDR 41:	SDR 32.5:
		PSI (14)	100 PSI (15)	125 PSI (16)
6x2	8206-2IPS	\$107.91	\$119.90	\$130.11
6x3	8206-3IPS	\$110.10	\$122.33	\$132.75
6x4	8206-4IPS	\$111.21	\$123.57	\$134.09
6	8206	\$118.79	\$131.98	\$143.29
8x2	8208-2IPS	\$130.87	\$145.42	\$156.76
8x3	8208-3IPS	\$133.53	\$148.37	\$159.95
8x4	8208-4IPS	\$134.88	\$149.87	\$161.56
8x6	82086	\$142.57	\$158.41	\$188.52
8	8208	\$158.66	\$176.29	\$215.46
10x2	82010-2IPS	\$191.94	\$213.27	\$226.79
10x3	82010-3IPS	\$195.84	\$217.60	\$231.40
10x4	82010-4IPS	\$211.00	\$219.80	\$233.74
10x6	820106	\$215.20	\$229.14	\$259.77
10x8	820108	\$237.29	\$246.22	\$282.38
10	82010	\$241.62	\$268.31	\$323.13
12x2	82012-2IPS	\$241.77	\$268.64	\$304.23
12x3	82012-3IPS	\$246.68	\$274.09	\$310.40
12x4	82012-4IPS	\$245.83	\$276.86	\$313.54
12x6	820126	\$252.67	\$286.19	\$336.14
12x8	820128	\$292.64	\$319.38	\$358.76
12x10	8201210	\$301.04	\$325.37	\$403.06
12	82012	\$333.38	\$364.54	\$448.28
15x3	82015-3IPS	\$390.70	\$413.21	\$543.89
15x4	82015-4IPS	\$394.65	\$417.38	\$549.38
15x6	820156	\$399.77	\$483.91	\$584.35
15x8	820158	\$421.07	\$492.32	\$606.57
15x10	8201510	\$453.27	\$505.21	\$637.19
15x12	8201512	\$483.12	\$549.38	\$680.58
15	82015	\$532.42	\$659.28	\$790.47
18.7x3	82018.7-3IPS	\$506.92	\$565.87	\$695.77
18.7x4	82018.7-4IPS	\$512.04	\$571.59	\$702.80
18.7x6	82018.76	\$548.59	\$614.97	\$769.18
18.7x8	82018.78	\$560.55	\$694.24	\$834.78
18.7x10	82018.710	\$623.39	\$724.88	\$900.39
18.7x12	82018.712	\$676.24	\$769.18	\$944.68
18.7x15	82018.715	\$706.86	\$812.70	\$1,010.28
18.7	82018.7	\$848.84	\$988.06	\$1,273.48
21x3	82021-3IPS	\$786.47	\$957.10	\$1,151.93
21x4	82021-4IPS	\$794.42	\$966.77	\$1,163.57
21x6	820216	\$802.97	\$988.06	\$1,185.79
21x8	820218	\$845.43	\$1,040.91	\$1,242.84
21x10	8202110	\$871.85	\$1,054.59	\$1,282.81
21x12	8202112	\$956.91	\$1,120.18	\$1,405.60
21x15	8202115	\$1,036.05	\$1,163.57	\$1,515.36
21x18.7	8202118.7	\$1,172.12	\$1,405.60	\$1,713.08
21	82021	\$1,336.18	\$1,646.57	\$2,011.24
24x3	82024-3IPS	\$2,070.90	\$2,346.55	\$2,933.06
24x4	82024-4IPS	\$2,091.81	\$2,370.26	\$2,962.69
24x6	820246	\$2,134.29	\$2,418.38	\$3,022.84
24x8	820248	\$2,246.29	\$2,507.77	\$3,179.28
24x10	8202410	\$2,360.92	\$2,552.99	\$3,358.21
24x12	8202412	\$2,488.71	\$2,618.68	\$3,538.05
24x15	8202415	\$2,618.99	\$2,731.92	\$3,716.96
24x18.7	8202418.7	\$2,754.52	\$2,865.62	\$3,895.88
24x21	8202421	\$2,900.45	\$3,045.46	\$4,120.03
24	82024	\$3,052.42	\$3,179.28	\$4,334.57
27x3	82027-3IPS	\$2,588.40	\$2,933.06	\$3,693.30
27x4	82027-4IPS	\$2,614.55	\$2,962.69	\$3,730.61
27x6	820276	\$2,667.63	\$3,022.84	\$3,806.35
27x8	820278	\$2,807.51	\$3,179.28	\$3,985.40
27x10	8202710	\$2,951.72	\$3,358.21	\$4,164.33
27x12	8202712	\$3,111.44	\$3,538.05	\$4,365.86
27x15	8202715	\$3,274.85	\$3,716.96	\$4,523.09
27x18.7	8202718.7	\$3,444.18	\$3,918.49	\$4,880.93
27x21	8202721	\$3,625.72	\$4,120.03	\$5,149.38
27x24	8202724	\$3,816.88	\$4,298.94	\$5,440.30
27	82027	\$4,388.34	\$5,037.23	\$6,381.05

GASKETxGASKETxSOLVENT WELD BELL

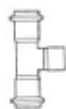

Size	PartNumber	SDR 51: 80	SDR 41:	SDR 32.5:
		PSI (14)	100 PSI (15)	125 PSI (16)
6x2	8386-2IPS	\$107.91	\$90.41	\$118.18
6x3	8386-3IPS	\$110.10	\$96.80	\$125.51
6x4	8386-4IPS	\$111.21	\$100.83	\$128.92
6	8386	\$118.79	\$111.02	\$180.01
8x2	8388-2IPS	\$130.87	\$124.28	\$183.46
8x3	8388-3IPS	\$133.53	\$134.25	\$188.25
8x4	8388-4IPS	\$134.88	\$149.87	\$200.10
8x6	8388-6IPS	\$142.57	\$158.41	\$209.66
8	8388	\$158.66	\$176.29	\$255.50
10x2	83810-2IPS	\$179.68	\$210.83	\$264.36
10x3	83810-3IPS	\$195.84	\$217.60	\$280.22
10x4	83810-4IPS	\$211.00	\$219.80	\$292.52
10x6	838106	\$215.20	\$242.13	\$304.46
10x8	838108	\$223.68	\$246.22	\$282.38
10	83810	\$232.20	\$268.31	\$323.13
12x2	83812-2IPS	\$241.77	\$251.32	\$345.09
12x3	83812-3IPS	\$253.88	\$258.20	\$351.23
12x4	83812-4IPS	\$258.21	\$267.55	\$365.21
12x6	838126	\$267.78	\$286.19	\$408.60
12x8	838128	\$276.67	\$311.98	\$429.83
12x10	8381210	\$285.92	\$325.37	\$455.77
12	83812	\$313.06	\$364.54	\$540.86
15x3	83815-3IPS	\$307.45	\$403.40	\$589.39
15x4	83815-4IPS	\$312.32	\$417.38	\$615.08
15x6	838156	\$336.56	\$447.63	\$636.61
15x8	838158	\$358.44	\$469.71	\$668.09
15x10	8381510	\$402.42	\$467.89	\$706.99
15x12	8381512	\$423.92	\$549.38	\$749.21
15	83815	\$514.05	\$626.40	\$967.72
18.7x3	83818.7-3IPS	\$456.24	\$537.42	\$882.96
18.7x4	83818.7-4IPS	\$469.77	\$559.41	\$887.27
18.7x6	83818.76	\$492.63	\$671.91	\$916.10
18.7x8	83818.78	\$514.23	\$761.31	\$1,086.99
18.7x10	83818.710	\$559.94	\$851.35	\$1,303.35
18.7x12	83818.712	\$622.71	\$941.51	\$1,382.00
18.7x15	83818.715	\$650.90	\$986.26	\$1,465.27
18.7	83818.7	\$782.55	\$1,030.82	\$1,825.85
21x3	83821-3IPS	\$680.28	\$837.93	\$1,482.41
21x4	83821-4IPS	\$693.69	\$850.93	\$1,585.95
21x6	838216	\$700.23	\$895.00	\$1,623.56
21x8	838218	\$739.12	\$1,007.28	\$1,686.70
21x10	8382110	\$760.63	\$1,232.15	\$1,798.22
21x12	8382112	\$835.61	\$1,346.51	\$1,923.24
21x15	8382115	\$891.32	\$1,434.49	\$2,134.87
21x18.7	8382118.7	\$949.15	\$1,523.23	\$2,416.22
21	83821	\$1,167.17	\$1,792.91	\$2,895.58
24x3	83824-3IPS	\$1,737.40	\$2,332.56	\$2,915.71
24x4	83824-4IPS	\$1,755.97	\$2,356.58	\$2,945.18
24x6	838246	\$1,793.24	\$2,405.62	\$3,006.62
24x8	838248	\$1,883.37	\$2,537.70	\$3,173.68
24x10	8382410	\$1,974.64	\$2,664.72	\$3,331.84
24x12	8382412	\$2,063.74	\$2,762.03	\$3,453.16
24x15	8382415	\$2,152.46	\$2,951.11	\$3,687.35
24x18.7	8382418.7	\$2,243.40	\$3,121.37	\$3,902.41
24x21	8382421	\$2,466.58	\$3,281.65	\$4,101.85
24	83824	\$2,736.24	\$3,405.63	\$4,256.86
27x3	83827-3IPS	\$2,567.34	\$2,915.72	\$3,646.26
27x4	83827-4IPS	\$2,593.55	\$2,945.18	\$3,683.39
27x6	838276	\$2,647.12	\$3,006.30	\$3,759.35
27x8	838278	\$2,780.49	\$3,173.57	\$3,967.16
27x10	8382710	\$2,915.72	\$3,332.06	\$4,163.41
27x12	8382712	\$3,029.02	\$3,452.04	\$4,316.12
27x15	8382715	\$3,252.59	\$3,687.45	\$4,609.23
27x18.7	8382718.7	\$3,431.96	\$3,902.33	\$4,877.90
27x21	8382721	\$3,588.92	\$4,102.66	\$5,138.74
27x24	8382724	\$3,768.08	\$4,258.48	\$5,271.95
27	83827	\$4,464.29	\$5,109.01	\$6,283.18

PVC GASKETED PIP FITTINGS

TEE

MALE X FEMALE X FEMALE

Size	PartNumber	SDR 51: 80 PSI (14)	SDR 41: 100 PSI (15)	SDR 32.5: 125 PSI (16)
6x2	__8306-2IPS	\$106.83	\$118.70	\$128.81
6x3	__8306-3IPS	\$109.00	\$121.11	\$131.42
6x4	__8306-4IPS	\$110.10	\$123.57	\$134.09
6x6	__83066	\$117.60	\$131.98	\$143.29
8x2	__8308-2IPS	\$129.57	\$143.96	\$155.20
8x3	__8308-3IPS	\$132.20	\$146.88	\$158.35
8x4	__8308-4IPS	\$133.53	\$149.87	\$161.56
8x6	__83086	\$141.14	\$158.41	\$188.52
8x8	__83088	\$157.08	\$176.29	\$215.46
10x2	__83010-2IPS	\$190.02	\$211.14	\$224.53
10x3	__83010-3IPS	\$193.88	\$215.42	\$229.08
10x4	__83010-4IPS	\$211.00	\$219.80	\$233.74
10x6	__830106	\$215.20	\$229.14	\$259.77
10x8	__830108	\$237.29	\$246.22	\$282.38
10x10	__8301010	\$241.62	\$268.31	\$323.13
12x2	__83012-2IPS	\$239.36	\$265.95	\$301.18
12x3	__83012-3IPS	\$244.22	\$271.35	\$307.30
12x4	__83012-4IPS	\$245.83	\$276.86	\$313.54
12x6	__830126	\$252.67	\$286.19	\$336.14
12x8	__830128	\$292.64	\$319.38	\$358.76
12x10	__8301210	\$301.04	\$325.37	\$403.06
12x12	__8301212	\$333.38	\$364.54	\$448.28
15x3	__83015-3IPS	\$386.81	\$409.10	\$538.45
15x4	__83015-4IPS	\$390.70	\$413.21	\$543.89
15x6	__830156	\$395.78	\$479.07	\$578.50
15x8	__830158	\$416.86	\$487.40	\$600.50
15x10	__8301510	\$448.74	\$500.16	\$630.82
15x12	__8301512	\$478.29	\$543.89	\$673.77
15x15	__8301515	\$530.93	\$647.63	\$791.49
18.7x3	__83018.7-3IPS	\$506.70	\$564.57	\$694.53
18.7x4	__83018.7-4IPS	\$512.03	\$571.14	\$702.33
18.7x6	__83018.76	\$548.90	\$577.73	\$767.88
18.7x8	__83018.78	\$559.75	\$693.72	\$834.63
18.7x10	__83018.710	\$622.69	\$724.12	\$901.98
18.7x12	__83018.712	\$675.80	\$770.54	\$945.06
18.7x15	__83018.715	\$706.36	\$812.31	\$1,010.43
18.7x18	__83018.718	\$850.26	\$989.40	\$1,274.43
21x3	__83021-3IPS	\$786.27	\$956.61	\$1,152.08
21x4	__83021-4IPS	\$794.63	\$967.00	\$1,164.73
21x6	__830216	\$802.12	\$989.36	\$1,187.50
21x8	__830218	\$846.67	\$1,041.13	\$1,243.37
21x10	__8302110	\$871.77	\$1,056.08	\$1,284.92
21x12	__8302112	\$957.58	\$1,119.94	\$1,407.55
21x15	__8302115	\$1,036.04	\$1,164.73	\$1,518.04
21x18	__8302118	\$1,174.50	\$1,406.59	\$1,716.03
21x21	__8302121	\$1,338.70	\$1,649.52	\$2,015.23
24x3	__83024-3IPS	\$2,071.56	\$2,350.03	\$2,936.44
24x4	__83024-4IPS	\$2,093.40	\$2,374.05	\$2,967.02
24x6	__830246	\$2,137.18	\$2,423.04	\$3,027.95
24x8	__830248	\$2,250.43	\$2,511.81	\$3,185.23
24x10	__8302410	\$2,364.91	\$2,557.36	\$3,364.13
24x12	__8302412	\$2,492.76	\$2,623.70	\$3,544.36
24x15	__8302415	\$2,623.21	\$2,736.09	\$3,723.69
24x18	__8302418	\$2,758.81	\$2,869.23	\$3,904.72
24x21	__8302421	\$2,904.73	\$3,051.47	\$4,127.64
24x24	__8302424	\$3,056.80	\$3,185.76	\$4,344.65
27x3	__83027-3IPS	\$2,593.01	\$2,938.39	\$3,700.60
27x4	__83027-4IPS	\$2,619.21	\$2,968.07	\$3,737.98
27x6	__830276	\$2,672.38	\$3,028.33	\$3,813.88
27x8	__830278	\$2,812.82	\$3,184.65	\$3,993.87
27x10	__8302710	\$2,956.34	\$3,365.25	\$4,172.32
27x12	__8302712	\$3,116.61	\$3,544.35	\$4,374.03
27x15	__8302715	\$3,280.90	\$3,723.81	\$4,532.17
27x18	__8302718	\$3,451.26	\$3,925.20	\$4,890.74
27x21	__8302721	\$3,631.98	\$4,128.92	\$5,159.54
27x24	__8302724	\$3,825.23	\$4,308.51	\$5,450.31
27x27	__8302727	\$4,396.45	\$5,046.58	\$6,395.37

MALE X GASKET X SOLVENT WELD BELL

Size	PartNumber	SDR 51: 80	SDR 41:	SDR 32.5:
		PSI (14)	100 PSI (15)	125 PSI (16)
6x2	__8416-2IPS	\$107.91	\$89.87	\$118.18
6x3	__8416-3IPS	\$110.10	\$97.52	\$125.54
6x4	__8416-4IPS	\$111.21	\$102.33	\$129.03
6x6	__84166	\$126.50	\$111.33	\$182.30
8x2	__8418-2IPS	\$129.48	\$124.15	\$183.94
8x3	__8418-3IPS	#VALUE!	\$134.51	\$188.77
8x4	__8418-4IPS	\$133.44	\$149.87	\$201.48
8x6	__84186	\$142.57	\$158.41	\$209.60
8x8	__84188	\$159.05	\$179.31	\$254.94
10x2	__84110-2IPS	\$178.63	\$205.65	\$264.47
10x3	__84110-3IPS	\$195.84	\$213.87	\$280.35
10x4	__84110-4IPS	\$205.91	\$219.80	\$292.32
10x6	__841106	\$215.20	\$240.81	\$305.75
10x8	__841108	\$223.83	\$246.22	\$317.04
10x10	__8411010	\$232.12	\$267.15	\$372.96
12x2	__84112-2IPS	\$245.36	\$249.44	\$345.33
12x3	__84112-3IPS	\$253.85	\$259.07	\$351.33
12x4	__84112-4IPS	\$260.12	\$268.00	\$366.17
12x6	__841126	\$267.91	\$290.47	\$409.38
12x8	__841128	\$276.19	\$311.99	\$430.13
12x10	__8411210	\$285.30	\$335.02	\$455.76
12x12	__8411212	\$313.08	\$357.91	\$541.59
15x3	__84115-3IPS	\$308.55	\$401.76	\$590.00
15x4	__84115-4IPS	\$311.48	\$423.73	\$614.53
15x6	__841156	\$335.53	\$447.70	\$637.62
15x8	__841158	\$358.55	\$469.58	\$667.05
15x10	__8411510	\$402.43	\$467.35	\$706.64
15x12	__8411512	\$424.59	\$560.41	\$749.23
15x15	__8411515	\$515.10	\$626.22	\$966.61
18.7x3	__84118.7-3IPS	\$456.62	\$536.22	\$881.81
18.7x4	__84118.7-4IPS	\$470.82	\$560.39	\$887.91
18.7x6	__84118.76	\$493.75	\$672.72	\$915.61
18.7x8	__84118.78	\$514.12	\$761.83	\$1,088.87
18.7x10	__84118.710	\$559.45	\$850.62	\$1,302.39
18.7x12	__84118.712	\$622.96	\$941.00	\$1,381.51
18.7x15	__84118.715	\$650.86	\$986.61	\$1,466.50
18.7x18	__84118.718	\$783.53	\$1,030.44	\$1,825.30
21x3	__84121-3IPS	\$679.96	\$838.45	\$1,481.35
21x4	__84121-4IPS	\$692.86	\$851.16	\$1,584.95
21x6	__841216	\$701.19	\$894.61	\$1,622.32
21x8	__841218	\$739.52	\$1,008.39	\$1,685.59
21x10	__8412110	\$760.82	\$1,232.56	\$1,797.38
21x12	__8412112	\$835.62	\$1,345.84	\$1,920.60
21x15	__8412115	\$1,079.50	\$1,434.49	\$2,133.64
21x18	__8412118	\$1,023.42	\$1,523.27	\$2,416.48
21x21	__8412121	\$1,168.00	\$1,792.94	\$2,895.66
24x3	__84124-3IPS	\$1,738.34	\$2,332.99	\$2,917.00
24x4	__84124-4IPS	\$1,755.90	\$2,356.55	\$2,946.46
24x6	__841246	\$1,791.55	\$2,404.40	\$3,006.28
24x8	__841248	\$1,882.99	\$2,538.25	\$3,172.28
24x10	__8412410	\$1,973.56	\$2,664.48	\$3,329.42
24x12	__8412412	\$2,063.73	\$2,761.81	\$3,461.58
24x15	__8412415	\$2,152.90	\$2,951.68	\$3,685.43
24x18	__8412418	\$2,243.00	\$3,121.24	\$3,900.90
24x21	__8412421	\$2,467.32	\$3,280.54	\$4,101.34
24x24	__8412424	\$2,736.39	\$3,405.71	\$4,256.18
27x3	__84127-3IPS	\$2,569.59	\$2,916.89	\$3,644.56
27x4	__84127-4IPS	\$2,595.55	\$2,946.35	\$3,681.38
27x6	__841276	\$2,648.25	\$3,006.18	\$3,756.12
27x8	__841278	\$2,780.43	\$3,173.63	\$3,965.65
27x10	__8412710	\$2,915.72	\$3,329.58	\$4,159.96
27x12	__8412712	\$3,028.06	\$3,450.85	\$4,314.66
27x15	__8412715	\$3,252.71	\$3,685.49	\$4,608.42
27x18	__8412718	\$3,432.15	\$3,901.29	\$4,876.51
27x21	__8412721	\$3,588.92	\$4,100.53	\$5,125.20
27x24	__8412724	\$3,768.11	\$4,257.44	\$5,270.51
27x27	__8412727	\$4,487.08	\$5,108.06	\$6,282.73

PVC GASKETED PIP FITTINGS

TEE

RISER

PIP x PIP x IPS

FEMALE X FEMALE X FIPT



Size	PartNumber	SDR 51: 80 PSI (14)	SDR 41: 100 PSI (15)	SDR 32.5: 125 PSI (16)
6x2	8406-2IPS	\$76.10	\$79.27	\$94.65
6x3	8406-3IPS	\$93.26	\$97.14	\$97.14
6x4	8406-4IPS	\$101.34	\$105.56	\$124.28
8x2	8408-2IPS	\$114.46	\$119.23	\$144.21
8x3	8408-3IPS	\$125.06	\$130.27	\$130.27
8x4	8408-4IPS	\$134.90	\$140.53	\$179.84
10x2	84010-2IPS	\$157.22	\$172.08	\$209.28
10x3	84010-3IPS	\$165.90	\$189.17	\$228.47
10x4	84010-4IPS	\$179.84	\$202.71	\$242.41
12x2	84012-2IPS	\$215.46	\$241.88	\$291.85
12x3	84012-3IPS	\$224.14	\$254.64	\$307.49
12x4	84012-4IPS	\$238.07	\$272.64	\$325.76
15x3	84015-3IPS	\$336.14	\$364.54	\$467.08
15x4	84015-4IPS	\$358.76	\$382.42	\$491.27
18.7x3	84018.7-3IPS	\$604.60	\$662.83	\$868.56
18.7x4	84018.7-4IPS	\$614.18	\$680.97	\$877.10
21x3	84021-3IPS	\$918.13	\$1,044.07	\$1,330.80
21x4	84021-4IPS	\$940.74	\$1,084.03	\$1,368.75
24x3	84024-3IPS	\$1,281.23	\$1,495.77	\$1,861.51
24x4	84024-4IPS	\$1,298.58	\$1,514.05	\$1,921.56
27x3	84027-3IPS	\$1,612.25	\$1,433.12	\$2,286.78
27x4	84027-4IPS	\$1,657.34	\$1,473.19	\$2,309.58

MALE X FEMALE X FIPT



Size	PartNumber	SDR 51: 80 PSI (14)	SDR 41: 100 PSI (15)	SDR 32.5: 125 PSI (16)
6x2	8506-2IPS	\$71.94	\$74.93	\$90.31
6x3	8506-3IPS	\$93.26	\$97.14	\$97.14
6x4	8506-4IPS	\$97.30	\$101.36	\$117.26
8x2	8508-2IPS	\$101.34	\$105.56	\$134.61
8x3	8508-3IPS	\$125.06	\$130.27	\$130.27
8x4	8508-4IPS	\$130.87	\$136.32	\$153.44
10x2	85010-2IPS	\$144.21	\$158.41	\$179.84
10x3	85010-3IPS	\$151.96	\$165.61	\$192.86
10x4	85010-4IPS	\$155.51	\$173.79	\$211.12
12x2	85012-2IPS	\$211.91	\$219.80	\$246.75
12x3	85012-3IPS	\$219.80	\$237.68	\$269.23
12x4	85012-4IPS	\$222.44	\$246.22	\$291.85
15x3	85015-3IPS	\$297.18	\$325.37	\$390.44
15x4	85015-4IPS	\$321.19	\$351.79	\$422.15
18.7x3	85018.7-3IPS	\$613.95	\$675.84	\$845.51
18.7x4	85018.7-4IPS	\$628.12	\$680.97	\$854.89
21x3	85021-3IPS	\$944.16	\$1,021.59	\$1,313.60
21x4	85021-4IPS	\$970.32	\$1,030.26	\$1,348.14
24x3	85024-3IPS	\$1,321.20	\$1,468.03	\$1,834.55
24x4	85024-4IPS	\$1,359.45	\$1,511.55	\$1,887.54
27x3	85027-3IPS	\$1,612.25	\$1,836.27	\$2,294.15
27x4	85027-4IPS	\$1,657.34	\$1,880.70	\$2,360.92
30x3	85030-3IPS	\$5,242.97	\$5,405.12	\$6,215.89
30x4	85030-4IPS	\$5,505.12	\$5,675.38	\$6,526.69

REINFORCED

FEMALE X FEMALE X FIPT



Size	PartNumber	SDR 51: 80 PSI (14)	SDR 41: 100 PSI (15)	SDR 32.5: 125 PSI (16)
6x2	8406-2IPSR	\$115.68	\$118.04	\$136.93
6x3	8406-3IPSR	\$141.80	\$144.69	\$167.84
6x4	8406-4IPSR	\$154.24	\$157.39	\$182.57
8x2	8408-2IPSR	\$174.13	\$177.68	\$206.11
8x3	8408-3IPSR	\$190.31	\$194.20	\$225.27
8x4	8408-4IPSR	\$205.22	\$209.41	\$242.91
10x2	84010-2IPSR	\$251.24	\$256.36	\$297.38
10x3	84010-3IPSR	\$276.13	\$281.76	\$326.85
10x4	84010-4IPSR	\$296.02	\$302.06	\$350.39
12x2	84012-2IPSR	\$353.28	\$360.49	\$418.17
12x3	84012-3IPSR	\$371.91	\$379.50	\$440.22
12x4	84012-4IPSR	\$398.07	\$406.19	\$471.19
15x3	84015-3IPSR	\$532.40	\$543.27	\$695.93
15x4	84015-4IPSR	\$558.54	\$569.94	\$731.87

REINFORCED

MALE X FEMALE X FIPT



Size	PartNumber	SDR 51: 80 PSI (14)	SDR 41: 100 PSI (15)	SDR 32.5: 125 PSI (16)
6x2	8506-2IPSR	\$109.44	\$111.67	\$129.54
6x3	8506-3IPSR	\$141.80	\$144.69	\$167.84
6x4	8506-4IPSR	\$148.04	\$151.06	\$175.23
8x2	8508-2IPSR	\$154.24	\$157.39	\$182.57
8x3	8508-3IPSR	\$180.36	\$184.04	\$213.49
8x4	8508-4IPSR	\$199.04	\$203.10	\$235.59
10x2	85010-2IPSR	\$231.37	\$236.09	\$273.86
10x3	85010-3IPSR	\$243.78	\$248.76	\$288.56
10x4	85010-4IPSR	\$253.72	\$258.90	\$300.33
12x2	85012-2IPSR	\$320.93	\$327.48	\$379.87
12x3	85012-3IPSR	\$347.04	\$354.12	\$410.78
12x4	85012-4IPSR	\$359.49	\$366.83	\$425.52
15x3	85015-3IPSR	\$475.16	\$484.86	\$598.22
15x4	85015-4IPSR	\$513.73	\$524.21	\$652.27

REPAIR STYLE

PIP x PIP x IPS

FEMALE X FEMALE X FIPT



Size	PartNumber	SDR 51: 80 PSI (14)	SDR 41: 100 PSI (15)	SDR 32.5: 125 PSI (16)
6x2	8006-2IPS	\$87.36	\$91.96	\$122.30
6x3	8006-3IPS	\$106.41	\$112.01	\$148.97
6x4	8006-4IPS	\$116.33	\$122.45	\$162.86
8x2	8008-2IPS	\$131.39	\$138.30	\$183.95
8x3	8008-3IPS	\$145.24	\$152.89	\$203.34
8x4	8008-4IPS	\$154.86	\$163.01	\$216.80
10x2	80010-2IPS	\$189.63	\$199.61	\$236.70
10x3	80010-3IPS	\$187.33	\$197.19	\$262.27
10x4	80010-4IPS	\$223.39	\$235.15	\$312.75
12x2	80012-2IPS	\$266.55	\$280.58	\$373.18
12x3	80012-3IPS	\$285.50	\$300.52	\$399.70
12x4	80012-4IPS	\$300.45	\$316.27	\$420.64
15x3	80015-3IPS	\$401.72	\$422.86	\$562.41
15x4	80015-4IPS	\$421.43	\$443.61	\$590.00
18.7x3	80018.7-3IPS	\$730.44	\$768.88	\$1,022.61
18.7x4	80018.7-4IPS	\$750.43	\$789.93	\$1,050.60
21x3	80021-3IPS	\$1,150.56	\$1,211.12	\$1,610.78
21x4	80021-4IPS	\$1,194.61	\$1,257.48	\$1,672.45
24x3	80024-3IPS	\$1,648.34	\$1,735.10	\$2,307.68
24x4	80024-4IPS	\$1,668.49	\$1,756.30	\$2,335.88
27x3	80027-3IPS	\$2,023.57	\$2,130.07	\$2,832.99
27x4	80027-4IPS	\$2,048.47	\$2,156.29	\$2,867.86

PVC GASKETED PIP FITTINGS

TEE

MALE X FEMALE X FIPT



Size	PartNumber	SDR 51: 80	SDR 41:	SDR 32.5:
		PSI (14)	100 PSI (15)	125 PSI (16)
6x2	__8016-2IPS	\$86.50	\$91.05	\$118.29
6x3	__8016-3IPS	\$95.84	\$100.90	\$138.34
6x4	__8016-4IPS	\$100.89	\$106.20	\$145.62
8x2	__8018-2IPS	\$111.04	\$116.43	\$158.41
8x3	__8018-3IPS	\$123.05	\$129.52	\$175.53
8x4	__8018-4IPS	\$129.52	\$136.39	\$184.77
10x2	__80110-2IPS	\$151.20	\$159.15	\$215.05
10x3	__80110-3IPS	\$167.53	\$176.34	\$238.21
10x4	__80110-4IPS	\$176.34	\$185.62	\$250.76
12x2	__80112-2IPS	\$217.43	\$228.89	\$308.95
12x3	__80112-3IPS	\$240.93	\$253.61	\$342.34
12x4	__80112-4IPS	\$253.61	\$467.72	\$360.36
15x3	__80115-3IPS	\$309.10	\$325.37	\$401.35
15x4	__80115-4IPS	\$334.20	\$351.79	\$437.63
18.7x3	__80118.7-3IPS	\$642.05	\$675.84	\$845.17
18.7x4	__80118.7-4IPS	\$646.92	\$680.97	\$855.68
21x3	__80121-3IPS	\$970.51	\$1,021.59	\$1,310.81
21x4	__80121-4IPS	\$978.75	\$1,030.26	\$1,348.14
24x3	__80124-3IPS	\$1,394.63	\$1,468.03	\$1,834.55
24x4	__80124-4IPS	\$1,536.87	\$1,617.77	\$1,887.54
27x3	__80127-3IPS	\$1,744.45	\$1,836.27	\$2,294.15
27x4	__80127-4IPS	\$1,786.66	\$1,880.70	\$2,360.92

WYE

FEMALE X FEMALE X FEMALE

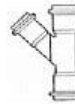

§ Available in Larger Sizes.

§ Available with Dissimilar Outlets.

Size	PartNumber	SDR 51: 80	SDR 41:	SDR 32.5:
		PSI (14)	100 PSI (15)	125 PSI (16)
6x2	__9206-2IPS	\$143.52	\$159.46	\$173.04
6x3	__9206-3IPS	\$146.43	\$162.70	\$176.56
6x4	__9206-4IPS	\$75.05	\$164.34	\$178.34
6	__9206	\$86.05	\$175.54	\$190.57
8x2	__9208-2IPS	\$174.06	\$193.40	\$208.50
8x3	__9208-3IPS	\$177.60	\$197.33	\$212.73
8x4	__9208-4IPS	\$114.67	\$199.32	\$214.88
8x6	__92086	\$123.41	\$210.68	\$250.73
8	__9208	\$162.40	\$234.47	\$286.56
10x2	__92010-2IPS	\$255.28	\$283.65	\$301.64
10x3	__92010-3IPS	\$260.47	\$289.41	\$307.76
10x4	__92010-4IPS	\$137.70	\$292.33	\$310.87
10x6	__920106	\$155.92	\$304.75	\$345.49
10x8	__920108	\$182.10	\$327.47	\$375.57
10	__92010	\$237.66	\$356.85	\$429.76
12x2	__92012-2IPS	\$321.56	\$357.29	\$404.62
12x3	__92012-3IPS	\$328.09	\$364.54	\$412.84
12x4	__92012-4IPS	\$193.94	\$368.22	\$417.01
12x6	__920126	\$234.30	\$380.63	\$447.07
12x8	__920128	\$262.27	\$424.77	\$477.15
12x10	__9201210	\$282.28	\$432.74	\$536.07
12	__92012	\$386.31	\$484.83	\$596.22
15x3	__92015-3IPS	\$519.63	\$549.57	\$723.37
15x4	__92015-4IPS	\$524.88	\$555.12	\$730.68
15x6	__920156	\$531.70	\$643.60	\$777.18
15x8	__920158	\$560.02	\$654.78	\$806.73
15x10	__9201510	\$602.85	\$671.93	\$847.47
15x12	__9201512	\$642.56	\$730.68	\$905.17
15	__92015	\$708.12	\$876.84	\$1,051.33
18.7x3	__92018.7-3IPS	\$674.20	\$752.61	\$925.37
18.7x4	__92018.7-4IPS	\$681.01	\$760.21	\$934.72
18.7x6	__92018.76	\$729.63	\$817.91	\$1,023.01
18.7x8	__92018.78	\$745.53	\$923.35	\$1,110.26
18.7x10	__92018.710	\$829.11	\$964.09	\$1,197.51
18.7x12	__92018.712	\$899.40	\$1,023.01	\$1,256.42
18.7x15	__92018.715	\$940.13	\$1,080.89	\$1,343.68
21x3	__92021-3IPS	\$1,046.01	\$1,272.94	\$1,532.07
21x4	__92021-4IPS	\$1,056.58	\$1,285.80	\$1,547.54
21x6	__920216	\$1,067.95	\$1,314.12	\$1,577.10
21x8	__920218	\$1,124.42	\$1,384.41	\$1,652.97
21x10	__9202110	\$1,159.57	\$1,402.61	\$1,706.13
21x12	__9202112	\$1,272.69	\$1,489.84	\$1,869.44
21x15	__9202115	\$1,377.95	\$1,547.54	\$2,015.43
21x18.7	__9202118.7	\$1,558.92	\$1,869.44	\$2,278.40
21	__92021	\$1,777.12	\$2,189.93	\$2,674.95
24x3	__92024-3IPS	\$2,754.29	\$3,120.92	\$3,900.97
24x4	__92024-4IPS	\$2,782.11	\$3,152.44	\$3,940.37
24x6	__920246	\$2,838.60	\$3,216.45	\$4,020.38
24x8	__920248	\$2,987.57	\$3,335.34	\$4,228.44
24x10	__9202410	\$3,140.03	\$3,395.48	\$4,466.41
24x12	__9202412	\$3,309.98	\$3,482.85	\$4,705.60
24x15	__9202415	\$3,483.26	\$3,633.45	\$4,943.56
24x18.7	__9202418.7	\$3,663.51	\$3,811.27	\$5,181.52
24x21	__9202421	\$3,857.59	\$4,050.46	\$5,479.63
24	__92024	\$4,059.72	\$4,228.44	\$5,764.98
27x3	__92027-3IPS	\$3,442.58	\$3,900.97	\$4,912.09
27x4	__92027-4IPS	\$3,477.35	\$3,940.37	\$4,961.71
27x6	__920276	\$3,547.95	\$4,020.38	\$5,062.45
27x8	__920278	\$3,733.98	\$4,228.44	\$5,300.59
27x10	__9202710	\$3,925.78	\$4,466.41	\$5,538.56
27x12	__9202712	\$4,138.22	\$4,705.60	\$5,806.60
27x15	__9202715	\$4,355.56	\$4,943.56	\$6,015.71
27x18.7	__9202718.7	\$4,580.76	\$5,211.60	\$6,491.64
27x21	__9202721	\$4,822.21	\$5,479.63	\$6,848.67
27x24	__9202724	\$5,076.45	\$5,717.59	\$7,235.60
27	__92027	\$5,836.50	\$6,699.52	\$8,486.79

PVC GASKETED PIP FITTINGS

PVC FITTINGS

PIP: SOLVENT WELD SDR81 - SDR32.5



Specified Fittings



Frequently Asked Questions

Q: Can PVC be successfully fused for pressure applications?

A: We cannot vouch for others, but at Specified Fittings the answer is yes. Although not totally at liberty to describe the method we use to achieve universally successful fuses, suffice it to say with over a decade of experience, the PVC fuse for pressure is a done deal at Specified.

Q: Why are gaskets made from different materials?

A: Each gasket material, whether SBR, EPDM, FKM (Viton), NBR (Buna-N), or CR have properties that make them the gasket of choice when the contents of pipeline dictate. Handling of diverse products or conditions such as steam, alcohol, methanol, greases, low temperature, or silicate ester lubricants, demand a certain gasket material with the proper resistant characteristics.

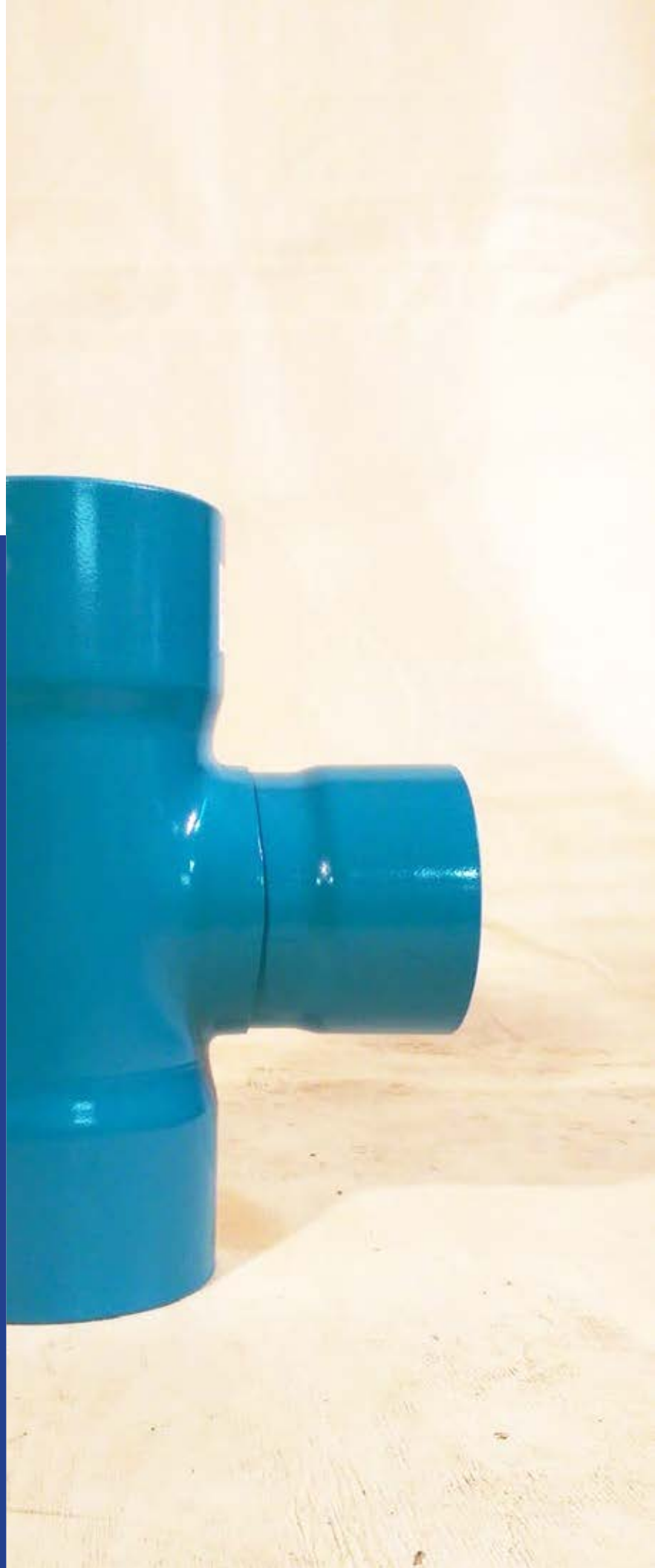

ADAPTER

PIP X IPS

FEMALE X FEMALE

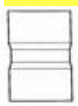

Size	PartNumber	SDR81: 50 PSI (03)	SDR51: 80 PSI (05)	SDR41: 100 PSI (06)	SDR32.5: 125 PSI (07)
4	1054-IPS	\$13.09	\$13.49	\$13.84	\$16.43
6x2	1056-2IPS	\$18.07	\$59.92	\$66.58	\$85.85
6x3	1056-3IPS	\$18.07	\$61.50	\$68.33	\$87.98
6x4	1056-4IPS	\$26.83	\$27.66	\$28.52	\$34.61
6	1056-IPS	\$25.64	\$26.43	\$27.25	\$34.61
8x2	1058-2IPS	\$26.65	\$61.52	\$68.36	\$87.98
8x3	1058-3IPS	\$26.65	\$62.63	\$69.59	\$88.97
8x4	1058-4IPS	\$26.65	\$54.24	\$60.26	\$89.86
8x6	1058-6IPS	\$40.88	\$42.14	\$43.45	\$51.03
8	1058-IPS	\$36.86	\$37.99	\$39.17	\$46.70
10x2	10510-2IPS	\$41.93	\$79.57	\$88.40	\$116.03
10x3	10510-3IPS	\$41.93	\$83.93	\$93.26	\$121.69
10x4	10510-4IPS	\$41.93	\$88.94	\$98.82	\$128.15
10x8	10510-8IPS	\$56.10	\$57.83	\$59.61	\$64.88
10	10510-IPS	\$61.72	\$63.63	\$65.59	\$80.42
12x2	10512-2IPS	\$61.02	\$113.26	\$125.85	\$164.53
12x3	10512-3IPS	\$61.02	\$122.98	\$136.64	\$178.85
12x4	10512-4IPS	\$61.02	\$133.22	\$148.02	\$188.90
12x10	10512-10IPS	\$80.96	\$83.46	\$86.04	\$104.64
12	10512-IPS	\$96.15	\$99.11	\$102.18	\$107.24
15x3	10515-3IPS	\$92.54	\$159.82	\$177.57	\$233.21
15x4	10515-4IPS	\$92.54	\$163.08	\$181.20	\$242.41
15x12	10515-12IPS	\$130.62	\$134.66	\$138.83	\$185.96
15 x 16	10515-16IPS	\$206.00	\$216.31	\$227.13	\$306.63
18.7x3	10518.7-3IPS	CF	\$270.97	\$301.09	\$390.76
18.7x4	10518.7-4IPS	CF	\$277.09	\$307.88	\$399.09
21x3	10521-3IPS	CF	\$406.22	\$451.35	\$586.29
21x4	10521-4IPS	CF	\$414.87	\$460.97	\$598.17
21x20	10521-20IPS	CF	\$496.30	\$511.66	\$568.50
24x3	10524-3IPS	CF	\$618.82	\$687.57	\$895.37
24x4	10524-4IPS	CF	\$625.06	\$694.52	\$903.64
24x24	10524-24IPS	CF	\$713.71	\$735.80	\$817.55
27x3	10527-3IPS	CF	\$790.66	\$878.51	\$1,132.87
27x4	10527-4IPS	CF	\$806.80	\$896.44	\$1,153.41

FEMALE X MALE



Size	PartNumber	SDR81: 50 PSI (03)	SDR51: 80 PSI (05)	SDR41: 100 PSI (06)	SDR32.5: 125 PSI (07)
6	1716	\$17.39	\$26.37	\$28.54	\$34.23
8	1718	\$15.24	\$40.84	\$31.49	\$54.50
10	17110	\$21.09	\$57.74	\$68.90	\$80.92
12	17112	\$28.74	\$71.07	\$84.25	\$106.40
15	17115	\$50.63	\$109.88	\$166.11	\$193.17
18.7	17118.7	CF	\$184.49	\$224.88	\$254.21
21	17121	CF	\$269.84	\$333.33	\$387.36
24	17124	CF	\$334.75	\$516.05	\$442.10
27	17127	CF	\$428.14	\$535.02	\$668.88

AIR RELIEF VALVE ADAPTER

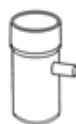

Size	PartNumber	SDR81: 50 PSI (03)	SDR51: 80 PSI (05)	SDR41: 100 PSI (06)	SDR32.5: 125 PSI (07)
6x2	10362	\$55.38	CF	\$57.09	CF
8x3	10383	\$75.66	CF	\$57.33	CF
10x3	103103	\$93.24	\$91.73	\$104.66	CF
12x4	103124	\$125.59	\$124.56	\$142.70	CF
14x4	103144	\$197.90	\$196.60	\$215.68	CF
15x4	103154	\$197.90	\$196.60	\$226.42	CF

IPS X PIP

MALE X FEMALE (BUSHING)



Size	PartNumber	SDR81: 50 PSI (03)	SDR51: 80 PSI (05)	SDR41: 100 PSI (06)	SDR32.5: 125 PSI (07)
6	1716-IPS	CF	CF	\$28.54	CF
8	1718-IPS	CF	CF	\$31.12	CF
10	17110-IPS	CF	CF	\$68.90	CF
12	17112-IPS	CF	CF	\$84.25	CF

FIPT X FEMALE

FEMALE

Size	PartNumber	SDR81: 50 PSI (03)	SDR51: 80 PSI (05)	SDR41: 100 PSI (06)	SDR32.5: 125 PSI (07)
6	1306	-	-	\$84.73	CF
8	1308			\$126.52	CF
10	13010			\$175.98	CF
12	13012			\$203.60	CF

PIP x VALVE

FEMALE X FEMALE

Size	PartNumber	SDR81: 50 PSI (03)	SDR51: 80 PSI (05)	SDR41: 100 PSI (06)	SDR32.5: 125 PSI (07)
6	1386	CF	CF	\$30.27	CF
8	1388	CF	CF	\$38.06	CF
10	13810	CF	CF	\$61.39	CF
12	13812	CF	CF	\$79.58	CF
15	13815	CF	CF	\$150.49	CF

OD

FEMALE X FEMALE

LINEGATE



Size	PartNumber	SDR81: 50 PSI (03)	SDR51: 80 PSI (05)	SDR41: 100 PSI (06)	SDR32.5: 125 PSI (07)
6	1396	CF	CF	\$30.27	CF
8	1398	CF	CF	\$38.06	CF
10	13910	CF	CF	\$61.39	CF
12	13912	CF	CF	\$81.31	CF
15	13915	CF	CF	\$150.49	CF

PVC SOLVENT WELD PIP FITTINGS

ADAPTER

IPS X PIP

MIPT X FEMALE

MALE



Size	PartNumber	SDR81: 50 PSI (03)	SDR51: 80 PSI (05)	SDR41: 100 PSI (06)	SDR32.5: 125 PSI (07)
6	1506	CF	CF	\$75.19	CF
8	1508	CF	CF	\$106.57	CF
10	15010	CF	CF	\$156.03	CF
12	15012	CF	CF	\$183.64	CF

CAP

FEMALE



Size	PartNumber	SDR81: 50 PSI (03)	SDR51: 80 PSI (05)	SDR41: 100 PSI (06)	SDR32.5: 125 PSI (07)
6	1906	\$10.36	\$33.70	\$34.74	\$42.74
8	1908	\$17.67	\$47.08	\$48.53	\$59.70
10	19010	\$31.37	\$74.98	\$77.30	\$79.49
12	19012	\$41.86	\$89.24	\$91.99	\$112.43
15	19015	\$61.86	\$145.41	\$149.91	\$216.22
18.7	19018.7	CF	\$284.20	\$292.99	\$353.73
21	19021	CF	\$434.62	\$448.06	\$539.68
24	19024	CF	\$603.19	\$621.85	\$779.27
27	19027	CF	\$759.18	\$782.66	\$975.58

PLUG

MALE



Size	PartNumber	SDR81: 50 PSI (03)	SDR51: 80 PSI (05)	SDR41: 100 PSI (06)	SDR32.5: 125 PSI (07)
6	5606	\$12.95	CF	\$35.06	\$44.17
8	5608	\$22.09	\$78.85	\$80.46	\$106.48
10	56010	\$39.20	\$127.55	\$130.15	\$170.77
12	56012	\$52.34	\$148.15	\$151.17	\$198.89
15	56015	\$77.33	\$247.48	\$252.53	\$331.54
18.7	56018.7	CF	\$352.61	\$359.80	\$472.20
21	56021	CF	\$536.33	\$547.27	\$719.36
24	56024	CF	\$671.35	\$685.05	\$904.19
27	56027	CF	\$857.90	\$875.41	\$1,131.22

COUPLING

STOP

FEMALE X FEMALE



Size	PartNumber	SDR81: 50 PSI (03)	SDR51: 80 PSI (05)	SDR41: 100 PSI (06)	SDR32.5: 125 PSI (07)
6	2406	\$15.75	\$20.41	\$23.00	\$28.62
8	2408	\$21.25	\$25.53	\$31.48	\$38.91
10	24010	\$30.44	\$42.56	\$50.25	\$63.14
12	24012	\$40.91	\$63.89	\$77.49	\$89.83
15	24015	\$70.38	\$97.09	\$132.83	\$151.31
18.7	24018.7	CF	\$222.34	\$279.38	\$340.67
21	24021	CF	\$295.56	\$488.09	\$551.06
24	24024	CF	\$518.74	\$652.01	\$662.77
27	24027	CF	\$628.89	\$788.74	\$985.89

CROSS

FEMALE X FEMALE X FEMALE X FEMALE



Size	PartNumber	SDR81: 50 PSI (03)	SDR51: 80 PSI (05)	SDR41: 100 PSI (06)	SDR32.5: 125 PSI (07)
6x2	2606-2IPS	\$52.83	\$53.67	\$62.15	\$76.97
6x3	2606-3IPS	\$55.01	\$58.76	\$69.84	\$83.02
6x4	2606-4IPS	\$56.14	\$63.89	\$74.94	\$87.36
6	2606	\$59.93	\$70.69	\$97.94	\$123.68
8x2	2608-2IPS	\$69.41	\$66.41	\$80.02	\$93.39
8x3	2608-3IPS	\$72.27	\$72.37	\$87.71	\$104.64
8x4	2608-4IPS	\$73.75	\$77.49	\$93.70	\$118.47
8x6	26086	\$77.77	\$90.27	\$108.19	\$135.79
8	2608	\$81.83	\$120.10	\$143.09	\$179.01
10x2	26010-2IPS	\$72.54	\$102.18	\$106.48	\$121.08
10x3	26010-3IPS	\$75.52	\$109.88	\$124.33	\$130.60
10x4	26010-4IPS	\$77.08	\$122.65	\$132.83	\$166.93
10x6	260106	\$86.59	\$138.83	\$149.04	\$186.81
10x8	260108	\$108.45	\$162.68	\$181.42	\$228.32
10	26010	\$145.55	\$203.57	\$246.16	\$290.59
12x2	26012-2IPS	\$87.75	\$153.31	\$156.73	\$201.54
12x3	26012-3IPS	\$91.38	\$169.49	\$171.23	\$216.22
12x4	26012-4IPS	\$93.24	\$172.91	\$187.39	\$236.10
12x6	260126	\$102.74	\$185.68	\$206.12	\$259.47
12x8	260128	\$120.82	\$216.35	\$240.18	\$302.72
12x10	2601210	\$162.68	\$254.68	\$289.60	\$363.26
12	26012	\$194.05	\$316.00	\$372.23	\$467.05
15x3	26015-3IPS	\$141.70	\$219.77	\$258.96	\$311.76
15x4	26015-4IPS	\$144.60	\$229.99	\$264.93	\$323.66
15x6	260156	\$156.96	\$252.96	\$292.99	\$335.62
15x8	260158	\$174.10	\$299.01	\$335.62	\$458.28
15x10	2601510	\$221.68	\$345.80	\$417.36	\$555.36
15x12	2601512	\$240.69	\$407.16	\$488.09	\$634.61
15	26015	\$292.06	\$528.97	\$641.40	\$817.76
18.7x3	26018.7-3IPS	CF	\$332.19	\$396.96	\$521.31
18.7x4	26018.7-4IPS	CF	\$344.13	\$405.47	\$553.64
18.7x6	26018.76	CF	\$368.81	\$437.84	\$610.74
18.7x8	26018.78	CF	\$408.84	\$478.72	\$691.65
18.7x10	26018.710	CF	\$451.44	\$518.74	\$793.90
18.7x12	26018.712	CF	\$527.26	\$641.40	\$899.52
18.7x15	26018.715	CF	\$638.87	\$833.96	\$1,068.20
18.7	26018.7	CF	\$915.69	\$1,037.53	\$1,322.02
21x3	26021-3IPS	CF	\$625.89	\$754.53	\$898.31
21x4	26021-4IPS	CF	\$639.38	\$770.31	\$917.32
21x6	260216	CF	\$676.63	\$935.87	\$1,050.16
21x8	260218	CF	\$723.22	\$964.96	\$1,094.76
21x10	2602110	CF	\$770.28	\$1,001.48	\$1,146.99
21x12	2602112	CF	\$845.50	\$1,011.18	\$1,423.24
21x14	2602114	CF	\$912.91	\$1,135.42	\$1,596.62
21x15	2602115	CF	\$931.16	\$1,159.16	\$1,629.66
21x18.7	2602118.7	CF	\$1,086.38	\$1,324.22	\$1,858.22
21	26021	CF	\$1,351.86	\$1,708.78	\$2,034.15
24x3	26024-3IPS	CF	\$876.69	\$1,047.47	\$1,123.15
24x4	26024-4IPS	CF	\$895.51	\$1,069.59	\$1,146.99
24x6	260246	CF	\$944.89	\$1,147.38	\$1,221.01
24x8	260248	CF	\$1,005.26	\$1,220.16	\$1,325.71
24x10	2602410	CF	\$1,035.31	\$1,326.88	\$1,423.74
24x12	2602412	CF	\$1,120.77	\$1,424.39	\$1,528.45
24x15	2602415	CF	\$1,229.51	\$1,553.70	\$1,680.90
24x18.7	2602418.7	CF	\$1,400.49	\$1,756.29	\$1,909.46
24x21	2602421	CF	\$1,576.63	\$1,883.08	\$2,267.02
24	26024	CF	\$1,932.79	\$2,277.79	\$3,132.22
27x3	26027-3IPS	CF	\$1,061.53	\$1,333.94	\$1,557.71

PVC SOLVENT WELD PIP FITTINGS

CROSS

FEMALE X FEMALE X FEMALE X FEMALE

Size	PartNumber	SDR81: 50 PSI (03)	SDR51: 80 PSI (05)	SDR41: 100 PSI (06)	SDR32.5: 125 PSI (07)
27x4	26027-4IPS	CF	\$1,084.03	\$1,361.85	\$1,589.86
27x6	260276	CF	\$1,144.22	\$1,466.53	\$1,834.17
27x8	260278	CF	\$1,219.11	\$1,573.16	\$1,963.52
27x10	2602710	CF	\$1,255.06	\$1,678.50	\$2,099.59
27x12	2602712	CF	\$1,356.21	\$1,813.83	\$2,267.23
27x15	2602715	CF	\$1,404.98	\$1,995.71	\$2,495.49
27x18.7	2602718.7	CF	\$1,698.10	\$2,264.25	\$2,828.83
27x21	2602721	CF	\$1,908.47	\$2,409.26	\$3,011.15
27x24	2602724	CF	\$2,436.48	\$2,975.17	\$3,717.97
27	26027	CF	\$2,926.45	\$3,448.52	\$4,482.21

ELBOW

11-1/4 DEGREE

FEMALE X FEMALE



Size	PartNumber	SDR81: 50 PSI (03)	SDR51: 80 PSI (05)	SDR41: 100 PSI (06)	SDR32.5: 125 PSI (07)
6	3106	\$18.07	\$23.00	\$27.25	\$33.73
8	3108	\$26.59	\$37.46	\$40.88	\$51.03
10	31010	\$38.39	\$67.27	\$77.49	\$98.60
12	31012	\$53.22	\$95.37	\$108.19	\$135.79
15	31015	\$91.53	\$148.19	\$181.42	\$235.95
18.7	31018.7	CF	\$254.68	\$301.54	\$374.76
21	31021	CF	\$425.05	\$484.67	\$631.21
24	31024	CF	\$571.57	\$631.21	\$681.47
27	31027	CF	\$716.64	\$765.27	\$995.47

15 DEGREE

FEMALE X FEMALE

Size	PartNumber	SDR81: 50 PSI (03)	SDR51: 80 PSI (05)	SDR41: 100 PSI (06)	SDR32.5: 125 PSI (07)
6	3206	\$18.07	\$23.00	\$27.25	\$33.73
8	3208	\$26.59	\$37.46	\$40.88	\$51.03
10	32010	\$38.39	\$67.27	\$77.49	\$98.60
12	32012	\$53.22	\$95.37	\$108.19	\$135.79
15	32015	\$91.53	\$148.19	\$181.42	\$235.95
18.7	32018.7	CF	\$254.68	\$301.54	\$374.76
21	32021	CF	\$425.05	\$484.67	\$631.21
24	32024	CF	\$571.57	\$631.21	\$681.47
27	32027	CF	\$716.64	\$765.27	\$995.47

22-1/2 DEGREE

FEMALE X FEMALE



Size	PartNumber	SDR81: 50 PSI (03)	SDR51: 80 PSI (05)	SDR41: 100 PSI (06)	SDR32.5: 125 PSI (07)
6	3306	\$18.07	\$23.00	\$27.25	\$33.73
8	3308	\$26.59	\$37.46	\$40.88	\$51.03
10	33010	\$38.39	\$67.27	\$77.49	\$98.60
12	33012	\$53.22	\$95.37	\$108.19	\$135.79
15	33015	\$91.53	\$148.19	\$181.42	\$236.07
18.7	33018.7	CF	\$254.68	\$301.54	\$374.76
21	33021	CF	\$425.05	\$484.67	\$631.21
24	33024	CF	\$571.57	\$631.21	\$681.47
27	33027	CF	\$716.64	\$765.32	\$995.47

30 DEGREE

FEMALE X FEMALE

Size	PartNumber	SDR81: 50 PSI (03)	SDR51: 80 PSI (05)	SDR41: 100 PSI (06)	SDR32.5: 125 PSI (07)
6	3406	\$30.44	\$34.91	\$36.60	\$47.56
8	3408	\$31.75	\$52.81	\$63.89	\$80.42
10	34010	\$56.14	\$81.74	\$96.23	\$121.97
12	34012	\$93.56	\$117.53	\$143.09	\$179.01
15	34015	\$150.60	\$185.68	\$222.34	\$275.12
18.7	34018.7	CF	\$303.24	\$370.53	\$464.23
21	34021	CF	\$490.66	\$597.98	\$753.01
24	34024	CF	\$1,399.58	\$1,626.97	\$1,707.93
27	34027	CF	\$1,542.71	\$1,735.57	\$1,911.89

45 DEGREE

FEMALE X FEMALE



Size	PartNumber	SDR81: 50 PSI (03)	SDR51: 80 PSI (05)	SDR41: 100 PSI (06)	SDR32.5: 125 PSI (07)
6	3506	\$30.44	\$34.91	\$36.60	\$47.56
8	3508	\$31.95	\$52.81	\$63.89	\$80.42
10	35010	\$56.14	\$81.74	\$96.23	\$121.97
12	35012	\$93.56	\$117.53	\$143.09	\$179.01
15	35015	\$150.60	\$185.68	\$222.34	\$275.12
18.7	35018.7	CF	\$303.24	\$370.53	\$464.23
21	35021	CF	\$490.66	\$597.98	\$753.01
24	35024	CF	\$1,399.58	\$1,626.97	\$1,707.93
27	35027	CF	\$1,542.71	\$1,735.57	\$1,911.89

60 DEGREE

FEMALE X FEMALE

Size	PartNumber	SDR81: 50 PSI (03)	SDR51: 80 PSI (05)	SDR41: 100 PSI (06)	SDR32.5: 125 PSI (07)
6	3606	\$84.67	\$90.66	\$98.80	\$124.53
8	3608	\$102.74	\$132.98	\$155.88	\$180.75
10	36010	\$169.33	\$198.01	\$219.77	\$276.76
12	36012	\$225.48	\$241.03	\$308.34	\$343.35
15	36015	\$310.14	\$402.04	\$477.86	\$546.88
18.7	36018.7	CF	\$604.79	\$712.10	\$936.14
21	36021	CF	\$946.36	\$1,147.39	\$1,409.78
24	36024	CF	\$2,115.10	\$2,522.30	\$2,656.85
27	36027	CF	\$2,253.26	\$2,688.46	\$2,957.74

90 DEGREE

FEMALE X FEMALE



Size	PartNumber	SDR81: 50 PSI (03)	SDR51: 80 PSI (05)	SDR41: 100 PSI (06)	SDR32.5: 125 PSI (07)
6	3696	\$84.67	\$90.66	\$97.53	\$124.53
8	3698	\$102.74	\$132.98	\$154.16	\$180.75
10	36910	\$169.33	\$198.01	\$205.32	\$276.76
12	36912	\$225.48	\$241.03	\$308.34	\$343.35
15	36915	\$310.14	\$402.04	\$477.86	\$546.88
18.7	37018.7	CF	\$604.79	\$712.10	\$936.14
21	37021	CF	\$946.36	\$1,147.39	\$1,409.78
24	37024	CF	\$2,115.10	\$2,522.30	\$2,656.85
27	37027	CF	\$2,253.26	\$2,688.46	\$2,957.74

PVC SOLVENT WELD PIP FITTINGS

FLANGE

IPS X PIP

FLANGE X FEMALE



Size	PartNumber	SDR81: 50 PSI (03)	SDR51: 80 PSI (05)	SDR41: 100 PSI (06)	SDR32.5: 125 PSI (07)
6	5306	\$95.50	\$95.50	\$97.45	\$121.82
8	5308	\$144.60	\$144.60	\$147.55	\$184.44
10	53010	\$203.32	\$203.32	\$207.47	\$259.34
12	53012	\$310.50	\$310.50	\$316.83	\$396.04
16x15	5301615	\$891.92	\$891.92	\$910.12	\$1,137.65
18x18.7	5301818.7	CF	\$1,360.35	\$1,388.11	\$1,735.15
20x21	5302021	CF	\$2,072.15	\$2,114.43	\$2,643.05
22x21	5302221	CF	\$2,553.35	\$2,605.46	\$3,256.82
24	53024	CF	\$3,034.55	\$3,096.48	\$3,870.60
24x27	5302427	CF	\$3,316.92	\$3,556.64	\$4,445.27

FLANGE X MALE



Size	PartNumber	SDR81: 50 PSI (03)	SDR51: 80 PSI (05)	SDR41: 100 PSI (06)	SDR32.5: 125 PSI (07)
6x6	52066	\$127.23	\$127.23	\$129.44	\$143.83
8X8	52088	\$187.43	\$187.43	\$190.23	\$210.81
10x10	5201010	\$277.68	\$277.68	\$282.52	\$313.75
12x12	5201212	\$418.21	\$418.21	\$426.58	\$473.08
16x15	5201615	\$1,012.02	\$1,012.02	\$1,032.67	\$1,147.29
18x18.7	5201818.7	CF	\$1,569.84	\$1,601.68	\$1,779.59
20x20.4	5202020.4	CF	\$2,411.24	\$2,459.35	\$2,731.90
20x21	5202021	CF	\$2,411.24	\$2,459.35	\$2,731.90
22x21	5202221	CF	\$3,327.08	\$3,394.70	\$3,771.88
24x24	5202424	CF	\$3,502.65	\$3,574.13	\$3,972.78
24x27	5202427	CF	\$3,316.92	\$3,556.64	\$4,445.27

REDUCER

FLUSH

IPS X PIP

Size	PartNumber	SDR81: 50 PSI (03)	SDR51: 80 PSI (05)	SDR41: 100 PSI (06)	SDR32.5: 125 PSI (07)
4	6054	\$19.02	\$19.02	\$19.02	\$19.02
6	6056	\$27.60	\$27.60	\$27.60	\$27.60
8	6058	\$30.44	\$30.44	\$30.44	\$30.44
10	60510	\$43.70	\$43.70	\$43.70	\$43.70
12	60512	\$66.70	\$66.70	\$66.70	\$66.70

CONCENTRIC

LARGE END BELL (LEB)

FEMALE X MALE



Size	PartNumber	SDR81: 50 PSI (03)	SDR51: 80 PSI (05)	SDR41: 100 PSI (06)	SDR32.5: 125 PSI (07)
6x2	6406-2IPS	\$26.02	\$86.28	\$95.87	\$119.84
6x3	6406-3IPS	\$26.02	\$88.55	\$98.39	\$122.99
6x4	6406-4IPS	\$26.02	\$55.96	\$41.07	\$49.83
8x2	6408-2IPS	\$38.37	\$75.79	\$84.21	\$105.26
8x3	6408-3IPS	\$38.37	\$77.33	\$85.92	\$100.89
8x4	6408-4IPS	\$38.37	\$78.10	\$86.79	\$107.14
8x6	64086	\$38.37	\$56.30	\$62.56	\$73.49
10x2	64010-2IPS	\$60.37	\$107.42	\$119.36	\$129.54
10x3	64010-3IPS	\$60.37	\$109.60	\$121.78	\$135.73
10x4	64010-4IPS	\$60.37	\$110.70	\$123.01	\$141.98
10x6	640106	\$60.37	\$112.96	\$125.51	\$142.60
10x8	640108	\$60.37	\$77.26	\$85.84	\$93.43
12x2	64012-2IPS	\$87.87	\$154.48	\$171.65	\$183.05
12x3	64012-3IPS	\$87.87	\$157.64	\$175.15	\$198.01
12x4	64012-4IPS	\$87.87	\$159.23	\$176.93	\$215.47
12x6	640126	\$87.87	\$162.48	\$180.52	\$220.44
12x8	640128	\$87.87	\$164.12	\$182.35	\$227.50
12x10	6401210	\$87.87	\$111.51	\$123.90	\$150.68
15x3	64015-3IPS	\$133.27	\$230.14	\$255.70	\$263.83
15x4	64015-4IPS	\$133.27	\$234.83	\$260.92	\$269.00
15x6	640156	\$133.27	\$244.51	\$271.68	\$280.21
15x8	640158	\$133.27	\$249.50	\$277.21	\$307.62
15x10	6401510	\$133.27	\$254.59	\$282.88	\$379.32
15x12	6401512	\$133.27	\$179.92	\$199.91	\$267.78
18.7x3	64018.7-3IPS	CF	\$422.01	\$468.90	\$562.68
18.7x4	64018.7-4IPS	CF	\$399.02	\$443.35	\$532.02
18.7x6	64018.76	CF	\$419.35	\$465.94	\$559.13
18.7x8	64018.78	CF	\$410.26	\$455.84	\$547.01
18.7x10	64018.710	CF	\$507.44	\$563.82	\$676.58
18.7x12	64018.712	CF	\$415.75	\$461.95	\$554.34
18.7x15	64018.715	CF	\$327.84	\$364.27	\$437.12
21x3	64021-3IPS	CF	\$584.95	\$649.95	\$779.93
21x4	64021-4IPS	CF	\$597.41	\$663.79	\$796.55
21x6	640216	CF	\$617.60	\$686.22	\$823.47
21x8	640218	CF	\$633.29	\$703.65	\$844.38
21x10	6402110	CF	\$656.85	\$729.82	\$875.79
21x12	6402112	CF	\$709.52	\$788.35	\$946.03
21x15	6402115	CF	\$762.21	\$846.91	\$930.59
21x18.7	6402118.7	CF	\$375.34	\$418.03	\$629.43
24x3	64024-3IPS	CF	\$891.10	\$990.11	\$1,188.13
24x4	64024-4IPS	CF	\$900.09	\$1,000.10	\$1,200.13
24x6	640246	CF	\$912.41	\$1,013.78	\$1,216.54
24x8	640248	CF	\$928.07	\$1,031.20	\$1,237.43
24x10	6402410	CF	\$941.55	\$1,046.16	\$1,255.38
24x12	6402412	CF	\$960.61	\$1,067.35	\$1,280.82
24x15	6402415	CF	\$985.27	\$1,094.75	\$1,313.69
24x18.7	6402418.7	CF	\$1,035.70	\$1,743.98	\$1,939.58
24x21	6402421	CF	\$664.59	\$1,585.44	\$1,763.22
27x3	64027-3IPS	CF	\$1,138.55	\$1,265.05	\$1,518.07
27x4	64027-4IPS	CF	\$1,161.79	\$1,290.87	\$1,549.05
27x6	640276	CF	\$1,173.04	\$1,303.38	\$1,564.04
27x8	640278	CF	\$1,186.58	\$1,318.42	\$1,582.11
27x10	6402710	CF	\$1,210.17	\$1,344.63	\$1,613.56
27x12	6402712	CF	\$1,241.73	\$1,379.70	\$1,655.64
27x15	6402715	CF	\$1,311.50	\$1,457.22	\$1,748.68
27x18.7	6402718.7	CF	\$1,360.30	\$1,511.44	\$1,813.73
27x21	6402721	CF	\$1,411.72	\$1,568.57	\$1,882.29
27x24	6402724	CF	\$1,438.72	\$1,598.58	\$1,918.31

REDUCER

CONCENTRIC

FEMALE X FEMALE



Size	PartNumber	SDR81: 50 PSI (03)	SDR51: 80 PSI (05)	SDR41: 100 PSI (06)	SDR32.5: 125 PSI (07)
8x6	60086	\$26.65	\$39.09	\$43.45	\$51.03
10x6	600106	\$41.93	\$78.44	\$87.16	\$99.03
10x8	600108	\$41.93	\$53.65	\$59.61	\$64.88
12x6	600126	\$61.02	\$137.51	\$152.80	\$198.32
12x8	600128	\$61.02	\$113.98	\$126.63	\$157.99
12x10	6001210	\$61.02	\$77.44	\$86.04	\$104.64
15x6	600156	\$92.54	\$169.80	\$188.66	\$251.12
15x8	600158	\$92.54	\$191.58	\$212.87	\$276.91
15x10	6001510	\$92.54	\$176.80	\$196.44	\$263.41
15x12	6001512	\$92.54	\$124.95	\$138.83	\$185.96
18.7x6	60018.76	CF	\$278.71	\$309.67	\$403.14
18.7x8	60018.78	CF	\$284.90	\$316.56	\$409.81
18.7x10	60018.710	CF	\$352.38	\$391.54	\$508.11
18.7x12	60018.712	CF	\$288.72	\$320.79	\$400.23
18.7x15	60018.715	CF	\$227.67	\$252.96	\$307.77
21x6	600216	CF	\$428.88	\$476.54	\$618.97
21x8	600218	CF	\$439.78	\$488.65	\$635.33
21x10	6002110	CF	\$456.14	\$506.82	\$659.44
21x12	6002112	CF	\$492.72	\$547.47	\$711.20
21x15	6002115	CF	\$529.32	\$588.13	\$646.24
21x18.7	6002118.7	CF	\$313.53	\$348.37	\$437.11
24x6	600246	CF	\$633.62	\$704.01	\$914.69
24x8	600248	CF	\$644.50	\$716.11	\$931.18
24x10	6002410	CF	\$653.85	\$726.50	\$945.01
24x12	6002412	CF	\$667.09	\$741.21	\$965.29
24x15	6002415	CF	\$684.22	\$760.24	\$989.89
24x18.7	6002418.7	CF	\$719.24	\$799.15	\$935.35
24x21	6002421	CF	\$461.52	\$512.81	\$615.36
27x6	600276	CF	\$814.60	\$905.12	\$1,177.33
27x8	600278	CF	\$824.01	\$915.57	\$1,191.90
27x10	6002710	CF	\$840.39	\$933.77	\$1,214.66
27x12	6002712	CF	\$862.31	\$958.13	\$1,246.35
27x15	6002715	CF	\$910.76	\$1,011.96	\$1,316.62
27x18.7	6002718.7	CF	\$961.59	\$1,068.43	\$1,390.69
27x21	6002721	CF	\$999.11	\$1,110.13	\$1,449.73
27x24	6002724	CF	\$691.91	\$768.78	\$958.99

SMALL END BELL (SEB)

MALE X FEMALE



Size	PartNumber	SDR81: 50 PSI (03)	SDR51: 80 PSI (05)	SDR41: 100 PSI (06)	SDR32.5: 125 PSI (07)
6x2	6206-2IPS	\$21.69	\$71.91	\$79.90	\$99.86
6x3	6206-3IPS	\$21.69	\$73.79	\$81.99	\$102.49
6x4	6206-4IPS	\$21.69	\$30.80	\$34.22	\$41.53
8x2	6208-2IPS	\$31.97	\$63.15	\$70.17	\$87.71
8x3	6208-3IPS	\$31.97	\$64.44	\$71.60	\$84.08
8x4	6208-4IPS	\$31.97	\$65.09	\$72.32	\$89.28
8x6	62086	\$31.97	\$46.92	\$52.14	\$61.24
10x2	62010-2IPS	\$50.32	\$89.51	\$99.46	\$107.95
10x3	62010-3IPS	\$50.32	\$91.33	\$101.49	\$113.11
10x4	62010-4IPS	\$50.32	\$92.26	\$102.51	\$118.32
10x6	620106	\$50.32	\$94.13	\$104.59	\$118.84
10x8	620108	\$50.32	\$64.39	\$71.54	\$77.85
12x2	62012-2IPS	\$73.23	\$128.74	\$143.05	\$152.54
12x3	62012-3IPS	\$73.23	\$131.36	\$145.96	\$165.01
12x4	62012-4IPS	\$73.23	\$132.70	\$147.44	\$179.56
12x6	620126	\$73.23	\$135.40	\$150.44	\$183.70
12x8	620128	\$73.23	\$136.77	\$151.96	\$189.59
12x10	6201210	\$73.23	\$92.92	\$103.25	\$125.56
15x3	62015-3IPS	\$111.05	\$191.78	\$213.09	\$219.86
15x4	62015-4IPS	\$111.05	\$195.69	\$217.44	\$224.16
15x6	620156	\$111.05	\$203.75	\$226.40	\$233.51
15x8	620158	\$111.05	\$207.91	\$231.01	\$256.34
15x10	6201510	\$111.05	\$212.15	\$235.73	\$316.10
15x12	6201512	\$111.05	\$149.93	\$166.59	\$223.15
18.7x3	62018.7-3IPS	CF	\$351.68	\$390.76	\$468.90
18.7x4	62018.7-4IPS	CF	\$332.51	\$369.46	\$443.35
18.7x6	62018.76	CF	\$349.46	\$388.28	\$465.94
18.7x8	62018.78	CF	\$341.89	\$379.87	\$455.84
18.7x10	62018.710	CF	\$422.86	\$469.85	\$563.82
18.7x12	62018.712	CF	\$346.46	\$384.96	\$461.95
18.7x15	62018.715	CF	\$273.20	\$303.55	\$364.27
21x3	62021-3IPS	CF	\$487.46	\$541.63	\$649.95
21x4	62021-4IPS	CF	\$497.84	\$553.16	\$663.79
21x6	620216	CF	\$514.67	\$571.86	\$686.22
21x8	620218	CF	\$527.73	\$586.38	\$703.65
21x10	6202110	CF	\$547.37	\$608.19	\$729.82
21x12	6202112	CF	\$591.27	\$656.97	\$788.35
21x15	6202115	CF	\$635.18	\$705.75	\$775.49
21x18.7	6202118.7	CF	\$376.24	\$348.37	\$524.53
24x3	62024-3IPS	CF	\$742.58	\$825.09	\$990.11
24x4	62024-4IPS	CF	\$750.07	\$833.42	\$1,000.10
24x6	620246	CF	\$760.34	\$844.82	\$1,013.78
24x8	620248	CF	\$773.39	\$859.33	\$1,031.20
24x10	6202410	CF	\$784.62	\$871.80	\$1,046.16
24x12	6202412	CF	\$800.51	\$889.45	\$1,067.35
24x15	6202415	CF	\$821.06	\$912.29	\$1,094.75
24x18.7	6202418.7	CF	\$863.08	\$1,358.56	\$1,616.32
24x21	6202421	CF	\$553.83	\$1,321.19	\$1,469.35
27x3	62027-3IPS	CF	\$948.79	\$1,054.21	\$1,265.05
27x4	62027-4IPS	CF	\$968.16	\$1,075.73	\$1,290.87
27x6	620276	CF	\$977.53	\$1,086.14	\$1,303.38
27x8	620278	CF	\$988.81	\$1,098.69	\$1,318.42
27x10	6202710	CF	\$1,008.48	\$1,120.53	\$1,344.63
27x12	6202712	CF	\$1,034.77	\$1,149.75	\$1,379.70
27x15	6202715	CF	\$1,092.92	\$1,214.35	\$1,457.23
27x18.7	6202718.7	CF	\$1,153.91	\$1,282.12	\$1,538.54
27x20.4	6202720.4	CF	\$1,176.42	\$1,307.15	\$1,568.57
27x21	6202721	CF	\$1,198.94	\$1,332.15	\$1,598.58
27x24	6202724	CF	\$1,222.10	\$1,836.27	\$1,630.94

PVC SOLVENT WELD PIP FITTINGS

REDUCER

CONCENTRIC

SURFACE STYLE

FEMALE X FEMALE

Size	PartNumber	SDR81: 50 PSI (03)	SDR51: 80 PSI (05)	SDR41: 100 PSI (06)	SDR32.5: 125 PSI (07)
6x2	6616-2IPS	\$16.26	\$53.92	\$59.92	\$74.90
6x3	6616-3IPS	\$16.26	\$55.35	\$61.50	\$76.87
6x4	6616-4IPS	\$16.26	\$23.10	\$25.67	\$31.15
8x2	6618-2IPS	\$23.98	\$47.36	\$52.63	\$65.79
8x3	6618-3IPS	\$23.98	\$48.33	\$53.70	\$63.06
8x4	6618-4IPS	\$23.98	\$48.82	\$54.24	\$66.97
8x6	66186	\$23.98	\$35.19	\$39.09	\$45.93
10x2	66110-2IPS	\$37.74	\$67.13	\$74.60	\$80.96
10x3	66110-3IPS	\$37.74	\$68.50	\$76.11	\$84.84
10x4	66110-4IPS	\$37.74	\$69.19	\$76.88	\$88.74
10x6	661106	\$37.74	\$70.60	\$78.44	\$89.13
10x8	661108	\$37.74	\$48.29	\$53.65	\$58.39
12x2	66112-2IPS	\$54.92	\$96.56	\$107.28	\$114.41
12x3	66112-3IPS	\$54.92	\$98.52	\$109.47	\$123.76
12x4	66112-4IPS	\$54.92	\$99.52	\$110.58	\$134.67
12x6	661126	\$54.92	\$101.55	\$112.83	\$137.78
12x8	661128	\$54.92	\$102.58	\$113.98	\$142.19
12x10	6611210	\$54.92	\$69.69	\$77.44	\$94.18
15x3	66115-3IPS	\$83.29	\$143.83	\$159.82	\$164.90
15x4	66115-4IPS	\$83.29	\$146.76	\$163.08	\$168.12
15x6	661156	\$83.29	\$152.82	\$169.80	\$175.13
15x8	661158	\$83.29	\$155.94	\$173.26	\$192.26
15x10	6611510	\$83.29	\$159.11	\$176.80	\$237.07
15x12	6611512	\$83.29	\$112.44	\$124.95	\$167.36
18.7x3	66118.7-3IPS	CF	\$263.76	\$293.07	\$351.68
18.7x4	66118.7-4IPS	CF	\$249.39	\$277.09	\$332.51
18.7x6	66118.76	CF	\$262.09	\$291.21	\$349.46
18.7x8	66118.78	CF	\$256.41	\$284.90	\$341.89
18.7x10	66118.710	CF	\$317.15	\$352.38	\$422.86
18.7x12	66118.712	CF	\$259.85	\$288.72	\$346.46
18.7x15	66118.715	CF	\$204.90	\$227.67	\$273.20
21x3	66121-3IPS	CF	\$365.60	\$406.22	\$487.46
21x4	66121-4IPS	CF	\$373.38	\$414.87	\$497.84
21x6	661216	CF	\$386.00	\$428.88	\$514.67
21x8	661218	CF	\$395.80	\$439.78	\$527.73
21x10	6612110	CF	\$410.53	\$456.14	\$547.37
21x12	6612112	CF	\$443.45	\$492.72	\$591.27
21x15	6612115	CF	\$476.39	\$529.32	\$581.61
21x18.7	6612118.7	CF	\$282.17	\$313.53	\$393.39
24x3	66124-3IPS	CF	\$556.94	\$618.82	\$742.58
24x4	66124-4IPS	CF	\$562.56	\$625.06	\$750.07
24x6	661246	CF	\$570.26	\$633.62	\$760.34
24x8	661248	CF	\$580.05	\$644.50	\$773.39
24x10	6612410	CF	\$588.46	\$653.85	\$784.62
24x12	6612412	CF	\$600.38	\$667.09	\$800.51
24x15	6612415	CF	\$615.80	\$684.22	\$821.06
24x18.7	6612418.7	CF	\$647.31	\$719.24	\$841.81
24x21	6612421	CF	\$415.37	\$461.52	\$553.83
27x3	66127-3IPS	CF	\$711.60	\$790.66	\$948.79
27x4	66127-4IPS	CF	\$726.12	\$806.80	\$968.15
27x6	661276	CF	\$733.14	\$814.60	\$977.53
27x8	661278	CF	\$741.61	\$824.01	\$988.82
27x10	6612710	CF	\$756.36	\$840.39	\$1,008.48
27x12	6612712	CF	\$776.08	\$862.31	\$1,034.77
27x15	6612715	CF	\$819.69	\$910.76	\$1,092.92
27x18.7	6612718.7	CF	\$865.43	\$961.59	\$1,153.90
27x24	6612724	CF	\$899.20	\$999.11	\$1,198.94

ECCENTRIC

FEMALE X FEMALE



Size	PartNumber	SDR81: 50 PSI (03)	SDR51: 80 PSI (05)	SDR41: 100 PSI (06)	SDR32.5: 125 PSI (07)
6x2	6106-2IPS	\$19.88	\$59.92	\$66.58	\$85.85
6x3	6106-3IPS	\$19.88	\$61.50	\$68.32	\$87.98
6x4	6106-4IPS	\$19.88	\$25.67	\$28.51	\$34.61
8x2	6108-2IPS	\$29.30	\$61.52	\$68.36	\$88.87
8x3	6108-3IPS	\$29.30	\$62.63	\$69.59	\$89.86
8x4	6108-4IPS	\$29.30	\$54.23	\$60.27	\$74.40
8x6	61086	\$29.30	\$39.11	\$43.45	\$51.03
10x2	61010-2IPS	\$46.12	\$79.77	\$88.40	\$116.03
10x3	61010-3IPS	\$46.12	\$83.93	\$93.26	\$121.69
10x4	61010-4IPS	\$46.12	\$88.94	\$98.82	\$128.15
10x6	610106	\$46.12	\$78.45	\$87.16	\$99.03
10x8	610108	\$46.12	\$51.49	\$59.61	\$64.88
12x2	61012-2IPS	\$73.22	\$113.26	\$125.85	\$164.53
12x3	61012-3IPS	\$73.22	\$12.68	\$136.64	\$178.85
12x4	61012-4IPS	\$73.22	\$133.22	\$148.02	\$188.90
12x6	610126	\$73.22	\$137.51	\$152.80	\$198.32
12x8	610128	\$73.22	\$113.97	\$126.63	\$157.99
12x10	6101210	\$73.22	\$77.44	\$86.04	\$104.64
15x3	61015-3IPS	\$101.80	\$159.81	\$177.57	\$233.21
15x4	61015-4IPS	\$101.80	\$163.07	\$181.20	\$242.41
15x6	610156	\$101.80	\$169.81	\$188.67	\$251.12
15x8	610158	\$101.80	\$191.58	\$212.87	\$276.91
15x10	6101510	\$101.80	\$176.80	\$196.44	\$263.41
15x12	6101512	\$101.80	\$124.95	\$138.82	\$185.95
18.7x3	61018.7-3IPS	CF	\$270.97	\$301.09	\$390.76
18.7x4	61018.7-4IPS	CF	\$277.10	\$307.88	\$399.09
18.7x6	61018.76	CF	\$278.71	\$309.67	\$403.14
18.7x8	61018.78	CF	\$284.90	\$316.55	\$409.81
18.7x10	61018.710	CF	\$352.38	\$391.54	\$508.11
18.7x12	61018.712	CF	\$288.72	\$320.81	\$400.23
18.7x15	61018.715	CF	\$227.66	\$252.96	\$307.77
21x3	61021-3IPS	CF	\$406.22	\$451.34	\$586.29
21x4	61021-4IPS	CF	\$414.87	\$460.97	\$598.17
21x6	610216	CF	\$428.88	\$476.54	\$618.97
21x8	610218	CF	\$439.79	\$488.64	\$635.33
21x10	6102110	CF	\$456.15	\$506.82	\$659.55
21x12	6102112	CF	\$492.72	\$547.47	\$711.20
21x15	6102115	CF	\$529.32	\$588.13	\$646.24
21x18.7	6102118.7	CF	\$313.53	\$567.88	\$437.11
24x3	61024-3IPS	CF	\$618.82	\$687.57	\$895.37
24x4	61024-4IPS	CF	\$625.06	\$694.51	\$903.64
24x6	610246	CF	\$633.62	\$704.02	\$914.69
24x8	610248	CF	\$644.50	\$716.11	\$931.18
24x10	6102410	CF	\$653.85	\$726.50	\$945.01
24x12	6102412	CF	\$667.09	\$741.22	\$965.29
24x15	6102415	CF	\$684.22	\$760.24	\$989.89
24x18.7	6102418.7	CF	\$719.24	\$799.15	\$935.35
24x21	6102421	CF	\$461.52	\$512.79	\$615.36
27x3	61027-3IPS	CF	\$790.66	\$878.52	\$1,132.87
27x4	61027-4IPS	CF	\$806.80	\$896.44	\$1,153.41
27x6	610276	CF	\$814.60	\$905.12	\$1,177.33
27x8	610278	CF	\$824.01	\$915.57	\$1,191.90
27x10	6102710	CF	\$840.39	\$933.77	\$1,214.66
27x12	6102712	CF	\$862.31	\$958.12	\$1,246.35
27x15	6102715	CF	\$910.76	\$1,011.96	\$1,316.62
27x18.7	6102718.7	CF	\$961.59	\$1,068.42	\$1,390.69
27x21	6102721	CF	\$999.11	\$1,110.12	\$1,449.73
27x24	6102724	CF	\$691.90	\$768.78	\$958.99

PVC SOLVENT WELD PIP FITTINGS

SMALL END BELL (SEB)

MALE X FEMALE



Size	PartNumber	SDR81: 50 PSI (03)	SDR51: 80 PSI (05)	SDR41: 100 PSI (06)	SDR32.5: 125 PSI (07)
6x2	6306-2IPS	\$23.85	\$79.09	\$87.88	\$109.85
6x3	6306-3IPS	\$23.85	\$81.18	\$90.20	\$112.74
6x4	6306-4IPS	\$23.85	\$33.88	\$37.65	\$45.68
8x2	6308-2IPS	\$35.17	\$69.47	\$77.19	\$96.49
8x3	6308-3IPS	\$35.17	\$70.88	\$78.76	\$92.49
8x4	6308-4IPS	\$35.17	\$71.60	\$79.56	\$98.21
8x6	63086	\$35.17	\$51.61	\$57.34	\$67.36
10x2	63010-2IPS	\$55.35	\$98.46	\$109.41	\$118.74
10x3	63010-3IPS	\$55.35	\$100.47	\$111.63	\$124.42
10x4	63010-4IPS	\$55.35	\$101.49	\$112.75	\$130.15
10x6	630106	\$55.35	\$103.55	\$115.05	\$130.71
10x8	630108	\$55.35	\$70.82	\$78.69	\$85.64
12x2	63012-2IPS	\$80.55	\$141.62	\$157.35	\$167.79
12x3	63012-3IPS	\$80.55	\$144.49	\$160.56	\$181.50
12x4	63012-4IPS	\$80.55	\$145.96	\$162.18	\$197.51
12x6	630126	\$80.55	\$148.94	\$165.49	\$202.07
12x8	630128	\$80.55	\$150.45	\$167.16	\$208.55
12x10	6301210	\$80.55	\$102.21	\$113.57	\$138.12
15x3	63015-3IPS	\$122.16	\$210.95	\$234.39	\$241.84
15x4	63015-4IPS	\$122.16	\$215.26	\$239.18	\$246.59
15x6	630156	\$122.16	\$224.14	\$249.03	\$256.86
15x8	630158	\$122.16	\$228.70	\$254.12	\$281.99
15x10	6301510	\$122.16	\$233.38	\$259.31	\$347.71
15x12	6301512	\$122.16	\$164.92	\$183.25	\$245.46
18.7x3	63018.7-3IPS	CF	\$386.85	\$429.83	\$515.79
18.7x4	63018.7-4IPS	CF	\$365.77	\$406.40	\$487.68
18.7x6	63018.76	CF	\$384.40	\$427.11	\$512.53
18.7x8	63018.78	CF	\$376.07	\$417.86	\$501.43
18.7x10	63018.710	CF	\$465.14	\$516.83	\$620.20
18.7x12	63018.712	CF	\$381.11	\$423.45	\$508.14
18.7x15	63018.715	CF	\$300.52	\$333.91	\$400.69
21x3	63021-3IPS	CF	\$536.20	\$595.78	\$714.94
21x4	63021-4IPS	CF	\$547.62	\$608.47	\$730.16
21x6	630216	CF	\$566.13	\$629.03	\$754.85
21x8	630218	CF	\$580.51	\$645.02	\$774.01
21x10	6302110	CF	\$602.11	\$669.01	\$802.81
21x12	6302112	CF	\$650.40	\$722.67	\$867.19
21x15	6302115	CF	\$698.70	\$776.34	\$853.04
21x18.7	6302118.7	CF	\$413.86	\$459.85	\$576.98
24x3	63024-3IPS	CF	\$816.84	\$907.60	\$1,089.13
24x4	63024-4IPS	CF	\$825.09	\$916.76	\$1,100.11
24x6	630246	CF	\$836.38	\$929.31	\$1,115.17
24x8	630248	CF	\$850.73	\$945.26	\$1,134.32
24x10	6302410	CF	\$863.08	\$958.98	\$1,150.77
24x12	6302412	CF	\$880.57	\$978.40	\$1,174.09
24x15	6302415	CF	\$903.17	\$1,003.52	\$1,204.23
24x18.7	6302418.7	CF	\$949.40	\$1,598.65	\$1,777.96
24x21	6302421	CF	\$1,307.98	\$1,453.32	\$1,616.29
27x3	63027-3IPS	CF	\$1,043.67	\$1,159.63	\$1,391.56
27x4	63027-4IPS	CF	\$1,064.97	\$1,183.30	\$1,419.96
27x6	630276	CF	\$1,075.28	\$1,194.76	\$1,433.70
27x8	630278	CF	\$1,087.69	\$1,208.55	\$1,450.27
27x10	6302710	CF	\$1,109.32	\$1,232.58	\$1,479.09
27x12	6302712	CF	\$1,138.25	\$1,264.72	\$1,517.67
27x15	6302715	CF	\$1,202.21	\$1,335.79	\$1,602.95
27x18.7	6302718.7	CF	\$1,269.30	\$1,410.33	\$1,692.39
27x21	6302721	CF	\$1,318.83	\$1,465.37	\$1,758.44
27x24	6302724	CF	\$1,817.90	\$2,019.89	\$2,522.55

SADDLE TEE

STUB STYLE

SLIP X FEMALE



Size	PartNumber	SDR81: 50 PSI (03)	SDR51: 80 PSI (05)	SDR41: 100 PSI (06)	SDR32.5: 125 PSI (07)
6x2	7016-2IPS	\$36.71	\$37.66	\$41.82	\$52.28
6x3	7016-3IPS	\$52.12	\$53.45	\$55.05	\$74.20
6x4	7016-4IPS	\$48.33	\$49.57	\$59.36	\$68.82
8x2	7018-2IPS	\$38.57	\$39.56	\$43.92	\$54.90
8x3	7018-3IPS	\$52.12	\$53.45	\$59.36	\$74.20
8x4	7018-4IPS	\$60.23	\$61.77	\$68.60	\$85.75
8x6	70186	\$74.45	\$76.36	\$84.80	\$106.01
10x2	70110-2IPS	\$47.37	\$48.59	\$53.96	\$67.44
10x3	70110-3IPS	\$52.12	\$53.45	\$59.36	\$74.20
10x4	70110-4IPS	\$60.23	\$61.77	\$68.60	\$85.75
10x6	701106	\$74.45	\$76.36	\$84.80	\$106.01
10x8	701108	\$97.47	\$99.97	\$111.02	\$138.78
12x2	70112-2IPS	\$47.37	\$48.59	\$53.96	\$67.44
12x3	70112-3IPS	\$52.12	\$53.45	\$59.36	\$74.20
12x4	70112-4IPS	\$60.23	\$61.77	\$68.60	\$85.75
12x6	701126	\$74.45	\$76.36	\$84.80	\$106.01
12x8	701128	\$97.47	\$99.97	\$111.02	\$138.78
12x10	7011210	\$105.59	\$108.29	\$120.26	\$150.33
15x3	70115-3IPS	\$75.80	\$77.75	\$86.34	\$107.92
15x4	70115-4IPS	\$79.19	\$81.23	\$90.21	\$112.76
15x6	701156	\$81.89	\$83.99	\$93.27	\$116.59
15x8	701158	\$97.47	\$99.97	\$111.02	\$138.78
15x10	7011510	\$112.37	\$115.24	\$127.99	\$159.98
15x12	7011512	\$148.24	\$152.03	\$168.85	\$211.06
18.7x3	70118.7-3IPS	\$114.40	\$117.33	\$130.30	\$162.88
18.7x4	70118.7-4IPS	\$138.09	\$141.63	\$157.28	\$196.60
18.7x6	70118.76	\$176.01	\$180.52	\$200.48	\$250.60
18.7x8	70118.78	\$188.17	\$193.00	\$214.34	\$267.93
18.7x10	70118.710	\$216.62	\$222.18	\$246.74	\$308.42
18.7x12	70118.712	\$249.80	\$256.21	\$284.53	\$355.67
18.7x15	70118.715	\$349.43	\$358.39	\$398.01	\$497.51
18.7x16	70118.716	\$384.36	\$394.22	\$437.81	\$547.26
21x3	70121-3IPS	\$338.48	\$347.17	\$385.54	\$481.92
21x4	70121-4IPS	\$344.56	\$353.40	\$392.47	\$490.58
21x6	701216	\$362.76	\$372.05	\$413.18	\$516.48
21x8	701218	\$419.39	\$430.14	\$477.69	\$597.13
21x10	7012110	\$451.77	\$463.35	\$514.58	\$643.22
21x12	7012112	\$455.82	\$467.50	\$519.19	\$648.99
21x15	7012115	\$523.24	\$536.65	\$595.98	\$744.97
21x18.7	7012118.7	\$596.73	\$612.03	\$679.69	\$849.62
24x3	70124-3IPS	\$448.40	\$459.89	\$510.73	\$638.41
24x4	70124-4IPS	\$482.11	\$494.47	\$549.14	\$686.43
24x6	701246	\$517.17	\$530.43	\$589.08	\$736.35
24x8	701248	\$550.90	\$565.02	\$627.49	\$784.36
24x10	7012410	\$596.74	\$612.04	\$679.70	\$849.63
24x12	7012412	\$642.59	\$659.07	\$731.94	\$914.92
24x15	7012415	\$700.58	\$718.54	\$797.99	\$997.49
24x18.7	7012418.7	\$752.67	\$771.97	\$857.32	\$1,071.64
24x21	7012421	\$848.93	\$870.69	\$966.95	\$1,208.68
27x3	70127-3IPS	\$561.67	\$576.07	\$639.76	\$799.70
27x4	70127-4IPS	\$602.79	\$618.25	\$686.60	\$858.25
27x6	701276	\$647.30	\$663.89	\$737.30	\$921.62
27x8	701278	\$688.45	\$706.10	\$784.15	\$980.19
27x10	7012710	\$746.44	\$765.58	\$850.21	\$1,062.78
27x12	7012712	\$803.07	\$823.67	\$914.73	\$1,143.41
27x15	7012715	\$876.56	\$899.04	\$998.44	\$1,248.04
27x18.7	7012718.7	\$987.82	\$1,013.15	\$1,043.17	\$1,406.45
27x21	7012721	\$1,061.99	\$1,089.23	\$1,209.64	\$1,512.06
27x24	7012724	\$1,105.83	\$1,134.19	\$1,259.57	\$1,574.47

PVC SOLVENT WELD PIP FITTINGS

SADDLE TEE

SURFACE STYLE

SLIP X FEMALE

Size	PartNumber	SDR81:	SDR51:	SDR41:	SDR32.5:
		50 PSI (03)	80 PSI (05)	100 PSI (06)	125 PSI (07)
6x2	6996-2IPS	-	\$28.22	\$31.37	\$39.20
6x3	6996-3IPS		\$40.06	\$44.52	\$55.65
6x4	6996-4IPS		\$37.15	\$41.29	\$51.61
8x2	6998-2IPS		\$29.65	\$32.94	\$41.18
8x3	6998-3IPS		\$40.06	\$44.52	\$55.65
8x4	6998-4IPS		\$46.31	\$51.45	\$64.31
8x6	69986		\$57.24	\$63.60	\$79.50
10x2	69910-2IPS		\$36.42	\$40.46	\$50.58
10x3	69910-3IPS		\$40.06	\$44.52	\$55.65
10x4	69910-4IPS		\$46.31	\$51.45	\$64.31
10x6	699106		\$57.24	\$63.60	\$79.50
10x8	699108		\$74.95	\$83.27	\$104.09
12x2	69912-2IPS		\$36.42	\$40.46	\$50.58
12x3	69912-3IPS		\$40.06	\$44.52	\$55.65
12x4	69912-4IPS		\$46.31	\$51.45	\$64.31
12x6	699126		\$57.24	\$63.60	\$79.50
12x8	699128		\$74.95	\$83.27	\$104.09
12x10	6991210		\$81.18	\$90.20	\$112.75
15X3	69915-3IPS		\$58.28	\$64.75	\$80.95
15x4	69915-4IPS		\$60.89	\$67.66	\$84.57
15X6	699156		\$62.96	\$69.95	\$87.45
15x8	699158		\$74.95	\$83.27	\$104.09
15x10	6991510		\$86.39	\$95.99	\$119.99
15x12	6991512		\$113.98	\$126.63	\$158.30
18.7x3	69918.7-3IPS		\$87.96	\$97.73	\$122.16
18.7x4	69918.7-4IPS		\$106.16	\$117.96	\$147.45
18.7x6	69918.76		\$135.32	\$150.36	\$187.95
18.7x8	69918.78		\$144.68	\$160.76	\$200.94
18.7x10	69918.710		\$166.54	\$185.05	\$231.32
18.7x12	69918.712		\$192.06	\$213.40	\$266.75
18.7x15	69918.715		\$268.66	\$298.50	\$373.13
21x3	69921-3IPS		\$260.25	\$289.15	\$361.44
21x4	69921-4IPS		\$264.91	\$294.35	\$367.94
21x6	699216		\$278.90	\$309.89	\$387.36
21x8	699218		\$322.45	\$358.27	\$447.84
21x10	6992110		\$347.34	\$385.93	\$482.42
21x12	6992112		\$350.45	\$389.39	\$486.73
21x15	6992115		\$402.28	\$446.99	\$558.72
21x18.7	6992118.7		\$458.79	\$509.77	\$637.21
24x3	69924-3IPS		\$370.67	\$411.86	\$514.82
24x4	69924-4IPS		\$384.16	\$426.83	\$533.54
24x6	699246		\$423.56	\$470.61	\$588.27
24x8	699248		\$458.81	\$509.78	\$637.22
24x10	6992410		\$494.05	\$548.96	\$686.20
24x12	6992412		\$516.34	\$573.72	\$717.15
24x15	6992415		\$558.67	\$620.74	\$775.92
24x18.7	6992418.7		\$652.69	\$725.21	\$906.51
24x21	6992421		\$652.69	\$725.21	\$906.51
27x3	69927-3IPS		\$431.84	\$479.82	\$599.77
27x4	69927-4IPS		\$463.46	\$514.96	\$643.69
27x6	699276		\$497.68	\$552.97	\$691.21
27x8	699278		\$529.30	\$588.12	\$735.15
27x10	6992710		\$573.90	\$637.66	\$797.07
27x12	6992712		\$617.44	\$686.05	\$857.56
27x15	6992715		\$673.95	\$748.83	\$936.03
27x18.7	6992718.7		\$759.48	\$843.86	\$1,054.84
27x21	6992721		\$816.51	\$907.24	\$1,134.04
27x24	6992724		\$850.21	\$944.68	\$1,180.84

SADDLE WYE

STUB STYLE

SLIP X FEMALE

Size	PartNumber	SDR81:	SDR51:	SDR41:	SDR32.5:
		50 PSI (03)	80 PSI (05)	100 PSI (06)	125 PSI (07)
6x2	7416-2IPS	\$47.04	\$47.04	\$52.28	\$65.35
6x3	7416-3IPS	\$66.78	\$66.78	\$74.20	\$92.75
6x4	7416-4IPS	\$53.76	\$53.76	\$68.82	\$86.02
8x2	7418-2IPS	\$49.41	\$49.41	\$54.90	\$68.64
8x3	7418-3IPS	\$66.78	\$66.78	\$74.20	\$92.75
8x4	7418-4IPS	\$64.51	\$64.51	\$85.75	\$107.19
8x6	74186	\$84.46	\$84.46	\$106.01	\$132.50
10x2	74110-2IPS	\$60.70	\$60.70	\$67.44	\$84.31
10x3	74110-3IPS	\$66.78	\$66.78	\$74.20	\$92.75
10x4	74110-4IPS	\$86.02	\$86.02	\$95.58	\$107.19
10x6	741106	\$98.31	\$98.31	\$106.01	\$132.50
10x8	741108	\$113.66	\$113.66	\$138.78	\$173.48
12x2	74112-2IPS	\$60.70	\$60.70	\$67.44	\$84.31
12x3	74112-3IPS	\$66.78	\$66.78	\$74.20	\$92.75
12x4	74112-4IPS	\$122.10	\$122.10	\$135.67	\$169.60
12x6	741126	\$142.84	\$142.84	\$158.72	\$198.39
12x8	741128	\$158.98	\$158.98	\$176.64	\$220.81
12x10	7411210	\$171.27	\$171.27	\$190.30	\$237.88
15x3	74115-3IPS	\$97.13	\$97.13	\$107.92	\$134.90
15x4	74115-4IPS	\$225.67	\$225.67	\$250.04	\$312.55
15x6	741156	\$237.31	\$237.31	\$263.68	\$329.60
15x8	741158	\$285.69	\$285.69	\$317.43	\$396.83
15x10	7411510	\$317.20	\$317.20	\$352.45	\$440.59
15x12	7411512	\$352.52	\$352.52	\$391.70	\$489.63
18.7x3	74118.7-3IPS	\$146.59	\$146.59	\$162.88	\$203.60
18.7x4	74118.7-4IPS	\$400.90	\$400.90	\$445.44	\$556.81
18.7x6	74118.76	\$436.24	\$436.24	\$484.70	\$605.88
18.7x8	74118.78	\$470.81	\$470.81	\$523.13	\$653.90
18.7x10	74118.710	\$510.73	\$510.73	\$567.48	\$709.37
18.7x12	74118.712	\$552.21	\$552.21	\$613.56	\$766.95
18.7x15	74118.715	\$558.36	\$558.36	\$620.40	\$775.54
21x3	74121-3IPS	\$422.94	\$422.94	\$469.93	\$587.41
21x4	74121-4IPS	\$433.73	\$433.73	\$481.92	\$602.41
21x6	741216	\$453.18	\$453.18	\$503.53	\$629.42
21x8	741218	\$464.84	\$464.84	\$516.48	\$645.60
21x10	7412110	\$537.41	\$537.41	\$597.13	\$746.40
21x12	7412112	\$578.90	\$578.90	\$643.22	\$804.03
21x15	7412115	\$627.28	\$627.28	\$696.98	\$871.22
21x18.7	7412118.7	\$764.66	\$764.66	\$849.62	\$1,062.03
24x3	74124-3IPS	\$574.58	\$574.58	\$638.41	\$798.02
24x4	74124-4IPS	\$617.79	\$617.79	\$686.43	\$858.03
24x6	741246	\$662.71	\$662.71	\$736.35	\$920.43
24x8	741248	\$705.92	\$705.92	\$784.36	\$980.45
24x10	7412410	\$764.67	\$764.67	\$849.63	\$1,062.04
24x12	7412412	\$823.42	\$823.42	\$914.92	\$1,143.66
24x15	7412415	\$897.73	\$897.73	\$997.49	\$1,246.86
24x18.7	7412418.7	\$964.48	\$964.48	\$1,071.64	\$1,339.55
24x21	7412421	\$1,087.81	\$1,087.81	\$1,208.68	\$1,510.85
27x3	74127-3IPS	\$719.72	\$719.72	\$799.70	\$999.63
27x4	74127-4IPS	\$772.43	\$772.43	\$858.25	\$1,072.82
27x6	741276	\$829.45	\$829.45	\$921.62	\$1,152.02
27x8	741278	\$882.18	\$882.18	\$980.19	\$1,225.24
27x10	7412710	\$956.50	\$956.50	\$1,062.78	\$1,328.47
27x12	7412712	\$1,029.07	\$1,029.07	\$1,143.41	\$1,429.27
27x15	7412715	\$1,123.24	\$1,123.24	\$1,248.04	\$1,560.05
27x18.7	7412718.7	\$1,265.80	\$1,265.80	\$1,406.45	\$1,758.06
27x21	7412721	\$1,360.85	\$1,360.85	\$1,512.06	\$1,890.07
27x24	7412724	\$1,417.02	\$1,417.02	\$1,574.47	\$1,968.08

PVC SOLVENT WELD PIP FITTINGS

TEE

FEMALE X FEMALE X FEMALE

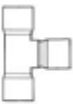

Size	PartNumber	SDR81: 50 PSI (03)	SDR51: 80 PSI (05)	SDR41: 100 PSI (06)	SDR32.5: 125 PSI (07)
6x2	8206-2IPS	\$36.00	\$43.45	\$50.25	\$57.09
6x3	8206-3IPS	\$36.72	\$46.83	\$53.67	\$61.39
6x4	8206-4IPS	\$37.10	\$48.54	\$56.21	\$63.99
6	8206	\$57.09	\$62.15	\$62.15	\$76.12
8x2	8208-2IPS	\$47.07	\$53.67	\$62.15	\$86.49
8x3	8208-3IPS	\$48.02	\$59.61	\$67.27	\$94.26
8x4	8208-4IPS	\$48.51	\$67.27	\$73.26	\$102.05
8x6	82086	\$57.09	\$80.02	\$90.27	\$126.27
8	8208	\$68.50	\$109.88	\$109.88	\$152.23
10x2	82010-2IPS	\$62.80	\$78.34	\$86.04	\$120.22
10x3	82010-3IPS	\$70.38	\$86.04	\$109.88	\$153.08
10x4	82010-4IPS	\$71.36	\$99.64	\$112.40	\$157.39
10x6	820106	\$80.88	\$109.88	\$115.00	\$172.97
10x8	820108	\$89.43	\$126.90	\$153.31	\$214.47
10	82010	\$116.08	\$167.70	\$176.32	\$227.47
12x2	82012-2IPS	\$89.50	\$103.89	\$124.33	\$188.49
12x3	82012-3IPS	\$91.32	\$122.65	\$149.04	\$208.44
12x4	82012-4IPS	\$97.03	\$138.83	\$165.24	\$230.05
12x6	820126	\$109.39	\$146.48	\$179.71	\$251.68
12x8	820128	\$125.59	\$172.91	\$212.08	\$296.64
12x10	8201210	\$134.16	\$199.32	\$244.45	\$341.64
12	82012	\$161.74	\$219.77	\$281.06	\$396.99
15x3	82015-3IPS	\$117.96	\$201.89	\$235.95	\$299.01
15x4	82015-4IPS	\$126.52	\$207.84	\$246.16	\$309.20
15x6	820156	\$147.46	\$225.69	\$270.87	\$350.08
15x8	820158	\$159.83	\$260.62	\$303.24	\$402.91
15x10	8201510	\$175.04	\$295.56	\$358.62	\$455.10
15x12	8201512	\$192.19	\$338.15	\$402.91	\$535.09
15	82015	\$250.21	\$411.41	\$483.71	\$628.66
18.7x3	82018.7-3IPS	CF	\$333.42	\$373.05	\$496.60
18.7x4	82018.7-4IPS	CF	\$379.89	\$410.56	\$528.97
18.7x6	82018.76	CF	\$390.96	\$892.10	\$541.76
18.7x8	82018.78	CF	\$407.16	\$442.93	\$604.79
18.7x10	82018.710	CF	\$430.14	\$476.15	\$661.03
18.7x12	82018.712	CF	\$476.15	\$565.62	\$742.75
18.7x15	82018.715	CF	\$551.98	\$683.99	\$864.58
18.7	82018.7	CF	\$637.17	\$742.75	\$1,057.98
21x3	82021-3IPS	CF	\$500.88	\$610.74	\$701.91
21x4	82021-4IPS	CF	\$511.09	\$617.58	\$732.58
21x6	820216	CF	\$541.76	\$748.74	\$839.91
21x8	820218	CF	\$578.37	\$770.89	\$874.81
21x10	8202110	CF	\$616.73	\$799.85	\$915.69
21x12	8202112	CF	\$675.49	\$807.50	\$1,138.89
21x15	8202115	CF	\$744.51	\$925.92	\$1,301.60
21x18.7	8202118.7	CF	\$868.84	\$1,057.98	\$1,484.74
21	82021	CF	\$1,175.53	\$1,383.37	\$1,576.72
24x3	82024-3IPS	CF	\$685.40	\$793.90	\$854.36
24x4	82024-4IPS	CF	\$718.03	\$854.36	\$915.69
24x6	820246	CF	\$754.72	\$915.69	\$976.21
24x8	820248	CF	\$804.12	\$976.21	\$1,057.98
24x10	8202410	CF	\$827.94	\$1,057.98	\$1,138.89
24x12	8202412	CF	\$895.30	\$1,138.89	\$1,220.67
24x15	8202415	CF	\$982.98	\$1,241.14	\$1,342.49
24x18.7	8202418.7	CF	\$1,119.30	\$1,403.82	\$1,525.65
24x21	8202421	CF	\$1,258.98	\$1,504.32	\$1,810.14
24	82024	CF	\$1,604.85	\$1,851.05	\$1,920.90
27x3	82027-3IPS	CF	\$858.23	\$1,077.53	\$1,345.82
27x4	82027-4IPS	CF	\$866.90	\$1,088.41	\$1,359.42
27x6	820276	CF	\$914.68	\$1,171.78	\$1,464.52
27x8	820278	CF	\$973.74	\$1,254.31	\$1,568.77
27x10	8202710	CF	\$1,003.29	\$1,341.18	\$1,677.37
27x12	8202712	CF	\$1,084.07	\$1,448.88	\$1,811.12
27x15	8202715	CF	\$1,190.06	\$1,594.83	\$1,994.41
27x18.7	8202718.7	CF	\$1,355.96	\$1,808.52	\$2,260.64
27x21	8202721	CF	\$1,525.35	\$1,924.05	\$2,404.05
27x24	8202724	CF	\$1,944.89	\$2,375.76	\$2,969.01
27	82027	CF	\$2,431.32	\$2,850.89	\$3,564.04

TEE

MALE X FEMALE X FEMALE

Size	PartNumber	SDR81: 50 PSI (03)	SDR51: 80 PSI (05)	SDR41: 100 PSI (06)	SDR32.5: 125 PSI (07)
6x2	8306-2IPS	\$35.63	\$43.01	\$49.74	\$56.51
6x3	8306-3IPS	\$36.36	\$46.36	\$53.14	\$60.77
6x4	8306-4IPS	\$36.72	\$48.06	\$55.64	\$63.35
6x6	83066	\$56.51	\$61.53	\$61.53	\$75.36
8x2	8308-2IPS	\$46.60	\$53.14	\$61.53	\$85.63
8x3	8308-3IPS	\$47.54	\$59.02	\$66.60	\$93.32
8x4	8308-4IPS	\$48.02	\$66.60	\$72.52	\$101.02
8x6	83086	\$56.51	\$79.23	\$89.38	\$125.00
8x8	83088	\$67.81	\$108.77	\$108.77	\$150.71
10x2	83010-2IPS	\$62.17	\$77.56	\$85.18	\$119.01
10x3	83010-3IPS	\$69.68	\$85.18	\$108.77	\$151.55
10x4	83010-4IPS	\$70.65	\$98.65	\$111.28	\$155.83
10x6	830106	\$80.06	\$108.77	\$113.86	\$171.25
10x8	830108	\$88.54	\$125.63	\$151.78	\$212.33
10x10	8301010	\$114.92	\$167.70	\$174.57	\$225.19
12x2	83012-2IPS	\$88.61	\$102.84	\$123.08	\$186.61
12x3	83012-3IPS	\$90.42	\$121.43	\$147.55	\$206.34
12x4	83012-4IPS	\$96.06	\$137.44	\$163.60	\$227.75
12x6	830126	\$108.30	\$145.01	\$177.91	\$249.17
12x8	830128	\$124.33	\$171.17	\$209.96	\$293.67
12x10	8301210	\$132.83	\$197.34	\$242.00	\$338.22
12x12	8301212	\$160.12	\$217.58	\$278.25	\$393.02
15x3	83015-3IPS	\$116.78	\$199.85	\$233.59	\$296.02
15x4	83015-4IPS	\$125.26	\$205.74	\$243.70	\$306.11
15x6	830156	\$145.99	\$223.40	\$268.16	\$346.58
15x8	830158	\$158.22	\$257.99	\$300.21	\$398.87
15x10	8301510	\$173.30	\$292.56	\$355.04	\$450.55
15x12	8301512	\$190.27	\$334.72	\$398.87	\$529.73
15x15	8301515	\$208.15	\$407.23	\$478.94	\$622.28
18.7x3	83018.7-3IPS	CF	\$339.79	\$369.27	\$491.56
18.7x4	83018.7-4IPS	CF	\$376.04	\$406.39	\$523.61
18.7x6	83018.76	CF	\$387.01	\$420.75	\$536.27
18.7x8	83018.78	CF	\$403.04	\$438.45	\$631.77
18.7x10	83018.710	CF	\$425.96	\$471.32	\$654.36
18.7x12	83018.712	CF	\$471.32	\$559.88	\$733.67
18.7x15	83018.715	CF	\$546.39	\$677.07	\$855.84
21x3	83021-3IPS	CF	\$495.86	\$604.63	\$694.89
21x4	83021-4IPS	CF	\$505.98	\$611.40	\$725.25
21x6	830216	CF	\$536.33	\$741.25	\$831.51
21x8	830218	CF	\$572.58	\$763.18	\$866.07
21x10	8302110	CF	\$610.55	\$791.86	\$906.53
21x12	8302112	CF	\$668.73	\$799.43	\$1,127.50
21x15	8302115	CF	\$736.96	\$916.54	\$1,288.40
21x18	8302118	CF	\$860.04	\$1,047.25	\$1,469.69
21x21	8302121	CF	\$1,163.63	\$1,369.40	\$1,560.75
24x3	83024-3IPS	CF	\$671.15	\$785.86	\$845.72
24x4	83024-4IPS	CF	\$709.14	\$845.72	\$906.42
24x6	830246	CF	\$747.08	\$906.42	\$966.32
24x8	830248	CF	\$795.97	\$966.32	\$1,047.25
24x10	8302410	CF	\$819.54	\$1,047.25	\$1,127.35
24x12	8302412	CF	\$875.34	\$1,127.35	\$1,208.30
24x15	8302415	CF	\$973.01	\$1,228.38	\$1,328.89
24x18	8302418	CF	\$1,107.97	\$1,389.59	\$1,510.19
24x21	8302421	CF	\$1,246.21	\$1,489.07	\$1,791.81
24x24	8302424	CF	\$1,588.60	\$1,832.30	\$1,901.43
27x3	83027-3IPS	CF	\$849.54	\$1,066.60	\$1,332.18
27x4	83027-4IPS	CF	\$858.12	\$1,077.39	\$1,345.65
27x6	830276	CF	\$905.42	\$1,159.92	\$1,449.68
27x8	830278	CF	\$963.88	\$1,241.60	\$1,552.88
27x10	8302710	CF	\$993.12	\$1,361.42	\$1,660.38
27x12	8302712	CF	\$1,073.10	\$1,434.20	\$1,792.78
27x15	8302715	CF	\$1,178.00	\$1,578.67	\$1,974.20
27x18	8302718	CF	\$1,342.24	\$1,790.21	\$2,237.34
27x21	8302721	CF	\$1,509.77	\$1,904.56	\$2,380.07
27x24	8302724	CF	\$1,925.19	\$2,351.69	\$2,938.92
27x27	8302727	CF	\$2,406.69	\$2,822.01	\$3,527.93

PVC SOLVENT WELD PIP FITTINGS

TEE

PIP x PIP x IPS

FEMALE X FEMALE X FIPT

Size	PartNumber	SDR81: 50 PSI (03)	SDR51: 80 PSI (05)	SDR41: 100 PSI (06)	SDR32.5: 125 PSI (07)
6x2	8406-2IPS	-	\$44.96	\$46.83	\$59.78
6x3	8406-3IPS		\$54.77	\$57.05	\$73.32
6x4	8406-4IPS		\$61.33	\$63.89	\$82.64
8x2	8408-2IPS		\$76.03	\$79.19	\$101.00
8x3	8408-3IPS		\$80.11	\$83.45	\$107.74
8x4	8408-4IPS		\$86.67	\$90.27	\$116.42
10x2	84010-2IPS		\$103.86	\$108.19	\$139.43
10x3	84010-3IPS		\$127.53	\$132.83	\$171.99
10x4	84010-4IPS		\$136.54	\$142.23	\$183.18
12x2	84012-2IPS		\$158.64	\$165.24	\$213.84
12x3	84012-3IPS		\$175.77	\$183.09	\$236.52
12x4	84012-4IPS		\$201.16	\$209.54	\$271.09
15x3	84015-3IPS		\$282.75	\$294.53	\$380.75
15x4	84015-4IPS		\$298.25	\$310.67	\$403.35
18.7x3	84018.7-3IPS		\$483.68	\$537.41	\$579.97
18.7x4	84018.7-4IPS		\$491.35	\$545.94	\$595.85
21x3	84021-3IPS		\$734.51	\$816.13	\$913.55
21x4	84021-4IPS		\$752.59	\$836.21	\$948.52
24x3	84024-3IPS		\$1,024.98	\$1,047.04	\$1,308.80
24x4	84024-4IPS		\$1,038.86	\$1,059.83	\$1,324.80
27x3	84027-3IPS		\$1,289.80	\$1,285.38	\$1,606.73
27x4	84027-4IPS		\$1,325.87	\$1,301.20	\$1,626.51

REINFORCED

FEMALE X FEMALE X FIPT

Size	PartNumber	SDR81: 50 PSI (03)	SDR51: 80 PSI (05)	SDR41: 100 PSI (06)	SDR32.5: 125 PSI (07)
6x2	8406-2IPSR	-	\$68.38	\$69.77	\$80.93
6x3	8406-3IPSR		\$83.30	\$85.00	\$98.61
6x4	8406-4IPSR		\$93.28	\$95.18	\$110.42
8x2	8408-2IPSR		\$115.69	\$118.04	\$136.93
8x3	8408-3IPSR		\$121.87	\$124.35	\$144.25
8x4	8408-4IPSR		\$131.85	\$134.54	\$156.06
10x2	84010-2IPSR		\$157.99	\$161.22	\$187.02
10x3	84010-3IPSR		\$194.02	\$197.99	\$229.66
10x4	84010-4IPSR		\$207.73	\$211.97	\$245.89
12x2	84012-2IPSR		\$236.48	\$241.30	\$279.91
12x3	84012-3IPSR		\$254.37	\$259.55	\$301.08
15x2	84015-2IPSR		\$397.72	\$405.84	\$469.62
15x3	84015-3IPSR		\$423.07	\$431.71	\$495.03
15x4	84015-4IPSR		\$453.70	\$462.96	\$507.65

REINFORCED

MALE X FEMALE X FIPT

Size	PartNumber	SDR81: 50 PSI (03)	SDR51: 80 PSI (05)	SDR41: 100 PSI (06)	SDR32.5: 125 PSI (07)
6x2	8506-2IPSR	-	\$63.45	\$64.74	\$75.10
6x3	8506-3IPSR		\$74.63	\$76.15	\$88.34
6x4	8506-4IPSR		\$87.08	\$88.85	\$103.06
8x2	8508-2IPSR		\$101.99	\$104.06	\$120.72
8x3	8508-3IPSR		\$111.94	\$114.22	\$132.50
8x4	8508-4IPSR		\$121.87	\$124.35	\$144.25
10x2	85010-2IPSR		\$151.68	\$154.77	\$179.53
10x3	85010-3IPSR		\$185.35	\$189.13	\$219.40
10x4	85010-4IPSR		\$196.52	\$200.53	\$232.62
12x2	85012-2IPSR		\$226.37	\$230.98	\$267.94
12x3	85012-3IPSR		\$258.71	\$263.99	\$306.23
12x4	85012-4IPSR		\$295.79	\$301.83	\$350.12
15x3	85015-3IPSR		\$419.19	\$427.75	\$488.69
15x4	85015-4IPSR		\$446.53	\$455.65	\$501.35

PIP x PIP x IPS

MALE X FEMALE X FIPT

Size	PartNumber	SDR81: 50 PSI (03)	SDR51: 80 PSI (05)	SDR41: 100 PSI (06)	SDR32.5: 125 PSI (07)
6x2	8506-2IPS	\$37.65	\$38.16	\$42.93	\$56.12
6x3	8506-3IPS	\$39.48	\$46.01	\$51.11	\$65.58
6x4	8506-4IPS	\$40.96	\$53.65	\$59.61	\$76.56
8x2	8508-2IPS	\$48.72	\$67.05	\$69.84	\$90.03
8x3	8508-3IPS	\$50.78	\$68.96	\$76.63	\$98.68
8x4	8508-4IPS	\$52.37	\$80.11	\$83.45	\$107.73
10x2	85010-2IPS	\$64.45	\$106.98	\$103.89	\$132.83
10x3	85010-3IPS	\$73.14	\$133.24	\$126.90	\$163.42
10x4	85010-4IPS	\$75.21	\$138.09	\$134.58	\$173.89
12x2	85012-2IPS	\$91.15	\$159.47	\$154.99	\$200.21
12x3	85012-3IPS	\$94.08	\$191.13	\$177.18	\$228.72
12x4	85012-4IPS	\$100.90	\$195.03	\$201.89	\$261.14
15x3	85015-3IPS	\$120.71	\$275.56	\$287.04	\$371.91
15x4	85015-4IPS	\$130.39	\$293.54	\$305.78	\$396.19
18.7x3	85018.7-3IPS	CF	\$465.45	\$479.85	\$551.82
18.7x4	85018.7-4IPS	CF	\$468.98	\$483.49	\$556.01
21x3	85021-3IPS	CF	\$703.57	\$725.32	\$834.13
21x4	85021-4IPS	CF	\$709.55	\$731.49	\$841.21
24x3	85024-3IPS	CF	\$1,011.04	\$1,042.30	\$1,198.65
24x4	85024-4IPS	CF	\$1,041.00	\$1,073.20	\$1,234.18
27x3	85027-3IPS	CF	\$1,264.63	\$1,303.75	\$1,499.31
27x4	85027-4IPS	CF	\$1,295.24	\$1,335.29	\$1,535.58
30x3	85030-3IPS	CF	\$3,722.51	\$3,837.64	\$4,413.29
30x4	85030-4IPS	CF	\$3,908.64	\$4,029.52	\$4,633.95

VENT CHAMBER

HUBxHUBxHUB

Size	PartNumber	SDR81: 50 PSI (03)	SDR51: 80 PSI (05)	SDR41: 100 PSI (06)	SDR32.5: 125 PSI (07)
6x4x2	8706-42IPS	\$168.05	\$170.79	\$126.29	\$165.10
6x6x2	8706-62IPS	\$171.48	\$172.51	\$128.87	\$166.78
8x6x3	8708-63IPS	\$174.98	\$176.30	\$168.34	\$231.60
8x8x3	8708-83IPS	\$178.55	\$179.62	\$171.77	\$223.33
10x8x3	87010-83IPS	\$220.97	\$183.28	\$192.93	\$241.16
10x10x3	87010-103IPS	\$225.48	\$219.36	\$230.92	\$248.61
12x10x4	87012-104IPS	\$264.49	\$258.79	\$272.41	\$411.03
12x12x4	87012-124IPS	\$303.51	\$309.76	\$326.06	\$423.73
15x12x4	87015-124IPS	\$354.87	\$461.74	\$569.03	\$797.03
15x15x4	87015-154IPS	\$375.80	\$497.13	\$632.26	\$821.68
18x15x4	87018-154IPS	\$413.38	\$635.08	\$668.51	\$835.64
18x18x4	87018-184IPS	\$454.72	\$654.73	\$689.19	\$861.47

WYE

FEMALE X FEMALE X FEMALE



§ Available in Larger Sizes.

§ Available with Dissimilar Outlets.

Size	PartNumber	SDR81: 50 PSI (03)	SDR51: 80 PSI (05)	SDR41: 100 PSI (06)	SDR32.5: 125 PSI (07)
6x2	9206-2IPS	\$47.87	\$49.20	\$66.83	\$75.93
6x3	9206-3IPS	\$48.84	\$50.20	\$71.39	\$81.65
6x4	9206-4IPS	\$49.34	\$50.70	\$74.75	\$85.10
6	9206	\$47.68	\$56.11	\$82.67	\$101.23
8x2	9208-2IPS	\$62.60	\$71.39	\$82.67	\$115.03
8x3	9208-3IPS	\$63.87	\$79.29	\$89.48	\$125.37
8x4	9208-4IPS	\$64.52	\$89.12	\$97.43	\$135.73
8x6	92086	\$75.93	\$96.06	\$120.07	\$167.93
8	9208	\$91.11	\$126.02	\$146.14	\$202.47
10x2	92010-2IPS	\$83.51	\$103.65	\$114.43	\$159.88
10x3	92010-3IPS	\$93.61	\$105.75	\$146.14	\$203.60
10x4	92010-4IPS	\$94.90	\$106.82	\$149.49	\$209.34
10x6	920106	\$107.56	\$120.65	\$152.95	\$230.06
10x8	920108	\$118.96	\$141.38	\$203.92	\$285.25
10	92010	\$154.39	\$183.67	\$234.51	\$302.53
12x2	92012-2IPS	\$119.04	\$146.14	\$165.36	\$250.70
12x3	92012-3IPS	\$121.46	\$149.11	\$198.23	\$277.21
12x4	92012-4IPS	\$129.05	\$150.60	\$219.78	\$305.97
12x6	920126	\$145.50	\$181.27	\$239.01	\$334.73
12x8	920128	\$167.03	\$202.54	\$282.06	\$394.53
12x10	9201210	\$178.44	\$218.31	\$325.12	\$454.37
12	92012	\$215.11	\$297.12	\$373.81	\$528.00
15x3	92015-3IPS	\$169.63	\$268.51	\$365.80	\$397.68
15x4	92015-4IPS	\$173.09	\$284.52	\$369.49	\$411.23
15x6	920156	\$196.12	\$301.08	\$389.76	\$465.61
15x8	920158	\$212.57	\$363.89	\$471.20	\$535.86
15x10	9201510	\$232.81	\$402.73	\$522.23	\$605.28
15x12	9201512	\$255.61	\$445.31	\$578.05	\$711.66
15	92015	\$332.79	\$625.79	\$813.31	\$836.10
18.7x3	92018.7-3IPS	CF	\$443.45	\$653.85	\$660.47
18.7x4	92018.7-4IPS	CF	\$508.36	\$660.45	\$703.53
18.7x6	92018.76	CF	\$550.91	\$716.00	\$720.53
18.7x8	92018.78	CF	\$595.84	\$589.10	\$804.37
18.7x10	92018.710	CF	\$647.84	\$633.28	\$879.17
18.7x12	92018.712	CF	\$701.44	\$752.27	\$987.86
18.7x15	92018.715	CF	\$815.74	\$909.71	\$1,149.90
21x3	92021-3IPS	CF	\$666.16	\$812.29	\$933.54

FEMALE X FEMALE X FEMALE

Size	PartNumber	SDR81: 50 PSI (03)	SDR51: 80 PSI (05)	SDR41: 100 PSI (06)	SDR32.5: 125 PSI (07)
21x4	92021-4IPS	CF	\$679.75	\$821.37	\$974.32
21x6	920216	CF	\$720.53	\$995.83	\$1,117.08
21x8	920218	CF	\$769.23	\$1,025.28	\$1,163.50
21x10	9202110	CF	\$820.24	\$1,063.80	\$1,217.88
21x12	9202112	CF	\$898.39	\$1,073.99	\$1,514.72
21x15	9202115	CF	\$990.19	\$1,231.48	\$1,731.12
21x18.7	9202118.7	CF	\$1,155.55	\$1,407.11	\$1,974.69
21	92021	CF	\$1,563.46	\$1,839.89	\$2,097.04
24x3	92024-3IPS	CF	\$911.59	\$1,055.89	\$1,136.30
24x4	92024-4IPS	CF	\$821.68	\$1,136.30	\$1,217.88
24x6	920246	CF	\$981.80	\$1,190.70	\$1,298.36
24x8	920248	CF	\$1,044.71	\$1,254.38	\$1,407.11
24x10	9202410	CF	\$1,077.59	\$1,375.26	\$1,514.72
24x12	9202412	CF	\$1,164.61	\$1,481.79	\$1,623.49
24x15	9202415	CF	\$1,277.59	\$1,614.03	\$1,785.52
24x18.7	9202418.7	CF	\$1,456.55	\$1,826.28	\$2,029.12
24x21	9202421	CF	\$1,638.51	\$1,958.06	\$2,407.49
24	92024	CF	\$2,088.86	\$2,507.01	\$2,554.80
27x3	92027-3IPS	CF	\$1,141.45	\$1,433.11	\$1,789.94
27x4	92027-4IPS	CF	\$1,152.97	\$1,447.58	\$1,808.02
27x6	920276	CF	\$1,216.53	\$1,558.47	\$1,947.81
27x8	920278	CF	\$1,295.07	\$1,668.24	\$2,086.47
27x10	9202710	CF	\$1,334.37	\$1,783.77	\$2,230.90
27x12	9202712	CF	\$1,441.82	\$1,927.00	\$2,408.80
27x15	9202715	CF	\$1,582.78	\$2,121.12	\$2,652.57
27x18.7	9202718.7	CF	\$1,803.44	\$2,405.34	\$3,014.48
27x21	9202721	CF	\$2,028.72	\$2,558.99	\$3,197.38
27x24	9202724	CF	\$2,586.70	\$3,159.74	\$3,948.78
27	92027	CF	\$3,233.65	\$3,791.68	\$4,740.18



Yes, Specified Fittings is your source for a variety of valve products: PVC end flap gates, backwater valves, sheer gates, PVC butterfly and HDPE backwater valves are just a sample of styles and types we fabricate. We also stock gate, ball, butterfly, diaphragm, check, and needle valves that are manufactured by other companies. These valves are available in 1/4" through 48" diameter in a variety of trim and end configurations. Valves for IPS, PIP, Sewer, C-900, C-905, and all profile pipes *as well as* HDPE solid wall are all produced at Specified Fittings. Speaking of valves, Specified Fittings also makes adapter flanges in glue bell, spigot end, and gasket bell to adapt to any type of pipe from a flanged end valve. With these adapter flanges, it is no longer a problem to place a flanged valve into a line at any point. Flanges of this type are available in 1/2" through 60" diameter, in a Van Stone style for easy installation. Because the majority of our valves are made completely from plastic material, the non-corrosive benefits of our valves are evident. Our uniquely designed PVC sheer gate is a great example. These sheer gates are commonly used in flow control devices because of the potential corrosion associated with these installations. Our PVC construction is a perfect example of the superiority of the PVC product. So for your specialty valving needs, all you need to remember is: Specified Fittings!

PVC SOLVENT WELD PIP FITTINGS

For Our Farmers...



Aptly named, the Z-Drop Pipe is a great replacement for the standard steel pipe that is commonly used to tie in a pivot from an underground mainline. Certain soil conditions are very corrosive to steel, and thus their lifespan is significantly shortened. A UV resistant HDPE Z-Drop is a perfect fit for these types of installations. ■

Below: A Z-Drop in the works. ▼



PVC FITTINGS

PIP: LOWHEAD SDR93.5



Specified Fittings



Specified Fittings

ADAPTER

FEMALE X MALE

Size	PartNumber	SDR93.5: 43 PSI (02)
6	__1716	\$45.17
8	__1718	\$91.99
10	__17110	\$103.92
12	__17112	\$150.81
15	__17115	\$242.87
18.3	__17118.3	\$404.67
20.4	__17120.4	\$507.08

OD

FEMALE X FEMALE

LINEGATE

Size	PartNumber	SDR93.5: 43 PSI (02)
6	__1396	\$44.97
8	__1398	\$51.48
10	__13910	\$64.64
12	__13912	\$56.40
15	__13915	\$57.55
18.3	__13918.3	\$58.13
20.4	__13920.4	\$60.87

PIP X CONCRETE

FEMALE X MALE

Size	PartNumber	SDR93.5: 43 PSI (02)
6	__1156	\$22.45
8	__1158	\$32.89
10	__11510	\$50.70
12	__11512	\$71.29
12x16	__1151216	\$93.45
15	__11515	\$107.93
15x16	__1151516	\$109.82
18.3 x18	__11518.318	\$127.64
20.4 x 20	__11520.420	\$146.70

PIP x VALVE

FEMALE X FEMALE

Size	PartNumber	SDR93.5: 43 PSI (02)
6	__1386	\$22.45
8	__1388	\$28.10
10	__13810	\$46.94
12	__13812	\$70.41
15	__13815	\$107.07
18.3	__13818.3	\$135.51
20.4	__13820.4	\$143.59

PIP X IPS

FEMALE X FEMALE



Size	PartNumber	SDR93.5: 43 PSI (02)
6x4	__1056-4IPS	\$21.16
6	__1056-IPS	\$23.47
8x6	__1058-6IPS	\$30.56
8	__1058-IPS	\$34.77
10x8	__10510-8IPS	\$47.30
10	__10510-IPS	\$54.46
12x10	__10512-10IPS	\$70.41
12	__10512-IPS	\$76.93
15x12	__10515-12IPS	\$112.58

CAP

FEMALE



Size	PartNumber	SDR93.5: 43 PSI (02)
6	__1906	\$9.40
8	__1908	\$15.93
10	__19010	\$25.35
12	__19012	\$39.40
15	__19015	\$55.33
18.3	__19018.3	\$101.42
20.4	__19020.4	\$136.18

PLUG

MALE



Size	PartNumber	SDR93.5: 43 PSI (02)
6	__5606	\$22.09
8	__5608	\$39.20
10	__56010	\$52.34
12	__56012	\$77.33
15	__56015	\$126.52
18.3	__56018.3	\$169.91
20.4	__56020.4	\$161.82



As storm water management gains greater importance throughout the nation, Specified is here to help with some of the problems that arise. We manufacture non-corrosive, built to specification flow control structures, with or without PVC/HDPE shear gates, for manholes and catch basins. These structures, built from HDPE or PVC are the finest replacements for metal equivalents, which are subject to decay or corrosion. Flow control structures may be combined with any of our thousands of other products for achieving a complete solution and a freight prepaid order.

COUPLING

REPAIR

FEMALE X FEMALE

	SDR93.5: 43 PSI	
Size	PartNumber	(02)
6	__2206	\$97.46
8	__2208	\$114.23
10	__22010	\$110.19
12	__22012	\$117.96
15	__22015	\$126.52
18.3	__22018.3	\$130.28
20.4	__22020.4	\$145.18

STOP

FEMALE X FEMALE

	SDR93.5: 43 PSI	
Size	PartNumber	(02)
6	__2406	\$15.06
8	__2408	\$16.96
10	__24010	\$23.47
12	__24012	\$31.87
15	__24015	\$56.36
18.3	__24018.3	\$100.40
20.4	__24020.4	\$123.88

REDUCER

FLUSH

IPS X PIP

	SDR93.5: 43 PSI	
Size	PartNumber	(02)
4	__6054	\$19.02
6	__6056	\$27.60
8	__6058	\$30.44
10	__60510	\$43.70
12	__60512	\$66.70

A WORD ABOUT OUR HOURS

We try to have hours that work for our East Coast customers:
Stevensville opens at 7:30 AM (9:30 AM ET) and closes at 5PM (7PM ET).

Bellingham opens at 6AM (9AM ET) and closes at 5PM (8PM ET).

The importance of these hours other than early access to our sales force is the late night shipping possibilities. If you need something shipped for next day delivery, and you are in an Eastern Time Zone, you could order up to 7:30 your time, and still expect it the next day. In the emergency, "I don't care what the freight costs. My customer needs it here tomorrow" scenarios we will ship from stock up until 4PM or later from Stevensville or Bellingham. Because we have no minimum purchase requirement, whether you need a \$.50 PVC nipple or a \$500.00 stainless steel back up ring we will ship in-stock orders if you need it.

CROSS

FEMALE X FEMALE X FEMALE X FEMALE

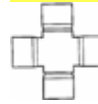

	SDR93.5: 43 PSI	
Size	PartNumber	(02)
6x4	__2606-4IPS	\$51.57
6	__2606	\$59.11
8x4	__2608-4IPS	\$70.41
8x6	__26086	\$74.18
8	__2608	\$80.69
10x4	__26010-4IPS	\$70.41
10x6	__260106	\$78.81
10x8	__260108	\$90.11
10	__26010	\$109.82
12x4	__26012-4IPS	\$91.99
12x6	__260126	\$99.53
12x8	__260128	\$107.93
12x10	__2601210	\$130.54
12	__26012	\$152.99
15x4	__26015-4IPS	\$139.81
15x6	__260156	\$148.35
15x8	__260158	\$159.64
15x10	__2601510	\$188.78
15x12	__2601512	\$227.18
15	__26015	\$291.93
18.3x4	__26018.3-4IPS	\$258.18
18.3x6	__26018.36	\$264.70
18.3x8	__26018.38	\$272.23
18.3x10	__26018.310	\$309.76
18.3x12	__26018.312	\$328.55
18.3x15	__26018.315	\$375.54
18.3	__26018.3	\$468.41
20.4x4	__260120.4-4IPS	\$361.48
20.4x6	__260120.46	\$369.89
20.4x8	__260120.48	\$379.30
20.4x10	__260120.410	\$406.54
20.4x12	__260120.412	\$437.54
20.4x15	__260120.415	\$458.12
20.4x18.3	__260120.418.3	\$537.95
20.4	__26020.4	\$616.77

ELBOW

11-1/4 DEGREE

FEMALE X FEMALE



Size	PartNumber	SDR93.5: 43 PSI (02)
6	__3106	\$17.82
8	__3108	\$25.35
10	__31010	\$35.54
12	__31012	\$50.70
15	__31015	\$87.36
18.3	__31018.3	\$152.99
20.4	__31020.4	\$198.05

15 DEGREE

FEMALE X FEMALE

Size	PartNumber	SDR93.5: 43 PSI (02)
6	__3206	\$17.82
8	__3208	\$25.35
10	__32010	\$35.54
12	__32012	\$50.70
15	__32015	\$87.36
18.3	__32018.3	\$152.99
20.4	__32020.4	\$198.05

22-1/2 DEGREE

FEMALE X FEMALE



Size	PartNumber	SDR93.5: 43 PSI (02)
6	__3306	\$17.82
8	__3308	\$25.35
10	__33010	\$35.54
12	__33012	\$50.70
15	__33015	\$87.36
18.3	__33018.3	\$152.99
20.4	__33020.4	\$198.05

30 DEGREE

FEMALE X FEMALE

Size	PartNumber	SDR93.5: 43 PSI (02)
6	__3406	\$29.99
8	__3408	\$44.03
10	__34010	\$54.46
12	__34012	\$89.24
15	__34015	\$143.57
18.3	__34018.3	\$254.40
20.4	__34020.4	\$282.50

45 DEGREE

FEMALE X FEMALE



Size	PartNumber	SDR93.5: 43 PSI (02)
6	__3506 / __3496 (Gsk)	\$29.99
8	__3508 / __3498 (Gsk)	\$44.03
10	__35010 / __34910 (Gsk)	\$54.46
12	__35012 / __34912 (Gsk)	\$89.24
15	__35015	\$143.57
18.3	__35018.3	\$254.40
20.4	__35020.4	\$282.50

60 DEGREE

FEMALE X FEMALE

Size	PartNumber	SDR93.5: 43 PSI (02)
6	__3606	\$56.36
8	__3608	\$69.39
10	__36010	\$110.89
12	__36012	\$145.46
15	__36015	\$237.46
18.3	__36018.3	\$411.18
20.4	__36020.4	\$553.88

90 DEGREE

FEMALE X FEMALE



Size	PartNumber	SDR93.5: 43 PSI (02)
6	__3696	\$56.36
8	__3698	\$69.39
10	__36910	\$110.89
12	__36912	\$145.46
15	__36915	\$237.46
18.3	__37018.3	\$411.18
20.4	__37020.4	\$553.88

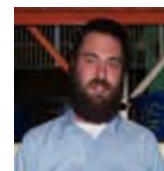
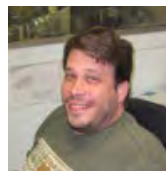

Many times when considering a special product or determining whether a certain fittings can fit a particular

dimensional configuration, it is helpful to have a drawing prior to purchase. Our CAD operators, Brad Sukolsky (bsukolsky@specfit.com) and Derek Eirish (deirish@specfit.com), can provide you with such a service. If you need a drawing please call, fax, or email Brad, and he or Derek will respond promptly. Also, if you are designing a product and need technical data such as flow characteristics, impact information, dimensional sizing, or any other professional help, Brad Sukolsky and our friendly staff are here to assist you.

FLANGE

IPS X PIP

FLANGE X FEMALE



Size	PartNumber	SDR93.5: 43 PSI (02)
6	__5306	\$128.69
8	__5308	\$188.89
10	__53010	\$279.31
12	__53012	\$419.23
16x15	__5301615	\$1,013.16
18x18.3	__5301818.3	\$1,571.88
20x20.4	__5302020.4	\$2,411.07

FLANGE X MALE



Size	PartNumber	SDR93.5: 43 PSI (02)
6x6	__52066	\$97.67
8x8	__52088	\$147.83
10x10	__5201010	\$207.87
12x12	__5201212	\$317.21
16x16	__5201616	\$859.38
18x18.3	__5201818.3	\$1,390.76
20x20.4	__5202020.4	\$2,118.44

DISTRIBUTING GATE

Size	PartNumber	SDR93.5: 43 PSI (02)
2	__2762IPS	\$10.29
3	__2763IPS	\$14.03
4	__2764IPS	\$20.72

DISTRIBUTING GATE RISER

POT X RISER X SADDLE

(Gates not included)

Size	PartNumber	SDR93.5: 43 PSI (02)
8x4xpipe size	__2758-4-pipe size	\$195.94
10x4xpipe size	__27510-4-pipe size	\$240.77
10x6xpipe size	__27510-6 pipe size	\$312.03
12x6xpipe size	__27512-6-pipe size	\$59.07
12x8xpipe size	__27512-8-pipe size	\$63.08
15x10xpipe size	__27515-10-pipe size	\$78.66
18.3x12xpipe size	__27518.3-12-pipe size	\$93.70



Clear PVC Inspection Chamber for sanitary and storm servicing lines.

MECHANICAL VENT RISER

Size	PartNumber	SDR93.5: 43 PSI (02)
6x4x2	__5466-4-2IPS	\$60.12
8x6x2	__546-8-6-2 IPS	\$64.76
10x8x2	__54610-8-2IPS	\$78.81
10x8x3	__54610-8-3IPS	\$93.88
10x8x4	__54612-8-4IPS	\$110.83
12x10x2	__54612-10-2IPS	\$101.42
12x10x3	__54612-10-3IPS	\$115.46
12x10x4	__54612-10-4IPS	\$131.40
15x12x4	__54615-12-4IPS	\$170.82
18.3x15x4	__54618.3-15-4IPS	\$220.65
20.4x18.3x4	__54620.4-18.3-4IPS	\$373.65

ORCHARD RISER

SADDLE X RISER

Size	PartNumber	SDR93.5: 43 PSI (02)
6x4	__6986-4 IPS	\$26.65
6x6	__6986	\$47.24
8x4	__6988-4IPS	\$26.69
8x6	__69886	\$35.63
8x8	__6988	\$65.76
10x4	__69810-4 IPS	\$28.10
10x6	__698106	\$35.63
10x8	__698108	\$48.81
10x10	__69810	\$93.88
12x4	__69812-4 IPS	\$29.12
12x6	__698126	\$35.63
12x8	__698128	\$48.81
12x10	__6981210	\$67.65
12x12	__69812	\$131.40
15x4	__69815-4 IPS	\$31.05
15x6	__698156	\$40.12
15x8	__698158	\$55.33
15x10	__6981510	\$76.93
15x12	__6981512	\$106.06
15x15	__69815	\$219.63
18x4	__69818-4 IPS	\$33.76
18x6	__698186	\$41.39
18x8	__698188	\$58.25
18x10	__6981810	\$77.94
18x12	__6981812	\$120.10
18x15	__6981815	\$173.71
18x18	__69818	\$329.47
20x4	__69820-4 IPS	\$35.63
20x6	__698206	\$46.94
20x8	__698208	\$70.41
20x10	__6982010	\$109.82
20x12	__6982012	\$133.28
20x15	__6982015	\$196.31
20x18	__6982018	\$241.23
20x20	__69820	\$312.45

SADDLE TEE

STUB STYLE

SLIP X FEMALE



Size	PartNumber	SDR93.5: 43 PSI (02)
6x2	_7016-2IPS	\$18.70
6x3	_7016-3IPS	\$22.45
6x4	_7016-4IPS	\$26.22
8x2	_7018-2IPS	\$18.70
8x3	_7018-3IPS	\$22.45
8x4	_7018-4IPS	\$26.22
8x6	_70186	\$30.99
10x2	_70110-2IPS	\$18.70
10x3	_70110-3IPS	\$22.45
10x4	_70110-4IPS	\$26.22
10x6	_701106	\$30.99
10x8	_701108	\$58.38
12x2	_70112-2IPS	\$19.69
12x3	_70112-3IPS	\$24.34
12x4	_70112-4IPS	\$26.22
12x6	_701126	\$30.99
12x8	_701128	\$41.39
12x10	_7011210	\$54.46
15x2	_70115-2IPS	\$21.59
15x3	_70115-3IPS	\$24.34
15x4	_70115-4IPS	\$26.22
15x6	_701156	\$32.89
15x8	_701158	\$44.03
15x10	_7011510	\$57.22
15x12	_7011512	\$81.72
18.3x2	_70118.3-2IPS	\$21.59
18.3x3	_70118.3-3IPS	\$24.34
18.3x4	_70118.3-4IPS	\$27.67
18.3x6	_70118.36	\$32.89
18.3x8	_70118.38	\$46.94
18.3x10	_70118.310	\$58.25
18.3x12	_70118.312	\$94.89
18.3x15	_70118.315	\$127.64
20.4x2	_70120.4-2IPS	\$24.34
20.4x3	_70120.4-3IPS	\$26.22
20.4x4	_70120.4-4IPS	\$28.10
20.4x6	_70120.46	\$37.52
20.4x8	_70120.48	\$76.41
20.4x10	_70120.410	\$90.11
20.4x12	_70120.412	\$107.93
20.4x15	_70120.415	\$151.12
20.4x18.3	_70120.418.3	\$184.00

SURFACE STYLE

SLIP X FEMALE

Size	PartNumber	SDR93.5: 43 PSI (02)
6x2	_6996-2IPS	\$15.06
6x3	_6996-3IPS	\$15.93
6x4	_6996-4IPS	\$17.82
8x2	_6998-2IPS	\$15.06
8x3	_6998-3IPS	\$15.93
8x4	_6998-4IPS	\$17.82
8x6	_69986	\$22.45
10x2	_69910-2IPS	\$15.06
10x3	_69910-3IPS	\$15.93
10x4	_69910-4IPS	\$17.82
10x6	_699106	\$22.45
10x8	_699108	\$26.22
12x2	_69912-2IPS	\$15.06
12x3	_69912-3IPS	\$15.93
12x4	_69912-4IPS	\$17.82
12x6	_699126	\$22.45
12x8	_699128	\$26.22
12x10	_6991210	\$31.87
15x2	_69915-2IPS	\$15.06
15x3	_69915-3IPS	\$15.93
15x4	_69915-4IPS	\$17.82
15x6	_699156	\$22.45
15x8	_699158	\$26.22
15x10	_6991510	\$36.65
15x12	_6991512	\$48.81
18.3x2	_69918.3-2IPS	\$15.06
18.3x3	_69918.3-3IPS	\$15.93
18.3x4	_69918.3-4IPS	\$17.82
18.3x6	_69918.36	\$22.45
18.3x8	_69918.38	\$29.12
18.3x10	_69918.310	\$37.52
18.3x12	_69918.312	\$62.88
18.3x15	_69918.315	\$81.72
20.4x2	_69920.4-2IPS	\$15.93
20.4x3	_69920.4-3IPS	\$16.96
20.4x4	_69920.4-4IPS	\$17.82
20.4x6	_69920.46	\$25.35
20.4x8	_69920.48	\$51.69
20.4x10	_69920.410	\$69.36
20.4x12	_69920.412	\$76.06
20.4x15	_69920.415	\$104.16
20.4x18.3	_69920.418.3	\$115.46

PVC LOWHEAD PIP FITTINGS

SADDLE WYE**STUB STYLE****SLIP X FEMALE**

SDR93.5: 43 PSI		
Size	PartNumber	(02)
6x2	__7416-2IPS	\$47.04
6x3	__7416-3IPS	\$66.78
6x4	__7416-4IPS	\$53.76
8x2	__7418-2IPS	\$49.41
8x3	__7418-3IPS	\$66.78
8x4	__7418-4IPS	\$64.51
8x6	__74186	\$84.46
10x2	__74110-2IPS	\$60.70
10x3	__74110-3IPS	\$66.78
10x4	__74110-4IPS	\$86.02
10x6	__741106	\$98.31
10x8	__741108	\$113.67
12x2	__74112-2IPS	\$60.70
12x3	__74112-3IPS	\$66.78
12x4	__74112-4IPS	\$122.10
12x6	__741126	\$142.84
12x8	__741128	\$158.98
12x10	__7411210	\$171.27
15x2	__74115-2IPS	\$87.62
15x3	__74115-3IPS	\$97.13
15x4	__74115-4IPS	\$225.67
15x6	__741156	\$237.31
15x8	__741158	\$285.69
15x10	__7411510	\$317.20
15x12	__7411512	\$352.52
18.3x2	__74118.3-2IPS	\$143.12
18.3x3	__74118.3-3IPS	\$146.59
18.3x4	__74118.3-4IPS	\$400.90
18.3x6	__74118.36	\$436.24
18.3x8	__74118.38	\$470.81
18.3x10	__74118.310	\$510.73
18.3x12	__74118.312	\$552.21
18.3x15	__74118.315	\$558.36
18.7x2	__74118.7-2IPS	\$143.12
18.7x3	__74118.7-3IPS	\$146.59
18.7x4	__74118.7-4IPS	\$400.90
18.7x6	__74118.76	\$436.24
18.7x8	__74118.78	\$470.81
18.7x10	__74118.710	\$510.73
18.7x12	__74118.712	\$552.21
18.7x15	__74118.715	\$558.36
18.7x18.3	__74118.718.3	CF
20.4x2	__74120.4-2IPS	\$403.90
20.4x3	__74120.4-3IPS	\$422.94
20.4x4	__74120.4-4IPS	\$433.73
20.4x6	__74120.46	\$453.18
20.4x8	__74120.48	\$464.84
20.4x10	__74120.410	\$537.41
20.4x12	__74120.412	\$578.90
20.4x15	__74120.415	\$627.28
20.4x18.3	__74120.418.3	\$717.56
20.4x18.7	__74120.418.7	\$764.66

TEE**FEMALE X FEMALE X FEMALE**

SDR93.5: 43 PSI		
Size	PartNumber	(02)
6x4	__8206-4IPS	\$31.87
6	__8206	\$35.64
8x3	__8208-3IPS	\$45.06
8x4	__8208-4IPS	\$51.57
8x6	__82086	\$64.76
10x4	__82010-4IPS	\$58.25
10x6	__820106	\$60.99
10x8	__820108	\$70.41
10	__82010	\$82.59
12x4	__82012-4IPS	\$78.81
12x6	__820126	\$82.59
12x8	__820128	\$89.24
12x10	__8201210	\$97.65
12	__82012	\$114.45
15x4	__82015-4IPS	\$126.77
15x6	__820156	\$131.18
15x8	__820158	\$145.46
15x10	__8201510	\$162.41
15x12	__8201512	\$189.64
15	__82015	\$227.18
18.3x4	__82018.3-4IPS	\$233.70
18.3x6	__82018.36	\$238.48
18.3x8	__82018.38	\$242.23
18.3x10	__82018.310	\$264.70
18.3x12	__82018.312	\$291.88
18.3x15	__82018.315	\$319.17
18.3	__82018.3	\$395.24
20.4x4	__82020.4-4IPS	\$298.60
20.4x6	__82020.46	\$307.87
20.4x8	__82020.48	\$314.54
20.4x10	__82020.410	\$348.29
20.4x12	__82020.412	\$369.89
20.4x15	__82020.415	\$397.12
20.4x18.3	__82020.418.3	\$446.82
20.4x18.7	__82020.418.7	\$464.58
20.4	__82020.4	\$489.11

STRAPS**STAINLESS STEEL**

Size	PartNumber	(81)
4	__7554	\$8.88
8	__7558	\$10.42
10	__75510	\$10.87
12	__75512	\$13.14
15	__75515	\$16.75
18	__75518	\$17.21

TEE

MALE X FEMALE X FEMALE

Size	PartNumber	SDR93.5: 43 PSI (02)
6x2	__8306-2IPS	\$30.56
6x3	__8306-3IPS	\$31.18
6x4	__8306-4IPS	\$31.49
6x6	__83066	\$35.21
8x2	__8308-2IPS	\$43.20
8x3	__8308-3IPS	\$44.08
8x4	__8308-4IPS	\$44.52
8x6	__83086	\$50.97
8x8	__83088	\$64.00
10x2	__83010-2IPS	\$55.84
10x3	__83010-3IPS	\$56.98
10x4	__83010-4IPS	\$57.55
10x6	__830106	\$60.26
10x8	__830108	\$69.57
10x10	__8301010	\$81.61
12x2	__83012-2IPS	\$75.55
12x3	__83012-3IPS	\$77.09
12x4	__83012-4IPS	\$77.87
12x6	__830126	\$81.61
12x8	__830128	\$88.18
12x10	__8301210	\$96.49
12x12	__8301212	\$113.09
15x2	__83015-2IPS	\$121.54
15x3	__83015-3IPS	\$124.01
15x4	__83015-4IPS	\$125.26
15x6	__830156	\$128.98
15x8	__830158	\$143.73
15x10	__8301510	\$160.48
15x12	__8301512	\$187.39
15x15	__8301515	\$226.64
18.3x2	__83018.3-2IPS	\$224.04
18.3x3	__83018.3-3IPS	\$228.58
18.3x4	__83018.3-4IPS	\$230.89
18.3x6	__83018.36	\$235.63
18.3x8	__83018.38	\$239.32
18.3x10	__83018.310	\$261.52
18.3x12	__83018.312	\$288.43
18.3x15	__83018.315	\$315.34
18.3	__83018.3	\$394.49
20.4x2	__83020.4-2IPS	\$286.29
20.4x3	__83020.4-3IPS	\$292.11
20.4x4	__83020.4-4IPS	\$295.05
20.4x6	__83020.46	\$304.21
20.4x8	__83020.48	\$310.81
20.4x10	__83020.410	\$344.16
20.4x12	__83020.412	\$365.49
20.4x15	__83020.415	\$392.41
20.4x18.3	__83020.418.3	\$441.52
20.4x18.7	__83020.418.7	\$462.41
20.4	__83020.4	\$483.30

WYE

FEMALE X FEMALE X FEMALE



Size	PartNumber	SDR93.5: 43 PSI (02)
6x2	__9206-2IPS	\$41.05
6x3	__9206-3IPS	\$41.88
6x4	__9206-4IPS	\$42.30
6	__9206	\$47.31
8x2	__9208-2IPS	\$58.04
8x3	__9208-3IPS	\$59.22
8x4	__9208-4IPS	\$59.81
8x6	__92086	\$68.47
8	__9208	\$85.97
10x2	__92010-2IPS	\$75.03
10x3	__92010-3IPS	\$76.55
10x4	__92010-4IPS	\$77.32
10x6	__920106	\$80.96
10x8	__920108	\$93.47
10	__92010	\$109.63
12x2	__92012-2IPS	\$101.51
12x3	__92012-3IPS	\$103.57
12x4	__92012-4IPS	\$104.62
12x6	__920126	\$109.63
12x8	__920128	\$118.46
12x10	__9201210	\$129.62
12	__92012	\$151.94
15x2	__92015-2IPS	\$163.28
15x3	__92015-3IPS	\$166.60
15x4	__92015-4IPS	\$168.27
15x6	__920156	\$173.28
15x8	__920158	\$193.09
15x10	__9201510	\$215.60
15x12	__9201512	\$251.74
15	__92015	\$301.58
18.3x2	__92018.3-2IPS	\$306.53
18.3x3	__92018.3-3IPS	\$307.12
18.3x4	__92018.3-4IPS	\$310.23
18.3x6	__92018.36	\$316.57
18.3x8	__92018.38	\$321.56
18.3x10	__92018.310	\$351.39
18.3x12	__92018.312	\$387.53
18.3x15	__92018.315	\$423.69
18.3	__92018.3	\$524.67
20.4x2	__92020.4-2IPS	\$384.61
20.4x3	__92020.4-3IPS	\$392.42
20.4x4	__92020.4-4IPS	\$396.38
20.4x6	__92020.46	\$408.70
20.4x8	__92020.48	\$417.55
20.4x10	__92020.410	\$462.34
20.4x12	__92020.412	\$491.01
20.4x15	__92020.415	\$527.17
20.4x18.3	__92020.418.3	\$593.16
20.4x18.7	__92020.418.7	\$621.23
20.4	__92020.4	\$649.30

High Density Polyethylene

Characteristics:

- Durable plastic
- Weather resistant
- Joints fused together for pressure resistance
- Absorbs shock waves
- More abrasion resistant
- 250% thicker than PVC counterpart
- Petroleum based
- Flexibility

Applications:

- Potable Water
- Force Main Sewer
- Mining Applications
- Industrial Applications
- Lower pressure installations
- Above ground Ag Applications



PVC or HDPE? What Should You Use?

The two most popular types of plastic pipe tend to invoke a sense of rivalry in the pipe industry. But is one really **better** than the other? Each was designed with specific applications in mind, so let our diagram help to determine what is right for **your** project! ■

Disclaimer: Always ask an engineer to approve your application of any pipe or fittings.

Polyvinyl Chloride

Characteristics:

- Durable plastic
- More affordable
- Many types of joints including solvent weld and gasketed
- Easy to install
- Thin wall , lightweight strength to weight ratio
- Flexibility
- Non-corrosive
- Flame resistant

Applications:

- DWV
- Sewers and Drains
- Water Service
- Hot & Cold Water Distribution
- Ag/Turf



PVC FITTINGS

SURFACE



Specified **F**ittings



**Specified
Fittings**

ADAPTER

SURFACE X IPS

Female x Female



Size	PartNumber	SDR 102/22 PSI	
		Solvent Weld Bell (01)	Gasketed Bell (11)
6	1056-IPS	\$15.53	CF
8	1058-IPS	\$19.49	CF
10	10510-IPS	\$26.48	CF
12	10512-IPS	\$32.80	CF

SURFACE X PIP

Female x Female



Size	PartNumber	SDR 102/22 PSI	
		Solvent Weld Bell (01)	Gasketed Bell (11)
6	1056-PIP	\$15.53	CF
8	1058-PIP	\$19.49	CF
10	10510-PIP	\$26.48	CF
12	10512-PIP	\$32.80	CF

SURFACE X SURFACE

Female x Male



Size	PartNumber	SDR 102/22 PSI	
		Solvent Weld Bell (01)	Gasketed Bell (11)
6	1716	\$30.13	CF
8	1718	\$37.40	CF
10	1710	\$45.96	CF
12	1712	\$87.75	CF

SURFACE X IPS

Gasket x Slip Bell

Size	PartNumber	SDR 102/22 PSI	
		Solvent Weld Bell (01)	Gasketed Bell (11)
6	1356-IPS	NA	\$45.96
8	1358-IPS	NA	\$66.25
10	13510-IPS	NA	\$68.62
12	13512-IPS	NA	\$88.12

SURFACE X PIP

Gasket x Slip Bell

Size	PartNumber	SDR 102/22 PSI	
		Solvent Weld Bell (01)	Gasketed Bell (11)
6	1356-PIP	NA	\$45.96
8	1358-PIP	NA	\$66.25
10	13510-PIP	NA	\$68.62
12	13512-PIP	NA	\$88.12

ADAPTER

SURFACE X SURFACE

Gasket x Slip Bell

Size	PartNumber	SDR 102/22 PSI	
		Solvent Weld Bell (01)	Gasketed Bell (11)
6	1356	NA	\$45.96
8	1358	NA	\$66.25
10	13510	NA	\$68.62
12	13512	NA	\$88.12

SURFACE X SURFACE (Starter Coupling)

Female x Male

OAL



Size	PartNumber	SDR 102/22 PSI	
		Solvent Weld Bell (01)	Gasketed Bell (11)
6x36	171636	CF	\$51.49
8x36	171836	CF	\$65.46
10x36	1711036	CF	\$82.71
12x36	1711236	CF	\$100.63
6x48	171648	CF	\$60.06
8x48	171848	CF	\$77.97
10x48	1711048	CF	\$97.47
12x48	1711248	CF	\$118.55
6x60	171660	CF	\$69.41
8x60	171860	CF	\$89.70
10x60	1711060	CF	\$113.14
12x60	1711260	CF	\$137.24

CAP

FEMALE



Size	PartNumber	SDR 102/22 PSI	
		Solvent Weld Bell (01)	Gasketed Bell (11)
6	1906	\$17.12	\$48.33
8	1908	\$23.44	\$63.23
10	19010	\$30.43	\$82.71
12	19012	\$43.73	\$110.77

COUPLING

Female x Female



Size	PartNumber	SDR 102/22 PSI	
		Solvent Weld Bell (01)	Gasketed Bell (11)
6	2406	\$15.53	\$45.96
8	2408	\$19.49	\$66.25
10	24010	\$26.48	\$68.62
12	24012	\$32.80	\$88.12

PVC SURFACE FITTINGS

ELBOW

22-1/2 Degree

Female x Female



Size	PartNumber	SDR 102/22 PSI	
		Solvent Weld Bell (01)	Gasketed Bell (11)
6	3306	\$30.97	\$113.81
8	3308	\$44.04	\$135.66
10	33010	\$54.47	\$171.62
12	33012	\$89.24	\$220.76

30 Degree

Female x Female



Size	PartNumber	SDR 102/22 PSI	
		Solvent Weld Bell (01)	Gasketed Bell (11)
6	3406	\$30.97	\$113.81
8	3408	\$44.04	\$135.66
10	34010	\$54.47	\$171.62
12	34012	\$89.24	\$220.76

45 Degree

Female x Female



Size	PartNumber	SDR 102/22 PSI	
		Solvent Weld Bell (01)	Gasketed Bell (11)
6	3506	\$30.97	\$113.81
8	3508	\$44.04	\$135.66
10	35010	\$54.47	\$171.62
12	35012	\$89.24	\$220.76

90 Degree

Female x Female



Size	PartNumber	SDR 102/22 PSI	
		Solvent Weld Bell (01)	Gasketed Bell (11)
6	3706	\$56.36	\$126.32
8	3708	\$69.40	\$160.69
10	37010	\$110.84	\$217.60
12	37012	\$145.47	\$279.24

22 1/2 DEGREE

FEMALE X MALE

Size	PartNumber	SDR 102/22 PSI	
		Solvent Weld Bell (01)	Gasketed Bell (11)
6	4206	CF	\$99.84
8	4208	CF	\$119.34
10	42010	CF	\$151.35
12	42012	CF	\$194.15

30 Degree

Female x Male



Size	PartNumber	SDR 102/22 PSI	
		Solvent Weld Bell (01)	Gasketed Bell (11)
6	4306	CF	\$99.84
8	4308	CF	\$119.71
10	43010	CF	\$151.35
12	43012	CF	\$194.15

45 Degree

Female x Male



Size	PartNumber	SDR 102/22 PSI	
		Solvent Weld Bell (01)	Gasketed Bell (11)
6	4406	CF	\$99.84
8	4408	CF	\$119.71
10	44010	CF	\$151.35
12	44012	CF	\$194.15

90 Degree

Female x Male



Size	PartNumber	SDR 102/22 PSI	
		Solvent Weld Bell (01)	Gasketed Bell (11)
6	4606	CF	\$110.77
8	4608	CF	\$141.20
10	46010	CF	\$191.91
12	46012	CF	\$245.65

GASKET

SURFACE

Size	PartNumber	SDR 102/22 PSI	
		Solvent Weld Bell (01)	Gasketed Bell (11)
6	5316	NA	\$9.63
8	5318	NA	\$14.51
10	53110	NA	\$16.61
12	53112	NA	\$25.69

PLUG

MALE



Size	PartNumber	SDR 102/22 PSI	
		Solvent Weld Bell (01)	Gasketed Bell (11)
6	5606	CF	\$36.61
8	5608	CF	\$45.17
10	56010	CF	\$56.11
12	56012	CF	\$71.78

REDUCER

SMALL END BELL (SEB)

MALE X FEMALE



Size	PartNumber	SDR 102/22 PSI	
		Solvent Weld Bell (01)	Gasketed Bell (11)
8x6	62086	CF	\$78.76
10x8	620108	CF	\$95.89
12x10	6201210	CF	\$116.18

LARGE END BELL (LEB)

FEMALE X MALE



Size	PartNumber	SDR 102/22 PSI	
		Solvent Weld Bell (01)	Gasketed Bell (11)
8x6	64086	CF	\$78.76
10x8	640108	CF	\$95.89
12x10	6401210	CF	\$116.18

TEE

(Line Tee)

Male x Gasket x Gasket

Size	PartNumber	SDR 102/22 PSI	
		Solvent Weld Bell (01)	Gasketed Bell (11)
6	8306	NA	\$142.78
8	8308	NA	\$179.40
10	83010	NA	\$222.99
12	83012	NA	\$300.32

(Field Tee)

Gasket x Gasket x Male

Size	PartNumber	SDR 102/22 PSI	
		Solvent Weld Bell (01)	Gasketed Bell (11)
6	8356	NA	\$142.78
8	8358	NA	\$179.40
10	83510	NA	\$222.99
12	83512	NA	\$300.32



PVC and Epoxy Aluminum Valves are also available. Call us for a quote today!

**Farming is a
profession
of hope.**



PVC FITTINGS

HEAT & AIR



Specified Fittings



Specified Fittings

Specified Fittings, LLC
Part # 038001210HA
Desc. 12X10 SXS 50# PIP
H&A CONC RED
SC# 00259253

Specified Fittings, LLC
Part # 038001210HA
Desc. 12X10 SXS 50# PIP
H&A CONC RED
SC# 00259253

Specified Fittings, LLC
Part # 038001210HA
Desc. 12X10 SXS 50# PIP
H&A CONC RED
SC# 00259253

Specified Fittings, LLC
Part # 038001210HA
Desc. 12X10 SXS 50# PIP
H&A CONC RED
SC# 00259253

Specified Fittings, LLC
Part # 038001210HA
Desc. 12X10 SXS 50# PIP
H&A CONC RED
SC# 00259253

COUPLER

Female X Female



Size	PartNumber	Price
4	032404HA	\$11.73
6	032406HA	\$13.04
8	032408HA	\$20.65
10	0324010HA	\$30.50
12	0324012HA	\$39.88
14	0324014HA	\$53.61
15	0324015HA	\$62.04
16	0324016HA	\$65.57

ELBOW

22-1/2 DEGREE



Size	PartNumber	Price
4	033304HA	\$11.73
6	033306HA	\$16.42
8	033308HA	\$25.82
10	0333010HA	\$35.19
12	0333012HA	\$44.58
14	0333014HA	\$73.68
15	0333015HA	\$99.21
16	0333016HA	\$102.08

TAPERED REDUCER

Size	PartNumber	Price
6x4	0360064HA	\$18.77
8x6	0360086HA	\$24.39
10x8	03600108HA	\$28.14
12x10	036001210HA	\$35.19
14x12	036001412HA	\$49.27
15x14	036001514HA	\$58.67
16x14	036001614HA	\$62.04

45 DEGREE



Size	PartNumber	Price
4	033504HA	\$11.73
6	033506HA	\$16.42
8	033508HA	\$25.82
10	0335010HA	\$35.19
12	0335012HA	\$44.58
14	0335014HA	\$73.68
15	0335015HA	\$99.21
16	0335016HA	\$102.08

REDUCER



Size	PartNumber	Price
6x4	0366164HA	\$12.95
8x4	0366184HA	\$21.59
8x6	0366186HA	\$24.39
10x6	03661106HA	\$30.50
10x8	03661108HA	\$35.19
12x6	03661126HA	\$46.92
12x8	03661128HA	\$49.27
12x10	036611210HA	\$53.96

90 DEGREE



Size	PartNumber	Price
4	033704HA	\$23.47
6	033706HA	\$35.19
8	033708HA	\$50.45
10	0337010HA	\$58.64
12	0337012HA	\$76.97
14	0337014HA	\$142.94
15	0337015HA	\$181.85
16	0337016HA	\$196.82

END CAP



Size	PartNumber	Price
4	031904HA	\$9.10
6	031906HA	\$11.73
8	031908HA	\$16.90
10	0319010HA	\$23.47
12	0319012HA	\$43.16
14	0319014HA	\$55.13
15	0319015HA	\$57.75
16	0319016HA	\$79.58

START COLLAR

Size	PartNumber	Price
4	035204HA	\$10.79
6	035206HA	\$15.02
8	035208HA	\$19.23
10	0352010HA	\$23.47
12	0352012HA	\$29.56
14	0352014HA	\$33.45
15	0352015HA	\$38.54
16	0352016HA	\$43.88

TEE

Female X Female X Female



Size	PartNumber	Price
6x4	0382064HA	\$35.67
6	038206HA	\$53.96
8x6	0382086HA	\$54.44
8	038208HA	\$67.57
10x6	03820106HA	\$78.04
10x8	03820108HA	\$85.41
10	0382010HA	\$101.14
12x6	03820126HA	\$104.65
12x8	03820128HA	\$120.14
12x10	038201210HA	\$128.11
12	0382012HA	\$127.97
14x6	03820146HA	\$125.30
14x8	03820148HA	\$137.51
14x10	038201410HA	\$152.80
14x12	038201412HA	\$165.04
14	0382014HA	\$194.17
15x6	03820156HA	\$140.79
15x8	03820158HA	\$152.06
15x10	038201510HA	\$167.54
15x12	038201512HA	\$183.03
15x14	038201514HA	\$213.54
15	0382015HA	\$239.33
16x6	03820166HA	\$147.84
16x8	03820168HA	\$160.04
16x10	038201610HA	\$175.98
16x12	038201612HA	\$192.42
16x14	038201614HA	\$240.29
16x15	038201615HA	\$317.71
16	0382016HA	\$314.85

SADDLE TEE

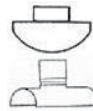

Size	PartNumber	Price
6x4	0369964HA	\$16.79
6	036996HA	\$37.17
8x6	0369986HA	\$19.16
8	036998HA	\$44.46
10x6	03699106HA	\$43.48
10x8	03699108HA	\$44.59
10	0369910HA	\$71.44
12x6	03699126HA	\$52.16
12x8	03699128HA	\$61.02
12x10	036991210HA	\$69.27
12	0369912HA	\$118.06
14x6	03699146HA	\$99.34
14x8	03699148HA	\$105.11
14x10	036991410HA	\$118.86
14x12	036991412HA	\$133.27
15x6	03699156HA	\$153.88
15x8	03699158HA	\$156.54
15x10	036991510HA	\$189.94
15x12	036991512HA	\$210.26
15x14	036991514HA	\$232.86
16x6	03699166HA	\$170.96
16x8	03699168HA	\$164.80
16x10	036991610HA	\$199.94
16x12	036991612HA	\$227.93
16x14	036991614HA	\$245.11
16x15	036991615HA	\$257.36

HEAT & AIR FITTINGS



◀ Need to impress your mother-in-law? We build birdhouses!

▶ "Whisper phones" were built for a class of Pre-K and Kindergarteners. They allow the children to hear their own speech while reading aloud, which helps them to enunciate more clearly.



▲ A children's slide made from Plastic Irrigation Pipe. Installed on the upper terrace of a backyard, it travels through a line of hedges and down to the lower terrace.

The Endless Possibilities of Plastic Pipe

PVC FITTINGS

IPS: GSK & SW SDR32.5 - SDR64



Specified **F**ittings

Long Pattern Repair Couplings

Looking for long pattern repair couplings? Give us a call. We can make any size 1-1/2"-48" nominal diameter for any type of pipe (IPS, C-900/905, SDR35/F679, Profile, PIP), in lengths up to 18' (216"). Whether used on PVC or HDPE these products are a great help when repair or expansion/contraction in place is needed. ■

Certainteed Couplings

We stock and distribute the full line of Certainteed couplings: C-900 DR14 4"-12" in repair and deflection (stop), IPS SDR17 and SDR21 1-1/2"-12" in repair, stop and long pattern repair (18" OAL). We ship same day and keep a representative inventory. You may combine these with any other PVC or CPVC product to obtain freight allowance. ■

Internal Couplings

Specified Fittings makes internal couplings. These couplings allow the installer to continue installation when pipe is flush with a surface. An example of this would be a pipe cut off flush with a wall in a vault or manhole. We make these for all sizes and IDs of pipe: whether IPS, Sewer, C-900/905, PIP, HDPE solid, or PVC Profile pipe. This product is an inexpensive rescue product that can make you a hero. ■

Bolted Repair Couplings

Our bolted repair coupling line is now finished. These versatile products are available in PIP and IPS, sizes 6"-15" where applicable, lengths 12" and 18" with custom lengths also available. Additionally, they are made with zinc or stainless trim, rated in excess of 100PSI, and are stocked in both Idaho and Washington facilities. Competitively priced, with easy installation features, we encourage you to give them a try. Call Bill or Josh in Idaho (208-852-0587), or any PVC salesperson in Bellingham for information! ■



ADAPTER

FEMALE X MIPT

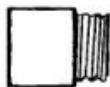

Size	PartNumber	SDR 64		SDR 41		SDR 32.5	
		SW Bell: (20)	GSK Bell: (26)	SW Bell: (21)	GSK Bell: (27)	SW Bell: (22)	GSK Bell: (28)
6	__1506	\$35.00	CF	CF	CF	CF	CF
8	__1508	\$78.30	CF	CF	CF	CF	CF
10	__15010	\$157.82	CF	CF	CF	CF	CF
12	__15012	\$220.73	CF	CF	CF	CF	CF

IPS X CONCRETE

FEMALE X MALE



Size	PartNumber	SDR 64		SDR 41		SDR 32.5	
		SW Bell: (20)	GSK Bell: (26)	SW Bell: (21)	GSK Bell: (27)	SW Bell: (22)	GSK Bell: (28)
6	__1156	\$36.35	CF	CF	CF	CF	CF
8	__1158	\$45.05	CF	CF	CF	CF	CF
10	__11510	\$58.87	CF	CF	CF	CF	CF
12	__11512	\$84.96	CF	CF	CF	CF	CF
12x14	__1151214	\$89.30	CF	CF	CF	CF	CF
12x16	__1151216	\$97.99	CF	CF	CF	CF	CF

IPS X VALVE ADAPTER

FEMALE X FEMALE

Size	PartNumber	SDR 64		SDR 41		SDR 32.5	
		SW Bell: (20)	GSK Bell: (26)	SW Bell: (21)	GSK Bell: (27)	SW Bell: (22)	GSK Bell: (28)
6x6	__1386	CF	CF	\$31.85	CF	CF	CF
8x8	__1388	CF	CF	\$40.03	CF	CF	CF
10x10	__13810	CF	CF	\$64.58	CF	CF	CF
12x12	__13812	CF	CF	\$85.53	CF	CF	CF

CAP

FEMALE



Size	PartNumber	SDR 64		SDR 41		SDR 32.5	
		SW Bell: (20)	GSK Bell: (26)	SW Bell: (21)	GSK Bell: (27)	SW Bell: (22)	GSK Bell: (28)
6	__1906	\$15.41	CF	\$25.15	CF	\$30.14	\$77.84
8	__1908	\$28.31	CF	\$30.95	CF	\$38.85	\$132.10
10	__19010	\$48.60	CF	\$50.19	CF	\$62.43	\$213.23
12	__19012	\$59.54	CF	\$87.85	CF	\$119.99	\$321.90

COUPLING

REPAIR

FEMALE X FEMALE



Size	PartNumber	SDR 64		SDR 41		SDR 32.5	
		SW Bell: (20)	GSK Bell: (26)	SW Bell: (21)	GSK Bell: (27)	SW Bell: (22)	GSK Bell: (28)
6	__2206	CF	CF	CF	\$67.57	CF	\$71.39
8	__2208	CF	CF	CF	\$81.27	CF	\$102.71
10	__22010	CF	CF	CF	\$126.17	CF	\$162.92
12	__22012	CF	CF	CF	\$155.81	CF	\$221.86

COUPLING

STOP

FEMALE X FEMALE

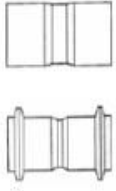

Size	PartNumber	SDR 64		SDR 41		SDR 32.5	
		SW Bell: (20)	GSK Bell: (26)	SW Bell: (21)	GSK Bell: (27)	SW Bell: (22)	GSK Bell: (28)
6	__2406	\$15.41	CF	\$18.70	\$67.30	\$21.07	\$75.33
8	__2408	\$26.74	CF	\$32.40	\$100.49	\$34.89	\$109.46
10	__24010	\$31.61	CF	\$53.47	\$142.64	\$64.02	\$158.97
12	__24012	\$48.60	CF	\$83.49	\$188.09	\$103.00	\$218.12

COUPLING

BOLTED

FEMALE X FEMALE

12" OAL W/ STAINLESS STEEL BOLTS



Size	PartNumber	SDR 64		SDR 41		SDR 32.5	
		SW Bell: (20)	GSK Bell: (26)	SW Bell: (21)	GSK Bell: (27)	SW Bell: (22)	GSK Bell: (28)
4	__2074-IPS SS	CF	\$217.80	CF	\$217.80	CF	\$217.80
6	__2076-12SS	CF	\$282.81	CF	\$282.81	CF	\$282.81
8	__2078-12SS	CF	\$341.18	CF	\$341.18	CF	\$341.18
10	__20710-12SS	CF	\$423.11	CF	\$423.11	CF	\$423.11
12	__20712-12SS	CF	\$483.55	CF	\$483.55	CF	\$483.55

18" OAL W/ STAINLESS STEEL BOLTS



Size	PartNumber	SDR 64		SDR 41		SDR 32.5	
		SW Bell: (20)	GSK Bell: (26)	SW Bell: (21)	GSK Bell: (27)	SW Bell: (22)	GSK Bell: (28)
4	__2074-18SS	CF	\$262.11	CF	\$262.11	CF	\$262.11
6	__2076-18SS	CF	\$341.66	CF	\$341.66	CF	\$341.66
8	__2078-18SS	CF	\$390.51	CF	\$390.51	CF	\$390.51
10	__20710-18SS	CF	\$479.95	CF	\$479.95	CF	\$479.95
12	__20712-18SS	CF	\$559.71	CF	\$559.71	CF	\$559.71

12" OAL W/ ZINC PLATED BOLTS



Size	PartNumber	SDR 64		SDR 41		SDR 32.5	
		SW Bell: (20)	GSK Bell: (26)	SW Bell: (21)	GSK Bell: (27)	SW Bell: (22)	GSK Bell: (28)
4	__2074-12Z	CF	\$92.61	CF	\$92.61	CF	\$92.61
6	__2076-12Z	CF	\$157.62	CF	\$157.62	CF	\$157.62
8	__2078-12Z	CF	\$215.99	CF	\$215.99	CF	\$215.99
10	__20710-12Z	CF	\$266.63	CF	\$266.63	CF	\$266.63
12	__20712-12Z	CF	\$295.78	CF	\$295.78	CF	\$295.78

BOLTED

FEMALE X FEMALE

18" OALW/ ZINC PLATED BOLTS



Size	PartNumber	SDR 64		SDR 41		SDR 32.5	
		SW Bell: (20)	GSK Bell: (26)	SW Bell: (21)	GSK Bell: (27)	SW Bell: (22)	GSK Bell: (28)
4	__2074-18Z	CF	\$99.97	CF	\$99.97	CF	\$99.97
6	__2076-18Z	CF	\$179.53	CF	\$179.53	CF	\$179.53
8	__2078-18Z	CF	\$228.37	CF	\$228.37	CF	\$228.37
10	__20710-18Z	CF	\$277.30	CF	\$277.30	CF	\$277.30
12	__20712-18Z	CF	\$316.53	CF	\$316.53	CF	\$316.53

PVC IPS AG FITTINGS

CROSS

FEMALE X FEMALE X FEMALE X FEMALE

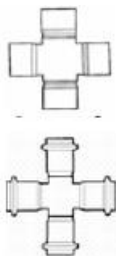

Size	PartNumber	SDR 64		SDR 41		SDR 32.5	
		SW Bell: (20)	GSK Bell: (26)	SW Bell: (21)	GSK Bell: (27)	SW Bell: (22)	GSK Bell: (28)
6x2	26062	\$46.23	CF	\$50.31	CF	\$67.30	CF
6x3	26063	\$52.68	CF	\$63.22	CF	\$84.29	CF
6x4	26064	\$56.77	CF	\$71.39	CF	\$96.41	\$187.90
6x5	26065	CF	CF	\$83.24	CF	\$107.47	CF
6	2606	\$67.30	CF	\$116.69	CF	\$132.10	\$207.57
8x2	26082	\$59.14	CF	\$75.33	CF	\$84.29	CF
8x3	26083	\$63.22	CF	\$84.29	CF	\$92.47	CF
8x4	26084	\$72.17	CF	\$96.41	CF	\$111.03	\$226.49
8x5	26085	CF	CF	\$116.96	CF	\$128.29	CF
8x6	26086	\$77.22	CF	\$117.61	CF	\$139.49	\$256.39
8	2608	\$87.58	CF	\$151.59	CF	\$186.20	\$309.65
10x2	260102	\$72.17	CF	\$104.57	CF	\$124.08	CF
10x3	260103	\$79.42	CF	\$118.41	CF	\$149.22	CF
10x4	260104	\$87.58	CF	\$132.10	CF	\$168.58	\$259.90
10x5	260105	CF	CF	\$143.04	CF	\$188.88	CF
10x6	260106	\$97.33	CF	\$146.72	CF	\$196.25	\$317.01
10x8	260108	\$111.03	CF	\$180.05	CF	\$244.06	\$366.07
10	26010	\$141.86	CF	\$226.14	CF	\$317.82	\$538.44
12x2	260122	\$103.00	CF	\$137.77	CF	\$201.13	CF
12x3	260123	\$112.74	CF	\$158.97	CF	\$209.16	CF
12x4	260124	\$119.99	CF	\$190.06	CF	\$234.31	\$442.66
12x5	260125	CF	CF	\$193.22	CF	\$255.65	CF
12x6	260126	\$126.45	CF	\$197.83	CF	\$269.21	\$507.21
12x8	260128	\$145.93	CF	\$231.02	CF	\$316.23	\$586.87
12x10	2601210	\$174.25	CF	\$286.99	CF	\$401.32	\$662.46
12	26012	\$221.40	CF	\$348.63	CF	\$513.28	\$755.62

ELBOW

11-1/4 DEGREE

FEMALE X FEMALE



Size	PartNumber	SDR 64		SDR 41		SDR 32.5	
		SW Bell: (20)	GSK Bell: (26)	SW Bell: (21)	GSK Bell: (27)	SW Bell: (22)	GSK Bell: (28)
6	3106	\$21.07	CF	\$27.52	\$94.04	\$33.20	\$117.61
8	3108	\$33.20	CF	\$42.15	\$115.11	\$51.10	\$175.96
10	31010	\$47.02	CF	\$34.22	\$197.04	\$93.25	\$234.31
12	31012	\$76.13	CF	\$105.37	\$263.55	\$151.59	\$317.82

ELBOW

15 DEGREE

FEMALE X FEMALE



Size	PartNumber	SDR 64		SDR 41		SDR 32.5	
		SW Bell: (20)	GSK Bell: (26)	SW Bell: (21)	GSK Bell: (27)	SW Bell: (22)	GSK Bell: (28)
6	3206	\$21.07	CF	\$27.52	\$94.04	\$33.20	\$117.61
8	3208	\$33.20	CF	\$42.15	\$115.11	\$51.10	\$175.96
10	32010	\$47.02	CF	\$34.22	\$197.04	\$93.25	\$234.31
12	32012	\$76.13	CF	\$105.37	\$263.55	\$151.59	\$317.82

22-1/2 DEGREE

FEMALE X FEMALE



Size	PartNumber	SDR 64		SDR 41		SDR 32.5	
		SW Bell: (20)	GSK Bell: (26)	SW Bell: (21)	GSK Bell: (27)	SW Bell: (22)	GSK Bell: (28)
6	__3306	\$21.07	CF	\$27.52	\$94.04	\$33.20	\$117.61
8	__3308	\$33.20	CF	\$42.15	\$115.11	\$51.10	\$175.96
10	__33010	\$47.02	CF	\$34.22	\$197.04	\$93.25	\$234.31
12	__33012	\$76.13	CF	\$105.37	\$263.55	\$151.59	\$317.82

30 DEGREE

FEMALE X FEMALE

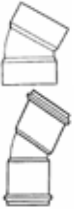

Size	PartNumber	SDR 64		SDR 41		SDR 32.5	
		SW Bell: (20)	GSK Bell: (26)	SW Bell: (21)	GSK Bell: (27)	SW Bell: (22)	GSK Bell: (28)
6	__3406	\$29.24	CF	\$36.47	\$125.65	\$41.34	\$133.81
8	__3408	\$42.93	CF	\$60.85	\$154.89	\$64.01	\$188.09
10	__34010	\$62.43	CF	\$93.25	\$218.12	\$132.10	\$276.46
12	__34012	\$101.42	CF	\$136.18	\$301.61	\$193.74	\$401.32

45 DEGREE

FEMALE X FEMALE



Size	PartNumber	SDR 64		SDR 41		SDR 32.5	
		SW Bell: (20)	GSK Bell: (26)	SW Bell: (21)	GSK Bell: (27)	SW Bell: (22)	GSK Bell: (28)
6	__3506	\$55.18	CF	\$71.39	\$125.65	\$79.42	\$133.81
8	__3508	\$75.33	CF	\$109.46	\$154.89	\$130.51	\$188.09
10	__35010	\$117.61	CF	\$93.25	\$218.12	\$206.78	\$276.46
12	__35012	\$167.80	CF	\$238.39	\$301.61	\$316.23	\$401.32

60 DEGREE

FEMALE X FEMALE

Size	PartNumber	SDR 64		SDR 41		SDR 32.5	
		SW Bell: (20)	GSK Bell: (26)	SW Bell: (21)	GSK Bell: (27)	SW Bell: (22)	GSK Bell: (28)
6	__3606	CF	CF	CF	\$144.35	CF	\$166.21
8	__3608	CF	CF	CF	\$218.90	CF	\$268.43
10	__36010	CF	CF	CF	\$318.60	CF	\$312.15
12	__36012	CF	CF	CF	\$427.26	CF	\$503.52

ELBOW

90 DEGREE

FEMALE X FEMALE



Size	PartNumber	SDR 64		SDR 41		SDR 32.5	
		SW Bell: (20)	GSK Bell: (26)	SW Bell: (21)	GSK Bell: (27)	SW Bell: (22)	GSK Bell: (28)
6	__3706	\$55.18	CF	\$71.39	\$144.35	\$79.42	\$166.21
8	__3708	\$75.33	CF	\$130.51	\$218.90	\$130.51	\$268.43
10	__37010	\$117.61	CF	\$206.78	\$318.60	\$206.78	\$422.40
12	__37012	\$167.80	CF	\$238.39	\$427.26	\$316.23	\$503.52

All Elbows Available in Female x Male Sizes and in Custom Angles. Please Contact Factory for More Information.

PLUG

MALE

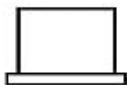

Size	PartNumber	SDR 64		SDR 41		SDR 32.5	
		SW Bell: (20)	GSK Bell: (26)	SW Bell: (21)	GSK Bell: (27)	SW Bell: (22)	GSK Bell: (28)
6	__5606	CF	CF	CF	CF	CF	\$39.04
8	__5608	CF	CF	CF	CF	CF	\$50.51
10	__56010	CF	CF	CF	CF	CF	\$81.17
12	__56012	CF	CF	CF	CF	CF	\$155.98

REDUCER

CONCENTRIC

STYLE A

FEMALE X FEMALE

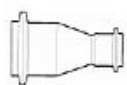
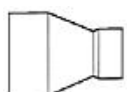

Size	PartNumber	SDR 64		SDR 41		SDR 32.5	
		SW Bell: (20)	GSK Bell: (26)	SW Bell: (21)	GSK Bell: (27)	SW Bell: (22)	GSK Bell: (28)
5x4	__60054	CF	CF	CF	CF	\$29.94	CF
6x4	__60064	\$21.07	CF	\$23.44	\$84.29	\$26.74	\$92.47
6x5	__60065	\$24.48	CF	\$27.78	CF	\$35.57	CF
8x6	__60086	\$27.52	CF	\$37.39	\$121.56	\$41.35	\$133.81
10x8	__600108	\$38.84	CF	\$58.38	\$167.80	\$66.50	\$209.16
12x10	__6001210	\$68.09	CF	\$101.42	\$232.74	\$126.45	\$263.55

STYLE B

FEMALE X FEMALE

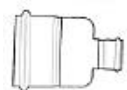
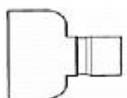

Size	PartNumber	SDR 64		SDR 41		SDR 32.5	
		SW Bell: (20)	GSK Bell: (26)	SW Bell: (21)	GSK Bell: (27)	SW Bell: (22)	GSK Bell: (28)
6x2	__60062	CF	CF	\$67.57	CF	\$70.20	CF
6x3	__60063	CF	CF	\$73.61	CF	\$74.54	CF
8x2	__60082	CF	CF	\$75.73	CF	\$80.60	CF
8x3	__60083	CF	CF	\$75.86	CF	\$87.58	CF
8x4	__60084	CF	CF	\$55.79	\$144.91	\$62.56	\$156.86
8x5	__60085	CF	CF	CF	CF	CF	CF
10x2	__600102	CF	CF	\$105.76	CF	\$116.96	CF
10x3	__600103	CF	CF	\$111.83	CF	\$125.65	CF
10x4	__600104	CF	CF	\$112.48	CF	\$143.04	CF
10x5	__600105	CF	CF	\$114.59	CF	\$148.18	CF
10x6	__600106	CF	CF	\$94.36	\$196.42	\$102.60	\$246.17
12x2	__600122	CF	CF	\$133.68	CF	\$169.91	CF
12x3	__600123	CF	CF	\$138.56	CF	\$176.75	CF
12x4	__600124	CF	CF	\$143.04	CF	\$183.74	CF
12x5	__600125	CF	CF	\$148.18	CF	\$192.43	CF
12x6	__600126	CF	CF	\$156.86	CF	\$196.77	CF
12x8	__600128	CF	CF	\$125.50	CF	\$158.45	CF

REDUCER

CONCENTRIC

SMALL END BELL (SEB)

MALE X FEMALE

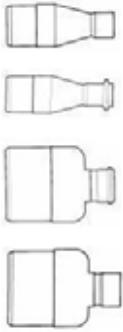

Size	PartNumber	SDR 64		SDR 41		SDR 32.5	
		SW Bell: (20)	GSK Bell: (26)	SW Bell: (21)	GSK Bell: (27)	SW Bell: (22)	GSK Bell: (28)
6x4	__62064	CF	CF	CF	\$63.25	CF	\$79.42
6x5	__62065	CF	CF	CF	CF	CF	CF
8x4	__62084	CF	CF	CF	\$110.02	CF	\$137.77
8x5	__62085	CF	CF	CF	CF	CF	CF
8x6	__62086	CF	CF	CF	\$84.29	CF	\$117.61
10x4	__620104	CF	CF	CF	CF	CF	CF
10x5	__620105	CF	CF	CF	CF	CF	CF
10x6	__620106	CF	CF	CF	\$165.13	CF	\$187.16
10x8	__620108	CF	CF	CF	\$133.81	CF	\$158.97
12x4	__620124	CF	CF	CF	CF	CF	CF
12x5	__620125	CF	CF	CF	CF	CF	CF
12x6	__620126	CF	CF	CF	CF	CF	CF
12x8	__620128	CF	CF	CF	\$236.79	CF	\$268.69
12x10	__6201210	CF	CF	CF	\$189.66	CF	\$228.65

LARGE END BELL (LEB)

FEMALE X MALE

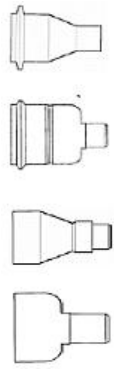

Size	PartNumber	SDR 64		SDR 41		SDR 32.5	
		SW Bell: (20)	GSK Bell: (26)	SW Bell: (21)	GSK Bell: (27)	SW Bell: (22)	GSK Bell: (28)
6x4	__64064	CF	CF	CF	\$67.30	CF	\$79.42
6x5	__64065	CF	CF	CF	CF	CF	CF
8x4	__64084	CF	CF	CF	\$128.54	CF	\$137.77
8x5	__64085	CF	CF	CF	CF	CF	CF
8x6	__64086	CF	CF	CF	\$96.41	CF	\$117.61
10x4	__640104	CF	CF	CF	CF	CF	CF
10x5	__640105	CF	CF	CF	CF	CF	CF
10x6	__640106	CF	CF	CF	\$165.13	CF	\$187.16
10x8	__640108	CF	CF	CF	\$133.81	CF	\$158.97
12x4	__640124	CF	CF	CF	CF	CF	CF
12x5	__640125	CF	CF	CF	CF	CF	CF
12x6	__640126	CF	CF	CF	CF	CF	CF
12x8	__640128	CF	CF	CF	\$236.79	CF	\$268.69
12x10	__6401210	CF	CF	CF	\$189.66	CF	\$228.65

ECCENTRIC

FEMALE X FEMALE

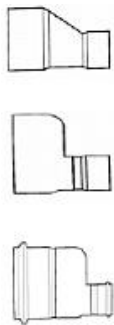

Size	PartNumber	SDR 64		SDR 41		SDR 32.5	
		SW Bell: (20)	GSK Bell: (26)	SW Bell: (21)	GSK Bell: (27)	SW Bell: (22)	GSK Bell: (28)
6x2	__61062	CF	CF	\$67.57	CF	\$70.20	CF
6x3	__61063	CF	CF	\$73.61	CF	\$74.54	CF
6x4	__61064	CF	CF	CF	CF	CF	CF
6x5	__61065	CF	CF	CF	CF	CF	CF
8x2	__61082	CF	CF	\$75.73	CF	\$80.60	CF
8x2.5	__61082.5	CF	CF	CF	CF	CF	CF
8x3	__61083	CF	CF	\$75.86	CF	\$87.58	CF
8x4	__61084	CF	CF	CF	CF	CF	CF
8x5	__61085	CF	CF	\$92.72	CF	\$98.78	CF
8x6	__61086	CF	CF	CF	CF	CF	CF
10x2	__610102	CF	CF	\$105.76	CF	\$116.96	CF
10x3	__610103	CF	CF	\$111.83	CF	\$125.65	CF
10x4	__610104	CF	CF	\$112.48	CF	\$143.04	CF

PVC IPS AG FITTINGS

REDUCER

ECCENTRIC

FEMALE X FEMALE

Size	PartNumber	SDR 64		SDR 41		SDR 32.5	
		SW Bell: (20)	GSK Bell: (26)	SW Bell: (21)	GSK Bell: (27)	SW Bell: (22)	GSK Bell: (28)
10x5	__610105	CF	CF	\$114.59	CF	\$148.18	CF
10x6	__610106	CF	CF	CF	CF	CF	CF
10x8	__610108	CF	CF	CF	CF	CF	CF
12x2	__610122	CF	CF	\$133.68	CF	\$169.91	CF
12x3	__610123	CF	CF	\$138.56	CF	\$176.75	CF
12x4	__610124	CF	CF	\$143.04	CF	\$183.74	CF
12x5	__610125	CF	CF	\$148.18	CF	\$192.43	CF
12x6	__610126	CF	CF	\$156.86	CF	\$196.77	CF

SURFACE STYLE

Size	PartNumber	SDR 64		SDR 41		SDR 32.5	
		SW Bell: (20)	GSK Bell: (26)	SW Bell: (21)	GSK Bell: (27)	SW Bell: (22)	GSK Bell: (28)
6x2	__66162	\$22.65	CF	CF	CF	CF	CF
6x3	__66163	\$22.65	CF	CF	CF	CF	CF
6x4	__66164	\$22.65	CF	CF	CF	CF	CF
6x5	__66165	\$22.65	CF	CF	CF	CF	CF
8x2	__66182	\$30.83	CF	CF	CF	CF	CF
8x3	__66183	\$30.83	CF	CF	CF	CF	CF
8x4	__66184	\$30.83	CF	CF	CF	CF	CF
8x5	__66185	\$30.83	CF	CF	CF	CF	CF
8x6	__66186	\$30.83	CF	CF	CF	CF	CF
10x2	__661102	\$49.51	CF	CF	CF	CF	CF
10x3	__6611013	\$49.51	CF	CF	CF	CF	CF
10x4	__661104	\$49.51	CF	CF	CF	CF	CF
10x5	__661105	\$49.51	CF	CF	CF	CF	CF
10x6	__661106	\$49.51	CF	CF	CF	CF	CF
10x8	__661108	\$49.51	CF	CF	CF	CF	CF
12x2	__661122	\$60.85	CF	CF	CF	CF	CF
12x3	__661123	\$60.85	CF	CF	CF	CF	CF
12x4	__661124	\$60.85	CF	CF	CF	CF	CF
12x5	__661125	\$60.85	CF	CF	CF	CF	CF
12x6	__661126	\$60.85	CF	CF	CF	CF	CF
12x8	__661128	\$60.85	CF	CF	CF	CF	CF

SADDLE TEE

FEMALE SLIP x FEMALE

STUB STYLE

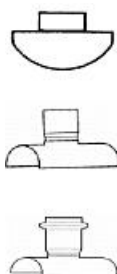

Size	PartNumber	SDR 64		SDR 41		SDR 32.5	
		SW Bell: (20)	GSK Bell: (26)	SW Bell: (21)	GSK Bell: (27)	SW Bell: (22)	GSK Bell: (28)
6x2	__70162	\$25.79	CF	CF	CF	\$47.23	CF
6x3	__70163	\$30.27	CF	CF	CF	\$51.73	CF
6x4	__70164	\$34.77	CF	CF	CF	\$57.95	CF
6x5	__70165	CF	CF	CF	CF	CF	CF
8x2	__70182	\$25.79	CF	CF	CF	\$47.23	CF
8x3	__70183	\$30.27	CF	CF	CF	\$51.73	CF
8x4	__70184	\$34.77	CF	CF	CF	\$57.95	CF
8x5	__70185	CF	CF	CF	CF	CF	CF
8x6	__70186	\$39.25	CF	CF	CF	\$70.41	CF
10x2	__701102	\$25.79	CF	CF	CF	\$47.23	CF
10x3	__701103	\$30.27	CF	CF	CF	\$51.73	CF
10x4	__701104	\$34.77	CF	CF	CF	\$57.95	CF
10x5	__701105	CF	CF	CF	CF	CF	CF
10x6	__701106	\$39.25	CF	CF	CF	\$70.41	CF

SADDLE TEE

FEMALE SLIP x FEMALE

STUB STYLE

Size	PartNumber	SDR 64		SDR 41		SDR 32.5	
		SW Bell: (20)	GSK Bell: (26)	SW Bell: (21)	GSK Bell: (27)	SW Bell: (22)	GSK Bell: (28)
10x8	__701108	\$53.47	CF	CF	CF	\$81.12	CF
12x2	__701122	\$25.79	CF	CF	CF	\$47.23	CF
12x3	__701123	\$30.27	CF	CF	CF	\$51.73	CF
12x4	__701124	\$34.77	CF	CF	CF	\$57.95	CF
12x5	__701125	CF	CF	CF	CF	CF	CF
12x6	__701126	\$39.25	CF	CF	CF	\$70.41	CF
12x8	__701128	\$53.47	CF	CF	CF	\$81.12	CF
12x10	__7011210	\$74.02	CF	CF	CF	\$85.62	CF

TEE

STRAIGHT

FEMALE X FEMALE X FEMALE

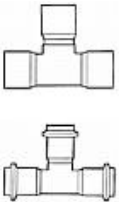

Size	PartNumber	SDR 64		SDR 41		SDR 32.5	
		SW Bell: (20)	GSK Bell: (26)	SW Bell: (21)	GSK Bell: (27)	SW Bell: (22)	GSK Bell: (28)
4	__8204	CF	CF	CF	CF	CF	\$132.88
6x2	__82062	\$39.78	CF	\$52.68	CF	\$63.22	CF
6x3	__82063	\$42.15	CF	\$59.14	CF	\$67.30	CF
6x4	__82064	\$46.23	CF	\$64.93	\$100.49	\$75.33	\$142.64
6x5	__82065	\$0.00	CF	\$71.92	CF	\$107.47	CF
6	__8206	\$50.31	CF	\$101.42	\$113.52	\$112.74	\$150.81
8x2	__82082	\$55.18	CF	\$69.67	CF	\$75.33	CF
8x3	__82083	\$59.14	CF	\$77.84	CF	\$84.30	CF
8x4	__82084	\$63.22	CF	\$88.38	\$150.81	\$96.41	\$167.80
8x5	__82085	CF	CF	\$103.13	CF	\$111.83	CF
8x6	__82086	\$75.33	CF	\$113.52	\$154.89	\$119.99	\$189.66
8	__8208	\$84.29	CF	\$128.14	\$201.13	\$151.59	\$217.32
10x2	__820102	\$75.33	CF	\$92.47	CF	\$118.41	CF
10x3	__820103	\$88.38	CF	\$106.94	CF	\$139.49	CF
10x4	__820104	\$100.49	CF	\$119.99	\$224.56	\$157.26	\$278.83
10x5	__820105	CF	CF	\$130.00	CF	\$169.91	CF
10x6	__820106	\$109.46	CF	\$132.10	\$240.76	\$174.25	\$291.08
10x8	__820108	\$116.69	CF	\$153.18	\$261.84	\$207.57	\$338.89
10	__82010	\$125.65	CF	\$178.33	\$292.66	\$246.43	\$368.14
12x2	__820122	\$129.73	CF	\$139.49	CF	\$182.42	CF
12x3	__820123	\$133.81	CF	\$147.51	CF	\$197.83	CF
12x4	__820124	\$138.69	CF	\$164.64	\$286.99	\$218.90	\$338.89
12x5	__820125	CF	CF	\$185.44	CF	\$237.48	CF
12x6	__820126	\$142.64	CF	\$188.09	\$294.38	\$246.43	\$348.63
12x8	__820128	\$150.81	CF	\$207.57	\$309.65	\$277.25	\$418.31
12x10	__8201210	\$154.89	CF	\$248.15	\$368.14	\$329.15	\$445.97
12	__82012	\$172.67	CF	\$281.34	\$406.99	\$369.71	\$532.64

PVC IPS AG FITTINGS

TEE

MALE X FEMALE X FEMALE

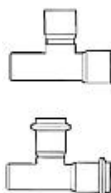

Size	Part Number	SDR 64		SDR 41		SDR 32.5	
		SW Bell: (20)	GSK Bell: (26)	SW Bell: (21)	GSK Bell: (27)	SW Bell: (22)	GSK Bell: (28)
4	8304	CF	CF	CF	CF	CF	\$84.29
6x4	83064	CF	CF	CF	\$100.49	CF	\$121.56
6x5	83065	CF	CF	CF	CF	CF	CF
6	8306	CF	CF	CF	\$117.61	CF	\$125.65
8x4	83084	CF	CF	CF	\$126.84	CF	\$138.69
8x5	83085	CF	CF	CF	CF	CF	CF
8x6	83086	CF	CF	CF	\$147.51	CF	\$175.17
8	83088	CF	CF	CF	\$162.52	CF	\$209.16
10x4	830104	CF	CF	CF	\$189.66	CF	\$242.47
10x5	830105	CF	CF	CF	CF	CF	CF
10x6	830106	CF	CF	CF	\$209.16	CF	\$263.55
10x8	830108	CF	CF	CF	\$232.74	CF	\$292.66
10	83010	CF	CF	CF	\$275.67	CF	\$334.81
12x4	830124	CF	CF	CF	\$256.18	CF	\$313.74
12x5	830125	CF	CF	CF	CF	CF	CF
12x6	830126	CF	CF	CF	\$273.31	CF	\$317.82
12x8	830128	CF	CF	CF	\$302.40	CF	\$334.81
12x10	8301210	CF	CF	CF	\$344.55	CF	\$376.17
12	8301212	CF	CF	CF	\$385.91	CF	\$438.53

TEE

TAPPED

FEMALE X FEMALE X FIPT

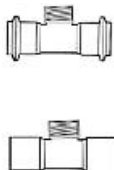

Size	Part Number	SDR 64		SDR 41		SDR 32.5	
		SW Bell: (20)	GSK Bell: (26)	SW Bell: (21)	GSK Bell: (27)	SW Bell: (22)	GSK Bell: (28)
4x3	84043	CF	CF	CF	CF	CF	\$90.37
4	8404	CF	CF	CF	CF	CF	\$107.47
6x2	84062	CF	CF	\$43.59	\$74.54	\$56.77	\$119.19
6x3	84063	CF	CF	\$53.86	\$81.92	\$64.93	\$127.49
6x4	84064	CF	CF	\$62.04	\$91.54	\$73.76	\$135.65
8x2	84082	CF	CF	\$67.18	\$114.45	\$81.92	\$148.83
8x3	84083	CF	CF	\$79.03	\$133.68	\$95.62	\$157.00
8x4	84084	CF	CF	\$87.05	\$144.75	\$104.57	\$170.17
10x2	840102	CF	CF	\$104.04	\$171.22	\$126.45	\$231.81
10x3	840103	CF	CF	\$122.49	\$180.83	\$147.51	\$244.19
10x4	840104	CF	CF	\$132.88	\$200.06	\$161.34	\$269.61
12x2	840122	CF	CF	\$151.34	\$228.78	\$182.42	\$313.99
12x3	840123	CF	CF	\$167.54	\$238.39	\$203.50	\$343.63
12x4	840124	CF	CF	\$185.97	\$248.01	\$224.56	\$359.30

TEE

MALE X GASKET X SOLVENT WELD BELL

Size	PartNumber	SDR 64		SDR 41		SDR 32.5	
		SW Bell:	GSK Bell:	SW Bell:	GSK Bell:	SW Bell:	GSK Bell:
		(20)	(26)	(21)	(27)	(22)	(28)
6x2	__84162	CF	CF	CF	\$107.47	CF	\$123.01
6x3	__84163	CF	CF	CF	\$121.31	CF	\$138.69
6x4	__84164	CF	CF	CF	\$132.63	CF	\$152.52
6x5	__84165	CF	CF	CF	\$138.69	CF	\$156.86
6x6	__84166	CF	CF	CF	\$148.18	CF	\$165.56
8x2	__84182	CF	CF	CF	\$134.35	CF	\$169.91
8x3	__84183	CF	CF	CF	\$143.04	CF	\$175.04
8x4	__84184	CF	CF	CF	\$152.52	CF	\$179.39
8x5	__84185	CF	CF	CF	\$161.22	CF	\$188.09
8x6	__84186	CF	CF	CF	\$169.91	CF	\$200.99
8x8	__84188	CF	CF	CF	\$188.09	CF	\$214.95
10x2	__841102	CF	CF	CF	\$206.26	CF	\$233.13
10x3	__841103	CF	CF	CF	\$214.95	CF	\$241.82
10x4	__841104	CF	CF	CF	\$223.51	CF	\$259.08
10x5	__841105	CF	CF	CF	\$227.85	CF	\$268.69
10x6	__841106	CF	CF	CF	\$237.48	CF	\$281.60
10x8	__841108	CF	CF	CF	\$254.72	CF	\$312.81
10x10	__8411010	CF	CF	CF	\$272.90	CF	\$357.86
12x2	__841122	CF	CF	CF	\$259.08	CF	\$312.81
12x3	__841123	CF	CF	CF	\$277.25	CF	\$322.29
12x4	__841124	CF	CF	CF	\$285.94	CF	\$330.99
12x5	__841125	CF	CF	CF	\$291.21	CF	\$335.34
12x6	__841126	CF	CF	CF	\$295.56	CF	\$339.68
12x8	__841128	CF	CF	CF	\$304.11	CF	\$357.86
12x10	__8411210	CF	CF	CF	\$346.66	CF	\$402.11
12x12	__8411212	CF	CF	CF	\$380.38	CF	\$492.20

MALE X FEMALE X FIPT

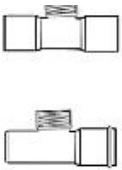

Size	PartNumber	SDR 64		SDR 41		SDR 32.5	
		SW Bell:	GSK Bell:	SW Bell:	GSK Bell:	SW Bell:	GSK Bell:
		(20)	(26)	(21)	(27)	(22)	(28)
4x3	__85043	CF	CF	CF	CF	CF	\$84.56
4	__8504	CF	CF	CF	CF	CF	\$98.78
6x2	__85062	CF	CF	\$43.59	\$63.48	\$56.77	\$98.65
6x3	__85063	CF	CF	\$53.86	\$72.31	\$64.93	\$112.61
6x4	__85064	CF	CF	\$62.04	\$84.16	\$73.76	\$119.19
8x2	__85082	CF	CF	\$67.18	\$95.22	\$81.92	\$123.28
8x3	__85083	CF	CF	\$79.03	\$107.09	\$95.62	\$131.58
8x4	__85084	CF	CF	\$87.05	\$118.14	\$104.57	\$140.67
10x2	__850102	CF	CF	\$104.04	\$149.09	\$126.45	\$186.63
10x3	__850103	CF	CF	\$122.49	\$160.15	\$147.51	\$201.38
10x4	__850104	CF	CF	\$132.88	\$175.69	\$161.34	\$221.14
12x2	__850122	CF	CF	\$151.34	\$198.62	\$182.42	\$254.86
12x3	__850123	CF	CF	\$167.54	\$209.68	\$203.50	\$276.20
12x4	__850124	CF	CF	\$185.97	\$228.78	\$224.56	\$296.75

VENT CHAMBER

FEMALE X FEMALE

Size	PartNumber	SDR 64		SDR 41		SDR 32.5	
		SW Bell:	GSK Bell:	SW Bell:	GSK Bell:	SW Bell:	GSK Bell:
		(20)	(26)	(21)	(27)	(22)	(28)
6x2	__87062	CF	CF	\$162.92	CF	\$175.04	CF
8x3	__87083	CF	CF	\$223.51	CF	\$268.69	CF
10x3	__870103	CF	CF	\$283.31	CF	\$357.86	CF
12x4	__870124	CF	CF	\$384.73	CF	\$455.85	CF

TEE

GASKET X GASKET X SLIP

Size	PartNumber	SDR 64		SDR 41		SDR 32.5	
		SW Bell: (20)	GSK Bell: (26)	SW Bell: (21)	GSK Bell: (27)	SW Bell: (22)	GSK Bell: (28)
6x1.5	83861.5	CF	CF	CF	CF	CF	CF
6x2	83862	CF	CF	CF	\$107.47	CF	\$123.01
6x3	83863	CF	CF	CF	\$121.31	CF	\$138.69
6x4	83864	CF	CF	CF	\$132.63	CF	\$152.52
6x5	83865	CF	CF	CF	\$138.69	CF	\$156.86
6	8386	CF	CF	CF	\$148.18	CF	\$165.56
8x2	83882	CF	CF	CF	\$134.35	CF	\$169.91
8x3	83883	CF	CF	CF	\$143.04	CF	\$175.04
8x4	83884	CF	CF	CF	\$152.52	CF	\$179.39
8x5	83885	CF	CF	CF	\$161.22	CF	\$188.09
8x6	83886	CF	CF	CF	\$169.91	CF	\$200.99
8	8388	CF	CF	CF	\$188.09	CF	\$214.95
10x2	838102	CF	CF	CF	\$206.26	CF	\$233.13
10x3	838103	CF	CF	CF	\$214.95	CF	\$241.82
10x4	838104	CF	CF	CF	\$223.51	CF	\$259.08
10x5	838105	CF	CF	CF	\$227.85	CF	\$268.69
10x6	838106	CF	CF	CF	\$237.48	CF	\$281.60
10x8	838108	CF	CF	CF	\$254.72	CF	\$312.81
10	83810	CF	CF	CF	\$272.90	CF	\$357.86
12x2	838122	CF	CF	CF	\$259.08	CF	\$312.81
12x3	838123	CF	CF	CF	\$277.25	CF	\$322.29
12x4	838124	CF	CF	CF	\$285.94	CF	\$330.99
12x5	838125	CF	CF	CF	\$291.21	CF	\$335.34
12x6	838126	CF	CF	CF	\$295.56	CF	\$339.68
12x8	838128	CF	CF	CF	\$304.11	CF	\$357.86
12x10	8381210	CF	CF	CF	\$346.66	CF	\$402.11
12x12	8381212	CF	CF	CF	\$380.38	CF	\$492.20

WYE

FEMALE X FEMALE X FEMALE

§ Available in Smaller and Larger Sizes. § Available in IPS x PIP. § Wyes Not Rated for Pressure—Contact Factory for Pressure Ratings.

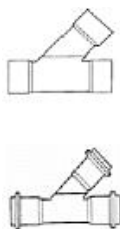

Size	PartNumber	SDR 64		SDR 41		SDR 32.5	
		SW Bell: (20)	GSK Bell: (26)	SW Bell: (21)	GSK Bell: (27)	SW Bell: (22)	GSK Bell: (28)
6x4	92064	CF	CF	CF	CF	CF	\$178.31
6x5	92065	CF	CF	CF	CF	CF	CF
6	9206	CF	CF	CF	CF	CF	\$186.37
8x4	92084	CF	CF	CF	CF	CF	\$209.75
8x5	92085	CF	CF	CF	CF	CF	CF
8x6	92086	CF	CF	CF	CF	CF	\$237.08
8	9208	CF	CF	CF	CF	CF	\$283.31
10x4	920104	CF	CF	CF	CF	CF	\$348.54
10x5	920105	CF	CF	CF	CF	CF	CF
10x6	920106	CF	CF	CF	CF	CF	\$363.85
10x8	920108	CF	CF	CF	CF	CF	\$423.60
10	92010	CF	CF	CF	CF	CF	\$449.79
12x4	920124	CF	CF	CF	CF	CF	\$440.49
12x5	920125	CF	CF	CF	CF	CF	CF
12x6	920126	CF	CF	CF	CF	CF	\$453.22
12x8	920128	CF	CF	CF	CF	CF	\$543.81
12x10	9201210	CF	CF	CF	CF	CF	\$579.76
12	92012	CF	CF	CF	CF	CF	\$650.78



Frequently Asked Questions

Q: What are the effects of PVC exposure to sunlight?

A: Ultraviolet (UV) radiation from sunlight can affect the outermost surface of PVC pipe. However, even after prolonged exposure, there is no practical effect on PVC pipe's performance characteristics. UV exposure affects PVC pipe material in two ways:

- Fading of pigment, which is characterized by whitening of the pipe's color. Since the pipe is intended to be buried, pigments are not colorfast and will fade when exposed to sunlight.
- Conversion of PVC molecules to polyene, which is a yellowish discoloration limited to the first .001" to .002" of exposed surface. Often called "UV degradation" or "sunburn," this process takes much longer than the color-fading phase.

Q: What information is included on the product label attached to fittings?

A: A label is attached to every fitting we fabricate prior to shipment. This label includes Company information including address and telephone number, the fitting's part number and description including size, and a work order or sales order number which allows us to trace the manufacturing process. Additional information such as location tags or ASTM/AWWA specifications can also be added. ■



PVC IPS FITTINGS

GASKETED PRESSURE: SDR26 - SDR21



Specified **F**ittings



ADAPTER

FEMALE X MALE

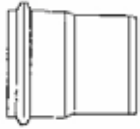

Size	PartNumber	SDR 26	SDR 21
		(29)	(30)
1.5	1711.5	\$13.40*	\$13.40*
2	1712	\$13.65*	\$13.65*
2.5	1712.5	\$15.58*	\$15.58*
3	1713	\$19.25*	\$19.25*
4	1714	\$34.39*	\$34.39*
5	1715	\$50.20*	\$50.20*
6	1716	\$50.20*	\$50.20*
8	1718	\$172.50	\$192.53
10	17110	\$252.72	\$319.56
12	17112	\$379.73	\$457.25
14	17114	CF	CF
16	17116	CF	CF
18	17118	CF	CF
20	17120	CF	CF
24	17124	CF	CF

Prices with asterisk (*) indicate molded item.

CROSS

FEMALE X FEMALE X FEMALE X FEMALE

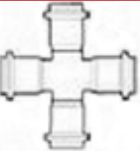

Size	PartNumber	SDR 26	SDR 21
		(29)	(30)
4	2604	\$318.37	\$343.84
6x4	2606-4	\$450.57	\$565.56
6	2606	\$572.24	\$726.05
8x4	2608-4	\$615.00	\$739.40
8x6	2608-6	\$738.07	\$861.07
8	2608	\$887.85	\$1,103.13
10x4	26010-4	\$799.56	\$954.71
10x6	26010-6	\$978.75	\$1,089.72
10x8	26010-8	\$1203.39	\$1,243.54
10	26010	\$1478.82	\$1,647.28
12x4	26012-4	\$1172.59	\$1,345.10
12x6	26012-6	\$1344.53	\$1,434.69
12x8	26012-8	\$1517.55	\$1,551.03
12x10	26012-10	\$1778.35	\$1,815.78
12	26012	CF	CF

PLUG

MALE

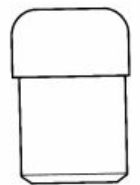

Size	PartNumber	SDR 26	SDR 21
		(29)	(30)
4	5604	\$92.70	\$92.70
6	5606	\$130.42	\$130.42
8	5608	\$221.74	\$221.74
10	56010	CF	CF
12	56012	CF	CF
14	56014	CF	CF
16	56016	CF	CF
18	56018	CF	CF
20	56020	CF	CF
24	56024	CF	CF

CAP

FEMALE



Size	PartNumber	SDR 26	SDR 21
		(29)	(30)
4	1904	\$88.55	\$92.49
6	1906	\$128.31	\$139.18
8	1908	\$163.81	\$176.96
10	19010	\$330.97	\$375.69
12	19012	\$499.46	\$567.17
14	19014	CF	CF
16	19016	CF	CF
18	19018	CF	CF
20	19020	CF	CF
24	19024	CF	CF

COUPLING

REPAIR

FEMALE X FEMALE



Size	PartNumber	SDR 26	SDR 21
		(29)	(30)
1.5	2201.5	\$12.91*	\$12.91*
2	2202	\$14.17*	\$14.17*
2.5	2202.5	\$15.58*	\$15.58*
3	2203	\$19.49*	\$19.49*
4	2204	\$35.08*	\$35.08*
5	2205	\$57.27*	\$57.27*
6	2206	\$61.64*	\$61.64*
8	2208	\$126.97*	\$126.97*
10	22010	\$230.16	\$255.55
12	22012	\$299.82	\$356.95
14	22014	CF	CF
16	22016	CF	CF
18	22018	CF	CF
20	22020	CF	CF
24	22024	CF	CF

Prices with asterisk (*) indicate molded item.

STOP

FEMALE X FEMALE

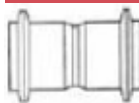

Size	PartNumber	SDR 26	SDR 21
		(29)	(30)
1.5	2401.5	\$11.71*	\$11.71*
2	2402	\$11.94*	\$11.94*
2.5	2402.5	\$12.91*	\$12.91*
3	2403	\$16.32*	\$16.32*
4	2404	\$29.72*	\$29.72*
5	2405	CF	CF
6	2406	\$45.31*	\$45.31*
8	2408	\$98.67*	\$98.67*
10	24010	\$219.89	\$263.55
12	24012	\$289.56	\$392.47
14	24014	CF	CF
16	24016	CF	CF
18	24018	CF	CF
20	24020	CF	CF
24	24024	CF	CF

Prices with asterisk (*) indicate molded item.

PVC IPS FITTINGS GASKETED PRESSURE: SDR26-SDR21

ELBOW

FEMALE X FEMALE

5 DEGREE



Size	PartNumber	SDR 26		SDR 21	
		(29)		(30)	
4	3004	\$154.73	\$190.41		
6	3006	\$214.90	\$235.32		
8	3008	\$315.17	\$379.73		
10	30010	\$458.24	\$659.15		
12	30012	\$652.51	\$907.90		
14	30014	CF	CF		
16	30016	CF	CF		
18	30018	CF	CF		
20	30020	CF	CF		
24	30024	CF	CF		

11-1/4 DEGREE



Size	PartNumber	SDR 26		SDR 21	
		(29)		(30)	
4	3104	\$107.44	\$132.23		
6	3106	\$149.17	\$163.36		
8	3108	\$218.66	\$263.55		
10	31010	\$310.86	\$457.46		
12	31012	\$452.93	\$630.04		
14	31014	CF	CF		
16	31016	CF	CF		
18	31018	CF	CF		
20	31020	CF	CF		
24	31024	CF	CF		

15 DEGREE

Size	PartNumber	SDR 26		SDR 21	
		(29)		(30)	
4	3204	\$107.44	\$132.23		
6	3206	\$149.17	\$163.36		
8	3208	\$218.66	\$263.55		
10	32010	\$310.86	\$457.46		
12	32012	\$452.93	\$630.04		
14	32014	CF	CF		
16	32016	CF	CF		
18	32018	CF	CF		
20	32020	CF	CF		
24	32024	CF	CF		

22-1/2 DEGREE



Size	PartNumber	SDR 26		SDR 21	
		(29)		(30)	
4	3304	\$107.44	\$132.23		
6	3306	\$149.17	\$163.36		
8	3308	\$218.66	\$263.55		
10	33010	\$310.86	\$457.46		
12	33012	\$452.93	\$630.04		
14	33014	CF	CF		
16	33016	CF	CF		
18	33018	CF	CF		
20	33020	CF	CF		
24	33024	CF	CF		

30 DEGREE

Size	PartNumber	SDR 26		SDR 21	
		(29)		(30)	
4	3404	\$133.60	\$140.09		
6	3406	\$198.58	\$243.14		
8	3408	\$292.27	\$361.94		
10	34010	\$485.25	\$604.20		
12	34012	\$642.11	\$758.18		
14	34014	CF	CF		
16	34016	CF	CF		
18	34018	CF	CF		
20	34020	CF	CF		
24	34024	CF	CF		

45 DEGREE

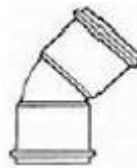

Size	PartNumber	SDR 26		SDR 21	
		(29)		(30)	
4	3504	\$45.80*	\$45.80*		
6	3506	\$84.08*	\$84.08*		
8	3508	\$163.98*	\$163.98*		
10	35010	\$485.25	\$604.20		
12	35012	\$642.11	\$758.18		
14	35014	CF	CF		
16	35016	CF	CF		
18	35018	CF	CF		
20	35020	CF	CF		
24	35024	CF	CF		

Prices with asterisk (*) indicate molded item.

ELBOW

FEMALE X FEMALE

60 DEGREE

Size	PartNumber	SDR 26	SDR 21
		(29)	(30)
4	3604	\$210.67	\$233.94
6	3606	\$310.86	\$326.58
8	3608	\$443.54	\$476.04
10	36010	\$642.11	\$784.19
12	36012	\$863.08	\$991.99
14	36014	CF	CF
16	36016	CF	CF
18	36018	CF	CF
20	36020	CF	CF
24	36024	CF	CF

90 DEGREE



Size	PartNumber	SDR 26	SDR 21
		(29)	(30)
4	3704	\$45.80*	\$45.80*
6	3706	\$84.08*	\$84.08*
8	3708	\$163.98*	\$163.98*
10	37010	\$925.27	\$1,129.82
12	37012	\$1035.72	\$1,429.35
14	37014	CF	CF
16	37016	CF	CF
18	37018	CF	CF
20	37020	CF	CF
24	37024	CF	CF

Prices with asterisk (*) indicate molded item.

FEMALE X MALE

5 DEGREE



Size	PartNumber	SDR 26	SDR 21
		(29)	(30)
4	3954	\$154.73	\$190.41
6	3956	\$214.90	\$235.32
8	3958	\$315.17	\$379.73
10	39510	\$447.89	\$659.15
12	39512	\$652.51	\$907.90
14	39514	CF	CF
16	39516	CF	CF
18	39518	CF	CF
20	39520	CF	CF
24	39524	CF	CF

11-1/4 DEGREE



Size	PartNumber	SDR 26	SDR 21
		(29)	(30)
4	4004	\$154.73	\$190.41
6	4006	\$214.90	\$235.32
8	4008	\$315.17	\$379.73
10	40010	\$447.89	\$659.15
12	40012	\$652.51	\$907.90
14	40014	CF	CF
16	40016	CF	CF
18	40018	CF	CF
20	40020	CF	CF
24	40024	CF	CF

15 DEGREE

Size	PartNumber	SDR 26	SDR 21
		(29)	(30)
4	4104	\$154.73	\$190.41
6	4106	\$214.90	\$235.32
8	4108	\$315.17	\$379.73
10	41010	\$447.89	\$659.15
12	41012	\$655.96	\$907.90
14	41014	CF	CF
16	41016	CF	CF
18	41018	CF	CF
20	41020	CF	CF
24	41024	CF	CF

22 1/2 DEGREE



Size	PartNumber	SDR 26	SDR 21
		(29)	(30)
4	4204	\$154.73	\$190.29
6	4206	\$214.90	\$235.32
8	4208	\$315.17	\$379.73
10	42010	\$447.89	\$659.15
12	42012	\$652.51	\$907.90
14	42014	CF	CF
16	42016	CF	CF
18	42018	CF	CF
20	42020	CF	CF
24	42024	CF	CF

PVC IPS FITTINGS GASKETED PRESSURE: SDR26-SDR21

ELBOW

FEMALE X MALE

30 DEGREE

Size	PartNumber	SDR 26	SDR 21
		(29)	(30)
4	4304	\$192.53	\$201.89
6	4306	\$286.14	\$350.29
8	4308	\$421.18	\$521.44
10	43010	\$699.28	\$870.49
12	43012	\$925.27	\$1,092.42
14	43014	CF	CF
16	43016	CF	CF
18	43018	CF	CF
20	43020	CF	CF
24	43024	CF	CF

45 DEGREE



Size	PartNumber	SDR 26	SDR 21
		(29)	(30)
4	4404	\$192.53	\$201.89
6	4406	\$286.14	\$350.29
8	4408	\$421.18	\$521.44
10	44010	\$699.28	\$868.40
12	44012	\$925.27	\$1,092.42
14	44014	CF	CF
16	44016	CF	CF
18	44018	CF	CF
20	44020	CF	CF
24	44024	CF	CF

60 DEGREE

Size	PartNumber	SDR 26	SDR 21
		(29)	(30)
4	4504	\$303.51	\$336.98
6	4506	\$447.89	\$470.65
8	4508	\$639.11	\$685.94
10	45010	\$925.27	\$1,129.82
12	45012	\$1,243.54	\$1,429.35
14	45014	CF	CF
16	45016	CF	CF
18	45018	CF	CF
20	45020	CF	CF
24	45024	CF	CF

90 DEGREE



Size	PartNumber	SDR 26	SDR 21
		(29)	(30)
4	4604	CF	CF
6	4606	\$447.89	\$470.65
8	4608	\$639.11	\$685.94
10	46010	\$925.27	\$1,129.82
12	46012	\$1,243.54	\$1,429.35
14	46014	CF	CF
16	46016	CF	CF
18	46018	CF	CF
20	46020	CF	CF
24	46024	CF	CF

REDUCER

CONCENTRIC

FEMALE X FEMALE

STYLE A

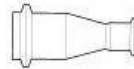

Size	PartNumber	SDR 26	SDR 21
		(29)	(30)
6x4	6006-4	\$125.27	\$137.38
8x6	6008-6	\$201.30	\$219.89
10x8	60010-8	\$287.74	\$420.42
12x10	60012-10	\$381.88	\$625.51

MALE X FEMALE

(SEB)



Size	PartNumber	SDR 26	SDR 21
		(29)	(30)
6x4	62064	\$75.80*	\$75.80*
8x4	62084	CF	CF
8x6	62086	\$128.67*	\$128.67*
10x4	620104	CF	CF
10x6	620106	\$301.52	\$382.20
10x8	620108	\$228.34	\$259.79
12x4	620124	CF	CF
12x6	620126	CF	CF
12x8	620128	\$426.87	\$452.18
12x10	6201210	\$369.35	\$416.66

Prices with asterisk (*) indicate molded item.

TEE

STRAIGHT

FEMALE X FEMALE X FEMALE



Size	PartNumber	SDR 26		SDR 21	
		(29)	(30)	(29)	(30)
6x4	82064	\$252.37	\$64.26*		
6	8206	\$292.27	\$141.34*		
8x4	82084	\$357.27	\$238.54*		
8x6	82086	\$397.15	\$244.15*		
8	8208	\$455.64	\$249.75*		
10x4	820104	\$560.51	\$571.55		
10x6	820106	\$594.83	\$620.82		
10x8	820108	\$665.40	\$699.71		
10	82010	\$747.02	\$876.98		
12x4	820124	\$711.80	\$744.28		
12x6	820126	\$777.68	\$823.17		
12x8	820128	\$852.04	\$900.09		
12x10	8201210	\$956.77	\$1,018.88		
12	82012	\$1,038.37	\$1,212.93		

Prices with asterisk (*) indicate molded item.

MALE X FEMALE X FIPT

Size	PartNumber	SDR 26		SDR 21	
		(29)	(30)	(29)	(30)
4x2	85042	CF	CF		
4x3	85043	\$161.54	\$196.77		
4	8504	\$199.63	\$210.51		
6x3	85063	\$249.65	\$264.47		
6x4	85064	\$257.06	\$275.66		
8x3	85083	\$311.78	\$371.16		
8x4	85084	\$331.26	\$380.52		
10x3	850103	\$521.53	\$579.09		
10x4	850104	\$550.25	\$602.23		
12x3	850123	\$674.62	\$734.92		
12x4	850124	\$708.93	\$770.29		

Larger and smaller sizes are available upon request. Please contact our factory at pvcsales@specfit.com or call (360)398-7700 for more information!

TAPPED

FEMALE X FEMALE X FIPT

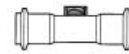

Size	PartNumber	SDR 26		SDR 21	
		(29)	(30)	(29)	(30)
4x1.5	84041.5	\$240.67	\$263.42		
4x2	84042	\$240.67	\$263.42		
4x2.5	84042.5	\$262.04	\$283.45		
4x3	84043	\$262.04	\$283.45		
6x1.5	84061.5	\$346.29	\$363.68		
6x2	84062	\$346.29	\$363.68		
6x2.5	84062.5	\$359.67	\$381.10		
6x3	84063	\$359.67	\$381.10		
6x4	84064	\$370.37	\$397.13		
8x1.5	84081.5	\$423.88	\$508.09		
8x2	84082	\$423.88	\$508.09		
8x2.5	84082.5	\$449.26	\$534.82		
8x3	84083	\$449.26	\$534.82		
8x4	84084	\$477.33	\$737.38		
10x2	840102	\$718.00	\$790.25		
10x2.5	840102.5	\$751.44	\$834.38		
10x3	840103	\$751.44	\$834.38		
10x4	840104	\$792.86	\$867.74		
12x2	840122	\$926.21	\$1,008.17		
12x2.5	840122.5	\$972.06	CF		
12x3	840123	\$972.06	\$1,058.98		
12x4	840124	\$1,021.51	\$1,109.80		

MALE X FEMALE X FEMALE

Size	PartNumber	SDR 26		SDR 21	
		(29)	(30)	(29)	(30)
4	8394	\$254.68	\$285.74		
6x4	83964	\$350.29	\$377.04		
6	8396	\$394.43	\$454.58		
8x4	83984	\$437.21	\$532.16		
8x6	83986	\$484.02	\$605.69		
8	8398	\$585.65	\$736.75		
10x4	839104	\$643.16	\$807.60		
10x6	839106	\$703.28	\$881.13		
10x8	839108	\$790.25	\$994.80		
10	83910	\$958.71	\$1,209.75		
12x4	839124	\$841.01	\$1,056.26		
12x6	839126	\$925.27	\$1,163.28		
12x8	839128	\$1,025.55	\$1,276.91		
12x10	8391210	\$1,160.60	\$1,445.38		
12	83912	\$1,361.11	CF		

PVC IPS FITTINGS GASKETED PRESSURE: SDR26-SDR21



C-900 Fittings

C-900 fittings through 60" are available from Specified Fittings and exclusively use the Reiber locked-in, steel backed gasket. These gaskets are generally of SBR composition but are also available in EPDM, FKM, Viton, Nitrile, and CR—to name a few. All these fittings can be manufactured to meet current AWWA C-900 specifications as well as the new upcoming AWWA standards. Remember large diameter PVC fittings are the best choice for all sewer and force main sewer applications. You do not have to coat PVC fittings; they are already noncorrosive. With C-900 fittings, we are nearing the universal PVC application for which the industry is looking. Specified

Fittings also makes manhole entry pieces 4" through 60" diameter for C-900. These fittings are coated on the exterior with a PVC silicate, giving a leak-free connection through the manhole wall. Cleanouts, female adapters, and threaded plugs are also available for 4" through 24" C-900. More of the diverse products we make in C-900 are: solvent weld fittings, and degree of elbow, deflection and repair couplings, adapter flanges in gasket and solvent weld ends, offsets, and one piece sweep bends in a myriad of radii and angles. If you need C-900, 4" through 60" fittings, please call us to get the information you need! ■

PVC FITTINGS

C-900 GASKETED PRESSURE



Specified Fittings



Specified Fittings

ADAPTER

GASKET X GASKET

CID x IPS

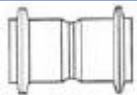

Size	PartNumber	DR 14 (49)	DR 18 (48)	DR21 (39PG)	DR 25 (47)	DR 41 (46)	DR 51 (45)	DR81 (12PC)
4	1054-IPS	\$193.88	\$155.00	\$147.26	\$139.90	CF	CF	CF
6	1056-IPS	\$227.95	\$182.36	\$173.25	\$164.59	CF	CF	CF
8	1058	\$427.62	\$342.09	\$324.99	\$308.75	CF	CF	CF
10	10510	\$478.77	\$383.01	\$363.86	\$345.68	CF	CF	CF
12	10512	\$677.97	\$542.37	\$515.26	\$489.50	CF	CF	CF
14	10514	\$1,347.44	\$1,077.95	\$1,024.06	\$972.87	\$924.23	\$878.03	\$834.13
16	10516	\$1,653.48	\$1,322.79	\$1,256.65	\$1,193.83	\$1,134.13	\$1,077.42	\$1,023.56
18	10518	\$3,306.38	\$2,645.09	\$2,512.84	\$2,387.20	\$2,267.85	\$2,154.46	\$2,046.74
20	10520	\$3,681.02	\$2,944.82	\$2,797.58	\$2,657.71	\$2,524.83	\$2,398.59	\$2,278.67
24	10524	\$5,197.39	\$4,157.91	\$3,950.02	\$3,752.53	\$3,564.91	\$3,386.67	\$3,217.34

MALE X GASKET

CID x IPS

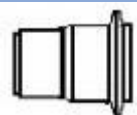

Size	PartNumber	DR 14 (49)	DR 18 (48)	DR21 (39PG)	DR 25 (47)	DR 41 (46)	DR 51 (45)	DR81 (12PC)
4	1714	\$164.69	\$131.74	\$125.17	\$118.91	CF	CF	CF
6	1716	\$193.75	\$155.00	\$147.26	\$139.90	CF	CF	CF
8	1718	\$235.85	\$188.68	\$179.25	\$170.29	CF	CF	CF
10	17110	\$347.55	\$278.04	\$264.14	\$250.94	CF	CF	CF
12	17112	\$542.12	\$433.69	\$412.01	\$391.41	CF	CF	CF
14	17114	\$966.02	\$772.81	\$734.17	\$697.46	\$662.60	\$629.48	\$598.01
16	17116	\$1,381.37	\$1,105.09	\$1,049.85	\$997.36	\$947.50	\$900.13	\$855.13
18	17118	\$2,810.40	\$2,248.32	\$2,135.91	\$2,029.12	\$1,927.66	\$1,831.28	\$1,739.72
20	17120	\$3,128.87	\$2,503.09	\$2,377.95	\$2,259.06	\$2,146.12	\$2,038.82	\$1,936.89
24	17124	\$4,417.77	\$3,534.21	\$3,357.51	\$3,189.64	\$3,030.17	\$2,878.67	\$2,734.75

COUPLING

GASKET X GASKET

REPAIR

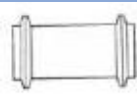

Size	PartNumber	DR 14 (49)	DR 18 (48)	DR21 (39PG)	DR 25 (47)	DR 41 (46)	DR 51 (45)	DR81 (12PC)
4	2204	\$174.09	\$139.27	\$135.79	\$132.31	CF	CF	CF
6	2206	\$217.60	\$174.08	\$169.73	\$165.37	CF	CF	CF
8	2208	\$296.23	\$383.67	\$206.61	\$201.31	CF	CF	CF
10	22010	\$452.02	\$403.44	\$383.27	\$364.11	CF	CF	CF
12	22012	\$660.28	\$589.29	\$559.83	\$531.84	CF	CF	CF
14	22014	\$1,632.09	\$975.15	\$899.83	\$824.49	\$783.28	\$744.12	\$706.92
16	22016	\$1,947.63	\$1,163.67	\$1,067.84	\$971.99	\$923.39	\$877.23	\$833.37
18	22018	\$3,877.94	\$3,102.34	\$2,750.47	\$2,398.57	\$2,278.64	\$2,164.71	\$2,056.49
20	22020	CF	\$3,481.69	\$3,075.91	\$2,670.10	\$2,536.60	\$2,409.78	\$2,289.29
24	22024	CF	\$4,393.99	\$4,082.25	\$3,770.48	\$3,581.96	\$3,402.87	\$3,232.73
30	22030	CF	\$5,844.00	\$5,255.74	\$4,667.46	\$4,434.09	\$4,212.39	\$4,001.78
36	22036	CF	\$7,449.26	\$6,525.11	\$5,600.95	\$5,320.91	\$5,054.87	\$4,802.14
42	22042	CF	\$9,311.58	\$8,380.43	\$7,449.26	\$7,076.80	\$6,722.97	\$6,386.82
48	22048	CF	\$11,639.47	\$10,773.50	\$9,907.51	\$9,412.14	\$8,941.54	\$8,494.46

C-900 GASKETED PRESSURE

COUPLING

GASKET X GASKET

DEFLECTION

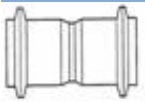

Size	PartNumber	DR 14 (49)	DR 18 (48)	DR21 (39PG)	DR 25 (47)	DR 41 (46)	DR 51 (45)	DR81 (12PC)
4	2104	\$56.60	NA	NA	NA	NA	NA	NA
6	2106	\$86.76	NA	NA	NA	NA	NA	NA
8	2108	\$207.51	NA	NA	NA	NA	NA	NA
10	21010	\$521.42	NA	NA	NA	NA	NA	NA
12	21012	\$584.56	NA	NA	NA	NA	NA	NA

STOP

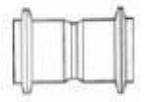

Size	PartNumber	DR 14 (49)	DR 18 (48)	DR21 (39PG)	DR 25 (47)	DR 41 (46)	DR 51 (45)	DR81 (12PC)
4	2404	\$165.80	\$90.24	\$129.32	\$125.99	\$119.70	\$113.72	\$108.04
6	2406	\$207.24	\$138.33	\$161.64	\$157.49	\$149.63	\$142.15	\$135.04
8	2408	\$330.81	\$252.28	\$196.78	\$191.73	\$182.15	\$173.05	\$164.40
10	24010	\$403.44	\$352.87	\$383.27	\$364.11	\$345.91	\$328.61	\$312.18
12	24012	\$579.81	\$463.84	\$452.25	\$440.65	\$418.62	\$397.69	\$377.81
14	24014	\$1,218.95	\$975.15	\$880.20	\$785.22	\$745.97	\$708.68	\$673.24
16	24016	\$1,454.60	\$1,163.67	\$1,044.69	\$925.69	\$879.42	\$835.45	\$793.68
18	24018	\$3,877.94	\$3,102.34	\$2,693.38	\$2,284.41	\$2,170.19	\$2,061.69	\$1,959.76
20	24020	\$4,352.13	\$3,481.69	\$3,012.48	\$2,543.25	\$2,416.09	\$2,295.30	\$2,180.54
24	24024	\$5,492.49	\$4,393.99	\$3,992.47	\$3,590.93	\$3,411.39	\$3,240.83	\$3,078.79
30	24030	CF	CF	CF	\$4,445.19	\$4,222.94	\$4,011.80	\$3,811.22
36	24036	CF	CF	CF	\$5,343.07	\$5,075.93	\$4,822.13	\$4,581.04
42	24042	CF	CF	CF	\$8,152.91	\$7,745.27	\$7,358.01	\$6,990.11
48	24048	CF	CF	CF	\$10,191.14	\$9,681.59	\$9,197.52	\$8,737.64

PLUG

MALE

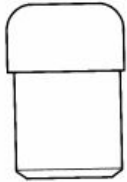

Size	PartNumber	DR 14 (49)	DR 18 (48)	DR21 (39PG)	DR 25 (47)	DR 41 (46)	DR 51 (45)	DR81 (12PC)
4	5604	\$109.23	\$89.99	\$72.82	CF	CF	CF	CF
6	5606	\$196.87	\$162.15	\$131.24	CF	CF	CF	CF
8	5608	\$334.56	\$275.49	\$223.03	CF	CF	CF	CF
10	56010	\$980.06	\$653.37	\$653.37	CF	CF	CF	CF
12	56012	\$1,389.09	\$926.05	\$926.05	CF	CF	CF	CF
14	56014	\$1,501.43	\$1,000.95	\$1,000.95	\$1,000.35	\$950.34	\$902.83	\$857.69
16	56016	\$1,634.18	\$1,089.45	\$1,089.45	\$1,089.26	\$1,034.80	\$983.07	\$933.92
18	56018	\$2,873.07	\$1,915.37	\$1,915.37	\$1,914.64	\$1,818.91	\$1,727.97	\$1,641.58
20	56020	CF	\$2,228.14	\$2,228.14	\$2,227.57	\$2,116.20	\$2,010.40	\$1,909.89
24	56024	CF	\$2,829.79	\$2,829.79	\$2,830.41	\$2,688.90	\$2,554.46	\$2,426.74
30	56030	CF	\$3,503.75	\$3,503.75	\$3,503.75	\$3,328.57	\$3,162.14	\$3,004.04
36	56036	CF	\$4,206.85	\$4,206.85	\$4,204.55	\$3,994.33	\$3,794.62	\$3,604.89
42	56042	CF	\$5,595.11	\$5,595.11	\$5,595.11	\$5,315.36	\$5,049.59	\$4,797.12
48	56048	CF	\$7,441.50	\$7,441.50	\$7,441.50	\$7,069.43	\$6,715.97	\$6,380.18

* Caps 30" and above are rated for 15 PSI unless fully encased in concrete. When encased in concrete they can be fully rated.

CAP

GASKETED BELL



Size	PartNumber	DR 14 (49)	DR 18 (48)	DR21 (39PG)	DR 25 (47)	DR 41 (46)	DR 51 (45)	DR81 (12PC)
4	1904	\$96.85	\$90.00	\$72.82	\$72.82	CF	CF	CF
6	1906	\$174.55	\$162.16	\$131.24	\$131.24	CF	CF	CF
8	1908	\$731.30	\$275.54	\$223.03	\$223.03	CF	CF	CF
10	19010	\$1,011.87	\$695.06	\$677.70	\$660.31	CF	CF	CF
12	19012	\$1,210.75	\$974.99	\$950.62	\$926.24	CF	CF	CF
14	19014	\$1,307.64	\$1,053.00	\$1,026.69	\$1,000.35	\$950.34	\$902.83	\$857.69
16	19016	\$1,423.85	\$1,146.58	\$1,117.93	\$1,089.26	\$1,034.80	\$983.07	\$933.92
18	19018	\$2,680.50	\$2,015.41	\$1,965.03	\$1,914.64	\$1,818.91	\$1,727.97	\$1,641.58
20	19020	CF	\$2,344.82	\$2,286.20	\$2,227.57	\$2,116.20	\$2,010.40	\$1,909.89
24	19024	CF	\$2,979.39	\$2,904.90	\$2,830.41	\$2,688.90	\$2,554.46	\$2,426.74
30*	19030	CF	\$3,962.58	\$3,733.18	\$3,503.75	\$3,328.57	\$3,162.14	\$3,004.04
36*	19036	CF	\$5,270.23	\$4,737.40	\$4,204.55	\$3,994.33	\$3,794.62	\$3,604.89
42*	19042	CF	\$7,009.41	\$6,834.19	\$6,658.94	\$6,326.00	\$6,009.70	\$5,709.22
48*	19048	CF	\$9,322.51	\$9,089.45	\$8,856.38	\$8,413.57	\$7,992.90	\$7,593.27

* Caps 30" and above are rated for 15 PSI unless fully encased in concrete. When encased in concrete they can be fully rated.

TAPPED

2" FIPT

Size	PartNumber	DR 14 (49)	DR 18 (48)	DR21 (39PG)	DR 25 (47)	DR 41 (46)	DR 51 (45)	DR81 (12PC)
4	1994	\$135.60	\$101.95	\$101.95	\$101.95	CF	CF	CF
6	1996	\$244.38	\$183.74	\$183.74	\$183.74	CF	CF	CF
8	1998	\$1,023.82	\$312.25	\$312.25	\$312.25	CF	CF	CF
10	19910	\$1,416.63	\$973.10	\$948.78	\$924.44	CF	CF	CF
12	19912	\$1,695.07	\$1,364.99	\$1,330.88	\$1,296.75	CF	CF	CF
14	19914	\$1,830.71	\$1,474.21	\$1,437.36	\$1,400.49	\$1,330.48	\$1,263.97	\$1,200.77
16	19916	\$1,993.40	\$1,605.23	\$1,565.10	\$1,524.97	\$1,448.74	\$1,376.30	\$1,307.49
18	19918	\$3,752.70	\$2,821.58	\$2,751.04	\$2,680.50	\$2,546.48	\$2,419.16	\$2,298.22
20	19920	CF	\$3,282.74	\$3,200.69	\$3,118.60	\$2,962.68	\$2,814.56	\$2,673.84
24	19924	CF	\$4,171.14	\$4,066.87	\$3,962.59	\$3,764.46	\$3,576.25	\$3,397.45
30*	19930	CF	\$5,547.61	\$5,226.45	\$4,905.26	\$4,660.01	\$4,427.01	\$4,253.84
36*	19936	CF	\$7,378.33	\$6,632.37	\$5,886.38	\$5,592.07	\$5,312.47	\$5,046.86
42*	19942	CF	\$9,813.18	\$9,567.86	\$9,322.52	\$8,856.40	\$8,413.60	\$7,992.91
48*	19948	CF	\$13,051.52	\$12,725.23	\$12,398.94	\$11,779.01	\$11,190.08	\$10,630.58

* Caps 30" and above are rated for 15 PSI unless fully encased in concrete. When encased in concrete they can be fully rated.

ELBOW

GASKET X GASKET

5 DEGREE



Size	PartNumber	DR 14 (49)	DR 18 (48)	DR21 (39PG)	DR 25 (47)	DR 41 (46)	DR 51 (45)	DR81 (12PC)
4	3004	\$166.36	\$133.08	\$133.08	\$133.08	CF	CF	CF
6	3006	\$296.55	\$237.23	\$231.31	\$225.38	CF	CF	CF
8	3008	\$479.90	\$304.47	\$296.87	\$289.25	CF	CF	CF
10	30010	\$732.30	\$429.71	\$420.05	\$410.38	CF	CF	CF
12	30012	\$954.37	\$653.52	\$638.83	\$624.12	CF	CF	CF
14	30014	\$2,009.95	\$1,200.90	\$1,173.89	\$1,146.86	\$1,089.52	\$1,035.05	\$983.30
16	30016	\$2,442.31	\$1,459.24	\$1,426.41	\$1,393.57	\$1,323.90	\$1,257.71	\$1,194.83
18	30018	\$3,203.00	\$2,562.40	\$2,504.75	\$2,447.09	\$2,324.74	\$2,208.51	\$2,098.08
20	30020	CF	\$3,181.45	\$3,109.88	\$3,038.29	\$2,886.39	\$2,742.07	\$2,604.97
24	30024	CF	\$4,501.04	\$4,399.77	\$4,298.49	\$4,083.57	\$3,879.40	\$3,685.44
30	30030	CF	\$7,136.38	\$7,028.62	\$6,920.83	\$6,574.79	\$6,246.05	\$5,933.76
36	30036	CF	\$9,315.18	\$8,809.72	\$8,304.25	\$7,889.05	\$7,494.60	\$7,119.87
42	30042	CF	\$12,388.95	\$11,716.81	\$11,044.66	\$10,492.43	\$9,967.81	\$9,469.42
48	30048	CF	\$16,477.32	\$16,065.39	\$15,653.44	\$14,870.78	\$14,127.24	\$13,420.89

C-900 GASKETED PRESSURE

ELBOW

GASKET X GASKET

11-1/4 DEGREE



Size	PartNumber	DR 14 (49)	DR 18 (48)	DR21 (39PG)	DR 25 (47)	DR 41 (46)	DR 51 (45)	DR81 (12PC)
4	3104	\$166.36	\$164.77	\$133.08	\$133.08	CF	CF	CF
6	3106	\$296.55	\$290.52	\$231.31	\$225.38	CF	CF	CF
8	3108	\$479.90	\$553.25	\$296.87	\$289.25	CF	CF	CF
10	31010	\$732.30	\$429.71	\$420.05	\$410.38	CF	CF	CF
12	31012	\$954.37	\$653.52	\$638.83	\$624.12	CF	CF	CF
14	31014	\$2,009.95	\$1,200.90	\$1,173.89	\$1,146.86	\$1,089.52	\$1,035.05	\$983.30
16	31016	\$2,442.31	\$1,459.24	\$1,426.41	\$1,393.57	\$1,323.90	\$1,257.71	\$1,194.83
18	31018	\$3,203.00	\$2,562.40	\$2,504.75	\$2,447.09	\$2,324.74	\$2,208.51	\$2,098.08
20	31020	CF	\$3,181.45	\$3,109.88	\$3,038.29	\$2,886.39	\$2,742.07	\$2,604.97
24	31024	CF	\$4,501.04	\$4,399.77	\$4,298.49	\$4,083.57	\$3,879.38	\$3,685.42
30	31030	CF	\$7,136.38	\$7,028.62	\$6,920.83	\$6,574.79	\$6,246.05	\$5,933.76
36	31036	CF	\$9,315.12	\$8,809.69	\$8,304.25	\$7,889.05	\$7,494.60	\$7,119.87
42	31042	CF	\$12,388.95	\$11,716.81	\$11,044.66	\$10,492.43	\$9,967.81	\$9,469.42
48	31048	CF	\$16,477.32	\$16,065.39	\$15,653.44	\$14,870.78	\$14,127.24	\$13,420.89

22-1/2 DEGREE



Size	PartNumber	DR 14 (49)	DR 18 (48)	DR21 (39PG)	DR 25 (47)	DR 41 (46)	DR 51 (45)	DR81 (12PC)
4	3304	\$166.36	\$164.77	\$133.08	\$133.08	CF	CF	CF
6	3306	\$296.55	\$290.52	\$231.31	\$225.38	CF	CF	CF
8	3308	\$479.90	\$553.25	\$296.87	\$289.25	CF	CF	CF
10	33010	\$732.30	\$429.71	\$420.05	\$410.38	CF	CF	CF
12	33012	\$954.37	\$653.52	\$638.83	\$624.12	CF	CF	CF
14	33014	\$2,009.95	\$1,200.90	\$1,173.89	\$1,146.86	\$1,089.52	\$1,035.05	\$983.30
16	33016	\$2,442.31	\$1,459.24	\$1,426.41	\$1,393.57	\$1,323.90	\$1,257.71	\$1,194.83
18	33018	\$3,203.00	\$2,562.40	\$2,530.62	\$2,498.84	\$2,324.74	\$2,255.21	\$2,142.45
20	33020	CF	\$3,181.45	\$3,109.88	\$3,038.29	\$2,886.39	\$2,742.07	\$2,604.97
24	33024	CF	\$4,501.04	\$4,399.77	\$4,298.49	\$4,083.57	\$3,879.40	\$3,685.44
30	33030	CF	\$7,136.38	\$7,028.62	\$6,920.83	\$6,574.79	\$6,246.05	\$5,933.76
36	33036	CF	\$9,315.12	\$8,809.69	\$8,304.25	\$7,889.05	\$7,494.60	\$7,119.87
42	33042	CF	\$12,388.95	\$11,716.81	\$11,044.66	\$10,492.43	\$9,967.81	\$9,469.42
48	33048	CF	\$16,477.32	\$16,065.39	\$15,653.44	\$14,870.78	\$14,127.24	\$13,420.89

45 DEGREE

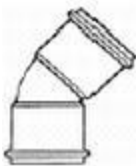

Size	PartNumber	DR 14 (49)	DR 18 (48)	DR21 (39PG)	DR 25 (47)	DR 41 (46)	DR 51 (45)	DR81 (12PC)
4	3504	\$167.47	\$166.36	\$133.08	\$133.08	CF	CF	CF
6	3506	\$296.55	\$290.52	\$231.31	\$225.38	CF	CF	CF
8	3508	\$479.90	\$429.71	\$296.87	\$289.25	CF	CF	CF
10	35010	\$732.30	\$553.25	\$420.05	\$410.38	CF	CF	CF
12	35012	\$954.37	\$653.52	\$638.83	\$624.12	CF	CF	CF
14	35014	\$2,009.95	\$1,200.90	\$1,173.89	\$1,146.86	\$1,089.52	\$1,035.05	\$983.30
16	35016	\$2,442.31	\$1,459.24	\$1,426.47	\$1,393.57	\$1,323.90	\$1,257.71	\$1,194.83
18	35018	\$3,203.00	\$2,562.40	\$2,465.97	\$2,369.52	\$2,373.90	\$2,138.49	\$2,031.58
20	35020	CF	\$3,181.45	\$3,109.88	\$3,038.29	\$2,886.39	\$2,742.07	\$2,604.97
24	35024	CF	\$4,501.04	\$4,399.77	\$4,298.49	\$4,083.57	\$3,879.40	\$3,685.44
30	35030	CF	\$7,136.38	\$7,028.62	\$6,920.83	\$6,574.79	\$6,246.05	\$5,933.76
36	35036	CF	\$9,315.12	\$8,809.69	\$8,304.25	\$7,889.05	\$7,494.60	\$7,119.87
42	35042	CF	\$12,388.95	\$11,716.81	\$11,044.66	\$10,492.43	\$9,967.81	\$9,469.42
48	35048	CF	\$16,477.32	\$16,065.39	\$15,653.44	\$14,870.78	\$14,127.24	\$13,420.89

90 DEGREE

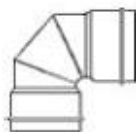
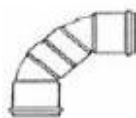

Size	PartNumber	DR 14 (49)	DR 18 (48)	DR21 (39PG)	DR 25 (47)	DR 41 (46)	DR 51 (45)	DR81 (12PC)
4	3704	\$169.44	\$167.47	\$135.55	\$135.55	CF	CF	CF
6	3706	\$529.00	\$298.29	\$412.63	\$402.04	CF	CF	CF
8	3708	\$856.07	\$576.59	\$491.07	\$479.76	CF	CF	CF
10	37010	\$1,306.40	\$806.89	\$788.74	\$770.58	CF	CF	CF
12	37012	\$1,723.05	\$1,137.59	\$1,112.00	\$1,086.41	CF	CF	CF
14	37014	\$2,543.59	\$1,634.85	\$1,598.07	\$1,561.29	\$1,089.52	\$1,409.07	\$1,338.62
16	37016	\$3,034.36	\$1,927.99	\$1,884.62	\$1,841.23	\$1,323.90	\$1,661.72	\$1,578.64
18	37018	\$4,319.64	\$3,455.70	\$3,377.96	\$3,300.20	\$2,251.04	\$2,978.44	\$2,829.53
20	37020	CF	\$4,224.64	\$4,129.59	\$4,034.53	\$2,886.39	\$3,641.18	\$3,459.12
24	37024	CF	\$7,072.91	\$6,913.78	\$6,754.63	\$4,083.57	\$6,096.07	\$5,791.27
30	37030	CF	\$10,351.16	\$10,298.88	\$10,246.58	\$6,574.79	\$9,247.55	\$8,785.18
36	37036	CF	\$13,767.04	\$13,031.48	\$12,295.89	\$7,889.05	\$11,097.05	\$10,542.20
42	37042	CF	\$18,310.16	\$17,331.86	\$16,353.54	\$10,492.43	\$14,759.08	\$14,021.13
48	37048	CF	\$24,352.52	\$23,051.37	\$21,750.21	\$14,870.78	\$19,629.58	\$18,648.11

C-900 GASKETED PRESSURE

GASKET X MALE

5 DEGREE



Size	PartNumber	DR 14 (49)	DR 18 (48)	DR21 (39PG)	DR 25 (47)	DR 41 (46)	DR 51 (45)	DR81 (12PC)
4	3954	\$260.97	\$208.77	\$203.55	\$198.33	CF	CF	CF
6	3956	\$296.55	\$260.96	\$254.45	\$247.92	CF	CF	CF
8	3958	\$469.68	\$334.93	\$326.55	\$318.17	CF	CF	CF
10	39510	\$716.75	\$468.48	\$456.77	\$445.05	CF	CF	CF
12	39512	\$907.57	\$686.19	\$670.76	\$655.32	CF	CF	CF
14	39514	\$1,930.39	\$1,272.35	\$1,243.73	\$1,215.09	\$1,154.35	\$1,096.64	\$1,041.82
16	39516	\$2,419.82	\$1,594.91	\$1,559.03	\$1,523.14	\$1,446.99	\$1,374.64	\$1,305.92
18	39518	\$3,203.00	\$2,920.51	\$2,854.81	\$2,789.08	\$2,649.63	\$2,517.15	\$2,391.30
20	39520	CF	\$3,406.47	\$3,324.18	\$3,241.87	\$3,079.78	\$2,925.80	\$2,779.48
24	39524	CF	\$5,147.66	\$4,698.93	\$4,578.44	\$4,349.52	\$4,132.05	\$3,925.46
30	39530	CF	\$6,409.81	\$6,249.57	\$6,089.32	\$5,784.86	\$5,495.62	\$5,220.85
36	39536	CF	\$8,525.05	\$8,311.94	\$8,098.81	\$7,693.87	\$7,309.18	\$6,943.72
42	39542	CF	\$11,338.32	\$11,054.87	\$10,771.41	\$10,232.84	\$9,721.20	\$9,235.14
48	39548	CF	\$15,079.97	\$14,702.97	\$14,325.98	\$13,609.69	\$12,929.21	\$12,282.76

11-1/4 DEGREE

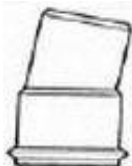

Size	PartNumber	DR 14 (49)	DR 18 (48)	DR21 (39PG)	DR 25 (47)	DR 41 (46)	DR 51 (45)	DR81 (12PC)
4	4004	\$260.97	\$208.77	\$203.55	\$198.33	CF	CF	CF
6	4006	\$296.55	\$260.96	\$254.45	\$247.92	CF	CF	CF
8	4008	\$469.68	\$334.93	\$326.55	\$318.17	CF	CF	CF
10	40010	\$716.75	\$468.48	\$456.77	\$445.05	CF	CF	CF
12	40012	\$907.57	\$686.19	\$670.76	\$655.32	CF	CF	CF
14	40014	\$1,930.39	\$1,272.35	\$1,243.73	\$1,215.09	\$1,154.35	\$1,096.64	\$1,041.82
16	40016	\$2,419.82	\$1,594.91	\$1,559.03	\$1,523.14	\$1,446.99	\$1,374.64	\$1,305.92
18	40018	\$3,203.00	\$2,920.51	\$2,854.81	\$2,789.08	\$2,649.63	\$2,517.15	\$2,391.30
20	40020	CF	\$3,406.47	\$3,324.18	\$3,241.87	\$3,079.78	\$2,925.80	\$2,779.52
24	40024	CF	\$5,147.66	\$4,698.93	\$4,578.44	\$4,349.52	\$4,132.05	\$3,925.46
30	40030	CF	\$6,409.81	\$6,249.57	\$6,089.32	\$5,784.86	\$5,495.62	\$5,220.85
36	40036	CF	\$8,525.05	\$8,311.94	\$8,098.81	\$7,693.87	\$7,309.18	\$6,943.72
42	40042	CF	\$11,338.32	\$11,054.87	\$10,771.41	\$10,232.84	\$9,721.20	\$9,235.14
48	40048	CF	\$15,079.97	\$14,702.97	\$14,325.98	\$13,609.69	\$12,929.21	\$12,282.76

22-1/2 DEGREE



Size	PartNumber	DR 14 (49)	DR 18 (48)	DR21 (39PG)	DR 25 (47)	DR 41 (46)	DR 51 (45)	DR81 (12PC)
4	4204	\$260.97	\$208.77	\$203.55	\$198.33	CF	CF	CF
6	4206	\$296.55	\$260.96	\$254.45	\$247.92	CF	CF	CF
8	4208	\$469.68	\$334.93	\$326.55	\$318.17	CF	CF	CF
10	42010	\$716.75	\$468.48	\$456.77	\$445.05	CF	CF	CF
12	42012	\$907.57	\$686.19	\$670.76	\$655.32	CF	CF	CF
14	42014	\$1,930.39	\$1,272.35	\$1,243.73	\$1,215.09	\$1,154.35	\$1,096.64	\$1,041.82
16	42016	\$2,419.82	\$1,594.91	\$1,559.03	\$1,523.14	\$1,446.99	\$1,374.64	\$1,305.92
18	42018	\$3,203.00	\$2,920.51	\$2,854.81	\$2,789.08	\$2,649.63	\$2,517.15	\$2,391.30
20	42020	CF	\$3,406.47	\$3,324.18	\$3,241.87	\$3,079.78	\$2,925.80	\$2,779.52
24	42024	CF	\$5,147.66	\$4,698.93	\$4,578.44	\$4,349.52	\$4,132.05	\$3,925.46
30	42030	CF	\$6,409.81	\$6,249.57	\$6,089.32	\$5,784.86	\$5,495.62	\$5,220.85
36	42036	CF	\$8,525.05	\$8,311.94	\$8,098.81	\$7,693.87	\$7,309.18	\$6,943.72
42	42042	CF	\$11,338.32	\$11,054.87	\$10,771.41	\$10,232.84	\$9,721.20	\$9,235.14
48	42048	CF	\$15,079.97	\$14,702.97	\$14,325.98	\$13,609.69	\$12,929.21	\$12,282.76

C-900 GASKETED PRESSURE

ELBOW

GASKET X MALE

45 DEGREE

Size	PartNumber	DR 14	DR 18	DR21	DR 25	DR 41	DR 51	DR81
		(49)	(48)	(39PG)	(47)	(46)	(45)	(12PC)
4	4404	\$260.97	\$208.77	\$203.55	\$198.33	CF	CF	CF
6	4406	\$296.55	\$260.96	\$254.45	\$247.92	CF	CF	CF
8	4408	\$469.68	\$334.93	\$326.55	\$318.17	CF	CF	CF
10	44010	\$716.75	\$468.48	\$456.77	\$445.05	CF	CF	CF
12	44012	\$907.57	\$686.19	\$670.76	\$655.32	CF	CF	CF
14	44014	\$1,930.39	\$1,272.35	\$1,243.73	\$1,215.09	\$1,154.35	\$1,096.64	\$1,041.82
16	44016	\$2,419.82	\$1,594.91	\$1,559.03	\$1,523.14	\$1,446.99	\$1,374.64	\$1,305.92
18	44018	\$3,203.00	\$2,920.51	\$2,854.81	\$2,789.08	\$2,649.63	\$2,517.15	\$2,391.30
20	44020	CF	\$3,406.47	\$3,324.18	\$3,241.87	\$3,079.78	\$2,925.80	\$2,779.52
24	44024	CF	\$5,147.66	\$4,698.93	\$4,578.44	\$4,349.52	\$4,132.05	\$3,925.46
30	44030	CF	\$6,409.81	\$6,249.57	\$6,089.32	\$5,784.86	\$5,495.62	\$5,220.85
36	44036	CF	\$8,525.05	\$8,311.94	\$8,098.81	\$7,693.87	\$7,309.18	\$6,943.72
42	44042	CF	\$11,338.32	\$11,054.87	\$10,771.41	\$10,232.84	\$9,721.20	\$9,235.14
48	44048	CF	\$15,079.97	\$14,702.97	\$14,325.98	\$13,609.69	\$12,929.21	\$12,282.76

90 DEGREE

Size	PartNumber	DR 14	DR 18	DR21	DR 25	DR 41	DR 51	DR81
		(49)	(48)	(39PG)	(47)	(46)	(45)	(12PC)
4	4604	\$465.53	\$372.42	\$363.11	\$353.80	CF	CF	CF
6	4606	\$529.00	\$465.52	\$412.63	\$402.04	CF	CF	CF
8	4608	\$856.07	\$552.60	\$491.07	\$479.76	CF	CF	CF
10	46010	\$1,306.40	\$887.57	\$788.74	\$770.58	CF	CF	CF
12	46012	\$1,723.05	\$1,251.35	\$1,112.00	\$1,086.41	CF	CF	CF
14	46014	\$2,543.59	\$1,798.34	\$1,598.07	\$1,561.29	\$1,483.22	\$1,409.07	\$1,338.62
16	46016	\$3,034.36	\$2,120.78	\$1,884.62	\$1,841.23	\$1,749.17	\$1,661.72	\$1,578.64
18	46018	\$4,319.64	\$3,801.28	\$3,377.96	\$3,300.20	\$3,135.20	\$2,978.44	\$2,829.53
20	46020	CF	\$4,647.10	\$4,129.59	\$4,034.53	\$3,832.81	\$3,641.18	\$3,459.12
24	46024	CF	\$7,780.21	\$6,913.78	\$6,754.63	\$6,416.91	\$6,096.07	\$5,791.27
30	46030	CF	\$11,501.29	\$10,926.23	\$10,379.92	\$9,860.93	\$9,367.88	\$8,899.48
36	46036	CF	\$15,296.71	\$14,531.88	\$13,805.29	\$13,115.03	\$12,459.27	\$11,836.31
42	46042	CF	\$20,344.63	\$19,327.41	\$18,361.03	\$17,442.98	\$16,570.83	\$15,742.29
48	46048	CF	\$27,058.35	\$25,705.44	\$24,420.17	\$23,199.16	\$22,039.20	\$20,937.25

C-900 GASKETED PRESSURE

FLANGE VAN STONE

GASKETED BELL

FLANGE X FEMALE (IPS x CID)

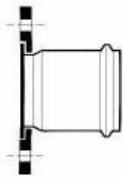

Size	PartNumber	DR 14 (49)	DR 18 (48)	DR21 (39PG)	DR 25 (47)	DR 41 (46)	DR 51 (45)	DR81 (12PC)
4	5304	\$139.36	\$104.78	\$104.78	\$104.78	CF	CF	CF
6	5306	\$184.30	\$147.43	\$147.43	\$147.43	CF	CF	CF
8	5308	\$278.40	\$222.72	\$222.72	\$222.72	CF	CF	CF
10	53010	\$373.27	\$298.61	\$298.61	\$298.61	CF	CF	CF
12	53012	\$594.69	\$475.74	\$475.74	\$475.74	CF	CF	CF
14	53014	\$1,710.07	\$1,368.05	\$1,368.05	\$1,368.05	\$1,368.05	\$1,368.05	\$1,368.05
16	53016	\$2,326.09	\$1,860.87	\$1,860.87	\$1,860.87	\$1,860.87	\$1,860.87	\$1,860.87
18	53018	\$2,852.36	\$2,281.88	\$2,281.88	\$2,281.88	\$2,281.88	\$2,281.88	\$2,281.88
20	53020	CF	\$2,718.22	\$2,718.22	\$2,718.22	\$2,718.22	\$2,718.22	\$2,718.22
24	53024	CF	\$3,694.15	\$3,694.15	\$3,694.15	\$3,694.15	\$3,694.15	\$3,694.15
30	53030	CF	\$7,500.79	\$7,125.75	\$6,769.47	\$6,430.99	\$6,109.44	\$5,803.97
36	53036	CF	\$7,748.77	\$7,361.33	\$6,993.26	\$6,643.60	\$6,311.42	\$5,995.85
42	53042	CF	\$10,331.69	\$9,815.11	\$9,324.35	\$8,858.13	\$8,415.23	\$7,994.47
48	53048	CF	\$17,003.24	\$16,153.08	\$15,345.43	\$14,578.16	\$13,849.25	\$13,156.79

FLANGE X MALE (IPS x CID)



Size	PartNumber	DR 14 (49)	DR 18 (48)	DR21 (39PG)	DR 25 (47)	DR 41 (46)	DR 51 (45)	DR81 (12PC)
4	5204	CF	\$99.03	CF	CF	CF	CF	CF
6	5206	CF	\$135.93	CF	CF	CF	CF	CF
8	5208	CF	\$208.75	CF	CF	CF	CF	CF
10	52010	CF	\$274.40	CF	CF	CF	CF	CF
12	52012	CF	\$443.79	CF	CF	CF	CF	CF
14	52014	CF	\$1,308.65	CF	CF	CF	CF	CF
16	52016	CF	\$1,774.62	CF	CF	CF	CF	CF
18	52018	CF	\$2,112.54	CF	CF	CF	CF	CF
20	52020	CF	\$2,527.49	CF	CF	CF	CF	CF
24	52024	CF	\$3,398.14	CF	CF	CF	CF	CF



► “Whisper phones” were built for a class of Pre-K and Kindergarteners. They allow the children to hear their own speech while reading aloud, which helps them to enunciate more clearly.

◀ Need to impress your mother-in-law? We build birdhouses!



▲ A children’s slide made from Plastic Irrigation Pipe. Installed on the upper terrace of a backyard, it travels through a line of hedges and down to the lower terrace.

The Endless Possibilities of Plastic Pipe

REDUCER

GASKET X GASKET

CONCENTRIC

STYLE A

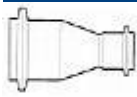

Size	PartNumber	DR 14 (49)	DR 18 (48)	DR21 (39PG)	DR 25 (47)	DR 41 (46)	DR 51 (45)	DR81 (12PC)
4x3	60043	\$228.03	\$182.42	\$177.87	\$173.31	CF	CF	CF
6x4	60064	\$285.05	\$228.03	\$222.34	\$216.64	CF	CF	CF
8x6	60086	\$335.35	\$268.27	\$261.58	\$254.86	CF	CF	CF
10x8	600108	\$414.03	\$331.22	\$327.87	\$324.48	CF	CF	CF
12x10	6001210	\$570.22	\$456.17	\$434.84	\$413.48	CF	CF	CF
14x12	6001412	\$1,129.22	\$903.37	\$880.80	\$858.20	\$815.29	\$774.54	\$735.82
16x14	6001614	\$1,356.17	\$1,084.93	\$1,057.82	\$1,030.69	\$979.16	\$930.20	\$883.69
18x16	6001816	\$2,553.84	\$2,043.07	\$1,992.00	\$1,940.91	\$1,843.88	\$1,751.69	\$1,664.11
20x18	6002018	CF	\$2,598.28	\$2,522.87	\$2,447.45	\$2,325.08	\$2,208.83	\$2,098.39
24x20	6002420	CF	\$3,194.76	\$3,114.90	\$3,035.02	\$2,883.28	\$2,739.13	\$2,602.17
30x24	6003024	CF	\$4,249.03	\$4,142.82	\$4,036.58	\$3,834.76	\$3,643.03	\$3,460.88
36x30	6003630	CF	\$5,651.20	\$5,509.94	\$5,368.65	\$5,100.23	\$4,845.23	\$4,602.97
42x36	6004236	CF	\$7,516.10	\$7,328.20	\$7,140.29	\$6,783.29	\$6,444.13	\$6,121.93
48x42	6004842	CF	\$9,996.41	\$9,746.50	\$9,496.59	\$9,021.76	\$8,570.67	\$8,142.15

STYLE B



Size	PartNumber	DR 14 (49)	DR 18 (48)	DR21 (39PG)	DR 25 (47)	DR 41 (46)	DR 51 (45)	DR81 (12PC)
4x2	60042	\$255.55	\$192.14	\$187.35	\$182.54	CF	CF	CF
6x2	60062	\$336.05	\$252.67	\$246.36	\$240.04	CF	CF	CF
6x3	60063	\$319.26	\$240.04	\$234.05	\$228.03	CF	CF	CF
8x4	60084	\$383.28	\$306.62	\$298.97	\$291.30	CF	CF	CF
10x4	600104	\$499.48	\$399.58	\$389.60	\$379.60	CF	CF	CF
10x6	600106	\$451.69	\$361.34	\$352.31	\$343.28	CF	CF	CF
12x4	600124	\$670.71	\$536.57	\$523.16	\$509.74	CF	CF	CF
12x6	600126	\$609.11	\$487.28	\$475.10	\$462.91	CF	CF	CF
12x8	600128	\$568.07	\$454.45	\$443.10	\$431.72	CF	CF	CF
14x4	600144	\$1,272.96	\$1,018.36	\$992.91	\$967.44	\$919.07	\$873.13	\$829.47
14x6	600146	\$1,245.54	\$996.43	\$971.53	\$946.61	\$899.29	\$854.34	\$811.62
14x8	600148	\$1,197.70	\$958.16	\$934.21	\$910.25	\$864.74	\$821.51	\$780.45
14x10	6001410	\$1,163.47	\$930.76	\$907.50	\$884.22	\$840.02	\$798.02	\$758.13
16x4	600164	\$1,851.25	\$1,480.99	\$1,443.97	\$1,406.94	\$1,336.60	\$1,269.77	\$1,206.29
16x6	600166	\$1,601.46	\$1,281.16	\$1,249.14	\$1,217.10	\$1,156.26	\$1,098.45	\$1,043.53
16x8	600168	\$1,570.65	\$1,256.51	\$1,225.11	\$1,193.69	\$1,134.02	\$1,077.32	\$1,023.47
16x10	6001610	\$1,454.28	\$1,163.42	\$1,134.35	\$1,105.25	\$1,050.00	\$997.50	\$947.63
16x12	6001612	\$1,420.09	\$1,136.06	\$1,107.67	\$1,079.26	\$1,025.31	\$974.05	\$925.36
18x4	600184	\$3,428.75	\$2,742.99	\$2,674.43	\$2,605.84	\$2,475.56	\$2,351.78	\$2,234.20
18x6	600186	\$3,226.82	\$2,581.45	\$2,516.92	\$2,452.38	\$2,329.76	\$2,213.28	\$2,102.63
18x8	600188	\$3,035.18	\$2,428.14	\$2,367.45	\$2,306.74	\$2,191.41	\$2,081.85	\$1,977.76
18x10	6001810	\$2,987.31	\$2,389.84	\$2,330.10	\$2,270.34	\$2,156.83	\$2,048.99	\$1,946.55
18x12	6001812	\$2,710.16	\$2,168.12	\$2,113.92	\$2,059.71	\$1,956.73	\$1,858.89	\$1,765.95
18x14	6001814	\$2,628.65	\$2,102.91	\$2,050.35	\$1,997.77	\$1,897.89	\$1,803.00	\$1,712.86
20x4	600204	CF	\$3,561.48	\$3,472.45	\$3,383.40	\$3,214.24	\$3,053.54	\$2,900.86
20x6	600206	CF	\$3,265.93	\$3,184.29	\$3,102.63	\$2,947.51	\$2,800.14	\$2,660.13
20x8	600208	CF	\$3,170.02	\$3,090.77	\$3,011.52	\$2,860.95	\$2,717.91	\$2,582.03
20x10	6002010	CF	\$2,707.35	\$2,639.68	\$2,571.99	\$2,443.39	\$2,321.23	\$2,205.17
20x12	6002012	CF	\$2,679.98	\$2,613.00	\$2,545.99	\$2,418.69	\$2,297.76	\$2,182.87
20x14	6002014	CF	\$2,600.61	\$2,535.60	\$2,470.58	\$2,347.06	\$2,229.71	\$2,118.23
20x16	6002016	CF	\$2,524.14	\$2,461.05	\$2,397.93	\$2,278.05	\$2,164.15	\$2,055.95
24x4	600244	CF	\$4,656.51	\$4,540.11	\$4,423.68	\$4,202.50	\$3,992.39	\$3,792.77
24x6	600246	CF	\$4,378.12	\$4,268.67	\$4,159.22	\$3,951.26	\$3,753.70	\$3,566.02
24x8	600248	CF	\$4,171.88	\$4,067.58	\$3,963.28	\$3,765.12	\$3,576.87	\$3,398.03
24x10	6002410	CF	\$3,939.22	\$3,840.75	\$3,742.26	\$3,555.16	\$3,377.40	\$3,208.53
24x12	6002412	CF	\$3,608.02	\$3,517.83	\$3,427.62	\$3,256.25	\$3,093.44	\$2,938.78
24x14	6002414	CF	\$3,498.54	\$3,411.08	\$3,323.62	\$3,157.44	\$2,999.58	\$2,849.61
24x16	6002416	CF	\$3,394.57	\$3,309.71	\$3,224.84	\$3,063.60	\$2,910.43	\$2,764.91
24x18	6002418	CF	\$3,293.44	\$3,211.11	\$3,128.77	\$2,972.34	\$2,823.72	\$2,682.54
30x4	600304	CF	\$6,193.16	\$6,038.35	\$5,883.50	\$5,589.33	\$5,309.87	\$5,044.38
30x6	600306	CF	\$5,822.90	\$5,677.34	\$5,531.76	\$5,255.18	\$4,992.43	\$4,742.81
30x8	600308	CF	\$5,548.60	\$5,409.89	\$5,271.16	\$5,007.61	\$4,757.23	\$4,519.37
30x10	6003010	CF	\$5,239.17	\$5,108.20	\$4,977.21	\$4,728.35	\$4,491.93	\$4,267.34
30x12	6003012	CF	\$4,798.67	\$4,678.72	\$4,558.74	\$4,330.81	\$4,114.27	\$3,908.56
30x14	6003014	CF	\$4,653.06	\$4,536.75	\$4,420.42	\$4,199.40	\$3,989.43	\$3,789.96
30x16	6003016	CF	\$4,514.79	\$4,401.92	\$4,289.04	\$4,074.60	\$3,870.88	\$3,677.34
30x18	6003018	CF	\$4,380.28	\$4,270.78	\$4,161.28	\$3,953.22	\$3,755.57	\$3,567.79
30x20	6003020	CF	\$3,942.26	\$3,843.70	\$3,745.16	\$3,557.90	\$3,380.01	\$3,211.02

C-900 GASKETED PRESSURE

REDUCER

GASKET X GASKET

CONCENTRIC

STYLE B

Size	PartNumber	DR 14 (49)	DR 18 (48)	DR21 (39PG)	DR 25 (47)	DR 41 (46)	DR 51 (45)	DR81 (12PC)
36x4	600364	CF	\$8,236.91	\$8,031.01	\$7,825.06	\$7,433.82	\$7,062.14	\$6,709.04
36x6	600366	CF	\$7,744.46	\$7,550.88	\$7,357.25	\$6,989.39	\$6,639.93	\$6,307.93
36x8	600368	CF	\$7,379.64	\$7,195.16	\$7,010.65	\$6,660.12	\$6,327.12	\$6,010.76
36x10	6003610	CF	\$6,968.10	\$6,793.91	\$6,619.70	\$6,288.72	\$5,974.28	\$5,675.57
36x12	6003612	CF	\$6,382.25	\$6,222.70	\$6,063.12	\$5,759.97	\$5,471.98	\$5,198.38
36x14	6003614	CF	\$6,188.58	\$6,033.89	\$5,879.16	\$5,585.21	\$5,305.95	\$5,040.66
36x16	6003616	CF	\$6,004.67	\$5,854.55	\$5,704.43	\$5,419.21	\$5,148.26	\$4,890.85
36x18	6003618	CF	\$5,825.79	\$5,230.34	\$4,634.87	\$4,403.13	\$4,182.98	\$3,973.84
36x20	6003620	CF	\$5,243.22	\$4,870.18	\$4,497.12	\$4,272.27	\$4,058.66	\$3,855.73
36x24	6003624	CF	\$4,718.90	\$4,600.92	\$4,482.95	\$4,258.82	\$4,045.88	\$3,843.59
42x4	600424	CF	\$10,955.10	\$10,681.26	\$10,407.34	\$9,886.98	\$9,392.64	\$8,923.01
42x6	600426	CF	\$10,300.14	\$10,042.67	\$9,785.15	\$9,295.90	\$8,831.11	\$8,389.56
42x8	600428	CF	\$9,814.93	\$9,569.56	\$9,324.18	\$8,857.98	\$8,415.09	\$7,994.34
42x10	6004210	CF	\$9,267.59	\$9,035.91	\$8,804.20	\$8,364.00	\$7,945.80	\$7,548.52
42x12	6004212	CF	\$8,488.39	\$8,276.19	\$8,063.96	\$7,660.77	\$7,277.74	\$6,913.86
42x14	6004214	CF	\$8,230.81	\$8,025.08	\$7,819.29	\$7,428.33	\$7,056.92	\$6,704.07
42x16	6004216	CF	\$7,986.21	\$7,786.56	\$7,586.90	\$7,207.56	\$6,847.18	\$6,504.83
42x18	6004218	CF	\$7,748.30	\$7,554.59	\$7,360.90	\$6,992.86	\$6,643.23	\$6,311.07
42x20	6004220	CF	\$6,973.47	\$6,799.13	\$6,624.82	\$6,293.58	\$5,978.91	\$5,679.98
42x24	6004224	CF	\$6,276.14	\$6,119.23	\$5,962.34	\$5,664.22	\$5,381.02	\$5,111.98
42x30	6004230	CF	\$5,648.52	\$5,507.32	\$5,366.10	\$5,097.80	\$4,842.91	\$4,600.78
48x4	600484	CF	\$14,570.28	\$14,206.08	\$13,841.77	\$13,149.69	\$12,492.21	\$11,867.61
48x6	600486	CF	\$13,699.19	\$13,356.77	\$13,014.26	\$12,363.56	\$11,745.39	\$11,158.13
48x8	600488	CF	\$13,053.86	\$12,727.52	\$12,401.16	\$11,781.11	\$11,192.05	\$10,632.45
48x10	6004810	CF	\$12,325.90	\$12,017.76	\$11,709.60	\$11,124.12	\$10,567.93	\$10,039.53
48x12	6004812	CF	\$11,289.56	\$11,007.34	\$10,725.07	\$10,188.83	\$9,679.39	\$9,195.42
48x14	6004814	CF	\$10,946.99	\$10,673.36	\$10,399.66	\$9,879.68	\$9,385.70	\$8,916.42
48x16	6004816	CF	\$10,621.66	\$10,356.13	\$10,090.57	\$9,586.04	\$9,106.75	\$8,651.42
48x18	6004818	CF	\$10,305.24	\$10,047.63	\$9,790.00	\$9,300.50	\$8,835.48	\$8,393.70
48x20	6004820	CF	\$9,274.73	\$9,043.32	\$8,811.00	\$8,370.46	\$7,951.94	\$7,554.35
48x24	6004824	CF	\$8,347.26	\$8,138.99	\$7,929.91	\$7,533.41	\$7,156.75	\$6,798.92
48x30	6004830	CF	\$7,512.54	\$7,325.09	\$7,136.91	\$6,780.07	\$6,441.08	\$6,119.02
48x36	6004836	CF	\$6,761.29	\$6,592.58	\$6,423.22	\$6,102.06	\$5,796.97	\$5,507.12

C-900 GASKETED PRESSURE

REDUCER

MALE X GASKET

CONCENTRIC

(SEB)



Size	PartNumber	DR 14 (49)	DR 18 (48)	DR21 (39PG)	DR 25 (47)	DR 41 (46)	DR 51 (45)	DR81 (12PC)
4x2	62042	\$298.84	\$239.06	\$233.09	\$227.11	CF	CF	CF
4x3	62043	\$283.90	\$227.11	\$221.44	\$215.76	CF	CF	CF
6x2	62062	\$354.87	\$283.89	\$276.81	\$269.70	CF	CF	CF
6x3	62063	\$337.15	\$269.71	\$263.14	\$256.55	CF	CF	CF
6x4	62064	\$290.79	\$260.35	\$214.33	\$196.02	CF	CF	CF
8x4	62084	\$325.81	\$260.64	\$254.13	\$247.61	CF	CF	CF
8x6	62086	\$475.78	\$442.59	\$320.65	\$260.68	CF	CF	CF
10x4	620104	\$424.56	\$339.64	\$324.97	\$322.66	CF	CF	CF
10x6	620106	\$384.05	\$307.23	\$300.31	\$293.38	CF	CF	CF
10x8	620108	\$351.93	\$339.78	\$274.52	\$267.47	CF	CF	CF
12x4	620124	\$570.12	\$456.09	\$444.69	\$433.29	CF	CF	CF
12x6	620126	\$517.74	\$414.18	\$403.83	\$393.47	CF	CF	CF
12x8	620128	\$482.28	\$414.26	\$404.95	\$395.62	CF	CF	CF
12x10	6201210	\$462.45	\$456.17	\$360.72	\$351.46	CF	CF	CF
14x4	620144	\$1,082.01	\$865.61	\$843.97	\$822.33	\$781.22	\$742.16	\$705.05
14x6	620146	\$1,058.72	\$846.98	\$825.82	\$804.63	\$764.41	\$726.19	\$689.87
14x8	620148	\$1,018.06	\$814.44	\$794.09	\$773.72	\$735.05	\$698.29	\$663.38
14x10	6201410	\$988.95	\$847.12	\$771.39	\$751.59	\$714.02	\$678.32	\$644.40
14x12	6201412	\$959.84	\$865.78	\$748.67	\$729.47	\$693.00	\$658.35	\$625.44
16x4	620164	\$1,573.57	\$1,258.85	\$1,227.38	\$1,195.91	\$1,136.12	\$1,079.32	\$1,025.36
16x6	620166	\$1,361.23	\$1,088.98	\$1,061.76	\$1,034.53	\$982.81	\$933.67	\$887.00
16x8	620168	\$1,335.05	\$1,068.03	\$1,041.34	\$1,014.62	\$963.90	\$915.71	\$869.93
16x10	6201610	\$1,236.15	\$1,068.26	\$964.19	\$939.46	\$892.49	\$847.87	\$805.48
16x12	6201612	\$1,207.07	\$1,089.19	\$941.53	\$917.38	\$871.52	\$827.94	\$786.54
16x14	6201614	\$1,172.30	\$1,259.09	\$914.40	\$890.94	\$846.40	\$804.08	\$763.88
18x4	620184	\$2,914.42	\$2,331.53	\$2,273.25	\$2,214.96	\$2,104.21	\$1,999.01	\$1,899.06
18x6	620186	\$2,742.80	\$2,194.23	\$2,139.39	\$2,084.52	\$1,980.30	\$1,881.30	\$1,787.24
18x8	620188	\$2,579.92	\$2,063.93	\$2,012.34	\$1,960.73	\$1,862.70	\$1,769.57	\$1,681.10
18x10	6201810	\$2,539.20	\$2,031.36	\$1,980.59	\$1,929.79	\$1,833.31	\$1,741.65	\$1,654.57
18x12	6201812	\$2,303.63	\$1,842.90	\$1,796.83	\$1,750.75	\$1,663.22	\$1,580.07	\$1,501.07
18x14	6201814	\$2,234.36	\$1,787.48	\$1,742.80	\$1,698.10	\$1,613.20	\$1,532.55	\$1,455.92
18x16	6201816	\$2,170.76	\$1,736.60	\$1,693.20	\$1,649.78	\$1,567.30	\$1,488.94	\$1,414.50
20x4	620204	CF	\$3,027.26	\$2,951.59	\$2,875.90	\$2,732.11	\$2,595.52	\$2,465.75
20x6	620206	CF	\$2,776.03	\$2,706.64	\$2,637.23	\$2,505.37	\$2,379.35	\$2,260.39
20x8	620208	CF	\$2,694.52	\$2,627.16	\$2,559.80	\$2,431.81	\$2,380.11	\$2,261.11
20x10	6202010	CF	\$2,301.25	\$2,243.73	\$2,186.20	\$2,076.89	\$1,973.06	\$1,874.41
20x12	6202012	CF	\$2,301.74	\$2,237.85	\$2,164.09	\$2,055.89	\$1,953.10	\$1,855.44
20x14	6202014	CF	\$2,384.54	\$2,155.26	\$2,099.99	\$1,995.00	\$1,895.25	\$1,800.49
20x16	6202016	CF	\$2,456.68	\$2,091.88	\$2,038.24	\$1,936.34	\$1,839.52	\$1,747.54
20x18	6202018	CF	\$2,719.75	\$2,028.34	\$1,976.32	\$1,877.51	\$1,783.64	\$1,694.47
24x4	620244	CF	\$3,958.04	\$3,859.09	\$3,760.13	\$3,572.13	\$3,393.54	\$3,223.86
24x6	620246	CF	\$3,721.41	\$3,628.39	\$3,535.34	\$3,358.58	\$3,190.65	\$3,031.12
24x8	620248	CF	\$3,546.09	\$3,457.45	\$3,368.79	\$3,200.36	\$3,040.35	\$2,888.34
24x10	6202410	CF	\$3,348.33	\$3,264.63	\$3,180.91	\$3,021.87	\$2,870.78	\$2,727.25
24x12	6202412	CF	\$3,066.81	\$2,990.15	\$2,913.47	\$2,767.80	\$2,629.42	\$2,497.95
24x14	6202414	CF	\$2,973.75	\$2,899.41	\$2,825.07	\$2,683.82	\$2,549.64	\$2,422.16
24x16	6202416	CF	\$2,885.37	\$2,813.25	\$2,741.11	\$2,604.66	\$2,474.43	\$2,350.72
24x18	6202418	CF	\$2,944.75	\$2,729.44	\$2,659.46	\$2,671.62	\$2,538.05	\$2,411.16
24x20	6202420	CF	\$3,132.60	\$2,647.66	\$2,579.76	\$2,450.78	\$2,328.24	\$2,211.83

C-900 GASKETED PRESSURE

REDUCER

MALE X GASKET

CONCENTRIC

(SEB)

Size	PartNumber	DR 14 (49)	DR 18 (48)	DR21 (39PG)	DR 25 (47)	DR 41 (46)	DR 51 (45)	DR81 (12PC)
30x4	620304	CF	\$5,264.19	\$4,947.97	\$4,631.72	\$4,400.14	\$4,180.14	\$3,971.12
30x6	620306	CF	\$4,949.49	\$4,659.58	\$4,369.66	\$4,151.18	\$3,943.61	\$3,746.44
30x8	620308	CF	\$4,716.31	\$4,598.83	\$4,106.59	\$3,901.27	\$3,706.21	\$3,520.90
30x10	6203010	CF	\$4,453.28	\$4,184.10	\$3,914.90	\$3,719.16	\$3,533.20	\$3,356.54
30x12	6203012	CF	\$4,078.87	\$3,976.90	\$3,874.91	\$3,681.17	\$3,497.12	\$3,322.27
30x14	6203014	CF	\$3,955.09	\$3,856.23	\$3,757.35	\$3,569.49	\$3,391.02	\$3,221.15
30x16	6203016	CF	\$3,837.55	\$3,741.62	\$3,645.67	\$3,463.40	\$3,290.23	\$3,125.72
30x18	6203018	CF	\$3,723.24	\$3,454.35	\$3,185.44	\$3,026.18	\$2,874.86	\$2,731.12
30x20	6203020	CF	\$3,611.68	\$3,351.12	\$3,090.56	\$2,936.03	\$2,789.23	\$2,649.77
30x24	6203024	CF	\$3,250.52	\$3,016.02	\$2,781.51	\$2,642.44	\$2,510.31	\$2,384.80
36x4	620364	CF	\$7,001.38	\$6,557.63	\$6,113.86	\$5,808.18	\$5,517.77	\$5,241.87
36x6	620366	CF	\$6,582.82	\$6,070.45	\$5,558.05	\$5,280.16	\$5,016.15	\$4,765.35
36x8	620368	CF	\$6,272.70	\$5,758.15	\$5,243.59	\$4,981.41	\$4,732.34	\$4,495.73
36x10	6203610	CF	\$5,922.87	\$5,426.51	\$4,930.12	\$4,683.62	\$4,449.44	\$4,226.97
36x12	6203612	CF	\$5,424.90	\$5,061.38	\$4,697.85	\$4,462.97	\$4,239.82	\$4,027.83
36x14	6203614	CF	\$5,260.27	\$4,848.07	\$4,435.85	\$4,214.06	\$4,003.36	\$3,803.19
36x16	6203616	CF	\$5,103.95	\$4,583.44	\$4,062.90	\$3,859.77	\$3,666.78	\$3,483.44
36x18	6203618	CF	\$4,951.91	\$4,445.76	\$3,939.60	\$3,742.63	\$3,555.50	\$3,377.72
36x20	6203620	CF	\$4,803.54	\$4,313.04	\$3,822.53	\$3,631.41	\$3,449.84	\$3,277.35
36x24	6203624	CF	\$4,323.20	\$4,011.32	\$3,699.41	\$3,514.45	\$3,338.73	\$3,171.79
36x30	6203630	CF	\$3,890.88	\$3,610.18	\$3,329.47	\$3,163.01	\$3,004.85	\$2,854.61
42x4	620424	CF	\$9,311.85	\$8,721.66	\$8,131.44	\$7,724.87	\$7,338.62	\$6,971.69
42x6	620426	CF	\$8,755.16	\$8,073.69	\$7,392.21	\$7,022.60	\$6,671.47	\$6,337.90
42x8	620428	CF	\$8,342.70	\$7,658.34	\$6,973.98	\$6,625.29	\$6,294.02	\$5,979.32
42x10	6204210	CF	\$7,877.42	\$7,217.25	\$6,557.06	\$6,229.22	\$5,917.75	\$5,621.87
42x12	6204212	CF	\$7,215.11	\$6,731.64	\$6,248.15	\$5,935.75	\$5,638.96	\$5,357.01
42x14	6204214	CF	\$6,996.16	\$6,447.94	\$5,899.68	\$5,604.71	\$5,324.47	\$5,058.25
42x16	6204216	CF	\$6,788.27	\$6,095.98	\$5,403.67	\$5,133.49	\$4,876.82	\$4,632.97
42x18	6204218	CF	\$6,586.05	\$5,912.87	\$5,239.68	\$4,977.69	\$4,728.81	\$4,492.37
42x20	6204220	CF	\$6,388.71	\$5,736.35	\$5,083.98	\$4,829.78	\$4,588.29	\$4,358.88
42x24	6204224	CF	\$5,749.85	\$5,335.05	\$4,920.23	\$4,674.22	\$4,440.52	\$4,218.49
42x30	6204230	CF	\$5,174.87	\$4,801.55	\$4,428.20	\$4,206.79	\$3,996.46	\$3,796.63
42x36	6204236	CF	\$4,657.40	\$4,321.39	\$3,985.38	\$3,786.12	\$3,596.81	\$3,416.97
48x4	620484	CF	\$12,384.76	\$11,599.81	\$10,814.83	\$10,274.10	\$9,760.40	\$9,272.37
48x6	620486	CF	\$11,644.36	\$10,738.01	\$9,831.65	\$9,340.07	\$8,873.07	\$8,429.42
48x8	620488	CF	\$11,095.80	\$10,185.61	\$9,275.39	\$8,811.63	\$8,371.05	\$7,952.49
48x10	6204810	CF	\$10,476.97	\$9,598.95	\$8,720.90	\$8,284.86	\$7,870.61	\$7,477.08
48x12	6204812	CF	\$9,596.11	\$8,953.08	\$8,310.04	\$7,894.54	\$7,499.82	\$7,124.83
48x14	6204814	CF	\$9,304.90	\$8,575.76	\$7,846.59	\$7,454.27	\$7,081.21	\$6,727.16
48x16	6204816	CF	\$9,028.40	\$8,107.65	\$7,186.88	\$6,827.54	\$6,486.16	\$6,161.86
48x18	6204818	CF	\$8,759.46	\$7,864.13	\$6,968.77	\$6,620.34	\$6,289.32	\$5,974.86
48x20	6204820	CF	\$8,496.99	\$7,629.35	\$6,761.70	\$6,423.62	\$6,102.44	\$5,797.32
48x24	6204824	CF	\$7,647.30	\$7,095.62	\$6,543.91	\$6,216.73	\$5,905.88	\$5,610.60
48x30	6204830	CF	\$6,882.59	\$6,386.07	\$5,889.52	\$5,595.05	\$5,315.30	\$5,049.54
48x36	6204836	CF	\$6,194.35	\$5,747.47	\$5,300.57	\$5,035.55	\$4,783.77	\$4,544.58
48x42	6204842	CF	\$5,574.91	\$5,172.72	\$4,770.51	\$4,531.99	\$4,305.39	\$4,090.12

C-900 GASKETED PRESSURE

REDUCER

MALE X GASKET

CONCENTRIC

(LEB)

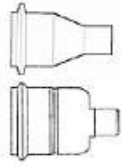

Size	PartNumber	DR 14 (49)	DR 18 (48)	DR21 (39PG)	DR 25 (47)	DR 41 (46)	DR 51 (45)	DR81 (12PC)
4x2	64042	\$255.55	\$192.14	\$187.35	\$182.54	CF	CF	CF
4x3	64043	\$228.03	\$182.42	\$177.87	\$173.31	CF	CF	CF
6x4	64064	\$285.05	\$228.03	\$222.34	\$216.64	CF	CF	CF
8x4	64084	\$383.28	\$306.62	\$291.30	\$291.30	CF	CF	CF
8x6	64086	\$335.35	\$268.27	\$261.58	\$254.86	CF	CF	CF
10x4	640104	\$499.48	\$399.58	\$389.60	\$379.60	CF	CF	CF
10x6	640106	\$451.69	\$361.34	\$352.31	\$343.28	CF	CF	CF
10x8	640108	\$414.03	\$331.22	\$327.87	\$324.48	CF	CF	CF
12x4	640124	\$670.71	\$536.57	\$523.16	\$509.74	CF	CF	CF
12x6	640126	\$609.11	\$487.28	\$475.10	\$462.91	CF	CF	CF
12x8	640128	\$568.07	\$454.45	\$425.04	\$395.62	CF	CF	CF
12x10	6401210	\$544.05	\$435.24	\$393.36	\$351.46	CF	CF	CF
14x4	640144	\$1,272.96	\$1,018.36	\$992.91	\$967.44	\$919.07	\$873.13	\$829.47
14x6	640146	\$1,245.54	\$996.43	\$971.53	\$946.61	\$899.29	\$854.34	\$811.62
14x8	640148	\$1,197.70	\$958.16	\$934.21	\$910.25	\$864.74	\$821.51	\$780.45
14x10	6401410	\$1,163.47	\$930.76	\$907.50	\$884.22	\$840.02	\$798.02	\$758.13
14x12	6401412	\$1,129.22	\$903.37	\$880.80	\$858.20	\$815.29	\$774.54	\$735.82
16x4	640164	\$1,851.25	\$1,480.99	\$1,443.97	\$1,406.94	\$1,336.60	\$1,269.77	\$1,206.29
16x6	640166	\$1,601.46	\$1,281.16	\$1,249.14	\$1,217.10	\$1,156.26	\$1,098.45	\$1,043.53
16x8	640168	\$1,570.65	\$1,256.51	\$1,225.11	\$1,193.69	\$1,134.02	\$1,077.32	\$1,023.47
16x10	6401640	\$1,454.28	\$1,163.42	\$1,134.35	\$1,105.25	\$1,050.00	\$997.50	\$947.63
16x12	6401612	\$1,420.09	\$1,136.06	\$1,107.67	\$1,079.26	\$1,025.31	\$974.05	\$925.36
16x14	6401614	\$1,356.17	\$1,084.93	\$1,057.82	\$1,030.69	\$979.16	\$930.20	\$883.69
18x4	640184	\$3,428.75	\$2,742.99	\$2,674.43	\$2,605.84	\$2,475.56	\$2,351.78	\$2,234.20
18x6	640186	\$3,226.82	\$2,581.45	\$2,516.92	\$2,452.38	\$2,329.76	\$2,213.28	\$2,102.63
18x8	640188	\$3,035.18	\$2,428.14	\$2,367.45	\$2,306.74	\$2,191.41	\$2,081.85	\$1,977.76
18x10	6401810	\$2,987.31	\$2,389.84	\$2,330.10	\$2,270.34	\$2,156.83	\$2,048.99	\$1,946.55
18x12	6401812	\$2,710.16	\$2,168.12	\$2,113.92	\$2,059.71	\$1,956.73	\$1,858.89	\$1,765.95
18x14	6401814	\$2,628.65	\$2,102.91	\$2,050.35	\$1,997.77	\$1,897.89	\$1,803.00	\$1,712.86
18x16	6401816	\$2,553.84	\$2,043.07	\$1,992.00	\$1,940.91	\$1,843.88	\$1,751.69	\$1,664.11
20x4	640204	CF	\$3,561.48	\$3,472.45	\$3,383.40	\$3,214.24	\$3,053.54	\$2,900.86
20x6	640206	CF	\$3,265.93	\$3,184.29	\$3,102.63	\$2,947.51	\$2,800.14	\$2,660.13
20x8	640208	CF	\$3,170.02	\$3,090.77	\$3,011.52	\$2,860.95	\$2,717.91	\$2,582.03
20x10	6402010	CF	\$2,707.35	\$2,639.68	\$2,571.99	\$2,443.39	\$2,321.23	\$2,205.17
20x12	6402012	CF	\$2,679.98	\$2,613.00	\$2,545.99	\$2,418.69	\$2,297.76	\$2,182.87
20x14	6402014	CF	\$2,600.61	\$2,535.60	\$2,470.58	\$2,347.06	\$2,229.71	\$2,118.23
20x16	6402016	CF	\$2,524.14	\$2,461.05	\$2,397.93	\$2,278.05	\$2,164.15	\$2,055.95
20x18	6402018	CF	\$2,447.45	\$2,386.27	\$2,325.08	\$2,208.83	\$2,098.39	\$1,993.47
24x4	640244	CF	\$4,656.51	\$4,540.11	\$4,423.68	\$4,202.50	\$3,992.39	\$3,792.77
24x6	640246	CF	\$4,378.12	\$4,268.67	\$4,159.22	\$3,951.26	\$3,753.70	\$3,566.02
24x8	640248	CF	\$4,171.88	\$4,067.58	\$3,963.28	\$3,765.12	\$3,576.87	\$3,398.03
24x10	6402410	CF	\$3,939.22	\$3,840.75	\$3,742.26	\$3,555.16	\$3,377.40	\$3,208.53
24x12	6402412	CF	\$3,608.02	\$3,517.83	\$3,427.62	\$3,256.25	\$3,093.44	\$2,938.78
24x14	6402414	CF	\$3,498.54	\$3,411.08	\$3,323.62	\$3,157.44	\$2,999.58	\$2,849.61
24x16	6402416	CF	\$3,394.57	\$3,309.71	\$3,224.84	\$3,063.60	\$2,910.43	\$2,764.91
24x18	6402418	CF	\$3,293.44	\$3,211.11	\$3,128.77	\$2,972.34	\$2,823.72	\$2,682.54
24x20	6402420	CF	\$2,964.10	\$2,890.01	\$2,815.90	\$2,675.11	\$2,541.35	\$2,414.29

C-900 GASKETED PRESSURE

REDUCER

MALE X GASKET

CONCENTRIC

(LEB)

Size	PartNumber	DR 14 (49)	DR 18 (48)	DR21 (39PG)	DR 25 (47)	DR 41 (46)	DR 51 (45)	DR81 (12PC)
30x4	640304	CF	\$6,193.16	\$6,038.35	\$5,883.50	\$5,589.33	\$5,309.87	\$5,044.38
30x6	640306	CF	\$5,822.90	\$5,677.34	\$5,531.76	\$5,255.18	\$4,992.43	\$4,742.81
30x8	640308	CF	\$5,548.60	\$5,409.89	\$5,271.16	\$5,007.61	\$4,757.23	\$4,519.37
30x10	6403010	CF	\$5,239.17	\$5,108.20	\$4,977.21	\$4,728.35	\$4,491.93	\$4,267.34
30x12	6403012	CF	\$4,798.67	\$4,678.72	\$4,558.74	\$4,330.81	\$4,114.27	\$3,908.56
30x14	6403014	CF	\$4,653.06	\$4,536.75	\$4,420.42	\$4,199.40	\$3,989.43	\$3,789.96
30x16	6403016	CF	\$4,514.79	\$4,401.92	\$4,289.04	\$4,074.60	\$3,870.88	\$3,677.33
30x18	6403018	CF	\$4,380.28	\$4,270.78	\$4,161.28	\$3,953.22	\$3,755.57	\$3,567.79
30x20	6403020	CF	\$3,942.26	\$3,843.71	\$3,745.16	\$3,557.90	\$3,380.01	\$3,380.01
30x24	6403024	CF	\$3,548.04	\$3,459.35	\$3,370.65	\$3,202.12	\$3,042.01	\$3,042.01
36x4	640364	CF	\$8,236.91	\$8,031.01	\$7,825.06	\$7,433.82	\$7,062.14	\$6,709.04
36x6	640366	CF	\$7,744.46	\$7,550.88	\$7,357.25	\$6,989.39	\$6,639.93	\$6,307.93
36x8	640368	CF	\$7,379.64	\$7,195.16	\$7,010.65	\$6,660.12	\$6,327.12	\$6,010.76
36x10	6403610	CF	\$6,968.10	\$6,793.91	\$6,619.70	\$6,288.72	\$5,974.28	\$5,675.57
36x12	6403612	CF	\$6,382.25	\$6,222.70	\$6,063.12	\$5,759.97	\$5,471.98	\$5,198.38
36x14	6403614	CF	\$6,188.58	\$6,033.89	\$5,879.16	\$5,585.21	\$5,305.95	\$5,040.66
36x16	6403616	CF	\$6,004.67	\$5,854.55	\$5,704.43	\$5,419.23	\$5,148.27	\$4,890.86
36x18	6403618	CF	\$5,825.79	\$5,680.14	\$5,534.50	\$5,257.78	\$4,994.90	\$4,745.16
36x20	6403620	CF	\$5,243.21	\$5,112.14	\$4,981.06	\$4,732.02	\$4,495.43	\$4,270.66
36x24	6403624	CF	\$4,718.90	\$4,600.94	\$4,482.98	\$4,258.83	\$4,045.90	\$3,843.60
36x30	6403630	CF	\$4,247.01	\$4,140.85	\$4,034.67	\$3,832.94	\$3,641.30	\$3,459.23
42x4	640424	CF	\$10,955.10	\$10,681.26	\$10,407.34	\$9,886.98	\$9,392.64	\$8,923.01
42x6	640426	CF	\$10,300.14	\$10,042.67	\$9,785.15	\$9,295.90	\$8,831.11	\$8,389.56
42x8	640428	CF	\$9,814.93	\$9,569.56	\$9,324.18	\$8,857.98	\$8,415.09	\$7,994.34
42x10	6404210	CF	\$9,267.59	\$9,035.91	\$8,804.20	\$8,364.00	\$7,945.80	\$7,548.52
42x12	6404212	CF	\$8,488.39	\$8,276.19	\$8,063.96	\$7,660.77	\$7,277.74	\$6,913.86
42x14	6404214	CF	\$8,230.81	\$8,025.08	\$7,819.29	\$7,428.33	\$7,056.92	\$6,704.07
42x16	6404216	CF	\$7,986.21	\$7,786.56	\$7,586.90	\$7,207.58	\$6,847.20	\$6,504.85
42x18	6404218	CF	\$7,748.30	\$7,554.60	\$7,360.90	\$6,992.86	\$6,643.23	\$6,311.07
42x20	6404220	CF	\$6,973.47	\$6,799.16	\$6,624.82	\$6,293.58	\$5,978.91	\$5,679.95
42x24	6404224	CF	\$6,276.14	\$6,119.25	\$5,962.36	\$5,664.24	\$5,381.03	\$5,111.98
42x30	6404230	CF	\$5,648.52	\$5,507.33	\$5,366.12	\$5,097.82	\$4,842.93	\$4,600.78
42x36	6404236	CF	\$5,083.68	\$4,956.60	\$4,829.52	\$4,588.05	\$4,358.65	\$4,140.71
48x4	640484	CF	\$14,570.28	\$14,206.08	\$13,841.77	\$13,149.69	\$12,492.21	\$11,867.61
48x6	640486	CF	\$13,699.19	\$13,356.77	\$13,014.26	\$12,363.56	\$11,745.39	\$11,158.13
48x8	640488	CF	\$13,053.86	\$12,727.52	\$12,401.16	\$11,781.11	\$11,192.05	\$10,632.45
48x10	6404810	CF	\$12,325.90	\$12,017.76	\$11,709.60	\$11,124.12	\$10,567.93	\$10,039.53
48x12	6404812	CF	\$11,289.56	\$11,007.34	\$10,725.07	\$10,188.83	\$9,679.39	\$9,195.42
48x14	6404814	CF	\$10,946.99	\$10,673.36	\$10,399.66	\$9,879.68	\$9,385.70	\$8,916.42
48x16	6404816	CF	\$10,621.66	\$10,356.12	\$10,090.57	\$9,586.09	\$9,106.79	\$8,651.45
48x18	6404818	CF	\$10,305.24	\$10,048.13	\$9,790.00	\$9,300.50	\$8,835.48	\$8,393.71
48x20	6404820	CF	\$9,274.73	\$9,042.88	\$8,811.01	\$8,370.47	\$7,951.94	\$7,554.35
48x24	6404824	CF	\$8,347.26	\$8,138.61	\$7,929.94	\$7,533.45	\$7,156.77	\$6,798.94
48x30	6404830	CF	\$7,512.55	\$7,324.75	\$7,136.95	\$6,780.10	\$6,441.10	\$6,119.05
48x36	6404836	CF	\$6,761.30	\$6,592.29	\$6,423.27	\$6,102.11	\$5,797.00	\$5,507.15
48x42	6404842	CF	\$6,085.17	\$5,933.06	\$5,780.94	\$5,491.89	\$5,217.31	\$4,956.44

C-900 GASKETED PRESSURE

REDUCER

GASKET X GASKET

ECCENTRIC

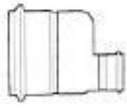

Size	PartNumber	DR 14 (49)	DR 18 (48)	DR21 (39PG)	DR 25 (47)	DR 41 (46)	DR 51 (45)	DR81 (12PC)
4x2	61042	\$255.55	\$192.14	\$187.35	\$182.54	CF	CF	CF
4x3	61043	\$228.03	\$182.42	\$177.87	\$173.31	CF	CF	CF
6x4	61064	\$285.05	\$228.03	\$222.34	\$216.64	CF	CF	CF
8x4	61084	\$383.28	\$306.62	\$291.30	\$291.30	CF	CF	CF
8x6	61086	\$335.35	\$268.27	\$261.58	\$254.86	CF	CF	CF
10x4	610104	\$499.48	\$399.58	\$389.60	\$379.60	CF	CF	CF
10x6	610106	\$451.69	\$361.34	\$352.31	\$343.28	CF	CF	CF
10x8	610108	\$414.03	\$339.78	\$322.79	\$306.66	CF	CF	CF
12x4	610124	\$670.71	\$536.57	\$523.16	\$509.74	CF	CF	CF
12x6	610126	\$609.11	\$487.28	\$475.10	\$462.91	CF	CF	CF
12x8	610128	\$568.07	\$454.45	\$443.10	\$431.72	CF	CF	CF
12x10	6101210	\$544.05	\$456.17	\$433.37	\$411.70	CF	CF	CF
14x4	610144	\$1,272.96	\$1,018.36	\$992.91	\$967.44	\$919.07	\$873.13	\$829.47
14x6	610146	\$1,245.54	\$996.43	\$971.53	\$946.61	\$899.29	\$854.34	\$811.62
14x8	610148	\$1,197.70	\$958.16	\$934.21	\$910.25	\$864.74	\$821.51	\$780.45
14x10	6101410	\$1,163.47	\$930.76	\$907.50	\$884.22	\$840.02	\$798.02	\$758.13
14x12	6101412	\$1,129.22	\$903.37	\$880.80	\$858.20	\$815.29	\$774.54	\$735.82
16x4	610164	\$1,851.25	\$1,480.99	\$1,443.97	\$1,406.94	\$1,336.60	\$1,269.77	\$1,206.29
16x6	610166	\$1,601.46	\$1,281.16	\$1,249.14	\$1,217.10	\$1,156.26	\$1,098.45	\$1,043.53
16x8	610168	\$1,570.65	\$1,256.51	\$1,225.11	\$1,193.69	\$1,134.02	\$1,077.32	\$1,023.47
16x10	6101610	\$1,454.28	\$1,163.42	\$1,134.35	\$1,105.25	\$1,050.00	\$997.50	\$947.63
16x12	6101612	\$1,420.09	\$1,136.06	\$1,107.67	\$1,079.26	\$1,025.31	\$974.05	\$925.36
16x14	6101614	\$1,356.17	\$1,084.93	\$1,057.82	\$1,030.69	\$979.16	\$930.20	\$883.69
18x4	610184	\$3,428.75	\$2,742.99	\$2,674.43	\$2,605.84	\$2,475.56	\$2,351.78	\$2,234.20
18x6	610186	\$3,226.82	\$2,581.45	\$2,516.92	\$2,452.38	\$2,329.76	\$2,213.28	\$2,102.63
18x8	610188	\$3,035.18	\$2,428.14	\$2,367.45	\$2,306.74	\$2,191.41	\$2,081.85	\$1,977.76
18x10	6101810	\$2,987.31	\$2,389.84	\$2,330.10	\$2,270.34	\$2,156.83	\$2,048.99	\$1,946.55
18x12	6101812	\$2,710.16	\$2,168.12	\$2,113.92	\$2,059.71	\$1,956.73	\$1,858.89	\$1,765.95
18x14	6101814	\$2,628.65	\$2,102.91	\$2,050.35	\$1,997.77	\$1,897.89	\$1,803.00	\$1,712.86
18x16	6101816	\$2,553.84	\$2,043.07	\$1,992.00	\$1,940.91	\$1,843.88	\$1,751.69	\$1,664.11
20x4	610204	CF	\$3,561.48	\$3,472.45	\$3,383.40	\$3,214.24	\$3,053.54	\$2,900.86
20x6	610206	CF	\$3,265.93	\$3,184.29	\$3,102.63	\$2,947.51	\$2,800.14	\$2,660.13
20x8	610208	CF	\$3,170.02	\$3,090.77	\$3,011.52	\$2,860.95	\$2,717.91	\$2,582.03
20x10	6102010	CF	\$2,707.35	\$2,639.68	\$2,571.99	\$2,443.39	\$2,321.23	\$2,205.17
20x12	6102012	CF	\$2,679.98	\$2,613.00	\$2,545.99	\$2,418.69	\$2,297.76	\$2,182.87
20x14	6102014	CF	\$2,600.61	\$2,535.60	\$2,470.58	\$2,347.06	\$2,229.71	\$2,118.23
20x16	6102016	CF	\$2,524.14	\$2,461.05	\$2,397.93	\$2,278.05	\$2,164.15	\$2,055.95
20x18	6102018	CF	\$2,598.28	\$2,468.37	\$2,344.95	\$2,227.70	\$2,116.32	\$2,010.50
24x4	610244	CF	\$4,656.51	\$4,540.11	\$4,423.68	\$4,202.50	\$3,992.39	\$3,792.77
24x6	610246	CF	\$4,378.12	\$4,268.67	\$4,159.22	\$3,951.26	\$3,753.70	\$3,566.02
24x8	610248	CF	\$4,171.88	\$4,067.58	\$3,963.28	\$3,765.12	\$3,576.87	\$3,398.03
24x10	6102410	CF	\$3,939.22	\$3,840.75	\$3,742.26	\$3,555.16	\$3,377.40	\$3,208.53
24x12	6102412	CF	\$3,608.02	\$3,517.83	\$3,427.62	\$3,256.25	\$3,093.44	\$2,938.78
24x14	6102414	CF	\$3,498.54	\$3,411.08	\$3,323.62	\$3,157.44	\$2,999.58	\$2,849.61
24x16	6102416	CF	\$3,394.57	\$3,309.71	\$3,224.84	\$3,063.60	\$2,910.43	\$2,764.91
24x18	6102418	CF	\$3,293.44	\$3,211.11	\$3,128.77	\$2,972.34	\$2,823.72	\$2,682.54
24x20	6102420	CF	\$2,964.10	\$2,890.01	\$2,815.90	\$2,675.11	\$2,541.35	\$2,414.29
30x4	610304	CF	\$6,193.16	\$6,038.35	\$5,883.50	\$5,589.33	\$5,309.87	\$5,044.38
30x6	610306	CF	\$5,822.90	\$5,677.34	\$5,531.76	\$5,255.18	\$4,992.43	\$4,742.81
30x8	610308	CF	\$5,548.60	\$5,409.89	\$5,271.16	\$5,007.61	\$4,757.23	\$4,519.37
30x10	6103010	CF	\$5,239.17	\$5,108.20	\$4,977.21	\$4,728.35	\$4,491.93	\$4,267.34
30x12	6103012	CF	\$4,798.67	\$4,678.72	\$4,558.74	\$4,330.81	\$4,114.27	\$3,908.56
30x14	6103014	CF	\$4,653.06	\$4,536.75	\$4,420.42	\$4,199.40	\$3,989.43	\$3,789.96
30x16	6103016	CF	\$4,514.79	\$4,401.92	\$4,289.04	\$4,074.60	\$3,870.87	\$3,677.32
30x18	6103018	CF	\$4,380.28	\$4,270.78	\$4,161.28	\$3,953.22	\$3,755.57	\$3,567.79
30x20	6103020	CF	\$4,314.66	\$4,206.80	\$4,098.93	\$3,893.99	\$3,699.29	\$3,514.32
30x24	6103024	CF	\$4,249.03	\$4,142.82	\$4,036.58	\$3,834.76	\$3,643.03	\$3,460.88

C-900 GASKETED PRESSURE

REDUCER

GASKET X GASKET

ECCENTRIC

Size	PartNumber	DR 14 (49)	DR 18 (48)	DR21 (39PG)	DR 25 (47)	DR 41 (46)	DR 51 (45)	DR81 (12PC)
36x4	610364	CF	\$8,236.91	\$8,031.01	\$7,825.06	\$7,433.82	\$7,062.14	\$6,709.04
36x6	610366	CF	\$7,744.46	\$7,550.88	\$7,357.25	\$6,989.39	\$6,639.93	\$6,307.93
36x8	610368	CF	\$7,379.64	\$7,195.16	\$7,010.65	\$6,660.12	\$6,327.12	\$6,010.76
36x10	6103610	CF	\$6,968.10	\$6,793.91	\$6,619.70	\$6,288.72	\$5,974.28	\$5,675.57
36x12	6103612	CF	\$6,382.25	\$6,222.70	\$6,063.12	\$5,759.97	\$5,471.98	\$5,198.38
36x14	6103614	CF	\$6,188.58	\$6,033.89	\$5,879.16	\$5,585.21	\$5,305.95	\$5,040.66
36x16	6103616	CF	\$6,004.67	\$5,854.55	\$5,704.43	\$5,419.21	\$5,148.25	\$4,890.84
36x18	6103618	CF	\$5,825.79	\$5,680.14	\$5,534.50	\$5,257.78	\$4,994.90	\$4,745.16
36x20	6103620	CF	\$5,738.51	\$5,595.06	\$5,451.59	\$5,179.01	\$4,920.07	\$4,674.06
36x24	6103624	CF	\$5,651.22	\$5,509.95	\$5,368.66	\$5,100.24	\$4,845.23	\$4,602.96
36x30	6103630	CF	\$5,086.09	\$4,958.95	\$4,831.79	\$4,590.21	\$4,360.70	\$4,142.67
42x4	610424	CF	\$10,955.10	\$10,681.26	\$10,407.34	\$9,886.98	\$9,392.64	\$8,923.01
42x6	610426	CF	\$10,300.14	\$10,042.67	\$9,785.15	\$9,295.90	\$8,831.11	\$8,389.56
42x8	610428	CF	\$9,814.93	\$9,569.56	\$9,324.18	\$8,857.98	\$8,415.09	\$7,994.34
42x10	6104210	CF	\$9,267.59	\$9,035.91	\$8,804.20	\$8,364.00	\$7,945.80	\$7,548.52
42x12	6104212	CF	\$8,488.39	\$8,276.19	\$8,063.96	\$7,660.77	\$7,277.74	\$6,913.86
42x14	6104214	CF	\$8,230.81	\$8,025.08	\$7,819.29	\$7,428.33	\$7,056.92	\$6,704.07
42x16	6104216	CF	\$7,986.21	\$7,786.56	\$7,586.90	\$7,207.56	\$6,847.18	\$6,504.83
42x18	6104218	CF	\$7,748.30	\$7,554.59	\$7,360.90	\$6,992.86	\$6,643.23	\$6,311.07
42x20	6104220	CF	\$7,632.23	\$7,441.43	\$7,250.61	\$6,888.09	\$6,543.68	\$6,216.50
42x24	6104224	CF	\$7,516.12	\$7,328.24	\$7,140.33	\$6,783.32	\$6,444.15	\$6,121.94
42x30	6104230	CF	\$6,764.51	\$6,595.41	\$6,426.29	\$6,104.98	\$5,799.74	\$5,509.75
42x36	6104236	CF	\$6,088.07	\$5,935.87	\$5,783.66	\$5,494.48	\$5,219.76	\$4,958.78
48x4	610484	CF	\$14,570.28	\$14,206.08	\$13,841.77	\$13,149.69	\$12,492.21	\$11,867.61
48x6	610486	CF	\$13,699.19	\$13,356.77	\$13,014.26	\$12,363.56	\$11,745.39	\$11,158.13
48x8	610488	CF	\$13,053.86	\$12,727.52	\$12,401.16	\$11,781.11	\$11,192.05	\$10,632.45
48x10	6104810	CF	\$12,325.90	\$12,017.76	\$11,709.60	\$11,124.12	\$10,567.93	\$10,039.53
48x12	6104812	CF	\$11,289.56	\$11,007.34	\$10,725.07	\$10,188.83	\$9,679.39	\$9,195.42
48x14	6104814	CF	\$10,946.99	\$10,673.36	\$10,399.66	\$9,879.68	\$9,385.70	\$8,916.42
48x16	6104816	CF	\$10,621.66	\$7,650.63	\$5,045.30	\$4,793.04	\$4,553.39	\$4,325.73
48x18	6104818	CF	\$10,305.24	\$10,048.13	\$9,790.00	\$9,300.50	\$8,835.48	\$8,393.71
48x20	6104820	CF	\$10,150.87	\$9,897.11	\$9,643.33	\$9,161.16	\$8,703.11	\$8,267.95
48x24	6104824	CF	\$9,996.46	\$9,746.56	\$9,496.64	\$9,021.82	\$8,570.72	\$8,142.18
48x30	6104830	CF	\$8,996.80	\$8,771.89	\$8,546.97	\$8,119.63	\$7,713.65	\$7,327.96
48x36	6104836	CF	\$8,097.14	\$7,894.72	\$7,692.27	\$7,307.66	\$6,942.27	\$6,595.17
48x42	6104842	CF	\$7,287.42	\$7,105.24	\$6,923.05	\$6,576.90	\$6,248.05	\$5,935.66

C-900 GASKETED PRESSURE

REDUCER

MALE X GASKET

ECCENTRIC

(SEB)

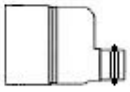

Size	PartNumber	DR 14 (49)	DR 18 (48)	DR21 (39PG)	DR 25 (47)	DR 41 (46)	DR 51 (45)	DR81 (12PC)
4x3	63043	\$228.03	\$182.42	\$177.87	\$173.31	CF	CF	CF
6x4	63064	\$285.05	\$228.03	\$222.34	\$216.64	CF	CF	CF
8x4	63084	\$383.28	\$306.62	\$291.30	\$291.30	CF	CF	CF
8x6	63086	\$335.35	\$268.27	\$261.58	\$254.86	CF	CF	CF
10x4	630104	\$499.48	\$399.58	\$389.60	\$379.60	CF	CF	CF
10x6	630106	\$451.69	\$361.34	\$352.31	\$343.28	CF	CF	CF
10x8	630108	\$414.03	\$399.74	\$327.87	\$324.48	CF	CF	CF
12x4	630124	\$670.71	\$536.57	\$523.16	\$509.74	CF	CF	CF
12x6	630126	\$609.11	\$487.28	\$475.10	\$462.91	CF	CF	CF
12x8	630128	\$568.07	\$487.37	\$443.10	\$431.72	CF	CF	CF
12x10	6301210	\$544.05	\$536.67	\$424.37	\$413.48	CF	CF	CF
14x4	630144	\$1,272.96	\$1,018.36	\$992.91	\$967.44	\$919.07	\$873.13	\$829.47
14x6	630146	\$1,245.54	\$996.43	\$971.53	\$946.61	\$899.29	\$854.34	\$811.62
14x8	630148	\$1,197.70	\$958.16	\$934.21	\$910.25	\$864.74	\$821.51	\$780.45
14x10	6301410	\$1,163.47	\$996.61	\$907.50	\$884.22	\$840.02	\$798.02	\$758.13
14x12	6301412	\$1,129.22	\$1,018.57	\$880.80	\$858.20	\$815.29	\$774.54	\$735.82
16x4	630164	\$1,851.25	\$1,480.99	\$1,443.97	\$1,406.94	\$1,336.60	\$1,269.77	\$1,206.29
16x6	630166	\$1,601.46	\$1,281.16	\$1,249.14	\$1,217.10	\$1,156.26	\$1,098.45	\$1,043.53
16x8	630168	\$1,570.65	\$1,256.51	\$1,225.11	\$1,193.69	\$1,134.02	\$1,077.32	\$1,023.47
16x10	6301610	\$1,454.28	\$1,256.78	\$1,134.35	\$1,105.25	\$1,050.00	\$997.50	\$947.63
16x12	6301612	\$1,420.09	\$1,281.40	\$1,107.67	\$1,079.26	\$1,025.31	\$974.05	\$925.36
16x14	6301614	\$1,356.17	\$1,481.28	\$1,057.82	\$1,030.69	\$979.16	\$930.20	\$883.69
18x4	630184	\$3,428.75	\$2,742.99	\$2,674.43	\$2,605.84	\$2,475.56	\$2,351.78	\$2,234.20
18x6	630186	\$3,226.82	\$2,581.45	\$2,516.92	\$2,452.38	\$2,329.76	\$2,213.28	\$2,102.63
18x8	630188	\$3,035.18	\$2,428.14	\$2,367.45	\$2,306.74	\$2,191.41	\$2,081.85	\$1,977.76
18x10	6301810	\$2,987.31	\$2,389.84	\$2,330.10	\$2,270.34	\$2,156.83	\$2,048.99	\$1,946.55
18x12	6301812	\$2,710.16	\$2,168.12	\$2,113.92	\$2,059.71	\$1,956.73	\$1,858.89	\$1,765.95
18x14	6301814	\$2,628.65	\$2,102.91	\$2,050.35	\$1,997.77	\$1,897.89	\$1,803.00	\$1,712.86
18x16	6301816	\$2,553.84	\$2,043.07	\$1,992.00	\$1,940.91	\$1,843.88	\$1,751.69	\$1,664.11
20x4	630204	CF	\$3,561.48	\$3,472.45	\$3,383.40	\$3,214.24	\$3,053.54	\$2,900.86
20x6	630206	CF	\$3,265.93	\$3,184.29	\$3,102.63	\$2,947.51	\$2,800.14	\$2,660.13
20x8	630208	CF	\$3,170.02	\$3,090.77	\$3,011.52	\$2,860.95	\$2,717.91	\$2,582.03
20x10	6302010	CF	\$2,707.35	\$2,639.68	\$2,571.99	\$2,443.39	\$2,321.23	\$2,205.17
20x12	6302012	CF	\$2,707.93	\$2,613.00	\$2,545.99	\$2,418.69	\$2,297.76	\$2,182.87
20x14	6302014	CF	\$2,805.33	\$2,535.60	\$2,470.58	\$2,347.06	\$2,229.71	\$2,118.23
20x16	6302016	CF	\$2,890.20	\$2,461.05	\$2,397.93	\$2,278.05	\$2,164.15	\$2,055.95
20x18	6302018	CF	\$3,199.70	\$2,214.95	\$2,158.15	\$2,050.24	\$1,947.73	\$1,850.35
24x4	630244	CF	\$4,656.51	\$4,540.11	\$4,423.68	\$4,202.50	\$3,992.39	\$3,792.77
24x6	630246	CF	\$4,378.12	\$4,268.67	\$4,159.22	\$3,951.26	\$3,753.70	\$3,566.02
24x8	630248	CF	\$4,171.88	\$4,067.58	\$3,963.28	\$3,765.12	\$3,576.87	\$3,398.03
24x10	6302410	CF	\$3,939.22	\$3,840.75	\$3,742.26	\$3,555.16	\$3,377.40	\$3,208.53
24x12	6302412	CF	\$3,608.02	\$3,517.83	\$3,427.62	\$3,256.25	\$3,093.44	\$2,938.78
24x14	6302414	CF	\$3,498.54	\$3,411.08	\$3,323.62	\$3,157.44	\$2,999.58	\$2,849.61
24x16	6302416	CF	\$3,394.57	\$3,309.71	\$3,224.84	\$3,063.60	\$2,910.43	\$2,764.91
24x18	6302418	CF	\$3,464.41	\$3,211.11	\$3,128.77	\$2,972.34	\$2,823.72	\$2,682.54
24x20	6302420	CF	\$3,685.42	\$3,114.90	\$3,035.02	\$2,883.28	\$2,739.13	\$2,602.17
30x4	630304	CF	\$6,193.16	\$6,038.35	\$5,883.50	\$5,589.33	\$5,309.87	\$5,044.38
30x6	630306	CF	\$5,822.90	\$5,677.34	\$5,531.76	\$5,255.18	\$4,992.43	\$4,742.81
30x8	630308	CF	\$5,548.60	\$5,409.89	\$5,271.16	\$5,007.61	\$4,757.23	\$4,519.37
30x10	6303010	CF	\$5,239.17	\$5,108.20	\$4,977.21	\$4,728.35	\$4,491.93	\$4,267.34
30x12	6303012	CF	\$4,798.67	\$4,678.72	\$4,558.74	\$4,330.81	\$4,114.27	\$3,908.56
30x14	6303014	CF	\$4,653.06	\$4,536.75	\$4,420.42	\$4,199.40	\$3,989.43	\$3,789.96
30x16	6303016	CF	\$4,514.79	\$4,401.91	\$4,289.04	\$4,074.60	\$3,870.87	\$3,677.32
30x18	6303018	CF	\$4,380.28	\$4,270.78	\$4,161.28	\$3,953.22	\$3,755.57	\$3,567.79
30x20	6303020	CF	\$4,249.03	\$4,142.82	\$4,036.58	\$3,834.76	\$3,643.03	\$3,460.88
30x24	6303024	CF	\$3,824.13	\$3,728.54	\$3,632.93	\$3,451.29	\$3,278.73	\$2,950.87

C-900 GASKETED PRESSURE

REDUCER

MALE X GASKET

ECCENTRIC

(SEB)

Size	PartNumber	DR 14 (49)	DR 18 (48)	DR21 (39PG)	DR 25 (47)	DR 41 (46)	DR 51 (45)	DR81 (12PC)
36x4	630364	CF	\$8,236.91	\$8,031.01	\$7,825.06	\$7,433.82	\$7,062.14	\$6,709.04
36x6	630366	CF	\$7,744.46	\$7,550.88	\$7,357.25	\$6,989.39	\$6,639.93	\$6,307.93
36x8	630368	CF	\$7,379.64	\$7,195.16	\$7,010.65	\$6,660.12	\$6,327.12	\$6,010.76
36x10	6303610	CF	\$6,968.10	\$6,793.91	\$6,619.70	\$6,288.72	\$5,974.28	\$5,675.57
36x12	6303612	CF	\$6,382.25	\$6,222.70	\$6,063.12	\$5,759.97	\$5,471.98	\$5,198.38
36x14	6303614	CF	\$6,188.58	\$6,033.89	\$5,879.16	\$5,585.21	\$5,305.95	\$5,040.66
36x16	6303616	CF	\$6,004.67	\$5,854.55	\$5,704.43	\$5,419.21	\$5,148.25	\$4,890.84
36x18	6303618	CF	\$5,825.79	\$5,680.14	\$5,534.50	\$5,257.78	\$4,994.90	\$4,745.16
36x20	6303620	CF	\$5,651.22	\$5,510.43	\$5,369.63	\$5,101.15	\$4,846.09	\$4,603.78
36x24	6303624	CF	\$5,086.09	\$4,958.96	\$4,831.81	\$4,590.23	\$4,360.71	\$4,142.68
36x30	6303630	CF	\$4,577.49	\$4,463.07	\$4,348.62	\$4,131.19	\$3,924.64	\$3,728.40
42x4	630424	CF	\$10,955.10	\$10,681.26	\$10,407.34	\$9,886.98	\$9,392.64	\$8,923.01
42x6	630426	CF	\$10,300.14	\$10,042.67	\$9,785.15	\$9,295.90	\$8,831.11	\$8,389.56
42x8	630428	CF	\$9,814.93	\$9,569.56	\$9,324.18	\$8,857.98	\$8,415.09	\$7,994.34
42x10	6304210	CF	\$9,267.59	\$9,035.91	\$8,804.20	\$8,364.00	\$7,945.80	\$7,548.52
42x12	6304212	CF	\$8,488.39	\$8,276.19	\$8,063.96	\$7,660.77	\$7,277.74	\$6,913.86
42x14	6304214	CF	\$8,230.81	\$8,025.08	\$7,819.29	\$7,428.33	\$7,056.92	\$6,704.07
42x16	6304216	CF	\$7,986.21	\$7,786.56	\$7,586.90	\$7,207.56	\$6,847.18	\$6,504.83
42x18	6304218	CF	\$7,748.30	\$7,554.59	\$7,360.90	\$6,992.86	\$6,643.23	\$6,311.07
42x20	6304220	CF	\$7,516.12	\$7,334.62	\$7,141.60	\$6,784.53	\$6,445.30	\$6,122.92
42x24	6304224	CF	\$6,764.51	\$6,595.41	\$6,426.30	\$6,104.99	\$5,799.75	\$5,509.75
42x30	6304230	CF	\$6,088.08	\$5,935.89	\$5,783.67	\$5,494.49	\$5,219.77	\$4,958.78
42x36	6304236	CF	\$5,479.27	\$5,342.29	\$5,205.30	\$4,945.05	\$4,697.80	\$4,462.90
48x4	630484	CF	\$14,570.28	\$14,206.08	\$13,841.77	\$13,149.69	\$12,492.21	\$11,867.61
48x6	630486	CF	\$13,699.19	\$13,356.77	\$13,014.26	\$12,363.56	\$11,745.39	\$11,158.13
48x8	630488	CF	\$13,053.86	\$12,727.52	\$12,401.16	\$11,781.11	\$11,192.05	\$10,632.45
48x10	6304810	CF	\$12,325.90	\$12,017.76	\$11,709.60	\$11,124.12	\$10,567.93	\$10,039.53
48x12	6304812	CF	\$11,289.56	\$11,007.34	\$10,725.07	\$10,188.83	\$9,679.39	\$9,195.42
48x14	6304814	CF	\$10,946.99	\$10,673.36	\$10,399.66	\$9,879.68	\$9,385.70	\$8,916.42
48x16	6304816	CF	\$10,621.66	\$10,356.12	\$10,090.57	\$9,586.04	\$9,106.75	\$8,651.40
48x18	6304818	CF	\$10,305.24	\$10,048.13	\$9,790.00	\$9,300.50	\$8,835.48	\$8,393.71
48x20	6304820	CF	\$9,996.46	\$9,747.40	\$9,498.33	\$9,023.42	\$8,572.25	\$8,143.64
48x24	6304824	CF	\$8,996.80	\$8,771.90	\$8,546.98	\$8,119.64	\$7,713.66	\$7,327.97
48x30	6304830	CF	\$8,097.15	\$7,894.73	\$7,692.29	\$7,307.69	\$6,942.30	\$6,595.18
48x36	6304836	CF	\$7,287.44	\$7,105.25	\$6,923.06	\$6,576.91	\$6,248.07	\$5,935.67
48x42	6304842	CF	\$6,558.69	\$6,394.74	\$6,230.76	\$5,919.21	\$5,623.26	\$5,342.10

C-900 GASKETED PRESSURE

REDUCER

GASKET X MALE

ECCENTRIC

(LEB)

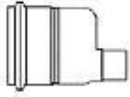

Size	PartNumber	DR 14 (49)	DR 18 (48)	DR21 (39PG)	DR 25 (47)	DR 41 (46)	DR 51 (45)	DR81 (12PC)
4x3	65043	\$228.03	\$182.42	\$177.87	\$173.31	CF	CF	CF
6x4	65064	\$285.05	\$228.03	\$222.34	\$216.64	CF	CF	CF
8x4	65084	\$383.28	\$306.62	\$291.30	\$291.30	CF	CF	CF
8x6	65086	\$335.35	\$268.27	\$261.58	\$254.86	CF	CF	CF
10x4	650104	\$499.48	\$399.58	\$389.60	\$379.60	CF	CF	CF
10x6	650106	\$451.69	\$361.34	\$352.31	\$343.28	CF	CF	CF
10x8	650108	\$414.03	\$331.22	\$327.87	\$324.48	CF	CF	CF
12x4	650124	\$670.71	\$536.57	\$523.16	\$509.74	CF	CF	CF
12x6	650126	\$609.11	\$487.28	\$475.10	\$462.91	CF	CF	CF
12x8	650128	\$568.07	\$454.45	\$443.10	\$431.72	CF	CF	CF
12x10	6501210	\$570.22	\$456.17	\$434.84	\$413.48	CF	CF	CF
14x4	650144	\$1,272.96	\$1,018.36	\$992.91	\$967.44	\$919.07	\$873.13	\$829.47
14x6	650146	\$1,245.54	\$996.43	\$971.53	\$946.61	\$899.29	\$854.34	\$811.62
14x8	650148	\$1,197.70	\$958.16	\$934.21	\$910.25	\$864.74	\$821.51	\$780.45
14x10	6501410	\$1,163.47	\$930.76	\$907.50	\$884.22	\$840.02	\$798.02	\$758.13
14x12	6501412	\$1,129.22	\$903.37	\$880.80	\$858.20	\$815.29	\$774.54	\$735.82
16x4	650164	\$1,851.25	\$1,480.99	\$1,443.97	\$1,406.94	\$1,336.60	\$1,269.77	\$1,206.29
16x6	650166	\$1,601.46	\$1,281.16	\$1,249.14	\$1,217.10	\$1,156.26	\$1,098.45	\$1,043.53
16x8	650168	\$1,570.65	\$1,256.51	\$1,225.11	\$1,193.69	\$1,134.02	\$1,077.32	\$1,023.47
16x10	6501610	\$1,454.28	\$1,163.42	\$1,134.35	\$1,105.25	\$1,050.00	\$997.50	\$947.63
16x12	6501612	\$1,420.09	\$1,136.06	\$1,107.67	\$1,079.26	\$1,025.31	\$974.05	\$925.36
16x14	6501614	\$1,356.17	\$1,084.93	\$1,057.82	\$1,030.69	\$979.16	\$930.20	\$883.69
18x4	650184	\$3,428.75	\$2,742.99	\$2,674.43	\$2,605.84	\$2,475.56	\$2,351.78	\$2,234.20
18x6	650186	\$3,226.82	\$2,581.45	\$2,516.92	\$2,452.38	\$2,329.76	\$2,213.28	\$2,102.63
18x8	650188	\$3,035.18	\$2,428.14	\$2,367.45	\$2,306.74	\$2,191.41	\$2,081.85	\$1,977.76
18x10	6501810	\$2,987.31	\$2,389.84	\$2,330.10	\$2,270.34	\$2,156.83	\$2,048.99	\$1,946.55
18x12	6501812	\$2,710.16	\$2,168.12	\$2,113.92	\$2,059.71	\$1,956.73	\$1,858.89	\$1,765.95
18x14	6501814	\$2,628.65	\$2,102.91	\$2,050.35	\$1,997.77	\$1,897.89	\$1,803.00	\$1,712.86
18x16	6501816	\$2,553.84	\$2,043.07	\$1,992.00	\$1,940.91	\$1,843.88	\$1,751.69	\$1,664.11
20x4	650204	CF	\$3,561.48	\$3,472.45	\$3,383.40	\$3,214.24	\$3,053.54	\$2,900.86
20x6	650206	CF	\$3,265.93	\$3,184.29	\$3,102.63	\$2,947.51	\$2,800.14	\$2,660.13
20x8	650208	CF	\$3,170.02	\$3,090.77	\$3,011.52	\$2,860.95	\$2,717.91	\$2,582.03
20x10	6502010	CF	\$2,707.35	\$2,639.68	\$2,571.99	\$2,443.39	\$2,321.23	\$2,205.17
20x12	6502012	CF	\$2,679.98	\$2,613.00	\$2,545.99	\$2,418.69	\$2,297.76	\$2,182.87
20x14	6502014	CF	\$2,600.61	\$2,535.60	\$2,470.58	\$2,347.06	\$2,229.71	\$2,118.23
20x16	6502016	CF	\$2,524.14	\$2,461.05	\$2,397.93	\$2,278.05	\$2,164.15	\$2,055.95
20x18	6502018	CF	\$2,447.45	\$2,386.27	\$2,325.08	\$2,208.83	\$2,098.39	\$1,993.47
24x4	650244	CF	\$4,656.51	\$4,540.11	\$4,423.68	\$4,202.50	\$3,992.39	\$3,792.77
24x6	650246	CF	\$4,378.12	\$4,268.67	\$4,159.22	\$3,951.26	\$3,753.70	\$3,566.02
24x8	650248	CF	\$4,171.88	\$4,067.58	\$3,963.28	\$3,765.12	\$3,576.87	\$3,398.03
24x10	6502410	CF	\$3,939.22	\$3,840.75	\$3,742.26	\$3,555.16	\$3,377.40	\$3,208.53
24x12	6502412	CF	\$3,608.02	\$3,517.83	\$3,427.62	\$3,256.25	\$3,093.44	\$2,938.78
24x14	6502414	CF	\$3,498.54	\$3,411.08	\$3,323.62	\$3,157.44	\$2,999.58	\$2,849.61
24x16	6502416	CF	\$3,394.57	\$3,309.71	\$3,224.84	\$3,063.60	\$2,910.43	\$2,764.91
24x18	6502418	CF	\$3,293.44	\$3,211.11	\$3,128.77	\$2,972.34	\$2,823.72	\$2,682.54
24x20	6502420	CF	\$2,964.10	\$2,890.01	\$2,815.90	\$2,675.11	\$2,407.61	\$2,414.29
30x4	650304	CF	\$6,193.16	\$6,038.35	\$5,883.50	\$5,589.33	\$5,309.87	\$5,044.38
30x6	650306	CF	\$5,822.90	\$5,677.34	\$5,531.76	\$5,255.18	\$4,992.43	\$4,742.81
30x8	650308	CF	\$5,548.60	\$5,409.89	\$5,271.16	\$5,007.61	\$4,757.23	\$4,519.37
30x10	6503010	CF	\$5,239.17	\$5,108.20	\$4,977.21	\$4,728.35	\$4,491.93	\$4,267.34
30x12	6503012	CF	\$4,798.67	\$4,678.71	\$4,558.74	\$4,330.81	\$4,114.27	\$3,908.56
30x14	6503014	CF	\$4,653.06	\$4,536.75	\$4,420.42	\$4,199.40	\$3,989.43	\$3,789.96
30x16	6503016	CF	\$4,514.79	\$4,401.92	\$4,289.04	\$4,074.60	\$3,870.87	\$3,677.32
30x18	6503018	CF	\$4,380.28	\$4,270.78	\$4,161.28	\$3,953.22	\$3,755.57	\$3,567.79
30x20	6503020	CF	\$3,942.26	\$3,843.71	\$3,745.16	\$3,557.89	\$3,202.12	\$3,211.01
30x24	6503024	CF	\$3,548.04	\$3,459.35	\$3,370.65	\$3,202.11	\$2,881.91	\$2,889.92

C-900 GASKETED PRESSURE

REDUCER

GASKET X MALE

ECCENTRIC

(LEB)

Size	PartNumber	DR 14 (49)	DR 18 (48)	DR21 (39PG)	DR 25 (47)	DR 41 (46)	DR 51 (45)	DR81 (12PC)
36x4	650364	CF	\$8,236.91	\$8,031.01	\$7,825.06	\$7,433.82	\$7,062.14	\$6,709.04
36x6	650366	CF	\$7,744.46	\$7,550.88	\$7,357.25	\$6,989.39	\$6,639.93	\$6,307.93
36x8	650368	CF	\$7,379.64	\$7,195.16	\$7,010.65	\$6,660.12	\$6,327.12	\$6,010.76
36x10	6503610	CF	\$6,968.10	\$6,793.91	\$6,619.70	\$6,288.72	\$5,974.28	\$5,675.57
36x12	6503612	CF	\$6,382.25	\$6,222.70	\$6,063.12	\$5,759.97	\$5,471.98	\$5,198.38
36x14	6503614	CF	\$6,188.58	\$6,033.89	\$5,879.16	\$5,585.21	\$5,305.95	\$5,040.66
36x16	6503616	CF	\$6,004.67	\$5,854.55	\$5,704.43	\$5,419.21	\$5,148.25	\$4,890.84
36x18	6503618	CF	\$5,825.79	\$5,680.14	\$5,534.50	\$5,257.78	\$4,994.90	\$4,745.16
36x20	6503620	CF	\$5,243.21	\$5,112.14	\$4,981.06	\$4,732.02	\$4,495.42	\$4,270.64
36x24	6503624	CF	\$4,718.90	\$4,600.94	\$4,482.98	\$4,258.83	\$4,045.90	\$3,843.60
36x30	6503630	CF	\$4,247.01	\$4,140.85	\$4,034.67	\$3,832.94	\$3,641.30	\$3,461.30
42x4	650424	CF	\$10,955.10	\$10,681.26	\$10,407.34	\$9,886.98	\$9,392.64	\$8,923.01
42x6	650426	CF	\$10,300.14	\$10,042.67	\$9,785.15	\$9,295.90	\$8,831.11	\$8,389.56
42x8	650428	CF	\$9,814.93	\$9,569.56	\$9,324.18	\$8,857.98	\$8,415.09	\$7,994.34
42x10	6504210	CF	\$9,267.59	\$9,035.91	\$8,804.20	\$8,364.00	\$7,945.80	\$7,548.52
42x12	6504212	CF	\$8,488.39	\$8,276.19	\$8,063.96	\$7,660.77	\$7,277.74	\$6,913.86
42x14	6504214	CF	\$8,230.81	\$8,025.08	\$7,819.29	\$7,428.33	\$7,056.92	\$6,704.07
42x16	6504216	CF	\$7,986.21	\$7,786.56	\$7,586.90	\$7,207.56	\$6,847.18	\$6,504.83
42x18	6504218	CF	\$7,748.30	\$7,554.59	\$7,360.90	\$6,992.86	\$6,643.23	\$6,311.07
42x20	6504220	CF	\$6,973.47	\$6,799.16	\$6,624.82	\$6,293.58	\$5,978.91	\$5,679.95
42x24	6504224	CF	\$6,276.14	\$6,119.25	\$5,962.36	\$5,664.24	\$5,381.03	\$5,111.98
42x30	6504230	CF	\$5,648.52	\$5,507.41	\$5,366.27	\$5,097.96	\$4,843.06	\$4,600.91
42x36	6504236	CF	\$5,083.68	\$4,956.67	\$4,829.64	\$4,588.17	\$4,358.76	\$4,140.82
48x4	650484	CF	\$14,570.28	\$14,206.08	\$13,841.77	\$13,149.69	\$12,492.21	\$11,867.61
48x6	650486	CF	\$13,699.19	\$13,356.77	\$13,014.26	\$12,363.56	\$11,745.39	\$11,158.13
48x8	650488	CF	\$13,053.86	\$12,727.52	\$12,401.16	\$11,781.11	\$11,192.05	\$10,632.45
48x10	6504810	CF	\$12,325.90	\$12,017.76	\$11,709.60	\$11,124.12	\$10,567.93	\$10,039.53
48x12	6504812	CF	\$11,289.56	\$11,007.34	\$10,725.07	\$10,188.83	\$9,679.39	\$9,195.42
48x14	6504814	CF	\$10,946.99	\$10,673.36	\$10,399.66	\$9,879.68	\$9,385.70	\$8,916.42
48x16	6504816	CF	\$10,621.66	\$10,356.12	\$10,090.57	\$9,586.04	\$9,106.75	\$8,651.40
48x18	6504818	CF	\$10,305.24	\$10,048.13	\$9,790.00	\$9,300.50	\$8,835.48	\$8,393.71
48x20	6504820	CF	\$9,274.73	\$9,042.88	\$8,811.01	\$8,370.47	\$7,951.94	\$7,554.35
48x24	6504824	CF	\$8,347.26	\$8,138.61	\$7,929.94	\$7,533.45	\$7,156.77	\$6,798.94
48x30	6504830	CF	\$7,512.55	\$7,324.86	\$7,137.14	\$6,780.29	\$6,441.28	\$6,119.21
48x36	6504836	CF	\$6,761.30	\$6,592.38	\$6,423.43	\$6,102.27	\$5,797.15	\$5,507.29
48x42	6504842	CF	\$6,085.17	\$5,933.14	\$5,781.08	\$5,492.03	\$5,217.44	\$4,956.56

TEE

TAPPED (CID x CID x IPS)

GASKET X GASKET X 2 INCH FIPT

Size	PartNumber	DR 14 (49)	DR 18 (48)	DR21 (39PG)	DR 25 (47)	DR 41 (46)	DR 51 (45)	DR81 (12PC)
4	7904	CF	\$176.97	CF	CF	CF	CF	CF
6	7906	CF	\$307.69	CF	CF	CF	CF	CF
8	7908	CF	\$453.53	CF	CF	CF	CF	CF

C-900 GASKETED PRESSURE

TEE

GASKET X GASKET X GASKET

STRAIGHT

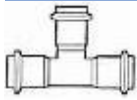

Size	PartNumber	DR 14 (49)	DR 18 (48)	DR21 (39PG)	DR 25 (47)	DR 41 (46)	DR 51 (45)	DR81 (12PC)
4	8204	\$280.13	\$230.72	\$186.75	\$186.75	CF	CF	CF
6x4	82064	\$609.71	\$502.09	\$406.39	\$406.39	CF	CF	CF
6	8206	\$626.53	\$516.03	\$417.68	\$417.68	CF	CF	CF
8x4	82084	\$2,072.69	\$871.42	\$705.33	\$705.33	CF	CF	CF
8x6	82086	\$2,109.82	\$892.58	\$722.46	\$722.46	CF	CF	CF
8	8208	\$2,146.89	\$912.82	\$738.84	\$738.84	CF	CF	CF
10x4	820104	\$2,183.95	\$767.89	\$748.70	\$729.49	CF	CF	CF
10x6	820106	\$2,221.00	\$902.12	\$879.58	\$857.01	CF	CF	CF
10x8	820108	\$2,258.16	\$967.59	\$943.40	\$919.21	CF	CF	CF
10	82010	\$2,295.20	\$1,075.11	\$1,048.25	\$1,021.36	CF	CF	CF
12x4	820124	\$2,332.28	\$1,003.00	\$977.93	\$952.84	CF	CF	CF
12x6	820126	\$2,369.28	\$1,162.31	\$1,133.26	\$1,104.20	CF	CF	CF
12x8	820128	\$2,405.82	\$1,236.87	\$1,205.96	\$1,175.02	CF	CF	CF
12x10	8201210	\$2,443.42	\$1,253.65	\$1,222.31	\$1,190.96	CF	CF	CF
12	82012	\$2,480.54	\$1,269.96	\$1,238.22	\$1,206.45	CF	CF	CF
14x4	820144	\$4,026.73	\$1,949.11	\$1,900.40	\$1,851.66	\$1,759.09	\$1,671.13	\$1,587.59
14x6	820146	\$4,211.08	\$2,030.08	\$1,979.35	\$1,928.58	\$1,832.16	\$1,740.56	\$1,653.54
14x8	820148	\$4,395.37	\$2,151.50	\$2,092.75	\$2,033.98	\$1,932.29	\$1,835.68	\$1,743.89
14x10	8201410	\$4,579.78	\$2,245.49	\$2,194.97	\$2,144.44	\$2,037.23	\$1,935.37	\$1,838.61
14x12	8201412	\$4,764.09	\$2,371.48	\$2,318.14	\$2,264.76	\$2,151.54	\$2,043.96	\$1,941.78
14	82014	\$4,948.42	\$2,527.07	\$2,470.21	\$2,413.34	\$2,292.69	\$2,178.05	\$2,069.16
16x4	820164	\$5,132.80	\$2,434.94	\$2,374.07	\$2,313.19	\$2,197.54	\$2,087.66	\$1,983.29
16x6	820166	\$5,317.11	\$2,515.89	\$2,453.00	\$2,390.09	\$2,270.59	\$2,157.07	\$2,049.22
16x8	820168	\$5,501.45	\$2,596.87	\$2,531.96	\$2,467.03	\$2,343.68	\$2,226.50	\$2,115.18
16x10	8201610	\$5,685.84	\$2,677.86	\$2,610.91	\$2,543.96	\$1,935.37	\$1,838.61	\$1,746.69
16x12	8201612	\$5,870.14	\$2,758.80	\$2,689.84	\$2,620.86	\$2,489.82	\$2,365.33	\$2,247.07
16x14	8201614	\$6,054.46	\$2,839.78	\$2,768.79	\$2,697.79	\$2,562.90	\$2,434.76	\$2,313.03
16	82016	\$6,238.83	\$2,920.76	\$2,847.75	\$2,774.72	\$2,636.00	\$2,504.21	\$2,379.01
18x4	820184	CF	\$3,860.35	\$3,773.51	\$3,686.64	\$3,502.31	\$3,327.20	\$3,160.84
18x6	820186	CF	\$3,978.40	\$3,888.90	\$3,799.37	\$3,609.41	\$3,428.94	\$3,257.50
18x8	820188	CF	\$4,042.78	\$3,951.83	\$3,860.85	\$3,667.81	\$3,484.43	\$3,310.22
18x10	8201810	CF	\$4,286.91	\$4,190.46	\$4,094.00	\$3,889.30	\$3,694.85	\$3,510.11
18x12	8201812	CF	\$4,528.36	\$4,426.48	\$4,324.58	\$4,108.35	\$3,902.94	\$3,707.80
18x14	8201814	CF	\$5,121.23	\$5,006.01	\$4,890.77	\$4,646.23	\$4,413.93	\$4,193.25
18x16	8201816	CF	\$5,461.95	\$5,339.06	\$5,216.16	\$4,955.36	\$4,707.59	\$4,472.22
18	82018	CF	\$5,736.61	\$5,607.55	\$5,478.46	\$5,204.54	\$4,944.32	\$4,697.11
20x4	820204	CF	\$4,439.84	\$4,339.95	\$4,240.05	\$4,028.06	\$3,826.66	\$3,635.33
20x6	820206	CF	\$4,574.67	\$4,471.74	\$4,368.80	\$4,150.37	\$3,942.86	\$3,745.72
20x8	820208	CF	\$4,689.32	\$4,583.82	\$4,478.30	\$4,254.39	\$4,041.68	\$3,839.60
20x10	8202010	CF	\$4,836.90	\$4,728.08	\$4,619.24	\$4,388.29	\$4,168.88	\$3,960.44
20x12	8202012	CF	\$5,107.78	\$4,992.86	\$4,877.93	\$4,634.04	\$4,402.35	\$4,182.24
20x14	8202014	CF	\$5,453.90	\$5,331.19	\$5,208.48	\$4,948.06	\$4,700.66	\$4,465.63
20x16	8202016	CF	\$5,719.46	\$5,590.78	\$5,462.09	\$5,188.98	\$4,929.54	\$4,683.08
20x18	8202018	CF	\$6,467.96	\$6,322.44	\$6,176.90	\$5,868.06	\$5,574.66	\$5,295.93
20	82020	CF	\$6,658.40	\$6,508.59	\$6,358.76	\$6,040.84	\$5,738.80	\$5,451.86
24x4	820244	CF	\$6,371.37	\$6,228.02	\$6,084.66	\$5,780.43	\$5,491.41	\$5,216.85
24x6	820246	CF	\$6,567.22	\$6,419.47	\$6,271.70	\$5,958.12	\$5,660.22	\$5,377.22
24x8	820248	CF	\$6,647.69	\$6,498.12	\$6,348.54	\$6,031.12	\$5,729.56	\$5,443.09
24x10	8202410	CF	\$6,736.21	\$6,584.65	\$6,433.08	\$6,111.43	\$5,805.87	\$5,515.58
24x12	8202412	CF	\$6,784.48	\$6,631.84	\$6,479.18	\$6,155.23	\$5,847.47	\$5,555.11
24x14	8202414	CF	\$7,045.30	\$6,886.79	\$6,728.26	\$6,391.85	\$6,072.26	\$5,768.65
24x16	8202416	CF	\$7,181.52	\$7,019.95	\$6,858.35	\$6,515.44	\$6,189.68	\$5,880.20
24x18	8202418	CF	\$8,949.44	\$8,748.08	\$8,546.71	\$8,119.38	\$7,713.42	\$7,327.75
24x20	8202420	CF	\$9,064.77	\$8,860.82	\$8,656.86	\$8,224.02	\$7,812.82	\$7,422.19
24	82024	CF	\$9,301.92	\$9,092.64	\$8,883.34	\$8,439.17	\$8,017.21	\$7,616.36

C-900 GASKETED PRESSURE

TEE

GASKET X GASKET X GASKET

STRAIGHT

Size	PartNumber	DR 14 (49)	DR 18 (48)	DR21 (39PG)	DR 25 (47)	DR 41 (46)	DR 51 (45)	DR81 (12PC)
30x4	820304	CF	\$8,473.92	\$8,283.28	\$8,092.61	\$7,687.98	\$7,303.59	\$6,938.42
30x6	820306	CF	\$8,734.41	\$8,537.90	\$8,341.36	\$7,924.31	\$7,528.10	\$7,151.70
30x8	820308	CF	\$8,841.43	\$8,642.50	\$8,443.56	\$8,021.39	\$7,620.33	\$7,239.32
30x10	8203010	CF	\$8,959.16	\$8,757.58	\$8,556.00	\$8,128.20	\$7,721.80	\$7,335.71
30x12	8203012	CF	\$9,023.37	\$8,820.35	\$8,617.32	\$8,186.46	\$7,777.14	\$7,388.29
30x14	8203014	CF	\$9,370.26	\$9,159.43	\$8,948.59	\$8,501.17	\$8,076.12	\$7,673.47
30x16	8203016	CF	\$9,551.43	\$9,336.53	\$9,121.60	\$8,665.53	\$8,232.25	\$7,820.64
30x18	8203018	CF	\$11,902.75	\$11,634.95	\$11,367.13	\$10,798.78	\$10,258.84	\$9,745.91
30x20	8203020	CF	\$12,056.15	\$11,784.90	\$11,513.63	\$10,937.95	\$10,391.06	\$9,871.51
30x24	8203024	CF	\$12,213.86	\$11,939.07	\$10,937.95	\$10,391.06	\$10,527.00	\$10,000.65
30	82030	CF	\$12,371.56	\$12,093.22	\$11,814.85	\$11,224.12	\$10,662.92	\$10,129.78
36x4	820364	CF	\$11,270.32	\$11,016.76	\$10,763.17	\$10,225.02	\$9,713.77	\$9,228.09
36x6	820366	CF	\$11,616.77	\$11,355.40	\$11,094.02	\$10,539.32	\$10,012.36	\$9,511.75
36x8	820368	CF	\$11,759.11	\$11,494.54	\$11,229.95	\$10,668.46	\$10,135.04	\$9,628.29
36x10	8203610	CF	\$11,915.68	\$11,647.59	\$11,379.49	\$10,810.52	\$10,269.99	\$9,756.50
36x12	8203612	CF	\$12,001.09	\$11,731.07	\$11,461.04	\$10,887.99	\$10,343.59	\$9,826.42
36x14	8203614	CF	\$12,462.45	\$12,182.04	\$11,901.63	\$11,306.55	\$10,741.23	\$10,204.18
36x16	8203616	CF	\$12,703.41	\$12,417.59	\$12,131.74	\$11,525.16	\$10,948.91	\$10,401.47
36x18	8203618	CF	\$15,830.67	\$15,474.49	\$15,118.29	\$14,362.38	\$13,644.27	\$12,962.06
36x20	8203620	CF	\$16,034.69	\$15,673.93	\$15,313.14	\$14,547.49	\$13,820.13	\$13,129.12
36x24	8203624	CF	\$16,244.44	\$15,878.97	\$14,547.48	\$13,820.11	\$14,000.92	\$13,300.88
36x30	8203630	CF	\$16,349.32	\$15,981.48	\$15,130.62	\$14,374.10	\$14,091.30	\$13,386.75
36	82036	CF	\$16,454.19	\$16,083.98	\$15,713.75	\$14,928.07	\$14,181.67	\$13,472.60
42x4	820424	CF	\$14,989.54	\$14,652.29	\$14,315.03	\$13,599.28	\$12,919.32	\$12,273.36
42x6	820426	CF	\$15,450.31	\$15,102.69	\$14,755.05	\$14,017.30	\$13,316.45	\$12,650.63
42x8	820428	CF	\$15,639.62	\$15,287.73	\$14,935.83	\$14,189.05	\$13,479.60	\$12,805.63
42x10	8204210	CF	\$15,847.86	\$15,491.31	\$15,134.72	\$14,377.99	\$13,659.10	\$12,976.15
42x12	8204212	CF	\$15,961.46	\$15,602.33	\$15,243.18	\$14,481.03	\$13,756.99	\$13,069.15
42x14	8204214	CF	\$16,575.07	\$16,202.12	\$15,829.16	\$15,037.71	\$14,285.83	\$13,571.54
42x16	8204216	CF	\$16,895.54	\$16,515.39	\$16,135.22	\$15,328.47	\$14,562.05	\$13,833.95
42x18	8204218	CF	\$21,054.80	\$20,581.08	\$20,107.34	\$19,101.97	\$18,146.87	\$17,239.54
42x20	8204220	CF	\$21,326.14	\$20,846.31	\$20,366.48	\$19,348.16	\$18,380.76	\$17,461.73
42x24	8204224	CF	\$21,605.11	\$21,119.04	\$19,348.15	\$19,232.88	\$18,621.23	\$17,690.17
42x30	8204230	CF	\$21,744.60	\$21,255.38	\$20,123.72	\$19,117.57	\$18,741.42	\$17,804.38
42x36	8204236	CF	\$21,814.35	\$21,323.54	\$20,511.52	\$19,485.96	\$18,801.53	\$17,861.47
42	82042	CF	\$21,884.07	\$21,391.69	\$20,899.30	\$19,854.34	\$18,861.62	\$17,918.54
48x4	820484	CF	\$19,936.09	\$19,487.56	\$19,039.00	\$18,087.05	\$17,182.70	\$16,323.57
48x6	820486	CF	\$20,548.91	\$20,086.58	\$19,624.22	\$18,643.02	\$17,710.87	\$16,825.34
48x8	820488	CF	\$20,800.71	\$20,332.69	\$19,864.66	\$18,871.43	\$17,927.87	\$17,031.48
48x10	8204810	CF	\$21,077.66	\$20,603.43	\$20,129.19	\$19,122.73	\$18,166.60	\$17,258.27
48x12	8204812	CF	\$21,228.75	\$20,751.11	\$20,273.44	\$19,259.77	\$18,296.79	\$17,381.95
48x14	8204814	CF	\$22,044.84	\$21,548.84	\$21,052.80	\$20,000.17	\$19,000.16	\$18,050.16
48x16	8204816	CF	\$22,471.07	\$21,965.47	\$21,459.85	\$20,386.87	\$19,367.53	\$18,399.16
48x18	8204818	CF	\$28,002.89	\$27,372.84	\$26,742.77	\$25,405.64	\$24,135.36	\$22,928.60
48x20	8204820	CF	\$28,363.77	\$27,725.60	\$27,087.42	\$25,733.06	\$24,446.41	\$23,224.10
48x24	8204824	CF	\$28,734.80	\$28,088.32	\$25,733.04	\$25,579.71	\$24,766.24	\$23,526.88
48x30	8204830	CF	\$28,920.33	\$28,269.67	\$26,764.56	\$25,426.37	\$24,926.10	\$23,679.83
48x36	8204836	CF	\$21,568.95	\$28,360.31	\$27,280.32	\$25,916.33	\$25,006.05	\$23,755.76
48x42	8204842	CF	\$25,337.40	\$28,405.64	\$27,538.20	\$26,162.45	\$25,046.01	\$23,793.72
48	82048	CF	\$29,105.82	\$28,450.95	\$27,796.06	\$26,406.27	\$25,085.96	\$23,831.67

C-900 GASKETED PRESSURE

CROSS

GASKET X GASKET X GASKET X GASKET

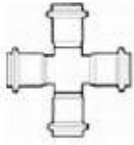

Size	PartNumber	DR 14 (49)	DR 18 (48)	DR21 (39PG)	DR 25 (47)	DR 41 (46)	DR 51 (45)	DR81 (12PC)
4x2	2604-2	\$412.57	\$330.05	\$317.47	\$304.88	CF	CF	CF
4x3	26043	\$434.27	\$347.42	\$334.18	\$320.92	CF	CF	CF
4	2604	\$457.14	\$365.70	\$351.76	\$337.81	CF	CF	CF
6x2	26062	\$504.06	\$403.24	\$392.13	\$381.01	CF	CF	CF
6x3	26063	\$530.58	\$424.45	\$412.77	\$401.06	CF	CF	CF
6x4	26064	\$555.63	\$444.50	\$433.39	\$422.27	CF	CF	CF
6	2606	\$571.41	\$457.13	\$445.71	\$434.27	CF	CF	CF
8x4	26084	\$771.86	\$617.48	\$602.05	\$586.60	CF	CF	CF
8x6	26086	\$812.49	\$649.98	\$625.09	\$600.20	CF	CF	CF
8	2608	\$894.06	\$715.24	\$664.62	\$613.99	CF	CF	CF
10x4	260104	\$1,200.32	\$960.25	\$936.25	\$912.24	CF	CF	CF
10x6	260106	\$1,409.75	\$1,127.79	\$1,099.61	\$1,071.41	CF	CF	CF
10x8	260108	\$1,553.63	\$1,242.90	\$1,211.84	\$1,180.75	CF	CF	CF
10	26010	\$1,679.20	\$1,343.35	\$1,309.77	\$1,276.18	CF	CF	CF
12x4	260124	\$1,567.70	\$1,254.16	\$1,222.81	\$1,191.45	CF	CF	CF
12x6	260126	\$1,816.03	\$1,452.82	\$1,416.50	\$1,380.17	CF	CF	CF
12x8	260128	\$1,932.56	\$1,546.05	\$1,507.41	\$1,468.75	CF	CF	CF
12x10	2601210	\$1,958.67	\$1,566.93	\$1,527.76	\$1,488.58	CF	CF	CF
12	26012	\$1,984.66	\$1,587.72	\$1,548.04	\$1,508.34	CF	CF	CF
14x4	260144	\$3,045.48	\$2,436.38	\$2,375.47	\$2,314.56	\$2,198.83	\$2,088.89	\$1,984.45
14x6	260146	\$3,171.62	\$2,537.29	\$2,473.87	\$2,410.42	\$2,289.90	\$2,175.41	\$2,066.64
14x8	260148	\$3,496.20	\$2,796.95	\$2,734.02	\$2,671.08	\$2,537.53	\$2,410.66	\$2,290.13
14x10	2601410	\$3,648.93	\$2,919.14	\$2,853.46	\$2,787.77	\$2,648.39	\$2,515.98	\$2,390.18
14x12	2601412	\$3,853.67	\$3,082.93	\$3,013.58	\$2,944.20	\$2,797.00	\$2,657.16	\$2,524.31
14	26014	\$4,106.50	\$3,285.19	\$3,211.28	\$3,137.36	\$2,980.50	\$2,831.48	\$2,689.92
16x4	260164	\$3,803.99	\$3,043.19	\$2,967.12	\$2,891.03	\$2,746.49	\$2,609.17	\$2,478.71
16x6	260166	\$3,931.84	\$3,145.47	\$3,066.84	\$2,988.19	\$2,838.79	\$2,696.85	\$2,562.02
16x8	260168	\$4,058.28	\$3,246.62	\$3,165.47	\$3,084.29	\$2,930.09	\$2,783.59	\$2,644.41
16x10	2601610	\$4,185.17	\$3,348.13	\$3,264.44	\$3,180.73	\$3,021.69	\$2,870.62	\$2,727.10
16x12	2601612	\$4,221.11	\$3,376.88	\$3,292.47	\$3,208.04	\$3,047.65	\$2,895.27	\$2,750.51
16x14	2601614	\$4,564.26	\$3,651.40	\$3,511.97	\$3,372.52	\$3,203.90	\$3,043.72	\$2,891.54
16	26016	\$4,629.60	\$3,703.68	\$3,620.35	\$3,537.01	\$3,360.16	\$3,192.16	\$3,032.56
18x4	260184	\$6,273.09	\$5,018.46	\$4,905.56	\$4,792.64	\$4,553.01	\$4,325.37	\$4,109.11
18x6	260186	\$6,464.91	\$5,171.92	\$5,055.56	\$4,939.18	\$4,692.23	\$4,457.63	\$4,234.76
18x8	260188	\$6,569.52	\$5,255.62	\$5,137.37	\$5,019.12	\$4,768.16	\$4,529.76	\$4,303.28
18x10	2601810	\$6,966.25	\$5,572.99	\$5,447.61	\$5,322.21	\$5,056.10	\$4,803.30	\$4,563.14
18x12	2601812	\$7,358.59	\$5,886.86	\$5,754.42	\$5,621.95	\$5,340.85	\$5,073.81	\$4,820.12
18x14	2601814	\$8,322.00	\$6,657.59	\$6,507.80	\$6,358.01	\$6,040.11	\$5,738.11	\$5,451.21
18x16	2601816	\$8,875.68	\$7,100.54	\$6,925.25	\$6,749.96	\$6,412.47	\$6,091.85	\$5,787.26
18	26018	\$9,322.00	\$7,457.60	\$7,289.82	\$7,122.01	\$6,765.91	\$6,427.63	\$6,106.25
20x4	260204	CF	\$5,771.79	\$5,641.93	\$5,512.07	\$5,238.77	\$4,976.83	\$4,728.00
20x6	260206	CF	\$5,947.06	\$5,813.26	\$5,679.45	\$5,395.48	\$5,125.71	\$4,869.43
20x8	260208	CF	\$6,096.12	\$5,958.97	\$5,821.79	\$5,530.71	\$5,254.18	\$4,991.47
20x10	2602010	CF	\$6,287.97	\$6,146.50	\$6,005.01	\$5,704.77	\$5,419.54	\$5,148.56
20x12	2602012	CF	\$6,640.12	\$6,490.73	\$6,341.32	\$6,024.26	\$5,724.21	\$5,438.01
20x14	2602014	CF	\$7,090.07	\$6,930.56	\$6,771.02	\$6,432.47	\$6,110.85	\$5,805.32
20x16	2602016	CF	\$7,435.29	\$7,268.00	\$7,100.70	\$6,745.67	\$6,408.40	\$6,087.99
20x18	2602018	CF	\$8,408.34	\$8,219.17	\$8,029.97	\$7,628.48	\$7,247.06	\$6,884.72
20	26020	CF	\$8,655.91	\$8,461.16	\$8,266.40	\$7,853.09	\$7,460.44	\$7,087.43
24x4	260244	CF	\$8,282.78	\$8,096.43	\$7,910.06	\$7,514.56	\$7,138.84	\$6,781.91
24x6	260246	CF	\$8,537.39	\$8,345.31	\$8,153.21	\$7,745.56	\$7,358.29	\$6,990.38
24x8	260248	CF	\$8,642.00	\$8,447.56	\$8,253.10	\$7,840.45	\$7,448.44	\$7,076.02
24x10	2602410	CF	\$8,757.07	\$8,560.04	\$8,363.00	\$7,944.86	\$7,547.62	\$7,170.25
24x12	2602412	CF	\$8,819.83	\$8,621.40	\$8,422.95	\$8,001.80	\$7,601.72	\$7,221.64
24x14	2602414	CF	\$9,158.90	\$8,952.83	\$8,746.75	\$8,305.97	\$7,890.68	\$7,496.15
24x16	2602416	CF	\$9,335.98	\$9,125.93	\$8,915.86	\$8,470.07	\$8,046.57	\$7,644.25
24x18	2602418	CF	\$11,634.27	\$11,372.51	\$11,110.74	\$10,555.21	\$10,027.45	\$9,526.08
24x20	2602420	CF	\$11,784.20	\$11,519.07	\$11,253.91	\$10,691.22	\$10,156.66	\$9,648.83
24	26024	CF	\$12,092.50	\$11,820.44	\$11,548.35	\$10,970.93	\$10,422.39	\$9,901.28

C-900 GASKETED PRESSURE

CROSS

GASKET X GASKET X GASKET X GASKET

Size	PartNumber	DR 14 (49)	DR 18 (48)	DR21 (39PG)	DR 25 (47)	DR 41 (46)	DR 51 (45)	DR81 (12PC)
30x6	260306	CF	\$11,354.74	\$11,099.27	\$10,843.78	\$10,301.60	\$9,786.52	\$9,297.20
30x8	260308	CF	\$11,493.86	\$11,235.26	\$10,976.64	\$10,427.80	\$9,906.42	\$8,832.35
30x10	2603010	CF	\$11,646.90	\$11,384.85	\$11,122.79	\$10,566.66	\$10,038.34	\$9,536.43
30x12	2603012	CF	\$11,730.38	\$11,466.47	\$11,202.52	\$10,642.40	\$10,110.28	\$9,604.78
30x14	2603014	CF	\$12,181.34	\$11,907.27	\$11,633.18	\$11,046.95	\$10,494.60	\$9,969.88
30x16	2603016	CF	\$12,416.85	\$12,137.49	\$11,858.10	\$11,265.20	\$10,701.95	\$10,166.85
30x18	2603018	CF	\$15,473.60	\$15,125.44	\$14,777.28	\$14,038.43	\$13,336.52	\$12,669.70
30x20	2603020	CF	\$15,672.99	\$15,320.37	\$14,967.71	\$14,219.32	\$13,508.36	\$12,832.95
30x24	2603024	CF	\$15,878.03	\$15,520.79	\$15,163.51	\$14,405.35	\$13,685.09	\$13,000.84
30	26030	CF	\$16,083.04	\$15,721.19	\$15,359.31	\$14,591.35	\$13,861.79	\$13,168.71
36x6	260366	CF	\$15,101.81	\$14,762.03	\$14,422.23	\$13,701.12	\$13,016.07	\$12,365.27
36x8	260368	CF	\$15,286.84	\$14,942.90	\$14,598.93	\$13,868.98	\$13,175.54	\$12,516.77
36x10	2603610	CF	\$15,490.39	\$15,141.85	\$14,793.31	\$14,053.67	\$13,350.99	\$12,683.45
36x12	2603612	CF	\$15,601.41	\$15,250.40	\$14,899.35	\$14,154.40	\$13,446.69	\$12,774.36
36x14	2603614	CF	\$16,201.19	\$15,836.67	\$15,472.13	\$14,692.45	\$13,957.83	\$13,259.94
36x16	2603616	CF	\$16,514.41	\$16,142.87	\$15,771.27	\$14,982.73	\$14,233.60	\$13,521.92
36x18	2603618	CF	\$20,579.88	\$20,116.85	\$19,653.79	\$18,671.11	\$17,737.57	\$16,850.70
36x20	2603620	CF	\$20,845.08	\$20,376.09	\$19,907.06	\$18,911.70	\$17,966.13	\$17,067.83
36x24	2603624	CF	\$21,117.77	\$20,642.66	\$20,167.47	\$19,159.12	\$18,201.17	\$17,291.11
36x30	2603630	CF	\$21,254.12	\$20,775.93	\$20,297.68	\$19,282.82	\$18,318.68	\$17,402.75
36	26036	CF	\$21,390.45	\$20,909.19	\$20,427.89	\$19,406.50	\$18,436.18	\$17,514.37
42x6	260426	CF	\$20,085.42	\$19,633.51	\$19,181.57	\$18,222.50	\$17,311.38	\$16,445.81
42x8	260428	CF	\$20,331.49	\$19,874.07	\$19,416.58	\$18,445.75	\$17,523.47	\$16,647.30
42x10	2604210	CF	\$20,602.22	\$20,138.67	\$19,675.11	\$18,691.39	\$17,756.83	\$16,868.99
42x12	2604212	CF	\$20,749.88	\$20,283.04	\$19,816.14	\$18,825.35	\$17,884.09	\$16,989.89
42x14	2604214	CF	\$21,547.58	\$21,063.09	\$20,577.94	\$19,540.96	\$18,563.92	\$17,635.73
42x16	2604216	CF	\$21,964.17	\$21,470.03	\$20,975.79	\$19,927.04	\$18,930.69	\$17,984.16
42x18	2604218	CF	\$27,371.25	\$26,755.42	\$26,139.55	\$24,832.58	\$23,590.96	\$22,411.42
42x20	2604220	CF	\$27,723.97	\$27,100.21	\$26,476.40	\$25,152.57	\$23,894.95	\$22,700.21
42x24	2604224	CF	\$28,086.65	\$27,454.74	\$26,822.74	\$25,481.63	\$24,207.56	\$22,997.18
42x30	2604230	CF	\$28,267.98	\$27,631.99	\$26,995.93	\$25,646.16	\$24,363.85	\$23,145.67
42x36	2604236	CF	\$28,358.64	\$27,720.61	\$27,083.10	\$25,728.42	\$24,442.01	\$23,219.91
42	26042	CF	\$28,449.30	\$27,809.22	\$27,169.10	\$25,810.66	\$24,520.13	\$23,294.12
48x6	260486	CF	\$26,713.61	\$26,112.58	\$25,511.50	\$24,235.92	\$23,024.13	\$21,872.92
48x8	260488	CF	\$27,040.89	\$26,432.52	\$25,824.06	\$24,532.85	\$23,306.21	\$22,140.90
48x10	2604810	CF	\$27,400.96	\$26,784.44	\$26,167.91	\$24,859.55	\$23,616.58	\$22,435.76
48x12	2604812	CF	\$27,597.34	\$26,976.46	\$26,355.48	\$25,037.72	\$23,785.84	\$22,596.56
48x14	2604814	CF	\$28,658.29	\$28,013.92	\$27,368.67	\$25,989.48	\$24,690.02	\$23,455.53
48x16	2604816	CF	\$36,403.77	\$28,555.14	\$27,897.82	\$26,502.97	\$25,177.82	\$23,918.94
48x18	2604818	CF	\$36,403.77	\$35,584.71	\$34,765.60	\$33,027.34	\$31,375.98	\$29,807.18
48x20	2604820	CF	\$36,872.89	\$36,043.29	\$35,213.62	\$33,452.93	\$31,780.28	\$30,191.27
48x24	2604824	CF	\$37,355.24	\$36,514.81	\$35,674.24	\$33,890.58	\$32,196.06	\$30,586.26
48x30	2604830	CF	\$37,596.42	\$36,750.55	\$35,904.59	\$34,109.40	\$32,403.94	\$30,783.75
48x36	2604836	CF	\$37,717.00	\$36,868.43	\$36,020.53	\$34,218.80	\$32,507.87	\$30,882.48
48x42	2604842	CF	\$37,777.29	\$36,927.35	\$36,077.72	\$34,273.50	\$32,559.82	\$30,931.84
48	26048	CF	\$37,837.58	\$36,986.27	\$36,134.90	\$34,328.18	\$32,611.78	\$30,981.20

C-900 GASKETED PRESSURE

WYE

GASKET X GASKET X GASKET



Size	PartNumber	DR 14 (49)	DR 18 (48)	DR21 (39PG)	DR 25 (47)	DR 41 (46)	DR 51 (45)	DR81 (12PC)
4	9204	\$498.86	\$332.57	\$326.81	\$280.13	CF	CF	CF
6x4	92064	\$1,066.79	\$711.18	\$711.18	\$609.59	CF	CF	CF
6	9206	\$1,096.42	\$730.94	\$730.94	\$626.53	CF	CF	CF
8x4	92084	\$1,841.15	\$1,234.33	\$1,146.17	\$1,058.00	CF	CF	CF
8x6	92086	\$1,897.99	\$1,265.32	\$1,174.52	\$1,083.70	CF	CF	CF
8	9208	\$1,939.46	\$1,292.97	\$1,200.62	\$1,108.27	CF	CF	CF
10x4	920104	\$1,727.77	\$1,151.84	\$1,123.06	\$1,094.25	CF	CF	CF
10x6	920106	\$2,029.78	\$1,353.18	\$1,319.36	\$1,285.53	CF	CF	CF
10x8	920108	\$2,177.10	\$1,451.39	\$1,415.11	\$1,378.82	CF	CF	CF
10	92010	\$2,419.01	\$1,612.67	\$1,572.36	\$1,532.04	CF	CF	CF
12x4	920124	\$2,256.76	\$1,504.50	\$1,466.89	\$1,429.28	CF	CF	CF
12x6	920126	\$2,615.22	\$1,743.47	\$1,699.90	\$1,656.30	CF	CF	CF
12x8	920128	\$2,782.99	\$1,855.32	\$1,808.94	\$1,762.55	CF	CF	CF
12x10	9201210	\$2,820.73	\$1,880.48	\$1,833.59	\$1,786.46	CF	CF	CF
12	92012	\$2,857.42	\$1,904.94	\$1,857.32	\$1,809.69	CF	CF	CF
14x4	920144	\$4,385.53	\$2,923.68	\$2,850.60	\$2,777.50	\$2,638.64	\$2,506.71	\$2,381.39
14x6	920146	\$4,567.71	\$3,045.13	\$2,968.83	\$2,892.88	\$2,748.25	\$2,610.85	\$2,480.31
14x8	920148	\$2,420.45	\$3,227.26	\$3,139.13	\$3,050.98	\$2,898.44	\$2,753.53	\$2,615.86
14x10	9201410	\$5,052.38	\$3,368.25	\$3,292.46	\$3,216.67	\$3,055.84	\$2,903.05	\$2,757.91
14x12	9201412	\$5,335.86	\$3,557.24	\$3,477.21	\$3,397.16	\$3,227.30	\$3,065.95	\$2,912.65
14	92014	\$5,685.92	\$3,790.61	\$3,705.32	\$3,620.03	\$3,439.03	\$3,267.08	\$3,103.74
16x4	920164	\$5,478.65	\$3,652.42	\$3,561.11	\$3,469.79	\$3,296.29	\$3,131.48	\$2,974.91
16x6	920166	\$5,660.77	\$3,773.84	\$3,679.51	\$3,585.15	\$3,405.90	\$3,235.61	\$3,073.84
16x8	920168	\$5,842.98	\$3,895.31	\$3,797.94	\$3,700.55	\$3,515.53	\$3,339.76	\$3,172.78
16x10	9201610	\$6,025.20	\$4,016.79	\$3,916.38	\$3,815.95	\$3,625.16	\$3,443.91	\$3,271.72
16x12	9201612	\$6,207.33	\$4,138.22	\$4,034.76	\$3,931.30	\$3,734.74	\$3,548.01	\$3,370.62
16x14	9201614	\$6,389.52	\$4,259.67	\$4,153.19	\$4,046.69	\$3,844.36	\$3,652.15	\$3,469.55
16	92016	\$6,571.72	\$4,381.14	\$4,271.63	\$4,162.09	\$3,953.99	\$3,756.29	\$3,568.48
18x4	920184	\$8,685.81	\$5,790.54	\$5,660.25	\$5,529.96	\$5,253.46	\$4,990.79	\$4,741.25
18x6	920186	\$8,951.43	\$5,967.61	\$5,833.35	\$5,699.07	\$5,414.12	\$5,143.42	\$4,886.26
18x8	920188	\$9,096.28	\$6,064.18	\$5,928.32	\$5,792.44	\$5,502.82	\$5,227.68	\$4,966.30
18x10	9201810	\$9,645.57	\$6,430.37	\$6,285.69	\$6,141.00	\$5,833.95	\$5,542.26	\$5,265.16
18x12	9201812	\$10,188.83	\$6,792.54	\$6,639.72	\$6,486.87	\$6,162.54	\$5,854.42	\$5,561.71
18x14	9201814	\$11,522.78	\$7,681.85	\$7,509.02	\$7,336.16	\$6,969.36	\$6,620.90	\$6,289.86
18x16	9201816	\$12,289.41	\$8,192.93	\$8,008.60	\$7,824.24	\$7,433.04	\$7,061.39	\$6,708.33
18	92018	\$12,907.40	\$8,604.93	\$8,411.33	\$8,217.70	\$7,806.82	\$7,416.49	\$7,045.67
20x4	920204	CF	\$6,659.77	\$6,509.93	\$6,360.09	\$6,042.09	\$5,740.00	\$5,453.00
20x6	920206	CF	\$6,862.00	\$6,707.62	\$6,553.22	\$6,225.56	\$5,914.29	\$5,618.58
20x8	920208	CF	\$7,033.99	\$6,863.58	\$6,709.15	\$6,377.20	\$6,045.31	\$5,749.81
20x10	9202010	CF	\$7,255.35	\$7,092.12	\$6,928.87	\$6,582.43	\$6,253.31	\$5,940.65
20x12	9202012	CF	\$7,661.68	\$7,489.31	\$7,316.91	\$6,951.07	\$6,603.52	\$6,273.35
20x14	9202014	CF	\$11,522.78	\$9,667.76	\$7,812.72	\$7,422.09	\$7,051.00	\$6,698.45
20x16	9202016	CF	\$12,289.41	\$10,241.28	\$8,193.14	\$7,783.49	\$7,394.32	\$7,024.60
20x18	9202018	CF	\$9,701.94	\$9,483.66	\$9,265.37	\$8,802.10	\$8,362.01	\$7,943.91
20	92020	CF	\$9,987.60	\$9,762.89	\$9,538.16	\$9,061.25	\$8,608.20	\$8,177.80
24x4	920244	CF	\$9,557.06	\$9,342.04	\$9,127.00	\$8,670.66	\$8,237.13	\$7,825.28
24x6	920246	CF	\$9,850.84	\$9,629.20	\$9,407.55	\$8,937.18	\$8,490.32	\$8,065.81
24x8	920248	CF	\$9,971.55	\$9,747.18	\$9,522.82	\$9,046.68	\$8,594.35	\$8,164.64
24x10	9202410	CF	\$10,104.31	\$9,876.98	\$9,649.63	\$9,167.16	\$8,708.80	\$8,273.36
24x12	9202412	CF	\$10,176.73	\$9,947.76	\$9,718.78	\$9,232.84	\$8,771.21	\$8,332.66
24x14	9202414	CF	\$10,567.96	\$10,330.19	\$10,092.40	\$9,587.79	\$9,108.40	\$8,652.99
24x16	9202416	CF	\$10,772.29	\$10,529.92	\$10,287.53	\$9,773.16	\$9,284.51	\$8,820.29
24x18	9202418	CF	\$13,424.17	\$13,122.13	\$12,820.07	\$12,179.08	\$11,570.13	\$10,991.63
24x20	9202420	CF	\$13,597.16	\$13,291.24	\$12,985.29	\$12,336.04	\$11,719.24	\$11,133.28
24	92024	CF	\$13,952.89	\$13,638.97	\$13,325.02	\$12,658.77	\$12,025.84	\$11,424.55

C-900 GASKETED PRESSURE

WYE

GASKET X GASKET X GASKET

Size	PartNumber	DR 14 (49)	DR 18 (48)	DR21 (39PG)	DR 25 (47)	DR 41 (46)	DR 51 (45)	DR81 (12PC)
30x4	920304	CF	\$12,710.89	\$12,424.91	\$12,138.92	\$11,531.98	\$10,955.38	\$10,407.62
30x6	920306	CF	\$14,776.27	\$13,644.18	\$12,512.06	\$11,886.46	\$11,292.14	\$10,727.53
30x8	920308	CF	\$13,262.16	\$12,963.77	\$12,665.35	\$12,032.09	\$11,430.49	\$10,858.98
30x10	9203010	CF	\$13,438.74	\$13,136.38	\$12,834.00	\$12,192.30	\$11,582.70	\$11,003.57
30x12	9203012	CF	\$13,535.06	\$13,230.53	\$12,925.99	\$12,279.70	\$11,665.73	\$11,082.45
30x14	9203014	CF	\$14,055.39	\$13,739.15	\$13,422.89	\$12,751.75	\$12,114.17	\$11,508.46
30x16	9203016	CF	\$14,327.15	\$14,004.79	\$13,682.41	\$12,998.30	\$12,348.39	\$11,730.98
30x18	9203018	CF	\$17,854.14	\$17,452.43	\$17,050.71	\$16,198.18	\$15,388.28	\$14,618.87
30x20	9203020	CF	\$18,084.23	\$17,677.35	\$17,270.45	\$16,406.94	\$15,586.59	\$14,807.27
30x24	9203024	CF	\$18,320.80	\$17,363.87	\$16,406.94	\$15,586.59	\$14,807.27	\$14,066.92
30	92030	CF	\$18,557.35	\$18,139.82	\$17,722.28	\$16,836.17	\$15,994.37	\$15,194.66
36x4	920364	CF	\$16,905.49	\$16,525.14	\$16,144.77	\$15,337.54	\$14,570.67	\$13,842.15
36x6	920366	CF	\$17,425.17	\$17,033.11	\$16,641.03	\$15,808.98	\$15,018.54	\$14,267.62
36x8	920368	CF	\$17,638.67	\$17,241.80	\$16,844.92	\$16,002.69	\$15,202.56	\$14,442.44
36x10	9203610	CF	\$17,873.53	\$17,471.40	\$17,069.24	\$16,215.78	\$15,405.00	\$14,634.75
36x12	9203612	CF	\$18,001.64	\$17,596.61	\$17,191.57	\$16,332.00	\$15,515.41	\$14,739.64
36x14	9203614	CF	\$18,693.68	\$18,273.07	\$17,852.45	\$16,959.83	\$16,111.85	\$15,306.26
36x16	9203616	CF	\$19,055.12	\$18,626.38	\$18,197.62	\$17,287.74	\$16,423.36	\$15,602.20
36x18	9203618	CF	\$23,746.02	\$23,211.74	\$22,677.45	\$21,543.58	\$20,466.41	\$19,443.10
36x20	9203620	CF	\$24,052.04	\$23,510.89	\$22,969.71	\$21,821.23	\$20,730.18	\$19,693.67
36x24	9203624	CF	\$24,366.67	\$23,093.96	\$21,821.23	\$20,730.18	\$19,693.67	\$18,708.99
36x30	9203630	CF	\$24,523.99	\$23,609.97	\$22,695.94	\$21,561.15	\$20,483.10	\$19,458.95
36	92036	CF	\$24,681.29	\$24,125.97	\$23,570.63	\$22,392.11	\$21,272.52	\$20,208.89
42x4	920424	CF	\$22,484.32	\$21,978.44	\$21,472.55	\$20,398.93	\$19,379.00	\$18,410.05
42x6	920426	CF	\$23,175.47	\$22,619.53	\$22,132.59	\$21,025.97	\$19,974.67	\$18,975.94
42x8	920428	CF	\$23,459.44	\$22,931.61	\$22,403.76	\$21,283.58	\$20,219.40	\$19,208.44
42x10	9204210	CF	\$23,771.80	\$23,236.96	\$22,702.09	\$21,567.00	\$20,488.65	\$19,464.22
42x12	9204212	CF	\$23,942.20	\$23,403.50	\$22,864.78	\$21,721.55	\$20,635.47	\$19,603.71
42x14	9204214	CF	\$24,862.61	\$24,303.19	\$23,743.75	\$22,556.57	\$21,428.74	\$20,357.31
42x16	9204216	CF	\$25,343.31	\$24,773.08	\$24,202.84	\$22,992.71	\$21,843.08	\$20,750.93
42x18	9204218	CF	\$31,582.21	\$30,871.62	\$30,161.02	\$28,652.97	\$27,220.33	\$25,859.31
42x20	9204220	CF	\$31,989.22	\$31,269.48	\$30,549.73	\$29,022.25	\$27,571.15	\$26,192.60
42x24	9204224	CF	\$32,407.67	\$30,714.96	\$29,022.24	\$27,571.14	\$26,192.58	\$24,882.96
42x30	9204230	CF	\$32,616.91	\$31,401.26	\$30,185.59	\$28,676.32	\$27,242.51	\$25,880.39
42x36	9204236	CF	\$32,721.54	\$31,744.42	\$30,767.28	\$29,228.93	\$27,767.49	\$26,379.11
42	92042	CF	\$32,826.12	\$32,087.54	\$31,348.95	\$29,781.52	\$28,292.45	\$26,877.83
48x4	920484	CF	\$29,904.14	\$29,231.33	\$28,558.50	\$27,130.58	\$25,774.05	\$24,485.35
48x6	920486	CF	\$30,823.38	\$30,129.87	\$29,436.34	\$27,964.53	\$26,566.31	\$25,238.00
48x8	920488	CF	\$31,201.06	\$30,499.05	\$29,797.01	\$28,307.16	\$26,891.81	\$25,547.23
48x10	9204810	CF	\$31,616.50	\$30,905.16	\$30,193.79	\$28,684.11	\$27,249.91	\$25,887.42
48x12	9204812	CF	\$31,843.13	\$31,126.66	\$30,410.17	\$28,889.67	\$27,445.19	\$26,072.94
48x14	9204814	CF	\$33,067.27	\$32,323.25	\$31,579.21	\$30,000.26	\$28,500.25	\$27,075.24
48x16	9204816	CF	\$33,706.62	\$32,948.21	\$32,189.79	\$30,580.31	\$29,051.30	\$27,598.75
48x18	9204818	CF	\$42,004.35	\$41,059.27	\$40,114.16	\$38,108.46	\$36,203.05	\$34,392.90
48x20	9204920	CF	\$42,545.66	\$41,588.42	\$40,631.14	\$38,599.59	\$36,669.61	\$34,836.13
48x24	9204824	CF	\$43,102.21	\$40,850.90	\$38,599.58	\$36,669.60	\$34,836.12	\$33,094.32
48x30	9204830	CF	\$43,380.50	\$41,763.68	\$40,146.85	\$38,139.51	\$36,232.54	\$34,420.93
48x36	9204836	CF	\$32,353.43	\$36,636.98	\$40,920.50	\$38,874.47	\$36,930.76	\$35,084.22
48x42	9204842	CF	\$38,006.11	\$39,656.72	\$41,307.31	\$39,241.96	\$37,279.86	\$35,415.87
48	92048	CF	\$43,658.74	\$42,676.43	\$41,694.10	\$39,609.40	\$37,628.94	\$35,747.50

C-900 GASKETED PRESSURE

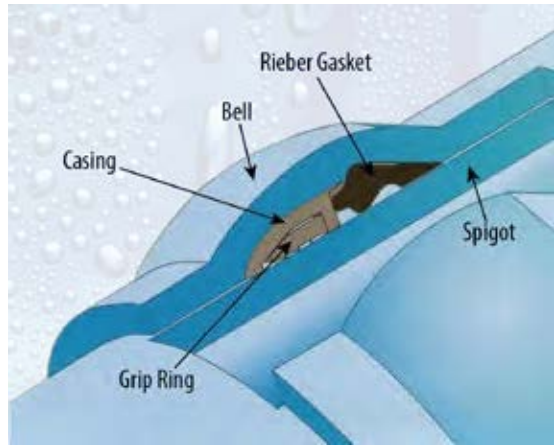

Spec-Loc Products

Our Spec-Loc line, featuring the Bulldog Restraint System, is available in both C-900 (4", 6", 8", 10", 12", 14", 16", & 24") and IPS (3"-8"). Although applications vary, they work well in the rural water industry due to no external restraints to corrode, ease of installation, longevity of product, and overall savings to the installer.

We Hydro-Test!

Have a job where the fittings are required to be hydro-tested? Look no further than Specified Fittings. This service is available in both Bellingham and Stevensville. Contact hdpesales@specfit.com for HDPE testing and pvcsales@specfit.com for PVC testing today!

PVC IPS FITTINGS

SPEC-LOC: C900 - IPS



SPEC-LOC



Specified Fittings

Specified Fittings, LLC
11000
14000
15000
16000
17000
18000
19000
20000
21000
22000
23000
24000
25000
26000
27000
28000
29000
30000
31000
32000
33000
34000
35000
36000
37000
38000
39000
40000
41000
42000
43000
44000
45000
46000
47000
48000
49000
50000
51000
52000
53000
54000
55000
56000
57000
58000
59000
60000
61000
62000
63000
64000
65000
66000
67000
68000
69000
70000
71000
72000
73000
74000
75000
76000
77000
78000
79000
80000
81000
82000
83000
84000
85000
86000
87000
88000
89000
90000
91000
92000
93000
94000
95000
96000
97000
98000
99000
100000

HYDRO-TESTED



ADAPTER

COUPLING

IPS GASKET X C900 GASKET

Size	PartNumber	DR25	DR18	DR14
		(47)	(48)	(49)
4	_1054-IPS	\$283.43	\$294.77	\$324.24
6	_8206	\$431.35	\$448.60	\$493.47
8	_82084	\$793.39	\$825.13	\$907.64
10	_82086	CF	CF	CF
12	_8208	CF	CF	CF
14	_820104	CF	CF	CF
16	_820106	CF	CF	CF
18	_820108	CF	CF	CF
20	_82010	CF	CF	CF
24	_820124	CF	CF	CF

CAP

GASKET X CAP

Size	PartNumber	DR25	DR18	DR14
		(47)	(48)	(49)
4	_1904	\$360.67	\$368.01	\$417.45
6	_1906	\$541.00	\$552.01	\$626.16
8	_1908	\$811.50	\$828.01	\$939.25
10	_19010	\$1,220.41	\$1,220.41	\$1,374.32
12	_19012	\$1,429.77	\$1,429.77	\$1,613.93
14	_19014	\$1,974.27	\$1,974.27	\$2,173.19
16	_19016	\$2,183.14	\$2,183.14	\$2,399.72
18	_19018	CF	CF	CF
20	_19020	CF	CF	CF
24	_19024	CF	CF	CF

COUPLING

STOP

GASKET X GASKET

Size	PartNumber	DR25	DR18	DR14
		(47)	(48)	(49)
4	_2404	\$284.77	\$292.78	\$321.87
6	_2406	\$395.47	\$424.68	\$470.60
8	_2408	\$725.08	\$725.08	\$773.46
10	_24010	\$1,189.50	\$1,189.50	\$1,263.33
12	_24012	\$1,434.00	\$1,434.00	\$1,535.78
14	_24014	\$2,927.10	\$2,927.10	\$3,133.87
16	_24016	\$3,380.67	\$3,380.67	\$3,629.52
18	_24018	CF	CF	CF
20	_24020	CF	CF	CF
24	_24024	CF	CF	CF

Larger and smaller sizes are available upon request. Please contact our factory at pvcsales@specfit.com or call (360)398-7700 for more information!

ELBOW

11-1/4 DEGREE

GASKET X GASKET

Size	PartNumber	DR25	DR18	DR14
		(47)	(48)	(49)
4	_3104	\$334.50	\$364.45	\$417.19
6	_3106	\$465.92	\$483.07	\$548.26
8	_3108	\$837.03	\$856.70	\$929.69
10	_31010	\$1,360.38	\$1,390.34	\$1,501.73
12	_31012	\$1,627.00	\$1,666.12	\$1,811.28
14	_31014	\$3,373.95	\$3,456.26	\$3,761.98
16	_31016	\$3,936.58	\$4,036.53	\$4,408.03
18	_31018	CF	CF	CF
20	_31020	CF	CF	CF
24	_31024	CF	CF	CF

GASKET X SPIGOT

Size	PartNumber	DR25	DR18	DR14
		(47)	(48)	(49)
4	_4004	\$231.79	\$261.74	\$314.48
6	_4006	\$323.16	\$340.31	\$405.50
8	_4008	\$595.96	\$615.20	\$686.65
10	_40010	\$950.99	\$980.34	\$1,089.37
12	_40012	\$1,146.02	\$1,183.17	\$1,321.20
14	_40014	\$2,406.06	\$2,480.83	\$2,774.46
16	_40016	\$2,899.54	\$2,993.28	\$3,361.35
18	_40018	CF	CF	CF
20	_40020	CF	CF	CF
24	_40024	CF	CF	CF

22-1/2 DEGREE

GASKET X GASKET

Size	PartNumber	DR25	DR18	DR14
		(47)	(48)	(49)
4	_3304	\$334.50	\$364.45	\$417.19
6	_3306	\$465.92	\$483.07	\$548.26
8	_3308	\$837.03	\$856.70	\$929.69
10	_33010	\$1,360.38	\$1,390.34	\$1,501.73
12	_33012	\$1,627.00	\$1,666.12	\$1,811.28
14	_33014	\$3,373.95	\$3,456.26	\$3,761.98
16	_33016	\$3,936.58	\$4,036.53	\$4,408.03
18	_33018	CF	CF	CF
20	_33020	CF	CF	CF
24	_33024	CF	CF	CF

GASKET X SPIGOT

Size	PartNumber	DR25	DR18	DR14
		(47)	(48)	(49)
4	_4204	\$231.79	\$261.74	\$314.48
6	_4206	\$323.16	\$340.31	\$405.50
8	_4208	\$595.96	\$615.20	\$686.65
10	_42010	\$950.99	\$980.34	\$1,089.37
12	_42012	\$1,146.02	\$1,183.17	\$1,321.20
14	_42014	\$2,406.06	\$2,485.33	\$2,779.80
16	_42016	\$2,899.54	\$2,998.88	\$3,367.99
18	_42018	CF	CF	CF
20	_42020	CF	CF	CF
24	_42024	CF	CF	CF

C-900 Spec-Loc Fittings

SPEC-LOC FITTINGS

ELBOW

45 DEGREE

GASKET X GASKET

Size	PartNumber	DR25	DR18	DR14
		(47)	(48)	(49)
4	3504	\$366.24	\$374.08	\$430.01
6	3506	\$525.72	\$525.72	\$676.60
8	3508	\$837.03	\$856.70	\$929.69
10	35010	\$1,360.38	\$1,390.34	\$1,501.73
12	35012	\$1,627.00	\$1,666.12	\$1,811.28
14	35014	\$3,335.20	\$3,456.26	\$3,761.98
16	35016	\$3,889.40	\$4,036.53	\$4,408.03
18	35018	CF	CF	CF
20	35020	CF	CF	CF
24	35024	CF	CF	CF

GASKET X SPIGOT

Size	PartNumber	DR25	DR18	DR14
		(47)	(48)	(49)
4	4404	\$263.53	\$271.38	\$327.30
6	4406	\$382.96	\$436.80	\$533.84
8	4408	\$595.96	\$615.20	\$686.65
10	44010	\$950.99	\$980.34	\$1,089.37
12	44012	\$1,146.02	\$1,183.17	\$1,321.20
14	44014	\$2,368.78	\$2,485.33	\$2,779.80
16	44016	\$2,852.66	\$2,998.88	\$3,367.99
18	44018	CF	CF	CF
20	44020	CF	CF	CF
24	44024	CF	CF	CF

90 DEGREE

GASKET X GASKET

Size	PartNumber	DR25	DR18	DR14
		(47)	(48)	(49)
4	3704	\$477.88	\$496.98	\$627.36
6	3706	\$679.24	\$718.52	\$908.57
8	3708	\$1,127.86	\$1,162.68	\$1,292.90
10	37010	\$1,804.20	\$1,857.32	\$2,056.03
12	37012	\$2,221.28	\$2,291.36	\$2,553.45
14	37014	\$3,786.87	\$3,890.34	\$4,277.23
16	37016	\$4,394.69	\$4,518.11	\$4,979.66
18	37018	CF	CF	CF
20	37020	CF	CF	CF
24	37024	CF	CF	CF

GASKET X SPIGOT

Size	PartNumber	DR25	DR18	DR14
		(47)	(48)	(49)
4	4604	\$459.39	\$487.50	\$580.84
6	4606	\$661.49	\$680.59	\$810.97
8	4608	\$800.04	\$710.73	\$1,059.73
10	46010	\$1,262.33	\$1,126.06	\$1,658.69
12	46012	\$1,505.52	\$1,338.43	\$2,108.56
14	46014	\$3,351.43	\$2,966.91	\$3,366.52
16	46016	\$3,845.66	\$3,401.27	\$3,954.69
18	46018	CF	CF	CF
20	46020	CF	CF	CF
24	46024	CF	CF	CF

FLANGE

VAN STONE STYLE

FLANGE X GASKET

Size	PartNumber	DR25	DR18	DR14
		(47)	(48)	(49)
4	5304	\$263.34	\$273.87	\$301.27
6	5306	\$395.01	\$410.81	\$451.89
8	5308	\$592.52	\$616.22	\$677.83
10	53010	\$1,118.68	\$1,163.43	\$1,279.78
12	53012	\$1,267.82	\$1,318.53	\$1,335.39
14	53014	\$2,479.85	\$2,579.05	\$2,836.96
16	53016	\$3,163.85	\$3,290.40	\$3,619.44
18	53018	CF	CF	CF
20	53020	CF	CF	CF
24	53024	CF	CF	CF

INCREASER COUPLING

GASKET X GASKET

Size	PartNumber	DR25	DR18	DR14
		(47)	(48)	(49)
6x4	60064	\$396.21	\$410.77	\$465.58
6x8	60068	\$712.98	\$730.83	\$797.19
6x10	600610	\$937.26	\$958.33	\$1,036.53
6x12	600612	\$1,087.18	\$1,087.18	\$1,212.02
6x14	600614	\$2,076.46	\$2,076.46	\$2,332.12
6x16	600616	\$2,416.44	\$2,416.44	\$2,728.50
8x4	60084	\$630.00	\$630.00	\$703.65
8x10	600810	\$1,069.83	\$1,069.83	\$1,179.60
8x12	600812	\$1,213.72	\$1,213.72	\$1,347.57
8x14	600814	\$2,196.96	\$2,196.96	\$2,460.16
8x16	600816	\$2,536.93	\$2,604.70	\$2,856.52
10x4	600104	\$863.36	\$882.61	\$954.29
10x12	6001012	\$1,432.04	\$1,463.32	\$1,579.46
10x14	6001014	\$2,403.25	\$2,461.26	\$2,676.92
10x16	6001016	\$2,803.46	\$2,876.61	\$3,148.57
12x4	600124	\$1,025.31	\$1,050.61	\$1,144.81
12x14	6001214	\$2,474.89	\$2,534.23	\$2,754.63
12x16	6001216	\$2,878.12	\$2,952.73	\$3,230.01
14x4	600144	\$2,005.53	\$2,058.12	\$2,253.64
14x16	6001416	\$3,563.42	\$3,615.23	\$3,970.28
16x4	600164	\$2,339.64	\$2,339.64	\$2,642.70
4x24	600424	CF	CF	CF
6x24	600624	CF	CF	CF
8x24	600824	CF	CF	CF
10x24	6001024	CF	CF	CF
12x24	6001224	CF	CF	CF
14x24	6001424	CF	CF	CF
16x24	6001624	CF	CF	CF
18x24	6001824	CF	CF	CF
20x24	6002024	CF	CF	CF

SPEC-LOC FITTINGS
C-900 Spec-Loc Fittings

REDUCER BUSHING

SPIGOT X GASKET

Size	PartNumber	DR25 (47)	DR18 (48)	DR14 (49)
6x4	62064	\$235.32	\$244.73	\$269.20
8x4	62084	\$353.72	\$367.09	\$41,669.10
8x6	62086	\$430.57	\$445.82	\$502.50
10x4	620104	\$381.75	\$396.59	\$451.70
10x6	620106	\$461.70	\$478.62	\$541.43
10x8	620108	\$588.24	\$607.06	\$676.97
12x4	620124	\$475.03	\$494.76	\$568.23
12x6	620126	\$551.97	\$573.70	\$654.29
12x8	620128	\$681.54	\$705.24	\$793.51
12x10	6201210	\$884.79	\$910.62	\$1,006.60
14x4	620144	\$1,840.03	\$1,883.86	\$2,046.79
14x6	620146	\$1,907.97	\$1,953.19	\$2,121.46
14x8	620148	\$2,025.47	\$2,072.17	\$2,245.79
14x10	6201410	\$2,231.71	\$2,280.68	\$2,462.59
14x12	6201412	\$2,312.42	\$2,363.15	\$2,551.56
16x4	620164	\$2,120.43	\$2,173.05	\$2,368.68
16x6	620166	\$2,190.80	\$2,499.55	\$2,446.45
16x8	620168	\$2,305.29	\$2,360.74	\$2,566.93
16x10	6201610	\$2,604.87	\$2,667.48	\$2,900.33
16x12	6201612	\$2,694.53	\$2,759.44	\$3,000.57
16x14	6201614	\$3,349.80	\$3,424.76	\$3,703.23
18x4	620184	\$1,956.41	\$2,054.68	\$2,260.15
18x6	620186	\$2,051.44	\$2,152.52	\$2,367.78
18x8	620188	\$2,201.04	\$2,305.29	\$2,535.82
18x10	6201810	\$2,599.87	\$2,716.60	\$2,988.26
18x12	6201812	\$2,755.83	\$2,878.27	\$3,166.09
18x14	6201814	\$3,338.89	\$3,467.54	\$3,814.30
18x16	6201816	\$3,555.47	\$3,689.59	\$4,058.55
20x4	620204	\$2,384.24	\$2,505.13	\$2,755.64
20x6	620206	\$2,496.56	\$2,621.26	\$2,883.40
20x8	620208	\$2,658.39	\$2,786.90	\$3,065.59
20x10	6202010	\$2,897.79	\$3,030.27	\$3,333.30
20x12	6202012	\$2,963.46	\$3,097.90	\$3,407.69
20x14	6202014	\$3,600.65	\$4,963.00	\$5,459.30
20x16	6202016	\$3,871.44	\$4,022.30	\$4,424.53
24x4	620244	CF	CF	CF
24x6	620246	CF	CF	CF
24x8	620248	CF	CF	CF
24x10	6202410	CF	CF	CF
24x12	6202412	CF	CF	CF
24x14	6202414	CF	CF	CF
24x16	6202416	CF	CF	CF

TEE

FULL OR REDUCING

GASKET X GASKET X GASKET

Size	PartNumber	DR25 (47)	DR18 (48)	DR14 (49)
4	8204	\$519.08	\$569.57	\$656.25
6x4	82064	\$692.71	\$715.16	\$823.31
6	8206	\$781.82	\$812.11	\$938.77
8x4	82084	\$2,404.44	\$2,588.28	\$2,966.02
8x6	82086	\$2,472.74	\$2,659.34	\$3,042.73
8	8208	\$2,590.59	\$3,013.08	\$3,168.93
10x4	820104	\$2,815.10	\$3,007.12	\$3,401.79
10x6	820106	\$2,883.36	\$3,078.14	\$3,478.45
10x8	820108	\$3,001.20	\$3,198.75	\$3,604.70
10	82010	\$3,192.73	\$3,393.05	\$3,804.64
12x4	820124	\$3,019.84	\$3,222.90	\$3,640.14
12x6	820126	\$3,088.08	\$3,293.85	\$3,716.71
12x8	820128	\$3,205.91	\$3,413.99	\$3,842.40
12x10	8201210	\$3,397.46	\$3,444.56	\$4,042.88
12	82012	\$3,472.52	\$3,686.56	\$4,126.34
14x4	820144	\$5,204.26	\$5,532.72	\$6,207.68
14x6	820146	\$5,381.40	\$5,723.52	\$6,426.52
14x8	820148	\$5,608.12	\$5,963.84	\$6,694.87
14x10	8201410	\$5,908.57	\$6,278.01	\$7,037.10
14x12	8201412	\$6,092.46	\$6,475.51	\$7,262.64
14	82014	\$6,694.43	\$7,179.16	\$7,906.24
16x4	820164	\$6,250.66	\$6,661.00	\$7,503.75
16x6	820166	\$6,427.79	\$6,851.76	\$46.00
16x8	820168	\$6,654.51	\$7,092.13	\$7,723.01
16x10	8201610	\$6,955.00	\$7,406.28	\$7,991.41
16x12	8201612	\$7,138.84	\$7,603.78	\$8,333.61
16x14	8201614	\$7,740.87	\$8,219.42	\$8,559.15
16	82016	\$7,991.51	\$8,483.72	\$9,202.82
18x4	820184	CF	CF	\$9,495.16
18x6	820186	CF	CF	CF
18x8	820188	CF	CF	CF
18x10	8201810	CF	CF	CF
18x12	8201812	CF	CF	CF
18x14	8201814	CF	CF	CF
18x16	8201816	CF	CF	CF
18	82018	CF	CF	CF
20x4	820204	CF	CF	CF
20x6	820206	CF	CF	CF
20x8	820208	CF	CF	CF
20x10	8202010	CF	CF	CF
20x12	8202012	CF	CF	CF
20x14	8202014	CF	CF	CF
20x16	8202016	CF	CF	\$324.24
20x18	8202018	CF	CF	\$493.47
20	82020	CF	CF	\$907.64
24x4	820244	CF	CF	CF
24x6	820246	CF	CF	CF
24x8	47820248	CF	CF	CF
24x10	478202410	CF	CF	CF
24x12	478202412	CF	CF	CF
24x14	478202414	CF	CF	CF
24x16	478202416	CF	CF	CF
24x18	478202418	CF	CF	\$417.45
24x20	478202420	CF	CF	\$626.16
24	4782024	CF	CF	\$939.25

C-900 Spec-Loc Fittings
SPEC-LOC FITTINGS

ADAPTER

COUPLING

IPS GASKET X C900 GASKET

Size	Part Number	SDR26 (29)	SDR21 (34)	SDR17 (31)
3	1053-CID	\$212.58	\$254.24	\$243.18
4	1054-CID	\$283.43	\$338.98	\$324.24
6	1056-CID	\$431.35	\$515.89	\$493.47
8	1058-CID	\$793.39	\$948.89	\$907.64

COUPLING

STOP

GASKET X GASKET

Size	Part Number	SDR26 (29)	SDR21 (34)	SDR17 (31)
3	2403	\$213.58	\$252.52	\$241.41
4	2404	\$284.77	\$336.70	\$321.87
6	2406	\$395.47	\$488.39	\$467.15
8	2408	\$725.08	\$833.84	\$773.46

CAP

GASKET X CAP

Size	Part Number	SDR26 (29)	SDR21 (34)	SDR17 (31)
3	1903	\$197.50	\$317.40	\$313.09
4	1904	\$263.34	\$423.20	\$417.45
6	1906	\$395.01	\$634.81	\$626.16
8	1908	\$592.51	\$952.21	\$939.25

ELBOW

11-1/4 DEGREE

GASKET X GASKET

Size	Part Number	SDR26 (29)	SDR21 (34)	SDR17 (31)
3	3103	\$250.87	\$314.33	\$312.89
4	3104	\$334.50	\$419.11	\$417.19
6	3106	\$465.92	\$555.53	\$548.26
8	3108	\$837.03	\$985.21	\$929.69

11-1/4 DEGREE

GASKET X SPIGOT

Size	Part Number	SDR26 (29)	SDR21 (34)	SDR17 (31)
3	4003	\$173.85	\$225.75	\$235.87
4	4004	\$231.79	\$301.00	\$314.48
6	4006	\$323.16	\$391.35	\$405.50
8	4008	\$595.96	\$707.48	\$686.65

ELBOW

22-1/2 DEGREE

GASKET X GASKET

Size	Part Number	SDR26 (29)	SDR21 (34)	SDR17 (31)
3	3303	\$250.87	\$314.35	\$312.89
4	3304	\$334.50	\$419.11	\$417.19
6	3306	\$465.92	\$555.53	\$548.26
8	3308	\$837.03	\$985.21	\$929.69

22-1/2 DEGREE

GASKET X SPIGOT

Size	Part Number	SDR26 (29)	SDR21 (34)	SDR17 (31)
3	4203	\$173.85	\$225.75	\$235.87
4	4204	\$231.79	\$301.00	\$314.48
6	4206	\$323.16	\$391.35	\$405.50
8	4208	\$595.96	\$707.48	\$686.65

45 DEGREE

GASKET X GASKET

Size	Part Number	SDR26 (29)	SDR21 (34)	SDR17 (31)
3	3503	\$274.68	\$322.65	\$322.51
4	3504	\$366.24	\$430.20	\$430.01
6	3506	\$525.72	\$604.58	\$676.60
8	3508	\$837.03	\$985.21	\$929.69

45 DEGREE

GASKET X SPIGOT

Size	Part Number	SDR26 (29)	SDR21 (34)	SDR17 (31)
3	4403	\$197.65	\$234.07	\$245.48
4	4404	\$263.53	\$312.08	\$327.30
6	4406	\$382.96	\$502.33	\$533.84
8	4408	\$595.96	\$707.48	\$686.65

90 DEGREE

GASKET X GASKET

Size	Part Number	SDR26 (29)	SDR21 (34)	SDR17 (31)
3	3703	\$344.54	\$420.46	\$435.63
4	3704	\$459.39	\$560.62	\$580.84
6	3706	\$661.49	\$782.68	\$810.97
8	3708	\$1,127.86	\$1,337.09	\$1,292.90

90 DEGREE

GASKET X SPIGOT

Size	Part Number	SDR26 (29)	SDR21 (34)	SDR17 (31)
3	4603	\$358.41	\$428.65	\$470.52
4	4604	\$477.88	\$571.53	\$627.36
6	4606	\$679.24	\$826.34	\$908.57
8	4608	\$800.04	\$817.34	\$1,059.73

FLANGE

VAN STONE STYLE

FLANGE X GASKET

Size	Part Number	SDR26 (29)	SDR21 (34)	SDR17 (31)
3	5303	\$197.50	CF	CF
4	5304	\$263.34	CF	CF
6	5306	\$395.01	CF	CF
8	5308	\$592.51	CF	CF

INCREASER COUPLING

GASKET X GASKET

Size	Part Number	SDR26 (29)	SDR21 (34)	SDR17 (31)
4x3	60043	\$335.35	\$399.83	\$394.07
6x3	60063	\$364.52	\$434.59	\$428.33
6x4	60064	\$396.21	\$472.38	\$465.58
8x3	60083	\$579.60	\$666.54	\$532.36
8x4	60084	\$630.00	\$724.51	\$703.65
8x6	60086	\$680.41	\$782.47	\$759.94

REDUCER BUSHING

SPIGOT X GASKET

Size	Part Number	SDR26 (29)	SDR21 (34)	SDR17 (31)
4x3	62043	\$199.17	\$238.21	\$227.85
6x3	62063	\$216.49	\$258.93	\$247.66
6x4	62064	\$235.31	\$281.44	\$269.20
8x3	62083	\$325.42	\$388.38	\$383.35
8x4	62084	\$353.72	\$422.16	\$416.69
8x6	62086	\$430.57	\$512.69	\$502.50

TEE

FULL OR REDUCING

GASKET X GASKET X GASKET

Size	Part Number	SDR26 (29)	SDR21 (34)	SDR17 (31)
3	8203	\$439.35	\$554.39	\$555.45
4x3	82043	\$477.55	\$602.61	\$603.75
4	8204	\$519.08	\$655.01	\$656.25
6x3	82063	\$637.30	\$756.64	\$7,542.45
6x4	82064	\$692.71	\$822.44	\$823.31
6	8206	\$781.82	\$933.92	\$938.77
8x3	82063	\$2,212.08	\$2,738.41	\$2,728.74
8x4	82084	\$2,404.44	\$2,976.52	\$2,966.02
8x6	82086	\$2,472.74	\$3,058.24	\$3,042.73
8	8208	\$2,590.59	\$3,465.04	\$3,168.93

PVC FITTINGS

SCH40/80 PRESSURE FITTINGS



Specified Fittings

ADAPTER

FEMALE X FIPT



Molded items offered in smaller sizes. Call us for a quote today!

Size	PartNumber	SCH 40 SW Bell (32)	SCH 80 SW Bell (33)
6	1306	CF	CF
8	1308	CF	CF
10	13010	CF	CF
12	13012	CF	CF
14	13014	CF	CF
16	13016	CF	CF
18	13018	CF	CF
20	13020	CF	CF
24	13024	CF	CF

FEMALE X MIPT



Molded items offered in smaller sizes. Call us for a quote today!

Size	PartNumber	SCH 40 SW Bell (32)	SCH 80 SW Bell (33)
6	1506	CF	CF
8	1508	CF	CF
10	15010	CF	CF
12	15012	CF	CF
14	15014	CF	CF
16	15016	CF	CF
18	15018	CF	CF
20	15020	CF	CF
24	15024	CF	CF

COUPLING

STOP

FEMALE X FEMALE



Can't find what you need? Don't worry! Also available in smaller, larger, reducing and molded sizes.

Size	PartNumber	SCH 40 SW Bell (32)	SCH 80 SW Bell (33)
10	24010	\$142.59	\$202.17
12	24012	\$151.79	\$233.04
14	24014	\$246.53	\$465.99
16	24016	\$274.91	\$554.01
18	24018	\$468.81	\$1,092.03
20	24020	\$817.85	\$1,346.45
24	24024	\$1,135.82	\$1,938.38

REDUCER

CONCENTRIC

FEMALE X FEMALE

STYLE A



Size	PartNumber	SCH 40 SW Bell (32)	SCH 80 SW Bell (33)
10x8	600108	\$158.90	\$303.85
12x10	6001210	\$231.30	\$292.66
14x12	6001412	\$387.42	\$427.31
16x14	6001614	\$464.97	\$631.68
18x16	6001816	\$687.55	\$1,124.56
20x18	6002018	\$1,166.99	\$1,356.48
24x20	6002420	\$1,781.83	\$2,899.07

REDUCER

CONCENTRIC

FEMALE X FEMALE

STYLE B



Size	PartNumber	SCH 40 SW Bell (32)	SCH 80 SW Bell (33)
10x2	600102	\$327.97	\$524.55
10x4	600104	\$243.60	\$463.48
10x6	600106	\$227.02	\$379.82
12x4	600124	\$433.42	\$646.81
12x6	600126	\$399.36	\$559.51
12x8	600128	\$387.24	\$433.22
14x4	600144	\$722.17	\$942.39
14x6	600146	\$655.98	\$796.01
14x8	600148	\$650.06	\$728.40
14x10	6001410	\$514.41	\$712.41
16x2	600162	\$910.96	CF
16x4	600164	\$845.24	\$1,399.19
16x6	600166	\$836.91	\$1,265.51
16x8	600168	\$642.84	\$1,111.42
16x10	6001610	\$596.13	\$987.22
16x12	6001612	\$487.62	\$832.13
18x4	600184	\$1,533.81	\$2,952.30
18x6	600186	\$1,227.49	\$2,759.71
18x8	600188	\$1,150.20	\$2,613.00
18x10	6001810	\$1,028.61	\$2,363.73
18x12	6001812	\$818.28	\$1,945.64
18x14	6001814	\$759.51	\$1,317.13
20x4	600204	\$1,976.34	CF
20x6	600206	\$1,644.90	\$2,691.07
20x8	600208	\$1,615.66	\$2,572.15
20x10	6002010	\$1,553.55	\$2,481.93
20x12	6002012	\$1,494.11	\$2,147.10
20x14	6002014	\$1,400.41	\$2,141.43
20x16	6002016	\$1,283.42	\$1,967.12
24x4	600244	\$3,660.92	\$4,675.27
24x6	600246	\$2,928.74	\$4,604.08
24x8	600248	\$2,694.66	\$4,504.31
24x10	6002410	\$2,457.91	\$4,395.67
24x12	6002412	\$2,419.17	\$3,998.73
24x14	6002414	\$2,326.00	\$3,688.30
24x16	6002416	\$2,236.97	\$3,361.37
24x18	6002418	\$1,980.84	\$3,070.37

REDUCER

ECCENTRIC

FEMALE X FEMALE

Size	PartNumber	SCH 40	SCH 80
		SW Bell (32)	SW Bell (33)
4x2	61042	\$52.52	\$117.31
4x3	61043	\$78.50	\$88.72
6x2	61062	\$170.81	\$208.01
6x3	61063	\$109.20	\$183.16
6x4	61064	\$54.60	\$132.61
8x2	61082	\$239.14	\$368.40
8x3	61083	\$225.24	\$280.77
8x4	61084	\$112.48	\$229.34
8x6	61086	\$90.92	\$176.36
10x2	610102	\$309.60	\$505.41
10x3	610103	\$305.72	\$476.82
10x4	610104	\$257.17	\$388.10
10x6	610106	\$236.46	\$329.39
10x8	610108	\$222.94	\$304.37
12x2	610122	\$532.35	\$710.80
12x3	610123	\$528.37	\$682.21
12x4	610124	\$479.83	\$593.49
12x6	610126	\$394.27	\$488.44
12x8	610128	\$261.45	\$421.98
12x10	6101210	\$226.69	\$269.73
14x2	610142	\$971.74	\$1,174.79
14x3	610143	\$910.13	\$1,149.94
14x4	610144	\$855.53	\$1,099.39
14x6	610146	\$800.93	\$966.78
14x8	610148	\$656.10	\$795.04
14x10	6101410	\$595.60	\$659.40
14x12	6101412	\$328.29	\$423.61
16x2	610162	\$952.13	\$2,002.28
16x3	610163	\$890.48	\$1,946.36
16x4	610164	\$835.88	\$1,895.81
16x6	610166	\$781.28	\$1,763.20
16x8	610168	\$652.00	\$1,635.63
16x10	6101610	\$586.64	\$1,189.87
16x12	6101612	\$550.18	\$1,056.41
16x14	6101614	\$515.92	\$818.26
18x2	610182	\$1,406.01	\$2,673.68
18x3	610183	\$1,344.41	\$2,648.83
18x4	610184	\$1,289.81	\$2,598.28
18x6	610186	\$1,235.20	\$2,465.67
18x8	610188	\$1,217.61	\$2,360.31
18x10	6101810	\$1,088.03	\$2,205.64
18x12	6101812	\$981.93	\$1,968.71
18x14	6101814	\$868.17	\$1,623.08
18x16	6101816	\$700.33	\$1,583.75

FLANGE

VAN STONE

FLANGE X MALE



Size	PartNumber	SCH 40	SCH 80
		SW Bell (32)	SW Bell (33)
14	52014	NA	\$1,032.91
16	52016	NA	\$1,381.62
18	52018	NA	\$2,081.37
20	52020	NA	\$2,522.17
24	52024	NA	\$3,394.44

FLANGE

VAN STONE

FLANGE X FEMALE



Size	PartNumber	SCH 40	SCH 80
		SW Bell (32)	SW Bell (33)
14	53014	NA	\$1,032.91
16	53016	NA	\$1,381.62
18	53018	NA	\$2,081.37
20	53020	NA	\$2,522.17
24	53024	NA	\$3,394.44

FLANGE

BLIND



Size	PartNumber	SCH 40	SCH 80
		SW Bell (32)	SW Bell (33)
10	49010	CF	\$542.54
12	49012	CF	\$844.96
14	49014	CF	\$1,077.00
16	49016	CF	\$1,277.11
18	49018	CF	\$1,436.28
20	49020	CF	\$2,321.53
24	49024	CF	\$3,095.08

CAP

FEMALE



Molded items offered in smaller sizes. Call us for a quote today!

Size	PartNumber	SCH 40	SCH 80
		SW Bell (32)	SW Bell (33)
10	19010	\$241.95	\$395.23
12	19012	\$351.51	\$593.16
14	19014	\$441.15	\$656.89
16	19016	\$526.54	\$851.63
18	19018	\$927.82	\$1,242.44
20	19020	\$1,408.88	\$1,665.53
24	19024	\$2,242.40	\$3,098.62

PLUG

MALE



Molded items offered in smaller sizes. Call us for a quote today!

Size	PartNumber	SCH 40	SCH 80
		SW Bell (32)	SW Bell (33)
6	5606	\$84.16	CF
8	5608	\$129.25	284.61
10	56010	\$296.71	462.79
12	56012	\$485.15	857.31
14	56014	\$531.86	952.02
16	56016	\$588.16	1057.14
18	56018	\$1,049.58	1440.51
20	56020	\$1,920.18	1931.05
24	56024	\$2,556.01	3592.66

CROSS

FEMALE X FEMALE X FEMALE X FEMALE



Can't find what you need? Don't worry! Also available in smaller, larger, reducing, adapting and molded sizes.

Size	PartNumber	SCH 40 SW Bell (32)	SCH 80 SW Bell (33)
4x2	26042	\$51.65	CF
6x2	26062	\$463.15	\$575.40
6x3	26063	\$481.71	\$604.92
6x4	26064	\$553.08	\$721.02
6	2606	CF	\$741.42
8x2	26082	\$606.76	\$742.50
8x3	26083	\$632.06	\$781.62
8x4	26084	\$664.21	\$807.24
8x6	26086	\$756.16	\$872.33
8	2608	\$902.89	\$1,084.09
10x2	260102	\$766.76	\$988.39
10x3	260103	\$826.49	\$1,071.71
10x4	260104	\$856.50	\$1,112.45
10x6	260106	\$918.06	\$1,164.18
10x8	260108	\$975.45	\$1,497.17
10	26010	\$1,092.78	\$1,748.55
12x2	260122	\$861.87	\$1,105.82
12x3	260123	\$924.89	\$1,191.39
12x4	260124	\$968.86	\$1,267.98
12x6	260126	\$1,018.95	\$1,472.45
12x8	260128	\$1,099.26	\$1,758.94
12x10	2601210	\$1,252.67	\$1,196.28
12	26012	\$1,540.00	\$2,462.38
14x2	260142	\$1,191.39	\$1,586.76
14x3	260143	\$1,277.24	\$1,707.68
14x4	260144	\$1,304.96	\$1,874.97
14x6	260146	\$1,531.52	\$2,070.93
14x8	260148	\$1,705.39	\$2,355.81
14x10	2601410	\$1,938.26	\$2,721.91
14x12	2601412	\$2,201.63	\$3,078.71
14	26014	\$2,738.38	\$3,957.46
16x2	260162	\$1,455.88	\$1,985.08
16x3	260163	CF	\$2,137.77
16x4	260164	\$1,618.31	\$2,371.50
16x6	260166	\$1,750.53	\$2,564.86
16x8	260168	\$2,050.47	\$2,868.77
16x10	2601610	\$2,209.78	\$3,126.08
16x12	2601612	\$2,493.64	\$3,511.12
16x14	2601614	\$2,759.15	\$4,397.16
16	26016	\$3,471.52	\$4,485.05
18x2	260182	\$1,636.90	\$2,861.26
18x3	260183	\$1,735.35	\$3,012.34
18x4	260184	\$1,753.08	\$3,347.59
18x6	260186	\$1,873.28	\$3,494.00
18x8	260188	\$2,173.95	\$3,749.71
18x10	2601810	\$2,764.53	\$4,005.23
18x12	2601812	\$2,968.82	\$4,194.08
18x14	2601814	\$3,434.73	\$4,443.80
18x16	2601816	\$3,538.24	\$4,630.42
18	26018	\$3,950.42	\$4,704.39

FEMALE X FEMALE X FEMALE X FEMALE

Size	PartNumber	SCH 40 SW Bell (32)	SCH 80 SW Bell (33)
20x2	260202	\$1,731.81	\$3,588.86
20x3	260203	\$1,848.58	CF
20x4	260204	\$1,957.27	\$4,197.60
20x6	260206	\$2,094.94	\$4,835.04
20x8	260208	\$2,293.76	\$4,889.34
20x10	2602010	\$3,907.63	\$5,227.08
20x12	2602012	\$4,137.67	\$5,604.82
20x14	2602014	\$4,387.09	\$6,258.31
20x16	2602016	\$5,118.60	\$6,380.34
20x18	2602018	\$5,708.62	\$6,724.99
20	26020	\$5,892.44	\$6,850.02
24x2	260242	\$2,885.36	\$4,283.69
24x3	260243	\$2,971.29	\$4,509.53
24x4	260244	\$3,072.16	\$5,011.33
24x6	260246	\$3,247.13	\$5,326.66
24x8	260248	\$3,495.68	\$5,534.66
24x10	2602410	\$5,018.61	\$5,613.74
24x12	2602412	\$5,117.17	\$5,870.16
24x14	2602414	\$5,295.39	\$6,984.70
24x16	2602416	\$6,561.89	\$7,458.92
24x18	2602418	\$7,215.51	\$8,558.40
24x20	2602420	\$8,388.73	\$10,233.37
24	26024	\$8,594.20	\$10,293.55

SCH40/SCH80 PRESSURE FITTINGS

TEE

STRAIGHT

FEMALE X FEMALE X FEMALE

Size	PartNumber	SCH 40 SW Bell (32)	SCH 80 SW Bell (33)
8x4	82084	\$351.97	CF
8x6	82086	\$351.97	CF
10x4	820104	\$724.11	\$804.46
10x6	820106	\$818.79	\$909.80
10x8	820108	\$918.60	\$1,020.66
10	82010	\$819.79	\$1,020.66
12x4	820124	\$962.85	\$1,069.88
12x6	820126	\$1,024.18	\$1,181.35
12x8	820128	\$1,140.72	\$1,267.43
12x10	8201210	\$1,155.12	\$1,408.38
12	82012	\$1,267.50	\$1,421.61
14x4	820144	\$1,223.28	\$1,587.18
14x6	820146	\$1,296.29	\$1,713.36
14x8	820148	\$1,366.11	\$1,801.69
14x10	8201410	\$1,598.87	\$1,924.81
14x12	8201412	\$1,816.13	\$2,032.49
14	82014	\$1,798.76	\$2,982.47
16x4	820164	\$1,312.28	\$1,775.63
16x6	820166	\$1,399.19	\$1,889.06
16x8	820168	\$1,537.92	\$2,098.11
16x10	8201610	\$1,780.06	\$2,274.37
16x12	8201612	\$1,953.07	\$2,506.41
16x14	8201614	\$2,335.02	\$2,890.11
16	82016	\$2,603.78	\$3,878.10
18x4	820184	\$1,352.58	\$3,233.59
18x6	820186	\$1,551.14	\$3,502.30
18x8	820188	\$1,701.98	\$3,652.26
18x10	8201810	\$2,023.16	\$3,912.69
18x12	8201812	\$2,097.97	\$4,134.92
18x14	8201814	\$2,767.06	\$4,394.39
18x16	8201816	\$3,162.87	\$4,450.53
18	82018	\$3,176.46	\$4,619.69
20x4	820204	\$1,707.39	\$3,965.82
20x6	820206	\$1,734.46	\$4,187.47
20x8	820208	\$1,824.43	\$4,316.20
20x10	8202010	\$2,234.69	\$4,494.56
20x12	8202012	\$2,432.79	\$4,819.32
20x14	8202014	\$3,074.51	\$5,168.07
20x16	8202016	\$3,629.42	\$5,539.22
20x18	8202018	\$3,854.56	\$5,833.66
20	82020	\$4,033.95	\$5,976.61
24x4	820244	\$3,396.34	\$4,937.95
24x6	820246	\$3,488.61	\$5,127.06
24x8	820248	\$3,642.96	\$5,261.54
24x10	8202410	\$3,722.84	\$5,584.10
24x12	8202412	\$3,828.30	\$5,790.17
24x14	8202414	\$4,109.86	\$6,029.09
24x16	8202416	\$4,317.89	\$6,307.23
24x18	8202418	\$4,718.37	\$7,628.95
24x20	8202420	\$5,067.38	\$7,772.72
24	82024	\$5,239.55	\$7,915.59

WYE

FEMALE X FEMALE X FEMALE

Size	PartNumber	SCH 40 SW Bell (32)	SCH 80 SW Bell (33)
6x2	92062	CF	\$575.40
6x3	92063	CF	\$604.92
8x2	92082	\$612.04	\$742.50
8x3	92083	\$664.99	\$781.62
8x4	92084	\$685.92	CF
8x6	92086	\$706.71	CF
10x2	920102	\$735.74	\$1,022.63
10x3	920103	\$788.34	\$1,042.54
10x4	920104	\$834.24	\$1,136.25
10x6	920106	\$921.16	\$1,292.96
10x8	920108	\$985.65	\$1,495.31
10	92010	\$1,239.60	\$1,539.84
12x4	920124	\$1,070.13	\$1,433.81
12x6	920126	\$1,075.27	\$1,635.21
12x8	920128	\$1,246.98	\$1,791.41
12x10	9201210	\$1,425.77	\$1,898.42
12	92012	\$2,182.72	CF

ELBOW

5 DEGREE

FEMALE X FEMALE

Size	PartNumber	SCH 40 SW Bell (32)	SCH 80 SW Bell (33)
10	30010	\$193.82	\$348.83
12	30012	\$306.61	\$509.81
14	30014	\$482.05	\$780.49
16	30016	\$657.11	\$1,043.30
18	30018	\$789.14	\$1,346.85
20	30020	\$975.49	\$2,323.60
24	30024	\$1,942.98	\$2,772.26

11-1/4 DEGREE

FEMALE X FEMALE

Size	PartNumber	SCH 40 SW Bell (32)	SCH 80 SW Bell (33)
10	31010	\$193.82	\$348.83
12	31012	\$306.61	\$509.83
14	31014	\$482.05	\$780.49
16	31016	\$657.16	\$1,043.30
18	31018	\$789.14	\$1,346.85
20	31020	\$975.49	\$2,323.60

22-1/2 DEGREE

FEMALE X FEMALE

Size	PartNumber	SCH 40 SW Bell (32)	SCH 80 SW Bell (33)
10	33010	\$193.82	\$348.83
12	33012	\$306.61	\$509.81
14	33014	\$482.05	\$780.49
16	33016	\$657.16	\$1,043.30
18	33018	\$789.14	\$1,346.85
20	33020	\$975.49	\$2,323.60
24	33024	\$1,942.98	\$2,772.26

ELBOW

45 DEGREE

FEMALE X FEMALE

Size	PartNumber	SCH 40 SW Bell (32)	SCH 80 SW Bell (33)
10	35010	\$333.95	\$534.22
12	35012	\$354.19	\$751.59
14	35014	\$742.98	\$1,225.06
16	35016	\$981.93	\$1,499.77
18	35018	\$1,038.22	\$1,825.48
20	35020	\$1,344.89	\$2,507.39
24	35024	\$2,164.01	\$3,105.78

90 DEGREE

FEMALE X FEMALE

Size	PartNumber	SCH 40 SW Bell (32)	SCH 80 SW Bell (33)
10	37010	\$474.80	\$759.68
12	37012	\$776.02	\$1,241.72
14	37014	\$1,118.50	\$1,583.95
16	37016	\$1,600.52	\$1,969.93
18	37018	\$1,718.15	\$2,815.28
20	37020	\$2,599.05	\$3,362.06
24	37024	\$3,894.90	\$5,162.86

45 DEGREE

FEMALE X MALE

Size	PartNumber	SCH 40 SW Bell (32)	SCH 80 SW Bell (33)
10	44010	\$370.78	CF
12	44012	\$393.55	CF
14	44014	\$802.69	CF
16	44016	\$1,091.04	CF
18	44018	\$1,190.96	CF
20	44020	\$1,511.70	CF
24	44024	\$2,381.21	CF

90 DEGREE

FEMALE X MALE

Size	PartNumber	SCH 40 SW Bell (32)	SCH 80 SW Bell (33)
10	46010	\$631.73	CF
12	46012	\$1,034.71	CF
14	46014	\$1,544.81	CF
16	46016	\$1,622.82	CF
18	46018	\$2,030.07	CF
20	46020	\$2,887.44	CF
24	46024	\$4,464.94	CF

PVC FITTINGS

C-900 DR18 NON-PRESSURE GASKETED FITTINGS



Specified Fittings



Specified Fittings

ADAPTER

SANDED MANHOLE

GASKET X MALE



Size	PartNumber	Price
4	581644	\$120.84
6	581646	\$170.02
8	581648	\$290.79
10	5816410	\$443.75
12	5816412	\$648.20
14	5816414	\$907.24
16	5816416	\$1,118.97
18	5816418	\$1,449.02
20	5816420	CF
24	5816424	CF

CDD x IPS

GASKET X GASKET

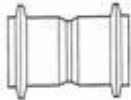

Size	PartNumber	Price
4	581054-IPS	\$146.25
6	581056-IPS	\$176.03
8	581058-IPS	\$566.24
10	5810510-IPS	\$693.69
12	5810512-IPS	\$830.97
14	5810514-IPS	\$1,761.25
16	5810516-IPS	\$2,310.34
18	5810518-IPS	\$2,650.70
20	5810520-IPS	\$3,202.18
24	5810524-IPS	\$3,753.62

GASKET X MALE

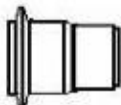

Size	PartNumber	Price
4	581344-IPS	\$146.25
6	581346-IPS	\$176.03
8	581348-IPS	\$566.24
10	5813410-IPS	\$693.69
12	5813412-IPS	\$830.97
14	5813414-IPS	\$1,761.25
16	5813416-IPS	\$2,310.34
18	5813418-IPS	\$2,650.70
20	5813420-IPS	\$3,202.18
24	5813424-IPS	\$3,753.62

MALE X GASKET

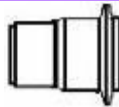

Size	PartNumber	Price
4	581714-IPS	\$146.25
6	581716-IPS	\$176.03
8	581718-IPS	\$566.24
10	5817110-IPS	\$693.69
12	5817112-IPS	\$830.97
14	5817114-IPS	\$761.00
16	5817116-IPS	CF
18	5817118-IPS	CF
20	5817120-IPS	CF
24	5817124-IPS	CF

CDD x SWR

GASKET X GASKET

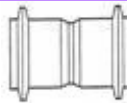

Size	PartNumber	Price
4	581054-SWR	\$146.25
6	581056-SWR	\$176.03
8	581058-SWR	\$566.24
10	5810510-SWR	\$693.69
12	5810512-SWR	\$830.97
18	5810518-SWR	\$2,650.70
24	5810524-SWR	\$3,753.62

GASKET X MALE

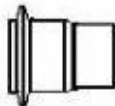

Size	PartNumber	Price
4	581344	\$146.25
6	581346	\$176.03
8	581348	\$566.24
10	5813410	\$693.69
12	5813412	\$830.97
18	5813418	\$2,650.70
24	5813424	\$3,753.62

MALE X GASKET

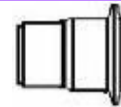

Size	PartNumber	Price
4	581714	\$146.25
6	581716	\$176.03
8	581718	\$566.24
10	5817110	\$693.69
12	5817112	\$830.97
18	5817118	\$2,650.70
24	5817124	\$3,753.62

COUPLING

REPAIR

GASKET X GASKET



Size	PartNumber	Price
4	582204	\$76.15
6	582206	\$116.76
8	582208	\$264.37
10	5822010	\$403.44
12	5822012	\$589.29
14	5822014	\$1,483.07
16	5822016	\$1,769.83
18	5822018	\$4,718.27
20	5822020	\$5,295.21
24	5822024	\$6,682.71

STOP

GASKET X GASKET

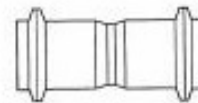

Size	PartNumber	Price
4	582404	\$76.15
6	582406	\$116.76
8	582408	\$264.37
10	5824010	\$403.44
12	5824012	\$589.29
14	5824014	\$1,483.07
16	5824016	\$1,769.83
18	5824018	\$4,718.27
20	5824020	\$5,295.21
24	5824024	\$6,682.71

C-900 GASKETED NON-PRESSURE

CAP

GASKETED



Size	PartNumber	Price
4	581904	\$137.80
6	581906	\$231.91
8	581908	\$513.73
10	5819010	\$736.81
12	5819012	\$857.47
14	5819014	\$890.78
16	5819016	\$1,005.08
18	5819018	\$1,674.01
20	5819020	\$1,926.15
24	5819024	\$2,776.61

PLUG

MALE

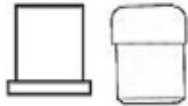

Size	PartNumber	Price
4	585604	\$131.53
6	585606	\$228.40
8	585608	\$493.24
10	5856010	\$593.72
12	5856012	\$749.67
14	5856014	\$799.77
16	5856016	\$883.95
18	5856018	\$1,448.80
20	5856020	\$1,700.88
24	5856024	\$2,675.71

CROSS

GASKET X GASKET X GASKET X GASKET

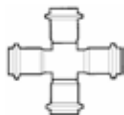

Size	PartNumber	Price
6x4	5826064	\$392.27
8x4	5826084	\$794.80
8x6	5826086	\$909.97
10x4	58260104	\$924.31
10x6	58260106	\$1,051.24
10x8	58260108	\$1,216.06
12x4	58260124	\$1,181.13
12x6	58260126	\$1,330.96
12x8	58260128	\$1,566.27
12x10	582601210	\$1,823.41

ELBOW

11-1/4 DEGREE

GASKET X GASKET



Size	PartNumber	Price
4	583104	\$147.35
6	583106	\$225.52
8	583108	\$428.28
10	5831010	\$653.55
12	5831012	\$993.92
14	5831014	\$1,826.43
16	5831016	\$2,219.33
18	5831018	\$3,897.09
20	5831020	\$4,838.60
24	5831024	\$6,845.50

ELBOW

22 1/2 DEGREE

GASKET X MALE



Size	PartNumber	Price
4	584204	\$147.35
6	584206	\$225.52
8	584208	\$428.28
10	5842010	\$653.55
12	5842012	\$993.92
14	5842014	\$1,826.43
16	5842016	\$2,219.33
18	5842018	\$3,897.09
20	5842020	\$4,838.60
24	5842024	\$6,845.50

ELBOW

45 DEGREE

GASKET X GASKET



Size	PartNumber	Price
4	583504	\$147.35
6	583506	\$225.52
8	583508	\$428.28
10	5835010	\$653.55
12	5835012	\$993.92
14	5835014	\$1,826.43
16	5835016	\$2,219.33
18	5835018	\$3,897.09
20	5835020	\$4,838.60
24	5835024	\$6,845.50

90 DEGREE

GASKET X GASKET

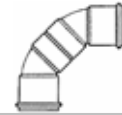

Size	PartNumber	Price
4	583704	\$172.70
6	583706	\$404.05
8	583708	\$764.05
10	5837010	\$1,165.97
12	5837012	\$1,537.73
14	5837014	\$2,311.34
16	5837016	\$2,757.33
18	5837018	\$4,905.87
20	5837020	\$5,900.47
24	5837024	\$9,882.51

ELBOW

11-1/4 DEGREE

GASKET X MALE



Size	PartNumber	Price
4	584004	\$147.35
6	584006	\$225.52
8	584008	\$428.28
10	5840010	\$653.55
12	5840012	\$993.92
14	5840014	\$1,826.43
16	5840016	\$2,219.33
18	5840018	\$3,897.09
20	5840020	\$4,838.60
24	5840024	\$6,845.50

ELBOW

22-1/2 DEGREE

GASKET X GASKET



Size	PartNumber	Price
4	583304	\$147.35
6	583306	\$225.52
8	583308	\$428.28
10	5833010	\$653.55
12	5833012	\$993.92
14	5833014	\$1,826.43
16	5833016	\$2,219.33
18	5833018	\$3,897.09
20	5833020	\$4,838.60
24	5833024	\$6,845.50

ELBOW

45 DEGREE

GASKET X MALE



Size	PartNumber	Price
4	584404	\$147.35
6	584406	\$225.52
8	584408	\$428.28
10	5844010	\$653.55
12	5844012	\$993.92
14	5844014	\$1,826.43
16	5844016	\$2,219.33
18	5844018	\$3,897.09
20	5844020	\$4,838.60
24	5844024	\$6,845.50

ELBOW

90 DEGREE

GASKET X MALE



Size	PartNumber	Price
4	584604	\$172.70
6	584606	\$404.05
8	584608	\$764.05
10	5846010	\$1,165.97
12	5846012	\$1,537.73
14	5846014	\$2,311.34
16	5846016	\$2,757.33
18	5846018	\$4,905.87
20	5846020	\$5,900.47
24	5846024	\$9,882.51

REDUCER

CONCENTRIC

GASKET X GASKET

STYLE A

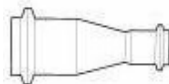

Size	PartNumber	Price
6x4	5860064	\$176.03
8x6	5860086	\$484.66
10x8	58600108	\$693.69
12x10	586001210	\$830.97

STYLE B

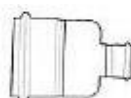

Size	PartNumber	Price
8x4	5860084	\$590.79
10x4	58600104	\$773.64
10x6	58600106	\$810.50
12x4	58600124	\$986.09
12x6	58600126	\$1,028.96
12x8	58600128	\$1,071.83

MALE X GASKET

STYLE A

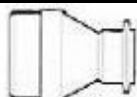

Size	PartNumber	Price
6x4	5862064	\$176.03
8x6	5862086	\$484.66
10x8	58620108	\$693.69
12x10	586201210	\$830.97

STYLE B

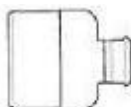

Size	PartNumber	Price
8x4	5862084	\$567.23
10x4	58620104	\$682.78
10x6	58620106	\$712.47
12x4	58620124	\$862.12
12x6	58620126	\$899.60
12x8	58620128	\$937.09

TEE

STRAIGHT

GASKET X GASKET X GASKET



Size	PartNumber	Price
6x4	5882064	\$240.27
8x4	5882084	\$626.47
8x6	5882086	\$704.10
10x4	58820104	\$791.04
10x6	58820106	\$812.91
10x8	58820108	\$870.41
12x4	58820124	\$1,020.73
12x6	58820126	\$1,092.79
12x8	58820128	\$1,210.71
12x10	588201210	\$1,374.53
14x4	58820144	\$2,364.93
14x6	58820146	\$2,436.68
14x8	58820148	\$3,029.77
14x10	588201410	\$3,162.34
14x12	588201412	\$3,339.63
16x4	58820164	\$3,214.91
16x6	58820166	\$3,313.12
16x8	58820168	\$3,392.48
16x10	588201610	\$3,456.68
16x12	588201612	\$3,490.68
16x14	588201614	\$3,955.36
18x4	58820184	\$5,436.25
18x6	58820186	\$5,602.46
18x8	58820188	\$5,693.12
18x10	588201810	\$6,025.54
18x12	588201812	\$6,376.91
18x14	588201814	\$7,211.78
18x16	588201816	\$7,691.60
20x4	58820204	\$6,252.25
20x6	58820206	\$6,442.15
20x8	58820208	\$6,603.58
20x10	588202010	\$6,811.40
20x12	588202012	\$7,192.89
20x14	588202014	\$7,680.28
20x16	588202016	\$8,054.26
20x18	588202018	\$9,108.29
24x4	58820244	\$8,972.27
24x6	58820246	\$9,248.06
24x8	58820248	\$9,361.39
24x10	588202410	\$9,486.04
24x12	588202412	\$9,554.03
24x14	588202414	\$9,920.50
24x16	588202416	\$10,113.13
24x18	588202418	\$12,602.77
24x20	588202420	\$12,765.18

TEE

C900 X C900 X SCH40 (GASKETED HUB)

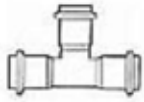

Size	PartNumber	Price
6x4	588206-4IPS	\$240.27
8x4	588208-4IPS	\$626.47
8x6	588208-6IPS	\$704.10
10x4	5882010-4IPS	\$791.04
10x6	5882010-6IPS	\$812.91
10x8	5882010-8IPS	\$870.41
12x4	5882012-4IPS	\$1,020.73
12x6	5882012-6IPS	\$1,092.79
12x8	5882012-8IPS	\$1,210.71
12x10	5882012-10IPS	\$1,374.53
14x4	5882014-4IPS	\$2,364.93
14x6	5882014-6IPS	\$2,436.68
14x8	5882014-8IPS	\$3,029.77
14x10	5882014-10IPS	\$3,162.34
14x12	5882014-12IPS	\$3,339.63
16x4	5882016-4IPS	\$3,214.91
16x6	5882016-6IPS	\$3,313.12
16x8	5882016-8IPS	\$3,392.48
16x10	5882016-10IPS	\$3,456.68
16x12	5882016-12IPS	\$3,490.68
16x14	5882016-14IPS	\$3,955.36
18x4	5882018-4IPS	\$5,436.25
18x6	5882018-6IPS	\$5,602.46
18x8	5882018-8IPS	\$5,693.12
18x10	5882018-10IPS	\$6,025.54
18x12	5882018-12IPS	\$6,376.91
18x14	5882018-14IPS	\$7,211.78
18x16	5882018-16IPS	\$7,691.60
20x4	5882020-4IPS	\$6,252.25
20x6	5882020-6IPS	\$6,442.15
20x8	5882020-8IPS	\$6,603.58
20x10	5882020-10IPS	\$6,811.40
20x12	5882020-12IPS	\$7,192.89
20x14	5882020-14IPS	\$7,680.28
20x16	5882020-16IPS	\$8,054.26
20x18	5882020-18IPS	\$9,108.29
24x4	5882024-4IPS	\$8,972.27
24x6	5882024-6IPS	\$9,248.06
24x8	5882024-8IPS	\$9,361.39
24x10	5882024-10IPS	\$9,486.04
24x12	5882024-12IPS	\$9,554.03
24x14	5882024-14IPS	\$9,920.50
24x16	5882024-16IPS	\$10,113.13
24x18	5882024-18IPS	\$12,602.77
24x20	5882024-20IPS	\$12,765.18

C900 X C900 X HWS (GASKETED HUB)

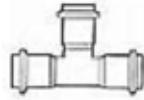

Size	PartNumber	Price
6x4	588206-4HWS	\$240.27
8x4	588208-4HWS	\$626.47
8x6	588208-6HWS	\$704.10
10x4	5882010-4HWS	\$791.04
10x6	5882010-6HWS	\$812.91
10x8	5882010-8HWS	\$870.41
12x4	5882012-4HWS	\$1,020.73
12x6	5882012-6HWS	\$1,092.79
12x8	5882012-8HWS	\$1,210.71
12x10	5882012-10HWS	\$1,374.53
14x4	5882014-4HWS	\$2,364.93
14x6	5882014-6HWS	\$2,436.68
14x8	5882014-8HWS	\$3,029.77
14x10	5882014-10HWS	\$3,162.34
14x12	5882014-12HWS	\$3,339.63
16x4	5882016-4HWS	\$3,214.91
16x6	5882016-6HWS	\$3,313.12
16x8	5882016-8HWS	\$3,392.48
16x10	5882016-10HWS	\$3,456.68
16x12	5882016-12HWS	\$3,490.68
16x14	5882016-14HWS	\$3,955.36
18x4	5882018-4HWS	\$5,436.25
18x6	5882018-6HWS	\$5,602.46
18x8	5882018-8HWS	\$5,693.12
18x10	5882018-10HWS	\$6,025.54
18x12	5882018-12HWS	\$6,376.91
18x14	5882018-14HWS	\$7,211.78
18x16	5882018-16HWS	\$7,691.60
20x4	5882020-4HWS	\$6,252.25
20x6	5882020-6HWS	\$6,442.15
20x8	5882020-8HWS	\$6,603.58
20x10	5882020-10HWS	\$6,811.40
20x12	5882020-12HWS	\$7,192.89
20x14	5882020-14HWS	\$7,680.28
20x16	5882020-16HWS	\$8,054.26
20x18	5882020-18HWS	\$9,108.29
24x4	5882024-4HWS	\$8,972.27
24x6	5882024-6HWS	\$9,248.06
24x8	5882024-8HWS	\$9,361.39
24x10	5882024-10HWS	\$9,486.04
24x12	5882024-12HWS	\$9,554.03
24x14	5882024-14HWS	\$9,920.50
24x16	5882024-16HWS	\$10,113.13
24x18	5882024-18HWS	\$12,602.77
24x20	5882024-20HWS	\$12,765.18

T-Y

GASKET X GASKET X GASKET

Size	PartNumber	Price
6x4	5889064	\$282.15
8x4	5889084	\$684.70
8x6	5889086	\$726.47
10x4	58890104	\$814.19
10x6	58890106	\$867.71
10x8	58890108	\$922.43
12x4	58890124	\$1,070.98
12x6	58890126	\$1,147.44
12x8	58890128	\$1,272.62
12x10	588901210	\$1,456.37
14x4	58890144	\$2,258.67
14x6	58890146	\$2,328.06
14x8	58890148	\$2,435.79
14x10	588901410	\$2,552.68
14x12	588901412	\$2,928.81
16x4	58890164	\$2,859.43
16x6	58890166	\$2,947.05
16x8	58890168	\$3,058.45
16x10	588901610	\$3,208.13
16x12	588901612	\$3,354.24
18x4	58890184	\$5,185.66
18x6	58890186	\$5,346.35
18x8	58890188	\$5,512.47
18x10	588901810	\$5,715.19
18x12	588901812	\$6,010.99
20x4	58890204	\$6,452.88
20x6	58890206	\$6,651.88
20x8	58890208	\$6,858.22
20x10	588902010	\$7,070.02
20x12	588902012	\$7,287.32
24x4	58890244	\$8,067.00
24x6	58890246	\$8,315.32
24x8	58890248	\$8,572.78
24x10	588902410	\$8,837.50
24x12	588902412	\$9,109.56

C-900 GASKETED NON-PRESSURE

T-Y

GASKETED HUB

C900 X C900 X HWS

Size	PartNumber	Price
4	588904-HWS	CF
6x4	588906-4HWS	\$282.15
8x4	588908-4HWS	\$684.70
8x6	588908-6HWS	\$726.47
10x4	5889010-4HWS	\$814.19
10x6	5889010-6HWS	\$867.71
10x8	5889010-8HWS	\$922.43
12x4	5889012-4HWS	\$1,070.98
12x6	5889012-6HWS	\$1,147.44
12x8	5889012-8HWS	\$1,272.62
12x10	5889012-10HWS	\$1,456.37
14x4	5889014-4HWS	\$2,258.67
14x6	5889014-6HWS	\$2,328.06
14x8	5889014-8HWS	\$2,435.79
14x10	5889014-10HWS	\$2,552.68
14x12	5889014-12HWS	\$2,928.81
16x4	5889016-4HWS	\$2,859.43
16x6	5889016-6HWS	\$2,947.05
16x8	5889016-8HWS	\$3,058.45
16x10	5889016-10HWS	\$3,208.13
16x12	5889016-12HWS	\$3,354.24
18x4	5889018-4HWS	\$5,185.66
18x6	5889018-6HWS	\$5,346.35
18x8	5889018-8HWS	\$5,512.47
18x10	5889018-10HWS	\$5,715.19
18x12	5889018-12HWS	\$6,010.99
20x4	5889020-4HWS	\$6,452.88
20x6	5889020-6HWS	\$6,651.88
20x8	5889020-8HWS	\$6,858.22
20x10	5889020-10HWS	\$7,070.02
20x12	5889020-12HWS	\$7,287.32
24x4	5889024-4HWS	\$8,067.00
24x6	5889024-6HWS	\$8,315.32
24x8	5889024-8HWS	\$8,572.78
24x10	5889024-10HWS	\$8,837.50
24x12	5889024-12HWS	\$9,109.56

DOUBLE WYE

GASKET HUB

C900 X C900 X C900 X C900

Size	PartNumber	Price
6x4	5894064	\$392.27
8x4	5894084	\$794.80
8x6	5894086	\$909.97
10x4	58940104	\$924.31
10x6	58940106	\$1,051.24
10x8	58940108	\$1,216.06
12x4	58940124	\$1,181.13
12x6	58940126	\$1,330.96
12x8	58940128	\$1,566.27
12x10	589401210	\$1,823.41

WYE

GASKET X GASKET X GASKET



Size	PartNumber	Price
6x4	5892064	\$282.15
8x4	5892084	\$684.70
8x6	5892086	\$726.47
10x4	58920104	\$814.19
10x6	58920106	\$867.71
10x8	58920108	\$922.43
12x4	58920124	\$1,070.98
12x6	58920126	\$1,147.44
12x8	58920128	\$1,272.62
12x10	589201210	\$1,456.37
14x4	58920144	\$2,258.67
14x6	58920146	\$2,328.06
14x8	58920148	\$2,435.79
14x10	589201410	\$2,552.68
14x12	589201412	\$2,928.81
16x4	58920164	\$2,859.43
16x6	58920166	\$2,947.05
16x8	58920168	\$3,058.45
16x10	589201610	\$3,208.13
16x12	589201612	\$3,354.24
16x14	589201614	\$3,409.01
18x4	58920184	\$5,185.66
18x6	58920186	\$5,346.35
18x8	58920188	\$5,512.47
18x10	589201810	\$5,715.19
18x12	589201812	\$6,010.99
18x14	589201814	\$6,295.82
18x16	589201816	\$6,646.44
20x4	58920204	\$6,452.88
20x6	58920206	\$6,651.88
20x8	58920208	\$6,858.22
20x10	589202010	\$7,070.02
20x12	589202012	\$7,287.32
20x14	589202014	\$7,647.03
20x16	589202016	\$7,948.31
20x18	589202018	\$8,512.51
24x4	58920244	\$8,067.00
24x6	58920246	\$8,315.32
24x8	58920248	\$8,572.78
24x10	589202410	\$8,837.50
24x12	589202412	\$9,109.56
24x14	589202414	\$9,558.79
24x16	589202416	\$9,934.92
24x18	589202418	\$10,641.57
24x20	589202420	\$11,110.78

GASKET HUB

C900 X C900 X HWS



Size	PartNumber	Price
6x4	589206-4HWS	\$282.15
8x4	589208-4HWS	\$684.70
8x6	589208-6HWS	\$726.47
10x4	5892010-4HWS	\$814.19
10x6	5892010-6HWS	\$867.71
10x8	5892010-8HWS	\$922.43
12x4	5892012-4HWS	\$1,070.98
12x6	5892012-6HWS	\$1,147.44
12x8	5892012-8HWS	\$1,272.62
12x10	5892012-10HWS	\$1,456.37
14x4	5892014-4HWS	\$2,258.67
14x6	5892014-6HWS	\$2,328.06
14x8	5892014-8HWS	\$2,435.79
14x10	5892014-10HWS	\$2,552.68
14x12	5892014-12HWS	\$2,928.81
16x4	5892016-4HWS	\$2,859.43
16x6	5892016-6HWS	\$2,947.05
16x8	5892016-8HWS	\$3,058.45
16x10	5892016-10HWS	\$3,208.13
16x12	5892016-12HWS	\$3,354.24
16x14	5892016-14HWS	\$3,409.01
18x4	5892018-4HWS	\$5,185.66
18x6	5892018-6HWS	\$5,346.35
18x8	5892018-8HWS	\$5,512.47
18x10	5892018-10HWS	\$5,715.19
18x12	5892018-12HWS	\$6,010.99
18x14	5892018-14HWS	\$6,295.82
18x16	5892018-16HWS	\$6,646.44
20x4	5892020-4HWS	\$6,452.88
20x6	5892020-6HWS	\$6,651.88
20x8	5892020-8HWS	\$6,858.22
20x10	5892020-10HWS	\$7,070.02
20x12	5892020-12HWS	\$7,287.32
20x14	5892020-14HWS	\$7,647.03
20x16	5892020-16HWS	\$7,948.31
20x18	5892020-18HWS	\$8,512.51
24x4	5892024-4HWS	\$8,067.00
24x6	5892024-6HWS	\$8,315.32
24x8	5892024-8HWS	\$8,572.78
24x10	5892024-10HWS	\$8,837.50
24x12	5892024-12HWS	\$9,109.56
24x14	5892024-14HWS	\$9,558.79
24x16	5892024-16HWS	\$9,934.92
24x18	5892024-18HWS	\$10,641.57
24x20	5892024-20HWS	\$11,110.78

C-900 GASKETED NON-PRESSURE

Specified's "Schedule" Selection

How about *that* for alliteration? Seriously though, Specified Fittings offers a complete selection of molded and fabricated Sch40 PVC, Sch80 PVC, Sch40 CPVC, and Sch80 CPVC 1/8" - 24" where applicable. Our product knowledge and service level make us a great resource for these products—whether you're filling out a fabricated order or just looking for molded fittings. We sell molded 10" and 12" Sch40, Sch80, Sch80 CPVC at competitive prices as well as fabricated in all configurations of 10" and 12".

In the size range 14" - 24" in the aforementioned materials, no one offers a broader line than Specified Fittings. Whether non-pressure, low pressure, fully rated, fiberglass reinforced, spouted, fused, glue joint, gasket joint, or grooved connections, we do it all. Bring your list, job requirements, estimates in whatever form you wish, and let our Inside Sales Team put some numbers to your needs. If it is industrial fittings you need, Specified is a great resource!

P.S. Remember: Our entire pipe inventory can be purchased—cut to length: Sch40 & Sch80 CPVC through 24", Sch40 & Sch80 through 24", Sch120 through 6" to name but a few. ■



PVC FITTINGS

SCH40 NON-PRESSURE GASKETED FITTINGS



Specified Fittings



Specified Fittings



ADAPTER

FEMALE X MALE

GASKETED BELL

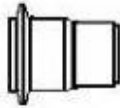

- Available in Smaller, Larger, and Reducing Sizes in Addition to Longer Lengths.

Size	PartNumber	
4	761344	\$56.42
6	761346	\$117.38
8	761348	\$207.33
10	7613410	\$310.71
12	7613412	\$457.39

IPS X SEWER

FEMALE X FEMALE

GASKETED BELL

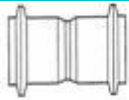

- Available in Smaller, Larger, and Reducing Sizes in Addition to Longer Lengths.

Size	PartNumber	GSK Bell (76)
4	761054-SWR	\$56.42
6	761056-SWR	\$117.38
8	761058-SWR	\$207.33
10	7610510-SWR	\$310.71
12	7610512-SWR	\$457.39

ADAPTER

IPS X SEWER

FEMALE X MALE

GASKETED BELL

- Available in Smaller, Larger, and Reducing Sizes in Addition to Longer Lengths.

Size	PartNumber	
4	761344-SWR	\$56.42
4x6	7613446-SWR	\$92.67
6	761346-SWR	\$117.38
8	761348-SWR	\$207.31
10	7613410-SWR	\$310.71
12	7613412-SWR	\$457.39

ADAPTER

IPS X SEWER

MALE X FEMALE

FOR GASKETED BELL

Available in Smaller, Larger Sizes and Reducing Sizes.

O-Ring Available—Please Contact Factory.

Size	PartNumber	
4	761714-SWR	\$56.42
6	761716-SWR	\$117.38
8	761718-SWR	\$207.33
10	7617110-SWR	\$310.71
12	7617112-SWR	\$457.39

RISER

FEMALE X FEMALE

GASKETED BELL

DEEP SOCKET SETTLER

Available in Smaller and Larger

Size	PartNumber	
4	762444	\$112.17
6	762446	\$152.53

MALE X FEMALE

GASKETED BELL

DEEP SOCKET SETTLER

Available in Smaller, Larger Sizes or Dissimilar Outlet.

Size	PartNumber	
4	762464	\$82.20
6	762466	\$114.90

SANDED MANHOLE

FEMALE X SLIP BELL

GASKETED BELL



Available in Smaller Sizes, Longer Lengths and Without Stop.

Size	PartNumber	
4	761644	\$106.87
6	761646	\$147.66
8	761648	\$169.78
10	7616410	\$267.95
12	7616412	\$393.10

COUPLING

REPAIR

FEMALE X FEMALE

GASKETED BELL



Available in Smaller/Larger Sizes, Longer Lengths, and in Tapped Style.
10"-12" Molded Fittings Available—Please Contact Factory.

Size	PartNumber	
4	762204	\$56.42
6	762206	\$117.37
8	762208	\$207.33
10	7622010	\$310.71
12	7622012	\$457.39

STOP

FEMALE X FEMALE

GASKETED BELL

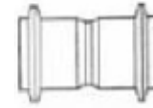

Available in Smaller, Larger Sizes, Longer Lengths, Tapped Style, and Threaded.
10"-12" Molded Fittings Available—Please Contact Factory.

Size	PartNumber	
4	762404	\$56.42
6	762406	\$117.37
8	762408	\$207.33
10	7624010	\$310.71
12	7624012	\$457.39

CAP

FEMALE

GASKETED BELL



Available in Domed Style, Tapped Concentrically and Eccentrically, and with Varying Depths.

Size	PartNumber	
4	761904	\$93.97
6	761906	\$147.55
8	761908	\$242.05
10	7619010	\$389.15
12	7619012	\$513.39

PLUG

MALE

GASKETED BELL



Available in Smaller and Larger Sizes, or Tapped Concentrically and Eccentrically.

Size	PartNumber	
4	765604	\$38.80
6	765606	\$112.06
8	765608	\$188.52
10	7656010	\$275.46
12	7656012	\$345.36

ELBOW

11-1/4 DEGREE

FEMALE X FEMALE

GASKETED BELL



§ Available in Smaller and Larger Sizes, Threaded, and with Dissimilar Outlets.

Size	PartNumber	
4	763104	\$149.84
6	763106	\$208.05
8	763108	\$351.80
10	7631010	\$584.13
12	7631012	\$924.02

22-1/2 DEGREE

FEMALE X FEMALE

GASKETED BELL



§ Available in Smaller and Larger Sizes, Threaded, and with Dissimilar Outlets.

Size	PartNumber	
4	763304	\$149.84
6	763306	\$208.05
8	763308	\$351.80
10	7633010	\$584.13
12	7633012	\$924.02

30 DEGREE

FEMALE X FEMALE

GASKETED BELL

§ Available in Smaller and Larger Sizes, Threaded, and with Dissimilar Outlets.

Size	PartNumber	
4	763404	\$149.84
6	763406	\$208.05
8	763408	\$351.80
10	7634010	\$584.13
12	7634012	\$924.02

45 DEGREE

FEMALE X FEMALE

GASKETED BELL



§ Available in Smaller, Larger, Reducing Sizes, and with Dissimilar Outlets.

§ 10"-12" Molded Fittings Available—Please Contact Factory.

Size	PartNumber	
4	763504	\$149.84
6	763506	\$199.46
8	763508	\$370.90
10	7635010	\$647.98
12	7635012	\$838.57

DEEP SOCKET (ONE END)

§ Available in Smaller and Larger Sizes, and with Dissimilar Outlets.

Size	PartNumber	
4	763504-DSOE	\$171.70
6	763506-DSOE	\$194.80

90 DEGREE

FEMALE X FEMALE

GASKETED BELL



§ Available in Smaller, Larger, Reducing Sizes, and with Dissimilar Outlets.

§ 10"-12" Molded Fittings Available—Please Contact Factory.

Size	PartNumber	
4	763704	\$168.01
6	763706	\$410.24
8	763708	\$496.78
10	7637010	\$875.67
12	7637012	\$1,347.04

11-1/4 DEGREE

FEMALE X MALE

GASKETED BELL



§ Available in Smaller and Larger Sizes, Threaded, and with Dissimilar Outlets.

Size	PartNumber	
4	764004	\$149.84
6	764006	\$208.05
8	764008	\$351.80
10	7640010	\$584.13
12	7640012	\$924.02

22-1/2 DEGREE

FEMALE X MALE

GASKETED BELL



§ Available in Smaller and Larger Sizes, Threaded, and with Dissimilar Outlets.

Size	PartNumber	
4	764204	\$149.84
6	764206	\$208.05
8	764208	\$351.80
10	7642010	\$584.13
12	7642012	\$924.02

45 DEGREE

FEMALE X MALE

GASKETED BELL



§ Available in Smaller and Larger Sizes, Threaded, and with Dissimilar Outlets.

Size	PartNumber	
4	764404	\$149.84
6	764406	\$208.05
8	764408	\$351.80
10	7644010	\$584.13
12	7644012	\$924.02

90 DEGREE

FEMALE X MALE

GASKETED BELL

FABRICATED

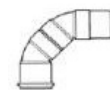

§ Available in Smaller and Larger Sizes, Threaded, and with Dissimilar Outlets.

Size	PartNumber	
4	764604	\$168.01
6	764606	\$410.24
8	764608	\$496.78
10	7646010	\$875.67
12	7646012	\$1,347.04

REDUCER

CONCENTRIC

FEMALE X FEMALE

GASKETED BELL

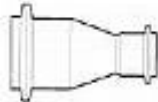

§ Available in Smaller and Larger Sizes, and with Dissimilar Outlets.
 § 10"-12" Molded Fittings Available—Please Contact Factory.

Size	PartNumber	
3x2	7660032	CF
4x3	7660043	CF
6x4	7660064	\$119.24
8x4	7660084	\$296.02
8x6	7660086	\$254.42
10x4	7660104	\$430.40
10x6	7660106	\$684.27
10x8	7660108	\$571.87
12x4	7660124	\$632.14
12x6	7660126	\$759.29
12x8	7660128	\$760.82
12x10	76601210	\$886.10

MALE X FEMALE

GASKETED BELL

(SEB)



§ Available in Smaller and Larger Sizes, and with Dissimilar Outlets.
 § 10"-12" Molded Fittings Available—Please Contact Factory.

Size	PartNumber	
4x3	7662043	CF
6x4	7662064	\$119.24
8x4	7662084	\$279.77
8x6	7662086	\$254.42
10x4	76620104	\$417.05
10x6	76620106	\$509.75
10x8	76620108	\$571.87
12x4	76620124	\$629.13
12x6	76620126	\$759.03
12x8	76620128	\$760.82
12x10	766201210	\$885.15
16x4	76620164	\$1,148.56
16x6	76620166	\$1,182.55
16x8	76620168	\$1,364.76
16x10	766201610	\$1,532.65
16x12	766201612	\$1,549.26

ECCENTRIC

FEMALE X FEMALE

GASKETED BELL

§ Available in Smaller and Larger Sizes, and with Dissimilar Outlets.

Size	PartNumber	
3x2	7661032	CF
4x3	7661043	CF
6x4	7661064	\$119.24
8x4	7661084	\$296.02
8x6	7661086	\$254.42
10x4	76610104	\$430.40
10x6	76610106	\$684.27
10x8	76610108	\$571.87
12x4	76610124	\$632.14
12x6	76610126	\$759.29
12x8	76610128	\$760.82
12x10	766101210	\$886.10

ECCENTRIC

MALE X FEMALE

GASKETED BELL

(SEB)

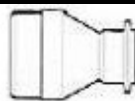

§ Available in Smaller and Larger Sizes, and with Dissimilar Outlets.

Size	PartNumber	
3x2	7663032	CF
4x3	7663043	CF
6x4	7663064	\$119.24
8x4	7663084	\$279.77
8x6	7663086	\$254.42
10x4	76630104	\$417.05
10x6	76630106	\$509.75
10x8	76630108	\$571.87
12x4	76630124	\$629.13
12x6	76630126	\$759.03
12x8	76630128	\$760.82
12x10	766301210	\$885.15

SADDLE TEE W/2 S.S. BANDS

FEMALE SLIP X FEMALE

GASKETED BELL



§ A Gasket Base Available—Please Contact Factory.
 § Available in Smaller and Larger Sizes, with Dissimilar Outlet.
 § Available with Numerous Skirt Dimension Sizes.

Size	PartNumber	
4x2	7670142	CF
4X3	7670143	CF
6x4	7670164	\$152.42
8x4	7670184	\$176.29
8x6	7670186	\$181.52
10x4	76701104	\$222.29
10x6	76701106	\$259.03
10x8	76701108	\$581.61
12x4	76701124	\$268.26
12x6	76701126	\$311.54
12x8	76701128	\$818.96
12x10	767011210	\$980.59

SADDLE WYE W/2 S.S. BANDS

FEMALE SLIP X FEMALE

GASKETED BELL



§ A Gasket Base Available—Please Contact Factory.
 § Available in Smaller and Larger Sizes, with Dissimilar Outlet.
 § Available with Numerous Skirt Dimension Sizes.

Size	PartNumber	
6x4	7674164	\$152.42
8x4	7674184	\$176.29
8x6	7674186	\$181.52
10x4	76741104	\$222.29
10x6	76741106	\$259.03
10x8	76741108	\$581.61
12x4	76741124	\$268.26
12x6	76741126	\$311.54
12x8	76741128	\$818.96
12x10	767411210	\$980.59

SCH40 NON-PRESSURE

CROSS

FEMALE X FEMALE X FEMALE X FEMALE

GASKETED BELL

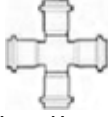

§ Available in Smaller and Larger Sizes, Threaded, and with Dissimilar Outlets.

Size	PartNumber	
4	762604	\$0.00
6x4	7626064	\$224.21
6	762606	\$300.68
8x4	7626084	\$372.32
8x6	7626086	\$501.97
8	762608	\$666.02
10x4	76260104	\$896.89
10x6	76260106	\$931.69
10x8	76260108	\$1,282.91
10	7626010	\$1,526.68
12x4	76260124	\$975.66
12x6	76260126	\$1,145.99
12x8	76260128	\$1,331.12
12x10	762601210	\$1,656.14
12	7626012	\$1,799.37

TEE

SANITARY

GASKETED BELL

§ Available in Smaller and Larger Sizes, Tapped Style, or with Dissimilar Outlet.

Size	PartNumber	
4	768104	CF
6x4	7681064	\$363.19
6	768106	\$485.12
8x4	7681084	\$531.69
8x6	7681086	\$656.15
8	768108	\$941.46
10x4	76810104	\$845.77
10x6	76810106	\$1,035.07
10x8	76810108	\$1,396.97
10	7681010	CF
12x4	76810124	\$1,074.58
12x6	76810126	\$1,116.28
12x8	76810128	\$1,819.58

STRAIGHT

GASKETED BELL

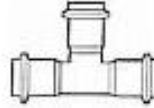

§ Available in Smaller or Larger Sizes, Threaded or Dissimilar Outlets.

Size	PartNumber	
4	768204	CF
6x4	7682064	\$198.58
6	768206	\$209.33
8x4	7682084	\$314.48
8x6	7682086	\$391.93
8	768208	\$634.47
10x4	76820104	\$547.62
10x6	76820106	\$655.36
10x8	76820108	\$846.48
10	7682010	\$879.87
12x4	76820124	\$720.38
12x6	76820126	\$822.30
12x8	76820128	\$944.25
12x10	768201210	\$1,136.00
12	7682012	\$1,378.23

T-Y

GASKETED BELL

§ Available in Smaller and Larger Sizes, and with Dissimilar Outlet.

Size	PartNumber	
4	768904	CF
6x4	7689064	\$363.19
6	768906	\$485.12
8x4	7689084	\$531.69
8x6	7689086	\$656.15
8	768908	\$941.46
10x4	76890104	\$845.77
10x6	76890106	\$1,035.07
10x8	76890108	\$1,396.97
10	7689010	\$0.00
12x4	76890124	\$1,074.58
12x6	76890126	\$1,116.28
12x8	76890128	\$1,819.58

WYE

GASKETED BELL

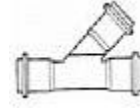

§ Available in Smaller, Larger Sizes, Tapped Style, or with Flanged Connections.

§ 10"-12" Molded Fittings Available—Please Contact Factory.

Size	PartNumber	
4	769204	\$120.63
6x4	7692064	\$249.51
6	769206	\$282.04
8x4	7692084	\$365.38
8x6	7692086	\$484.23
8	769208	\$612.48
10x4	76920104	\$626.40
10x6	76920106	\$811.65
10x8	76920108	\$963.28
10	7692010	\$1,098.01
12x4	76920124	\$969.23
12x6	76920126	\$1,057.28
12x8	76920128	\$1,257.15
12x10	769201210	\$1,407.90
12	7692012	\$1,785.85

DOUBLE

GASKETED BELL

§ Available in Smaller and Larger Sizes, and with Dissimilar Outlets.

Size	PartNumber	
4	769404	CF
6x4	7694064	\$244.92
6	769406	\$391.75
8x4	7694084	\$447.26
8x6	7694086	\$589.63
8	769408	\$755.27
10x4	76940104	\$966.23
10x6	76940106	\$1,020.85
10x8	76940108	\$1,434.15
10	7694010	\$1,620.14
12x4	76940124	\$1,221.62
12x6	76940126	\$1,303.81
12x8	76940128	\$1,786.29
12x10	769401210	\$2,125.85
12	7694012	\$2,193.56

PVC FITTINGS

SDR35-SDR26 SEWER/HWS & PROFILE FITTINGS



Specified Fittings



ForkFloor
2400



**Specified
Fittings**

ADAPTER

FEMALE X FIPT

§ Available in Larger, Reducing Sizes. § Available with Countersunk Plug.
 § Available with Dissimilar Outlet. § O-Ring Style Available—Please Contact Factory.

Size	Part Number	SDR35		SDR26/35 HWS		Profile: (23)
		SW: (81)	GSK: (79)	SW: (82)	GSK: (80)	
3	1303	CF	CF	CF	CF	CF
4	1304	\$13.32	CF	\$18.64	CF	\$24.79
6	1306	\$62.67	CF	\$88.00	CF	\$117.04
8	1308	\$197.66	CF	\$395.32	CF	\$525.77
10	13010	\$759.18	CF	\$1,538.48	CF	\$2,046.18
12	13012	\$1,101.43	CF	\$1,999.77	CF	\$2,659.69
15x16	13015-16IPS	\$2,220.61	CF	\$2,953.41	CF	\$3,928.03
18	13018	\$3,552.97	CF	\$4,725.44	CF	\$6,284.84
21x20	13021-20IPS	\$4,725.49	CF	\$6,284.90	CF	\$8,358.92
24	13024	\$5,464.95	CF	\$7,268.38	CF	\$9,666.94

FEMALE X MIPT

§ Available in Larger, Reducing Sizes. § Available with Countersunk Plug.
 § Available with Dissimilar Outlet. § O-Ring Style Available—Please Contact Factory.

Size	Part Number	SDR35		SDR26/35 HWS		Profile: (23)
		SW: (81)	GSK: (79)	SW: (82)	GSK: (80)	
4	1504	\$39.79	CF	\$55.91	CF	\$55.91
6	1506	\$186.86	CF	\$249.15	CF	\$249.15
8	1508	\$395.32	CF	\$527.08	CF	\$527.08
10	15010	\$1,156.75	CF	\$1,538.48	CF	\$1,538.48
12	15012	\$1,503.59	CF	\$1,999.77	CF	\$1,999.77

SLIP BELL X GASKET

§ Available in Smaller and Larger Sizes. § Available in Reducing Sizes.

Size	Part Number	SDR35		SDR26/35 HWS		Profile: (23)
		SW: (81)	GSK: (79)	SW: (82)	GSK: (80)	
4	1354	CF	\$48.68	CF	\$68.15	\$68.15
6X4	13564	CF	\$68.93	CF	\$96.50	\$96.50
6	1356	CF	\$89.18	CF	\$124.85	\$124.85
8	1358	CF	\$195.10	CF	\$273.13	\$273.13

SEWER X IPS

FEMALE X FEMALE

§ Available with Dissimilar Outlet. § Available with Stop.



Size	PartNumber	SDR35		SDR26/35 HWS		Profile: (23)
		SW: (81)	GSK: (79)	SW: (82)	GSK: (80)	
4x3	1054-3IPS	\$12.71	CF	\$66.13	CF	CF
4	1054	\$16.32	\$63.27	\$81.92	\$69.59	\$69.59
6x4	10564	\$64.99	\$78.38	\$131.01	\$86.22	\$86.22
6	1056	\$53.63	\$125.36	\$242.64	\$137.90	\$137.90
8	1058	\$149.47	\$232.19	\$363.69	\$255.41	\$255.41
10	10510	\$187.37	\$348.04	\$535.32	\$382.83	\$382.83
12	10512	\$257.94	\$512.26	\$1,779.41	\$563.50	\$563.50
15x14	10515-14IPS	\$1,500.36	\$1,702.77	\$2,224.30	\$1,873.06	\$1,873.06
15x16	10515-16IPS	\$1,875.41	\$2,128.51	\$3,608.31	\$2,341.37	\$2,341.37
18	10518	\$2,995.71	\$3,452.91	\$4,164.16	\$3,798.22	\$3,798.22
21x20	10521-20IPS	\$3,750.68	\$3,984.85	\$3,891.73	\$4,383.32	\$4,383.32

MALE X FEMALE

§ Available in Smaller and Larger Sizes. § Available in Reducing Sizes.

Size	Part Number	SDR35		SDR26/35 HWS		Profile: (23)
		SW: (81)	GSK: (79)	SW: (82)	GSK: (80)	
3x1.5	1713-1.5IPS	\$21.74	CF	CF	CF	CF
3x2	1713-2IPS	\$26.46	CF	CF	CF	CF
4x1.5	1714-1.5IPS	\$27.89	CF	CF	CF	CF
4x2	1714-2IPS	\$27.42	CF	CF	CF	CF
4x3	1714-3IPS	\$50.67	CF	CF	CF	CF
4	1714	\$32.45	\$56.42	CF	\$56.42	\$69.59
6x4	17164	\$55.99	CF	CF	CF	\$86.22
6	1716	\$74.07	\$117.38	CF	\$117.38	\$137.90
8	1718	\$140.45	\$207.32	CF	\$207.32	\$255.41
10	17110	\$181.95	\$310.71	CF	\$310.71	\$382.83
12	17112	\$250.24	\$457.39	CF	\$457.39	\$563.50
15x14	17115-14IPS	\$1,500.36	\$1,702.77	\$1,779.41	\$1,873.06	\$1,873.06
15x16	17115-16IPS	\$1,875.41	\$2,128.51	\$2,224.30	\$2,341.37	\$2,341.37
15	17115	\$2,995.71	\$3,452.91	\$3,608.31	\$3,798.22	\$3,798.22
18	17118	\$3,750.68	\$3,984.85	\$4,164.16	\$4,383.32	\$4,383.32

FEMALE X MALE

§ Available in Smaller and Larger Sizes. § Available in Reducing Sizes.

Size	Part Number	SDR35		SDR26/35 HWS		Profile: (23)
		SW: (81)	GSK: (79)	SW: (82)	GSK: (80)	
4	1344	\$12.74	\$76.00	\$19.10	\$114.01	\$114.01
6	1346	\$54.92	\$106.05	\$82.38	\$159.07	\$159.07
8	1348	\$149.47	\$207.32	\$224.21	\$310.98	\$310.98
10	13410	\$187.37	\$310.71	\$281.06	\$466.06	\$466.06
12	13412	\$291.72	\$457.39	\$437.58	\$686.09	\$686.09

IPS X SEWER

MALE X FEMALE

SLEEVE

§ Available in Smaller and Larger Sizes.

Size	PartNumber	SDR35		SDR26/35 HWS		Profile: (23)
		SW: (81)	GSK: (79)	SW: (82)	GSK: (80)	
4	736604-SWR	\$14.09	\$62.04	\$19.73	\$86.85	\$86.85
6	736606-SWR	\$12.74	\$106.06	\$17.83	\$148.48	\$148.48
8	736608-SWR	\$54.92	\$259.30	\$76.89	\$363.02	\$363.02
10	7366010-SWR	\$234.18	\$430.47	\$327.85	\$602.65	\$602.65
12	7366012-SWR	\$371.80	\$608.72	\$520.52	\$852.21	\$852.21

SEWER & PROFILE FITTINGS

ADAPTER

DOWNSPOUT

SHAPE X FEMALE

§ Available in Smaller/Larger Sizes, or Dissimilar Outlet. § Note Last Size is Pipe Dimension.

Size	Part Number	SDR35		SDR26/35 HWS		Profile: (23)
		SW: (81)	GSK: (79)	SW: (82)	GSK: (80)	
2x3x3	122233	\$11.86	CF	\$15.77	CF	CF
2x3x4	122234	\$13.81	CF	\$18.37	CF	CF
2x3x6	122236	\$120.28	CF	\$159.97	CF	CF
3x4x3	122343	\$19.75	CF	\$26.27	CF	CF
3x4x4	122344	\$21.79	CF	\$28.98	CF	CF
3x4x6	122346	\$243.58	CF	\$323.96	CF	CF
4x4x4	122444	\$120.28	CF	\$159.97	CF	CF
4x4x6	122446	\$282.05	CF	\$375.13	CF	CF
4x5x4	122454	\$159.27	CF	\$211.82	CF	CF
4x5x6	122456	\$325.45	CF	\$432.85	CF	CF
4x6x6	122466	\$214.53	CF	\$285.32	CF	CF
6x6x6	122666	\$214.53	CF	\$285.32	CF	CF
8x8x8	122888	\$664.41	CF	\$883.66	CF	CF

SHAPE X MALE

§ Available in Smaller/Larger Sizes, or Dissimilar Outlet. § Note Last Size is Pipe Dimension.

Size	Part Number	SDR35		SDR26/35 HWS		Profile: (23)
		SW: (81)	GSK: (79)	SW: (82)	GSK: (80)	
3x4x6	121346	\$311.93	CF	\$414.86	CF	CF
4x4x4	121444	\$122.92	CF	\$163.47	CF	CF
4x4x6	121446	\$258.27	CF	\$343.51	CF	CF
4x5x4	121454	\$167.90	CF	\$223.31	CF	CF
4x5x6	121456	\$329.49	CF	\$438.22	CF	CF
4x6x6	121466	\$285.32	CF	\$379.47	CF	CF
5x5x4	121554	\$139.48	CF	\$185.51	CF	CF
5x5x6	121556	\$256.96	CF	\$341.74	CF	CF
6x6x6	121666	\$285.32	CF	\$379.48	CF	CF
6x8x8	121688	CF	CF	CF	CF	CF
8x8x8	121888	\$317.37	CF	\$504.71	CF	CF

SHAPE X FEMALE

FLUSHMOUNT

§ Available in Smaller/Larger Sizes, or Dissimilar Outlet. § Note Last Size is Pipe Dimension.

Size	Part Number	SDR35		SDR26/35 HWS		Profile: (23)
		SW: (81)	GSK: (79)	SW: (82)	GSK: (80)	
2x3x3	120233	\$9.81	CF	CF	CF	CF
2x3x4	120234	\$10.39	CF	CF	CF	CF
3x4x4	120344	\$18.62	CF	CF	CF	CF
4x6x6	120466	\$59.74	CF	CF	CF	CF

SEWER/PROFILE X NO HUB CAST IRON

FEMALE X FEMALE



§ Available in Smaller, Larger, Reducing Sizes. § O-Ring Style Available: Contact Factory.

Size	Part Number	SDR35		SDR26/35 HWS		Profile: (23)
		SW: (81)	GSK: (79)	SW: (82)	GSK: (80)	
4	1054-NHC	\$59.43	CF	\$83.21	CF	CF
6	1056-NHC	\$63.49	CF	\$88.89	CF	CF
8	1058-NHC	\$147.00	CF	\$205.80	CF	CF
10	10510-NHC	\$389.30	CF	\$545.02	CF	CF
12	10512-NHC	\$488.22	CF	\$683.50	CF	CF

FEMALE X MALE

§ Available in Smaller, Larger, Reducing Sizes. § O-Ring Style Available: Contact Factory.

Size	Part Number	SDR35		SDR26/35 HWS		Profile: (23)
		SW: (81)	GSK: (79)	SW: (82)	GSK: (80)	
4	1344-NHC	\$59.43	CF	\$83.21	CF	CF
6	1346-NHC	\$63.49	CF	\$88.89	CF	CF
8	1348-NHC	\$147.00	CF	\$205.80	CF	CF
10	13410-NHC	\$389.30	CF	\$545.02	CF	CF
12	13412-NHC	\$488.22	CF	\$683.50	CF	CF

MALE X FEMALE

§ Available in Smaller, Larger, Reducing Sizes. § O-Ring Style Available: Contact Factory.

Size	Part Number	SDR35		SDR26/35 HWS		Profile: (23)
		SW: (81)	GSK: (79)	SW: (82)	GSK: (80)	
4	1714-NHC	\$59.43	CF	\$83.21	CF	CF
6	1716-NHC	\$63.49	CF	\$88.89	CF	CF
8	1718-NHC	\$147.00	CF	\$205.80	CF	CF
10	17110-NHC	\$389.30	CF	\$545.02	CF	CF
12	17112-NHC	\$488.22	CF	\$683.50	CF	CF

SEWER/PROFILE X SERVICE WEIGHT CAST IRON

FEMALE X FEMALE



§ Available in Smaller, Larger, Reducing Sizes. § O-Ring Style Available: Contact Factory.

Size	Part Number	SDR35		SDR26/35 HWS		Profile: (23)
		SW: (81)	GSK: (79)	SW: (82)	GSK: (80)	
4	1054-SWC	\$59.43	CF	\$83.21	CF	CF
6	1056-SWC	\$63.49	CF	\$88.89	CF	CF
8	1058-SWC	\$147.00	CF	\$205.80	CF	CF
10	10510-SWC	\$389.30	CF	\$545.02	CF	CF
12	10512-SWC	\$488.22	CF	\$683.50	CF	CF

FEMALE X MALE

§ Available in Smaller, Larger, Reducing Sizes. § O-Ring Style Available: Contact Factory.

Size	Part Number	SDR35		SDR26/35 HWS		Profile: (23)
		SW: (81)	GSK: (79)	SW: (82)	GSK: (80)	
4	1344-SWC	\$59.43	CF	\$83.21	CF	CF
6	1346-SWC	\$63.49	CF	\$88.89	CF	CF
8	1348-SWC	\$147.00	CF	\$205.80	CF	CF
10	13410-SWC	\$389.30	CF	\$545.02	CF	CF
12	13412-SWC	\$488.22	CF	\$683.50	CF	CF

ADAPTER

SEWER/PROFILE X SERVICE WEIGHT CAST IRON

MALE X FEMALE



§ Available in Smaller, Larger, Reducing Sizes. § O-Ring Style Available: Contact Factory.

Size	Part Number	SDR35		SDR26/35 HWS		Profile: (23)
		SW: (81)	GSK: (79)	SW: (82)	GSK: (80)	
4	1714-SWC	\$59.43	CF	\$83.21	CF	CF
6	1716-SWC	\$63.49	CF	\$88.89	CF	CF
8	1718-SWC	\$147.00	CF	\$205.80	CF	CF
10	17110-SWC	\$389.30	CF	\$545.02	CF	CF
12	17112-SWC	\$488.22	CF	\$683.50	CF	CF

SEWER/PROFILE X EXTRA HEAVY CAST IRON

FEMALE X FEMALE



§ Available in Smaller, Larger, Reducing Sizes. § O-Ring Style Available: Contact Factory.

Size	Part Number	SDR35		SDR26/35 HWS		Profile: (23)
		SW: (81)	GSK: (79)	SW: (82)	GSK: (80)	
4	1054-XHC	\$59.43	CF	\$83.21	CF	CF
6	1056-XHC	\$63.49	CF	\$88.89	CF	CF
8	1058-XHC	\$147.00	CF	\$205.80	CF	CF
10	10510-XHC	\$389.30	CF	\$545.02	CF	CF
12	10512-XHC	\$488.22	CF	\$683.50	CF	CF

FEMALE X MALE

§ Available in Smaller, Larger, Reducing Sizes. § O-Ring Style Available: Contact Factory.

Size	Part Number	SDR35		SDR26/35 HWS		Profile: (23)
		SW: (81)	GSK: (79)	SW: (82)	GSK: (80)	
4	1344-XHC	\$59.43	CF	\$83.21	CF	CF
6	1346-XHC	\$63.49	CF	\$88.89	CF	CF
8	1348-XHC	\$147.00	CF	\$205.80	CF	CF
10	13410-XHC	\$389.30	CF	\$545.02	CF	CF
12	13412-XHC	\$488.22	CF	\$683.50	CF	CF

MALE X FEMALE



§ Available in Smaller, Larger, Reducing Sizes. § O-Ring Style Available: Contact Factory.

Size	Part Number	SDR35		SDR26/35 HWS		Profile: (23)
		SW: (81)	GSK: (79)	SW: (82)	GSK: (80)	
4	1714-XHC	\$59.43	CF	\$83.21	CF	CF
6	1716-XHC	\$63.49	CF	\$88.89	CF	CF
8	1718-XHC	\$147.00	CF	\$205.80	CF	CF
10	17110-XHC	\$389.30	CF	\$545.02	CF	CF
12	17112-XHC	\$488.22	CF	\$683.50	CF	CF

FEMALE X MALE



Size	Part Number	SDR35		SDR26/35 HWS		Profile: (23)
		SW: (81)	GSK: (79)	SW: (82)	GSK: (80)	
4	1714	\$30.85	\$38.57	CF	\$51.95	\$30.85
6	1716	\$57.72	\$72.14	CF	\$86.62	\$57.72
8	1718	\$133.63	\$167.05	CF	\$183.75	\$133.63
10	17110	\$138.30	\$172.92	CF	\$218.08	\$138.30
12	17112	\$210.42	\$263.10	CF	\$326.54	\$210.42
15	17115	\$318.11	\$397.72	CF	\$493.10	\$318.11
18	17118	\$699.17	\$874.11	CF	\$1,094.40	\$699.17
21	17121	\$769.19	\$961.56	CF	\$1,298.19	\$769.19
24	17124	\$1,390.45	\$1,738.32	CF	\$2,346.69	\$1,390.45
27	17127	\$1,620.36	\$2,155.07	CF	\$2,531.82	\$1,620.36
30	17130	\$2,074.06	\$2,758.50	CF	\$3,240.72	\$2,074.06
36	17136	\$2,654.79	CF	CF	\$4,148.12	\$2,654.79

ADAPTER

CLEANOUT

MALE X FIPT



§ Available in Larger Sizes. § O-Ring Style Available—Please Contact Factory.

Size	Part Number	SDR35		SDR26/35 HWS		Profile: (23)
		SW: (81)	GSK: (79)	SW: (82)	GSK: (80)	
3	1103	CF	CF	CF	CF	CF
4	1104	\$10.43	CF	\$19.32	CF	CF
6	1106	\$65.14	CF	\$91.20	CF	CF
8	1108	\$273.96	CF	\$364.36	CF	CF
10	11010	\$1,183.58	CF	\$1,574.17	CF	CF
12	11012	\$1,503.59	CF	\$1,999.77	CF	CF
15x14	11015-14IPS	\$1,862.10	CF	\$2,476.59	CF	CF
15x16	11015-16IPS	\$2,220.61	CF	\$2,953.41	CF	CF
18	11018	\$3,552.97	CF	\$4,725.45	CF	CF
21x20	11021-20IPS	\$4,725.49	CF	\$6,284.90	CF	CF
24	11024	\$6,284.84	CF	\$8,358.84	CF	CF

ADAPTER

SANDED MANHOLE

FEMALE X FEMALE



§ Available with Dissimilar Outlet. § Available with Stop.

Size	Part Number	SDR35		SDR26/35 HWS		Profile: (23)
		SW: (81)	GSK: (79)	SW: (82)	GSK: (80)	
4	1664	CF	\$65.02	CF	\$86.48	\$86.48
6	1666	CF	\$128.04	CF	\$170.29	\$170.29
8	1668	CF	\$180.96	CF	\$240.68	\$240.68
10	16610	CF	\$369.73	CF	\$491.74	\$491.74
12	16612	CF	\$757.94	CF	\$1,008.06	\$1,008.06
15	16615	CF	\$997.76	CF	\$1,327.01	\$1,327.01
18	16618	CF	\$1,030.40	CF	\$1,370.43	\$1,370.43
21	16621	CF	\$1,406.84	CF	\$1,871.10	\$1,871.10
24	16624	CF	\$2,342.81	CF	\$3,115.94	\$3,115.94
27	16627	CF	\$2,720.85	CF	\$3,618.73	\$3,618.73
30	16630	CF	\$3,862.65	CF	\$5,137.32	\$5,137.32
36	16636	CF	\$5,322.22	CF	\$7,078.56	\$7,078.56

SEWER & PROFILE FITTINGS

ADAPTER

SANDED MANHOLE

FEMALE X MALE

NONSTOP

§ Available with Dissimilar Outlet. § Available with Stop.

Size	Part Number	SDR35		SDR26/35 HWS		Profile: (23)
		SW: (81)	GSK: (79)	SW: (82)	GSK: (80)	
4	1644	CF	\$55.12	CF	\$55.12	CF
6	1646	CF	\$103.91	CF	\$103.91	CF
8	1648	CF	\$115.98	CF	\$126.61	\$103.57
10	16410	CF	\$210.87	CF	\$236.95	\$188.26
12	16412	CF	\$309.19	CF	\$347.42	\$276.08
15	16415	CF	\$395.73	CF	\$444.57	\$353.33
18	16418	CF	\$795.99	CF	\$964.29	\$710.69
21	16421	CF	\$1,125.47	CF	\$1,519.37	\$1,004.92
24	16424	CF	\$1,874.25	CF	\$2,530.18	\$1,673.45
27	16427	CF	\$2,176.68	CF	\$2,938.50	\$1,943.45
30	16430	CF	\$3,090.11	CF	\$3,761.28	\$2,759.03
36	16436	CF	\$3,475.65	CF	\$4,814.44	\$4,775.89

CAP

FEMALE

§ Available Tapped Concentrically and Eccentrically. § Available in Flat Style.

Size	Part Number	SDR35		SDR26/35 HWS		Profile: (23)
		SW: (81)	GSK: (79)	SW: (82)	GSK: (80)	
3	1903	\$5.11	CF	CF	CF	NA
4	1904	\$5.86	\$17.89	\$46.63	\$48.24	NA
6	1906	\$21.44	\$33.55	\$53.48	\$110.89	NA
8	1908	\$70.19	\$90.58	\$155.53	\$165.20	\$80.90
10	19010	\$231.18	\$283.35	\$247.60	\$318.26	\$253.00
12	19012	\$292.67	\$425.64	\$313.30	\$500.68	\$380.05
15	19015	\$504.83	\$688.36	\$522.67	\$833.01	\$614.61
18	19018	\$890.80	\$1,000.73	\$902.86	\$1,252.98	\$893.52
21	19021	\$1,954.77	\$2,170.65	\$2,585.19	\$2,930.49	\$1,938.12
24	19024	\$2,231.11	\$2,506.85	\$2,900.45	\$3,384.63	\$2,238.25
27	19027	\$2,441.80	\$3,161.73	\$3,418.52	\$5,282.63	\$2,822.99
30	19030	\$3,486.21	\$4,062.99	\$4,880.69	\$6,788.41	\$3,627.69
36	19036	\$4,357.74	\$6,950.52	\$6,100.83	\$8,689.15	\$7,267.03

PLUG

SQUARE HEAD

MIPT

§ Available in Smaller and Larger Sizes, and Tapped Concentrically and Eccentrically.

Size	Part Number	SDR35		SDR26/35 HWS		Profile: (23)
		SW: (81)	GSK: (79)	SW: (82)	GSK: (80)	
3	5703	\$13.22	NA	CF	NA	CF
4	5704	\$7.44	NA	\$157.46	NA	CF
6	5706	\$35.08	NA	\$174.95	NA	CF
8	5708	\$138.85	NA	\$194.39	NA	CF
10	57010	\$273.28	NA	\$382.59	NA	CF
12	57012	\$334.18	NA	\$467.85	NA	CF

COUNTERSUNK

MIPT

§ Available in Smaller and Larger Sizes, and Tapped Concentrically and Eccentrically.

Size	Part Number	SDR35		SDR26/35 HWS		Profile: (23)
		SW: (81)	GSK: (79)	SW: (82)	GSK: (80)	
4	5504	\$18.66	NA	\$157.46	NA	CF
6	5506	\$48.01	NA	\$182.30	NA	CF
8	5508	\$190.13	NA	\$194.39	NA	CF
10	55010	\$421.28	NA	\$429.89	NA	CF
12	55012	\$608.96	NA	\$621.40	NA	CF

PLUG

MALE

§ Available Tapped Concentrically and Eccentrically.

Size	Part Number	SDR35		SDR26/35 HWS		Profile: (23)
		SW: (81)	GSK: (79)	SW: (82)	GSK: (80)	
4	5604	NA	\$13.53	NA	\$43.15	\$65.62
6	5606	NA	\$20.72	NA	\$86.91	\$218.60
8	5608	NA	\$73.48	NA	\$153.75	\$65.62
10	56010	NA	\$244.82	NA	\$295.01	\$218.60
12	56012	NA	\$292.60	NA	\$351.70	\$261.26
15	56015	NA	\$575.82	NA	\$646.99	\$514.12
18	56018	NA	\$810.75	NA	\$1,015.12	\$723.88
21	56021	NA	\$1,603.66	NA	\$2,164.98	\$1,431.85
24	56024	NA	\$2,411.37	NA	\$3,255.30	\$2,153.01
27	56027	NA	\$2,948.51	NA	CF	\$2,632.61
30	56030	NA	\$3,774.64	NA	CF	\$3,380.82
36	56036	NA	\$6,746.53	NA	CF	\$7,185.90

COUPLING

INTERNAL

§ Available in Smaller and Larger Sizes.

Size	Part Number	SDR35		SDR26/35 HWS		Profile: (23)
		SW: (81)	GSK: (79)	SW: (82)	GSK: (80)	
4	2154	\$71.26	\$71.26	\$71.26	\$71.26	\$71.26
6	2156	\$90.66	\$90.66	\$90.66	\$90.66	\$90.66
8	2158	\$125.73	\$125.73	\$125.73	\$125.73	\$125.73
10	21510	\$390.05	\$390.05	\$390.05	\$390.05	\$390.05
12	21512	\$567.36	\$567.36	\$567.36	\$567.36	\$1,133.39
15	21515	\$1,259.09	\$1,259.09	\$1,259.09	\$1,259.09	\$1,259.09
18	21518	\$1,534.18	\$1,534.18	\$1,534.18	\$1,534.18	\$1,534.18
21	21521	\$2,835.51	\$2,835.51	\$2,835.51	\$2,835.51	\$2,835.51
24	21524	\$4,040.73	\$4,040.73	\$4,040.73	\$4,040.73	\$4,040.73
27	21527	\$4,611.23	\$4,611.23	\$4,611.23	\$4,611.23	\$4,611.23

REPAIR

FEMALE X FEMALE



Size	Part Number	SDR35		SDR26/35 HWS		Profile: (23)
		SW: (81)	GSK: (79)	SW: (82)	GSK: (80)	
4	2204	CF	\$34.27	CF	\$58.73	\$56.60
6	2206	CF	\$68.42	CF	\$84.95	\$77.98
8	2208	CF	\$116.22	CF	\$143.88	\$103.72
10	22010	CF	\$257.94	CF	\$295.61	\$230.29
12	22012	CF	\$374.80	CF	\$429.14	\$334.62
15	22015	CF	\$775.43	CF	\$887.78	\$692.38
18	22018	CF	\$1,509.47	CF	\$1,889.59	\$1,347.73
21	22021	CF	\$2,572.42	CF	\$3,472.81	\$2,296.79
24	22024	CF	\$3,747.56	CF	\$5,059.23	\$3,346.02
27	22027	CF	\$4,226.11	CF	\$5,282.63	\$3,773.33
30	22030	CF	\$5,430.73	CF	\$6,788.41	\$4,848.91
36	22036	CF	\$6,951.32	CF	\$8,689.15	\$6,083.86

RISER

FEMALE X FEMALE

DEEP SOCKET

§ Available in Larger Sizes.

Size	Part Number	SDR35		SDR26/35 HWS		Profile: (23)
		SW: (81)	GSK: (79)	SW: (82)	GSK: (80)	
4	2444	CF	\$203.49	CF	\$203.49	CF
6	2446	CF	\$276.35	CF	\$276.35	CF
8	2448	CF	\$473.31	CF	\$473.31	CF

FEMALE X MALE

DEEP SOCKET

§ Available in Larger Sizes.

Size	Part Number	SDR35		SDR26/35 HWS		Profile: (23)
		SW: (81)	GSK: (79)	SW: (82)	GSK: (80)	
4	2464	CF	\$197.37	CF	\$197.37	CF
6	2466	CF	\$268.11	CF	\$268.11	CF
8	2468	CF	\$459.12	CF	\$459.12	CF

MALE X MALE

DEEP SOCKET

§ Available in Larger Sizes.

Size	Part Number	SDR35		SDR26/35 HWS		Profile: (23)
		SW: (81)	GSK: (79)	SW: (82)	GSK: (80)	
4	2434	CF	\$197.37	CF	\$197.37	CF
6	2436	CF	\$268.11	CF	\$268.11	CF
8	2438	CF	\$459.12	CF	\$459.12	CF

STARTER

FEMALE (GASKET) X FEMALE (SLIP BELL)

Size	Part Number	SDR35		SDR26/35 HWS		Profile: (23)
		SW: (81)	GSK: (79)	SW: (82)	GSK: (80)	
4	2254	CF	\$34.39	CF	\$48.68	\$34.39
6x4	22564	CF	\$59.09	CF	\$68.93	\$59.09
6	2256	CF	\$75.35	CF	\$89.18	\$75.35
8	2258	CF	\$174.15	CF	\$195.10	\$174.15
10	22510	CF	\$258.79	CF	\$295.54	\$258.79
12	22512	CF	\$374.80	CF	\$429.14	\$374.80
15	22515	CF	\$775.43	CF	\$887.78	\$775.43
18	22518	CF	\$1,509.47	CF	\$1,889.56	\$1,509.47
21	22521	CF	\$2,572.49	CF	\$3,472.74	\$2,572.49
24	22524	CF	\$3,747.56	CF	\$5,059.23	\$3,747.56
27	22527	CF	\$4,226.11	CF	\$5,678.84	\$4,226.11

STOP

FEMALE X FEMALE

§ Available in Reducing Sizes. § Available in Tapped Style.



Size	Part Number	SDR35		SDR26/35 HWS		Profile: (23)
		SW: (81)	GSK: (79)	SW: (82)	GSK: (80)	
4	2404	\$6.69	\$34.27	\$54.76	\$58.73	CF
6	2406	\$24.48	\$68.42	\$88.43	\$84.95	CF
8	2408	\$76.15	\$116.22	\$197.33	\$201.32	\$103.72
10	24010	\$215.67	\$257.94	\$287.61	\$295.61	\$230.29
12	24012	\$367.17	\$374.80	\$421.13	\$429.14	\$334.62
15	24015	\$643.02	\$775.43	\$879.77	\$887.78	\$692.38
18	24018	\$1,337.20	\$1,509.47	\$1,881.60	\$1,889.59	\$1,347.73
21	24021	\$2,333.30	\$2,572.48	\$3,464.73	\$3,472.74	\$2,296.86
24	24024	\$3,355.50	\$3,747.56	\$5,051.22	\$5,059.23	\$3,346.02
27	24027	\$4,194.35	\$4,226.11	CF	\$5,282.63	\$3,773.33
30	24030	\$5,242.94	\$5,430.73	CF	\$6,788.41	\$4,848.91
36	24036	\$6,553.67	\$6,951.32	CF	\$8,689.15	\$6,083.86

CROSS

INSIDE DROP MANHOLE

MALE X CAP X MALE X MALE

Size	Part Number	SDR35		SDR26/35 HWS		Profile: (23)
		SW: (81)	GSK: (79)	SW: (82)	GSK: (80)	
4x3	27043	\$122.02	CF	\$170.83	CF	\$122.02
6x4	27064	\$152.36	CF	\$213.31	CF	\$152.36
6	2706	\$181.51	CF	\$254.12	CF	\$181.51
8x4	27084	\$267.60	CF	\$374.65	CF	\$267.60
8x6	27086	\$281.44	CF	\$394.02	CF	\$281.44
8	2708	\$340.20	CF	\$476.28	CF	\$340.20
10x4	270104	\$526.35	CF	\$736.89	CF	\$526.35
10x6	270106	\$598.41	CF	\$837.77	CF	\$598.41
10x8	270108	\$822.92	CF	\$1,152.09	CF	\$822.92
10	27010	\$936.23	CF	\$1,310.72	CF	\$936.23
12x4	270124	\$631.66	CF	\$884.33	CF	\$631.66
12x6	270126	\$747.84	CF	\$1,046.97	CF	\$747.84
12x8	270128	\$945.92	CF	\$1,324.29	CF	\$945.92
12x10	2701210	\$1,201.31	CF	\$1,681.84	CF	\$1,201.31
12	27012	\$1,332.60	CF	\$1,865.65	CF	\$1,332.60

FEMALE X FEMALE X FEMALE X FEMALE

§ Available in Smaller and Larger Sizes. § Available with Threaded Outlets.



Size	Part Number	SDR35		SDR26/35 HWS		Profile: (23)
		SW: (81)	GSK: (79)	SW: (82)	GSK: (80)	
4	2604	\$39.17	\$171.66	\$149.43	\$197.42	\$39.17
6x4	26064	\$139.27	\$176.64	\$153.34	\$212.76	\$139.27
6	2606	\$168.41	\$224.35	\$211.96	\$288.28	\$168.41
8x4	26084	\$254.50	\$289.44	\$259.85	\$357.55	\$254.50
8x6	26086	\$268.35	\$364.23	\$322.06	\$443.51	\$268.35
8	2608	\$327.09	\$542.48	\$479.48	\$652.53	\$327.09
10x4	260104	\$505.76	\$733.31	\$833.07	\$841.08	\$505.76
10x6	260106	\$577.82	\$761.57	\$875.35	\$883.33	\$577.82
10x8	260108	\$802.35	\$1,048.50	\$1,188.38	\$1,196.39	\$802.35
10	26010	\$915.64	\$1,247.97	\$1,444.00	\$1,452.01	\$915.64
12x4	260124	\$603.60	\$797.39	\$932.46	\$940.47	\$603.60
12x6	260126	\$719.78	\$936.58	\$1,083.16	\$1,091.18	\$719.78
12x8	260128	\$917.85	\$1,088.15	\$1,256.15	\$1,264.19	\$917.85
12x10	2601210	\$1,173.24	\$1,263.22	\$1,475.10	\$1,483.06	\$1,173.24
12	26012	\$1,304.54	\$1,470.45	\$1,728.95	\$1,736.93	\$1,304.54
15x4	260154	\$1,273.75	\$1,370.87	\$1,546.65	\$1,554.66	\$1,273.75
15x6	260156	\$1,479.43	\$1,583.94	\$1,787.06	\$1,795.08	\$1,479.43
15x8	260158	\$1,548.71	\$1,664.96	\$1,889.73	\$1,897.67	\$1,548.71
15x10	2601510	\$1,590.33	\$1,709.58	\$1,972.52	\$1,980.51	\$1,590.33
15x12	2601512	\$1,701.17	\$1,828.02	\$2,132.16	\$2,140.16	\$1,701.17
15	26015	\$2,043.10	\$2,194.05	\$2,569.86	\$2,577.87	\$2,043.10
18x4	260184	\$2,566.63	\$2,754.30	\$3,440.06	\$3,448.08	\$2,566.63
18x6	260186	\$2,864.04	\$3,143.73	\$3,927.74	\$3,935.76	\$2,864.04
18x8	260188	\$2,995.90	\$3,284.64	\$4,104.04	\$4,112.07	\$2,995.90
18x10	2601810	\$3,616.90	\$3,991.79	\$4,989.21	\$4,997.24	\$3,616.90
18x12	2601812	\$3,822.90	\$4,373.02	\$5,466.62	\$5,474.59	\$3,822.90
18x15	2601815	\$4,419.12	\$4,980.12	\$6,226.74	\$6,234.75	\$4,419.12
18	26018	\$5,917.57	\$6,759.52	\$8,454.35	\$8,462.32	\$5,917.57
21x4	260214	\$3,031.68	\$3,614.85	CF	\$5,318.57	\$3,031.68
21x6	260216	\$3,307.95	\$3,942.89	CF	\$5,808.78	\$3,307.95
21x8	260218	\$3,787.83	\$4,517.03	CF	\$6,650.29	\$3,787.83
21x10	2602110	\$4,165.90	\$5,164.91	CF	\$7,312.03	\$4,165.90
21x12	2602112	\$4,580.27	\$5,684.29	CF	\$8,047.31	\$4,580.27
21x15	2602115	\$5,038.30	\$6,240.59	CF	\$8,847.98	\$5,038.30
21x18	2602118	\$5,539.95	\$6,874.58	CF	\$9,730.31	\$5,539.95
21	26021	\$6,928.58	\$8,591.39	CF	\$12,164.93	\$6,928.58
24x4	260244	\$4,689.35	\$5,588.02	CF	\$8,235.21	\$4,689.35
24x6	260246	\$5,241.90	\$6,246.07	CF	\$9,199.26	\$5,241.90
24x8	260248	\$5,365.48	\$6,401.73	CF	\$9,428.04	\$5,365.48
24x10	2602410	\$6,441.49	\$7,992.65	CF	\$11,315.24	\$6,441.49
24x12	2602412	\$7,728.33	\$9,586.84	CF	\$13,570.17	\$7,728.33
24x15	2602415	\$9,276.86	\$11,505.68	CF	\$16,290.73	\$9,276.86
24x18	2602418	\$11,130.84	\$13,806.79	CF	\$19,550.51	\$11,130.84
24x21	2602421	\$13,362.78	\$16,569.59	CF	\$23,455.69	\$13,362.78
24	26024	\$16,699.84	\$20,710.19	CF	\$29,321.63	\$16,699.84
27x4	260274	\$5,325.01	\$6,657.31	CF	\$8,852.86	\$5,325.01
27x6	260276	\$5,546.09	\$6,933.54	CF	\$9,220.40	\$5,546.09
27x8	260278	\$5,664.45	\$7,081.56	CF	\$9,417.14	\$5,664.45
27x10	2602710	\$6,147.23	\$8,836.63	CF	\$11,752.74	\$6,147.23
27x12	2602712	\$7,831.80	\$11,258.24	CF	\$14,973.46	\$7,831.80
27x15	2602715	\$8,851.99	\$12,724.74	CF	\$16,923.90	\$8,851.99
27x18	2602718	\$10,623.41	\$15,271.16	CF	\$20,310.64	\$10,623.41
27x21	2602721	\$12,751.07	\$18,329.68	CF	\$24,378.47	\$12,751.07
27x24	2602724	\$15,300.33	\$21,994.23	CF	\$29,252.30	\$15,300.33
27	26027	\$19,124.09	\$27,490.87	CF	\$36,562.86	\$19,124.09

ELBOW

5 DEGREE

FEMALE X FEMALE

§ Available with Dissimilar Outlet.

Size	Part Number	SDR35		SDR26/35 HWS		Profile: (23)
		SW: (81)	GSK: (79)	SW: (82)	GSK: (80)	
4	3004	\$71.26	\$75.27	\$71.26	\$75.27	\$71.26
6	3006	\$90.66	\$103.89	\$90.66	\$103.89	\$90.66
8	3008	\$125.73	\$159.07	\$247.24	\$251.23	\$125.73
10	30010	\$390.05	\$435.14	\$517.31	\$525.35	\$390.05
12	30012	\$567.43	\$567.43	\$698.01	\$706.01	\$567.43
15	30015	\$1,247.77	\$1,500.80	\$1,678.08	\$1,686.09	\$1,247.77
18	30018	\$1,534.18	\$2,193.47	\$2,738.07	\$2,746.09	\$1,534.18
21	30021	\$2,835.51	\$3,112.61	\$4,194.08	\$4,202.11	\$2,835.51
24	30024	\$4,040.72	\$4,481.83	\$6,042.53	\$6,050.55	\$4,040.72
27	30027	\$4,611.23	\$5,346.42	\$6,755.19	\$7,110.72	\$4,611.23
30	30030	\$6,313.64	\$6,870.08	\$8,680.48	\$9,137.21	\$6,313.64
36	30036	\$7,892.06	\$8,792.02	\$11,110.83	\$11,695.61	\$7,892.06

11-1/4 DEGREE

FEMALE X FEMALE



Size	Part Number	SDR35		SDR26/35 HWS		Profile: (23)
		SW: (81)	GSK: (79)	SW: (82)	GSK: (80)	
4	3104	\$71.26	\$75.27	\$71.26	\$75.27	\$71.26
6	3106	\$90.66	\$103.89	\$90.66	\$103.89	\$90.66
8	3108	\$125.73	\$159.07	\$247.24	\$251.23	\$125.73
10	31010	\$390.05	\$435.14	\$517.31	\$525.35	\$390.05
12	31012	\$567.43	\$567.43	\$698.01	\$706.01	\$567.43
15	31015	\$1,247.77	\$1,500.80	\$1,678.08	\$1,686.09	\$1,247.77
18	31018	\$1,534.18	\$2,193.47	\$2,738.07	\$2,746.09	\$1,534.18
21	31021	\$2,835.51	\$3,112.61	\$4,194.08	\$4,202.11	\$2,835.51
24	31024	\$4,040.72	\$4,481.83	\$6,042.53	\$6,050.55	\$4,040.72
27	31027	\$4,611.23	\$5,346.42	\$6,755.19	\$7,110.72	\$4,611.23
30	31030	\$6,313.64	\$6,870.08	\$8,680.48	\$9,137.21	\$6,313.64
36	31036	\$7,892.06	\$8,792.02	\$11,110.83	\$11,695.61	\$7,892.06

22-1/2 DEGREE

FEMALE X FEMALE



Size	Part Number	SDR35		SDR26/35 HWS		Profile: (23)
		SW: (81)	GSK: (79)	SW: (82)	GSK: (80)	
4	3304	\$11.09	\$27.69	\$36.25	\$40.29	\$75.27
6	3306	\$46.40	\$54.57	\$90.66	\$103.89	\$103.89
8	3308	\$125.73	\$158.94	\$247.24	\$245.03	\$141.93
10	33010	\$390.05	\$435.14	\$517.31	\$525.35	\$388.49
12	33012	\$567.43	\$567.43	\$698.01	\$706.01	\$506.64
15	33015	\$1,247.77	\$1,500.80	\$1,678.08	\$1,686.09	\$1,339.98
18	33018	\$1,534.18	\$2,193.47	\$2,738.07	\$2,746.09	\$1,958.46
21	33021	\$2,835.51	\$3,112.68	\$4,194.08	\$4,202.11	\$2,779.18
24	33024	\$4,040.72	\$4,481.83	\$6,042.53	\$6,050.55	\$4,808.59
27	33027	\$4,611.23	\$5,346.42	\$6,755.19	\$7,110.72	\$5,225.02
30	33030	\$6,313.64	\$6,870.32	\$8,680.48	\$9,137.52	\$6,714.32
36	33036	\$7,892.06	\$8,792.02	\$11,110.83	\$11,695.61	\$9,623.87

30 DEGREE

FEMALE X FEMALE

§ Available with Dissimilar Outlet.

Size	Part Number	SDR35		SDR26/35 HWS		Profile: (23)
		SW: (81)	GSK: (79)	SW: (82)	GSK: (80)	
4	3404	\$71.26	\$75.27	\$71.26	\$75.27	\$75.27
6	3406	\$90.66	\$103.89	\$90.66	\$103.89	\$103.89
8	3408	\$125.73	\$159.07	\$247.24	\$251.23	\$146.22
10	34010	\$390.05	\$435.14	\$517.31	\$525.35	\$400.24
12	34012	\$567.43	\$567.43	\$698.01	\$706.01	\$580.28
15	34015	\$1,247.77	\$1,500.80	\$1,678.08	\$1,686.09	\$1,380.49
18	34018	\$1,534.18	\$2,193.47	\$2,738.07	\$2,746.09	\$2,079.71
21	34021	\$2,835.51	\$3,112.61	\$4,194.08	\$4,202.11	\$3,522.16
24	34024	\$4,040.72	\$4,481.83	\$6,042.53	\$6,050.55	\$4,808.59
27	34027	\$4,611.23	\$5,346.42	\$7,805.40	\$8,216.21	\$5,225.02
30	34030	\$6,313.64	\$6,870.08	\$10,030.26	\$10,558.17	\$6,714.32
36	34036	\$7,892.06	\$8,792.02	\$12,838.68	\$13,514.40	\$9,623.87

ELBOW

45 DEGREE

FEMALE X FEMALE

FABRICATED

§ Available in Larger Sizes. § Available with Dissimilar Outlet.

Size	Part Number	SDR35		SDR26/35 HWS		Profile: (23)
		SW: (81)	GSK: (79)	SW: (82)	GSK: (80)	
6	3496F	\$90.66	\$103.89	\$126.93	\$145.45	CF
8	3498F	\$162.44	\$200.28	\$227.41	\$280.39	CF
10	34910F	\$457.78	\$476.72	\$640.89	\$667.41	CF

ELBOW

45 DEGREE

FEMALE X FEMALE

§ Available with Dissimilar Outlet.



Size	Part Number	SDR35		SDR26/35 HWS		Profile: (23)
		SW: (81)	GSK: (79)	SW: (82)	GSK: (80)	
4	3504	\$9.81	\$27.74	\$38.93	\$41.19	\$75.27
6	3506	\$39.91	\$56.29	\$69.28	\$94.68	\$103.89
8	3508	\$108.66	\$157.55	\$232.28	\$236.26	\$140.64
10	35010	\$381.53	\$408.77	\$471.06	\$479.06	\$364.98
12	35012	\$592.52	\$593.74	\$736.09	\$744.12	\$530.12
15	35015	\$1,324.20	\$1,329.51	\$1,485.66	\$1,493.68	\$1,187.09
18	35018	\$1,534.18	\$2,127.93	\$2,655.94	\$2,663.96	\$1,899.94
21	35021	\$2,835.51	\$3,603.86	\$4,857.20	\$4,865.18	\$3,217.71
24	35024	\$4,040.72	\$4,920.09	\$6,634.11	\$6,642.14	\$4,392.96
27	35027	\$4,611.23	\$5,346.21	\$7,280.45	\$7,643.63	\$4,773.39
30	35030	\$6,313.64	\$6,870.08	\$9,331.37	\$9,822.50	\$6,133.97
36	35036	\$7,892.06	\$8,792.02	\$11,944.15	\$12,572.79	\$8,792.02

SEWER & PROFILE FITTINGS

ELBOW

90 DEGREE

FEMALE X FEMALE

REGULAR

§ Available with Dissimilar Outlet.



Size	Part Number	SDR35		SDR26/35 HWS		Profile: (23)
		SW: (81)	GSK: (79)	SW: (82)	GSK: (80)	
4	3704	\$13.32	\$34.90	\$90.71	\$94.68	CF
6	3706	\$36.98	\$64.20	\$99.90	\$103.89	CF
8	3708	\$142.46	\$177.56	\$518.04	\$453.12	\$158.53
10	37010	\$537.88	\$597.20	\$743.06	\$751.07	\$533.21
12	37012	\$755.45	\$772.87	\$984.34	\$992.34	\$690.03
15	37015	\$1,603.59	\$1,631.43	\$1,824.75	\$1,832.78	\$1,456.61
18	37018	\$2,313.79	\$2,759.65	\$3,446.83	\$3,454.81	\$2,463.97
21	37021	\$3,561.47	\$4,739.92	\$6,390.95	\$6,398.94	\$4,232.08
24	37024	\$4,932.39	\$6,337.63	\$8,547.79	\$8,555.80	\$5,658.59
27	37027	\$6,458.44	\$7,237.42	\$7,280.45	\$9,046.76	\$6,461.95
30	37030	\$7,258.41	\$9,073.02	\$9,331.37	\$11,345.01	\$8,100.95
36	37036	\$9,290.76	\$12,737.01	\$11,944.15	\$14,516.93	\$12,725.77

ELBOW

11-1/4 DEGREE

FEMALE X MALE

§ Available with Dissimilar Outlet.



Size	Part Number	SDR35		SDR26/35 HWS		Profile: (23)
		SW: (81)	GSK: (79)	SW: (82)	GSK: (80)	
4	4004	\$68.01	\$71.94	\$68.01	\$71.94	\$71.94
6	4006	\$69.28	\$98.63	\$69.28	\$98.63	\$98.63
8	4008	\$133.65	\$166.10	\$247.24	\$251.23	\$166.10
10	40010	\$375.56	\$423.35	\$517.31	\$525.35	\$423.35
12	40012	\$554.36	\$555.26	\$698.01	\$706.01	\$555.26
15	40015	\$1,193.93	\$1,199.12	\$1,678.08	\$1,686.09	\$1,199.12
18	40018	\$1,534.18	\$1,830.39	\$2,738.07	\$2,746.09	\$1,830.39
21	40021	\$2,835.51	\$3,112.61	\$4,194.08	\$4,202.11	\$3,112.61
24	40024	\$4,040.72	\$4,481.83	\$6,042.41	\$6,050.45	\$4,481.83
27	40027	\$4,611.23	\$5,346.42	\$6,755.19	\$7,110.72	\$5,346.42
30	40030	\$6,313.64	\$6,870.08	\$10,850.38	\$11,421.45	\$6,870.08
36	40036	\$7,892.06	\$8,792.02	\$13,562.97	\$14,276.80	\$8,792.02

FABRICATED

§ Available in Larger Sizes. § Available with Dissimilar Outlet.

Size	Part Number	SDR35		SDR26/35 HWS		Profile: (23)
		SW: (81)	GSK: (79)	SW: (82)	GSK: (80)	
6	3696F	\$99.90	\$103.89	\$139.87	\$145.45	CF
8	3698F	\$171.59	\$224.91	\$240.23	\$314.88	CF
10	36910F	\$587.07	\$667.43	\$821.90	\$934.41	CF

22-1/2 DEGREE

FEMALE X MALE



Size	Part-Number	SDR35		SDR26/35 HWS		Profile: (23)
		SW: (81)	GSK: (79)	SW: (82)	GSK: (80)	
4	4204	\$13.05	\$26.35	\$34.17	\$38.19	\$26.35
6	4206	\$53.07	\$51.79	\$69.28	\$98.63	\$51.79
8	4208	\$133.65	\$166.10	\$247.24	\$245.03	\$166.10
10	42010	\$375.56	\$423.23	\$517.31	\$525.35	\$423.23
12	42012	\$554.36	\$555.26	\$698.01	\$706.01	\$555.26
15	42015	\$1,193.93	\$1,199.12	\$1,678.08	\$1,686.09	\$1,199.12
18	42018	\$1,534.18	\$1,830.39	\$2,738.07	\$2,746.09	\$1,830.39
21	42021	\$2,835.51	\$3,112.68	\$4,194.08	\$4,202.11	\$3,112.68
24	42024	\$4,040.72	\$4,481.77	\$6,042.41	\$6,050.45	\$4,481.77
27	42027	\$4,611.23	\$5,346.42	\$6,455.73	\$7,110.72	\$5,346.42
30	42030	\$6,313.64	\$6,870.32	\$8,839.10	\$11,421.89	\$6,870.32
36	42036	\$7,892.06	\$8,792.02	\$11,048.88	\$14,620.02	\$8,792.02

5 DEGREE

FEMALE X MALE

Size	Part Number	SDR35		SDR26/35 HWS		Profile: (23)
		SW: (81)	GSK: (79)	SW: (82)	GSK: (80)	
4	3954	\$68.01	\$71.94	\$68.01	\$71.94	\$71.94
6	3956	\$69.28	\$98.63	\$69.28	\$98.63	\$98.63
8	3958	\$133.65	\$166.10	\$247.24	\$251.23	\$166.10
10	39510	\$375.56	\$423.35	\$517.31	\$525.35	\$423.35
12	39512	\$554.36	\$555.26	\$698.01	\$706.01	\$555.26
15	39515	\$1,193.93	\$1,199.12	\$1,678.08	\$1,686.09	\$1,199.12
18	39518	\$1,534.18	\$1,830.39	\$2,738.07	\$2,746.09	\$1,830.39
21	39521	\$2,835.51	\$3,112.61	\$4,194.08	\$4,202.11	\$3,112.61
24	39524	\$4,040.72	\$4,481.83	\$6,042.41	\$6,050.45	\$4,481.83
27	39527	\$4,611.23	\$5,346.42	\$6,755.19	\$7,110.72	\$5,346.42
30	39530	\$6,313.64	\$6,870.08	\$10,850.38	\$11,421.45	\$6,870.08
36	39536	\$7,892.06	\$8,792.02	\$13,562.97	\$14,276.80	\$8,792.02

30 DEGREE

FEMALE X MALE

Size	Part Number	SDR35		SDR26/35 HWS		Profile: (23)
		SW: (81)	GSK: (79)	SW: (82)	GSK: (80)	
4	4304	\$68.01	\$71.94	\$68.01	\$71.94	\$26.35
6	4306	\$69.28	\$98.62	\$69.28	\$98.62	\$51.79
8	4308	\$133.65	\$166.10	\$247.24	\$251.23	\$166.10
10	43010	\$375.56	\$423.23	\$517.31	\$525.35	\$423.23
12	43012	\$554.36	\$555.26	\$698.01	\$706.01	\$555.26
15	43015	\$1,193.93	\$1,199.12	\$1,678.08	\$1,686.09	\$1,199.12
18	43018	\$1,534.18	\$1,830.39	\$2,738.07	\$2,746.09	\$1,830.39
21	43021	\$2,835.51	\$3,112.61	\$4,194.08	\$4,202.11	\$3,112.68
24	43024	\$4,040.72	\$4,481.83	\$6,042.41	\$6,050.45	\$4,481.77
27	43027	\$4,611.23	\$5,346.42	\$6,455.73	\$7,110.72	\$5,346.42
30	43030	\$6,313.64	\$6,870.08	\$8,839.10	\$11,421.45	\$6,870.32
36	43036	\$7,892.06	\$8,792.02	\$11,048.88	\$14,619.45	\$8,792.02

ELBOW

45 DEGREE

FEMALE X MALE

LONG TURN

§ Available in Larger Sizes. § Available with Dissimilar Outlet.

Size	Part Number	SDR35		SDR26/35 HWS		Profile: (23)
		SW: (81)	GSK: (79)	SW: (82)	GSK: (80)	
4	4434	\$16.30	\$45.58	\$92.97	\$120.18	CF
6	4436	\$126.28	\$167.43	\$145.51	\$256.44	CF
8	4438	\$336.65	\$372.36	\$583.56	\$527.57	CF

FABRICATED

§ Available in Larger Sizes. § Available with Dissimilar Outlet.

Size	Part Number	SDR35		SDR26/35 HWS		Profile: (23)
		SW: (81)	GSK: (79)	SW: (82)	GSK: (80)	
6	4396F	\$69.28	\$98.63	\$96.99	\$98.63	CF
8	4398F	\$156.30	\$190.50	\$218.81	\$266.70	CF
10	43910F	\$392.39	\$458.72	\$549.34	\$642.21	CF

45 DEGREE

FEMALE X MALE



Size	Part Number	SDR35		SDR26/35 HWS		Profile: (23)
		SW: (81)	GSK: (79)	SW: (82)	GSK: (80)	
3	4403	CF	CF	CF	CF	CF
4	4404	\$12.44	\$24.95	\$38.26	\$39.31	\$24.95
6	4406	\$49.64	\$49.88	\$69.28	\$72.25	\$49.88
8	4408	\$133.10	\$150.51	\$232.28	\$236.26	\$150.51
10	44010	\$367.58	\$402.86	\$471.06	\$479.06	\$402.86
12	44012	\$575.75	\$575.75	\$736.09	\$744.12	\$575.75
15	44015	\$1,041.59	\$1,041.59	\$1,485.66	\$1,493.68	\$1,041.59
18	44018	\$1,534.18	\$1,753.58	\$2,187.31	\$2,195.29	\$1,753.58
21	44021	\$2,835.51	\$3,112.91	\$4,194.42	\$4,202.46	\$3,112.91
24	44024	\$4,040.72	\$4,481.54	\$6,042.10	\$6,050.10	\$4,481.54
27	44027	\$4,611.23	\$5,346.21	\$6,455.73	\$7,110.43	\$5,346.21
30	44030	\$6,313.64	\$6,870.08	\$8,839.10	\$11,421.45	\$6,870.08
36	44036	\$7,892.06	\$8,792.02	\$11,048.88	\$14,619.45	\$8,792.02

90 DEGREE

FEMALE X MALE

REGULAR



Size	Part-Number	SDR35		SDR26/35 HWS		Profile: (23)
		SW: (81)	GSK: (79)	SW: (82)	GSK: (80)	
4	4604	\$16.26	\$32.09	\$90.71	\$94.68	\$32.09
6	4606	\$63.37	\$67.87	\$94.67	\$98.63	\$67.87
8	4608	\$173.02	\$183.24	\$583.56	\$440.70	\$183.24
10	46010	\$518.58	\$593.17	\$743.06	\$751.07	\$593.17
12	46012	\$755.13	\$755.13	\$984.34	\$992.34	\$755.13
15	46015	\$1,418.13	\$1,488.49	\$1,824.75	\$1,832.78	\$1,488.49
18	46018	\$2,313.79	\$2,550.62	\$3,185.21	\$3,193.19	\$2,550.62
21	46021	\$3,561.47	\$4,285.60	\$5,777.50	\$5,785.46	\$4,285.60
24	46024	\$4,932.39	\$5,291.66	\$7,135.66	\$7,143.67	\$5,291.66
27	46027	\$6,458.44	\$7,351.29	\$9,041.82	\$9,189.10	\$7,351.29
30	46030	\$9,073.05	\$9,073.02	\$12,702.27	\$14,176.62	\$9,073.02
36	46036	\$11,613.49	\$12,737.01	\$16,258.89	\$18,146.07	\$12,737.01

LONG TURN

§ Available in Larger Sizes. § Available with Dissimilar Outlet.

Size	Part Number	SDR35		SDR26/35 HWS		Profile: (23)
		SW: (81)	GSK: (79)	SW: (82)	GSK: (80)	
3	4653	\$15.54	CF	CF	CF	CF
4	4654	\$16.30	\$45.58	\$92.97	\$120.18	CF
6	4656	\$126.28	\$167.43	\$145.51	\$256.44	CF
8	4658	\$336.65	\$372.36	\$583.56	\$527.57	CF
10	46510	\$773.55	\$794.89	\$1,002.78	\$982.51	CF
12	46512	\$1,094.55	\$1,135.24	\$1,552.88	\$1,512.64	CF

FLANGE

VAN STONE

FLANGE X MALE

150# ANSI BOLT PATTERN x SDR35



§ Available in Larger Sizes. § Flanges w/ PVC /Stainless Steel Backing Rings Available—Please Contact Factory.
§ 14"+ Provided w/ "Thermal Powder Epoxy Coated AWWA Class D DI Backing Flange."

Size	Part Number	SDR35		SDR26/35 HWS		Profile: (23)
		SW: (81)	GSK: (79)	SW: (82)	GSK: (80)	
4	5204	\$121.85	NA	\$128.93	NA	\$121.85
6	5206	\$167.26	NA	\$181.41	NA	\$167.26
8	5208	\$256.86	NA	\$274.06	NA	\$256.86
10	52010	\$336.24	NA	\$367.44	NA	\$336.24
12	52012	\$546.08	NA	\$585.40	NA	\$546.08
14x15	5201415	\$1,789.80	NA	\$2,632.90	NA	\$1,789.80
16x15	5201615	\$2,358.19	NA	\$2,838.85	NA	\$2,358.19
18	52018	\$2,768.35	NA	\$3,281.90	NA	\$2,768.35
20x21	5202021	\$3,354.51	NA	\$4,042.40	NA	\$3,354.51
24	52024	\$4,516.91	NA	\$4,729.61	NA	\$4,516.91

FLANGE X FEMALE

150# ANSI BOLT PATTERN x SDR35



§ Available in Larger Sizes. § Flanges w/ PVC /Stainless Steel Backing Rings Available—Please Contact Factory.
§ 14"+ Provided w/ "Thermal Powder Epoxy Coated AWWA Class D DI Backing Flange."

Size	Part Number	SDR35		SDR26/35 HWS		Profile: (23)
		SW: (81)	GSK: (79)	SW: (82)	GSK: (80)	
4	5304	\$121.85	\$128.93	\$121.85	\$128.93	\$128.93
6	5306	\$167.26	\$181.41	\$167.26	\$181.41	\$181.41
8	5308	\$256.86	\$274.06	\$256.86	\$274.06	\$274.06
10	53010	\$336.24	\$367.44	\$336.24	\$367.44	\$367.44
12	53012	\$546.08	\$585.40	\$546.08	\$585.40	\$585.40
14x15	53014-15	\$1,789.80	\$2,632.90	\$1,789.80	\$2,632.90	\$2,632.90
16x15	53016-15	\$2,358.19	\$2,838.85	\$2,358.19	\$2,838.85	\$2,838.85
18	53018	\$2,768.35	\$3,281.90	\$2,768.35	\$3,281.90	\$3,281.90
20x21	53020-21	\$3,354.51	\$4,042.40	\$3,354.51	\$4,042.40	\$4,042.40
24	53024	\$4,516.91	\$4,729.61	\$4,516.91	\$4,729.61	\$4,729.61

SEWER & PROFILE FITTINGS

REDUCER

CONCENTRIC

FEMALE X FEMALE

§ Available with Dissimilar Outlet.

Size	Part Number	SDR35		SDR26/35 HWS		Profile: (23)
		SW: (81)	GSK: (79)	SW: (82)	GSK: (80)	
4x3	6004-3IPS	\$12.62	CF	NA	NA	CF
6x4	60064	\$32.53	\$98.36	\$116.83	\$112.51	CF
8x4	60084	\$133.85	\$156.15	\$263.91	\$215.33	\$135.82
8x6	60086	\$137.56	\$163.96	\$244.00	\$223.06	\$142.60
10x4	600104	\$275.90	\$359.88	\$396.60	\$404.58	\$312.53
10x6	600106	\$443.65	\$426.32	\$471.06	\$479.06	\$370.74
10x8	600108	\$395.02	\$494.72	\$547.73	\$555.71	\$441.74
12x4	600124	\$467.07	\$523.87	\$604.14	\$612.09	\$455.56
12x6	600126	\$492.08	\$554.24	\$1,035.13	\$1,043.15	\$481.95
12x8	600128	\$642.03	\$642.03	\$733.19	\$741.20	\$573.25
12x10	6001210	\$528.87	\$741.23	\$851.13	\$859.13	\$661.84
15x4	600154	\$566.64	\$825.53	\$1,020.09	\$1,028.08	\$717.91
15x6	600156	\$711.60	\$867.23	\$1,324.45	\$1,332.43	\$754.18
15x8	600158	\$940.49	\$940.49	\$1,123.12	\$1,131.13	\$839.75
15x10	6001510	\$1,036.19	\$1,036.19	\$1,238.73	\$1,246.71	\$925.16
15x12	6001512	\$1,033.56	\$1,126.65	\$1,347.66	\$1,355.66	\$1,005.92
18x4	600184	\$887.21	\$1,085.83	\$1,351.23	\$1,359.25	\$944.17
18x6	600186	\$936.33	\$1,104.54	\$1,374.89	\$1,382.84	\$960.55
18x8	600188	\$973.81	\$1,120.87	\$1,395.21	\$1,403.22	\$1,000.80
18x10	6001810	\$1,010.45	\$1,160.32	\$1,444.51	\$1,452.52	\$1,036.00
18x12	6001812	\$1,117.58	\$1,185.03	\$1,475.48	\$1,483.52	\$1,058.09
18x15	6001815	\$1,079.46	\$1,234.29	\$1,537.10	\$1,545.09	\$1,102.02
21x4	600214	\$1,158.56	\$1,566.22	\$2,008.63	\$2,114.33	\$1,361.92
21x6	600216	\$1,178.65	\$1,582.45	\$2,029.47	\$2,136.28	\$1,375.99
21x8	600218	\$1,208.66	\$1,604.92	\$2,058.28	\$2,166.61	\$1,432.96
21x10	6002110	\$1,247.96	\$1,626.16	\$2,084.58	\$2,194.29	\$1,451.94
21x12	6002112	\$1,293.27	\$1,710.47	\$2,193.72	\$2,309.18	\$1,527.21
21x15	6002115	\$1,392.11	\$1,975.71	\$2,533.97	\$2,667.33	\$1,764.03
21x18	6002118	\$1,542.52	\$2,128.87	\$2,730.26	\$2,873.95	\$1,900.77
24x4	600244	\$2,725.96	\$3,264.51	\$4,186.00	\$4,406.32	\$2,838.71
24x6	600246	\$2,745.85	\$3,296.30	\$4,227.49	\$4,449.99	\$2,866.38
24x8	600248	\$2,775.98	\$3,334.26	\$4,276.13	\$4,501.18	\$2,976.98
24x10	6002410	\$2,815.16	\$3,351.32	\$4,298.06	\$4,524.28	\$2,992.25
24x12	6002412	\$2,860.70	\$3,455.50	\$4,431.65	\$4,664.88	\$3,085.27
24x15	6002415	\$2,959.65	\$3,541.54	\$4,541.98	\$4,781.03	\$3,162.10
24x18	6002418	\$3,109.98	\$3,731.68	\$4,785.87	\$5,037.75	\$3,331.85
24x21	6002421	\$3,775.43	\$4,047.55	\$5,191.15	\$5,464.35	\$3,613.88
27x4	600274	\$3,625.53	\$4,341.79	\$3,979.47	\$4,188.92	\$3,351.14
27x6	600276	\$3,651.99	\$4,384.09	\$3,997.47	\$4,207.87	\$3,366.29
27x8	600278	\$3,692.07	\$4,434.57	\$4,040.28	\$4,252.92	\$3,402.35
27x10	6002710	\$3,744.18	\$4,457.28	\$4,086.35	\$4,301.42	\$3,441.15
27x12	6002712	\$3,804.74	\$4,595.82	\$4,295.88	\$4,521.97	\$3,617.60
27x15	6002715	\$3,936.33	\$4,710.26	\$4,319.15	\$4,546.47	\$3,637.14
27x18	6002718	\$4,136.28	\$4,963.14	\$4,497.05	\$4,733.74	\$3,787.02
27x21	6002721	\$5,021.33	\$5,383.25	\$5,182.60	\$5,455.35	\$4,364.30
27x24	6002724	\$5,579.26	\$5,981.40	\$5,614.21	\$5,909.69	\$4,727.75
30x4	600304	\$4,821.96	\$5,774.59	\$5,093.73	\$5,361.82	\$4,231.53
30x6	600306	\$4,857.15	\$5,830.85	\$5,116.78	\$5,386.09	\$4,325.77
30x8	600308	\$4,910.46	\$5,898.00	\$6,549.49	\$6,894.19	\$4,373.05
30x10	6003010	\$4,979.76	\$5,928.18	\$8,383.33	\$8,824.55	\$4,422.05
30x12	6003012	\$5,060.31	\$6,112.45	\$10,730.66	\$11,295.43	\$4,648.85
30x15	6003015	\$5,235.33	\$6,264.65	\$13,735.26	\$14,458.16	\$4,673.94
30x18	6003018	\$5,501.26	\$6,600.98	\$17,581.13	\$18,506.45	\$4,866.49
30x21	6003021	\$6,678.37	\$7,159.74	\$22,503.82	\$23,688.24	\$5,608.24
30x24	6003024	\$7,420.42	\$7,955.27	\$28,804.91	\$30,320.97	\$6,075.40
30x27	6003027	\$8,244.92	\$8,839.19	\$36,870.29	\$38,810.82	\$7,594.33
36x4	600364	\$6,413.22	\$7,680.21	\$6,519.99	\$6,863.14	\$9,484.36
36x6	600366	\$6,460.01	\$7,755.03	\$6,549.48	\$6,894.19	\$9,549.07
36x8	600368	\$6,530.92	\$7,844.34	\$8,383.33	\$8,824.55	\$9,622.21
36x10	6003610	\$6,623.09	\$7,884.49	\$10,730.66	\$11,295.43	\$9,741.02
36x12	6003612	\$6,730.22	\$8,129.56	\$13,735.26	\$14,458.16	\$9,872.91
36x15	6003615	\$6,963.01	\$8,331.99	\$17,581.13	\$18,506.45	\$10,107.40
36x18	6003618	\$7,316.68	\$8,779.31	\$22,503.82	\$23,688.24	\$10,365.35
36x21	6003621	\$8,882.23	\$9,522.46	\$28,804.91	\$30,320.97	\$10,643.57
36x24	6003624	\$9,869.16	\$10,580.52	\$36,870.29	\$38,810.82	\$11,845.56
36x27	6003627	\$10,965.75	\$11,756.12	\$47,193.97	\$49,677.86	\$12,182.79
36x30	6003630	\$12,184.16	\$13,062.36	\$60,408.28	\$63,587.65	\$12,908.40

MALE X FEMALE

(SEB)

§ Available with Dissimilar Outlet.

Size	Part Number	SDR35		SDR26/35 HWS		Profile: (23)
		SW: (81)	GSK: (79)	SW: (82)	GSK: (80)	
4x2	6204-2	\$47.36	NA	NA	NA	CF
4x3	6204-3	\$41.45	NA	NA	NA	CF
6x4	62064	\$31.81	\$49.88	\$109.19	\$101.43	CF
8x4	62084	\$104.83	\$136.24	\$246.65	\$193.84	\$136.24
8x6	62086	\$106.88	\$152.62	\$227.95	\$203.46	\$152.62
10x4	620104	\$229.82	\$357.08	\$370.25	\$404.19	\$357.08
10x6	620106	\$331.85	\$370.96	\$440.25	\$479.06	\$370.96
10x8	620108	\$366.32	\$441.18	\$511.90	\$555.71	\$441.18
12x4	620124	\$387.96	\$476.47	\$564.61	\$612.09	\$476.47
12x6	620126	\$409.93	\$486.81	\$593.88	\$643.45	\$486.81
12x8	620128	\$444.69	\$558.06	\$685.23	\$741.20	\$558.06
12x10	6201210	\$558.57	\$618.84	\$795.44	\$859.13	\$618.84
15x4	620154	\$532.61	\$793.66	\$953.35	\$1,028.08	\$793.66
15x6	620156	\$590.74	\$823.15	\$967.41	\$1,043.15	\$823.15
15x8	620158	\$792.98	\$931.74	\$1,049.68	\$1,131.14	\$931.74
15x10	6201510	\$885.03	\$939.09	\$1,157.69	\$1,246.71	\$939.09
15x12	6201512	\$938.72	\$1,077.06	\$1,259.50	\$1,355.66	\$1,077.06
18x4	620184	\$887.21	\$1,123.60	\$1,307.11	\$1,269.96	\$1,123.60
18x6	620186	\$936.33	\$1,138.68	\$1,179.42	\$1,406.56	\$1,138.68
18x8	620188	\$973.81	\$1,150.94	\$1,339.06	\$1,440.80	\$1,150.94
18x10	6201810	\$1,010.45	\$1,167.13	\$1,358.05	\$1,461.06	\$1,167.13
18x12	6201812	\$1,033.56	\$1,183.58	\$1,377.29	\$1,481.67	\$1,183.58
18x15	6201815	\$1,040.11	\$1,193.25	\$1,388.73	\$1,493.91	\$1,193.25
21x4	620214	\$1,144.67	\$1,300.47	\$1,558.75	\$1,755.64	\$1,300.47
21x6	620216	\$1,172.91	\$1,423.30	\$1,705.97	\$1,921.46	\$1,423.30
21x8	620218	\$1,198.89	\$1,431.80	\$1,716.25	\$1,933.03	\$1,431.80
21x10	6202110	\$1,247.96	\$1,448.87	\$1,736.63	\$1,955.99	\$1,448.87
21x12	6202112	\$1,293.39	\$1,483.52	\$1,778.17	\$2,002.78	\$1,483.52
21x15	6202115	\$1,379.34	\$1,540.69	\$1,846.70	\$2,079.96	\$1,540.69
21x18	6202118	\$1,554.02	\$1,670.64	\$2,002.37	\$2,255.30	\$1,670.64
24x4	620244	\$2,689.62	\$2,885.78	\$3,458.91	\$3,895.81	\$2,885.78
24x6	620246	\$2,721.53	\$2,920.06	\$3,499.93	\$3,942.03	\$2,920.06
24x8	620248	\$2,755.66	\$2,956.42	\$3,543.63	\$3,991.23	\$2,956.42
24x10	6202410	\$2,820.09	\$3,025.46	\$3,626.35	\$4,084.42	\$3,025.46
24x12	6202412	\$2,856.80	\$3,064.77	\$3,673.42	\$4,137.42	\$3,064.77
24x15	6202415	\$2,938.30	\$3,152.04	\$3,778.01	\$4,255.23	\$3,152.04
24x18	6202418	\$3,067.10	\$3,289.64	\$3,943.02	\$4,441.09	\$3,289.64
24x21	6202421	\$3,606.29	\$3,866.58	\$4,634.52	\$5,219.93	\$3,866.58
27x4	620274	\$2,746.75	\$2,946.44	\$3,270.08	\$3,683.03	\$2,946.44
27x6	620276	\$2,767.38	\$2,968.57	\$3,294.64	\$3,710.69	\$2,968.57
27x8	620278	\$2,805.44	\$3,009.40	\$3,339.93	\$3,761.71	\$3,009.40
27x10	6202710	\$2,842.34	\$3,048.98	\$3,383.91	\$3,811.24	\$3,048.98
27x12	6202712	\$2,847.17	\$3,054.16	\$3,389.60	\$3,817.65	\$3,054.16
27x15	6202715	\$3,006.19	\$3,224.74	\$3,578.99	\$4,030.95	\$3,224.74
27x18	6202718	\$3,164.48	\$3,394.54	\$3,767.42	\$4,243.17	\$3,394.54
27x21	6202721	\$3,689.17	\$3,957.37	\$4,392.05	\$4,946.69	\$3,957.37
27x24	6202724	\$4,407.34	\$4,727.75	\$5,247.08	\$5,909.69	\$4,727.75
30x4	620304	\$3,653.18	\$3,918.77	\$4,349.20	\$4,898.43	\$4,231.53
30x6	620306	\$3,680.62	\$3,948.20	\$4,381.87	\$4,935.22	\$4,325.77
30x8	620308	\$3,731.24	\$4,002.50	\$4,442.11	\$5,003.07	\$4,373.05
30x10	6203010	\$3,780.31	\$4,055.14	\$4,500.60	\$5,068.94	\$4,422.05
30x12	6203012	\$3,786.73	\$4,062.03	\$4,508.17	\$5,077.47	\$4,448.85
30x15	6203015	\$3,998.24	\$4,288.91	\$4,760.06	\$5,361.17	\$4,673.94
30x18	6203018	\$4,208.76	\$4,514.74	\$5,010.66	\$5,643.42	\$4,866.48
30x21	6203021	\$4,906.59	\$5,263.30	\$5,841.43	\$6,579.10	\$5,608.24
30x24	6203024	\$5,861.76	\$6,287.91	\$6,978.62	\$7,859.89	\$6,075.40
30x27	6203027	\$6,513.07	\$6,986.57	\$7,754.02	\$8,733.21	\$7,594.33
36x4	620364	\$4,858.73	\$5,211.96	\$5,784.44	\$6,514.91	\$9,484.36
36x6	620366	\$4,895.23	\$5,251.11	\$5,827.89	\$6,563.85	\$9,549.07
36x8	620368	\$4,962.55	\$5,323.32	\$5,908.01	\$6,654.09	\$9,622.21
36x10	6203610	\$5,027.81	\$5,393.34	\$5,985.80	\$6,741.69	\$9,741.02
36x12	6203612	\$5,036.35	\$5,402.50	\$5,995.86	\$6,753.03	\$9,872.91
36x15	6203615	\$5,317.66	\$5,704.25	\$6,330.88	\$7,130.36	\$10,107.40
36x18	6203618	\$5,597.65	\$6,004.60	\$6,664.18	\$7,505.75	\$10,365.35
36x21	6203621	\$6,525.77	\$7,000.19			

REDUCER

CONCENTRIC

FEMALE X MALE

(LEB)

 § Available with Dissimilar Outlet.

Size	Part Number	SDR35		SDR26/35 HWS		Profile: (23)
		SW: (81)	GSK: (79)	SW: (82)	GSK: (80)	
4x3	64043	\$12.62	NA	NA	NA	CF
6x4	64064	\$32.53	\$98.36	\$116.83	\$112.51	CF
8x4	64084	\$133.85	\$156.15	\$263.91	\$215.33	\$135.82
8x6	64086	\$137.56	\$163.96	\$244.00	\$223.06	\$142.60
10x4	640104	\$275.90	\$359.88	\$396.60	\$404.58	\$312.53
10x6	640106	\$443.65	\$426.32	\$471.06	\$479.06	\$370.74
10x8	640108	\$395.02	\$494.72	\$547.73	\$555.71	\$441.74
12x4	640124	\$467.07	\$523.87	\$604.14	\$612.09	\$455.56
12x6	640126	\$492.08	\$554.24	\$1,035.13	\$1,043.15	\$481.95
12x8	640128	\$642.03	\$642.03	\$733.19	\$741.20	\$573.25
12x10	6401210	\$528.87	\$741.23	\$851.13	\$859.13	\$661.84
15x4	640154	\$566.64	\$825.53	\$1,020.09	\$1,028.08	\$717.91
15x6	640156	\$711.60	\$867.23	\$1,324.45	\$1,332.43	\$754.18
15x8	640158	\$940.49	\$940.49	\$1,123.12	\$1,131.13	\$839.75
15x10	6401510	\$1,036.19	\$1,036.19	\$1,238.73	\$1,246.71	\$925.16
15x12	6401512	\$1,033.56	\$1,126.65	\$1,347.66	\$1,355.66	\$1,005.92
18x4	640184	\$887.21	\$1,085.83	\$1,351.23	\$1,359.25	\$944.17
18x6	640186	\$936.33	\$1,104.54	\$1,374.89	\$1,382.84	\$960.55
18x8	640188	\$973.81	\$1,120.87	\$1,395.21	\$1,403.22	\$1,000.80
18x10	6401810	\$1,010.45	\$1,160.32	\$1,444.51	\$1,452.52	\$1,036.00
18x12	6401812	\$1,117.58	\$1,185.03	\$1,475.48	\$1,483.52	\$1,058.09
18x15	6401815	\$1,079.46	\$1,234.29	\$1,537.10	\$1,545.09	\$1,102.02
21x4	640214	\$1,158.56	\$1,566.22	\$2,008.63	\$2,114.33	\$1,361.92
21x6	640216	\$1,178.64	\$1,582.45	\$2,029.47	\$2,136.28	\$1,375.99
21x8	640218	\$1,208.66	\$1,604.92	\$2,058.28	\$2,166.61	\$1,432.96
21x10	6402110	\$1,247.95	\$1,626.16	\$2,084.58	\$2,194.29	\$1,451.94
21x12	6402112	\$1,293.27	\$1,710.47	\$2,193.72	\$2,309.18	\$1,527.21
21x15	6402115	\$1,392.11	\$1,975.71	\$2,533.97	\$2,667.33	\$1,764.03
21x18	6402118	\$1,542.52	\$2,128.87	\$2,730.26	\$2,873.95	\$1,900.77
24x4	640244	\$2,725.96	\$3,264.51	\$4,186.00	\$4,406.32	\$2,838.71
24x6	640246	\$2,745.85	\$3,296.30	\$4,227.49	\$4,449.99	\$2,866.38
24x8	640248	\$2,775.98	\$3,334.26	\$4,276.13	\$4,501.18	\$2,976.98
24x10	6402410	\$2,815.16	\$3,351.32	\$4,298.06	\$4,524.28	\$2,992.25
24x12	6402412	\$2,860.70	\$3,455.50	\$4,431.65	\$4,664.88	\$3,085.27
24x15	6402415	\$2,959.64	\$3,541.54	\$4,541.98	\$4,781.03	\$3,162.10
24x18	6402418	\$3,109.98	\$3,731.68	\$4,785.87	\$5,037.75	\$3,331.85
24x21	6402421	\$3,775.43	\$4,047.55	\$5,191.15	\$5,464.35	\$3,613.88
27x4	640274	\$3,625.52	\$4,341.79	\$5,567.39	\$5,860.40	\$3,351.14
27x6	640276	\$3,651.99	\$4,384.08	\$5,622.57	\$5,918.48	\$3,366.29
27x8	640278	\$3,692.05	\$4,434.57	\$5,687.25	\$5,986.57	\$3,402.34
27x10	6402710	\$3,744.17	\$4,457.26	\$5,716.42	\$6,017.29	\$3,441.15
27x12	6402712	\$3,804.73	\$4,595.81	\$5,894.09	\$6,204.29	\$3,617.60
27x15	6402715	\$3,936.33	\$4,710.24	\$6,040.83	\$6,358.77	\$3,637.14
27x18	6402718	\$4,136.27	\$4,963.13	\$6,365.21	\$6,700.21	\$3,787.02
27x21	6402721	\$5,021.33	\$5,383.25	\$6,904.22	\$7,267.59	\$4,364.30
27x24	6402724	\$5,579.25	\$5,981.38	\$7,671.36	\$8,075.10	\$4,727.75
30x8	640308	\$4,412.29	\$5,515.13	\$6,549.49	\$6,894.19	\$4,373.05
30x10	6403010	\$5,647.71	\$7,059.06	\$8,383.33	\$8,824.55	\$4,422.05
30x12	6403012	\$7,229.08	\$9,035.30	\$10,730.66	\$11,295.43	\$4,648.84
30x15	6403015	\$9,253.22	\$10,199.34	\$13,735.26	\$14,458.16	\$4,673.93
30x18	6403018	\$11,844.11	\$13,055.14	\$17,581.13	\$18,506.45	\$4,866.48
30x21	6403021	\$15,160.46	\$13,661.49	\$22,503.82	\$23,688.24	\$5,608.24
30x24	6403024	\$19,405.40	\$15,345.78	\$28,804.91	\$30,320.97	\$6,075.40
30x27	6403027	\$24,838.92	\$14,691.65	\$36,870.29	\$38,810.82	\$7,594.33
36x8	640368	\$5,647.71	\$7,059.06	\$8,383.33	\$8,824.55	\$9,622.21
36x10	6403610	\$7,229.08	\$9,035.30	\$10,730.66	\$11,295.43	\$9,741.02
36x12	6403612	\$9,253.22	\$11,565.48	\$13,735.26	\$14,458.16	\$9,872.90
36x15	6403615	\$11,844.11	\$13,038.30	\$17,581.13	\$18,506.45	\$10,107.40
36x18	6403618	\$15,160.46	\$13,661.49	\$22,503.82	\$23,688.24	\$10,365.35
36x21	6403621	\$19,405.40	\$14,410.06	\$28,804.91	\$30,320.97	\$10,643.57
36x24	6403624	\$24,838.92	\$15,907.21	\$36,870.29	\$38,810.82	\$11,845.57
36x27	6403627	\$31,793.83	\$16,655.79	\$47,193.97	\$49,677.86	\$12,182.79
36x30	6403630	\$40,696.11	\$19,126.08	\$60,408.28	\$63,587.65	\$12,908.40

ECCENTRIC

FEMALE X FEMALE

 § Available with Dissimilar Outlet.

Size	Part Number	SDR35		SDR26/35 HWS		Profile: (23)
		SW: (81)	GSK: (79)	SW: (82)	GSK: (80)	
6x4	61064	CF	\$98.36	CF	\$112.51	CF
8x4	61084	\$133.85	\$156.15	CF	\$215.33	\$135.82
8x6	61086	\$137.56	\$149.49	CF	\$223.06	\$142.60
10x4	610104	\$275.90	\$359.88	CF	\$404.58	\$312.53
10x6	610106	\$443.65	\$426.32	CF	\$479.06	\$370.74
10x8	610108	\$395.02	\$494.72	CF	\$555.71	\$441.74
12x4	610124	\$467.07	\$523.87	CF	\$612.09	\$455.56
12x6	610126	\$492.08	\$554.24	CF	\$1,043.15	\$481.95
12x8	610128	\$642.03	\$642.03	CF	\$741.20	\$573.25
12x10	6101210	\$528.87	\$741.23	CF	\$859.13	\$661.84
15x4	610154	\$566.64	\$825.53	CF	\$1,028.08	\$717.91
15x6	610156	\$711.60	\$867.23	CF	\$1,332.43	\$754.18
15x8	610158	\$940.49	\$940.49	CF	\$1,131.13	\$839.75
15x10	6101510	\$1,036.19	\$1,036.19	CF	\$1,246.71	\$925.16
15x12	6101512	\$1,033.56	\$1,126.65	CF	\$1,355.66	\$1,005.92
18x4	610184	\$887.21	\$1,085.83	CF	\$1,359.25	\$944.17
18x6	610186	\$936.33	\$1,104.54	CF	\$1,382.84	\$960.55
18x8	610188	\$973.81	\$1,120.87	CF	\$1,403.22	\$1,000.80
18x10	6101810	\$1,010.45	\$1,160.32	CF	\$1,452.52	\$1,036.00
18x12	6101812	\$1,117.58	\$1,185.03	CF	\$1,483.52	\$1,058.09
18x15	6101815	\$1,079.46	\$1,234.29	CF	\$1,545.09	\$1,102.02
21x4	610214	\$1,158.56	\$1,566.22	CF	\$2,114.33	\$1,361.92
21x6	610216	\$1,178.64	\$1,582.45	CF	\$2,136.28	\$1,375.99
21x8	610218	\$1,208.66	\$1,604.92	CF	\$2,166.61	\$1,432.96
21x10	6102110	\$1,247.95	\$1,626.16	CF	\$2,194.29	\$1,451.94
21x12	6102112	\$1,293.27	\$1,710.47	CF	\$2,309.18	\$1,527.21
21x15	6102115	\$1,392.11	\$1,975.71	CF	\$2,667.33	\$1,764.03
21x18	6102118	\$1,542.52	\$2,128.87	CF	\$2,873.95	\$1,900.77
24x4	610244	\$2,725.96	\$3,264.51	CF	\$4,406.32	\$2,838.71
24x6	610246	\$2,745.85	\$3,296.30	CF	\$4,449.99	\$2,866.38
24x8	610248	\$2,775.98	\$3,334.26	CF	\$4,501.18	\$2,976.98
24x10	6102410	\$2,815.16	\$3,351.32	CF	\$4,524.28	\$2,992.25
24x12	6102412	\$2,860.70	\$3,455.50	CF	\$4,664.88	\$3,085.27
24x15	6102415	\$2,959.64	\$3,541.54	CF	\$4,781.03	\$3,162.10
24x18	6102418	\$3,109.98	\$3,731.68	CF	\$5,037.75	\$3,331.85
24x21	6102421	\$3,775.43	\$4,047.55	CF	\$5,464.35	\$3,613.88
27x4	610274	\$3,625.53	\$4,341.79	CF	\$5,860.42	\$3,351.14
27x6	610276	\$3,651.99	\$4,384.08	CF	\$5,918.50	\$3,366.29
27x8	610278	\$3,692.07	\$4,434.57	CF	\$5,986.58	\$3,402.35
27x10	6102710	\$3,744.18	\$4,457.28	CF	\$6,017.29	\$3,441.15
27x12	6102712	\$3,804.74	\$4,595.82	CF	\$6,204.29	\$3,617.60
27x15	6102715	\$3,936.36	\$4,710.26	CF	\$6,358.78	\$3,637.14
27x18	6102718	\$4,136.28	\$4,963.14	CF	\$6,700.22	\$3,787.02
27x21	6102721	\$5,021.33	\$5,383.25	CF	\$7,267.60	\$4,364.30
27x24	6102724	\$5,579.26	\$5,981.40	CF	\$8,075.11	\$4,727.75
30x4	610304	\$4,821.96	\$5,774.59	CF	\$7,794.36	\$4,231.53
30x6	610306	\$4,857.15	\$5,830.85	CF	\$7,871.61	\$4,325.77
30x8	610308	\$4,910.46	\$5,898.00	CF	\$7,962.16	\$4,373.05
30x10	6103010	\$4,979.76	\$5,928.18	CF	\$8,003.00	\$4,422.05
30x12	6103012	\$5,060.31	\$6,112.45	CF	\$8,251.71	\$4,648.85
30x15	6103015	\$5,235.36	\$6,264.65	CF	\$8,457.19	\$4,673.94
30x18	6103018	\$5,501.26	\$6,600.98	CF	\$8,911.29	\$4,866.49
30x21	6103021	\$6,678.37	\$7,159.74	CF	\$9,665.92	\$5,608.24
30x24	6103024	\$7,420.42	\$7,955.27	CF	\$10,739.90	\$6,075.40
30x27	6103027	\$9,869.15	\$8,839.19	CF	\$11,933.23	\$7,594.33
36x4	610364	\$6,413.22	\$7,680.21	CF	\$10,366.49	\$9,484.36
36x6	610366	\$6,460.01	\$7,755.03	CF	\$10,469.24	\$9,549.07
36x8	610368	\$6,530.92	\$7,844.34	CF	\$10,589.68	\$9,622.21
36x10	6103610	\$6,623.09	\$7,884.49	CF	\$10,644.00	\$9,741.02
36x12	6103612	\$6,730.22	\$8,129.56	CF	\$10,974.78	\$9,872.91
36x15	6103615	\$6,963.01	\$8,331.99	CF	\$11,248.07	\$10,107.40
36x18	6103618	\$7,316.68	\$8,779.31	CF	\$11,852.03	\$10,365.35
36x21	6103621	\$8,882.23	\$9,522.46	CF	\$12,855.69	\$10,643.57
36x24	6103624	\$9,869.16	\$10,580.52	CF	\$14,284.07	\$11,845.57
36x27	6103627	\$10,965.75	\$11,756.12	CF	\$15,871.20	\$12,182.79
36x30	6103630	\$12,184.16	\$13,062.36	CF	\$17,634.66	\$12,908.40

SEWER & PROFILE FITTINGS

REDUCER

ECCENTRIC

MALE X FEMALE

(SEB)

Available with Dissimilar Outlet.

Table with columns: Size, Part Number, SDR35 SW: (81), SDR35 GSK: (79), SDR26/35 HWS SW: (82), SDR26/35 HWS GSK: (80), Profile: (23). Rows include sizes from 6x4 to 36x30.

FEMALE X MALE

(LEB)

Available with Dissimilar Outlet.

Table with columns: Size, Part Number, SDR35 SW: (81), SDR35 GSK: (79), SDR26/35 HWS SW: (82), SDR26/35 HWS GSK: (80), Profile: (23). Rows include sizes from 6x4 to 36x30.

SEWER & PROFILE FITTINGS

SADDLE TEE W/2 S.S. BANDS

GASKET BASE X FEMALE

§ Available in Larger Sizes or Dissimilar Outlet. § Saddle Skirt Gasket Must Be Ordered From Pipe Manufacturer.

Size	Part Number	SDR35		SDR26/35 HWS		Profile: (23)
		SW: (81)	GSK: (79)	SW: (82)	GSK: (80)	
6x4	70064	CF	64.11	CF	CF	CF
8x4	70084	CF	80.55	CF	CF	CF
8x6	70086	CF	92.24	CF	CF	CF
10x4	700104	CF	142.38	CF	CF	CF
10x6	700106	CF	170.00	CF	CF	CF
12x4	700124	CF	176.62	CF	CF	CF
12x6	700126	CF	198.61	CF	CF	CF
15x4	700154	CF	186.73	CF	CF	CF
15x6	700156	CF	200.23	CF	CF	CF
18x4	700184	CF	329.15	CF	CF	CF
18x6	700186	CF	362.62	CF	CF	CF
21x4	700214	CF	342.59	CF	CF	CF
21x6	700216	CF	364.54	CF	CF	CF
24x4	700244	CF	349.07	CF	CF	CF
24x6	700246	CF	366.62	CF	CF	CF
27x4	700274	CF	349.07	CF	CF	CF
27x6	700276	CF	366.70	CF	CF	CF
30x6	700306	CF	366.70	CF	CF	CF

SOLVENT WELD BASE X FEMALE

§ Available in Larger Sizes. § Available with Dissimilar Outlet.

Size	Part Number	SDR35		SDR26/35 HWS		Profile: (23)
		SW: (81)	GSK: (79)	SW: (82)	GSK: (80)	
6x4	70164	\$67.88	\$78.89	\$95.04	\$110.45	\$78.89
8x4	70184	\$94.46	\$99.11	\$132.24	\$138.76	\$99.11
8x6	70186	\$104.70	\$113.50	\$146.59	\$158.90	\$113.50
10x4	701104	\$111.28	\$175.20	\$155.80	\$245.29	\$175.20
10x6	701106	\$127.13	\$209.19	\$177.99	\$292.86	\$209.19
10x8	701108	\$308.80	\$350.97	\$432.32	\$491.36	\$350.97
12x4	701124	\$114.37	\$217.33	\$160.12	\$304.26	\$217.33
12x6	701126	\$131.42	\$244.38	\$183.99	\$342.14	\$244.38
12x8	701128	\$364.30	\$405.02	\$510.02	\$567.03	\$405.02
12x10	7011210	\$475.44	\$509.88	\$665.61	\$713.83	\$509.88
15x4	701154	\$121.80	\$229.77	\$170.52	\$321.67	\$229.77
15x6	701156	\$136.24	\$246.38	\$190.74	\$344.92	\$246.38
15x8	701158	\$449.50	\$483.93	\$629.30	\$677.50	\$483.93
15x10	7011510	\$545.12	\$547.20	\$763.16	\$766.08	\$547.20
15x12	7011512	\$787.77	\$819.13	\$1,122.69	\$1,146.78	\$819.13
18x4	701184	\$195.17	\$405.02	\$273.24	\$567.03	\$405.02
18x6	701186	\$208.82	\$446.20	\$292.35	\$624.68	\$446.20
18x8	701188	\$505.76	\$577.49	\$708.06	\$808.49	\$577.49
18x10	7011810	\$594.52	\$640.76	\$832.32	\$897.06	\$640.76
18x12	7011812	\$823.46	\$916.01	\$1,152.85	\$1,282.41	\$916.01
18x15	7011815	\$897.87	\$1,000.01	\$1,257.01	\$1,400.00	\$1,000.01
21x4	701214	\$203.46	\$421.55	\$284.84	\$590.17	\$421.55
21x6	701216	\$223.55	\$448.56	\$312.97	\$628.00	\$448.56
21x8	701218	\$636.80	\$577.49	\$891.51	\$808.49	\$577.49
21x10	7012110	\$638.35	\$640.76	\$893.69	\$897.06	\$640.76
21x12	7012112	\$870.20	\$916.01	\$1,218.28	\$1,282.41	\$916.01
21x15	7012115	\$950.01	\$1,000.01	\$1,330.01	\$1,400.00	\$1,000.01
21x18	7012118	\$1,410.79	\$1,485.04	\$1,975.11	\$2,079.06	\$1,485.04
24x4	701244	\$210.87	\$429.53	\$295.23	\$601.35	\$429.53
24x6	701246	\$230.95	\$451.11	\$323.33	\$631.56	\$451.11
24x8	701248	\$555.71	\$584.96	\$777.99	\$818.95	\$584.96
24x10	7012410	\$615.73	\$648.13	\$862.02	\$907.39	\$648.13
24x12	7012412	\$874.56	\$920.59	\$1,224.38	\$1,288.82	\$920.59
24x15	7012415	\$957.03	\$1,007.41	\$1,339.84	\$1,410.38	\$1,007.41
24x18	7012418	\$1,482.28	\$1,560.28	\$2,075.19	\$2,184.38	\$1,560.28
24x21	7012421	\$1,668.63	\$1,756.45	\$2,336.08	\$2,459.03	\$1,756.45
27x4	701274	\$210.87	\$429.53	\$295.23	\$601.35	\$429.53
27x6	701276	\$230.95	\$451.11	\$323.33	\$631.56	\$451.11
27x8	701278	\$555.71	\$584.96	\$777.99	\$818.95	\$584.96
27x10	7012710	\$615.73	\$648.13	\$862.02	\$907.39	\$648.13
27x12	7012712	\$874.56	\$920.59	\$1,224.38	\$1,288.82	\$920.59
27x15	7012715	\$957.03	\$1,007.41	\$1,339.84	\$1,410.38	\$1,007.41

Size	Part Number	SDR35		SDR26/35 HWS		Profile: (23)
		SW: (81)	GSK: (79)	SW: (82)	GSK: (80)	
27x18	7012718	\$1,523.16	\$1,603.32	\$1,992.91	\$2,244.65	\$1,603.32
27x21	7012721	\$1,738.90	\$1,830.43	\$2,275.20	\$2,562.60	\$1,830.43
27x24	7012724	\$2,060.66	\$2,169.11	\$2,696.19	\$3,036.75	\$2,169.11
30x8	701308	\$711.24	\$945.95	\$930.60	\$1,324.33	\$945.95
30x10	7013010	\$787.96	\$1,047.98	\$1,030.97	\$1,467.16	\$1,047.98
30x12	7013012	\$1,119.24	\$1,488.59	\$1,464.43	\$2,084.02	\$1,488.59
30x15	7013015	\$1,224.87	\$1,629.08	\$1,602.65	\$2,280.70	\$1,629.08
30x18	7013018	\$1,896.95	\$2,522.94	\$2,481.99	\$3,532.11	\$2,522.94
30x21	7013021	\$2,135.57	\$2,840.31	\$2,794.20	\$3,976.43	\$2,840.31
30x24	7013024	\$2,453.58	\$3,263.26	\$3,210.30	\$4,568.57	\$3,263.26
30x27	7013027	\$2,732.16	\$3,633.77	\$3,574.78	\$5,087.28	\$3,633.77
36x8	701368	\$746.82	\$993.27	\$977.13	\$1,390.58	\$993.27
36x10	7013610	\$827.37	\$1,100.39	\$1,082.53	\$1,540.55	\$1,100.39
36x12	7013612	\$1,175.19	\$1,563.01	\$1,537.64	\$2,188.22	\$1,563.01
36x15	7013615	\$1,286.12	\$1,710.54	\$1,682.78	\$2,394.76	\$1,710.54
36x18	7013618	\$1,991.79	\$2,649.09	\$2,606.08	\$3,708.73	\$2,649.09
36x21	7013621	\$2,242.37	\$2,982.36	\$2,933.94	\$4,175.29	\$2,982.36
36x24	7013624	\$2,576.27	\$3,426.43	\$3,370.83	\$4,797.01	\$3,426.43
36x27	7013627	\$3,252.56	\$4,325.91	\$4,255.69	\$6,056.28	\$4,325.91
36x30	7013630	\$4,065.72	\$5,407.41	\$5,319.64	\$7,570.38	\$5,407.41

SADDLE TEE SKIRT GASKET

§ Available in Smaller and Larger Sizes.

Size	Part Number	SDR35		SDR26/35 HWS		Profile: (23)
		SW: (81)	GSK: (79)	SW: (82)	GSK: (80)	
4	7054	\$22.30	\$22.30	\$20.84	\$22.30	CF
6	7056	\$29.21	\$29.21	\$27.30	\$29.21	CF

SADDLE WYE W/2 S.S. BANDS

GASKET BASE X FEMALE

§ Available in Larger Sizes or Dissimilar Outlet. § Saddle Skirt Gasket Must Be Ordered From Pipe Manufacturer.

Size	Part Number	SDR35		SDR26/35 HWS		Profile: (23)
		SW: (81)	GSK: (79)	SW: (82)	GSK: (80)	
6x4	74064	CF	\$70.84	CF	CF	CF
8x4	74084	CF	\$99.11	CF	CF	CF
8x6	74086	CF	\$102.54	CF	CF	CF
10x4	740104	CF	\$196.54	CF	CF	CF
10x6	740106	CF	\$210.92	CF	CF	CF
12x4	740124	CF	\$219.04	CF	CF	CF
12x6	740126	CF	\$246.01	CF	CF	CF
15x4	740154	CF	\$230.83	CF	CF	CF
15x6	740156	CF	\$254.36	CF	CF	CF
18x4	740184	CF	\$411.59	CF	CF	CF
18x6	740186	CF	\$448.79	CF	CF	CF
21x4	740214	CF	\$427.41	CF	CF	CF
21x6	740216	CF	\$460.62	CF	CF	CF
24x4	740244	CF	\$435.40	CF	CF	CF
24x6	740246	CF	\$468.60	CF	CF	CF
27x4	740274	CF	\$435.40	CF	CF	CF
27x6	740276	CF	\$468.60	CF	CF	CF
30x4	740304	CF	\$435.40	CF	CF	CF
30x6	740306	CF	\$468.60	CF	CF	CF

SADDLE WYE W/2 S.S. BANDS

SOLVENT WELD BASE X FEMALE



Available in Larger Sizes. Available with Dissimilar Outlet.

Size	Part Number	SDR35		SDR26/35 HWS		Profile: (23)
		SW: (81)	GSK: (79)	SW: (82)	GSK: (80)	
6x4	74164	\$70.71	\$70.84	\$99.00	\$99.17	CF
8x4	74184	\$96.83	\$99.11	\$135.56	\$138.76	\$99.11
8x6	74186	\$102.39	\$102.54	\$143.35	\$143.55	\$102.54
10x4	741104	\$113.62	\$196.54	\$159.07	\$275.16	\$196.54
10x6	741106	\$128.14	\$210.92	\$179.39	\$295.28	\$210.92
10x8	741108	\$413.37	\$458.37	\$578.72	\$641.72	\$458.37
12x4	741124	\$117.30	\$219.04	\$164.22	\$306.66	\$219.04
12x6	741126	\$132.66	\$246.01	\$185.73	\$344.42	\$246.01
12x8	741128	\$584.40	\$645.51	\$818.15	\$903.72	\$645.51
12x10	7411210	\$711.40	\$775.35	\$995.96	\$1,085.49	\$775.35
15x4	741154	\$125.22	\$230.83	\$175.31	\$323.16	\$230.83
15x6	741156	\$139.63	\$254.36	\$195.48	\$356.10	\$254.36
15x8	741158	\$783.48	\$787.59	\$1,096.88	\$1,102.63	\$787.59
15x10	7411510	\$888.70	\$889.64	\$1,244.18	\$1,245.51	\$889.64
15x12	7411512	\$1,083.23	\$1,085.55	\$1,516.52	\$1,519.76	\$1,085.55
18x4	741184	\$198.24	\$411.59	\$277.54	\$576.22	\$411.59
18x6	741186	\$211.99	\$448.79	\$296.78	\$628.31	\$448.79
18x8	741188	\$831.27	\$881.12	\$1,163.79	\$1,233.58	\$881.12
18x10	7411810	\$943.22	\$983.21	\$1,320.51	\$1,376.49	\$983.21
18x12	7411812	\$1,121.57	\$1,179.27	\$1,570.21	\$1,650.97	\$1,179.27
18x15	7411815	\$1,203.11	\$1,266.44	\$1,731.67	\$1,773.00	\$1,266.44
21x4	741214	\$212.95	\$427.41	\$298.14	\$598.38	\$427.41
21x6	741216	\$226.85	\$460.62	\$317.59	\$644.86	\$460.62
21x8	741218	\$837.07	\$881.12	\$1,171.91	\$1,233.58	\$881.12
21x10	7412110	\$934.05	\$983.21	\$1,307.67	\$1,376.49	\$983.21
21x12	7412112	\$1,120.30	\$1,179.27	\$1,568.43	\$1,650.97	\$1,179.27
21x15	7412115	\$1,203.11	\$1,266.44	\$1,684.35	\$1,773.00	\$1,266.44
21x18	7412118	\$1,410.79	\$1,485.04	\$1,975.11	\$2,079.06	\$1,485.04
24x4	741244	\$220.34	\$435.40	\$308.47	\$609.57	\$435.40
24x6	741246	\$234.25	\$468.60	\$327.96	\$656.04	\$468.60
24x8	741248	\$844.21	\$888.64	\$1,181.88	\$1,244.09	\$888.64
24x10	7412410	\$941.11	\$990.64	\$1,317.55	\$1,386.89	\$990.64
24x12	7412412	\$1,127.42	\$1,186.75	\$1,578.39	\$1,661.45	\$1,186.75
24x15	7412415	\$1,210.20	\$1,273.89	\$1,694.28	\$1,783.45	\$1,273.89
24x18	7412418	\$1,482.26	\$1,560.28	\$2,075.17	\$2,184.38	\$1,560.28
24x21	7412421	\$1,668.63	\$1,756.45	\$2,336.08	\$2,459.03	\$1,756.45
27x4	741274	\$220.34	\$435.40	\$308.47	\$609.57	\$435.40
27x6	741276	\$234.25	\$468.60	\$327.96	\$656.04	\$468.60
27x8	741278	\$844.21	\$888.64	\$1,181.88	\$1,244.09	\$888.64
27x10	7412710	\$941.11	\$990.64	\$1,317.55	\$1,386.89	\$990.64
27x12	7412712	\$1,127.42	\$1,186.75	\$1,578.39	\$1,661.45	\$1,186.75
27x15	7412715	\$1,210.20	\$1,273.89	\$1,694.28	\$1,783.45	\$1,273.89
27x18	7412718	\$1,523.16	\$1,603.32	\$2,132.42	\$2,244.65	\$1,603.32
27x21	7412721	\$1,738.90	\$1,830.43	\$2,434.47	\$2,562.60	\$1,830.43
27x24	7412724	\$2,135.38	\$2,247.76	\$2,989.53	\$3,146.87	\$2,247.76
30x4	741304	\$556.46	\$585.74	\$779.06	\$820.04	\$585.74
30x6	741306	\$599.82	\$631.39	\$839.75	\$883.95	\$631.39

SADDLE WYE SKIRT GASKET

Available in Smaller and Larger Sizes.

Size	Part Number	SDR35		SDR26/35 HWS		Profile: (23)
		SW: (81)	GSK: (79)	SW: (82)	GSK: (80)	
4	7504	\$24.91	\$24.91	\$23.28	\$24.91	CF
6	7506	\$33.44	\$33.44	\$31.25	\$33.44	CF

TEE

TWO-WAY CLEANOUT

FEMALE X FEMALE X FEMALE

Available in Larger Sizes. Other Sized Taps Available.

Size	Part Number	SDR35		SDR26/35 HWS		Profile: (23)
		SW: (81)	GSK: (79)	SW: (82)	GSK: (80)	
4	8604	\$38.26	\$112.48	\$38.26	\$112.48	CF
6	8606	\$235.82	\$638.69	\$235.82	\$638.69	CF

CLEANOUT

FEMALE X FEMALE X FIPT

Available in Larger Sizes. Other Sized Taps Available.

Size	Part Number	SDR35		SDR26/35 HWS		Profile: (23)
		SW: (81)	GSK: (79)	SW: (82)	GSK: (80)	
4	8404	\$35.41	CF	CF	CF	CF
6	8406	\$234.58	CF	CF	CF	CF

STRAIGHT

FEMALE X FEMALE X FEMALE



Spigot End Configurations Available. Available with Dissimilar Outlet.

Size	Part Number	SDR35		SDR26/35 HWS		Profile: (23)
		SW: (81)	GSK: (79)	SW: (82)	GSK: (80)	
4	8204	\$13.32	\$44.94	\$40.90	\$120.62	NA
6x4	82064	\$52.50	\$94.17	\$151.88	\$155.91	NA
6	8206	\$55.41	\$96.27	\$172.40	\$172.60	NA
8x4	82084	\$121.29	\$145.47	\$213.25	\$217.28	\$126.47
8x6	82086	\$150.07	\$150.51	\$238.02	\$242.02	\$130.91
8	8208	\$226.21	\$213.61	\$319.84	\$342.48	\$207.37
10x4	820104	\$407.90	\$472.65	\$535.31	\$543.32	\$410.95
10x6	820106	\$469.49	\$480.63	\$545.88	\$553.83	\$417.90
10x8	820108	\$587.99	\$760.55	\$833.41	\$841.40	\$679.07
10	82010	\$709.63	\$780.75	\$909.16	\$917.14	\$697.05
12x4	820124	\$569.71	\$577.90	\$685.35	\$693.37	\$502.54
12x6	820126	\$614.67	\$609.08	\$718.15	\$726.16	\$529.62
12x8	820128	\$732.34	\$835.90	\$977.77	\$985.77	\$746.37
12x10	8201210	\$786.09	\$980.10	\$1,169.42	\$1,177.40	\$875.07
12	82012	\$1,064.36	\$1,121.87	\$1,262.86	\$1,270.86	\$1,001.67
15x4	820154	\$838.22	\$938.18	\$1,021.97	\$1,030.00	\$815.76
15x6	820156	\$968.02	\$1,010.45	\$1,127.01	\$1,135.03	\$878.65
15x8	820158	\$1,052.97	\$1,087.88	\$1,187.26	\$1,195.24	\$971.31
15x10	8201510	\$1,117.50	\$1,211.09	\$1,354.57	\$1,362.50	\$1,081.34
15x12	8201512	\$1,356.77	\$1,429.13	\$1,597.56	\$1,605.54	\$1,275.97
18x4	820184	\$2,139.00	\$2,367.62	\$2,955.91	\$2,963.95	\$2,058.67
18x6	820186	\$2,214.14	\$2,447.85	\$3,056.53	\$3,064.51	\$2,128.57
18x8	820188	\$2,316.25	\$2,557.48	\$3,193.65	\$3,201.64	\$2,283.48
18x10	8201810	\$2,408.27	\$2,655.90	\$3,316.72	\$3,324.75	\$2,371.31
18x12	8201812	\$2,476.01	\$2,728.51	\$3,407.81	\$3,415.78	\$2,436.14
21x4	820214	\$3,039.07	\$3,330.63	\$4,488.24	\$4,496.29	\$2,896.15
21x6	820216	\$3,265.38	\$3,572.82	\$4,815.25	\$4,823.23	\$3,106.80
21x8	820218	\$3,513.05	\$3,837.81	\$5,172.98	\$5,180.99	\$3,426.60
21x10	8202110	\$3,779.88	\$4,123.66	\$5,558.91	\$5,566.91	\$3,681.87
21x12	8202112	\$4,056.86	\$4,419.99	\$5,958.98	\$5,966.93	\$3,946.43
24x4	820244	\$4,657.14	\$5,255.35	\$7,086.62	\$7,094.62	\$4,569.81
24x6	820246	\$5,743.45	\$6,372.44	\$8,594.85	\$8,602.85	\$5,541.25
24x8	820248	\$5,902.31	\$6,473.35	\$8,731.03	\$8,739.02	\$5,779.77
24x10	8202410	\$5,961.91	\$6,759.42	\$9,117.19	\$9,125.17	\$6,035.21
24x12	8202412	\$6,092.99	\$6,882.87	\$9,283.91	\$9,291.88	\$6,145.40

TEE

STRAIGHT

FEMALE X FEMALE X FEMALE

Size	Part Number	SDR35		SDR26/35 HWS		Profile: (23)
		SW: (81)	GSK: (79)	SW: (82)	GSK: (80)	
27x4	820274	\$5,500.41	\$6,875.61	\$7,700.57	\$8,594.40	\$5,978.73
27x6	820276	\$5,533.38	\$6,916.75	\$7,746.73	\$8,645.90	\$6,014.63
27x8	820278	\$6,316.67	\$7,895.85	\$8,843.34	\$9,869.79	\$7,049.86
27x10	8202710	\$6,643.62	\$8,304.55	\$9,301.08	\$10,380.69	\$7,414.78
27x12	8202712	\$7,264.70	\$9,080.85	\$10,170.58	\$11,351.11	\$8,107.90
27	82027	\$11,011.92	\$13,764.87	\$11,481.51	\$17,206.12	\$12,290.07
30x4	820304	\$7,068.33	\$8,835.43	\$11,765.17	\$11,044.28	\$7,682.98
30x6	820306	\$7,110.71	\$8,888.40	\$12,117.40	\$11,110.49	\$7,729.11
30x8	820308	\$8,117.11	\$10,146.40	\$14,992.56	\$12,682.98	\$9,059.28
30x10	8203010	\$8,537.33	\$10,671.66	\$15,416.68	\$13,339.57	\$9,528.24
30x12	8203012	\$9,335.46	\$11,669.35	\$9,895.66	\$14,586.66	\$10,419.06
36x4	820364	\$9,400.88	\$11,060.20	\$13,161.23	\$14,688.89	\$8,796.45
36x6	820366	\$9,457.24	\$11,556.13	\$13,240.14	\$14,776.93	\$9,517.24
36x8	820368	\$10,795.76	\$13,586.63	\$15,114.06	\$16,868.36	\$9,833.30
36x10	8203610	\$11,354.63	\$13,758.80	\$15,896.49	\$17,741.62	\$11,416.64
36x12	8203612	\$12,416.18	\$14,537.32	\$17,382.65	\$19,400.27	\$11,769.96

TEE

SANITARY (T-Y)

FEMALE X FEMALE X FEMALE

Size	Part Number	SDR35		SDR26/35 HWS		Profile: (23)
		SW: (81)	GSK: (79)	SW: (82)	GSK: (80)	
21x4	810214	\$3,390.11	\$3,536.30	\$4,766.00	\$4,773.94	\$3,157.44
21x6	810216	\$3,479.50	\$3,825.71	\$5,156.70	\$5,164.71	\$3,415.79
21x8	810218	\$3,639.18	\$4,678.34	\$6,307.78	\$6,315.81	\$4,177.05
21x10	8102110	\$4,413.07	\$5,150.52	\$6,456.75	\$6,687.67	\$5,150.52
21x12	8102112	\$4,718.37	\$5,511.17	\$6,605.71	\$7,152.02	\$5,511.17
21x15	8102115	\$5,270.97	\$6,153.16	\$7,379.36	\$7,983.30	\$6,153.16
21x18	8102118	\$5,438.18	\$6,982.72	\$7,613.44	\$9,061.73	\$6,982.72
21	81021	\$5,598.09	\$9,262.22	\$7,837.34	\$12,019.90	\$9,262.22
24x4	810244	\$5,336.93	\$5,887.83	\$7,940.59	\$7,948.58	\$5,256.98
24x6	810246	\$5,645.57	\$6,238.41	\$8,413.94	\$8,421.96	\$5,570.03
24x8	810248	\$5,834.04	\$6,365.74	\$8,585.80	\$8,593.81	\$5,683.71
24x10	8102410	\$6,325.13	\$7,386.71	\$8,855.19	\$9,586.00	\$7,386.71
24x12	8102412	\$6,441.49	\$7,516.57	\$9,018.09	\$9,758.20	\$7,516.57
24x15	8102415	\$6,695.97	\$7,812.26	\$9,374.35	\$10,140.16	\$7,812.26
24x18	8102418	\$8,353.50	\$10,805.95	\$11,694.90	\$14,027.00	\$10,805.95
24x21	8102421	\$10,018.46	\$11,693.22	\$14,025.84	\$16,092.49	\$11,693.22
24	81024	\$12,308.58	\$14,369.39	\$17,232.01	\$18,647.73	\$14,369.39
27x4	810274	\$5,807.60	\$7,259.53	\$8,130.64	\$9,074.38	\$6,481.72
27x6	810276	\$5,958.88	\$7,448.62	\$8,342.43	\$9,310.75	\$6,479.80
27x8	810278	\$6,098.24	\$7,622.87	\$8,537.53	\$9,528.51	\$6,806.13
27x10	8102710	\$7,259.77	\$9,074.71	\$10,163.68	\$11,343.38	\$9,074.71
27x12	8102712	\$7,929.12	\$9,911.40	\$11,100.77	\$12,389.25	\$9,911.40
27x15	8102715	\$8,956.34	\$11,195.44	\$12,538.88	\$13,994.30	\$11,195.44
27x18	8102718	\$9,181.43	\$11,476.80	\$12,854.00	\$14,346.00	\$11,476.80
27x21	8102721	\$9,452.66	\$11,815.82	\$13,233.72	\$14,769.77	\$11,815.82
27x24	8102724	\$11,697.56	\$14,621.96	\$16,376.59	\$18,277.45	\$14,621.96
27	81027	\$12,026.43	\$15,033.04	\$16,837.00	\$18,791.30	\$15,033.04
30x4	810304	\$7,462.99	\$9,328.74	\$10,448.19	\$11,660.91	\$8,329.23
30x6	810306	\$7,657.49	\$9,571.88	\$10,720.49	\$11,964.84	\$8,546.32
30x8	810308	\$7,836.44	\$9,795.57	\$10,971.02	\$12,244.45	\$8,746.05
30x10	8103010	\$9,074.71	\$11,343.38	\$12,704.59	\$14,179.24	\$11,343.38
30x12	8103012	\$9,911.40	\$12,389.25	\$13,875.96	\$15,486.55	\$12,389.25
30x15	8103015	\$11,195.44	\$13,994.30	\$15,673.61	\$17,492.85	\$13,994.30
30x18	8103018	\$11,476.80	\$14,346.00	\$16,067.51	\$17,932.51	\$14,346.00
30x21	8103021	\$11,815.82	\$14,769.77	\$16,542.14	\$18,462.21	\$14,769.77
30x24	8103024	\$14,621.96	\$18,277.45	\$20,470.74	\$22,846.82	\$18,277.45
30x27	8103027	\$18,277.45	\$22,846.82	\$25,588.43	\$28,558.51	\$22,846.82
30	81030	\$22,846.82	\$28,558.51	\$31,985.55	\$35,698.14	\$28,558.51
36x4	810364	\$9,328.73	\$11,660.93	\$13,060.22	\$14,576.14	\$9,028.80
36x6	810366	\$9,571.86	\$11,964.09	\$13,400.60	\$14,956.04	\$9,754.27
36x8	810368	\$9,795.56	\$12,242.95	\$13,713.79	\$15,305.56	\$10,218.40
36x10	8103610	\$11,343.38	\$14,179.24	\$15,880.74	\$17,724.03	\$14,179.24
36x12	8103612	\$12,389.25	\$15,486.55	\$17,344.96	\$19,358.18	\$15,486.55
36x15	8103615	\$13,994.30	\$17,492.85	\$19,592.02	\$21,866.09	\$17,492.85
36x18	8103618	\$14,346.00	\$17,932.51	\$20,084.40	\$22,415.64	\$17,932.51
36x21	8103621	\$14,769.77	\$18,462.21	\$20,749.00	\$23,077.78	\$18,462.21
36x24	8103624	\$18,277.45	\$22,846.82	\$25,588.43	\$28,558.51	\$22,846.82
36x27	8103627	\$22,846.82	\$28,558.51	\$31,985.55	\$35,698.14	\$28,558.51
36x30	8103630	\$28,558.51	\$35,698.14	\$39,981.91	\$44,622.68	\$35,698.14
36	81036	\$35,698.14	\$44,622.68	\$49,977.39	\$55,778.37	\$44,622.68

TEE

SANITARY (T-Y)

FEMALE X FEMALE X FEMALE

§ Spigot End Configurations Available. § Available with Dissimilar Outlet.

Size	Part Number	SDR35		SDR26/35 HWS		Profile: (23)
		SW: (81)	GSK: (79)	SW: (82)	GSK: (80)	
3	8103	\$20.84	CF	CF	CF	NA
4	8104	\$21.37	\$53.38	\$156.01	CF	NA
6x4	81064	\$110.91	\$115.53	\$177.52	\$171.88	NA
6	8106	\$127.13	\$134.72	\$221.19	\$225.15	NA
8x4	81084	\$145.00	\$146.30	\$213.08	\$217.09	\$130.61
8x6	81086	\$163.31	\$168.28	\$244.02	\$248.03	\$150.24
8	8108	\$345.75	\$414.19	\$554.85	\$558.84	\$369.80
10x4	810104	\$519.59	\$550.66	\$632.92	\$640.93	\$491.68
10x6	810106	\$601.15	\$631.05	\$711.99	\$719.98	\$563.43
10x8	810108	\$932.86	\$968.60	\$1,107.41	\$1,115.39	\$864.84
10	81010	\$1,133.55	\$1,284.41	\$1,230.46	\$1,380.83	\$1,284.41
12x4	810124	\$624.71	\$678.61	\$791.17	\$799.21	\$605.94
12x6	810126	\$712.05	\$723.22	\$862.30	\$870.30	\$645.74
12x8	810128	\$1,151.40	\$1,071.79	\$1,759.79	\$1,218.69	\$956.94
12x10	8101210	\$1,256.15	\$1,587.59	\$1,758.61	\$1,687.56	\$1,587.59
12	81012	\$1,477.30	\$1,794.43	\$2,068.22	\$1,918.22	\$1,794.43
15x4	810154	\$940.40	\$1,094.96	\$1,251.24	\$1,259.25	\$977.63
15x6	810156	\$1,059.14	\$1,211.09	\$1,361.64	\$1,369.67	\$1,081.34
15x8	810158	\$1,229.28	\$1,307.30	\$1,460.68	\$1,468.62	\$1,167.24
15x10	8101510	\$1,376.74	\$1,514.84	\$1,927.43	\$2,251.16	\$1,514.84
15x12	8101512	\$1,541.88	\$1,781.75	\$2,158.63	\$2,644.80	\$1,781.75
15	81015	\$1,992.03	\$2,322.73	\$2,788.84	\$3,449.42	\$2,322.73
18x4	810184	\$2,258.94	\$2,494.96	\$3,116.28	\$3,124.26	\$2,227.63
18x6	810186	\$2,344.78	\$2,540.81	\$3,173.11	\$3,181.10	\$2,268.59
18x8	810188	\$2,478.94	\$2,693.26	\$3,366.17	\$3,374.19	\$2,404.72
18x10	8101810	\$2,602.76	\$3,036.96	\$3,643.86	\$4,502.20	\$3,036.96
18x12	8101812	\$2,668.15	\$3,124.88	\$3,735.42	\$4,622.05	\$3,124.88
18x15	8101815	\$2,849.96	\$4,106.41	\$3,989.95	\$4,930.14	\$4,106.41
18	81018	\$3,002.63	\$3,325.43	\$4,203.69	\$5,204.08	\$3,325.43

COMBO WYE W/ 1/8 BEND

FEMALE X FEMALE X FEMALE

§ Available with Dissimilar Outlet. § 10"-12" Molded Fittings Available—Contact Factory.

Size	Part Number	SDR35		SDR26/35 HWS		Profile: (23)
		SW: (81)	GSK: (79)	SW: (82)	GSK: (80)	
4	8904	\$44.36	\$84.96	\$197.84	\$224.69	CF
6x4	89064	\$94.16	\$134.12	\$203.13	\$226.54	CF
6	8906	\$141.49	\$210.76	\$255.25	\$295.16	CF
8x4	89084	\$173.11	\$224.65	\$268.04	\$297.92	CF
8x6	89086	\$238.34	\$306.17	\$331.88	\$359.39	CF
8	8908	\$407.09	\$463.90	\$686.58	\$750.23	CF
10x4	890104	\$463.39	\$550.73	\$603.30	\$640.93	CF
10x6	890106	\$556.12	\$631.07	\$643.36	\$719.98	CF
10x8	890108	\$823.13	\$968.60	\$1,116.99	\$1,131.93	CF
10	89010	CF	\$1,315.61	CF	\$1,567.41	CF
12x4	890124	\$625.66	\$678.61	\$808.69	\$827.62	CF
12x6	890126	\$740.83	\$723.22	\$849.71	\$870.30	CF
12x8	890128	\$1,013.51	\$1,138.91	\$1,390.27	\$1,402.51	CF
12x10	8901210	CF	\$1,620.47	CF	\$1,920.99	CF
12	89012	CF	\$1,842.34	CF	\$2,275.87	CF
15x4	890154	\$925.35	\$1,094.96	\$1,136.60	\$1,259.25	CF
15x6	890156	\$1,105.80	\$1,211.09	\$1,384.24	\$1,395.21	CF
15x8	890158	\$1,424.36	\$1,439.46	\$1,698.17	\$1,710.15	CF
15x10	8901510	CF	\$1,961.66	CF	\$2,260.19	CF
15x12	8901512	CF	\$2,309.40	CF	\$2,725.53	CF
15	89015	CF	\$3,512.15	CF	\$3,989.15	CF
18x4	890184	\$2,271.85	\$2,523.14	\$2,791.39	\$3,173.55	CF
18x6	890186	\$2,388.00	\$2,632.34	\$2,858.04	\$3,302.20	CF
18x8	890188	\$2,577.38	\$2,848.06	\$3,119.72	\$3,610.15	CF
21x4	890214	\$3,257.13	\$3,573.87	\$4,817.03	\$4,835.98	CF
21x6	890216	\$3,532.27	\$3,853.11	\$5,191.39	\$5,636.87	CF
21x8	890218	\$4,067.05	\$4,678.34	\$6,008.37	\$6,020.27	CF
24x4	890244	\$4,915.89	\$5,887.83	\$7,244.05	\$7,510.74	CF
24x6	890246	\$6,093.79	\$7,071.77	\$8,316.47	\$9,117.44	CF
24x8	890248	\$6,342.72	\$7,333.65	\$9,126.30	\$9,424.44	CF
27x4	890274	\$6,234.49	\$7,259.53	CF	\$9,762.35	CF
27x6	890276	\$6,308.96	\$7,448.62	CF	\$10,161.51	CF
27x8	890278	\$7,245.48	\$8,629.85	CF	\$11,388.99	CF
30x4	890304	\$8,004.29	\$9,328.74	CF	\$12,527.64	CF
30x6	890306	\$8,089.38	\$9,571.88	CF	\$12,975.30	CF
30x8	890308	\$9,272.79	\$11,043.29	CF	\$14,564.40	CF
36x4	890364	\$10,637.15	\$12,375.81	CF	\$16,641.49	CF
36x6	890366	\$10,738.10	\$12,474.74	CF	\$17,113.82	CF
36x8	890368	\$12,331.02	\$14,428.68	CF	\$19,288.63	CF

WYE

FEMALE X FEMALE X FEMALE

§ Available with Dissimilar Outlet. § 10"-12" Molded Fittings Available—Contact Factory.

Size	Part Number	SDR35		SDR26/35 HWS		Profile: (23)
		SW: (81)	GSK: (79)	SW: (82)	GSK: (80)	
4	9204	\$18.45	\$47.82	\$40.90	\$120.62	NA
6x4	92064	\$65.86	\$96.98	\$152.67	\$156.69	NA
6	9206	\$78.34	\$109.80	\$173.77	\$183.27	NA
8x4	92084	\$142.80	\$144.68	\$217.70	\$221.71	\$125.80
8x6	92086	\$172.37	\$172.54	\$250.40	\$254.39	\$150.05
8	9208	\$261.75	\$300.83	\$442.08	\$446.07	\$268.58
10x4	920104	\$418.79	\$440.13	\$552.84	\$560.82	\$382.68
10x6	920106	\$447.06	\$447.39	\$561.88	\$569.89	\$389.12
10x8	920108	\$677.84	\$707.20	\$872.49	\$880.53	\$631.43
10	92010	\$774.73	\$888.31	\$1,055.94	\$1,063.94	\$793.15
12x4	920124	\$599.62	\$633.70	\$758.23	\$766.16	\$551.04
12x6	920126	\$646.75	\$653.45	\$768.23	\$776.23	\$568.22
12x8	920128	\$868.21	\$976.18	\$1,146.08	\$1,154.08	\$871.59
12x10	9201210	\$1,051.77	\$1,193.18	\$1,409.49	\$1,417.52	\$1,065.34
12	92012	\$1,241.53	\$1,242.18	\$1,499.31	\$1,507.35	\$1,109.11
15x4	920154	\$899.46	\$955.93	\$1,086.13	\$1,094.15	\$831.22
15x6	920156	\$1,042.64	\$1,144.91	\$1,302.76	\$1,310.76	\$995.46
15x8	920158	\$1,272.46	\$1,276.74	\$1,453.68	\$1,461.69	\$1,139.96
15x10	9201510	\$1,488.77	\$1,534.37	\$1,748.71	\$1,756.73	\$1,369.93
15x12	9201512	\$1,672.18	\$1,709.24	\$1,949.00	\$1,957.01	\$1,526.12
15	92015	\$2,151.48	\$2,158.24	\$2,462.98	\$2,470.99	\$1,927.00

WYE

FEMALE X FEMALE X FEMALE

Size	Part Number	SDR35		SDR26/35 HWS		Profile: (23)
		SW: (81)	GSK: (79)	SW: (82)	GSK: (80)	
18x4	920184	\$2,040.34	\$2,195.77	\$2,740.93	\$2,748.91	\$1,909.28
18x6	920186	\$2,071.15	\$2,224.26	\$2,776.56	\$2,784.57	\$1,934.11
18x8	920188	\$2,122.80	\$2,303.09	\$2,875.22	\$2,883.19	\$2,056.30
18x10	9201810	\$2,408.27	\$2,587.49	\$3,231.22	\$3,239.25	\$2,310.29
18x12	9201812	\$2,476.01	\$2,780.37	\$3,472.75	\$3,480.73	\$2,482.47
18x15	9201815	\$2,642.21	\$2,975.46	\$3,716.79	\$3,724.77	\$2,656.51
18	92018	\$3,258.59	\$3,864.97	\$4,830.58	\$4,838.57	\$3,450.89
21x4	920214	\$3,231.22	\$3,536.73	\$4,766.57	\$4,774.58	\$3,075.34
21x6	920216	\$3,469.11	\$3,791.03	\$5,109.91	\$5,117.90	\$3,296.57
21x8	920218	\$3,921.75	\$4,275.44	\$5,763.88	\$5,771.81	\$3,817.33
21x10	9202110	\$4,430.29	\$4,819.17	\$6,497.88	\$6,505.86	\$4,302.82
21x12	9202112	\$4,797.19	\$5,211.91	\$7,028.10	\$7,036.06	\$4,653.49
21x15	9202115	\$5,567.30	\$6,036.30	\$8,140.95	\$8,148.94	\$5,389.55
21x18	9202118	\$6,569.36	\$7,108.30	\$9,588.27	\$9,596.30	\$6,346.70
21	92021	\$8,619.11	\$9,301.44	\$12,548.94	\$12,556.92	\$8,304.88
24x4	920244	\$4,652.77	\$5,334.51	\$7,193.59	\$7,201.54	\$4,638.77
24x6	920246	\$5,447.54	\$6,105.96	\$8,234.99	\$8,242.98	\$5,309.55
24x8	920248	\$5,894.88	\$6,585.09	\$8,881.80	\$8,889.83	\$5,879.55
24x10	9202410	\$5,961.91	\$6,656.34	\$8,978.04	\$8,986.05	\$5,943.15
24x12	9202412	\$6,092.99	\$6,796.52	\$9,167.21	\$9,175.23	\$6,068.34
24x15	9202415	\$6,139.60	\$6,846.42	\$9,234.71	\$9,242.69	\$6,112.86
24x18	9202418	\$8,728.41	\$9,616.40	\$12,974.13	\$12,982.11	\$8,586.07
24x21	9202421	\$9,597.05	\$10,545.56	\$14,228.58	\$14,236.62	\$9,415.68
24	92024	\$10,577.70	\$11,595.00	\$15,645.24	\$15,653.28	\$10,352.69
27x4	920274	\$5,503.14	\$6,878.95	\$7,704.40	\$8,598.66	\$5,981.65
27x6	920276	\$5,757.12	\$7,196.45	\$8,059.97	\$8,995.49	\$6,257.79
27x8	920278	\$6,773.70	\$8,467.13	\$9,483.18	\$10,583.93	\$7,559.94
27x10	9202710	\$6,871.55	\$8,589.48	\$9,620.16	\$10,736.81	\$7,669.15
27x12	9202712	\$7,240.19	\$9,050.25	\$10,136.27	\$11,312.79	\$8,080.59
27x15	9202715	\$7,892.84	\$9,866.03	\$11,049.97	\$12,332.55	\$8,808.98
27x18	9202718	\$8,499.76	\$10,624.74	\$11,899.66	\$13,280.88	\$9,486.37
27x21	9202721	\$9,661.13	\$12,076.42	\$13,525.58	\$15,095.52	\$10,782.55
27x24	9202724	\$10,812.42	\$13,515.55	\$15,137.38	\$16,894.42	\$12,067.45
27	92027	\$11,727.52	\$14,388.99	\$16,418.52	\$18,324.24	\$13,088.75
30x4	920304	\$7,081.64	\$8,852.06	\$9,914.30	\$11,065.07	\$7,686.86
30x6	920306	\$7,398.25	\$9,247.81	\$10,357.56	\$11,559.76	\$8,041.53
30x8	920308	\$8,704.45	\$10,880.57	\$12,186.24	\$13,600.71	\$9,714.79
30x10	9203010	\$8,830.29	\$11,037.87	\$12,362.41	\$13,797.34	\$9,855.25
30x12	9203012	\$9,304.03	\$11,630.05	\$13,025.65	\$14,537.55	\$10,383.93
30x15	9203015	\$9,866.05	\$12,678.24	\$13,812.46	\$15,847.79	\$11,319.85
30x18	9203018	\$10,922.58	\$13,653.24	\$15,291.61	\$17,066.54	\$12,190.40
30x21	9203021	\$12,415.00	\$15,518.79	\$17,381.01	\$19,398.46	\$13,856.03
30x24	9203024	\$13,894.55	\$17,368.19	\$19,869.21	\$21,710.24	\$15,507.31
30x27	9203027	\$15,070.55	\$18,838.17	\$21,098.77	\$23,547.73	\$16,819.82
30	92030	\$18,838.13	\$23,547.68	\$26,373.38	\$29,010.08	\$21,024.72
36x4	920364	\$8,852.06	\$11,063.93	\$12,392.89	\$13,831.33	\$8,799.21
36x6	920366	\$9,247.80	\$11,559.69	\$12,946.92	\$14,449.71	\$9,536.81
36x8	920368	\$10,880.55	\$13,600.72	\$15,232.77	\$17,000.90	\$9,849.59
36x10	9203610	\$11,037.85	\$13,759.91	\$15,453.00	\$17,246.67	\$11,456.80
36x12	9203612	\$11,630.05	\$14,537.55	\$16,282.07	\$18,171.93	\$11,851.15
36x15	9203615	\$12,678.22	\$15,847.79	\$17,749.51	\$19,809.75	\$12,876.38
36x18	9203618	\$13,653.22	\$17,066.54	\$19,114.51	\$21,333.16	\$14,161.86
36x21	9203621	\$15,518.77	\$19,397.44	\$21,726.28	\$24,248.09	\$15,673.61
36x24	9203624	\$17,368.18	\$21,708.67	\$24,315.45	\$27,137.80	\$16,149.29
36x27	9203627	\$18,838.17	\$23,546.42	\$26,373.45	\$29,434.65	\$20,365.92
36x30	9203630	\$23,547.73	\$29,433.96	\$32,966.82	\$36,793.29	\$23,180.64
36	92036	\$29,434.65	\$36,792.45	\$41,208.51	\$45,991.64	\$29,025.60

WYE

FEMALE X FEMALE X FEMALE

(WITH IPS OUTLET)

§ Available with Dissimilar Outlet. § 10"-12" Molded Fittings Available—Contact Factory.

Size	Part Number	SDR35		SDR26/35 HWS		Profile: (23)
		SW: (81)	GSK: (79)	SW: (82)	GSK: (80)	
6x4	9206-4IPS	\$65.86	\$146.44	\$152.67	\$156.69	NA
6	9206-IPS	\$78.34	\$160.51	\$173.77	\$171.75	NA
8x4	9208-4IPS	\$142.80	\$174.58	\$217.70	\$186.80	\$125.80
8x6	9208-6IPS	\$172.37	\$227.26	\$250.40	\$243.17	\$150.05
8	9208-IPS	\$261.75	\$281.15	\$442.08	\$446.07	\$268.58
10x4	92010-4IPS	\$418.79	\$429.40	\$552.84	\$580.55	\$382.68
10x6	92010-6IPS	\$447.06	\$438.51	\$561.88	\$591.71	\$389.12
10x8	92010-8IPS	\$677.84	\$660.93	\$872.49	\$880.53	\$631.43
10	92010-IPS	\$774.73	\$830.20	\$1,055.94	\$1,063.94	\$793.15
12x4	92012-4IPS	\$599.62	\$612.62	\$758.23	\$785.92	\$551.04
12x6	92012-6IPS	\$646.75	\$648.20	\$768.23	\$797.97	\$568.22
12x8	92012-8IPS	\$868.21	\$912.31	\$1,146.08	\$1,154.08	\$871.59
12x10	92012-10IPS	\$1,051.77	\$1,115.12	\$1,409.49	\$1,417.52	\$1,065.34
12	92012-IPS	\$1,241.53	\$1,160.92	\$1,499.31	\$1,507.35	\$1,109.11
15x4	92015-4IPS	\$899.46	\$911.65	\$1,086.13	\$1,113.79	\$831.22
15x6	92015-6IPS	\$1,042.64	\$1,105.28	\$1,302.76	\$1,332.59	\$995.46
15x8	92015-8IPS	\$1,272.46	\$1,193.21	\$1,453.68	\$1,461.69	\$1,139.96
15x10	92015-10IPS	\$1,488.77	\$1,433.99	\$1,748.71	\$1,756.73	\$1,369.93
15x12	92015-12IPS	\$1,672.18	\$1,597.42	\$1,949.00	\$1,957.01	\$1,526.12
18x4	92018-4IPS	\$2,040.34	\$2,070.55	\$2,740.93	\$2,768.62	\$1,909.28
18x6	92018-6IPS	\$2,071.15	\$2,099.05	\$2,776.56	\$2,806.36	\$1,934.11
18x8	92018-8IPS	\$2,303.09	\$2,152.42	\$2,875.22	\$2,883.19	\$2,056.30
18x10	92018-10IPS	\$2,587.49	\$2,418.22	\$3,231.22	\$3,239.25	\$2,310.29
18x12	92018-12IPS	\$2,780.37	\$2,598.47	\$3,472.75	\$3,480.73	\$2,482.47
21x4	92021-4IPS	\$3,536.73	\$3,323.71	\$4,766.57	\$4,794.26	\$3,075.34
21x6	92021-6IPS	\$3,791.03	\$3,563.34	\$5,109.91	\$5,139.24	\$3,296.57
21x8	92021-8IPS	\$4,275.44	\$3,995.74	\$5,763.88	\$5,771.81	\$3,817.33
21x10	92021-10IPS	\$4,819.17	\$4,503.89	\$6,497.88	\$6,505.86	\$4,302.82
21x12	92021-12IPS	\$5,211.91	\$4,870.94	\$7,028.10	\$7,036.06	\$4,653.49
24x4	92024-4IPS	\$5,334.51	\$5,003.94	\$7,193.59	\$7,221.27	\$4,638.77
24x6	92024-6IPS	\$6,105.96	\$5,726.83	\$8,234.99	\$8,264.89	\$5,309.55
24x8	92024-8IPS	\$6,585.09	\$6,154.29	\$8,881.80	\$8,889.83	\$5,879.55
24x10	92024-10IPS	\$6,656.34	\$6,220.88	\$8,978.04	\$8,986.05	\$5,943.15
24x12	92024-12IPS	\$6,796.52	\$6,351.89	\$9,167.21	\$9,175.23	\$6,068.34
27x4	92027-4IPS	\$6,878.95	\$6,447.33	CF	\$11,204.58	\$5,981.65
27x6	92027-6IPS	\$7,196.45	\$6,745.97	CF	\$11,639.01	\$6,257.79
27x8	92027-8IPS	\$8,467.13	\$7,913.21	CF	CF	\$7,559.94
27x10	92027-10IPS	\$8,589.48	\$8,027.55	CF	CF	\$7,669.15
27x12	92027-12IPS	\$9,050.25	\$8,458.18	CF	CF	\$8,080.59
30x4	92030-4IPS	\$8,852.06	\$8,272.95	CF	CF	\$7,686.86
30x6	92030-6IPS	\$9,247.81	\$8,642.82	CF	CF	\$8,041.53
30x8	92030-8IPS	\$10,880.57	\$10,168.76	CF	CF	\$9,714.79
30x10	92030-10IPS	\$11,037.87	\$10,315.76	CF	CF	\$9,855.25
30x12	92030-12IPS	\$11,630.05	\$10,869.20	CF	CF	\$10,383.93
36x4	92036-4IPS	\$11,063.93	\$10,340.12	CF	CF	\$8,799.21
36x6	92036-6IPS	\$11,559.69	\$10,803.45	CF	CF	\$9,536.81
36x8	92036-8IPS	\$13,600.72	\$12,710.96	CF	CF	\$9,849.59
36x10	92036-10IPS	\$13,759.91	\$12,859.73	CF	CF	\$11,456.80
36x12	92036-12IPS	\$14,537.55	\$13,586.49	CF	CF	\$11,851.15

WYE

DOUBLE

FEMALE X FEMALE X FEMALE X FEMALE

§ Available with Dissimilar Outlet. § 10"-12" Molded Fittings Available—Contact Factory.

Size	Part Number	SDR35		SDR26/35 HWS		Profile: (23)
		SW: (81)	GSK: (79)	SW: (82)	GSK: (80)	
6x4	94064	\$107.62	\$136.24	\$188.24	\$136.24	NA
6	9406	\$177.56	\$261.40	\$265.59	\$269.59	NA
8x4	94084	\$267.44	\$282.94	\$273.00	\$277.01	\$282.94
8x6	94086	\$326.98	\$327.08	\$327.61	\$331.58	\$327.08
8	9408	\$397.32	\$618.42	\$541.79	\$545.81	\$618.43
10x4	940104	\$580.24	\$811.95	\$925.21	\$933.21	\$811.94
10x6	940106	\$629.41	\$840.76	\$973.19	\$981.18	\$840.77
10x8	940108	\$834.78	\$1,206.86	\$1,376.89	\$1,384.85	\$1,206.86
10	94010	\$871.85	\$1,319.58	\$1,559.54	\$1,567.56	\$1,319.57

WYE

DOUBLE

FEMALE X FEMALE X FEMALE X FEMALE

Size	Part Number	SDR35		SDR26/35 HWS		Profile: (23)
		SW: (81)	GSK: (79)	SW: (82)	GSK: (80)	
12x4	940124	\$671.87	\$1,026.96	\$1,174.50	\$1,182.51	\$1,026.96
12x6	940126	\$856.08	\$1,079.06	\$1,249.43	\$1,257.45	\$1,079.07
12x8	940128	\$964.12	\$1,475.23	\$1,689.11	\$1,697.13	\$1,475.23
12x10	9401210	\$1,307.69	\$1,669.96	\$1,953.26	\$1,961.23	\$1,669.96
12	94012	\$1,426.75	\$1,754.03	\$2,116.68	\$2,124.62	\$1,754.03
15x4	940154	\$1,394.17	\$1,518.65	\$1,698.10	\$1,706.10	\$1,518.64
15x6	940156	\$1,611.29	\$1,731.17	\$1,937.04	\$1,945.00	\$1,731.16
15x8	940158	\$1,777.31	\$1,815.86	\$2,075.92	\$2,083.94	\$1,815.87
15x10	9401510	\$1,955.90	\$2,080.57	\$2,418.26	\$2,426.25	\$2,080.57
15x12	9401512	\$2,171.40	\$2,458.10	\$3,031.62	\$3,039.58	\$2,458.10
15	94015	\$2,301.26	\$2,687.88	\$3,365.42	\$3,373.44	\$2,687.88
18x4	940184	\$2,646.01	\$2,838.86	\$3,546.15	\$3,554.19	\$2,838.87
18x6	940186	\$2,777.82	\$2,980.16	\$3,722.82	\$3,730.80	\$2,980.16
18x8	940188	\$3,036.73	\$3,257.20	\$4,069.57	\$4,077.58	\$3,257.19
18x10	9401810	\$3,460.67	\$5,399.51	\$4,844.93	CF	\$5,399.50
18x12	9401812	\$3,722.40	\$5,546.91	\$5,211.35	CF	\$5,546.91
18x15	9401815	\$3,976.83	\$5,919.33	\$5,567.56	CF	\$5,919.33
18	94018	\$4,740.22	\$6,240.32	\$6,636.31	CF	\$6,240.33
21x4	940214	\$3,271.64	\$3,665.44	\$4,580.30	\$4,948.32	\$4,356.85
21x6	940216	\$3,533.38	\$3,965.08	\$4,946.73	\$5,352.83	\$4,677.19
21x8	940218	\$4,049.55	\$4,542.50	\$5,669.37	\$6,132.36	\$5,828.38
21x10	9402110	\$6,223.38	\$6,588.47	\$8,712.72	CF	\$6,588.46
21x12	9402112	\$6,746.87	\$7,049.89	\$9,445.61	CF	\$7,049.89
21x15	9402115	\$7,717.44	\$7,871.14	\$12,655.98	CF	\$7,871.14
21x18	9402118	\$8,687.98	\$8,976.56	\$12,163.18	CF	\$8,932.26
21	94021	\$9,653.32	\$11,848.16	\$17,099.71	CF	\$11,848.17
24x4	940244	\$5,009.21	\$5,619.52	\$7,012.90	\$7,586.33	\$6,174.16
24x6	940246	\$5,598.10	\$6,279.65	\$7,837.34	\$8,477.47	\$7,005.48
24x8	940248	\$5,736.23	\$6,437.94	\$8,030.72	\$8,691.17	\$7,961.37
24x10	9402410	\$8,746.18	\$9,449.00	\$12,244.66	CF	\$9,448.99
24x12	9402412	\$8,927.95	\$9,615.11	\$12,499.13	CF	\$9,615.11
24x15	9402415	\$8,993.28	\$9,993.44	\$12,590.60	CF	\$9,993.44
24x18	9402418	\$11,752.38	\$13,822.85	\$16,453.33	CF	\$13,822.85
24x21	9402421	\$14,511.48	\$14,957.88	\$20,316.08	CF	\$14,957.88
24	94024	\$15,347.56	\$18,307.28	\$21,486.58	CF	\$18,307.28
27x4	940274	\$5,698.62	\$7,123.29	\$7,978.07	CF	\$9,343.66
27x6	940276	\$5,935.12	\$7,418.92	\$8,309.16	CF	\$9,881.64
27x8	940278	\$6,061.80	\$7,577.27	\$8,486.52	CF	\$11,098.82
27x10	9402710	\$6,805.56	\$16,152.90	\$9,527.78	CF	\$16,152.90
27x12	9402712	\$7,539.65	\$17,642.36	\$10,555.51	CF	\$17,642.36
27x15	9402715	\$8,630.39	\$19,927.91	\$12,082.55	CF	\$19,927.91
27x18	9402718	\$9,426.64	\$20,428.69	\$13,197.29	CF	\$20,428.69
27x21	9402721	\$10,733.00	\$21,032.19	\$15,026.20	CF	\$21,032.19
27x24	9402724	\$11,778.09	\$26,027.04	\$16,489.33	CF	\$26,027.04
27	94027	\$12,474.86	\$26,758.96	\$17,464.81	CF	\$26,758.96
30x4	940304	\$7,123.29	\$11,679.58	\$9,972.60	CF	\$11,679.58
30x6	940306	\$7,418.90	\$12,352.05	\$10,386.45	CF	\$12,352.05
30x8	940308	\$7,577.26	\$13,873.52	\$10,608.17	CF	\$13,873.52
30x10	9403010	\$8,506.96	\$20,191.14	\$11,909.75	CF	\$20,191.14
30x12	9403012	\$9,424.57	\$22,052.97	\$13,194.40	CF	\$22,052.97
30x15	9403015	\$10,787.98	\$24,909.90	\$15,103.17	CF	\$24,909.90
30x18	9403018	\$11,783.29	\$25,535.86	\$16,496.60	CF	\$25,535.86
30x21	9403021	\$13,472.39	\$26,290.27	\$18,861.35	CF	\$26,290.27
30x24	9403024	\$14,722.64	\$32,533.82	\$20,611.70	CF	\$32,533.82
30x27	9403027	\$18,403.29	\$40,667.27	\$25,764.61	CF	\$40,667.27
30	94030	\$23,004.11	\$50,834.08	\$32,205.75	CF	\$50,834.08
36x4	940364	\$8,904.08	\$14,599.46	\$12,465.71	\$21,554.14	\$14,599.46
36x6	940366	\$9,273.62	\$15,440.04	\$12,983.07	\$22,989.63	\$15,440.04
36x8	940368	\$9,471.56	\$17,341.90	\$13,260.19	\$26,656.24	\$17,341.90
36x10	9403610	\$10,633.71	\$25,238.92	\$14,887.20	CF	\$25,238.92
36x12	9403612	\$11,780.70	\$27,566.21	\$16,492.98	CF	\$27,566.21
36x15	9403615	\$13,484.99	\$31,137.37	\$18,878.98	CF	\$31,137.37
36x18	9403618	\$14,729.11	\$31,919.83	\$20,620.74	CF	\$31,919.83
36x21	9403621	\$16,770.31	\$32,862.81	\$23,478.43	CF	\$32,862.81
36x24	9403624	\$18,403.29	\$40,667.27	\$25,764.61	CF	\$40,667.27
36x27	9403627	\$23,004.11	\$50,834.08	\$32,205.75	CF	\$50,834.08
36x30	9403630	\$28,755.16	\$63,542.61	\$40,257.23	CF	\$63,542.61
36	94036	\$35,943.95	\$79,428.26	\$50,321.54	CF	\$79,428.26

SEWER & PROFILE FITTINGS



Frequently Asked Questions

Q: What about surge pressures in PVC and HDPE piping?

A: Surge pressures in HDPE & PVC are significantly lower than in DI pipe due to the lower value of dynamic modulus. For example, in a typical 8" line a velocity change of 5 fps would cause a 51 psi surge in HDPE DR17 pipe, a 87 psi surge in PVC DR18 pipe, and a 262 psi surge in DI Class 350 lined pipe. Lower surge pressures often mean longer life for pumps and valves in an HDPE pipeline, as well as lower pressure class pipes. The "pressure ratings" of our PVC and HDPE fittings allow for occasional and recurring surges.

Q: How does use of plastic pipe save an owner money?

A: Both PVC and HDPE are attractive due to their high strength-to-weight ratios. This translates into everything from smaller machinery needed for handling and installation to fewer lower-back-pain workers comp claims. Further, their non-metallic nature means that they will perform satisfactorily for longer than other piping materials due to elimination of interior corrosion and tuberculation and exterior reaction to "hot" soils and electro-galvanic corrosion. Further, the very low leak rates for PVC and HDPE piping recommend these materials to specifying engineers and long-term cost-savvy owners for both pipe and fittings.

Q: Where can I find design manuals for PVC and HDPE pipe and fittings?

A: The trade associations for each material are great resources for technical resources. The Plastic Pipe Institute (plasticpipe.org) represents the HDPE piping industry and The Uni-Bell PVC Pipe Association (uni-bell.org) represents the PVC pipe industry. Each publishes a handbook of design and construction as well as technical papers and research findings.

Q: What's the difference between PVC solvent-cement and glue?

A: In common language, PVC solvent-cement is often misspoken of as a "glue" but this is not accurate and does not give it its proper due. PVC solvent cement is made of two basic components, a solvent that softens and "opens up" PVC pipe and fittings as well as PVC resin dissolved in the solvent. When applied at a PVC piping joint, the solvent softens the two mating surfaces while the PVC resin impregnates both surfaces. Once cured, this joint is homogeneous in cross section—it is a true weld where the two pieces have become one. This differs from a glue which is strictly an adhesive simply grabbing and sticking to each surface. Properly solvent-cemented joints are fully restrained and equal in strength to the piping material itself.

PVC FITTINGS

CSA APPROVED SEWER FITTINGS



Specified Fittings



Specified Fittings

ADAPTER

FEMALE X FIPT

- Available in Larger, Reducing Sizes. ▪ Available with Countersunk Plug.
- Available with Dissimilar Outlet. ▪ O-Ring Style Available—Please Contact Factory.

SDR35			
Size	PartNumber	SW: (81)	GSK: (79)
4	1304	\$13.32	CF
6	1306	\$62.67	CF
8	1308	\$197.66	CF
10	13010	\$759.18	CF
12	13012	\$1,101.43	CF
15x16	13015-16IPS	\$2,220.61	CF
18	13018	\$3,552.97	CF
21x20	13021-20IPS	\$4,725.49	CF
24	13024	\$5,464.95	CF

FEMALE X MIPT

- Available in Larger, Reducing Sizes. ▪ Available with Countersunk Plug.
- Available with Dissimilar Outlet. ▪ O-Ring Style Available—Please Contact Factory.

SDR35			
Size	PartNumber	SW: (81)	GSK: (79)
4	1504	\$39.79	CF
6	1506	\$186.86	CF
8	1508	\$395.32	CF
10	15010	\$1,156.75	CF
12	15012	\$1,503.59	CF

SLIP BELL X GASKET

- Available in Smaller and Larger Sizes. ▪ Available in Reducing Sizes.

SDR35			
Size	PartNumber	SW: (81)	GSK: (79)
4	1354	CF	\$48.68
6x4	13564	CF	\$68.93
6	1356	CF	\$89.18
8	1358	CF	\$195.10

SEWER X IPS

FEMALE X FEMALE



- Available with Dissimilar Outlet. ▪ Available with Stop.

SDR35			
Size	PartNumber	SW: (81)	GSK: (79)
4	1054	\$16.32	\$63.27
6x4	10564	\$64.99	\$78.38
6	1056	\$53.63	\$125.36
8	1058	\$149.47	\$232.19
10	10510	\$187.37	\$348.04
12	10512	\$257.94	\$512.26
15x14	10515-14IPS	\$1,500.36	\$1,702.77
15x16	10515-16IPS	\$1,875.41	\$2,128.51
18	10518	\$2,995.71	\$3,452.91
21x20	10521-20IPS	\$3,750.68	\$3,984.85

MALE X FEMALE

- Available in Smaller and Larger Sizes. ▪ Available in Reducing Sizes.

SDR35			
Size	PartNumber	SW: (81)	GSK: (79)
4x1.5	1714-1.5IPS	\$27.89	CF
4x2	1714-2IPS	\$27.42	CF
4x3	1714-3IPS	\$50.67	CF
4	1714	\$32.45	\$56.42
6x4	17164	\$55.99	CF
6	1716	\$74.07	\$117.38
8	1718	\$140.45	\$207.32
10	17110	\$181.95	\$310.71
12	17112	\$250.24	\$457.39
15x14	17115-14IPS	\$1,500.36	\$1,702.77
15x16	17115-16IPS	\$1,875.41	\$2,128.51
15	17115	\$2,995.71	\$3,452.91
18	17118	\$3,750.68	\$3,984.85

FEMALE X MALE

- Available in Smaller and Larger Sizes. ▪ Available in Reducing Sizes.

SDR35			
Size	PartNumber	SW: (81)	GSK: (79)
4	1344	\$12.74	\$76.00
6	1346	\$54.92	\$106.05
8	1348	\$149.47	\$207.32
10	13410	\$187.37	\$310.71
12	13412	\$291.72	\$457.39

IPS X SEWER

MALE X FEMALE

SLEEVE

- Available in Smaller and Larger Sizes.

SDR35			
Size	PartNumber	SW: (81)	GSK: (79)
4	736604-SWR	\$14.09	\$62.04
6	736606-SWR	\$12.74	\$106.06
8	736608-SWR	\$54.92	\$259.30
10	7366010-SWR	\$234.18	\$430.47
12	7366012-SWR	\$371.80	\$608.72

FEMALE X MALE



SDR35			
Size	PartNumber	SW: (81)	GSK: (79)
4	1714	\$30.85	\$38.57
6	1716	\$57.72	\$72.14
8	1718	\$133.63	\$167.05
10	17110	\$138.30	\$172.92
12	17112	\$210.42	\$263.10
15	17115	\$318.11	\$397.72
18	17118	\$699.17	\$874.11
21	17121	\$769.19	\$961.56
24	17124	\$1,390.45	\$1,738.32
27	17127	\$1,620.36	\$2,155.07
30	17130	\$2,074.06	\$2,758.50
36	17136	\$2,654.79	CF

ADAPTER

CLEANOUT

MALE X FIPT



▪ Available in Larger Sizes. ▪ O-Ring Style Available—Please Contact Factory.

SDR35			
Size	PartNumber	SW: (81)	GSK: (79)
4	1104	\$10.43	CF
6	1106	\$65.14	CF
8	1108	\$273.96	CF
10	11010	\$1,183.58	CF
12	11012	\$1,503.59	CF
15x14	11015-14IPS	\$1,862.10	CF
15x16	11015-16IPS	\$2,220.61	CF
18	11018	\$3,552.97	CF
21x20	11021-20IPS	\$4,725.49	CF
24	11024	\$6,284.84	CF

ADAPTER

SANDED MANHOLE

FEMALE X FEMALE



▪ Available with Dissimilar Outlet. ▪ Available with Stop.

SDR35			
Size	PartNumber	SW: (81)	GSK: (79)
4	1664	CF	\$65.02
6	1666	CF	\$128.04
8	1668	CF	\$180.96
10	16610	CF	\$369.73
12	16612	CF	\$757.94
15	16615	CF	\$997.76
18	16618	CF	\$1,030.40
21	16621	CF	\$1,406.84
24	16624	CF	\$2,342.81
27	16627	CF	\$2,720.85
30	16630	CF	\$3,862.65
36	16636	CF	\$5,322.22

FEMALE X MALE

NONSTOP



▪ Available with Dissimilar Outlet. ▪ Available with Stop.

SDR35			
Size	PartNumber	SW: (81)	GSK: (79)
4	1644	CF	\$55.12
6	1646	CF	\$103.91
8	1648	CF	\$115.98
10	16410	CF	\$210.87
12	16412	CF	\$309.19
15	16415	CF	\$395.73
18	16418	CF	\$795.99
21	16421	CF	\$1,125.47
24	16424	CF	\$1,874.25
27	16427	CF	\$2,176.68
30	16430	CF	\$3,090.11
36	16436	CF	\$3,475.65

CAP

FEMALE



▪ Available Tapped Concentrically and Eccentrically. ▪ Available in Flat Style.

SDR35			
Size	PartNumber	SW: (81)	GSK: (79)
4	1904	\$5.86	\$17.89
6	1906	\$21.44	\$33.55
8	1908	\$70.19	\$90.58
10	19010	\$231.18	\$283.35
12	19012	\$292.67	\$425.64
15	19015	\$504.83	\$688.36
18	19018	\$890.80	\$1,000.73
21	19021	\$1,954.77	\$2,170.65
24	19024	\$2,231.11	\$2,506.85
27	19027	\$2,441.80	\$3,161.73
30	19030	\$3,486.21	\$4,062.99
36	19036	\$4,357.74	\$6,950.52

PLUG

SQUARE HEAD

MIPT

▪ Available in Smaller and Larger Sizes, and Tapped Concentrically and Eccentrically.

SDR35			
Size	PartNumber	SW: (81)	GSK: (79)
3	5703	\$13.22	CF
4	5704	\$7.44	CF
6	5706	\$35.08	CF
8	5708	\$138.85	CF
10	57010	\$273.28	CF
12	57012	\$334.18	CF

COUNTERSUNK

MIPT

▪ Available in Smaller and Larger Sizes, and Tapped Concentrically and Eccentrically.

SDR35			
Size	PartNumber	SW: (81)	GSK: (79)
4	5504	\$18.66	CF
6	5506	\$48.01	CF
8	5508	\$190.13	CF
10	55010	\$421.28	CF
12	55012	\$608.96	CF

PLUG

MALE

▪ Available Tapped Concentrically and Eccentrically.

SDR35			
Size	PartNumber	SW: (81)	GSK: (79)
4	5604	CF	\$13.53
6	5606	CF	\$20.72
8	5608	CF	\$73.48
10	56010	CF	\$244.82
12	56012	CF	\$292.60
15	56015	CF	\$575.82
18	56018	CF	\$810.75
21	56021	CF	\$1,603.66
24	56024	CF	\$2,411.37
27	56027	CF	\$2,948.51
30	56030	CF	\$3,774.64
36	56036	CF	\$6,746.53

COUPLING

REPAIR

FEMALE X FEMALE



SDR35			
Size	PartNumber	SW: (81)	GSK: (79)
4	2204	CF	\$34.27
6	2206	CF	\$68.42
8	2208	CF	\$116.22
10	22010	CF	\$257.94
12	22012	CF	\$374.80
15	22015	CF	\$775.43
18	22018	CF	\$1,509.47
21	22021	CF	\$2,572.42
24	22024	CF	\$3,747.56
27	22027	CF	\$4,226.11
30	22030	CF	\$5,430.73
36	22036	CF	\$6,951.32

RISER

FEMALE X FEMALE

DEEP SOCKET

▪ Available in Larger Sizes.

SDR35			
Size	PartNumber	SW: (81)	GSK: (79)
4	2444	CF	\$203.49
6	2446	CF	\$276.35
8	2448	CF	\$473.31

FEMALE X MALE

DEEP SOCKET

▪ Available in Larger Sizes.

SDR35			
Size	PartNumber	SW: (81)	GSK: (79)
4	2464	CF	\$197.37
6	2466	CF	\$268.11
8	2468	CF	\$459.12

STOP

FEMALE X FEMALE



▪ Available in Reducing Sizes. ▪ Available in Tapped Style.

SDR35			
Size	PartNumber	SW: (81)	GSK: (79)
4	2404	\$6.69	\$34.27
6	2406	\$24.48	\$68.42
8	2408	\$76.15	\$116.22
10	24010	\$215.67	\$257.94
12	24012	\$367.17	\$374.80
15	24015	\$643.02	\$775.43
18	24018	\$1,337.20	\$1,509.47
21	24021	\$2,333.30	\$2,572.48
24	24024	\$3,355.50	\$3,747.56
27	24027	\$4,194.35	\$4,226.11
30	24030	\$5,242.94	\$5,430.73
36	24036	\$6,553.67	\$6,951.32

CROSS

FEMALE X FEMALE X FEMALE X FEMALE



▪ Available in Smaller and Larger Sizes. ▪ Available with Threaded Outlets.

SDR35			
Size	PartNumber	SW: (81)	GSK: (79)
4	2604	\$39.17	\$171.66
6x4	26064	\$139.27	\$176.64
6	2606	\$168.41	\$224.35
8x4	26084	\$254.50	\$289.44
8x6	26086	\$268.35	\$364.23
8	2608	\$327.09	\$542.48
10x4	260104	\$505.76	\$733.31
10x6	260106	\$577.82	\$761.57
10x8	260108	\$802.35	\$1,048.50
10	26010	\$915.64	\$1,247.97
12x4	260124	\$603.60	\$797.39
12x6	260126	\$719.78	\$936.58
12x8	260128	\$917.85	\$1,088.15
12x10	2601210	\$1,173.24	\$1,263.22
12	26012	\$1,304.54	\$1,470.45
15x4	260154	\$1,273.75	\$1,370.87
15x6	260156	\$1,479.43	\$1,583.94
15x8	260158	\$1,548.71	\$1,664.96
15x10	2601510	\$1,590.33	\$1,709.58
15x12	2601512	\$1,701.17	\$1,828.02
15	26015	\$2,043.10	\$2,194.05
18x4	260184	\$2,566.63	\$2,754.30
18x6	260186	\$2,864.04	\$3,143.73
18x8	260188	\$2,995.90	\$3,284.64
18x10	2601810	\$3,616.90	\$3,991.79
18x12	2601812	\$3,822.90	\$4,373.02
18x15	2601815	\$4,419.12	\$4,980.12
18	26018	\$5,917.57	\$6,759.52
21x6	260216	\$3,307.95	\$3,942.89
21x8	260218	\$3,787.83	\$4,517.03
21x10	2602110	\$4,165.90	\$5,164.91
21x12	2602112	\$4,580.27	\$5,684.29
21x15	2602115	\$5,038.30	\$6,240.59
21x18	2602118	\$5,539.95	\$6,874.58
21	26021	\$6,928.58	\$6,246.07
24x6	260246	\$5,241.90	\$6,401.73
24x8	260248	\$5,365.48	\$7,992.65
24x10	2602410	\$6,441.49	\$9,586.84
24x12	2602412	\$7,728.33	\$11,505.68
24x15	2602415	\$9,276.86	\$13,806.79
24x18	2602418	\$11,130.84	\$16,569.59
24x21	2602421	\$13,362.78	\$20,710.19
24	26024	\$16,699.84	\$19,355.32
27x6	260276	\$5,546.09	\$6,933.54
27x8	260278	\$5,664.45	\$7,081.56
27x10	2602710	\$6,147.23	\$8,836.63
27x12	2602712	\$7,831.80	\$11,258.24
27x15	2602715	\$8,851.99	\$12,724.74
27x18	2602718	\$10,623.41	\$15,271.16
27x21	2602721	\$12,751.07	\$18,329.68
27x24	2602724	\$15,300.33	\$21,994.23
27	26027	\$19,124.09	\$27,490.87

ELBOW

5 DEGREE

FEMALE X FEMALE



▪ Available with Dissimilar Outlet.

SDR35			
Size	PartNumber	SW: (81)	GSK: (79)
4	3004	\$71.26	\$75.27
6	3006	\$90.66	\$103.89
8	3008	\$125.73	\$159.07
10	30010	\$390.05	\$435.14
12	30012	\$567.43	\$567.43
15	30015	\$1,247.77	\$1,500.80
18	30018	\$1,534.18	\$2,193.47
21	30021	\$2,835.51	\$3,112.61
24	30024	\$4,040.72	\$4,481.83
27	30027	\$4,611.23	\$5,346.42
30	30030	\$6,313.64	\$6,870.08
36	30036	\$7,892.06	\$8,792.02

11-1/4 DEGREE

FEMALE X FEMALE

SDR35			
Size	PartNumber	SW: (81)	GSK: (79)
4	3104	\$71.26	\$75.27
6	3106	\$90.66	\$103.89
8	3108	\$125.73	\$159.07
10	31010	\$390.05	\$435.14
12	31012	\$567.43	\$567.43
15	31015	\$1,247.77	\$1,500.80
18	31018	\$1,534.18	\$2,193.47
21	31021	\$2,835.51	\$3,112.61
24	31024	\$4,040.72	\$4,481.83
27	31027	\$4,611.23	\$5,346.42
30	31030	\$6,313.64	\$6,870.08
36	31036	\$7,892.06	\$8,792.02

22-1/2 DEGREE

FEMALE X FEMALE

SDR35			
Size	PartNumber	SW: (81)	GSK: (79)
4	3304	\$11.09	\$27.69
6	3306	\$46.40	\$54.57
8	3308	\$125.73	\$158.94
10	33010	\$390.05	\$435.14
12	33012	\$567.43	\$567.43
15	33015	\$1,247.77	\$1,500.80
18	33018	\$1,534.18	\$2,193.47
21	33021	\$2,835.51	\$3,112.68
24	33024	\$4,040.72	\$4,481.83
27	33027	\$4,611.23	\$5,346.42
30	33030	\$6,313.64	\$6,870.32
36	33036	\$7,892.06	\$8,792.02

30 DEGREE

FEMALE X FEMALE

▪ Available with Dissimilar Outlet.

SDR35			
Size	PartNumber	SW: (81)	GSK: (79)
4	3404	\$71.26	\$75.27
6	3406	\$90.66	\$103.89
8	3408	\$125.73	\$159.07
10	34010	\$390.05	\$435.14
12	34012	\$567.43	\$567.43
15	34015	\$1,247.77	\$1,500.80
18	34018	\$1,534.18	\$2,193.47
21	34021	\$2,835.51	\$3,112.61
24	34024	\$4,040.72	\$4,481.83
27	34027	\$4,611.23	\$5,346.42
30	34030	\$6,313.64	\$6,870.08
36	34036	\$7,892.06	\$8,792.02

ELBOW

45 DEGREE

FEMALE X FEMALE

FABRICATED

▪ Available in Larger Sizes. ▪ Available with Dissimilar Outlet.

SDR35			
Size	PartNumber	SW: (81)	GSK: (79)
6	3496F	\$90.66	\$103.89
8	3498F	\$162.44	\$200.28
10	34910F	\$457.78	\$476.72

ELBOW

45 DEGREE

FEMALE X FEMALE

▪ Available with Dissimilar Outlet.



SDR35			
Size	PartNumber	SW: (81)	GSK: (79)
4	3504	\$9.81	\$27.74
6	3506	\$39.91	\$56.29
8	3508	\$108.66	\$157.55
10	35010	\$381.53	\$408.77
12	35012	\$592.52	\$593.74
15	35015	\$1,324.20	\$1,329.51
18	35018	\$1,534.18	\$2,127.93
21	35021	\$2,835.51	\$3,603.86
24	35024	\$4,040.72	\$4,920.09
27	35027	\$4,611.23	\$5,346.21
30	35030	\$6,313.64	\$6,870.08
36	35036	\$7,892.06	\$8,792.02

ELBOW

90 DEGREE

FEMALE X FEMALE

REGULAR



▪ Available with Dissimilar Outlet.

SDR35			
Size	PartNumber	SW: (81)	GSK: (79)
4	3704	\$13.32	\$34.90
6	3706	\$36.98	\$64.20
8	3708	\$142.46	\$177.56
10	37010	\$537.88	\$597.20
12	37012	\$755.45	\$772.87
15	37015	\$1,603.59	\$1,631.43
18	37018	\$2,313.79	\$2,759.65
21	37021	\$3,561.47	\$4,739.92
24	37024	\$4,932.39	\$6,337.63
27	37027	\$6,458.44	\$7,237.42
30	37030	\$7,258.41	\$9,073.02
36	37036	\$9,290.76	\$12,737.01

FABRICATED

▪ Available in Larger Sizes. ▪ Available with Dissimilar Outlet.

SDR35			
Size	PartNumber	SW: (81)	GSK: (79)
6	3696F	\$99.90	\$103.89
8	3698F	\$171.59	\$200.28
10	36910F	\$587.07	\$476.72

5 DEGREE

FEMALE X MALE



SDR35			
Size	PartNumber	SW: (81)	GSK: (79)
4	3954	\$68.01	\$71.94
6	3956	\$69.28	\$98.63
8	3958	\$133.65	\$166.10
10	39510	\$375.56	\$423.35
12	39512	\$554.36	\$555.26
15	39515	\$1,193.93	\$1,199.12
18	39518	\$1,534.18	\$1,830.39
21	39521	\$2,835.51	\$3,112.61
24	39524	\$4,040.72	\$4,481.83
27	39527	\$4,611.23	\$5,346.42
30	39530	\$6,313.64	\$6,870.08
36	39536	\$7,892.06	\$8,792.02

ELBOW

11-1/4 DEGREE

FEMALE X MALE



▪ Available with Dissimilar Outlet.

SDR35			
Size	PartNumber	SW: (81)	GSK: (79)
4	4004	\$68.01	\$71.94
6	4006	\$69.28	\$98.63
8	4008	\$133.65	\$166.10
10	40010	\$375.56	\$423.35
12	40012	\$554.36	\$555.26
15	40015	\$1,193.93	\$1,199.12
18	40018	\$1,534.18	\$1,830.39
21	40021	\$2,835.51	\$3,112.61
24	40024	\$4,040.72	\$4,481.83
27	40027	\$4,611.23	\$5,346.42
30	40030	\$6,313.64	\$6,870.08
36	40036	\$7,892.06	\$8,792.02

22-1/2 DEGREE

FEMALE X MALE



SDR35			
Size	PartNumber	SW: (81)	GSK: (79)
4	4204	\$13.05	\$26.35
6	4206	\$53.07	\$51.79
8	4208	\$133.65	\$166.10
10	42010	\$375.56	\$423.23
12	42012	\$554.36	\$555.26
15	42015	\$1,193.93	\$1,199.12
18	42018	\$1,534.18	\$1,830.39
21	42021	\$2,835.51	\$3,112.68
24	42024	\$4,040.72	\$4,481.77
27	42027	\$4,611.23	\$5,346.42
30	42030	\$6,313.64	\$6,870.32
36	42036	\$7,892.06	\$8,792.02

ELBOW

30 DEGREE

FEMALE X MALE

SDR35			
Size	PartNumber	SW: (81)	GSK: (79)
4	4304	\$68.01	\$71.94
6	4306	\$69.28	\$98.62
8	4308	\$133.65	\$166.10
10	43010	\$375.56	\$423.23
12	43012	\$554.36	\$555.26
15	43015	\$1,193.93	\$1,199.12
18	43018	\$1,534.18	\$1,830.39
21	43021	\$2,835.51	\$3,112.61
24	43024	\$4,040.72	\$4,481.83
27	43027	\$4,611.23	\$5,346.42
30	43030	\$6,313.64	\$6,870.08
36	43036	\$7,892.06	\$8,792.02

ELBOW

45 DEGREE

FEMALE X MALE

LONG TURN

▪ Available in Larger Sizes. ▪ Available with Dissimilar Outlet.

SDR35			
Size	PartNumber	SW: (81)	GSK: (79)
4	4434	\$16.30	\$45.58
6	4436	\$126.28	\$167.43
8	4438	\$336.65	\$372.36

FABRICATED

▪ Available in Larger Sizes. ▪ Available with Dissimilar Outlet.

SDR35			
Size	PartNumber	SW: (81)	GSK: (79)
6	4396F	\$69.28	\$98.63
8	4398F	\$156.30	\$190.50

ELBOW

45 DEGREE

FEMALE X MALE

SDR35			
Size	PartNumber	SW: (81)	GSK: (79)
4	4404	\$12.44	\$24.95
6	4406	\$49.64	\$49.88
8	4408	\$133.10	\$150.51
10	44010	\$367.58	\$402.86
12	44012	\$575.75	\$575.75
15	44015	\$1,041.59	\$1,041.59
18	44018	\$1,534.18	\$1,753.58
21	44021	\$2,835.51	\$3,112.91
24	44024	\$4,040.72	\$4,481.54
27	44027	\$4,611.23	\$5,346.21
30	44030	\$6,313.64	\$6,870.08
36	44036	\$7,892.06	\$8,792.02

ELBOW

90 DEGREE

FEMALE X MALE

REGULAR

SDR35			
Size	PartNumber	SW: (81)	GSK: (79)
4	4604	\$16.26	\$32.09
6	4606	\$63.37	\$67.87
8	4608	\$173.02	\$183.24
10	46010	\$518.58	\$593.17
12	46012	\$755.13	\$755.13
15	46015	\$1,418.13	\$1,488.49
18	46018	\$2,313.79	\$2,550.62
21	46021	\$3,561.47	\$4,285.60
24	46024	\$4,932.39	\$5,291.66
27	46027	\$6,458.44	\$7,351.29
30	46030	\$9,073.05	\$9,073.02
36	46036	\$11,613.49	\$12,737.01

LONG TURN

▪ Available in Larger Sizes. ▪ Available with Dissimilar Outlet.

SDR35			
Size	PartNumber	SW: (81)	GSK: (79)
4	4654	\$16.30	\$45.58
6	4656	\$126.28	\$167.43
8	4658	\$336.65	\$372.36
10	46510	\$773.55	\$794.89
12	46512	\$1,094.55	\$1,135.24

FLANGE

VAN STONE

FLANGE X MALE

150# ANSI BOLT PATTERN x SDR35



▪ Available in Larger Sizes. ▪ Flanges w/ PVC /Stainless Steel Backing Rings
▪ Available—Please Contact Factory.
▪ 14"+ Provided w/ "Thermal Powder Epoxy Coated AWWA Class D DI Backing Flange."

SDR35			
Size	PartNumber	SW: (81)	GSK: (79)
4	5204	\$121.85	CF
6	5206	\$167.26	CF
8	5208	\$256.86	CF
10	52010	\$336.24	CF
12	52012	\$546.08	CF
14x15	5201415	\$1,789.80	CF
16x15	5201615	\$2,358.19	CF
18	52018	\$2,768.35	CF
20x21	5202021	\$3,354.51	CF
24	52024	\$4,516.91	CF

FLANGE X FEMALE

150# ANSI BOLT PATTERN x SDR35



▪ Available in Larger Sizes. ▪ Flanges w/ PVC /Stainless Steel Backing Rings
▪ Available—Please Contact Factory.
▪ 14"+ Provided w/ "Thermal Powder Epoxy Coated AWWA Class D DI Backing Flange."

SDR35			
Size	PartNumber	SW: (81)	GSK: (79)
4	5304	\$121.85	\$128.93
6	5306	\$167.26	\$181.41
8	5308	\$256.86	\$274.06
10	53010	\$336.24	\$367.44
12	53012	\$546.08	\$585.40
14x15	53014-15	\$1,789.80	\$2,632.90
16x15	53016-15	\$2,358.19	\$2,838.85
18	53018	\$2,768.35	\$3,281.90
20x21	53020-21	\$3,354.51	\$4,042.40
24	53024	\$4,516.91	\$4,729.61

REDUCER

CONCENTRIC

FEMALE X FEMALE



▪ Available with Dissimilar Outlet.

SDR35			
Size	PartNumber	SW: (81)	GSK: (79)
6x4	60064	\$32.53	\$98.36
8x4	60084	\$133.85	\$156.15
8x6	60086	\$137.56	\$163.96
10x4	600104	\$275.90	\$359.88
10x6	600106	\$443.65	\$426.32
10x8	600108	\$395.02	\$494.72
12x4	600124	\$467.07	\$523.87
12x6	600126	\$492.08	\$554.24
12x8	600128	\$642.03	\$642.03
12x10	6001210	\$528.87	\$741.23
15x4	600154	\$566.64	\$825.53
15x6	600156	\$711.60	\$867.23
15x8	600158	\$940.49	\$940.49
15x10	6001510	\$1,036.19	\$1,036.19
15x12	6001512	\$1,033.56	\$1,126.65
18x4	600184	\$887.21	\$1,085.83
18x6	600186	\$936.33	\$1,104.54
18x8	600188	\$973.81	\$1,120.87
18x10	6001810	\$1,010.45	\$1,160.32
18x12	6001812	\$1,117.58	\$1,185.03
18x15	6001815	\$1,079.46	\$1,234.29
21x4	600214	\$1,158.56	\$1,566.22
21x6	600216	\$1,178.65	\$1,582.45
21x8	600218	\$1,208.66	\$1,604.92
21x10	6002110	\$1,247.96	\$1,626.16
21x12	6002112	\$1,293.27	\$1,710.47
21x15	6002115	\$1,392.11	\$1,975.71
21x18	6002118	\$1,542.52	\$2,128.87
24x4	600244	\$2,725.96	\$3,264.51
24x6	600246	\$2,745.85	\$3,296.30
24x8	600248	\$2,775.98	\$3,334.26
24x10	6002410	\$2,815.16	\$3,351.32
24x12	6002412	\$2,860.70	\$3,455.50
24x15	6002415	\$2,959.65	\$3,541.54
24x18	6002418	\$3,109.98	\$3,731.68
24x21	6002421	\$3,775.43	\$4,047.55
27x4	600274	\$3,625.53	\$4,341.79
27x6	600276	\$3,651.99	\$4,384.09
27x8	600278	\$3,692.07	\$4,434.57
27x10	6002710	\$3,744.18	\$4,457.28
27x12	6002712	\$3,804.74	\$4,595.82
27x15	6002715	\$3,936.33	\$4,710.26
27x18	6002718	\$4,136.28	\$4,963.14
27x21	6002721	\$5,021.33	\$5,383.25
27x24	6002724	\$5,579.26	\$5,981.40
30x4	600304	\$4,821.96	\$5,774.59
30x6	600306	\$4,857.15	\$5,830.85
30x8	600308	\$4,910.46	\$5,898.00
30x10	6003010	\$4,979.76	\$5,928.18
30x12	6003012	\$5,060.31	\$6,112.45
30x15	6003015	\$5,235.33	\$6,264.65
30x18	6003018	\$5,501.26	\$6,600.98
30x21	6003021	\$6,678.37	\$7,159.74
30x24	6003024	\$7,420.42	\$7,955.27
30x27	6003027	\$8,244.92	\$8,839.19
36x4	600364	\$6,413.22	\$7,680.21
36x6	600366	\$6,460.01	\$7,755.03
36x8	600368	\$6,530.92	\$7,844.34
36x10	6003610	\$6,623.09	\$7,884.49
36x12	6003612	\$6,730.22	\$8,129.56
36x15	6003615	\$6,963.01	\$8,331.99
36x18	6003618	\$7,316.68	\$8,779.31
36x21	6003621	\$8,882.23	\$9,522.46
36x24	6003624	\$9,869.16	\$10,580.52
36x27	6003627	\$10,965.75	\$11,756.12
36x30	6003630	\$12,184.16	\$13,062.36

MALE X FEMALE

(SEB)



▪ Available with Dissimilar Outlet.

SDR35			
Size	PartNumber	SW: (81)	GSK: (79)
6x4	62064	\$31.81	\$49.88
8x4	62084	\$104.83	\$136.24
8x6	62086	\$106.88	\$152.62
10x4	620104	\$229.82	\$357.08
10x6	620106	\$331.85	\$370.96
10x8	620108	\$366.32	\$441.18
12x4	620124	\$387.96	\$476.47
12x6	620126	\$409.93	\$486.81
12x8	620128	\$444.69	\$558.06
12x10	6201210	\$558.57	\$618.84
15x4	620154	\$532.61	\$793.66
15x6	620156	\$590.74	\$823.15
15x8	620158	\$792.98	\$931.74
15x10	6201510	\$885.03	\$939.09
15x12	6201512	\$938.72	\$1,077.06
18x4	620184	\$887.21	\$1,123.60
18x6	620186	\$936.33	\$1,138.68
18x8	620188	\$973.81	\$1,150.94
18x10	6201810	\$1,010.45	\$1,167.13
18x12	6201812	\$1,033.56	\$1,183.58
18x15	6201815	\$1,040.11	\$1,193.25
21x4	620214	\$1,144.67	\$1,300.47
21x6	620216	\$1,172.91	\$1,423.30
21x8	620218	\$1,198.89	\$1,431.80
21x10	6202110	\$1,247.95	\$1,448.87
21x12	6202112	\$1,293.39	\$1,483.52
21x15	6202115	\$1,379.34	\$1,540.69
21x18	6202118	\$1,554.02	\$1,670.64
24x4	620244	\$2,689.62	\$2,885.78
24x6	620246	\$2,721.53	\$2,920.06
24x8	620248	\$2,755.66	\$2,956.42
24x10	6202410	\$2,820.09	\$3,025.46
24x12	6202412	\$2,856.80	\$3,064.77
24x15	6202415	\$2,938.30	\$3,152.04
24x18	6202418	\$3,067.10	\$3,289.64
24x21	6202421	\$3,606.29	\$3,866.58
27x4	620274	\$2,746.75	\$2,946.44
27x6	620276	\$2,767.38	\$2,968.57
27x8	620278	\$2,805.44	\$3,009.40
27x10	6202710	\$2,842.34	\$3,048.98
27x12	6202712	\$2,847.17	\$3,054.16
27x15	6202715	\$3,006.19	\$3,224.74
27x18	6202718	\$3,164.48	\$3,394.54
27x21	6202721	\$3,689.17	\$3,957.37
27x24	6202724	\$4,407.34	\$4,727.75
30x4	620304	\$3,653.18	\$3,918.77
30x6	620306	\$3,680.62	\$3,948.20
30x8	620308	\$3,731.24	\$4,002.50
30x10	6203010	\$3,780.31	\$4,055.14
30x12	6203012	\$3,786.73	\$4,062.03
30x15	6203015	\$3,998.24	\$4,288.91
30x18	6203018	\$4,208.76	\$4,514.74
30x21	6203021	\$4,906.59	\$5,263.30
30x24	6203024	\$5,861.76	\$6,287.91
30x27	6203027	\$6,513.07	\$6,986.57
36x4	620364	\$4,858.73	\$5,211.96
36x6	620366	\$4,895.23	\$5,251.11
36x8	620368	\$4,962.55	\$5,323.32
36x10	6203610	\$5,027.81	\$5,393.34
36x12	6203612	\$5,036.35	\$5,402.50
36x15	6203615	\$5,317.66	\$5,704.25
36x18	6203618	\$5,597.65	\$6,004.60
36x21	6203621	\$6,525.77	\$7,000.19
36x24	6203624	\$7,796.14	\$8,362.92
36x27	6203627	\$8,662.38	\$9,292.13
36x30	6203630	\$9,624.86	\$10,324.59

REDUCER

CONCENTRIC

FEMALE X MALE

(LEB)



▪ Available with Dissimilar Outlet.

SDR35				
Size	PartNumber	SW: (81)	GSK: (79)	
6x4	64064	\$32.53	\$98.36	
8x4	64084	\$133.85	\$156.15	
8x6	64086	\$137.56	\$163.96	
10x4	640104	\$275.90	\$359.88	
10x6	640106	\$443.65	\$426.32	
10x8	640108	\$395.02	\$494.72	
12x4	640124	\$467.07	\$523.87	
12x6	640126	\$492.08	\$554.24	
12x8	640128	\$642.03	\$642.03	
12x10	6401210	\$528.87	\$741.23	
15x4	640154	\$566.64	\$825.53	
15x6	640156	\$711.60	\$867.23	
15x8	640158	\$940.49	\$940.49	
15x10	6401510	\$1,036.19	\$1,036.19	
15x12	6401512	\$1,033.56	\$1,126.65	
18x4	640184	\$887.21	\$1,085.83	
18x6	640186	\$936.33	\$1,104.54	
18x8	640188	\$973.81	\$1,120.87	
18x10	6401810	\$1,010.45	\$1,160.32	
18x12	6401812	\$1,117.58	\$1,185.03	
18x15	6401815	\$1,079.46	\$1,234.29	
21x4	640214	\$1,158.56	\$1,566.22	
21x6	640216	\$1,178.64	\$1,582.45	
21x8	640218	\$1,208.66	\$1,604.92	
21x10	6402110	\$1,247.95	\$1,626.16	
21x12	6402112	\$1,293.27	\$1,710.47	
21x15	6402115	\$1,392.11	\$1,975.71	
21x18	6402118	\$1,542.52	\$2,128.87	
24x4	640244	\$2,725.96	\$3,264.51	
24x6	640246	\$2,745.85	\$3,296.30	
24x8	640248	\$2,775.98	\$3,334.26	
24x10	6402410	\$2,815.16	\$3,351.32	
24x12	6402412	\$2,860.70	\$3,455.50	
24x15	6402415	\$2,959.64	\$3,541.54	
24x18	6402418	\$3,109.98	\$3,731.68	
24x21	6402421	\$3,775.43	\$4,047.55	
27x4	640274	\$3,625.52	\$4,341.79	
27x6	640276	\$3,651.99	\$4,384.08	
27x8	640278	\$3,692.05	\$4,434.56	
27x10	6402710	\$3,744.17	\$4,457.26	
27x12	6402712	\$3,804.73	\$4,595.81	
27x15	6402715	\$3,936.33	\$4,710.24	
27x18	6402718	\$4,136.27	\$4,963.13	
27x21	6402721	\$5,021.33	\$5,383.25	
27x24	6402724	\$5,579.25	\$5,981.38	
30x4	640304	\$3,431.57	\$4,290.59	
30x6	640306	\$3,447.08	\$4,454.02	
30x8	640308	\$4,412.29	\$5,515.13	
30x10	6403010	\$5,647.71	\$7,059.06	
30x12	6403012	\$7,229.08	\$9,035.30	
30x15	6403015	\$9,253.22	\$10,199.34	
30x18	6403018	\$11,844.11	\$13,055.14	
30x21	6403021	\$15,160.46	\$13,661.49	
30x24	6403024	\$19,405.40	\$15,345.78	
30x27	6403027	\$24,838.92	\$15,720.07	
36x4	640364	\$4,392.41	\$5,488.92	
36x6	640366	\$4,412.29	\$5,515.13	
36x8	640368	\$5,647.71	\$7,059.06	
36x10	6403610	\$7,229.08	\$9,035.30	
36x12	6403612	\$9,253.22	\$11,565.48	
36x15	6403615	\$11,844.11	\$13,038.30	
36x18	6403618	\$15,160.46	\$13,661.49	
36x21	6403621	\$19,405.40	\$14,410.06	
36x24	6403624	\$24,838.92	\$15,907.21	
36x27	6403627	\$31,793.83	\$16,655.79	
36x30	6403630	\$40,696.11	\$19,126.08	

ECCENTRIC

FEMALE X FEMALE



▪ Available with Dissimilar Outlet.

SDR35			
Size	PartNumber	SW: (81)	GSK: (79)
6x4	61064	CF	\$98.36
8x4	61084	\$133.85	\$156.15
8x6	61086	\$137.56	\$149.49
10x4	610104	\$275.90	\$359.88
10x6	610106	\$443.65	\$426.32
10x8	610108	\$395.02	\$494.72
12x4	610124	\$467.07	\$523.87
12x6	610126	\$492.08	\$554.24
12x8	610128	\$642.03	\$642.03
12x10	6101210	\$528.87	\$741.23
15x4	610154	\$566.64	\$825.53
15x6	610156	\$711.60	\$867.23
15x8	610158	\$940.49	\$940.49
15x10	6101510	\$1,036.19	\$1,036.19
15x12	6101512	\$1,033.56	\$1,126.65
18x4	610184	\$887.21	\$1,085.83
18x6	610186	\$936.33	\$1,104.54
18x8	610188	\$973.81	\$1,120.87
18x10	6101810	\$1,010.45	\$1,160.32
18x12	6101812	\$1,117.58	\$1,185.03
18x15	6101815	\$1,079.46	\$1,234.29
21x4	610214	\$1,158.56	\$1,566.22
21x6	610216	\$1,178.64	\$1,582.45
21x8	610218	\$1,208.66	\$1,604.92
21x10	6102110	\$1,247.95	\$1,626.16
21x12	6102112	\$1,293.27	\$1,710.47
21x15	6102115	\$1,392.11	\$1,975.71
21x18	6102118	\$1,542.52	\$2,128.87
24x4	610244	\$2,725.96	\$3,264.51
24x6	610246	\$2,745.85	\$3,296.30
24x8	610248	\$2,775.98	\$3,334.26
24x10	6102410	\$2,815.16	\$3,351.32
24x12	6102412	\$2,860.70	\$3,455.50
24x15	6102415	\$2,959.64	\$3,541.54
24x18	6102418	\$3,109.98	\$3,731.68
24x21	6102421	\$3,775.43	\$4,047.55
27x4	610274	\$3,625.52	\$4,341.79
27x6	610276	\$3,651.99	\$4,384.09
27x8	610278	\$3,692.07	\$4,434.57
27x10	6102710	\$3,744.18	\$4,457.28
27x12	6102712	\$3,804.74	\$4,595.82
27x15	6102715	\$3,936.36	\$4,710.26
27x18	6102718	\$4,136.28	\$4,963.14
27x21	6102721	\$5,021.33	\$5,383.25
27x24	6102724	\$5,579.26	\$5,981.40
30x4	610304	\$4,821.96	\$5,774.59
30x6	610306	\$4,857.15	\$5,830.85
30x8	610308	\$4,910.46	\$5,898.00
30x10	6103010	\$4,979.76	\$5,928.18
30x12	6103012	\$5,060.31	\$6,112.45
30x15	6103015	\$5,235.36	\$6,264.65
30x18	6103018	\$5,501.26	\$6,600.98
30x21	6103021	\$6,678.37	\$7,159.74
30x24	6103024	\$7,420.42	\$7,955.27
30x27	6103027	\$9,869.15	\$8,839.19
36x4	610364	\$6,413.22	\$7,680.21
36x6	610366	\$6,460.01	\$7,755.03
36x8	610368	\$6,530.92	\$7,844.34
36x10	6103610	\$6,623.09	\$7,884.49
36x12	6103612	\$6,730.22	\$8,129.56
36x15	6103615	\$6,963.01	\$8,331.99
36x18	6103618	\$7,316.68	\$8,779.31
36x21	6103621	\$8,882.23	\$9,522.46
36x24	6103624	\$9,869.16	\$10,580.52
36x27	6103627	\$10,965.75	\$11,756.12
36x30	6103630	\$12,184.16	\$13,062.36

REDUCER

ECCENTRIC

MALE X FEMALE

(SEB)



▪ Available with Dissimilar Outlet.

SDR35			
Size	PartNumber	SW: (81)	GSK: (79)
6x4	63064	\$52.41	\$52.41
8x4	63084	\$104.83	\$136.24
8x6	63086	\$106.88	\$149.49
10x4	630104	\$229.82	\$357.08
10x6	630106	\$331.85	\$370.96
10x8	630108	\$366.32	\$441.18
12x4	630124	\$387.96	\$476.47
12x6	630126	\$409.93	\$486.81
12x8	630128	\$444.69	\$558.06
12x10	6301210	\$558.57	\$618.84
15x4	630154	\$532.61	\$793.66
15x6	630156	\$590.74	\$823.15
15x8	630158	\$792.98	\$931.74
15x10	6301510	\$885.03	\$939.09
15x12	6301512	\$938.72	\$1,077.06
18x4	630184	\$887.21	\$1,123.60
18x6	630186	\$936.33	\$1,138.68
18x8	630188	\$973.81	\$1,150.94
18x10	6301810	\$1,010.45	\$1,168.43
18x12	6301812	\$1,033.56	\$1,183.58
18x15	6301815	\$1,040.11	\$1,193.25
21x4	630214	\$1,144.67	\$1,300.47
21x6	630216	\$1,172.91	\$1,423.30
21x8	630218	\$1,198.89	\$1,431.80
21x10	6302110	\$1,247.95	\$1,448.87
21x12	6302112	\$1,293.39	\$1,483.52
21x15	6302115	\$1,379.34	\$1,540.69
21x18	6302118	\$1,554.02	\$1,670.64
24x4	630244	\$2,689.62	\$2,885.78
24x6	630246	\$2,721.53	\$2,920.06
24x8	630248	\$2,755.66	\$2,956.42
24x10	6302410	\$2,820.09	\$3,025.46
24x12	6302412	\$2,856.80	\$3,064.77
24x15	6302415	\$2,938.30	\$3,152.04
24x18	6302418	\$3,067.10	\$3,289.64
24x21	6302421	\$3,606.29	\$3,866.58
27x4	630274	\$2,746.75	\$2,946.44
27x6	630276	\$2,767.38	\$2,968.57
27x8	630278	\$2,805.44	\$3,009.40
27x10	6302710	\$2,842.34	\$3,048.98
27x12	6302712	\$2,847.17	\$3,054.16
27x15	6302715	\$3,006.19	\$3,224.74
27x18	6302718	\$3,164.48	\$3,394.54
27x21	6302721	\$3,689.17	\$3,957.37
27x24	6302724	\$4,407.34	\$4,727.75

FEMALE X MALE

(LEB)

▪ Available with Dissimilar Outlet.

Size	PartNumber	SDR35	
		SW: (81)	GSK: (79)
6x4	65064	CF	\$98.36
8x4	65084	\$133.85	\$156.15
8x6	65086	\$137.56	\$149.49
10x4	650104	\$275.90	\$359.88
10x6	650106	\$443.65	\$426.32
10x8	650108	\$395.02	\$494.72
12x4	650124	\$467.07	\$523.87
12x6	650126	\$492.08	\$554.24
12x8	650128	\$642.03	\$642.03
12x10	6501210	\$528.87	\$741.23
15x4	650154	\$566.64	\$825.53
15x6	650156	\$711.60	\$867.23
15x8	650158	\$940.49	\$940.49
15x10	6501510	\$1,036.19	\$1,036.19
15x12	6501512	\$1,033.56	\$1,126.65
18x4	650184	\$887.21	\$1,085.83
18x6	650186	\$936.33	\$1,104.54
18x8	650188	\$973.81	\$1,120.87
18x10	6501810	\$1,010.45	\$1,160.32
18x12	6501812	\$1,117.58	\$1,185.03
18x15	6501815	\$1,079.46	\$1,234.29
21x4	650214	\$1,158.56	\$1,566.22
21x6	650216	\$1,178.64	\$1,582.45
21x8	650218	\$1,208.66	\$1,604.92
21x10	6502110	\$1,247.95	\$1,626.16
21x12	6502112	\$1,293.27	\$1,710.47
21x15	6502115	\$1,392.11	\$1,975.71
21x18	6502118	\$1,542.52	\$2,128.87
24x4	650244	\$2,725.96	\$3,264.51
24x6	650246	\$2,745.85	\$3,296.30
24x8	650248	\$2,775.98	\$3,334.26
24x10	6502410	\$2,815.16	\$3,351.32
24x12	6502412	\$2,860.70	\$3,455.50
24x15	6502415	\$2,959.64	\$3,541.54
24x18	6502418	\$3,109.98	\$3,731.68
24x21	6502421	\$3,775.43	\$4,047.55
27x4	650274	\$2,680.90	\$3,351.14
27x6	650276	\$2,693.03	\$3,366.29
27x8	650278	\$2,721.85	\$3,402.35
27x10	6502710	\$2,752.92	\$3,441.15
27x12	6502712	\$2,894.08	\$3,617.60
27x15	6502715	\$2,909.71	\$3,637.14
27x18	6502718	\$3,029.60	\$3,787.02
27x21	6502721	\$3,491.44	\$4,364.30
27x24	6502724	\$3,782.20	\$4,727.75
30x4	650304	\$3,431.57	\$4,289.46
30x6	650306	\$3,447.07	\$4,308.83
30x8	650308	\$4,352.52	\$5,515.31
30x10	6503010	\$5,647.69	\$7,059.58
30x12	6503012	\$7,229.02	\$9,036.30
30x15	6503015	\$9,253.16	\$11,566.47
30x18	6503018	\$11,844.05	\$14,805.05
30x21	6503021	\$15,160.39	\$18,950.49
30x24	6503024	\$19,405.29	\$24,256.62
30x27	6503027	\$24,838.80	\$31,048.47
36x4	650364	\$4,392.41	\$5,490.51
36x6	650366	\$4,412.23	\$5,515.31
36x8	650368	\$5,647.69	\$7,059.58
36x10	6503610	\$7,229.02	\$9,036.30
36x12	6503612	\$9,253.16	\$11,566.47
36x15	6503615	\$11,844.05	\$14,805.05
36x18	6503618	\$15,160.39	\$18,950.49
36x21	6503621	\$19,405.29	\$24,256.62
36x24	6503624	\$24,838.80	\$31,048.47
36x27	6503627	\$31,793.65	\$39,742.07
36x30	6503630	\$40,695.86	\$50,869.84

SADDLE TEE W/2 S.S. BANDS

SOLVENT WELD BASE X FEMALE

▪ Available in Larger Sizes. ▪ Available with Dissimilar Outlet.

SDR35			
Size	PartNumber	SW: (81)	GSK: (79)
6x4	70164	\$63.44	\$78.89
8x4	70184	\$88.28	\$99.11
8x6	70186	\$97.85	\$113.50
10x4	701104	\$104.00	\$175.20
10x6	701106	\$118.81	\$209.19
10x8	701108	\$288.60	\$350.97
12x4	701124	\$106.88	\$217.33
12x6	701126	\$122.82	\$244.38
12x8	701128	\$340.46	\$405.02
12x10	7011210	\$444.33	\$509.88
15x4	701154	\$113.83	\$229.77
15x6	701156	\$127.33	\$246.38
15x8	701158	\$420.09	\$483.93
15x10	7011510	\$509.45	\$547.20
15x12	7011512	\$736.24	\$819.13
18x4	701184	\$182.40	\$405.02
18x6	701186	\$195.16	\$446.20
18x8	701188	\$472.67	\$577.49
18x10	7011810	\$555.62	\$640.76
18x12	7011812	\$769.59	\$916.01
18x15	7011815	\$839.13	\$1,000.01
21x4	701214	\$190.15	\$421.55
21x6	701216	\$208.93	\$448.56
21x8	701218	\$595.14	\$577.49
21x10	7012110	\$596.59	\$640.76
21x12	7012112	\$813.27	\$916.01
21x15	7012115	\$887.86	\$1,000.01
21x18	7012118	\$1,318.49	\$1,485.04
24x4	701244	\$197.08	\$429.53
24x6	701246	\$215.85	\$451.11
24x8	701248	\$519.36	\$584.96
24x10	7012410	\$575.45	\$648.13
24x12	7012412	\$817.34	\$920.59
24x15	7012415	\$894.42	\$1,007.41
24x18	7012418	\$1,385.31	\$1,560.28
24x21	7012421	\$1,559.47	\$1,756.45
27x4	701274	\$197.08	\$429.53
27x6	701276	\$215.85	\$451.11
27x8	701278	\$519.36	\$584.96
27x10	7012710	\$575.45	\$648.13
27x12	7012712	\$817.34	\$920.59
27x15	7012715	\$894.42	\$1,007.41
27x18	7012718	\$1,423.51	\$1,603.32
27x21	7012721	\$1,625.14	\$1,830.43
27x24	7012724	\$1,925.85	\$2,169.11
30x4	701304	\$437.44	\$622.52
30x6	701306	\$470.80	\$670.00
30x8	701308	\$664.71	\$945.95
30x10	7013010	\$736.41	\$1,047.98
30x12	7013012	\$1,046.02	\$1,488.59
30x15	7013015	\$1,144.74	\$1,629.08
30x18	7013018	\$1,772.85	\$2,522.94
30x21	7013021	\$1,995.86	\$2,840.31
30x24	7013024	\$2,293.07	\$3,263.26
30x27	7013027	\$2,553.42	\$3,633.77
36x4	701364	\$546.79	\$778.14
36x6	701366	\$588.50	\$837.50
36x8	701368	\$697.96	\$993.27
36x10	7013610	\$773.24	\$1,100.39
36x12	7013612	\$1,098.31	\$1,563.01
36x15	7013615	\$1,201.98	\$1,710.54
36x18	7013618	\$1,861.48	\$2,649.09
36x21	7013621	\$2,095.67	\$2,982.36
36x24	7013624	\$2,407.73	\$3,426.43
36x27	7013627	\$3,039.78	\$4,325.91
36x30	7013630	\$3,799.74	\$5,407.41

GASKET BASE X FEMALE

▪ Available in Larger Sizes or Dissimilar Outlet. ▪ Saddle Skirt Gasket Must Be Ordered From Pipe Manufacturer.

SDR35			
Size	PartNumber	SW: (81)	GSK: (79)
6x4	70064	CF	\$78.89
8x4	70084	CF	\$99.11
8x6	70086	CF	\$113.50
10x4	700104	CF	\$175.20
10x6	700106	CF	\$209.19
12x4	700124	CF	\$217.33
12x6	700126	CF	\$244.38
15x4	700154	CF	\$229.77
15x6	700156	CF	\$246.38
18x4	700184	CF	\$405.02
18x6	700186	CF	\$446.20
21x4	700214	CF	\$421.55
21x6	700216	CF	\$448.56
24x4	700244	CF	\$429.53
24x6	700246	CF	\$451.13
27x4	700274	CF	\$429.53
27x6	700276	CF	\$451.22
30x4	700304	CF	\$429.53
30x6	700306	CF	\$451.22

SADDLE WYE W/2 S.S. BANDS

GASKET BASE X FEMALE

▪ Available in Larger Sizes or Dissimilar Outlet. ▪ Saddle Skirt Gasket Must Be Ordered From Pipe Manufacturer.

SDR35			
Size	PartNumber	SW: (81)	GSK: (79)
6x4	74064	CF	\$70.84
8x4	74084	CF	\$99.11
8x6	74086	CF	\$102.54
10x4	740104	CF	\$196.54
10x6	740106	CF	\$210.92
12x4	740124	CF	\$219.04
12x6	740126	CF	\$246.01
15x4	740154	CF	\$230.83
15x6	740156	CF	\$254.36
18x4	740184	CF	\$411.59
18x6	740186	CF	\$448.79
21x4	740214	CF	\$427.41
21x6	740216	CF	\$460.62
24x4	740244	CF	\$435.40
24x6	740246	CF	\$468.60
27x4	740274	CF	\$435.40
27x6	740276	CF	\$468.60
30x4	740304	CF	\$435.40
30x6	740306	CF	\$468.60

SOLVENT WELD BASE X FEMALE

▪ Available in Larger Sizes. ▪ Available with Dissimilar Outlet.

SDR35			
Size	PartNumber	SW: (81)	GSK: (79)
6x4	74164	\$70.71	\$70.84
8x4	74184	\$96.83	\$99.11
8x6	74186	\$102.39	\$102.54
10x4	741104	\$113.62	\$196.54
10x6	741106	\$128.14	\$210.92
10x8	741108	\$413.37	\$458.37
12x4	741124	\$117.30	\$219.04
12x6	741126	\$132.66	\$246.01
12x8	741128	\$584.40	\$645.51
12x10	7411210	\$711.40	\$775.35
15x4	741154	\$125.22	\$230.83
15x6	741156	\$139.63	\$254.36
15x8	741158	\$783.48	\$787.59
15x10	7411510	\$888.70	\$889.64
15x12	7411512	\$1,083.23	\$1,085.55
18x4	741184	\$198.24	\$411.59
18x6	741186	\$211.99	\$448.79
18x8	741188	\$831.27	\$881.12
18x10	7411810	\$943.22	\$983.21
18x12	7411812	\$1,121.57	\$1,179.27
18x15	7411815	\$1,203.11	\$1,266.44
21x4	741214	\$212.95	\$427.41
21x6	741216	\$226.85	\$460.62
21x8	741218	\$837.07	\$881.12
21x10	7412110	\$934.05	\$983.21
21x12	7412112	\$1,120.30	\$1,179.27
21x15	7412115	\$1,203.11	\$1,266.44
21x18	7412118	\$1,410.79	\$1,485.04
24x4	741244	\$220.34	\$435.40
24x6	741246	\$234.25	\$468.60
24x8	741248	\$844.21	\$888.64
24x10	7412410	\$941.11	\$990.64
24x12	7412412	\$1,127.42	\$1,186.75
24x15	7412415	\$1,210.20	\$1,273.89
24x18	7412418	\$1,482.26	\$1,560.28
24x21	7412421	\$1,668.63	\$1,756.45
27x4	741274	\$220.34	\$435.40
27x6	741276	\$234.25	\$468.60
27x8	741278	\$844.21	\$888.64
27x10	7412710	\$941.11	\$990.64
27x12	7412712	\$1,127.42	\$1,186.75
27x15	7412715	\$1,210.20	\$1,273.89
27x18	7412718	\$1,523.16	\$1,603.32
27x21	7412721	\$1,738.90	\$1,830.43
27x24	7412724	\$2,135.38	\$2,247.76
30x4	741304	\$556.46	\$585.74
30x6	741306	\$599.82	\$631.39

TEE

STRAIGHT

FEMALE X FEMALE X FEMALE

▪ Spigot End Configurations Available. ▪ Available with Dissimilar Outlet.



SDR35			
Size	PartNumber	SW: (81)	GSK: (79)
4	8204	\$13.32	\$44.94
6x4	82064	\$52.50	\$94.17
6	8206	\$55.41	\$96.27
8x4	82084	\$121.29	\$145.47
8x6	82086	\$150.07	\$150.51
8	8208	\$226.21	\$213.61
10x4	820104	\$407.90	\$472.65
10x6	820106	\$469.49	\$480.63
10x8	820108	\$587.99	\$760.55
10	82010	\$709.63	\$780.75

STRAIGHT

FEMALE X FEMALE X FEMALE

SDR35			
Size	PartNumber	SW: (81)	GSK: (79)
12x4	820124	\$569.71	\$577.90
12x6	820126	\$614.67	\$609.08
12x8	820128	\$732.34	\$835.90
12x10	8201210	\$786.09	\$980.10
12	82012	\$1,064.36	\$1,121.87
15x4	820154	\$838.22	\$938.18
15x6	820156	\$968.02	\$1,010.45
15x8	820158	\$1,052.97	\$1,087.88
15x10	8201510	\$1,117.50	\$1,211.09
15x12	8201512	\$1,356.77	\$1,429.13
15	82015	\$1,646.77	\$1,856.14
18x4	820184	\$2,139.00	\$2,367.62
18x6	820186	\$2,214.14	\$2,447.85
18x8	820188	\$2,316.25	\$2,557.48
18x10	8201810	\$2,408.27	\$2,655.90
18x12	8201812	\$2,476.01	\$2,728.51
18x15	8201815	\$2,642.21	\$2,905.80
18	82018	\$2,794.04	\$3,068.58
21x4	820214	\$3,039.07	\$3,330.63
21x6	820216	\$3,265.38	\$3,572.82
21x8	820218	\$3,513.05	\$3,837.81
21x10	8202110	\$3,779.88	\$4,123.66
21x12	8202112	\$4,056.86	\$4,419.99
21x15	8202115	\$4,536.97	\$4,933.31
21x18	8202118	\$5,158.02	\$5,598.04
21	82021	\$6,362.42	\$7,420.13
24x4	820244	\$4,657.14	\$5,255.35
24x6	820246	\$5,743.45	\$6,372.44
24x8	820248	\$5,902.31	\$6,473.35
24x10	8202410	\$5,961.91	\$6,759.42
24x12	8202412	\$6,092.99	\$6,882.87
24x15	8202415	\$6,139.60	\$7,152.61
24x18	8202418	\$8,470.04	\$9,898.15
24x21	8202421	\$9,940.93	\$10,708.38
24	82024	\$11,835.18	\$13,157.86
27x4	820274	\$5,500.41	\$6,875.61
27x6	820276	\$5,533.38	\$6,916.75
27x8	820278	\$6,316.67	\$7,895.85
27x10	8202710	\$6,643.62	\$8,304.55
27x12	8202712	\$7,264.70	\$9,080.85
27x15	8202715	\$8,201.08	\$10,251.36
27x18	8202718	\$8,403.69	\$10,504.48
27x21	8202721	\$8,655.28	\$10,819.10
27x24	8202724	\$10,708.98	\$13,386.24
27	82027	\$11,011.92	\$13,764.87
30x4	820304	\$7,068.33	\$8,835.43
30x6	820306	\$7,110.71	\$8,888.40
30x8	820308	\$8,117.11	\$10,146.40
30x10	8203010	\$8,537.33	\$10,671.66
30x12	8203012	\$9,335.46	\$11,669.35
30x15	8203015	\$10,538.71	\$13,173.41
30x18	8203018	\$10,799.13	\$13,498.90
30x21	8203021	\$11,122.48	\$13,903.13
30x24	8203024	\$13,761.63	\$17,202.03
30x27	8203027	\$14,150.69	\$17,688.37
30	82030	\$17,688.42	\$22,110.53
36x4	820364	\$9,400.88	\$11,060.20
36x6	820366	\$9,457.24	\$11,556.13
36x8	820368	\$10,795.76	\$13,586.63
36x10	8203610	\$11,354.63	\$13,758.80
36x12	8203612	\$12,416.18	\$14,537.32
36x15	8203615	\$14,016.50	\$15,847.33
36x18	8203618	\$14,362.81	\$17,065.63
36x21	8203621	\$14,792.93	\$19,397.44
36x24	8203624	\$18,302.98	\$21,708.67
36x27	8203627	\$18,820.41	\$23,546.42
36x30	8203630	\$25,031.16	\$29,433.96
36	82036	\$33,291.44	\$36,792.45

CLEANOUT

FEMALE X FEMALE X FIPT

▪ Available in Larger Sizes. ▪ Other Sized Taps Available.

SDR35			
Size	PartNumber	SW: (81)	GSK: (79)
4	8404	\$35.41	CF
6	8406	\$234.58	CF

TEE

TWO-WAY CLEANOUT

FEMALE X FEMALE X FEMALE

▪ Available in Larger Sizes. ▪ Other Sized Taps Available.

SDR35			
Size	PartNumber	SW: (81)	GSK: (79)
4	8604	\$38.26	\$112.48
6	8606	\$235.82	\$638.69

TEE

SANITARY (T-Y)

FEMALE X FEMALE X FEMALE

▪ Spigot End Configurations Available. ▪ Available with Dissimilar Outlet.

SDR35			
Size	PartNumber	SW: (81)	GSK: (79)
4	8104	\$21.37	\$53.38
6x4	81064	\$110.91	\$115.53
6	8106	\$127.13	\$134.72
8x4	81084	\$145.00	\$146.30
8x6	81086	\$163.31	\$168.28
8	8108	\$345.75	\$414.19
10x4	810104	\$519.59	\$550.66
10x6	810106	\$601.15	\$631.05
10x8	810108	\$932.86	\$968.60
10	81010	\$1,133.55	\$1,284.41
12x4	810124	\$624.71	\$678.61
12x6	810126	\$712.05	\$723.22
12x8	810128	\$1,151.40	\$1,071.79
12x10	8101210	\$1,256.15	\$1,587.59
12	81012	\$1,477.30	\$1,794.43
15x4	810154	\$940.40	\$1,094.96
15x6	810156	\$1,059.14	\$1,211.09
15x8	810158	\$1,229.28	\$1,307.30
15x10	8101510	\$1,376.74	\$1,514.84
15x12	8101512	\$1,541.88	\$1,781.75
15	81015	\$1,992.03	\$2,322.73
18x4	810184	\$2,258.94	\$2,494.96
18x6	810186	\$2,344.78	\$2,540.81
18x8	810188	\$2,478.94	\$2,693.26
18x10	8101810	\$2,602.76	\$3,036.96
18x12	8101812	\$2,668.15	\$3,124.88
18x15	8101815	\$2,849.96	\$4,106.41
18	81018	\$3,002.63	\$3,325.43
21x4	810214	\$3,390.11	\$3,536.30
21x6	810216	\$3,479.50	\$3,825.71
21x8	810218	\$3,639.18	\$4,678.34
21x10	8102110	\$4,413.07	\$5,150.52
21x12	8102112	\$4,718.37	\$5,511.17
21x15	8102115	\$5,270.97	\$6,153.16
21x18	8102118	\$5,438.18	\$6,982.72
21	81021	\$5,598.09	\$9,262.22
24x4	810244	\$5,336.93	\$5,887.83
24x6	810246	\$5,645.57	\$6,238.41
24x8	810248	\$5,834.04	\$6,365.74
24x10	8102410	\$6,325.13	\$7,386.71
24x12	8102412	\$6,441.49	\$7,516.57
24x15	8102415	\$6,695.97	\$7,812.26

TEE

SANITARY (T-Y)

FEMALE X FEMALE X FEMALE

SDR35			
Size	PartNumber	SW: (81)	GSK: (79)
24x18	8102418	\$8,353.50	\$10,805.95
24x21	8102421	\$10,018.46	\$11,693.22
24	81024	\$12,308.58	\$14,369.39
27x4	810274	\$5,807.60	\$7,259.53
27x6	810276	\$5,958.88	\$7,448.62
27x8	810278	\$6,098.24	\$7,622.87
27x10	8102710	\$7,259.77	\$9,074.71
27x12	8102712	\$7,929.12	\$9,911.40
27x15	8102715	\$8,956.34	\$11,195.44
27x18	8102718	\$9,181.43	\$11,476.80
27x21	8102721	\$9,452.66	\$11,815.82
27x24	8102724	\$11,697.56	\$14,621.96
27	81027	\$12,026.43	\$15,033.04
30x4	810304	\$7,462.99	\$9,328.74
30x6	810306	\$7,657.49	\$9,571.88
30x8	810308	\$7,836.44	\$9,795.57
30x10	8103010	\$9,074.71	\$11,343.38
30x12	8103012	\$9,911.40	\$12,389.25
30x15	8103015	\$11,195.44	\$13,994.30
30x18	8103018	\$11,476.80	\$14,346.00
30x21	8103021	\$11,815.82	\$14,769.77
30x24	8103024	\$14,621.96	\$18,277.45
30x27	8103027	\$18,277.45	\$22,846.82
30	81030	\$22,846.82	\$28,558.51
36x4	810364	\$9,328.73	\$11,660.93
36x6	810366	\$9,571.86	\$11,964.09
36x8	810368	\$9,795.56	\$12,242.95
36x10	8103610	\$11,343.38	\$14,179.24
36x12	8103612	\$12,389.25	\$15,486.55
36x15	8103615	\$13,994.30	\$17,492.85
36x18	8103618	\$14,346.00	\$17,932.51
36x21	8103621	\$14,769.77	\$18,462.21
36x24	8103624	\$18,277.45	\$22,846.82
36x27	8103627	\$22,846.82	\$28,558.51
36x30	8103630	\$28,558.51	\$35,698.14
36	81036	\$35,698.14	\$44,622.68

COMBO WYE W/ 1/8 BEND

FEMALE X FEMALE X FEMALE

▪ Available with Dissimilar Outlet. ▪ 10"-12" Molded Fittings Available—Contact Factory.

SDR35			
Size	PartNumber	SW: (81)	GSK: (79)
4	8904	\$44.36	\$84.96
6x4	89064	\$94.16	\$134.12
6	8906	\$141.49	\$210.76
8x4	89084	\$173.11	\$224.65
8x6	89086	\$238.34	\$306.17
8	8908	\$407.09	\$463.90
10x4	890104	\$463.39	\$550.73
10x6	890106	\$556.12	\$631.07
10x8	890108	\$823.13	\$968.60
10	89010	CF	\$1,315.61
12x4	890124	\$625.66	\$678.61
12x6	890126	\$740.83	\$723.22
12x8	890128	\$1,013.51	\$1,138.91
12x10	8901210	CF	\$1,620.47
12	89012	CF	\$1,842.34
15x4	890154	\$925.35	\$1,094.96
15x6	890156	\$1,105.80	\$1,211.09
15x8	890158	\$1,424.36	\$1,439.46
15x10	8901510	CF	\$1,961.66
15x12	8901512	CF	\$2,309.40
15	89015	CF	\$3,512.15
18x4	890184	\$2,271.85	\$2,523.14
18x6	890186	\$2,388.00	\$2,632.34

FEMALE X FEMALE X FEMALE

SDR35			
Size	PartNumber	SW: (81)	GSK: (79)
18x8	890188	\$2,577.38	\$2,848.06
21x4	890214	\$3,257.13	\$3,573.87
21x6	890216	\$3,532.27	\$3,853.11
21x8	890218	\$4,067.05	\$4,678.34
24x4	890244	\$4,915.89	\$5,887.83
24x6	890246	\$6,093.79	\$7,071.77
24x8	890248	\$6,342.72	\$7,333.65
27x4	890274	\$6,234.49	\$7,259.53
27x6	890276	\$6,308.96	\$7,448.62
27x8	890278	\$7,245.48	\$8,629.85
30x4	890304	\$8,004.29	\$9,328.74
30x6	890306	\$8,089.38	\$9,571.88
30x8	890308	\$9,272.79	\$11,043.29
36x4	890364	\$10,637.15	\$12,375.81
36x6	890366	\$10,738.10	\$12,474.74
36x8	890368	\$12,331.02	\$14,428.68

FEMALE X FEMALE X FEMALE

SDR35			
Size	PartNumber	SW: (81)	GSK: (79)
27x6	920276	\$5,757.12	\$7,196.45
27x8	920278	\$6,773.70	\$8,467.13
27x10	9202710	\$6,871.55	\$8,589.48
27x12	9202712	\$7,240.19	\$9,050.25
27x15	9202715	\$7,892.84	\$9,866.03
27x18	9202718	\$8,499.76	\$10,624.74
27x21	9202721	\$9,661.13	\$12,076.42
27x24	9202724	\$10,812.42	\$13,515.55
27	92027	\$11,727.52	\$14,659.44
30x4	920304	\$7,081.64	\$8,852.06
30x6	920306	\$7,398.25	\$9,247.81
30x8	920308	\$8,704.45	\$10,880.57
30x10	9203010	\$8,830.29	\$11,037.87
30x12	9203012	\$9,304.03	\$11,630.05
30x15	9203015	\$9,866.05	\$12,678.24
30x18	9203018	\$10,922.58	\$13,653.24
30x21	9203021	\$12,415.00	\$15,518.79
30x24	9203024	\$13,894.55	\$17,368.19
30x27	9203027	\$15,070.55	\$18,838.17
30	92030	\$18,838.13	\$23,547.68
36x4	920364	\$8,852.06	\$11,063.93
36x6	920366	\$9,247.80	\$11,559.69
36x8	920368	\$10,880.55	\$13,600.72
36x10	9203610	\$11,037.85	\$13,759.91
36x12	9203612	\$11,630.05	\$14,537.55
36x15	9203615	\$12,678.22	\$15,847.79
36x18	9203618	\$13,653.22	\$17,066.54
36x21	9203621	\$15,518.77	\$19,397.44
36x24	9203624	\$17,368.18	\$21,708.67
36x27	9203627	\$18,838.17	\$23,546.42
36x30	9203630	\$23,547.73	\$29,433.96
36	92036	\$29,434.65	\$36,792.45

WYE

FEMALE X FEMALE X FEMALE



Available with Dissimilar Outlet. • 10"-12" Molded Fittings Available—Contact Factory.

SDR35			
Size	PartNumber	SW: (81)	GSK: (79)
4	9204	\$18.45	\$47.82
6x4	92064	\$65.86	\$96.98
6	9206	\$78.34	\$109.80
8x4	92084	\$142.80	\$144.68
8x6	92086	\$172.37	\$172.54
8	9208	\$261.75	\$300.83
10x4	920104	\$418.79	\$440.13
10x6	920106	\$447.06	\$447.39
10x8	920108	\$677.84	\$707.20
10	92010	\$774.73	\$888.31
12x4	920124	\$599.62	\$633.70
12x6	920126	\$646.75	\$653.45
12x8	920128	\$868.21	\$976.18
12x10	9201210	\$1,051.77	\$1,193.18
12	92012	\$1,241.53	\$1,242.18
15x4	920154	\$899.46	\$955.93
15x6	920156	\$1,042.64	\$1,144.91
15x8	920158	\$1,272.46	\$1,276.74
15x10	9201510	\$1,488.77	\$1,534.37
15x12	9201512	\$1,672.18	\$1,709.24
15	92015	\$2,151.48	\$2,158.24
18x4	920184	\$2,040.34	\$2,195.77
18x6	920186	\$2,071.15	\$2,224.26
18x8	920188	\$2,122.80	\$2,303.09
18x10	9201810	\$2,408.27	\$2,587.49
18x12	9201812	\$2,476.01	\$2,780.37
18x15	9201815	\$2,642.21	\$2,975.46
18	92018	\$3,258.59	\$3,864.97
21x4	920214	\$3,231.22	\$3,536.73
21x6	920216	\$3,469.11	\$3,791.03
21x8	920218	\$3,921.75	\$4,275.44
21x10	9202110	\$4,430.29	\$4,819.17
21x12	9202112	\$4,797.19	\$5,211.91
21x15	9202115	\$5,567.30	\$6,036.30
21x18	9202118	\$6,569.36	\$7,108.30
21	92021	\$8,619.11	\$9,301.44
24x4	920244	\$4,652.77	\$5,334.51
24x6	920246	\$5,447.54	\$6,105.96
24x8	920248	\$5,894.88	\$6,585.09
24x10	9202410	\$5,961.91	\$6,656.34
24x12	9202412	\$6,092.99	\$6,796.52
24x15	9202415	\$6,139.60	\$6,846.42
24x18	9202418	\$8,728.41	\$9,616.40
24x21	9202421	\$9,597.05	\$10,545.56
24	92024	\$10,577.70	\$11,595.00
27x4	920274	\$5,503.14	\$6,878.95

FEMALE X FEMALE X FEMALE

(WITH IPS OUTLET)

Available with Dissimilar Outlet. • 10"-12" Molded Fittings Available—Contact Factory.

SDR35			
Size	PartNumber	SW: (81)	GSK: (79)
6x4	9206-4IPS	\$65.86	\$156.69
6	9206-IPS	\$78.34	\$171.75
8x4	9208-4IPS	\$142.80	\$186.80
8x6	9208-6IPS	\$172.37	\$243.17
8	9208-IPS	\$261.75	\$300.83
10x4	92010-4IPS	\$418.79	\$459.46
10x6	92010-6IPS	\$447.06	\$469.21
10x8	92010-8IPS	\$677.84	\$707.20
10	92010-IPS	\$774.73	\$888.31
12x4	92012-4IPS	\$599.62	\$655.51
12x6	92012-6IPS	\$646.75	\$693.57
12x8	92012-8IPS	\$868.21	\$976.18
12x10	92012-10IPS	\$1,051.77	\$1,193.18
12	92012-IPS	\$1,241.53	\$1,242.18
15x4	92015-4IPS	\$899.46	\$975.47
15x6	92015-6IPS	\$1,042.64	\$1,182.65
15x8	92015-8IPS	\$1,272.46	\$1,276.74
15x10	92015-10IPS	\$1,488.77	\$1,534.37
15x12	92015-12IPS	\$1,672.18	\$1,709.24
18x4	92018-4IPS	\$2,040.34	\$2,215.48
18x6	92018-6IPS	\$2,071.15	\$2,245.98
18x8	92018-8IPS	\$2,303.09	\$2,303.09
18x10	92018-10IPS	\$2,587.49	\$2,587.49
18x12	92018-12IPS	\$2,780.37	\$2,780.37
21x4	92021-4IPS	\$3,536.73	\$3,556.37
21x6	92021-6IPS	\$3,791.03	\$3,812.78
21x8	92021-8IPS	\$4,275.44	\$4,275.44
21x10	92021-10IPS	\$4,819.17	\$4,819.17
21x12	92021-12IPS	\$5,211.91	\$5,211.91
24x4	92024-4IPS	\$5,334.51	\$5,354.22

WYE

FEMALE X FEMALE X FEMALE

(WITH IPS OUTLET)

SDR35			
Size	PartNumber	SW: (81)	GSK: (79)
24x6	92024-6IPS	\$6,105.96	\$6,127.71
24x8	92024-8IPS	\$6,585.09	\$6,585.09
24x10	92024-10IPS	\$6,656.34	\$6,656.34
24x12	92024-12IPS	\$6,796.52	\$6,796.52
27x4	92027-4IPS	\$6,878.95	\$6,898.65
27x6	92027-6IPS	\$7,196.45	\$7,218.18
27x8	92027-8IPS	\$8,467.13	\$8,467.13
27x10	92027-10IPS	\$8,589.48	\$8,589.48
27x12	92027-12IPS	\$9,050.25	\$9,050.25
30x4	92030-4IPS	\$8,852.06	\$8,852.06
30x6	92030-6IPS	\$9,247.81	\$9,247.81
30x8	92030-8IPS	\$10,880.57	\$10,880.57
30x10	92030-10IPS	\$11,037.87	\$11,037.87
30x12	92030-12IPS	\$11,630.05	\$11,630.05
36x4	92036-4IPS	\$11,063.93	\$11,063.93
36x6	92036-6IPS	\$11,559.69	\$11,559.69
36x8	92036-8IPS	\$13,600.72	\$13,600.72
36x10	92036-10IPS	\$13,759.91	\$13,759.91
36x12	92036-12IPS	\$14,537.55	\$14,537.55

DOUBLE

FEMALE X FEMALE X FEMALE X FEMALE



Available with Dissimilar Outlet. 10"-12" Molded Fittings Available—Contact Factory.

SDR35			
Size	PartNumber	SW: (81)	GSK: (79)
4	9404	\$107.62	CF
6x4	94064	\$177.56	\$136.24
6	9406	\$267.44	\$261.40
8x4	94084	\$326.98	\$282.94
8x6	94086	\$397.32	\$327.08
8	9408	\$580.24	\$618.42
10x4	940104	\$629.41	\$811.95
10x6	940106	\$834.78	\$840.76
10x8	940108	\$871.85	\$1,206.86
10	94010	\$671.87	\$1,319.58
12x4	940124	\$856.08	\$1,026.96
12x6	940126	\$964.12	\$1,079.06
12x8	940128	\$1,307.69	\$1,475.23
12x10	9401210	\$1,426.75	\$1,669.96
12	94012	\$1,394.17	\$1,754.03
15x4	940154	\$1,611.29	\$1,518.65
15x6	940156	\$1,777.31	\$1,731.17
15x8	940158	\$1,955.90	\$1,815.86
15x10	9401510	\$2,171.40	\$2,080.57
15x12	9401512	\$2,301.26	\$2,458.10
15	94015	\$2,646.01	\$2,687.88
18x4	940184	\$2,777.82	\$2,838.86
18x6	940186	\$3,036.73	\$2,980.16
18x8	940188	\$3,460.67	\$3,257.20
18x10	9401810	\$3,722.40	\$5,399.51
18x12	9401812	\$3,976.83	\$5,546.91
18x15	9401815	\$4,740.22	\$5,919.33
18	94018	\$3,271.64	\$6,240.32
21x4	940214	\$3,533.38	\$3,665.44
21x6	940216	\$4,049.55	\$3,965.08
21x8	940218	\$6,223.38	\$4,542.50
21x10	9402110	\$6,746.87	\$6,588.47
21x12	9402112	\$7,717.44	\$7,049.89
21x15	9402115	\$8,687.98	\$7,871.14
21x18	9402118	\$9,653.32	\$8,976.56
21	94021	\$5,009.21	\$11,848.16
24x4	940244	\$5,598.10	\$5,619.52
24x6	940246	\$5,736.23	\$6,279.65
24x8	940248	4,661.71	\$6,437.94

DOUBLE

FEMALE X FEMALE X FEMALE X FEMALE

SDR35			
Size	PartNumber	SW: (81)	GSK: (79)
24x10	9402410	\$8,746.18	\$9,449.00
24x12	9402412	\$8,927.95	\$9,615.11
24x15	9402415	\$8,993.28	\$9,993.44
24x18	9402418	\$11,752.38	\$13,822.85
24x21	9402421	\$14,511.48	\$14,957.88
24	94024	\$15,347.56	\$18,307.28
27x4	940274	\$5,698.62	\$7,123.29
27x6	940276	\$5,935.12	\$7,418.92
27x8	940278	\$6,061.80	\$7,577.27
27x10	9402710	\$6,805.56	\$16,152.90
27x12	9402712	\$7,539.65	\$17,642.36
27x15	9402715	\$8,630.39	\$19,927.91
27x18	9402718	\$9,426.64	\$20,428.69
27x21	9402721	\$10,733.00	\$21,032.19
27x24	9402724	\$11,778.09	\$26,027.04
27	94027	\$12,474.86	\$26,758.96
30x4	940304	\$7,123.29	\$11,679.58
30x6	940306	\$7,418.90	\$12,352.05
30x8	940308	\$7,577.26	\$13,873.52
30x10	9403010	\$8,506.96	\$20,191.14
30x12	9403012	\$9,424.57	\$22,052.97
30x15	9403015	\$10,787.98	\$24,909.90
30x18	9403018	\$11,783.29	\$25,535.86
30x21	9403021	\$13,472.39	\$26,290.27
30x24	9403024	\$14,722.64	\$32,533.82
30x27	9403027	\$18,403.29	\$40,667.27
30	94030	\$23,004.11	\$50,834.08
36x4	940364	\$8,904.08	\$14,599.46
36x6	940366	\$9,273.62	\$15,440.04
36x8	940368	\$9,471.56	\$17,341.90
36x10	9403610	\$10,633.71	\$25,238.92
36x12	9403612	\$11,780.70	\$27,566.21
36x15	9403615	\$13,484.99	\$31,137.37
36x18	9403618	\$14,729.11	\$31,919.83
36x21	9403621	\$16,770.31	\$32,862.81
36x24	9403624	\$18,403.29	\$40,667.27
36x27	9403627	\$23,004.11	\$50,834.08
36x30	9403630	\$28,755.16	\$63,542.61
36	94036	\$35,943.95	\$79,428.26

DUCT FITTINGS

PVC & CPVC

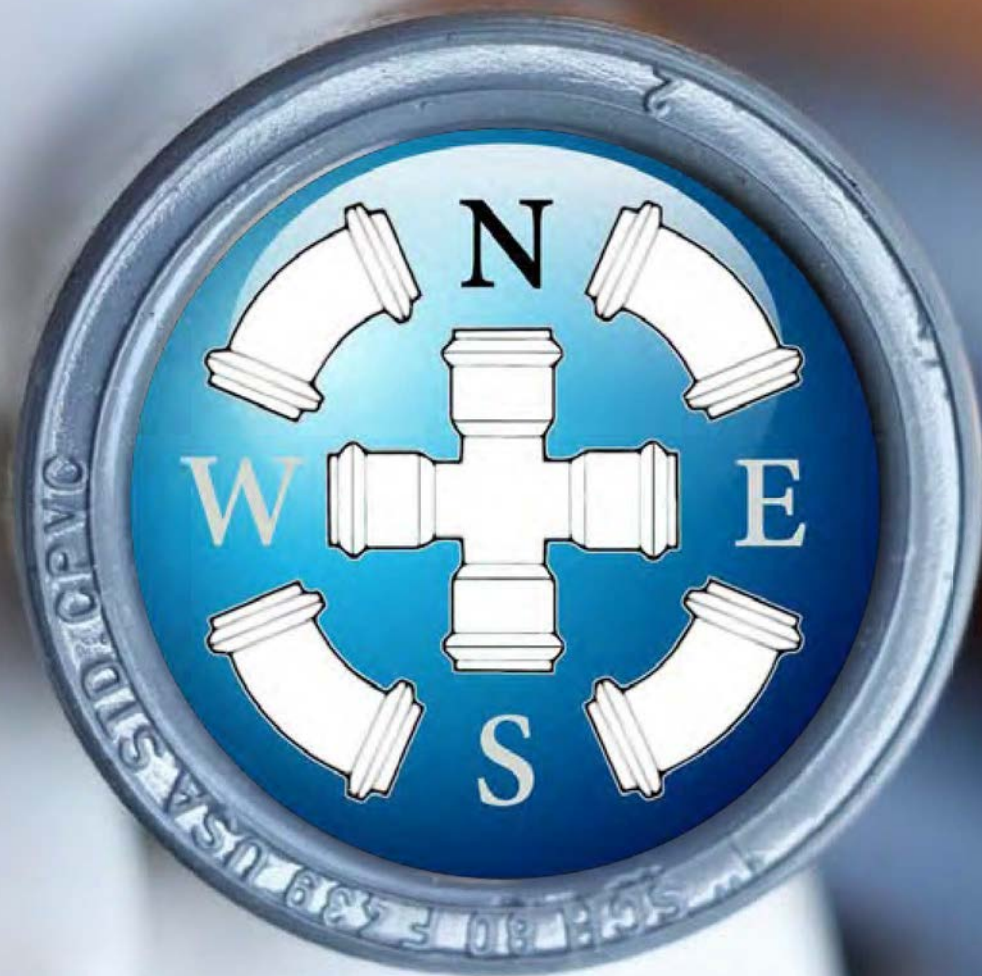

Specified **F**ittings

Duct Fittings

When looking for duct fittings, think of Specified Fittings. We provide a complete line of duct fittings 4" through 48" in PVC and CPVC--whether residential or commercial. Duct accessories such as blast gates, valve end dampers, and rain caps are also available. Our commercial ducting is predominantly made from Harvel duct, which meets all the relevant requirements pertaining to fire codes and material. Our duct fittings are available in a variety of configurations and used in a number of locations such as hospitals, chip plants, restaurants, schools, and automotive shops just to name a few. ■

Downspout Adapters

John Fogarty may have asked, "*Who'll stop the rain?*," and although Specified Fittings may not be able to stop the rain, we can certainly contain it with our vast array of downspout adapters. Whether connecting on the top end to square, rectangular, or round shapes, and adapting to plastic, aluminum, or steel material, we have mandrels for all. Downspouts are available in sizes 3"-24" for any material or shape. We are only limited by **your** imagination! ■

Expansion Joints

Although not in our catalog currently, you may be interested in Specified Fittings' complete line of SCH80 PVC and CPVC fabricated expansion joints. These O-ring style expansion joints are available with EPDM O-rings in both 6" and 12" travel, and sizes range from 1/2"-14". If looking for an alternative for this product from the big guy, we would be glad to quote you. ■



CAP

FEMALE



▪ Available in Smaller and Larger Sizes.

Size	PartNumber	PVC	CPVC
6	1906	\$98.58	\$189.09
7	1907	\$100.35	\$217.55
8	1908	\$108.20	\$225.29
9	1909	\$113.62	\$256.16
10	19010	\$108.20	\$262.66
11	19011	\$118.93	\$295.35
12	19012	\$118.34	\$299.93
14	19014	\$190.79	\$337.44
16	19016	\$207.91	\$387.75
18	19018	\$226.54	\$489.57
20	19020	\$337.64	\$702.93
24	19024	\$345.17	\$750.05

COUPLING

BELLED

FEMALE X FEMALE



▪ Available in Smaller and Larger Sizes.

Size	PartNumber	PVC	CPVC
6	2206	\$47.98	\$102.48
7	2207	\$54.76	\$122.41
8	2208	\$56.34	\$130.67
9	2209	\$64.43	\$158.98
10	22010	\$66.39	\$172.13
11	22011	\$74.22	\$191.02
12	22012	\$74.99	\$191.72
14	22014	\$82.25	\$237.20
16	22016	\$101.53	\$258.83
18	22018	\$148.33	\$323.56
20	22020	\$229.21	\$406.78
24	22024	\$310.30	\$500.38

SLEEVE

FEMALE X FEMALE



▪ Available in Smaller and Larger Sizes.

Size	PartNumber	PVC	CPVC
6	2406	\$39.65	\$109.73
7	2407	\$48.20	\$131.59
8	2408	\$52.15	\$140.92
9	2409	\$58.22	\$171.50
10	24010	\$58.74	\$185.75
11	24011	\$64.54	\$206.20
12	24012	\$64.18	\$207.00
14	24014	\$82.33	\$256.14
16	24016	\$91.09	\$279.69
18	24018	\$120.42	\$349.55
20	24020	\$151.16	\$440.31
24	24024	\$175.29	\$540.62

ELBOW

45 DEGREE

FEMALE X FEMALE

2-PIECE



▪ Available in Smaller and Larger Sizes.

Size	PartNumber	PVC	CPVC
6	3496	\$177.12	\$223.07
7	3497	\$197.78	\$273.78
8	3498	\$199.61	\$298.44
9	3499	\$231.23	\$368.40
10	34910	\$240.84	\$403.28
11	34911	\$269.04	\$467.77
12	34912	\$271.61	\$487.73
14	34914	\$320.22	\$601.32
16	34916	\$413.70	\$692.43
18	34918	\$575.75	\$933.20
20	34920	\$875.81	\$1,259.39
24	34924	\$1,056.49	\$1,770.80

3-PIECE



▪ Available in Smaller and Larger Sizes.

Size	PartNumber	PVC	CPVC
6	3506	\$169.83	\$301.83
7	3507	\$200.73	\$315.51
8	3508	\$191.37	\$299.16
9	3509	\$237.69	\$433.02
10	35010	\$235.98	\$525.64
11	35011	\$262.82	\$621.07
12	35012	\$260.39	\$657.35
14	35014	\$310.65	\$814.80
16	35016	\$396.65	\$972.66
18	35018	\$552.02	\$1,236.46
20	35020	\$864.46	\$1,770.62
24	35024	\$1,124.37	\$2,376.31

90 DEGREE

FEMALE X FEMALE

3-PIECE



▪ Available in Smaller and Larger Sizes.

Size	PartNumber	PVC	CPVC
6	3696	\$124.10	\$291.86
7	3697	\$146.37	\$358.58
8	3698	\$154.71	\$391.17
9	3699	\$169.26	\$484.67
10	36910	\$167.68	\$532.01
11	36911	\$197.09	\$613.31
12	36912	\$207.71	\$636.19
14	36914	\$245.38	\$799.57
16	36916	\$297.37	\$980.54
18	36918	\$434.03	\$1,235.42
20	36920	\$595.44	\$1,748.06
24	36924	\$774.89	\$2,338.35

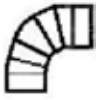
ELBOW**90 DEGREE****FEMALE X FEMALE****5-PIECE**

Available in Smaller and Larger Sizes.

Size	PartNumber	PVC	CPVC
6	3706	\$383.80	\$387.55
7	3707	\$413.13	\$505.47
8	3708	\$418.08	\$575.25
9	3709	\$486.43	\$727.97
10	37010	\$492.37	\$811.37
11	37011	\$570.14	\$945.32
12	37012	\$550.55	\$989.24
14	37014	\$606.17	\$1,160.21
16	37016	\$707.33	\$1,479.25
18	37018	\$933.93	\$1,925.05
20	37020	\$1,388.54	\$2,906.18
24	37024	\$1,769.55	\$3,822.20

VALVE**END BLAST GATE****FEMALE**

Size	PartNumber	PVC	CPVC
6	91106BG	\$296.59	\$664.86
7	91107BG	\$332.71	\$777.16
8	91108BG	\$337.15	\$815.44
9	91109BG	\$364.61	\$956.37
10	911010BG	\$357.35	\$1,006.24
11	911011BG	\$422.68	\$1,132.61
12	911012BG	\$447.76	\$1,151.13
14	911014BG	\$594.35	\$1,439.94
16	911016BG	\$660.48	\$1,699.21
18	911018BG	\$779.17	\$2,157.98
20	911020BG	\$884.32	\$2,611.09
24	911024BG	\$1,204.92	\$3,524.95

END DAMPER

Size	PartNumber	PVC	CPVC
6	91106ED	\$290.49	\$457.39
7	91107ED	\$309.70	\$502.44
8	91108ED	\$299.40	\$499.63
9	91109ED	\$337.24	\$600.96
10	911010ED	\$342.95	\$645.05
11	911011ED	\$372.99	\$749.59
12	911012ED	\$367.52	\$782.75
14	911014ED	\$492.07	\$937.35
16	911016ED	\$548.37	\$1,089.14
18	911018ED	\$744.26	\$1,391.17
20	911020ED	\$877.06	\$1,683.67
24	911024ED	\$1,133.52	\$2,283.57

FLANGE**BLIND**

Size	PartNumber	PVC	CPVC
6	4906	\$98.83	\$234.81
7	4907	\$116.98	\$264.93
8	4908	\$123.98	\$269.80
9	4909	\$136.90	\$312.50
10	49010	\$136.77	\$325.44
11	49011	\$158.11	\$358.71
12	49012	\$164.40	\$357.82
14	49014	\$209.22	\$425.02
16	49016	\$237.88	\$468.02
18	49018	\$289.72	\$665.41
20	49020	\$404.08	\$824.48
24	49024	\$434.98	\$1,099.96

BLIND SMACNA BOLT PATTERN

Size	PartNumber	PVC	CPVC
6	4916	\$105.18	\$249.80
7	4917	\$124.46	\$281.83
8	4918	\$131.89	\$287.03
9	4919	\$145.62	\$332.44
10	49110	\$145.49	\$346.21
11	49111	\$168.21	\$381.59
12	49112	\$174.90	\$380.64
14	49114	\$222.59	\$452.16
16	49116	\$253.06	\$502.94
18	49118	\$313.57	\$707.92
20	49120	\$429.85	\$877.09
24	49124	\$462.73	\$1,169.46

DUCT**FEMALE**

Size	PartNumber	PVC	CPVC
6	5106	\$102.17	\$233.28
7	5107	\$121.81	\$264.22
8	5108	\$129.86	\$270.01
9	5109	\$141.02	\$316.76
10	51010	\$138.76	\$333.33
11	51011	\$315.66	\$722.26
12	51012	\$161.87	\$354.53
14	51014	\$177.56	\$411.11
16	51016	\$229.05	\$478.41
18	51018	\$341.40	\$639.95
20	51020	\$418.76	\$777.03
24	51024	\$450.78	\$1,094.64

RAIN CAP

STYLE A

Size	PartNumber	PVC	CPVC
6	2016	\$750.79	\$893.44
7	2017	\$790.19	\$1,110.83
8	2018	\$754.33	\$1,222.45
9	2019	\$808.48	\$1,387.92
10	20110	\$785.63	\$1,421.22
11	20111	\$839.55	\$1,648.78
12	20112	\$813.50	\$1,719.32
14	20114	\$890.89	\$2,320.62
16	20116	\$972.43	\$2,648.12
18	20118	\$1,297.43	\$3,051.88
20	20120	\$1,380.63	\$4,455.66
24	20124	\$1,564.31	\$5,256.51

STYLE B

Size	PartNumber	PVC	CPVC
6	2026	\$709.11	\$799.84
7	2027	\$793.57	\$1,042.61
8	2028	\$802.45	\$1,186.09
9	2029	\$876.79	\$1,377.62
10	20210	\$867.64	\$1,437.95
11	20211	\$951.50	\$1,662.10
12	20212	\$944.74	\$1,727.94
14	20214	\$1,062.00	\$2,329.20
16	20216	\$1,288.32	\$2,652.20
18	20218	\$1,557.57	\$3,251.06
20	20220	\$1,787.07	\$4,781.47
24	20224	\$2,068.56	\$5,207.03

REDUCER

FEMALE X FEMALE

Size	PartNumber	PVC	CPVC
6x4	60064	\$62.68	\$200.05
7x4	60074	\$183.11	\$465.54
7x6	60076	\$77.65	\$183.14
8x4	60084	\$193.76	\$492.64
8x6	60086	\$82.17	\$193.79
8x7	60087	\$81.96	\$193.30
9x4	60094	\$223.80	\$569.00
9x6	60096	\$94.91	\$223.82
9x7	60097	\$94.67	\$223.27
9x8	60098	\$94.44	\$222.71
10x4	600104	\$362.17	\$678.63
10x6	600106	\$225.16	\$502.47
10x7	600107	\$173.64	\$398.75
10x8	600108	\$105.58	\$257.06
10x9	600109	\$267.21	\$638.45
12x4	600124	\$403.39	\$959.02
12x6	600126	\$389.57	\$759.67
12x7	600127	\$352.52	\$745.50
12x8	600128	\$281.90	\$660.34
12x9	600129	\$212.52	\$531.30
12x10	6001210	\$122.89	\$351.66
12x11	6001211	\$590.55	\$831.31
14x4	600144	\$1,001.96	\$1,231.80
14x6	600146	\$725.91	\$985.46
14x7	6001147	\$605.19	\$957.13
14x8	600148	\$426.81	\$837.66
14x9	600149	\$409.19	\$890.41
14x10	6001410	\$352.59	\$858.37
14x11	6001411	\$291.02	\$703.37
14x12	6001412	\$201.72	\$481.38
16x4	600164	\$1,210.27	\$1,604.48
16x6	600166	\$980.38	\$1,277.47
16x7	600167	\$885.93	\$1,239.03
16x8	600168	\$707.10	\$1,082.60
16x9	600169	\$629.45	\$1,108.12
16x10	6001610	\$491.86	\$1,028.10
16x11	6001611	\$478.26	\$1,064.99
16x12	6001612	\$419.13	\$1,000.45
16x14	6001614	\$227.96	\$618.48
18x4	600184	\$1,512.02	\$1,940.53
18x6	600186	\$1,235.05	\$1,558.68
18x7	600187	\$1,204.18	\$1,511.78
18x8	600188	\$1,058.60	\$1,320.90
18x9	600189	\$935.35	\$1,350.16
18x10	6001810	\$723.02	\$1,250.84
18x11	6001811	\$705.88	\$1,289.35
18x12	6001812	\$621.52	\$1,205.06
18x14	6001814	\$524.71	\$1,171.67
18x16	6001816	\$261.83	\$726.92
20x4	600204	\$1,806.90	\$2,529.71
20x6	600206	\$1,546.87	\$2,040.11
20x7	600207	\$1,474.16	\$1,983.51
20x8	600208	\$1,261.06	\$1,738.01
20x9	600209	\$1,257.43	\$1,773.24
20x10	6002010	\$1,134.06	\$1,639.60
20x11	6002011	\$1,115.39	\$1,686.20
20x12	6002012	\$990.48	\$1,572.20
20x14	6002014	\$742.83	\$1,483.25
20x16	6002016	\$723.68	\$1,456.79
20x18	6002018	\$461.84	\$1,061.82
24x4	600244	\$2,307.80	\$3,250.20
24x6	600246	\$2,064.03	\$2,618.10
24x7	600247	\$2,025.98	\$2,560.18
24x8	600248	\$1,794.99	\$2,258.43
24x9	600249	\$1,746.63	\$2,294.97
24x10	6002410	\$1,531.93	\$2,112.95
24x11	6002411	\$1,482.84	\$2,176.96
24x12	6002412	\$1,292.54	\$2,033.64
24x14	6002414	\$1,137.42	\$1,918.52
24x16	6002416	\$932.39	\$1,813.33
24x18	6002418	\$856.38	\$1,750.75
24x20	6002420	\$840.19	\$1,685.54

DUCT FITTINGS



TEE

FEMALE X FEMALE X FEMALE

Size	PartNumber	PVC	CPVC
6x4	82064	\$249.67	\$355.05
6	8206	\$224.19	\$548.85
7x4	82074	\$245.65	\$386.68
7x6	82076	\$260.36	\$448.27
7	8207	\$258.95	\$633.91
8x4	82084	\$259.95	\$409.18
8x6	82086	\$275.52	\$474.35
8x7	82087	\$274.83	\$473.17
8	8208	\$285.34	\$548.85
9x4	82094	\$300.24	\$472.60
9x6	82096	\$318.22	\$547.88
9x7	82097	\$317.42	\$546.51
9x8	82098	\$316.63	\$545.15
9	8209	\$329.56	\$633.91
10x4	820104	\$292.64	\$511.99
10x6	820106	\$306.13	\$586.12
10x7	820107	\$358.73	\$645.56
10x8	820108	\$377.18	\$643.53
10x9	820109	\$386.98	\$741.04
10	82010	\$359.92	\$767.97
12x4	820124	\$351.27	\$590.01
12x6	820126	\$396.53	\$629.99
12x7	820127	\$430.05	\$733.69
12x8	820128	\$422.63	\$767.52
12x9	820129	\$479.10	\$875.37
12x10	8201210	\$489.96	\$899.84
12x11	8201211	\$465.42	\$959.88
12	82012	\$396.54	\$928.50
14x4	820144	\$395.26	\$746.86
14x6	820146	\$428.17	\$785.83
14x7	820147	\$465.01	\$872.46
14x8	820148	\$457.59	\$876.00
14x9	820149	\$504.57	\$994.50
14x10	8201410	\$503.50	\$1,018.27
14x11	8201411	\$574.76	\$1,089.63
14x12	8201412	\$591.26	\$1,057.21
14	82014	\$461.25	\$1,089.81
16x4	820164	\$437.36	\$821.56
16x6	820166	\$464.82	\$864.79
16x7	820167	\$519.85	\$958.48
16x8	820168	\$525.37	\$960.88

FEMALE X FEMALE X FEMALE

Size	PartNumber	PVC	CPVC
16x9	820169	\$583.26	\$1,091.06
16x10	8201610	\$585.59	\$1,117.34
16x11	8201611	\$637.04	\$1,213.00
16x12	8201612	\$627.83	\$1,193.14
16x14	8201614	\$710.38	\$1,373.89
16	82016	\$594.22	\$1,350.36
18x4	820184	\$488.01	\$1,038.65
18x6	820186	\$512.03	\$1,116.86
18x7	820187	\$573.87	\$1,209.32
18x8	820188	\$581.06	\$1,186.60
18x9	820189	\$638.31	\$1,292.83
18x10	8201810	\$634.77	\$1,275.93
18x11	8201811	\$707.27	\$1,382.48
18x12	8201812	\$712.41	\$1,357.37
18x14	8201814	\$777.11	\$1,529.29
18x16	8201816	\$900.31	\$1,584.16
18	82018	\$782.00	\$1,607.36
20x4	820204	\$550.94	\$1,245.77
20x6	820206	\$566.90	\$1,299.21
20x7	820207	\$634.49	\$1,448.48
20x8	820208	\$641.64	\$1,459.80
20x9	820209	\$690.64	\$1,566.38
20x10	8202010	\$673.87	\$1,523.78
20x11	8202011	\$760.44	\$1,651.03
20x12	8202012	\$774.57	\$1,621.04
20x14	8202014	\$854.07	\$1,743.08
20x16	8202016	\$999.97	\$1,943.14
20x18	8202018	\$1,196.00	\$2,223.25
20	82020	\$1,149.16	\$2,227.57
24x4	820244	\$578.35	\$1,441.57
24x6	820246	\$603.51	\$1,657.97
24x7	820247	\$681.01	\$1,796.43
24x8	820248	\$693.65	\$1,763.79
24x9	820249	\$778.00	\$1,900.73
24x10	8202410	\$788.26	\$1,856.65
24x11	8202411	\$896.06	\$2,034.25
24x12	8202412	\$918.51	\$2,018.10
24x14	8202414	\$1,014.99	\$2,169.99
24x16	8202416	\$1,120.40	\$2,308.50
24x18	8202418	\$1,334.58	\$2,703.02
24x20	8202420	\$1,531.97	\$3,083.48
24	82024	\$1,535.89	\$3,180.73

WYE

FEMALE X FEMALE X FEMALE



Size	PartNumber	PVC	CPVC
6x4	92064	\$301.01	\$301.01
6	9206	\$308.88	\$308.88
7x4	92074	\$311.06	\$311.06
7x6	92076	\$326.35	\$326.35
7	9207	\$351.91	\$351.91
8x4	92084	\$329.16	\$329.16
8x6	92086	\$345.35	\$345.35
8x7	92087	\$344.48	\$344.48
8	9208	\$372.39	\$372.39
9x4	92094	\$380.19	\$380.19
9x6	92096	\$398.88	\$398.88
9x7	92097	\$397.88	\$397.88
9x8	92098	\$396.88	\$396.88
9	9209	\$430.11	\$430.11
10x4	920104	\$374.53	\$374.53
10x6	920106	\$401.50	\$401.50
10x7	920107	\$441.97	\$441.97
10x8	920108	\$440.35	\$440.35
10x9	920109	\$439.25	\$439.25
10	92010	\$461.60	\$461.60
12x4	920124	\$409.84	\$409.84
12x6	920126	\$431.26	\$431.26
12x7	920127	\$483.29	\$483.29
12x8	920128	\$489.28	\$489.28
12x9	920129	\$544.48	\$544.48
12x10	9201210	\$547.83	\$547.83
12x11	9201211	\$610.55	\$610.55
12	92012	\$615.11	\$615.11
14x4	920144	\$478.99	\$478.99
14x6	920146	\$512.56	\$512.56
14x7	920147	\$557.47	\$557.47
14x8	920148	\$549.31	\$549.31
14x9	920149	\$617.70	\$617.70
14x10	9201410	\$627.27	\$627.27
14x11	9201411	\$698.60	\$698.60
14x12	9201412	\$703.40	\$703.40
14	92014	\$712.26	\$712.26
16x4	920164	\$568.38	\$568.38
16x6	920166	\$607.98	\$607.98
16x7	920167	\$649.88	\$649.88
16x8	920168	\$629.89	\$629.89

FEMALE X FEMALE X FEMALE

Size	PartNumber	PVC	CPVC
16x9	920169	\$680.48	\$680.48
16x10	9201610	\$666.26	\$666.26
16x11	9201611	\$731.92	\$731.92
16x12	9201612	\$727.87	\$727.87
16x14	9201614	\$827.60	\$827.60
16	92016	\$820.86	\$820.86
18x4	920184	\$668.56	\$668.56
18x6	920186	\$697.37	\$697.37
18x7	920187	\$764.80	\$764.80
18x8	920188	\$759.38	\$759.38
18x9	920189	\$817.08	\$817.08
18x10	9201810	\$796.94	\$796.94
18x11	9201811	\$859.11	\$859.11
18x12	9201812	\$839.47	\$839.47
18x14	9201814	\$953.55	\$953.55
18x16	9201816	\$1,116.63	\$1,116.63
18	92018	\$1,171.97	\$1,171.97
20x4	920204	\$752.82	\$752.82
20x6	920206	\$801.18	\$801.18
20x7	920207	\$867.31	\$867.31
20x8	920208	\$850.84	\$850.84
20x9	920209	\$919.01	\$919.01
20x10	9202010	\$899.66	\$899.66
20x11	9202011	\$974.00	\$974.00
20x12	9202012	\$955.58	\$955.58
20x14	9202014	\$1,016.24	\$1,016.24
20x16	9202016	\$1,214.09	\$1,214.09
20x18	9202018	\$1,396.91	\$1,396.91
20	92020	\$1,479.87	\$1,479.87
24x4	920244	\$904.35	\$904.35
24x6	920246	\$955.48	\$955.48
24x7	920247	\$1,050.49	\$1,050.49
24x8	920248	\$1,045.44	\$1,045.44
24x9	920249	\$1,155.22	\$1,155.22
24x10	9202410	\$1,154.98	\$1,154.98
24x11	9202411	\$1,252.29	\$1,252.29
24x12	9202412	\$1,230.34	\$1,230.34
24x14	9202414	\$1,347.28	\$1,347.28
24x16	9202416	\$1,404.77	\$1,404.77
24x18	9202418	\$1,593.58	\$1,593.58
24x20	9202420	\$1,801.26	\$1,801.26
24	92024	\$1,942.40	\$1,942.40

DUCT FITTINGS

The Creation of a PVC Pipe Fitting...

Many of you spend your days in an office with your eyes focused on a computer screen. You make calls, receive or submit orders, sell fittings to your customers, talk the fittings talk, see the product in the field, but have you ever wondered just how a fitting is made? We've displayed below the process of a PVC C-900 x Sewer Reducing Wye from its beginnings in Specified Fittings' pipe yard to its packaging stage in our Shipping Department.

Start



1 One sunny, spring day in Bellingham, a lift of 8" DR18 pipe sat in Specified Fittings' pipe yard, waiting for their life as fittings to begin. A forklift suddenly appeared, grabbed a stick of pipe, and whisked it off to the Saw Room.



2 Busy Saw Room workers cut the stick to length, marked the desired fitting on the pieces, and moved them to the next station to be beveled.



3 Once beveled, another Specified employee carefully bored a hole into each piece's center and pulled it for an outlet to be installed.



Finish



6 The pieces, now labeled by QC as 8"x4" Gasketed DR18 x SDR35 Wyes, were packed neatly in layers by the Specified Fittings Shipping Crew, where they awaited a freight truck to transport them to a customer's destination. It had been a busy day!



5 A gluer efficiently solvent welded a 4" D3034 gasket branch into each piece, and sent them on their way to Quality Control to be cleaned, labeled, and inspected.



4 Next stop on the pieces' journey: the press belled the ends, and gaskets were installed. They were ready to be sent to the Gluing Department.

DRAIN BASINS



Specified Fittings



INLINE DRAINS AND CATCH BASINS

(Nominal Inlet/Outlet Sizes Available)

SCH40 DWV	SDR35		F949 PROFILE ^b	PIP	POLYETHYLENE ^c
6	6	6	6	6	6
8	8	8	8	8	8
10	10	10	10	10	10
12	12	12	12	12	12
14				14	
	15	15	15	15	15
16				16	
18	18	18	18	18	18
20				20	
	21	21	21	21	21
24	24	24	24	24	24
	27	27		27	
	30	30	30		30
		33			
	36	36	36		36
	42	42	42		42
	48	48	48		48

^a Products include J-M Perma-Loc™, Ultra-Rib™, Vylon™, Pro21™ etc.

^b Products include Ultra-Corr™, A-2000™.

^c Please indicate brand name.

Whether you need price and availability, technical information or submittal drawings, customer service is always just a phone call away. Our offices are open from 6 AM to 5:00 PM PST/PDT.

You may e-mail us your comments, requests for quotation or orders to spec@specfit.com. RFQ's received before 2 PM PST/PDT are answered the same day.

Can't find what you need in the catalog? Don't know where to look? Call customer service for assistance.

Need an item on site fast and can't wait for the traditional carriers? Let us use our contacts to find a carrier who can get it to you on your timetable, not theirs.

CATCH BASINS ^{1, 2, 4}

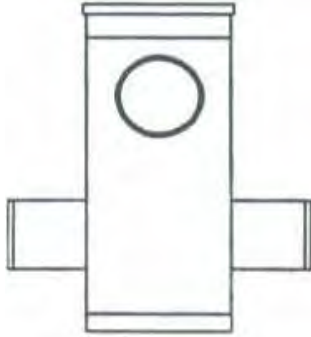

Basin w/ Round Grate	Outlet Sizes	Height 12" - 60"	Height 61" - 120"
8" Basin W/ Grate	4" - 8"	\$240.00	\$300.00
10" Basin W/ Grate	4" - 10"	\$320.00	\$400.00
12" Basin W/ Grate	4" - 12"	\$500.00	\$660.00
15" Basin W/ Grate	4" - 15"	\$700.00	\$890.00
18" Basin W/ Grate	4" - 18"	\$920.00	\$1,025.00
24" Basin W/ Grate	4" - 24"	\$1,240.00	\$1,450.00
30" Basin W/ Grate	4" - 30"	CF	CF
36" Basin W/ Grate	4" - 36"	CF	CF

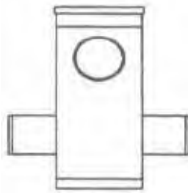

Side View

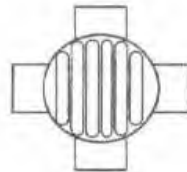

Top View

(See page 12 for detailed drawing).

¹ Up to 4 outlets at the same price.

² Size on size basins will fit up to 2 size on size inlet/outlet(s).

³ Standard height invert to top of grate. **BECAUSE FRAME & GRATE FIT RESPECTIVELY THE OD AND ID OF THE BASIN TOP, YOU MAY WANT TO ORDER LONGER BASIN AND FIELD CUT TO GRADE.**

⁴ 24,30,36,42 & 48 catch basins only -- add 53.33 list for each outlet up to 18" in excess of one, add 133.33 for each outlet 24" and up in excess of one.

Specified Fittings will not pay freight on orders of 30" or larger Basins. Or any Basin that is taller than 80" (OAL).

CATCH BASIN BAFFLES 1, 2, 4, 5

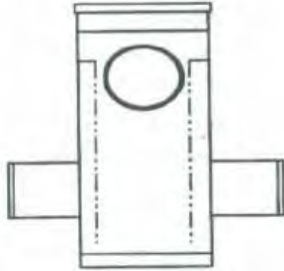

(See page 13 for detailed drawing).

Standard			List Price (including grate)
Size	Height ⁶	Part No.	
6	13	932936 *	CF
8	13	932938 *	CF
10	20	9329310 *	CF
12	24	9329312 *	CF
15	30	9329315 *	CF
18	36	9329318 *	CF
24 ²	36	9329324 *	CF
30 ²	48	9329330*	CF
36 ²	48	9329336*	CF
48 ²	48	9329348*	CF

* Basic part number

Catch basin drains may be furnished with internal baffle. This option gives the user an inexpensive way to remove various kinds of floating debris and regulate flow from the basin. Because this unit is made entirely from maximum walled SDR35-F679 material, it has resistance to the same array of pure and diluted chemicals as the pipe, thus eliminating any concerns that might arise about the overall efficacy of the structure.

APPLICATIONS

Oil/Water Separator

Baffle will trap and separate hydrocarbons from the water run off. "Floating" residue must be periodically collected with the use of vacuum equipment.

Sediment Filter

Drain basins equipped with slotted baffles can be used for sediment collection. Regular cleaning should be performed to maintain maximum efficiency of the catch basin drain. Where levels of sedimentation may be heavier than usual, more frequent cleaning will be required.

Foul Air Control

The baffle functions as a foul air trap. This is particularly useful in sanitary and leachate systems.

Flow Control

Whether for a one-hundred year flood or controlling flow into a city treatment plant, the catch basin drain equipped with an internal baffle can accommodate and regulate flow by selective sizing.

¹ Up to 4 outlets at the same price.

² For drains with outlets dissimilar in size, type or position, please contact factory.

³ You may order catch basins any length and field cut to grade.

⁴ Standard height invert to top of grate. **BECAUSE FRAME & GRATE FIT RESPECTIVELY THE OD AND ID OF THE BASIN TOP, YOU MAY WANT TO ORDER LONGER BASIN AND FIELD CUT TO GRADE.**

⁵ 24,30,36,42 & 48 catch basins only -- add 53.33 list for each outlet up to 18" in excess of one, add 133.33 for each outlet 24" and up in excess of one.

EXTENSION RISER, CATCH BASIN

(Price per lineal foot)



Size	Part No.	List Price
6	932946 *	\$26.40
8	932948 *	\$26.40
10	9329410*	\$26.40
12	9329412*	\$31.00
15	9329415*	\$40.00
18	9329418*	\$65.00
24	9329424*	\$103.32
30	9329430*	CF
36	9329436*	CF
42	9329442*	CF
48	9329448*	CF

* Basic part number

GRATES (LIST PRICES)

Size	Domed	Hinged	Locking Top	Pedestrian	Solid	Epoxy Coated
8	\$100.00	Not available	\$100.00	No add'l charge	\$5.86	\$400.00
10 w/ Frame	\$199.00	Not available	\$100.00	No add'l charge	\$5.86	\$400.00
12 w/ Frame	\$350.34	NO ADD'L CHARGE	\$100.00	No add'l charge	\$35.20	\$400.00
15 w/ Frame	\$402.65	NO ADD'L CHARGE	\$100.00	No add'l charge	\$42.54	\$400.00
18 w/ Frame	\$434.91	Not available	\$100.00	No add'l charge	\$51.34	\$400.00
24 w/ Frame	\$831.48	Not available	\$100.00	No add'l charge	\$71.49	\$400.00
30 w/ Frame	CF	Not available	\$100.00	CF	CF	CF
36 w/ Frame	CF	Not available	\$100.00	CF	CF	CF
48 w/ Frame	CF	Not available	\$100.00	CF	CF	CF

IMPORTANT

IF GRATE STYLE OTHER THAN FLAT IS DESIRED, ADD LIST PRICES ABOVE TO COST OF DRAIN.

STANDARD GRATE FEATURES:

- Grates are flat with linear openings and are bicycle safe.
- Grates are ductile iron.
- Grates are H-20 rated.

SPECIAL GRATE FEATURES:

- Grates can be provided domed, pedestrian friendly, solid, locking top, epoxy-coated H-20 rated. Contact factory for details.

HOW TO ORDER:

CATCH BASIN:

1. Select basic part number.
2. Determine outlet size(s) desired. 8" = 8; 12" = 12; 24" =
3. Select type of pipe connection from codes listed below.
4. Indicate number of outlets
5. Be sure to indicate if outlet(s) is (are) solvent weld end or gasket end.
6. **SEE CONVENIENT ORDER FORM ON PAGE 28.**

Example:

	P/N	OUTLET SIZE	PIPE	NO./OUTLETS
18" catch basin with two 15" sewer outlets =	<u>9329318</u>	<u>15</u>	SWR	2
24" catch basin with two 18" Perma-Loc™ outlets =	<u>9329324</u>	<u>18</u>	PLC	2
24" catch basin with three 12" C-900 outlets =	<u>9329324</u>	<u>12</u>	CDD	3

Pipe Connection Codes:

ACO = A-2000 C _i	PLC = Perma-Loc™
ADS = N12™	P21 = Pro21™
CDD = AWWA cast iron dimension	SWR = SDR35/F679 Sewer
HAN = Hancor Sure-Lok™	ULC = Ultra-Corr™
IPS = Iron pipe size	ULR = Ultra-Rib™
PIP = Plastic irrigation pipe	VYL = Vylon™
CRU = Crumpler	LAN = Lane™
QC = Quality Culvert	PRI = Princo

EXTENSION RISER:

1. Select basic part number.
2. Designate riser length (in inches). 8" = 8; 12" = 12; 24" = 24, etc

Example:

	BASIC P/N	LENGTH
25" extension riser for 24" catch basin drain =	<u>9329424</u>	<u>25</u>
8" extension riser for 15" catch basin drain =	<u>9329415</u>	<u>8</u>
100" extension riser for 18" catch basin drain =	<u>9329418</u>	<u>100</u>

Risers are available in any length desired and are billed in increments of whole lineal feet. Fractions of feet will be rounded up to the nearest foot.

INLINE DRAIN



(See page 14 for detailed drawing)

In-Line Drain with Grate	Outlet Sizes	Price (including grate)
8" In-Line Drain W/ Grate	4" - 8"	\$72.00
10" In-Line Drain W/ Grate	4" - 10"	\$90.00
12" In-Line Drain W/ Grate	4" - 12"	\$300.00
15" In-Line Drain W/ Grate	4" - 15"	\$350.00
18" In-Line Drain W/ Grate	4" - 18"	\$460.00
24" In-Line Drain W/ Grate	4" - 24"	\$1,050.00
30" In-Line Drain W/ Grate	4" - 30"	CF
36" In-Line Drain W/ Grate	4" - 36"	CF

How to order inline drain:

1. Select basic part number.
2. Select outlet size. 8" = 8; 12" = 12; 24" = 24, etc.
3. Select type of pipe connection from codes listed below.
4. Be sure to indicate if outlet(s) is (are) solvent weld end or gasket end.

Example:

18" inline drain with 8" PIP connection =	9329218	8	PIP
24" inline drain with 24" Ultra-Corr TM connection =	9329224	24	ULC

Pipe Connection Codes:

ACO = A-2000 ContechTM

ADS = N12TM

CDD = AWWA cast iron dimension

HAN = Hancor Sure-LokTM

IPS = Iron pipe size

PIP = Plastic irrigation pipe

CRU = Crumpler

QC = Quality Culvert

QUA = QUAIL

PLC = Perma-LocTM

P21 = Pro21TM

SWR = SDR35/F679 sewer

ULC = Ultra-CorrTM

ULR = Ultra-RibTM

VYL = VylonTM

LAN = LaneTM

PRI = Princo

Specified Fittings will not pay freight on orders of 30" or larger Inline Drain.

DRAIN, STORMWATER DEBRIS CATCH BASIN

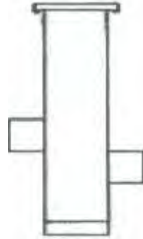

(See page 15 for detailed drawing).

Size	Part No.	List Price
8X4X4	93295844DWV	\$300.00
CAP FOR ABOVE	931908	\$75.00
8" BUCKET	93 BUCKET	\$71.00

The stormwater debris catch basin is used to filter leaves, needles and other debris carried in stormwater for subsurface disposal. The stormwater enters through the inlet and is filtered through slotted PVC pipe before flowing out again through the outlet. The cap at the top of the basin is removable for easy cleaning.

BACK WATER VALVE ¹

Prevents backflow in drain lines and eliminates backup when water levels rise. Four- and six-inch valves are injection molded PVC. Eight-inch through twelve-inch valves are fabricated from PVC pipe.

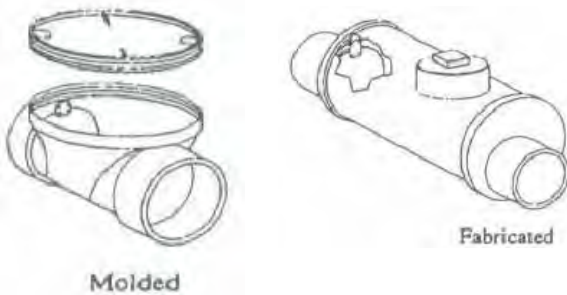

Size	Part No.	List Price
4	__ 9114 *	\$75.00
6	__ 9116 *	\$180.00
8	__ 9118 *	\$360.00
10	__ 91110 *	\$730.00
12	__ 91112 *	\$850.00

* Basic part number

How to order backwater valve:

1. Select type of pipe connection from codes listed below.
2. Select basic part number.

Pipe Connection Codes:

D3034 Sewer	81
IPS	73
PIP	07

Example:

8" backwater valve with IPS outlet =	73	9118
12" backwater valve with D3034 outlet =	81	91112

¹ Other outlets available. Contact factory for details.

ACCESSORIES

NET PRICE SHEET FOR SDR35 SWR X HDPE CORRUGATED ADAPTERS

4" GxS SWR SWR x HDPE ADAPTER	\$45.68
6" GxS SWR SWR x HDPE ADAPTER	\$79.13
8" GxS SWR SWR x HDPE ADAPTER	\$110.05
10" GxS SWR SWR x HDPE ADAPTER	\$171.88
12" GxS SWR SWR x HDPE ADAPTER	\$218.93
15" GxS SWR SWR x HDPE ADAPTER	CF
18" GxS SWR SWR x HDPE ADAPTER	CF
24" GxS SWR SWR x HDPE ADAPTER	CF
30" GxS SWR SWR x HDPE ADAPTER	CF
36" GxS SWR SWR x HDPE ADAPTER	CF

NET PRICE SHEET FOR SDR35 SWR X HDPE CORRUGATED ADAPTERS

4" SxS SWR SWR x HDPE ADAPTER	\$43.40
6" SxS SWR SWR x HDPE ADAPTER	\$75.16
8" SxS SWR SWR x HDPE ADAPTER	\$104.53
10" SxS SWR SWR x HDPE ADAPTER	\$155.00
12" SxS SWR SWR x HDPE ADAPTER	\$203.53
15" SxS SWR SWR x HDPE ADAPTER	CF
18" SxS SWR SWR x HDPE ADAPTER	CF
24" SxS SWR SWR x HDPE ADAPTER	CF
30" SxS SWR SWR x HDPE ADAPTER	CF
36" SxS SWR SWR x HDPE ADAPTER	CF

NET PRICE SHEET FOR HDPE x FIPT ADAPTERS

4" SxFIPT HDPE x IPS WITH PLUG	\$59.88
6" SxFIPT HDPE x IPS WITH PLUG	\$109.83
8" SxFIPT HDPE x IPS WITH PLUG	\$142.36
10" SxFIPT HDPE x IPS WITH PLUG	\$366.76
12" SxFIPT HDPE x IPS WITH PLUG	\$450.82
15" SxFIPT HDPE x IPS WITH PLUG	CF
18" SxFIPT HDPE x IPS WITH PLUG	CF
24" SxFIPT HDPE x IPS WITH PLUG	CF

CATCH BASIN DRAIN

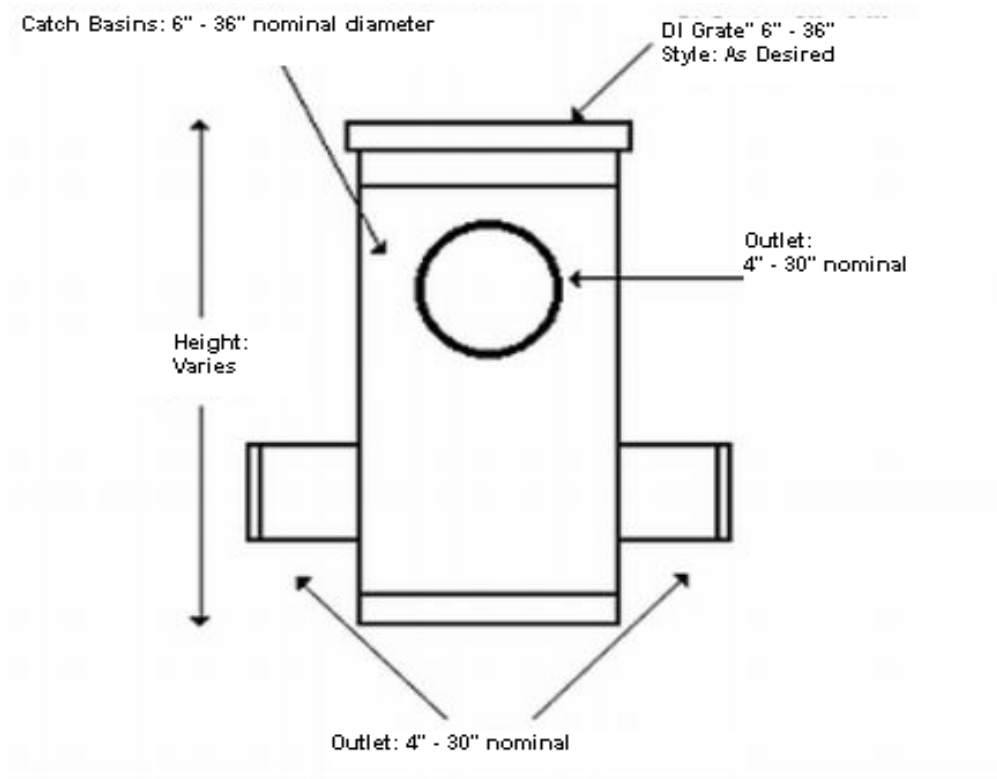

(Not to scale. Due to various factors affecting the production process, all dimensions are approximate).

Material meets the requirements of ASTM D3034/SDR35 including but not limited to the following:

- D1784 Specification for rigid poly (vinyl chloride) (PVC) compounds and chlorinated poly (vinyl chloride) (CPVC) compounds
- D2321 Practice for underground installation of flexible thermoplastic sewer pipe
- D2412 Test method for external loading properties of plastic pipe by parallel-plate loading
- D2444 Test method for impact resistance of thermoplastic pipe & fittings by means of a TUP (falling weight)
- D2855 Practice for making solvent-cemented joints with poly (vinyl chloride) (PVC) pipe & fittings

CATCH BASIN DRAIN WITH BAFFLE

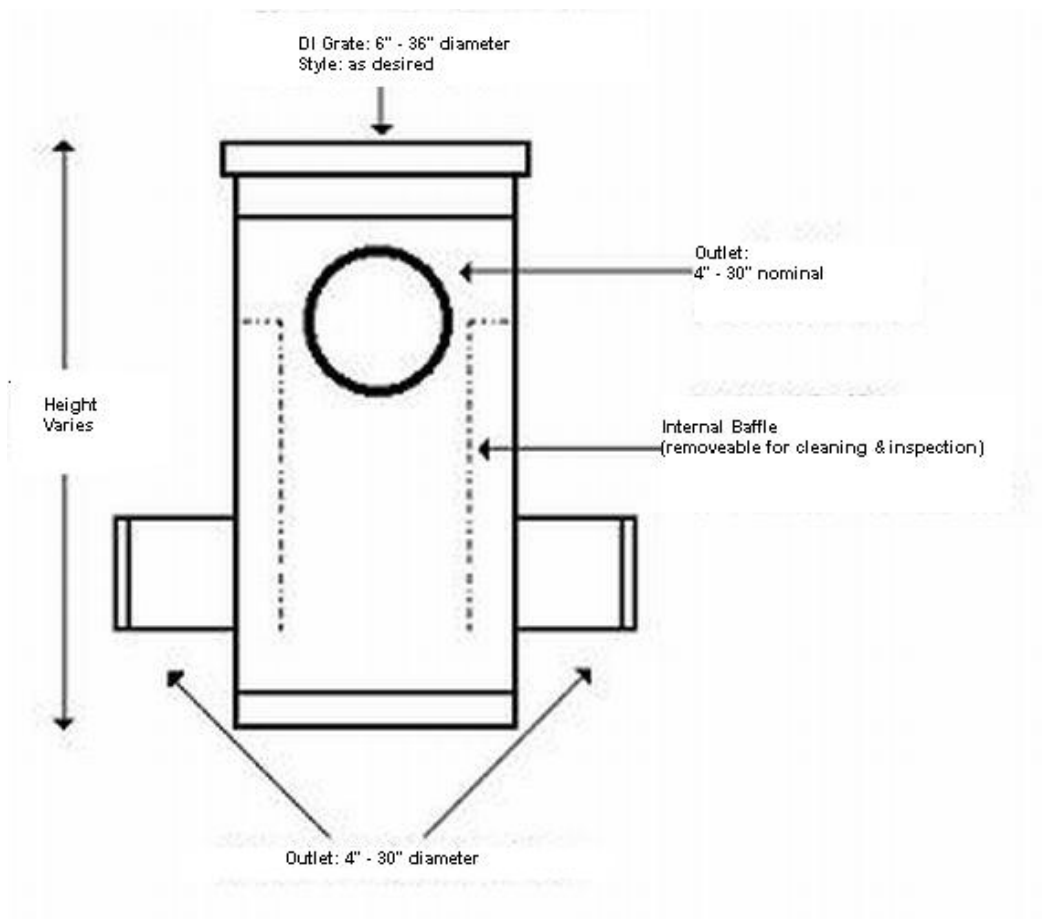

(Not to scale. Due to various factors affecting the production process, all dimensions are approximate).

Material meets the requirements of ASTM D3034/SDR35/F679/F1336 including but not limited to the following:

- D1784 Specification for rigid poly (vinyl chloride) (PVC) compounds and chlorinated poly (vinyl chloride) (CPVC) compounds
- D2321 Practice for underground installation of flexible thermoplastic sewer pipe
- D2412 Test method for external loading properties of plastic pipe by parallel-plate loading
- D2444 Test method for impact resistance of thermoplastic pipe & fittings by means of a TUP (falling weight)
- D2855 Practice for making solvent-cemented joints with poly (vinyl chloride) (PVC) pipe & fittings

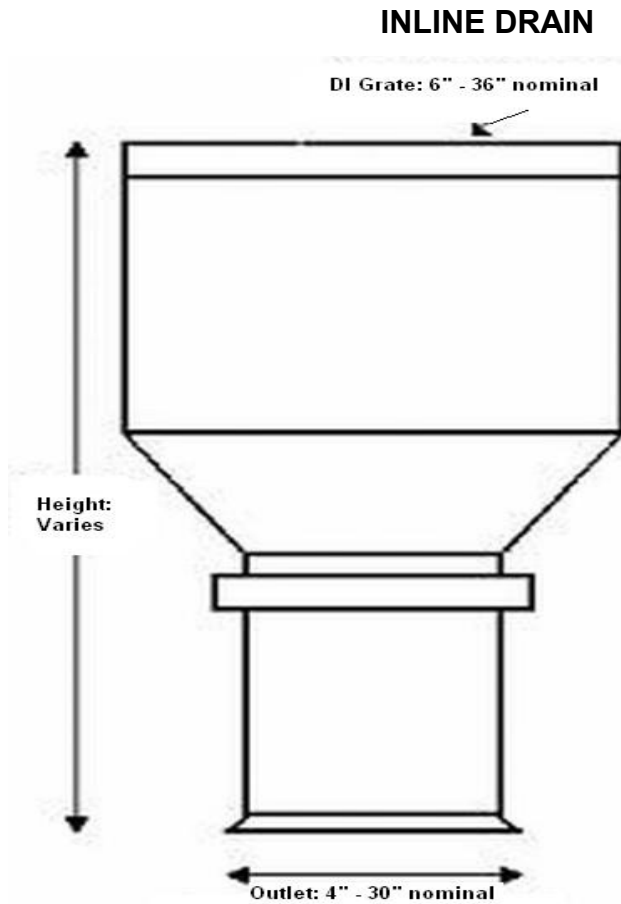

(Not to scale. Due to various factors affecting the production process, all dimensions are approximate.)

Material meets the requirements of ASTM D3034/SDR35 including but not limited to the following:

- D1784 Specification for rigid poly (vinyl chloride) (PVC) compounds and chlorinated poly (vinyl chloride) (CPVC) compounds
- D2321 Practice for underground installation of flexible thermoplastic sewer pipe
- D2412 Test method for external loading properties of plastic pipe by parallel-plate loading
- D2444 Test method for impact resistance of thermoplastic pipe & fittings by means of a TUP (falling weight)
- D2855 Practice for making solvent-cemented joints with poly (vinyl chloride) (PVC) pipe & fittings

STORMWATER DEBRIS CATCH BASIN DRAIN

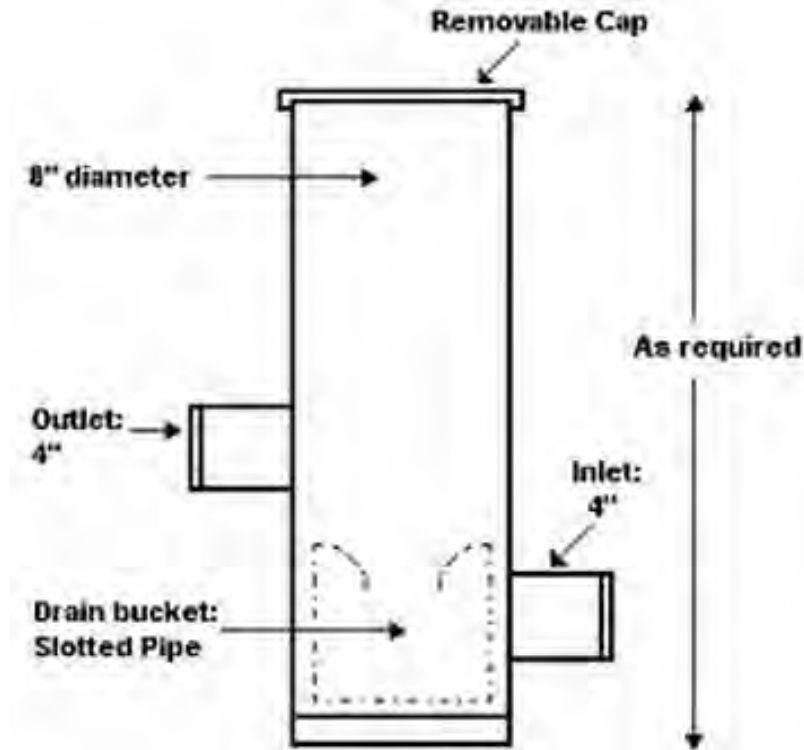

(Not to scale. Due to various factors affecting the production process, all dimensions are approximate).

The basin will handle up to 164 gallons a minute when there are no obstructions.

Material meets the requirements of ASTM D3034/SDR35

Housing:	8" class 63 PVC pipe per ASTM D1785
Drain bucket:	PVC slotted pipe meeting requirements of ASTM D1785
Removable cap:	PVC pipe meeting requirements of ASTM D1784

ADS/NYLOPLAST INLINE DRAIN CROSS REFERENCE CHART

THEIR PART NUMBER	OUR PART NUMBER
	932964
	9329266
2708AG4N	9329284
2708AG6N	9329286
2708AG	9329288
2710AG4N	93292104
2710AG6N	93292106
2710AG8N	93292108
2710AG	932921010
2712AG4N	93292124*
2712AG6N	93292126*
2712AG8N	93292128*
2712AG10N	932921210*
2712AG12N	932921212*
2715AG4N	93292154*
2715AG6N	93292156*
2715AG8N	93292158*
2715AG10N	932921510*
2715AG12N	932921512*
2715AG15N	932921515*
2718AG4N	93292184
2718AG6N	93292186
2718AG8N	93292188
2718AG10N	932921810
2718AG12N	932921812
2718AG15N	932921815
2718AG18N	932921818
2724AG4N	93292244
2724AG6N	93292246
2724AG8N	93292248
2724AG10N	932922410
2724AG12N	932922412
2724AG15N	932922415
2724AG18N	932922418
2724AG24N	932922424

* We ship our drains with round grates standard. ADS/Nyloplast ship their 12" and 15" drains with hinged grates standard. Please be sure to specify if hinged grates are desired.

ADS/NYLOPLAST CATCH BASIN CROSS REFERENCE CHART

THEIR PART NUMBER
2808AG
2810AG
2812AG
2815AG
2818AG
2824AG

OUR PART NUMBER
932938##
9329310##
9329312##*
9329315##*
9329318##
9329324##

ADS/NYLOPLAST RISER EXTENSION CROSS REFERENCE CHART

THEIR PART NUMBER
2908AG (Specify length)
2910AG (Specify length)
2912AG (Specify length)
2915AG (Specify length)
2918AG (Specify length)
2924AG (Specify length)

OUR PART NUMBER
932948 (Specify length)
9329410 (Specify length)
9329412 (Specify length)
9329415 (Specify length)
9329418 (Specify length)
9329424 (Specify length)

NOTE: Where "ADS" [= N12™] appears in the description, you may substitute any one of the following to designate the type of connection desired:

- ACO = A-2000 Contech™
- CDD = AWWA cast iron drain dimension
- HAN = Hancor HiQ™
- IPS = Iron Pipe Size
- PIP = Plastic irrigation pipe
- PLC = Perma-Loc™
- CRU = Crumpler™
- QC = Quality Culvert

- P21 = Pro21™
- SWR = SDR35/F679 sewer
- TRU = Truss pipe
- ULC = Ultra-Corr™
- ULR = Ultra-Rib™
- VYL = Vylon™
- LAN = Lane™
- PRI = Prinsco

- More numbers may be needed if multiple openings are requested.

* We ship our drains with round grates standard. ADS/Nyloplast ship their 12" and 15" drains with hinged grates standard. Please be sure to specify if hinged grates are desired.

MINIMUM ANGLE BETWEEN OUTLETS

6" CATCH BASIN DRAIN

Outlet Size	Outlet Size	Degree
4"	4"	90
4"	6"	128
6"	6"	180

Outlets larger than 6" are not possible.

8" CATCH BASIN DRAIN

Outlet Size	Outlet Size	Degree
4"	4"	75
6"	4"	90
6"	6"	108
8"	4"	108
8"	6"	128
8"	8"	170

Outlets larger than 8" are not possible.

10" CATCH BASIN DRAIN

Outlet Size	Outlet Size	Degree
4"	4"	57
6"	4"	68
6"	6"	79
8"	4"	79
8"	6"	91
8"	8"	108
10"	4"	96
10"	6"	108
10"	8"	119
10"	10"	170

Outlets larger than 10" are not possible.

THE ONLY WAY OUTLETS MAY BE CLOSER THAN INDICATED IS IF THE INVERTED HEIGHT IS DIFFERENT FROM THE NOMINAL O.D. OF THE OUTLET PLUS 2.

MINIMUM ANGLE BETWEEN OUTLETS

12" CATCH BASIN DRAIN

Outlet Size	Outlet Size	Degree
4"	4"	48
4"	6"	57
4"	8"	67
4"	10"	76
4"	12"	86
6"	6"	67
6"	8"	76
6"	10"	86
6"	12"	95
8"	8"	86
8"	10"	95
8"	12"	105
10"	10"	105
10"	12"	115
12"	12"	170

Outlets larger than 12" are not possible.

15" CATCH BASIN DRAIN

Outlet Size	Outlet Size	Degree
4"	4"	43
4"	6"	51
4"	8"	59
4"	10"	67
4"	12"	74
4"	15"	85
6"	6"	59
6"	8"	67
6"	10"	74
6"	12"	82
6"	15"	93
8"	8"	74
8"	10"	82
8"	12"	89
8"	15"	100
10"	10"	90
10"	12"	97
10"	15"	108
12"	12"	105
12"	15"	116
15"	15"	170

Outlets larger than 15" are not possible.

THE ONLY WAY OUTLETS MAY BE CLOSER THAN INDICATED IS IF THE INVERTED HEIGHT IS DIFFERENT FROM THE NOMINAL O.D. OF THE OUTLET PLUS 2.

MINIMUM ANGLE BETWEEN OUTLETS

18" CATCH BASIN DRAIN

Outlet Size	Outlet Size	Degree
4"	4"	35
4"	6"	41
4"	8"	48
4"	10"	54
4"	12"	60
4"	15"	69
4"	18"	79
6"	6"	48
6"	8"	54
6"	10"	60
6"	12"	67
6"	15"	75
6"	18"	86
8"	8"	61
8"	10"	68
8"	12"	73
8"	15"	82
8"	18"	92
10"	10"	74
10"	12"	80
10"	15"	88
10"	18"	99
12"	12"	86
12"	15"	94
12"	18"	105
15"	15"	103
15"	18"	114
18"	18"	170

Outlets larger than 18" are not possible.

THE ONLY WAY OUTLETS MAY BE CLOSER THAN INDICATED IS IF THE INVERTED HEIGHT IS DIFFERENT FROM THE NOMINAL O.D. OF THE OUTLET PLUS 2.

MINIMUM ANGLE BETWEEN OUTLETS

24" CATCH BASIN DRAIN

Outlet Size	Outlet Size	Degree
4"	4"	28
4"	6"	33
4"	8"	41
4"	10"	45
4"	12"	50
4"	15"	56
4"	18"	64
4"	24"	79
6"	6"	40
6"	8"	46
6"	10"	49
6"	12"	53
6"	15"	66
6"	18"	72
6"	24"	86
8"	8"	53
8"	10"	58
8"	12"	62

Outlet Size	Outlet Size	Degree
8"	15"	71
8"	18"	79
8"	24"	95
10"	10"	65
10"	12"	70
10"	15"	76
10"	18"	86
10"	24"	100
12"	12"	74
12"	15"	81
12"	18"	91
12"	24"	107
15"	15"	92
15"	18"	99
15"	24"	120
18"	18"	107
18"	24"	126
24"	24"	170

Outlets larger than 24" are not possible

THE ONLY WAY OUTLETS MAY BE CLOSER THAN INDICATED IS IF THE INVERTED HEIGHT IS DIFFERENT FROM THE NOMINAL O.D. OF THE OUTLET PLUS 2.

MINIMUM ANGLE BETWEEN OUTLETS

30" CATCH BASIN DRAIN

Outlet Size	Outlet Size	Degree
4"	4"	24
4"	6"	27
4"	8"	33
4"	10"	37
4"	12"	40
4"	15"	45
4"	18"	52
4"	24"	62
4"	30"	75
6"	6"	33
6"	8"	37
6"	10"	41
6"	12"	44
6"	15"	53
6"	18"	57
6"	24"	68
6"	30"	83
8"	8"	42
8"	10"	46
8"	12"	50
8"	15"	57
8"	18"	63
8"	24"	75

Outlet Size	Outlet Size	Degree
8"	30"	90
10"	10"	52
10"	12"	55
10"	15"	60
10"	18"	68
10"	24"	79
10"	30"	83
12"	12"	59
12"	15"	64
12"	18"	72
12"	24"	85
12"	30"	97
15"	15"	73
15"	18"	79
15"	24"	95
15"	30"	106
18"	18"	85
18"	24"	99
18"	30"	112
24"	24"	114
24"	30"	129
30"	30"	180

Outlets larger than 30" are not possible.

THE ONLY WAY OUTLETS MAY BE CLOSER THAN INDICATED IS IF THE INVERTED HEIGHT IS DIFFERENT FROM THE NOMINAL O.D. OF THE OUTLET PLUS 2.

MINIMUM ANGLE BETWEEN OUTLETS

36" CATCH BASIN DRAIN

Outlet Size	Outlet Size	Degree
4"	4"	21
4"	6"	24
4"	8"	29
4"	10"	32
4"	12"	35
4"	15"	39
4"	18"	44
4"	24"	53
4"	30"	64
4"	36"	73
6"	6"	29
6"	8"	32
6"	10"	35
6"	12"	38
6"	15"	45
6"	18"	49
6"	24"	58
6"	30"	70
6"	36"	80
8"	8"	37
8"	10"	40
8"	12"	43
8"	15"	48
8"	18"	53
8"	24"	64
8"	30"	76
8"	36"	86
10"	10"	44

Outlet Size	Outlet Size	Degree
12"	12"	47
10"	15"	52
10"	18"	58
10"	24"	67
10"	30"	71
10"	36"	80
12"	12"	50
12"	15"	55
12"	18"	61
12"	24"	72
12"	30"	83
12"	36"	95
15"	15"	62
15"	18"	67
15"	24"	80
15"	30"	90
15"	36"	99
18"	18"	72
18"	24"	84
18"	30"	95
18"	36"	107
24"	24"	96
24"	30"	109
24"	36"	121
30"	30"	121
30"	36"	130
36"	36"	180

Outlets larger than 36" are not possible.

THE ONLY WAY OUTLETS MAY BE CLOSER THAN INDICATED IS IF THE INVERTED HEIGHT IS DIFFERENT FROM THE NOMINAL O.D. OF THE OUTLET PLUS 2.

MINIMUM ANGLE BETWEEN OUTLETS

48" CATCH BASIN DRAIN

Outlet Size	Outlet Size	Degree	Outlet Size	Outlet Size	Degree	Outlet Size	Outlet Size	Degree
4"	4"	18	8"	15"	38	15"	24"	62
4"	6"	20	8"	18"	42	15"	30"	69
4"	8"	23	8"	24"	50	15"	36"	76
4"	10"	25	8"	30"	59	15"	42"	83
4"	12"	28	8"	36"	66	15"	48"	91
4"	15"	31	8"	42"	75	18"	18"	56
4"	18"	35	8"	48"	83	18"	24"	65
4"	24"	42	10"	10"	35	18"	30"	73
4"	30"	50	10"	12"	37	18"	36"	83
4"	36"	57	10"	15"	41	18"	42"	89
4"	42"	64	10"	18"	46	18"	48"	97
4"	48"	71	10"	24"	52	24"	24"	74
6"	6"	23	10"	30"	55	24"	30"	84
6"	8"	25	10"	36"	62	24"	36"	93
6"	10"	28	10"	42"	78	24"	42"	99
6"	12"	30	10"	48"	85	24"	48"	106
6"	15"	36	12"	12"	40	30"	30"	93
6"	18"	39	12"	15"	43	30"	36"	100
6"	24"	45	12"	18"	48	30"	42"	107
6"	30"	55	12"	24"	56	30"	48"	114
6"	36"	62	12"	30"	64	36"	36"	109
6"	42"	69	12"	36"	73	36"	42"	116
6"	48"	76	12"	42"	80	36"	48"	123
8"	8"	29	12"	48"	87	42"	42"	126
8"	10"	32	15"	15"	48	42"	48"	133
8"	12"	34	15"	18"	52	48"	48"	180

Outlets larger than 48" are not possible.

THE ONLY WAY OUTLETS MAY BE CLOSER THAN INDICATED IS IF THE INVERTED HEIGHT IS DIFFERENT FROM THE NOMINAL O.D. OF THE OUTLET PLUS 2.

CATCH BASIN ORDER FORM

IMPORTANT:

When determining position of inlet(s)/outlet(s) on drain basins, be sure to factor in actual outside dimension of openings needed. For example, 15" HDPE has an outside diameter of 18.7" (+ 15% for work area) so be sure to leave enough space between inlet(s)/outlet(s).

Terms and Conditions

Careful consideration of this detail will eliminate overlapping of inlet(s)/outlet(s), reduce confusion and facilitate fabrication.

COST \$ _____

PART NUMBER: _____

DRAIN BASIN SIZE: _____ DRAIN NO. _____

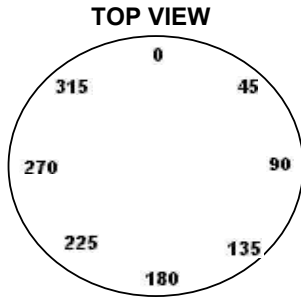

STUB NO.	STUB SIZE	LOCATION (DEG.)	TYPE OF PIPE
1			
2			
3			
4			

A = Overall height of basin (inches) _____

B = Top of grate to bottom of stub (flowline) (inches)

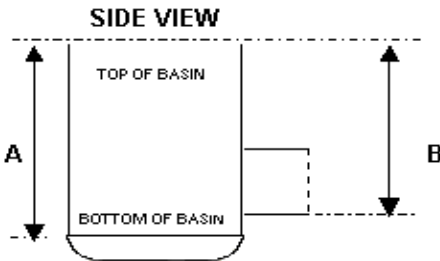

STUB NO.	B	COMMENTS
1		
2		
3		
4		

COST \$ _____

PART NUMBER: _____

DRAIN BASIN SIZE: _____ DRAIN NO. _____

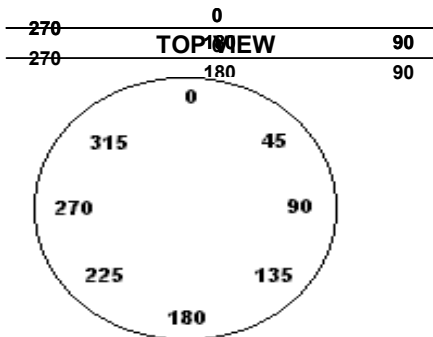

STUB NO.	STUB SIZE	LOCATION (DEG.)	TYPE OF PIPE
1			
2			
3			
4			

A = Overall height of basin (inches) _____

B = Top of grate to bottom of stub (flowline) (inches)

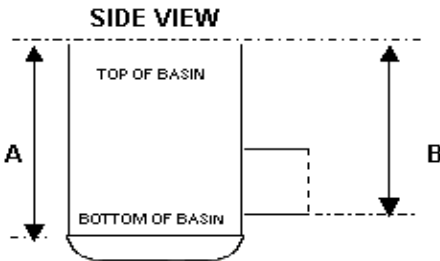

STUB NO.	B	COMMENTS
1		

ALL CATCH BASINS ARE NON-RETURNABLE AND NON-CANCELABLE AFTER PLACEMENT OF ORDER.

WARRANTY: Specified Fittings, LLC warrants all new SF products against defects resulting from faulty workmanship or materials for a period of one (1) year from the date of original purchase.

SFI will replace or repair at its option, any product established to be so defective, with a product of like type. Claims for labor costs and other charges resulting from the use of SFI products are not covered by this warranty.

This warranty is effective only for the benefit of the original purchaser and user and provided the following procedure is followed. **FAILURE TO ADHERE TO THE REQUIREMENTS OUTLINED BELOW WILL INVALIDATE THE TERMS OF THIS WARRANTY.**

- Within thirty (30) days after noticing the defect, purchaser/user must notify Specified Fittings, LLC, IN WRITING, at its corporate offices located at 164 West Smith Road, PO Box 28157, Bellingham, WA 98228, of the alleged defect.
- Upon request by SF, purchaser/user must either return the defective fitting(s) to SF, freight prepaid, or at the option of SF, make the defective fitting(s) available for inspection by a duly appointed SF representative. (In the event that the product is found to be defective because of a manufacturing error, the freight cost will be reimbursed to the purchaser/user.)

After SF repairs and/or replaces the product, it will ship the product back to the purchaser/user, freight prepaid. This warranty pertains only to products that have not been altered or damaged or used beyond their intended application. This warranty is in lieu of all other warranties, express or implied, of the merchantability or fitness for a particular purpose, which would otherwise extend beyond the warranties specified herein. This warranty specifically excludes incidental or consequential damages of any kind. However, some states do not allow exclusion or limitation of implied warranties or incidental or consequential damages so the above limitation may not apply to you.

In the event that a dispute arises, the parties agree to be governed by the conditions outlined below until a resolution is achieved.

- Independent third party testing of the alleged defective product shall be conducted and all costs in connection with such testing shall be borne by the party proved incorrect in the allegation.
- Mediation by a third party if agreed by the
- Arbitration by third party if agreed by the parties.
- Legal recourse with the losing side to pay all legal fees incurred by both parties.

This warranty gives you specific legal rights and you may also have other rights, which vary from state to state.

RECOMMENDATIONS FOR INSTALLERS AND USERS:

SOLVENT WELD CONNECTIONS-- Use a quality grade of primer and solvent cement formulated for the type of connection, with the **CORRECT SIZE APPLICATOR**. Read and follow all of the solvent weld manufacturer's application and cure time instructions thoroughly. Before applying primer and cement, appropriate safety precautions should be taken. Primer and cement should be stored in the shade between 40°F and 110°F. Eliminate all ignition sources. Avoid breathing of vapors. Use only with adequate ventilation; explosion-proof general mechanical ventilation or local exhaust is recommended to maintain vapor concentrations below recommended exposure limits. In confined or partially enclosed areas, a NIOSH-approved organic vapor cartridge respirator with full-face piece is recommended. Containers should be kept tightly closed when not in use, and covered as much as possible when in use. Avoid frequent contact with skin; wearing PVA coated protective gloves and impervious apron are recommended. Avoid any contact with eyes; splash proof chemical goggles are recommended.

THREADED CONNECTIONS – SF recommends the use of a quality grade thread sealant. Choice of either Teflon tape, paste, or other pipe joint compound is at the discretion of the installer. The manufacturer's literature for these products should be reviewed for proper selection and application procedures. **WARNING: SOME PIPE JOINT COMPOUNDS OR TEFLON PASTES MAY CONTAIN SUBSTANCES THAT COULD CAUSE STRESS CRACKING TO PLASTIC.** 1 to 2 turns beyond FINGER TIGHT are generally all that is required to make a sound plastic threaded connection. Unnecessary **OVERTIGHTENING** will cause **DAMAGE TO BOTH PIPE AND FITTING.**

GASKET CONNECTIONS – Gasket area and pipe or spigot end should be clean and free of dirt and debris. Do not attempt to remove the formed-in gasket (Figure 1). Lubricate the entire sealing surface of the gasket and the pipe or spigot end with a light coating of a suitable lubricant (Figure 2). Push the pipe or spigot end into the gasket bell while maintaining a straight alignment. The proper insertion depth is equal to the total gasket bell length minus one-half inch (1/2") (Figure 3).

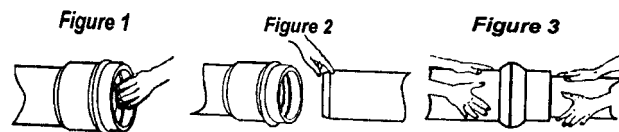

FLANGE CONNECTIONS – Once a flange is joined to pipe, the method for joining two flanges is as follows:

- Piping runs joined to the flanges must be installed in a straight-line position to the flange to avoid stress at the flange due to misalignment. Piping must also be secured and supported to prevent lateral movement, which can create stress and damage to the flange.
- With gasket in place, align the boltholes of the mating flanges by rotating the ring into position. (Consideration should be given to alignment of one-piece flange prior to joining with pipe.)
- Insert all bolts, washers (two standard flat washers per bolt) and nuts.
- Make sure the faces of the mating surfaces are flush against gasket prior to bolting down the flanges.
- Tighten the nuts by hand until they are snug. Establish uniform pressure over the flange face by tightening the bolts in 5-ft. lbs. increments according to the sequence shown in Figure 1 following a 180° opposing sequence.

Figure 1

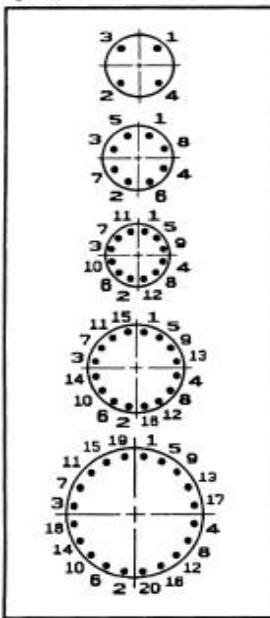

Flange Size	Recommended Torque (Ft. Lbs.)
1/2 - 1-1/2	10 - 15
2 - 4	20 - 30
6 - 8	33 - 50
10	53 - 75
12	80 - 110
14 - 24	110

- Care must be taken to avoid “bending” the flange when joining a flange to a “raised face” flange, or a wafer-style valve. Do not use bolts to bring together improperly mated flanges.

CAUTION: Unnecessary over-torquing will damage the flange.

FOR GROOVED END, LAP JOINT END, etc., contact factory.

IMPORTANT

WATER HAMMER – SF recommends that all PVC and CPVC plastic piping systems be designed and constructed to **AVOID EXCESSIVE WATER HAMMER**. Water hammer can cause damage and failure to pipe, valves, and fittings within the piping system.

NOTE – When temperatures rise above 73°F, the tensile strength of thermoplastics decreases, thereby derating the pipe or fitting Maximum Internal Pressure. When temperatures fall below 73°F, the tensile strength of thermoplastics increases. However, the impact strength decreases. Maximum operating temperatures for PVC piping systems should not exceed 140°F (110°F threaded systems). Maximum operating temperatures for CPVC piping systems should not exceed 200°F (150°F threaded systems).

CAUTION – **SF DOES NOT RECOMMEND** the use of thermoplastic piping products for systems to transport or store compressed air or gases, or the testing of thermoplastic piping systems with compressed air or gases in above and below ground locations. The use of SFI products in compressed air or gas systems automatically voids SF’s warranty for such products and their use against our recommendation is entirely the responsibility and liability of the installer. SF will not accept responsibility for damage or impairment of its products, or other consequential or incidental damages caused by misapplication, incorrect assembly, and/or exposure to harmful substances or conditions.

THRUST BLOCKING – Water under pressure exerts thrust forces in piping systems. Thrust blocking should be provided, as necessary, to prevent movement of pipe or appurtenances in response to thrust.

Types of thrust blocking:

- Through line connection, tee
- Through line connection, cross used as tee
- Direction change, elbow
- Change in line size, reducer
- Direction change, tee used as elbow

- (8) Through line connection, wye
- (9) Valve anchor
- (10) Direction change vertical, bend anchor
- (11) End caps (above or below ground)

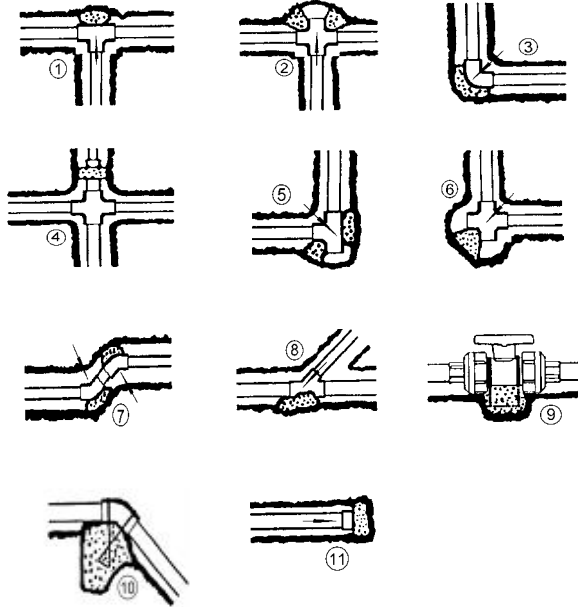

Thrust blocking is required wherever the pipeline:

- Changes direction (e.g. tees, bends, ells, crosses)
- Changes size at its reducers
- Stops, as at dead ends
- Valves and hydrants, at which thrust develops when closed.

Size and type of thrust blocking depends on:

- Maximum system pressure
- Pipe size
- Type and size of fittings or appurtenances
- Line profile (horizontal or vertical bends)
- Soil type

- (6) Direction change, cross used as elbow
- (7) Direction change
 - We are customer friendly. If we can't build it or get it for you, we will do everything we can to find a source for your needs.
 - We ship until 4:30 PM weekdays if material is in stock.
 - We try to keep our turnaround time to three working days or less from the date you place your order.
- We will arrange emergency deliveries on Saturday.

- We can give you access to information even on weekends.
- We have no minimum billing so no order is too small.
- We will be pleased to quote any inquiry and we try to get back to you within three hours.
- Sample fittings are available and can be shipped direct to you or your customer(s) so that you or they can see the quality of our fabrication and gasket.

Our full line of catalogs was designed to offer the estimator/customer the broadest range of fittings, prices and information available. You will find most configurations presently used in the marketplace and those not listed are available by contacting

IPS	¼	- 36	SCH40.80 PVC, CPVC
IPS	½	- 36	SDR64 - SDR17
PIP	4	- 27	SDR102 - SDR21
GATED	6	- 12	
C900/905/907	4	- 48	DR51 - DR14
SEWER	3	- 36	SDR35 - SDR26/35
SEWER TRUSS PIPE	8	- 15	
PERMA-LOC™	15	- 48	M304/F794
ULTRARIB™	6	- 30	F794
ULTRA-CORR™	24	- 36	F794/F949
VYLON™	21	- 60	F794
PRO-21™	21	- 60	F794
A-2000™	4	- 30	F949
ADSH-12™	4	- 48	
HANCOR Sure-Lok™	4	- 60	
HDPE	¾	- 63	SDR6.3 - SDR32.5
IN-LINE DRAINS	6	- 36	Outlet as specified
DRAIN BASINS	8	- 36	Outlets as specified

All fittings fabricated by Specified Fittings, LLC, conform to ASTM/ANSI standards, unless otherwise noted, and certification letters, specification sheets and technical drawings are available on request. Prior to shipment, all products are inspected to ensure that they meet our stringent quality control standards and all items are labeled.

In addition to our own products, we offer other commodities such as injection-molded sewer, C-907, SDR21 gasketed and PVC DWV to complement our line and provide you, our customer, with a one stop purchasing source.



Specified Fittings

Notes



**Specified
Fittings**



Bellingham, WA
164 West Smith Rd.
Bellingham, WA 98226
(360) 398-7700



Stevensville, MT
483 Stevensville Airport Road
Stevensville, MT 59870
(406) 777-3466



Early Branch, SC
320 Commerce Parkway
Early Branch, SC 29916

Visit us at: specifiedfittings.com