

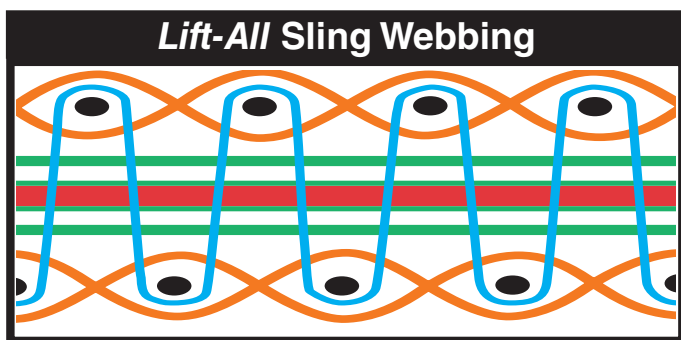

WHY LIFT-ALL WEB SLINGS?

Lift-All web slings meet or exceed OSHA, ASME B30.9 and WSTDA standards and regulations

All sling webbing contained in this catalog is recommended for general purpose lifting. Sling webbing has surface yarns connected from side to side, which not only protect the core yarns, but position surface and tensile yarns to work together to support the load. Wear or damage to sling webbing face yarns cause an immediate strength loss. Sling webbing has red core yarns to visually reveal damage which is one indicator for sling rejection. Please read warning sheet provided with each sling for additional details.



- Transverse pick yarns inter-relate with binder/surface yarns.
- Woven surface yarns cover each side and carry a portion of the load.
- Strip of longitudinal core yarns bears majority of load.
- Binder yarns secure the surface yarns to web core yarns.
- Red core warning yarns.

Web Slings

Tuff-Tag™

OSHA requires all web slings to show rated capacities and type of material. The *Lift-All Tuff-Tag* is made from an abrasion resistant polymer that will remain legible far longer than any leather or vinyl tag. In fact, *Tuff-Tags* will consistently outlast the useful life of slings.

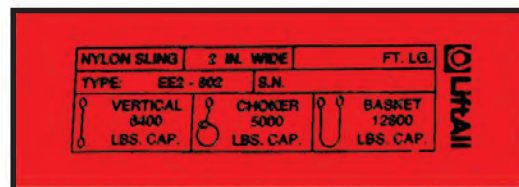

Safety Bulletin

A safety bulletin is packaged with every web sling from *Lift-All*. The bulletin includes:

- Inspection and removal from service criteria.
- Environmental considerations.
- Inspection frequency.
- Effect of angles.
- Rigging configuration.
- Sling protection.
- Exposure of slings to edges.

Measure the edge radius. The radius is equal to the distance between points A and B.

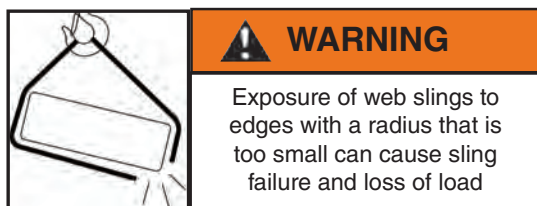
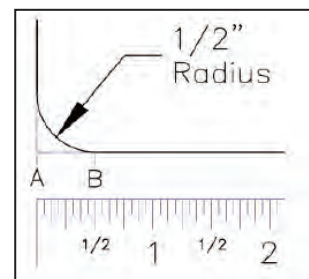

Minimum edge radii suitable for contact with unprotected web slings.

Edges do not need to be sharp to cause failure of the sling. The table shows the minimum allowable edge radii suitable for contact with unprotected webbing slings. Chamfering or cutting off edges is not an acceptable substitute for fully rounding the edges to the minimum radius. Slings can also be damaged from contact with the edges or burrs at the sling connections.

Vertical Rated Capacity	Minimum Edge Radii (in.)	
1 Ply	.18	3/16
2 Plies	.50	1/2
3 Plies	.75	3/4
4 Plies	1.00	1

For further information on minimum edge radii, contact *Lift-All*.

LIFT-ALL WEB SELECTOR

Web Slings

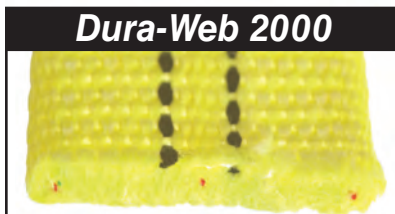
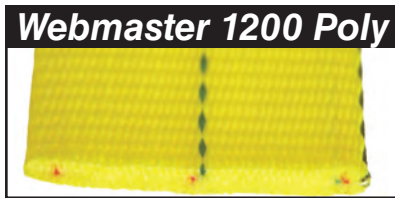
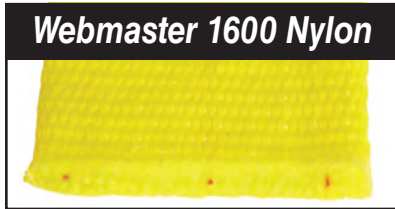
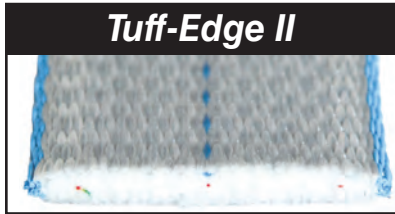

Approx. Thickness	Single-Ply Capacity Per Inch of Width	Material	Identifier	Applications*
3/16"	1600-lbs.	Polyester	Blue edge. Blue center stripe. Silver surface.	Daily use under good to rugged lifting conditions. 2X more edge cut resistance. Our most popular.
3/16"	1600-lbs.	Polyester	Blue center stripe.	Daily use under good to moderate lifting conditions. Polyester stretches less for better load control, reduced abrasion.
3/16"	1600-lbs.	Nylon	No center stripe.	Daily use under good to moderate lifting conditions. Nylon stretches more to help avoid shock loading.
1/8"	1200-lbs.	Polyester	Blue center stripe. Black yarn one edge.	Light use under good lifting conditions. Polyester stretches less for better load control, reduced abrasion.
1/8"	1200-lbs.	Nylon	No center stripe. Black yarn one edge	Light use under good lifting conditions. Nylon stretches more to help avoid shock loading.
5/16"	2000-lbs.	Nylon	Two black center stripes.	Heavy use under moderate to rugged lifting conditions. Abrasion resistant yarns cover entire surface.
3/16"	1000-lbs.	Nylon	One black center stripe.	Daily use under moderate lifting conditions. Abrasion resistant yarns cover entire surface.

* **⚠ WARNING**

Always protect synthetic slings from being cut by corners and edges. See Sling Protection section in this catalog.

STANDARD WEB SLING TYPES

Hardware Slings

Unilink and *Web-Trap* hardware can help to extend sling life by protecting the webbing from abrasion on rough crane hooks. Hardware can often be reused, lowering sling replacement costs.

Type U (UU) - Has the preferred and economical *Unilink* fitting with *Web-Trap* on each end for use in a vertical, choker or basket hitch. *Unilinks* allow choking from either end to save time and vary wear points.

Type 1 (TC) - Has a *Web-Trap* triangle on one end and choker on the other end. Typical use is in a choker hitch. Can also be used in vertical and basket hitches.

Type 2 (TT) - Has a *Web-Trap* triangle on each end. Normally used in a basket hitch, but can also be used in a vertical hitch. Cannot be used as a choker.

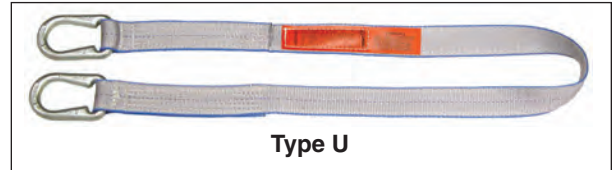

Type U

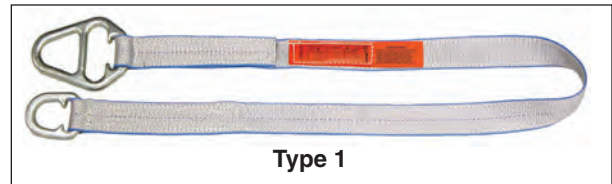

Type 1

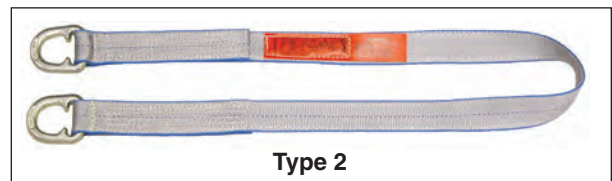

Type 2

Web Slings

Eye/Eye Type

Type 3 (EE) - Flat Eye slings are very popular and can be used in all three types of hitches. They are easier to remove from beneath the load than sling Types 1, 2 and 4. Type 3 will be supplied as the standard EE sling, unless Type 4 is requested.

Type 4 (EE) - Twisted Eye slings are similar to Type 3 except the eyes are turned 90°. The eyes of a Type 4 nest easily on the crane hook.

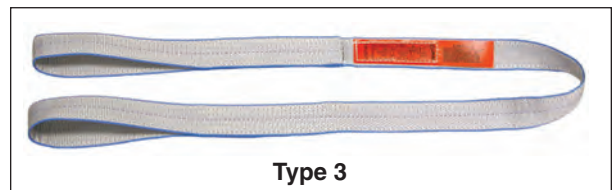

Type 3

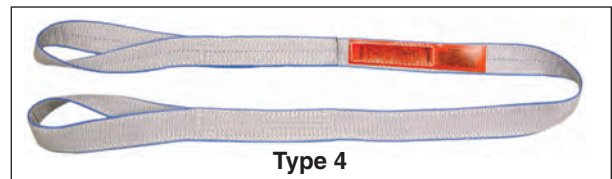

Type 4

Endless Type

Type 5 (EN) - Endless slings are versatile and the most economically priced. They can be used in all three types of hitches. The sling can be rotated to minimize wear. The sling legs can be spread for improved load balance.

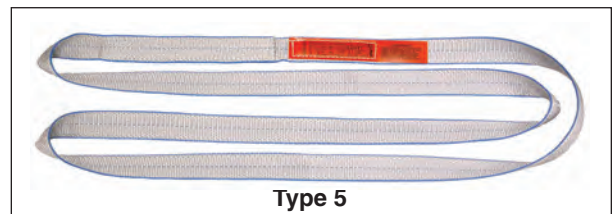

Type 5

Reverse Eye Type

Type 6 (RE) - An endless sling with butted edges sewn together to double the sling width. They have reinforced eyes and wear pads on both sides of body and eyes for premium wear resistance.

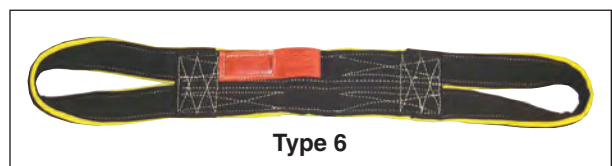

Type 6

WEB SLING EYE TREATMENTS

The eyes of web slings are often subjected to the harsh treatment of rough crane hooks. Specialty eye treatments are available to help reduce the wear in that area, thereby extending sling life. The following photos illustrate the more common eye treatments using wear-resistant webbing in various forms. Should you want eye treatment on your eye & eye web slings, please specify using the terminology below.

Web Slings

Type 3 - Flat Eyes		Type 4 - Twisted Eyes	
	Standard Style		
	Lined Bearing Point		
	Fully Lined Eye		
	Wrapped Bearing Point		
	Fully Wrapped Eye		

Textured, wear-resistant material is standard for these eye treatments. Other pad materials are available in the Sling Protection section of this catalog.

Tapering Eyes - As a standard practice, the bearing points of the eyes on Type 3 and Type 4 slings are tapered to accommodate a crane hook on slings 3" and wider. Untapered eyes are available upon request. Type 5 (endless) slings are NOT tapered unless specified on order. *Dura-Web* 2000 slings are NOT tapered in any width.

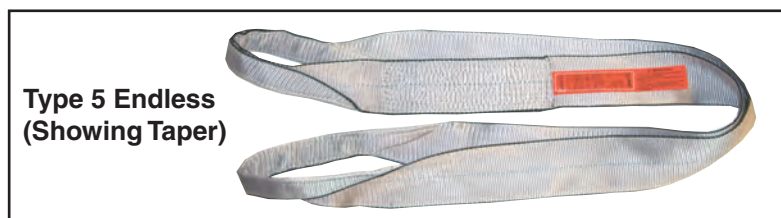
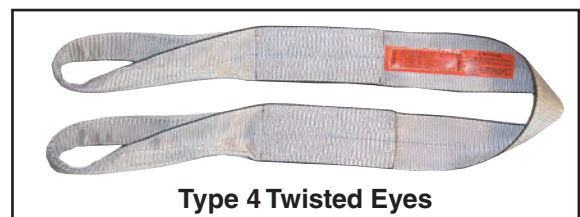
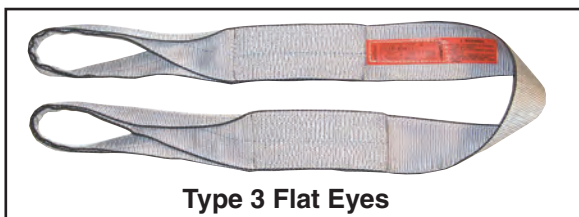

Web Slings

ENVIRONMENTAL CONSIDERATIONS

Exposure to sunlight and other environmental factors can result in accelerated deterioration of web slings. The rate of this deterioration varies with the level of exposure and with the thickness of the sling material.

Visible indication of such environmental deterioration can include the following:

- Fading of webbing color.
- Uneven or disoriented surface yarn of the webbing.
- Shortening of the sling length.
- Reduction in elasticity of the sling.
- Accelerated abrasive damage to the surface yarns of the sling.
- Breakage or damage to yarn fibers is often evident by a fuzzy appearance on the web.
- Stiffening of the web.

Anti-Abrasion Treatment

Lift-All webbing is treated for abrasion. Heavy duty treatments are available as a supplemental process for greater protection. Natural, untreated webbing is available upon request.

Elasticity

The stretch characteristics of web slings depends on the type of yarn and the web treatment. Approximate stretch at rated sling capacity:

NYLON		POLYESTER	
Treated	10%	Treated	7%
Untreated	6%	Untreated	3%

Length Tolerance for Web Slings

Sling Type	Tolerance*
1-Ply	± (1.5" + 1.5% of sling length)
2-Ply	± (2.0" + 2% of sling length)
3-Ply & 4-Ply	± (3.0" + 3% of sling length)

* For web sling widths wider than 6", add 1/2" to these values. For tighter tolerance or matched set lengths, please consult with Customer Service prior to Ordering.

Sunlight / UV Exposure Service Life

Nylon and polyester web slings possess a limited useful service life due to the degradation caused by exposure to sunlight or other measurable sources of UV radiation.

Lift-All web slings that are regularly exposed to UV radiation should be identified with the date they are placed into service and should be proof-tested to twice their rated capacity every six months.

Lift-All nylon and polyester web slings shall be permanently removed from service when the cumulative UV or outdoor exposure has reached these limits:

- 2 years: 1-Ply and 2-Ply web slings
- 3 years: 3-Ply and 4-Ply web slings

Temperature

Nylon and polyester slings degrade at temperatures above 200°F.

Chemical Environment Data

Many chemicals have an adverse effect on nylon and polyester. The chemical chart below is a general guide only. For specific temperature, concentration and time factors, please consult *Lift-All* prior to purchasing or use.

CHEMICAL	NYLON	POLYESTER
Acids	NO	OK ⁺
Alcohols	OK	OK
Aldehydes	OK	NO
Alkalis	OK	NO
Bleaching Agents	NO	OK
Dry Cleaning Solvents	OK	OK
Ethers	OK	OK
Halogenated Hydro-Carbons	OK	OK
Hydro-Carbons	OK	OK
Ketones	OK	OK
Oils Crude	OK	OK
Oils Lubricating	OK	OK
Soap & Detergents	OK	OK
Water & Seawater	OK	OK
Weak Alkalis	OK	OK

⁺ Disintegrated by concentrated sulfuric acid.

Prior to sling selection and use, review and understand the HELP section.

HOW TO ORDER WEB SLINGS

Web Slings

EE 1 8 02 T F X 12

Sling Type
UU - Type U - *Unilink* Each End
TC - Type 1 - Triangle/Choker
TT - Type 2 - Triangle/Triangle
EE - Type 3 & 4 Eye/Eye
EN - Endless
RE - Reverse Eye
WL - Wide Lift

Number of Plies
 1, 2, 3 or 4

Web Class
1 - *Dura-Web 1000*
2 - *Dura-Web 2000*
8 - *Webmaster 1600 or Tuff-Edge II*
6 - *Webmaster 1200*
SH - Stone Handling

Always protect synthetic slings from being cut or damaged by corners, edges and protrusions using protection sufficient for each application.



Refer to Sling Protection section in this catalog.

Sling Length
 Use actual pull to pull length (reach) in feet.

'X'

Eye Treatments

Flat Eyes (Type 3)
F - Standard
G - Lined Bearing Point
H - Fully Lined
I - Wrapped Bearing Point
J - Fully Wrapped

Twisted Eyes (Type 4)
T - Standard
U - Lined Bearing Point
V - Fully Lined
W - Wrapped Bearing Point
X - Fully Wrapped

Exceptions: Class 1, 2 and SH slings.

Tapered Eye Standards
Non-Tapered: 1" and 2" wide slings.
Tapered: 3" wider and up, in class 6 & 8 slings only.
Note: Other treatments can be accommodated. Please specify at time of order.

Web Material
T - *Tuff-Edge*
D - Polyester
N - Nylon

Sling Width in inches

WEB SLING HARDWARE

Unilink™ Web Sling Hardware

Unilinks are a forged, high carbon steel fitting and functions as both a triangle and choker.

Features and Benefits

- Forged steel for strength and reliability.
- Smooth rounded profile helps protect sling, worker, and load.
- Can be re-webbed to reduce cost.
- Powder-coated finish for longer life.
- Unilinks cost less than triangle/choker combinations.
- Large crane hook opening speeds rigging.
- Web-Trap feature keeps web aligned on hardware.
- Functions both as a triangle and a choker as you can choke at either end.

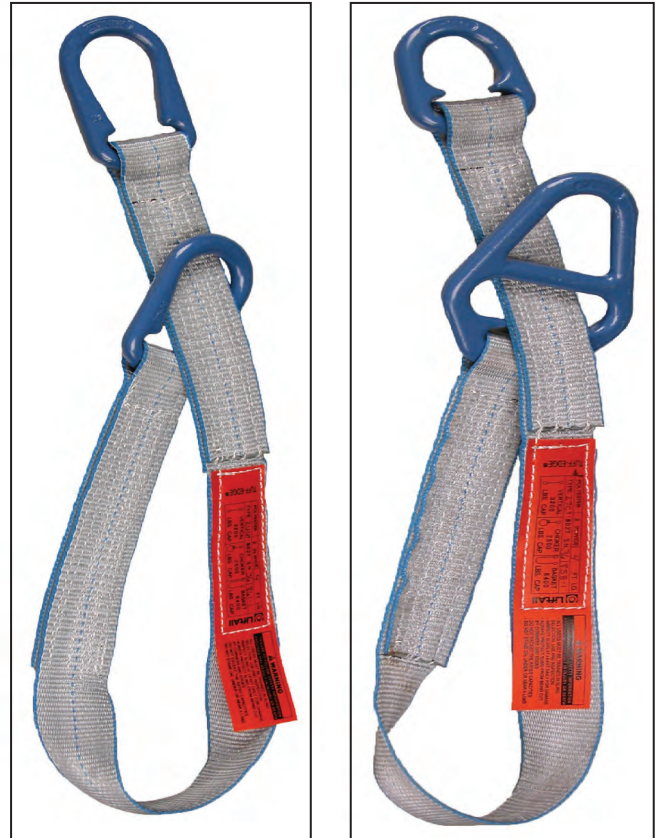

Web Slings

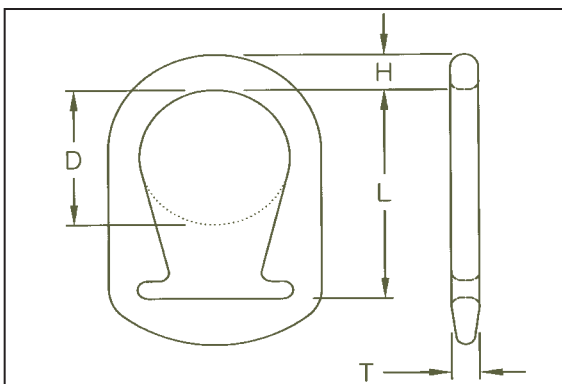

Unilink Codes and Specifications

Web Width (in.)	Dimensions (in.)				Weight (lbs.)
	L	D	H	T	
2	3.69	2.0	0.69	0.56	1.1
3	5.06	3.0	0.88	0.63	2.4
4	6.19	4.0	1.00	0.75	4.0

Forged Aluminum Triangles and Chokers

Aluminum is severely degraded by alkali, caustic environments, acids and salt water.

Aluminum Triangles and Chokers are available but may only be used with single ply web slings within the rated capacities shown in the table. They should not be used with *Dura-Web 2000* webbing.

Forged from aircraft aluminum, this tough alloy is stronger than mild steel. Aluminum has the advantages of being lightweight, non-sparking and does not rust.

Note: Aluminum triangles and chokers DO NOT offer the advantages of the *Web-Trap* feature. Aluminum fittings are not as durable and cost more than steel.

Avoid contact of hardware with load edges.
Unilink has the same rated capacities as TT or TC slings.

WEB SLING HARDWARE

Web-Trap Steel Sling Hardware - Triangles and Chokers

A significant improvement in triangle/choker design, *Web-Trap* fittings feature positive web capture to eliminate web slippage. These fittings are manufactured from alloy steel for lighter sling weight and a powder-coated finish to inhibit rust.

Web Slings



Webbing can slip with ordinary fittings.

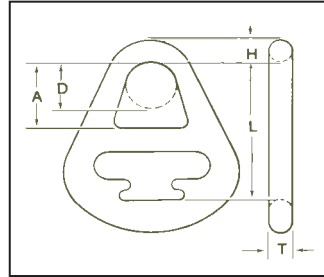
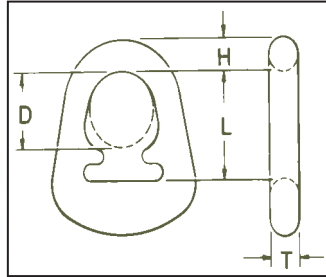

Web-Trap locks webbing to center of hardware.

Alloy Steel for 1-Ply and 2-Ply Slings

Web-Trap Triangles						Web-Trap Chokers						
Web Width	Dimensions (in.)				Weight (lbs.)	Web Width	Dimensions (in.)					Weight (lbs.)
	L	D	T	H			L	A	D	T	H	
*2"	2.38	1.75	.56	0.63	1.0	*2"	5.00	2.44	1.75	.56	0.69	1.9
*3"	3.44	2.00	.50	0.75	1.9	*3"	6.25	3.38	2.00	.50	0.75	3.6
*4"	4.13	2.38	.50	0.81	2.8	*4"	7.00	4.00	2.38	.50	0.81	5.1
6"	5.56	3.13	.50	1.06	6.3	6"	8.88	4.75	3.13	.50	1.06	12

* Unlink is standard fitting - Triangle and chokers available on special order only.

Alloy Steel for 1-Ply Slings

Web-Trap Triangles						Web-Trap Chokers						
Web Width	Dimensions (in.)				Weight (lbs.)	Web Width	Dimensions (in.)					Weight (lbs.)
	L	D	T	H			L	A	D	T	H	
8"	6.50	4.0	.50	1.25	8	8"	11.25	7.50	4.00	.50	1.44	16
10"	8.25	5.0	.75	1.44	16	10"	12.88	8.25	5.00	.75	1.50	28
12"	8.75	5.5	.75	1.75	20	12"	14.50	10.0	5.50	.75	1.75	40

Alloy Steel for 2-Ply Slings

Web-Trap Triangles						Web-Trap Chokers						
Web Width	Dimensions (in.)				Weight (lbs.)	Web Width	Dimensions (in.)					Weight (lbs.)
	L	D	T	H			L	A	D	T	H	
8"	6.50	4.0	.75	1.25	12	8"	11.25	7.50	4.0	.75	1.438	25
10"	8.25	5.0	1.0	1.438	21	10"	12.88	8.25	5.0	1.0	1.50	38
12"	8.75	5.5	1.0	1.75	27	12"	14.50	10.0	5.50	1.0	1.75	54

TUFF-EDGE II®

Tuff-Edge II Polyester Webbing

2X Stronger After Abrasion 2X Better Edge Cut Resistance

You can expect longer sling life and lower overall costs when you switch to **Tuff-Edge II**. Resistance to abrasion and edge cutting is greatly improved over nylon and polyester webbing.

Using Federal Test Method 191A, **Tuff-Edge II** webbing was tested against standard yellow polyester webbing. After being subjected to the same number of hex bar abrasion cycles, the **Tuff-Edge II** treated webbing, achieved average break strengths that were twice that of the standard yellow webbing!

In a test developed to measure edge cutting properties, the cut depth on the **Tuff-Edge II** webbing with special polymer edge yarns cut less than half the depth of the standard yellow polyester.

Although you should **always** pad and protect synthetic slings from load edges, normal wear and tear will be greatly reduced when using **Tuff-Edge II**, giving you longer sling life, reducing your overall costs.

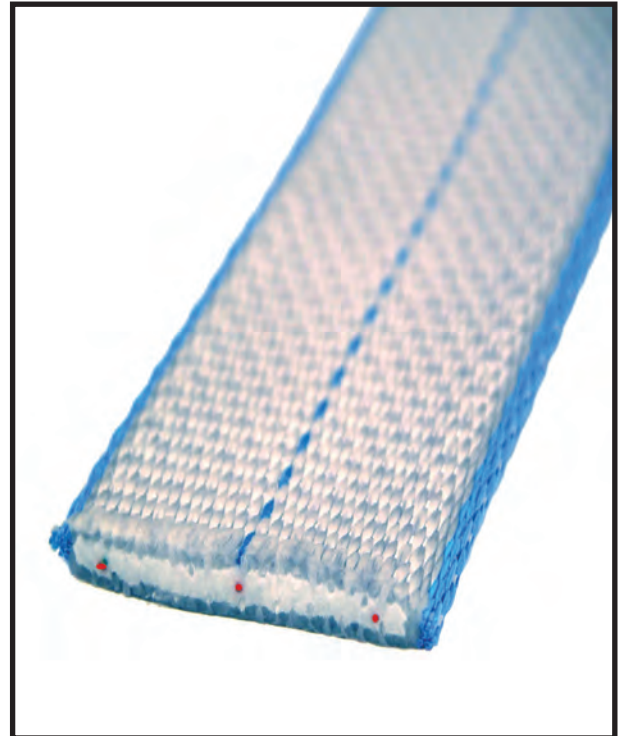

Web
Slings

Features and Benefits

Promotes Safety

- Red Core yarn warning system aids in the inspection process.
- **Tuff-Tag** provides serial numbered identification for traceability.
- Special polymer coated edge yarns reduce edge cutting and abrasion.

Saves Money

- Web treatment fights abrasion for additional sling life.
- **Tuff-Tag** provides required OSHA information for the life of the sling.

Saves Time

- Easy identification; silver body, blue edges, and blue center stripe.

Always protect synthetic slings from being cut or damaged by corners, edges and protrusions using protection sufficient for each application.



Refer to Sling Protection section in this catalog.

WEBMASTER 1600 NYLON AND POLYESTER SLINGS

The Traditional Standard for Heavy Duty Slings

Webmaster 1600 is our most popular web due to strength and service life. This versatile workhorse can be designed in many configurations for a wide variety of lifting applications. Many industries appreciate the value versus strength capabilities of this product line, making it the go-to solution.

Features and Benefits

Promotes Safety

- Red core yarn warning system aids in the inspection process.
- *Tuff-Tag* provides serial numbered identification for traceability.
- Proven reliability.

Saves Money

- Yellow treatment for abrasion resistance and extended sling life.
- *Tuff-Tag* provides required OSHA information for the life of the sling.

Saves Time

- Polyester web is identified by single blue surface stripe.

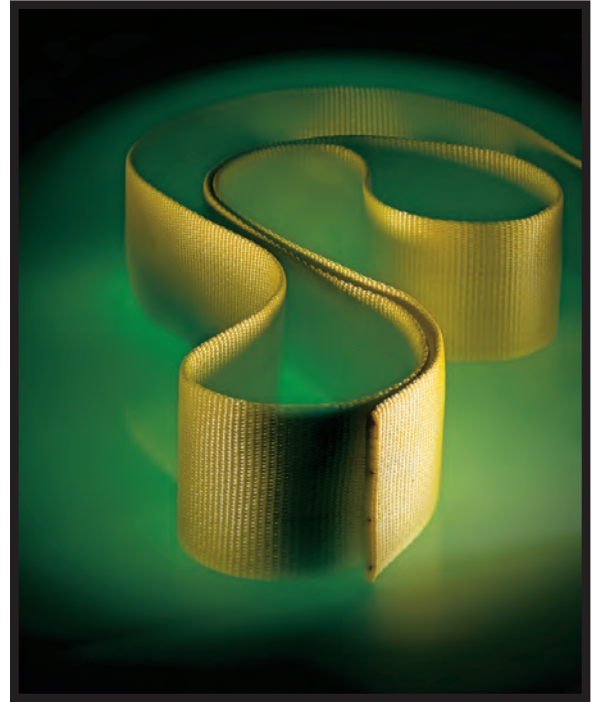

Always protect synthetic slings from being cut or damaged by corners, edges and protrusions using protection sufficient for each application.



Refer to Sling Protection section in this catalog.



For details on characteristics of nylon versus polyester webbing, see 'Environmental Considerations' in this section.

TUFF-EDGE AND WEBMASTER 1600 POLYESTER SLINGS

Web Slings

Type U Unilink Hardware Slings

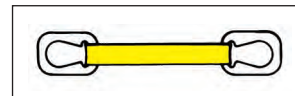

	Tuff-Edge II Part Number ⁺	Web Width (in.)	Rated Capacity* (lbs.)			Webmaster 1600 Part Number****
			Vertical	Choker	V. Basket	
One Ply	UU1802T	2	3,200	2,500	6,400	UU1802D
	UU1803T	3	4,800	3,800	9,600	UU1803D
	UU1804T	4	6,400	5,000	12,800	UU1804D
Two Ply	UU2802T	2	6,400	5,000	12,800	UU2802D
	UU2803T	3	8,800	7,040	17,600	UU2803D
	UU2804T	4	11,500	9,200	23,000	UU2804D

*Replace the UU with TT or TC in part number above if Type 1 or Type 2 is required.

Type 1 (TC) and Type 2 (TT) Web-Trap Hardware Slings

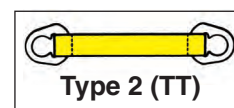
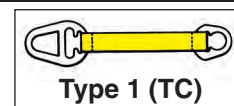
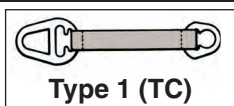

	Tuff-Edge II Part Number		Web Width (in.)	Rated Capacity* (lbs.)			Webmaster 1600 Part Number***	
	Type 1	Type 2**		Vertical	Choker	V. Basket	Type 1	Type 2**
One Ply	TC1806T	TT1806T	6	9,600	7,700	19,200	TC1806D	TT1806D
	TC1808T	TT1808T	8	12,800	10,200	25,600	TC1808D	TT1808D
	TC1810T	TT1810T	10	16,000	12,800	32,000	TC1810D	TT1810D
	TC1812T	TT1812T	12	19,200	15,400	38,400	TC1812D	TT1812D
	TC1816T	TT1816T	16	25,500	20,400	51,000	TC1816D	TT1816D
	Two Ply	TC2806T	TT2806T	6	16,800	13,400	33,600	TC2806D
TC2808T		TT2808T	8	22,400	17,900	44,800	TC2808D	TT2808D
TC2810T		TT2810T	10	28,000	22,400	56,000	TC2810D	TT2810D
TC2812T		TT2812T	12	33,600	26,800	67,200	TC2812D	TT2812D
TC2816T		TT2816T	16	44,800	35,800	89,600	TC2816D	TT2816D

** Type 2 (TT) cannot be used in a choker hitch.

*** To order nylon, replace the "D" with an "N".

Custom configurations available.

* **WARNING** Do not exceed rated capacities. Sling tension increases as the angle from horizontal decreases. Slings should not be used at angles of less than 30°. Refer to the Effect of Angle chart in the HELP section.

TUFF-EDGE AND WEBMASTER 1600 POLYESTER SLINGS

Web Slings

Eye and Eye Slings						
	Tuff-Edge II Part No.**	Web Width (in.)	Rated Capacity* (lbs.)			Webmaster 1600 Part No.***
			Vertical	Choker	V. Basket	
One Ply	EE1801TF	1	1,600	1,280	3,200	EE1801DF
	EE1802TF	2	3,200	2,500	6,400	EE1802DF
	EE1803TF	3	4,800	3,800	9,600	EE1803DF
	EE1804TF	4	6,400	5,000	12,800	EE1804DF
	EE1806TF	6	9,600	7,700	19,200	EE1806DF
	EE1808TF	8	12,800	10,200	25,600	EE1808DF
	EE1810TF	10	16,000	12,800	32,000	EE1810DF
	EE1812TF	12	19,200	15,400	38,400	EE1812DF
Two Ply	EE2801TF	1	3,200	2,500	6,400	EE2801DF
	EE2802TF	2	6,400	5,000	12,800	EE2802DF
	EE2803TF	3	8,800	7,040	17,600	EE2803DF
	EE2804TF	4	11,500	9,200	23,000	EE2804DF
	EE2806TF	6	16,500	13,200	33,000	EE2806DF
	EE2808TF	8	19,200	15,400	38,400	EE2808DF
	EE2810TF	10	22,400	17,900	44,800	EE2810DF
	EE2812TF	12	26,900	21,500	53,800	EE2812DF
Three Ply	EE3801TF	1	4,100	3,300	8,200	EE3801DF
	EE3802TF	2	8,300	6,600	16,600	EE3802DF
	EE3803TF	3	12,500	10,000	25,000	EE3803DF
	EE3804TF	4	16,000	12,800	32,000	EE3804DF
	EE3806TF	6	23,000	18,400	46,000	EE3806DF
	EE3808TF	8	30,700	24,500	61,400	EE3808DF
	EE3810TF	10	36,800	29,400	73,600	EE3810DF
	EE3812TF	12	44,000	35,200	88,000	EE3812DF
Four Ply	EE4801TF	1	5,000	4,000	10,000	EE4801DF
	EE4802TF	2	10,000	8,000	20,000	EE4802DF
	EE4803TF	3	14,900	11,900	29,800	EE4803DF
	EE4804TF	4	19,800	15,800	39,600	EE4804DF
	EE4806TF	6	29,800	23,800	59,600	EE4806DF
	EE4808TF	8	39,700	31,700	79,400	EE4808DF
	EE4810TF	10	49,600	39,600	99,200	EE4810DF
	EE4812TF	12	59,500	47,600	119,000	EE4812DF

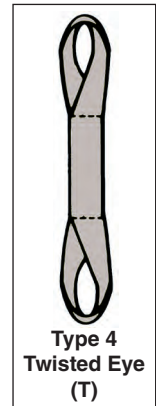
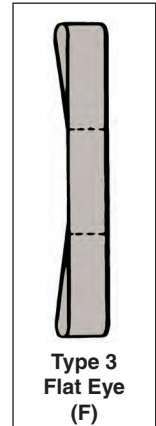

** Replace the "F" with a "T" for Twisted Eyes. *** Replace the "D" with an "N" to order nylon.
 Eyes on Type 3 and Type 4 slings are tapered at 3" and wider, unless otherwise specified.

Eye Length - Applies to all Web Slings								
Plies of Web	Sling Width (in.)							
	1	2	3	4	6	8	10	12
1	8.5	10	11	12	16	20	24	24
2	8.5	10	11	12	16	20	24	24
3	10.0	12	14	16	18	24	24	24
4	10.0	12	14	16	18	24	24	24

* **WARNING** Do not exceed rated capacities. Sling tension increases as the angle from horizontal decreases. Slings should not be used at angles of less than 30°. Refer to the Effect of Angle chart in the HELP section.

TUFF-EDGE AND WEBMASTER 1600 POLYESTER SLINGS

Endless						
	Tuff-Edge II Part No.	Web Width (in.)	Rated Capacity* (lbs.)			Webmaster 1600 Part No.**
			Vertical	Choker	V. Basket	
One Ply	EN1801T	1	3,200	2,500	6,400	EN1801D
	EN1802T	2	6,400	5,000	12,800	EN1802D
	EN1803T	3	8,800	7,040	17,600	EN1803D
	EN1804T	4	11,500	9,200	23,000	EN1804D
	EN1806T	6	16,500	13,200	33,000	EN1806D
	EN1808T	8	19,200	15,400	38,400	EN1808D
	EN1810T	10	22,400	17,900	44,800	EN1810D
	EN1812T	12	26,900	21,500	53,800	EN1812D
Two Ply	EN2801T	1	6,200	4,900	12,400	EN2801D
	EN2802T	2	12,400	9,900	24,800	EN2802D
	EN2803T	3	16,300	13,000	32,600	EN2803D
	EN2804T	4	20,700	16,500	41,400	EN2804D
	EN2806T	6	28,600	23,000	57,200	EN2806D
	EN2808T	8	30,700	24,500	61,400	EN2808D
	EN2810T	10	33,600	26,800	67,200	EN2810D
	EN2812T	12	37,600	30,000	75,200	EN2812D
Three Ply	EN3801T	1	8,000	6,400	16,000	EN3801D
	EN3802T	2	16,000	12,800	32,000	EN3802D
	EN3803T	3	21,500	17,200	43,000	EN3803D
	EN3804T	4	28,700	23,000	57,400	EN3804D
	EN3806T	6	40,700	32,500	81,400	EN3806D
	EN3808T	8	46,000	36,800	92,000	EN3808D
	EN3810T	10	51,500	41,200	103,000	EN3810D
	EN3812T	12	59,200	47,300	118,400	EN3812D
Four Ply	EN4801T	1	10,000	8,000	20,000	EN4801D
	EN4802T	2	19,800	15,800	39,600	EN4802D
	EN4803T	3	26,700	21,300	53,400	EN4803D
	EN4804T	4	35,600	28,400	71,200	EN4804D
	EN4806T	6	50,500	40,400	101,000	EN4806D
	EN4808T	8	57,600	46,000	115,200	EN4808D
	EN4810T	10	67,200	53,700	134,400	EN4810D
	EN4812T	12	80,700	64,500	161,400	EN4812D

** Replace the "D" with an "N" to order nylon.
 Note: Type 5 (Endless) slings are not tapered unless specified.

Web Slings

Tuflex is an Alternative ...

For 3-Ply and 4-Ply slings wider than 6", *Tuflex Roundslings* should be seriously considered.

Tuflex offers increased flexibility, ease of use and lower cost.

* **WARNING** Do not exceed rated capacities. Sling tension increases as the angle from horizontal decreases. Slings should not be used at angles of less than 30°. Refer to Effect of Angle chart in HELP section.

DURA-WEB NYLON SLINGS

Best in Abrasion Resistance

Available in two strength classes, all *Dura-Web* slings feature premium abrasive resistant yarns covering all surfaces for extended sling life and long term value.

Features and Benefits

Promotes Safety

- Red core yarn warning system aids in the inspection process.
- Striped webbing helps identify proper capacity.

- *Tuff-Tag* provides serial numbered identification for traceability.

Saves Money

- Abrasion resistant fibers cover both faces and edges for greater sling life.

- *Tuff-Tag* provides required OSHA information for the life of the sling.

Saves Time

- Easily identified by stripes.

Web Slings

Dura-Web 2000

Two black stripes: 2,000-lbs. per inch of width. 25% stronger than other webbing.

The strongest abrasion resistant sling available.

Dura-Web 2000 slings cannot have tapered eyes.

Dura-Web slings meet or exceed OSHA and ASME B30.9 requirements.

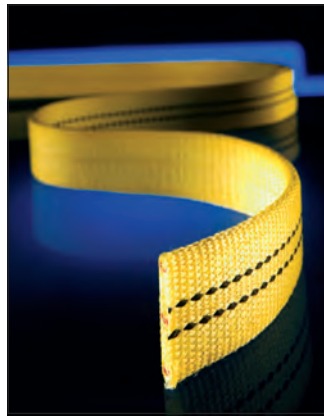

Dura-Web 1000



One black stripe: 1,000-lbs. per inch of width.

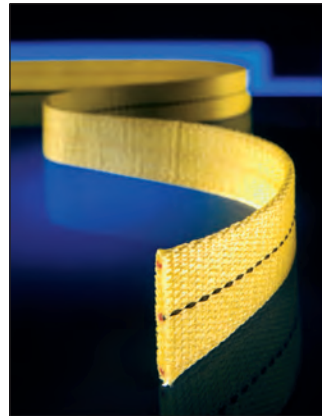

The only light-duty web sling with an abrasive resistant surface.

Wider bearing surface per capacity, helps protect load surface.

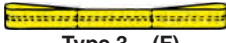
Dura-Web slings meet or exceed OSHA and ASME B30.9 requirements.

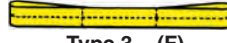

	Part Number	Web Width (in.)	Rated Capacity (lbs.)		
			Vertical	Choker	V. Basket
 Type U					
One Ply	UU1202N	2	4,000	3,200	8,000
	UU1203N	3	6,000	4,800	12,000
	UU1204N	4	8,000	6,400	16,000
Two Ply	UU2202N	2	8,000	6,400	16,000
	UU2203N	3	10,800	8,600	21,600
	UU2204N	4	14,400	11,500	28,800
 Type 3 - (F)  Type 4 - (T)					
One Ply	EE1201NF	1	2,000	1,600	4,000
	EE1202NF	2	4,000	3,200	8,000
	EE1203NF	3	6,000	4,800	12,000
	EE1204NF	4	8,000	6,400	16,000
Two Ply	EE2201NF	1	4,000	3,200	8,000
	EE2202NF	2	8,000	6,400	16,000
	EE2203NF	3	10,800	8,600	21,600
	EE2204NF	4	14,400	11,500	28,800
 Type 5					
One Ply	EN1201N	1	4,000	3,200	8,000
	EN1202N	2	8,000	6,400	16,000
	EN1203N	3	12,000	9,600	24,000
	EN1204N	4	16,000	12,800	32,000
Two Ply	EN2201N	1	7,800	6,200	15,600
	EN2202N	2	15,200	12,200	30,400
	EN2203N	3	20,400	16,300	40,800
	EN2204N	4	25,800	20,600	51,600

	Part Number	Web Width (in.)	Rated Capacity (lbs.)		
			Vertical	Choker	V. Basket
 Type U					
One Ply	UU1102N	2	2,000	1,600	4,000
Two Ply	UU2102N	2	4,000	3,200	8,000
 Type 3 - (F)  Type 4 - (T)					
One Ply	EE1101NF	1	1,000	800	2,000
	EE1102NF	2	2,000	1,600	4,000
Two Ply	EE2101NF	1	2,000	1,600	4,000
	EE2102NF	2	4,000	3,200	8,000
 Type 5					
One Ply	EN1101N	1	2,000	1,600	4,000
	EN1102N	2	4,000	3,200	8,000
Two Ply	EN2101N	1	3,900	3,100	7,800
	EN2102N	2	7,600	6,100	15,200

WEBMASTER 1200 SLINGS

Standard duty *Webmaster* 1200 is designed as an economical sling for less frequent use.

Features and Benefits

Promotes Safety

- Red core yarn warning system aids in the inspection process.
- Proven reliability.
- *Tuff-Tag* provides serial numbered identification for traceability.

Saves Money

- Economical option for less frequent use.
- Yellow treatment for abrasion resistance and extended sling life.
- *Tuff-Tag* provides required OSHA information for the life of the sling.

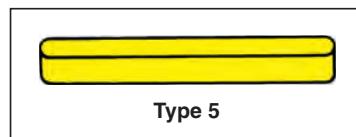
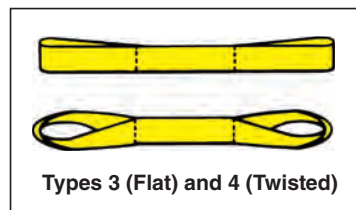
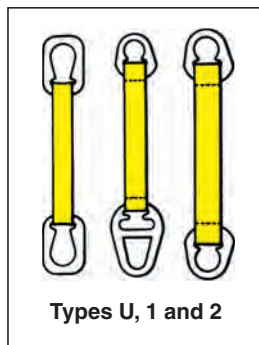

Note: Types 3 and 4 slings are tapered at 3" and wider unless otherwise specified. Type 5 (Endless) slings are NOT tapered unless specified.

* **WARNING**

Do not exceed rated capacities. Sling tension increases as the angle from horizontal decreases. Slings should not be used at angles of less than 30°. Refer to the Effect of Angle chart in the HELP section of this catalog.

Hardware Slings (TYPES U, 1 AND 2)

	Part Number	Rated Capacity* (lbs.)		
		Vertical	Choker	V. Basket
One Ply	UU1602D	2,400	1,900	4,800
	UU1603D	3,600	2,900	7,200
	UU1604D	4,800	3,800	9,600
	TC1606D	7,200	5,800	14,400
	TT1606D	7,200	n/a	14,400
Two Ply	UU2602D	4,800	3,800	9,600
	UU2603D	6,600	5,280	13,200
	UU2604D	8,600	6,900	17,200
	TC2606D	12,600	10,100	25,200
	TT2606D	12,600	n/a	25,200

Eye and Eye Slings (TYPES 3 AND 4)**

One Ply	EE1601DF	1,200	950	2,400
	EE1602DF	2,400	1,900	4,800
	EE1603DF	3,600	2,900	7,200
	EE1604DF	4,800	3,800	9,600
	EE1606DF	7,200	5,800	14,400
Two Ply	EE2601DF	2,400	1,900	4,800
	EE2602DF	4,800	3,800	9,600
	EE2603DF	6,600	5,280	13,200
	EE2604DF	8,600	6,900	17,200
	EE2606DF	12,300	9,840	24,600
Three Ply	EE3601DF	3,500	2,800	7,000
	EE3602DF	7,000	5,600	14,000
	EE3603DF	9,400	7,500	18,800
	EE3604DF	12,000	9,600	24,000
	EE3606DF	18,000	14,400	36,000
Four Ply	EE4601DF	4,200	3,400	8,400
	EE4602DF	8,000	6,400	16,000
	EE4603DF	12,000	9,600	24,000
	EE4604DF	16,000	12,800	32,000
	EE4606DF	23,500	18,800	47,000

**Replace the "F" with a "T" for Twisted Eyes

Endless Slings (TYPE 5)

One Ply	EN1601D	2,400	1,900	4,800
	EN1602D	4,800	3,800	9,600
	EN1603D	6,500	5,200	13,000
	EN1604D	8,600	6,900	17,200
	EN1606D	12,200	9,800	24,400
Two Ply	EN2601D	4,800	3,800	9,600
	EN2602D	9,600	7,700	19,200
	EN2603D	11,700	9,400	23,400
	EN2604D	15,500	12,400	31,000
	EN2606D	22,500	18,000	45,000
Three Ply	EN3601D	6,200	4,900	12,400
	EN3602D	12,500	10,000	25,000
	EN3603D	16,300	13,000	32,600
	EN3604D	20,600	16,400	41,200
	EN3606D	29,300	23,400	58,600
Four Ply	EN4601D	7,700	6,200	15,400
	EN4602D	15,500	12,400	31,000
	EN4603D	20,800	16,600	41,600
	EN4604D	26,600	21,200	53,200
	EN4606D	37,800	30,200	75,600

REVERSE EYE SLINGS

Reverse Eye (RE) Slings

The Reverse Eye Sling is a modified endless sling, reinforced and protected on all sides. It's the most rugged and versatile of all web slings. The sling incorporates premium wear-resistant material for protection on all surfaces.

Features and Benefits

Promotes Safety

- Superior choke hitch performance grips load securely.
- Reinforced eyes improve strength.
- The red core yarn warning system aids in the inspection process.
- *Tuff-Tag* provides serial numbered identification for traceability.

Saves Money

- An additional wear-resistant layer offers superior abrasion resistance.
- Reversible eyes reduce wear and increase sling life.
- Top grade slings using *Tuff-Edge* webbing are armored on all four sides resulting in the toughest web sling available.

Saves Time

- Eyes nest well on crane hook for easy rigging.
- Flat eye construction is available to facilitate removal from under loads.

The Reverse Eye sling is not just an endless sling with wear pads.



Single Ply Endless with Reinforced Eyes

- A. Extended web length makes 2-Ply eyes.
- B. Reinforcing web piece sewn-on to make 2-Ply eye.

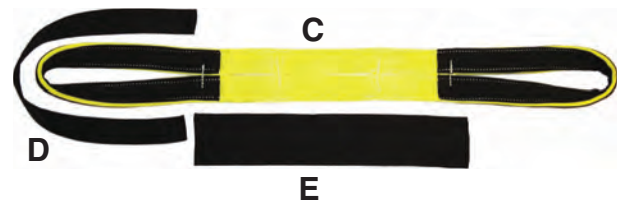

Add wear pads to both sides of body and eyes

- C. Single Ply Endless sling with butted sides.
- D. Texturized wear pads on both sides of eyes.
- E. Texturized wear pads sewn on both sides of body.



Completed RE sling may be a 1, 2 or 3 ply endless sling with reinforcing webbing for each loop, and texturized wear pad on each side of eyes and sling body.

Heavy Duty RE Slings: *Tuff-Edge* Web

Standard Duty RE Slings: *Webmaster* 1200

	Part Number	Rated Capacity* (lbs.)			Sling Thickness (in.)	Sling Width (in.)	Eye Length (in.)	Part Number	Rated Capacity* (lbs.)			Sling Thickness (in.)
		Vertical	Choker	V. Basket					Vertical	Choker	V. Basket	
One Ply	RE1802T	4,500	3,600	9,000	5/16	2	9	RE1602N	3,600	2,900	7,200	1/4
	RE1804T	7,700	6,200	15,400	5/16	4	12	RE1604N	6,800	5,400	13,600	1/4
	RE1806T	11,000	8,800	22,000	5/16	6	15	RE1606N	8,000	6,400	16,000	1/4
Two Ply	RE2802T	6,500	5,200	13,000	1/2	2	9	RE2602N	5,200	4,200	10,400	3/8
	RE2804T	13,000	10,400	26,000	1/2	4	12	RE2604N	10,500	8,400	21,000	3/8
	RE2806T	20,000	16,000	40,000	1/2	6	15	RE2606N	14,400	11,500	28,800	3/8
Three Ply	RE3804T	16,400	13,100	32,800	11/16	4	14	RE3604N	14,000	11,200	28,000	1/2
	RE3806T	25,500	20,400	51,000	11/16	6	18	RE3606N	20,000	16,000	40,000	1/2

Reverse eye slings using *Webmaster* 1600 webbing are available by special order.

* **WARNING**

Do not exceed rated capacities. Sling tension increases as the angle from horizontal decreases. Slings should not be used at angles of less than 30°. Refer to the Effect of Angle chart in the HELP section of this catalog.

SYNTHETIC WEB BRIDLE SLINGS

Bridle Slings are useful when fixed lifting points are available

Features and Benefits

Promotes Safety

- *Tuff-Edge II* web material is standard; helps prevent sling damage.
- Better load control and balance by using fixed connection points and multiple legs.
- Standard oblong links and hooks are forged from alloy steel for strength and reliability.
- Red core yarn warning system aids in the inspection process.
- Use of hardware prevents cutting and abrasion of sling at bearing points.
- *Tuff-Tag* provides serial numbered identification for traceability.
- Proven reliability.

Saves Money

- Soft web sling legs protect load.
- Endless configuration allows shifting of wear points.
- *Tuff-Edge II* material extends sling life.
- Sling hooks and links can be re-webbed.
- *Tuff-Tag* provides required OSHA information for the life of the sling.

Saves Time

- Lighter weight and easier to use than chain or wire rope.
- Sling hooks quickly connect to loads having hoist rings or eye bolts.

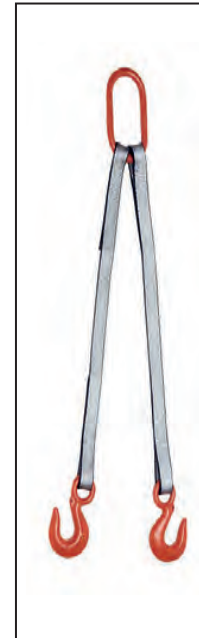

Web Slings

HOW TO ORDER WEB BRIDLE SLINGS

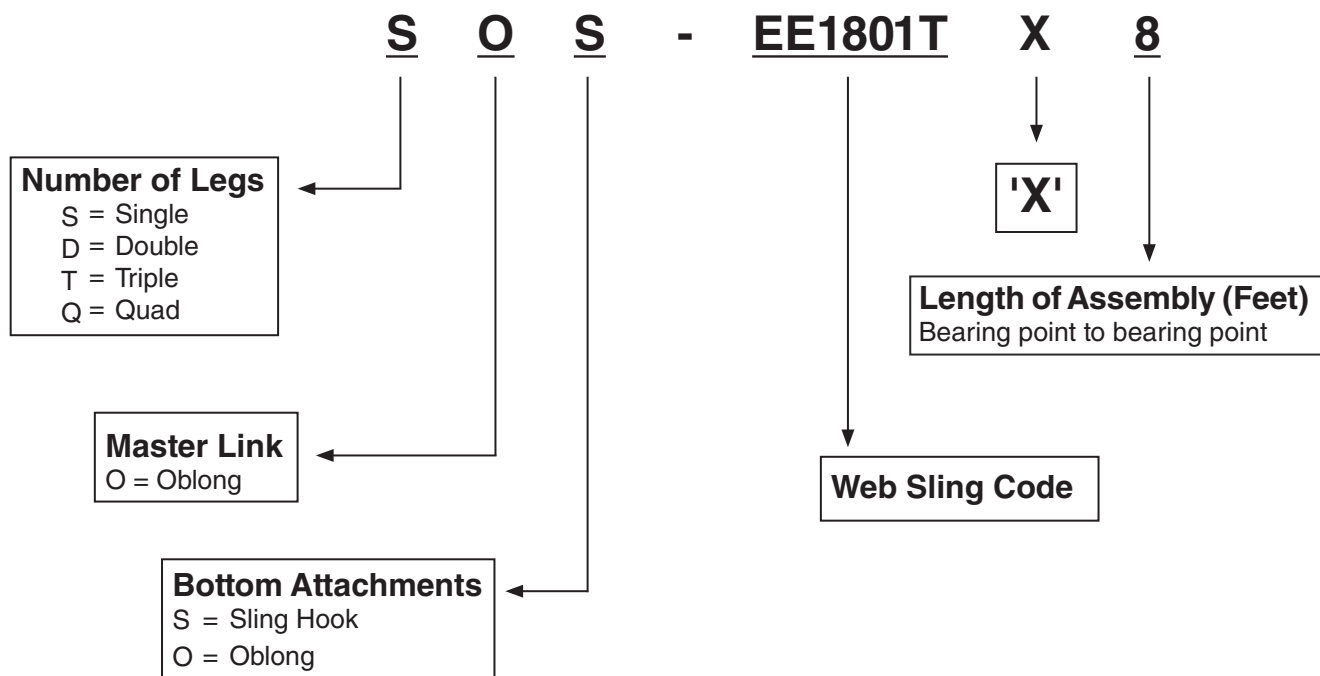

TUFF-EDGE II BRIDLE SLINGS

Web Slings

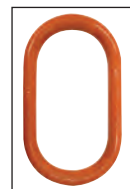
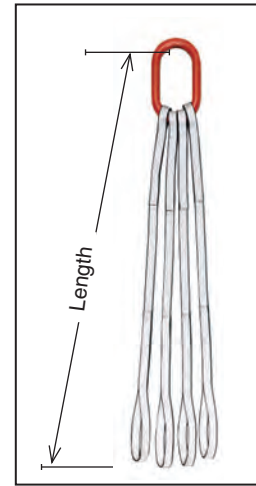
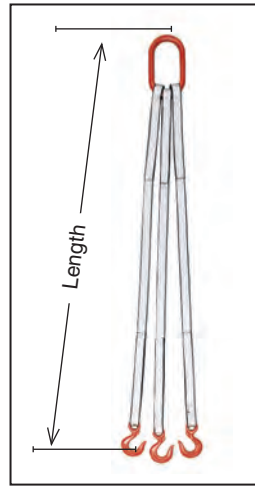
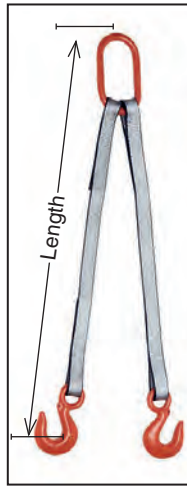
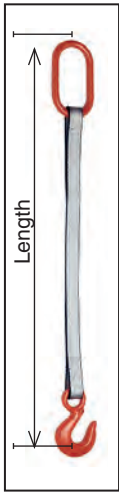

TUFF-EDGE II Bridle Slings

Part No. For Web Sling Legs	Web Width (in.)	Web Plies	Number of Legs	Rated Capacity* (lbs.)				Alloy Sling Hook Size	Oblong Link Dia. (in.)
				Vertical	@60°	@45°	@30°		
EE1801T	1	1	Single	1,600	–	–	–	1-Ton Alloy	1/2
	1	1	Double	–	2,700	2,200	1,600	1-Ton Alloy	1/2
	1	1	Triple	–	4,100	3,300	2,400	1-Ton Alloy	3/4
	1	1	Quad	–	5,500	4,500	3,200	1-Ton Alloy	1
EE2801T	1	2	Single	3,000	–	–	–	1-1/2 Ton Alloy	1/2
	1	2	Double	–	5,100	4,200	3,000	1-1/2 Ton Alloy	3/4
	1	2	Triple	–	7,700	6,300	4,500	1-1/2 Ton Alloy	3/4
	1	2	Quad	–	10,300	8,400	6,000	1-1/2 Ton Alloy	1
EE1802T	2	1	Single	3,000	–	–	–	1-1/2 Ton Alloy	1/2
	2	1	Double	–	5,100	4,200	3,000	1-1/2 Ton Alloy	3/4
	2	1	Triple	–	7,700	6,300	4,500	1-1/2 Ton Alloy	3/4
	2	1	Quad	–	10,300	8,400	6,000	1-1/2 Ton Alloy	1
EE2802T	2	2	Single	6,000	–	–	–	3-Ton Alloy	3/4
	2	2	Double	–	10,300	8,400	6,000	3-Ton Alloy	1
	2	2	Triple	–	15,500	12,700	9,000	3-Ton Alloy	1
	2	2	Quad	–	20,700	16,900	12,000	3-Ton Alloy	1-1/4

Note: Hardware capacities correspond to the appropriate sling capacities. See hardware dimensions in HARDWARE section.

*

WARNING

Do not exceed rated capacities. Sling tension increases as the angle from horizontal decreases. Slings should not be used at angles of less than 30°. Refer to the Effect of Angle chart in the HELP section of this catalog.

WIDE-LIFT SLINGS

Lift-All Wide-Lift slings support the load over a wide area to offer better balance – whether heavy or light. The wide bearing area reduces marring of soft load surfaces. Stiffeners at the base of the eyes deter the body webbing from folding down the middle. Wide-Lift slings are for use in a basket hitch only. The standard web material is *Webmaster* 1600 nylon; polyester is available upon request.

Features and Benefits

Promotes Safety

- Red core yarn warning system aids in the inspection process.
- *Tuff-Tag* provides serial numbered identification for traceability.
- Improved load stabilization.

Saves Money

- Wide bearing area reduces marring of soft load surfaces.
- Yellow treatment for abrasion resistance and extended sling life.
- *Tuff-Tag* provides required OSHA information for the life of the sling.

Web Slings

Attached Eye Wide-Lift



For Light Loads

Continuous Eye Wide-Lift



For Heavy Loads - Constructed from one endless sling with the two body lengths butted and joined side by side.

	Body Width (in.)	Part Number	Rated Capacity* Vertical Basket (lbs.)	Eye Length (in.)	Minimum Sling Length (in.)
One Ply Eye	6	WLA1806N	5,000	6	50
	8	WLA1808N	5,000	8	50
	10	WLA1810N	5,000	10	54
	12	WLA1812N	5,000	12	56
	16	WLA1816N	10,000	14	56
	20	WLA1820N	10,000	16	68
	24	WLA1824N	10,000	20	72
Two Ply Eye	6	WLA2806N	10,000	10	50
	8	WLA2808N	10,000	10	50
	10	WLA2810N	10,000	12	54
	12	WLA2812N	10,000	12	56
	16	WLA2816N	18,000	12	56
	20	WLA2820N	18,000	18	68
	24	WLA2824N	18,000	18	72
	30	WLA2830N	18,000	22	74
	36	WLA2836N	18,000	27	84
	48	WLA2848N	18,000	36	102

	Body Width (in.)	Part Number	Rated Capacity* Vertical Basket (lbs.)	Eye Length (in.)	Minimum Sling Length (in.)
One Ply	6	WL1806N	15,400	9	40
	8	WL1808N	20,400	12	45
	12	WL1812N	30,800	18	60
	16	WL1816N	38,000	24	72
	20	WL1820N	45,000	30	88
	24	WL1824N	52,000	36	100
	30	WL1830N	45,000	45	120
Two Ply	36	WL1836N	45,000	54	144
	6	WL2806N	28,600	9	40
	8	WL2808N	38,000	12	45
	12	WL2812N	57,200	18	60
	16	WL2816N	75,000	24	72
	20	WL2820N	90,000	30	88
	24	WL2824N	110,000	36	100
	30	WL2830N	90,000	45	120
	36	WL2836N	90,000	54	144

Note:

1. Never use Wide-Lift slings in a choker hitch.
2. *Tuff-Edge II* may be used for the attached eyes.
3. Custom slings with higher capacities are available.
4. *Tuflex* slings are also available as Wide-Lift slings.

*** ⚠ WARNING**

Do not exceed rated capacities. Sling tension increases as the angle from horizontal decreases. Slings should not be used at angles of less than 30°. Refer to the Effect of Angle chart in the HELP section of this catalog.

STONE HANDLING SLINGS

Special abrasion resistant 4-inch nylon webbing for handling stone, concrete and building panels.

Lift-All stone handling slings feature a soft abrasion-resistant wear pad woven onto the load side of the webbing, providing outstanding protection for both the sling and the polished stone surfaces.

Note: Eye/Eye style slings with flat eyes only. Untapered and 12" eye length.

Web Slings

Features and Benefits

Promotes Safety

- Red core yarn warning system aids in the inspection process.
- *Tuff-Tag* provides serial numbered identification for traceability.
- Proven reliability.

Saves Money

- Heavy, soft yarns on load side to help protect the sling from abrasion.
- White pile yarns prevent color transfer to load.
- 2-Ply version results in an abrasion resistant face on both sides.
- *Tuff-Tag* provides required OSHA information for the life of the sling.

Saves Time

- 2-Ply version with abrasion resistance on both sides, does not need orientation by the rigger.



	Part Number	Rated Capacity* (lbs.)		
		Vertical	Choker	V. Basket
One Ply	UU1SH4N	5,400	4,000	10,800
	EE1SH4N	5,400	4,000	10,800
	EN1SH4N	10,800	8,600	21,600
Two Ply	UU2SH4N	9,400	7,000	18,800
	EE2SH4N	9,400	7,000	18,800
	EN2SH4N	10,800	8,600	21,600

* **⚠ WARNING**

Do not exceed rated capacities. Sling tension increases as the angle from horizontal decreases. Slings should not be used at angles of less than 30°. Refer to the Effect of Angle chart in the HELP section of this catalog.

INSPECTION CRITERIA FOR WEB SLINGS

The following photos illustrate some of the common damages that occur to web slings, indicating that the sling should be taken out of service. For inspection frequency requirements, see the HELP section of this catalog and the safety bulletin provided with each sling.

Web Slings

SURFACE AND EDGE CUTS

WHAT TO LOOK FOR: *Broken fibers* of equal length indicate that the sling has been cut by an edge. **Red core warning yarns may or may not be visible and are not required to show before removing slings from service.** It is important to realize that all of the fibers in web slings contribute to the strength of that sling.

TO PREVENT: Always protect synthetic slings from being cut by corners and edges by using cut protection. See the Sling Protection section in this catalog.

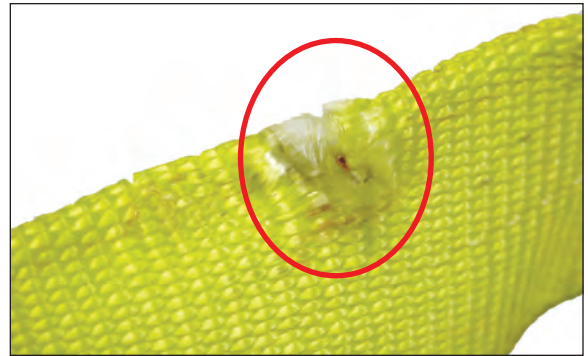
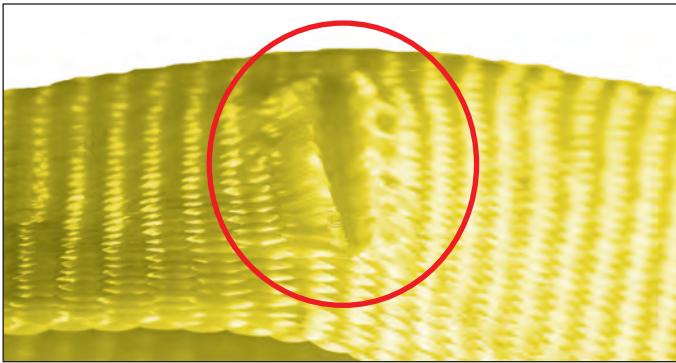

HOLES, SNAGS & PULLS

WHAT TO LOOK FOR: *Punctures or areas* where fibers stand out from the rest of the sling surface.

TO PREVENT: Avoid sling contact with protrusions, both during lifts and while transporting or storing. See the Sling Protection section in this catalog.

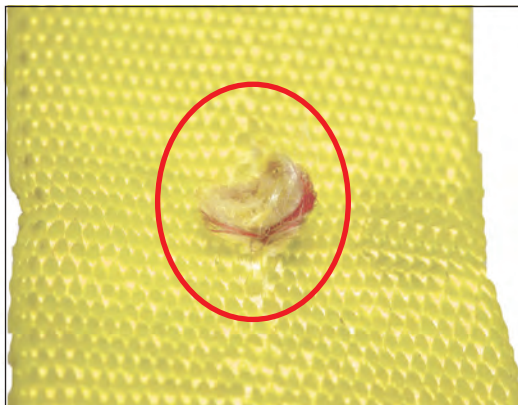

ABRASION

WHAT TO LOOK FOR: Areas of the sling that look and feel **fuzzy** indicate that the fibers have been broken by being subject to contact and movement against a rough surface. Affected areas are usually stained.

TO PREVENT: Never drag slings along the ground. Never pull slings from under loads that are resting on the sling. Use wear pads between slings and rough surface loads. See the Sling Protection section in this catalog.

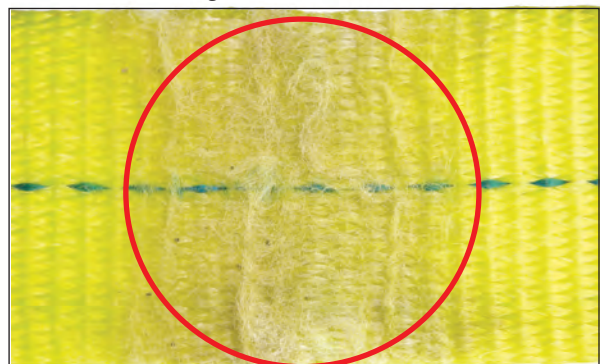

INSPECTION CRITERIA FOR WEB SLINGS

HEAT / CHEMICAL

WHAT TO LOOK FOR: *Melted or charred fibers* anywhere along the sling. Heat and chemical damage can look similar and they both have the effect of damaging sling fibers and compromising the sling's strength. Look for discoloration and/or fibers that have been fused together and often feel hard or crunchy.

TO PREVENT: Never use nylon or polyester slings where they can be exposed to temperatures in excess of 200°F. Never use nylon or polyester slings in or around chemicals without confirming that the sling material is compatible with the chemicals being used.

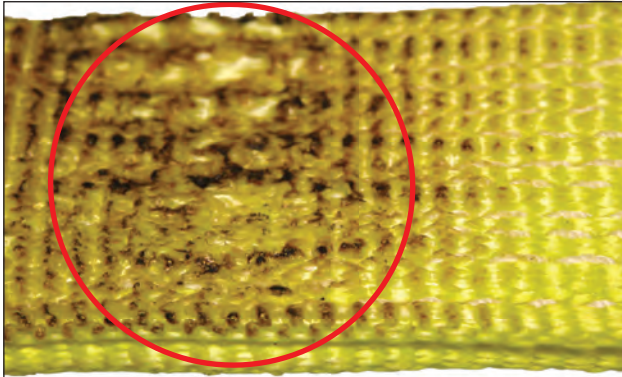

BROKEN / WORN STITCHING

WHAT TO LOOK FOR: *Loose or broken threads* in the main stitch patterns. The stitch patterns in web slings have been engineered to produce the most strength out of the webbing. If the stitching is not fully intact, the strength of the sling may be affected.

TO PREVENT: Never pull slings from beneath loads where stitch patterns can get hung up or snagged. Never overload the slings or allow the load edge to directly contact the stitch pattern while lifting. Never place a sling eye over a hook or other attachment whose width/diameter exceeds 1/3 of the eye length.

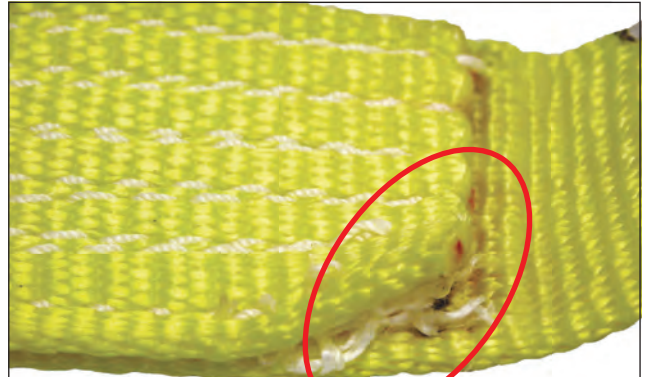

KNOTS

WHAT TO LOOK FOR: *Knots* are rather obvious problems as shown below. Knots compromise the strength of slings by not allowing all fibers to contribute to the lift as designed. Knots may reduce sling strength by up to 50%.

TO PREVENT: Never tie knots in slings and never use slings that are knotted.

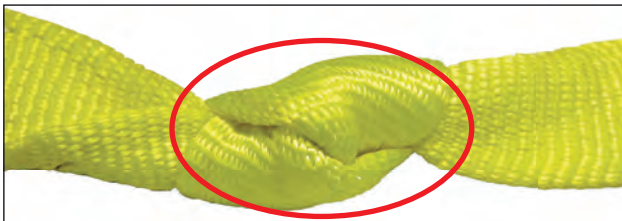

ILLEGIBLE OR MISSING TAGS

WHAT TO LOOK FOR: If you cannot find or read all of the information on a sling tag, OSHA requires that the sling shall be taken out of service.

TO PREVENT: Never set loads down on top of slings or pull sling from beneath loads if there is any resistance. Load edges should never contact sling tags during the lift. Avoid paint or chemical contact with tags.

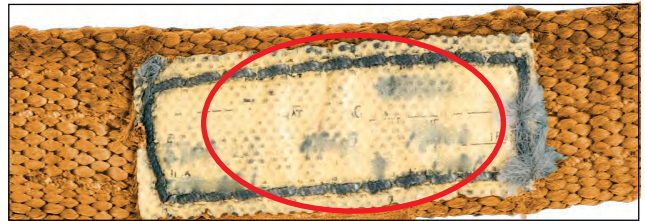

Red Core Yarns are an **additional** aid to warn of dangerous sling damage. All standard *Lift-All* Web Slings have this warning feature. The red core yarns become exposed when the sling surface is cut or worn through the woven face yarns. When red yarns are visible, the sling should be removed from service immediately. For other inspection criteria see OSHA/Manufacturer regulations in the HELP section of this catalog and the safety bulletin provided with each sling.

WEB SLING WEIGHTS*

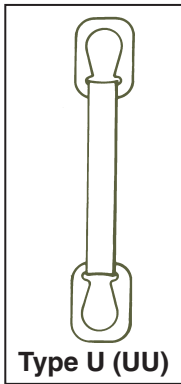

Part Number	Minimum Standard Length		Additional Foot
	Ft.	Wt.** (lbs.)	Wt. (lbs.)
Unilink			
UU1802	3	2.7	.12
UU1803	3	5.6	.18
UU1804	4	9.2	.24
UU2802	3	2.9	.25
UU2803	3	5.8	.38
UU2804	3	9.2	.50

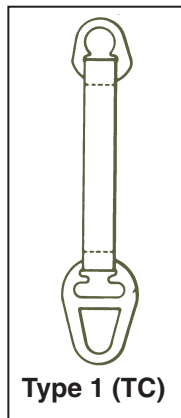

Triangle & Choker			
TC1802	3	3.5	.12
TC1803	3	6.3	.18
TC1804	4	9.0	.24
TC1806	4	21	.36
TC1808	5	27	.48
TC1810	5	48	.60
TC1812	6	65	.72
TC2802	3	3.6	.25
TC2803	3	6.5	.38
TC2804	3	9.1	.50
TC2806	4	21	.76
TC2808	4	39	1.0
TC2810	5	63	1.3
TC2812	5	86	1.5

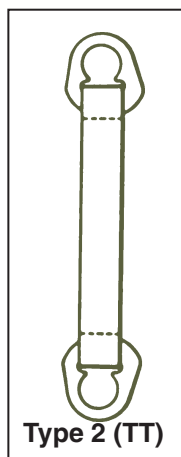

Triangle & Triangle			
TT1802	3	2.6	.12
TT1803	3	4.6	.18
TT1804	3	6.7	.24
TT1806	4	15	.36
TT1808	5	19	.48
TT1810	5	36	.60
TT1812	5	44	.72
TT2802	3	2.7	.25
TT2803	3	4.8	.38
TT2804	3	7.0	.50
TT2806	3	15	.76
TT2808	4	28	1.0
TT2810	4	46	1.3
TT2812	5	60	1.5

* Weights will vary. Published weights are average weights for *Webmaster* 1600 slings.

** Approximate weight for the minimum standard length as shown.



WEB SLING WEIGHTS*

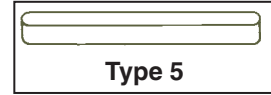
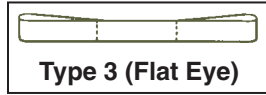

Web Slings

Eye & Eye			
Part Number	Minimum Standard Length		Additional Foot Weight (lbs.)
	Ft.	Wt.** (lbs.)	
EE1801	3	0.4	.06
EE1802	4	0.9	.12
EE1803	4	1.4	.18
EE1804	4	1.9	.24
EE1806	5	3.4	.36
EE1808	6	5.3	.48
EE1810	8	8.0	.60
EE1812	8	9.8	.72
EE2801	3	0.4	.13
EE2802	3	0.9	.25
EE2803	4	1.7	.38
EE2804	4	2.3	.50
EE2806	6	4.9	.76
EE2808	6	6.5	1.0
EE2810	7	9.4	1.3
EE2812	8	13	1.5
EE3801	4	1.0	.20
EE3802	4	2.1	.40
EE3803	5	3.7	.59
EE3804	5	5.0	.79
EE3806	5	7.6	1.2
EE3808	7	13	1.6
EE3810	7	16	2.0
EE3812	7	20	2.4
EE4801	4	1.1	.26
EE4802	4	2.2	.53
EE4803	5	4.1	.79
EE4804	5	5.5	1.1
EE4806	5	8.3	1.6
EE4808	7	15	2.1
EE4810	7	19	2.6
EE4812	7	23	3.2

Endless			
Part Number	Minimum Standard Length		Additional Foot Weight (lbs.)
	Ft.	Wt.** (lbs.)	
EN1801	3	.40	.12
EN1802	3	.80	.24
EN1803	3	1.3	.36
EN1804	3	1.7	.48
EN1806	3	2.5	.72
EN1808	3	3.4	.96
EN1810	3	4.2	1.2
EN1812	3	5.0	1.4
EN2801	3	.80	.25
EN2802	3	1.6	.50
EN2803	3	2.5	.76
EN2804	3	3.3	1.0
EN2806	3	4.9	1.5
EN2808	3	6.6	2.0
EN2810	3	8.2	2.5
EN2812	3	9.9	3.0
EN3801	3	1.2	.38
EN3802	3	2.4	.76
EN3803	3	3.6	1.1
EN3804	3	4.8	1.5
EN3806	3	7.2	2.3
EN3808	3	9.6	3.0
EN3810	3	12	3.8
EN3812	3	14	4.5
EN4801	3	1.6	.52
EN4802	3	3.2	1.0
EN4803	3	4.9	1.6
EN4804	3	6.5	2.1
EN4806	3	9.7	3.1
EN4808	3	13	4.2
EN4810	3	16	5.2
EN4812	3	19	6.2

* Weights will vary. Published weights are average weights for *Webmaster 1600* slings.

** Approximate weight for the minimum standard length as shown.



WEB SLING WEIGHTS*

Attached Eye Wide-Lift		
Part Number	10-ft. Sling Weight (lbs.)	Additional Foot Weight (lbs.)
WLA1806	3.8	.36
WLA1808	4.9	.48
WLA1810	5.6	.60
WLA1812	6.2	.72
WLA1816	9.5	1.1
WLA1820	12	1.3
WLA1824	14	1.6
WLA2806	4.2	.36
WLA2808	5.4	.48
WLA2812	7.4	.72
WLA2816	12	1.1
WLA2820	15	1.3
WLA2824	16	1.6
WLA2830	17	2.0
WLA2836	17	2.4
WLA2848	20	3.2

Continuous Eye Wide-Lift		
Part Number	10-ft. Sling Weight (lbs.)	Additional Foot Weight (lbs.)
WL1806	5.8	.54
WL1808	7.1	.66
WL1810	8.4	.78
WL1812	9.7	.90
WL1816	12	1.1
WL1820	15	1.4
WL1824	17	1.6
WL1830	23	2.2
WL1836	27	2.5
WL2806	9.4	.9
WL2808	12	1.1
WL2812	17	1.6
WL2816	22	2.1
WL2820	27	2.6
WL2824	31	3.0
WL2830	41	4.0
WL2836	48	4.6

* Weights will vary. Published weights are average weights using *Webmaster 1600* webbing.