

# **Specification & Commercial Drainage**

**Options Pricing Guide v. 07.27.22**



# **Specification Drainage**

**Floor Drains**

**Floor Sinks**

**Roof Drains**

**Cleanouts**

**Fixture Carriers**

# Specification Drainage



## Floor Drains

Adjustable and non-adjustable floor drains for on-grade and above-grade applications.  
Designed in accordance with *ASME A112.6.3 Standard for Floor and Trench Drains*.

**Note:** All floor drains installed in above-grade applications must be leak tested for watertightness according to local codes and standards. Failure to do so will void the warranty.

## Floor Sinks

Enamel-coated cast iron floor sinks designed for direct or indirect waste applications.  
Designed in accordance with *ASME A112.6.7 Standard for Sanitary Floor Sinks*.

**Note:** All floor sinks installed in above-grade applications must be leak tested for watertightness according to local codes and standards. Failure to do so will void the warranty.

## Roof Drains

Roof drain, overflow, scupper and accessory fixtures available with cast iron connections.  
Designed in accordance with *ASME A112.6.4 Standard for Roof, Deck, and Balcony Drains*.

**Note:** All roof drains must be leak tested for watertightness according to local codes and standards. Failure to do so will void the warranty.

## Cleanouts

Adjustable and non-adjustable cleanout fixtures provide access to drain lines.  
Designed in accordance with *ASME A112.36.2M Standard for Cleanouts*.

**Note:** All floor cleanouts installed in above-grade applications must be leak tested for watertightness according to local codes and standards. Failure to do so will void the warranty.

## Fixture Carriers

Floor-mounted Carriers and supports for commercial water closet and lavatory fixtures.  
Designed in accordance with *ASME A112.6.1M Standard for Floor-Affixed Supports for Off-The-Floor Plumbing Fixtures for Public Use*.

# Specification Floor Drains

**FinishLine™ Floor Drains**

**FatMax™ Floor Drains**

**Above-Grade Floor Drains**

**Halo™ Floor Drains**

Sioux Chief's FinishLine™ Floor drain system is adjustable both before and AFTER the concrete pour.

The FinishLine virtually eliminates drains set too low or not level. Installations that are faster, easier, and more professional-looking.

**Floor Drain  
Accessories**





**832-4DNR**  
Page 235



**832-25DNR**  
Page 236



**832-6DNR**  
Page 237



**832-63DSQ**  
Page 238



**832-3SSR**  
Page 239



**833-22DNQ**  
Page 240



**833-225DSR**  
Page 241



**833-62DNQ**  
Page 243



**862-235NR**  
Page 245



**862-245SQ**  
Page 246



**862-249I**  
Page 247



**862-625NQ**  
Page 248



**862-627NRE**  
Page 248



**862-625SR**  
Page 249



**862-629I**  
Page 250



**822-2DNR**  
Page 251



**822-F3DNR**  
Page 252



**860-22I**  
Page 253



**860-Q222I**  
Page 254



**860-3SS**  
Page 255



**862-47LNRE**  
Page 256



**862-47LIN**  
Page 257



**835-3CQ**  
Page 235



**836-2**  
Page 258



**863-FACQ**  
Page 235

Cast Iron - No-Hub Connection

6-1/2" Tops

Options: Add suffix to item no. Add price to list

V = Vandal-Resistant Strainer: \$23.00; H = Hinged Strainer (1): \$54.00;

E = Extended Ring (2): \$267.00; B = Complies with Buy American Act (2): \$211.00;

M = Medium-duty strainer (3,000 lbs. safe-load) (3): \$134.00;

1: Not available for iron strainers 2: For round nickel bronze ring/strainer only 3: For round 304 SS ring/strainer only

Item Number	Item Description	Pkg Type	Min Qty	Case Qty	Price
<b>ROUGH-IN FIXTURE</b>					
832-3DF	3" No-Hub	Bl	1	5	\$230.00
832-4DF	4" No-Hub	Bl	1	5	\$322.00
<b>FINISH FIXTURE</b>					
832-4DHIR	6-1/2" Rnd Ductile Iron Ring & Strainer	Bl	1	10	\$278.00
832-4DHNQ	7" Sqr Nikl-Brnz Ring & Strainer	Bl	1	10	\$453.00
832-4DHNR	6-1/2" Rnd Nikl-Brnz Ring & Strainer	Bl	1	10	\$320.00
832-4DHSQ	7" Sqr Stnls Steel Ring & Strainer	Bl	1	10	\$453.00
832-4DHSR	6-1/2" Rnd Stnls Steel Ring & Strainer	Bl	1	10	\$320.00
<b>COMPLETE ASSEMBLY</b>					
832-3DIR	3" No-Hub - 6-1/2" Rnd Ductile Iron Ring & Strainer	Bl	1	1	\$644.00
832-3DNQ	3" No-Hub - 7" Sqr Nikl-Brnz Ring & Strainer	Bl	1	1	\$828.00
832-3DNR	3" No-Hub - 6-1/2" Rnd Nikl-Brnz Ring & Strainer	Bl	1	1	\$671.60
832-3DSQ	3" No-Hub - 7" Sqr Stnls Steel Ring & Strainer	Bl	1	1	\$1,472.00
832-3DSR	3" No-Hub - 6-1/2" Rnd Stnls Steel Ring & Strainer	Bl	1	1	\$1,380.00
832-4DIR	4" No-Hub - 6-1/2" Rnd Ductile Iron Ring & Strainer	Bl	1	1	\$644.00
832-4DNQ	4" No-Hub - 7" Sqr Nikl-Brnz Ring & Strainer	Bl	1	1	\$828.00
832-4DNR	4" No-Hub - 6-1/2" Rnd Nikl-Brnz Ring & Strainer	Bl	1	1	\$671.60
832-4DSQ	4" No-Hub - 7" Sqr Stnls Steel Ring & Strainer	Bl	1	1	\$1,472.00
832-4DSR	4" No-Hub - 6-1/2" Rnd Stnls Steel Ring & Strainer	Bl	1	1	\$1,380.00
<b>ACCESSORIES</b>					
832-EX4CQ	Ductile Iron Extension Adapter - 2" Min - 4" Max	Bl	1	1	\$120.00
832-PCQ	Coring Plug Wrench	Bl	1	1	\$87.00
832-S4CQ	Two Adjustment Shims, Two 3/4" Screws	Bl	1	1	\$22.00
832-UMCQ	4-1/4" Stainless Steel Debris Basket	Bl	1	1	\$75.00
832-WCQ	Flexible Red Locating Bristles w/ Screw	Bl	1	1	\$26.00
835-3CQ	Trapshield™ For 3" Drain Outlet	Bl	1	25	\$224.00
835-4CQ	Trapshield™ For 4" Drain Outlet	Bl	1	20	\$265.00
863-FACQ	Round Aluminum Condensate Funnel w/ Screws	Bl	1	12	\$168.00
863-FNCQ	Round Nikl-Brnz Condensate Funnel w/ Screws	Bl	1	12	\$370.00
863-FNOCQ	Oval Nikl-Brnz Condensate Funnel w/ Screws	Bl	1	12	\$815.00



832-3DF



Finish Fixture



832-4DNR



832-EX4CQ

Supply

Drainage

Support

Specialties

Appendix



832-25DF



832-3DHNQ



832-25DNR



832-PCQ

## Cast Iron - No-Hub Connection

### 5-1/2" Tops

Options: Add suffix to item no. Add price to list

V = Vandal-Resistant Strainer: \$23.00; B = Complies with Buy American Act (1): \$211.00;

E = Extended Ring (1): \$267.00;

1: For round nickel bronze ring/strainer only

Item Number	Item Description	Pkg Type	Min Qty	Case Qty	Price
<b>ROUGH-IN FIXTURE</b>					
832-25DF	2" No-Hub	BI	1	1	\$230.00
832-35DF	3" No-Hub	BI	1	1	\$276.00
<b>FINISH FIXTURE</b>					
832-3DHNQ	5-7/8" Sqr Nikl-Brnz Ring & Strainer	BI	1	1	\$340.00
832-3DHNQ	5-1/2" Rnd Nikl-Brnz Ring & Strainer	BI	1	10	\$260.00
832-3DHSQ	5-7/8" Sqr Stnls Steel Ring & Strainer	BI	1	1	\$340.00
832-3DHSR	5-1/2" Rnd Stnls Steel Ring & Strainer	BI	1	1	\$260.00
<b>COMPLETE ASSEMBLY</b>					
832-25DNQ	2" No-Hub - 5-7/8" Sqr Nikl-Brnz Ring & Strainer	BI	1	1	\$736.00
832-25DNR	2" No-Hub - 5-1/2" Rnd Nikl-Brnz Ring & Strainer	BI	1	1	\$552.00
832-25DSQ	2" No-Hub - 5-7/8" Sqr Stnls Steel Ring & Strainer	BI	1	1	\$1,196.00
832-25DSR	2" No-Hub - 5-1/2" Rnd Stnls Steel Ring & Strainer	BI	1	1	\$1,104.00
832-35DNQ	3" No-Hub - 5-7/8" Sqr Nikl-Brnz Ring & Strainer	BI	1	1	\$736.00
832-35DNR	3" No-Hub - 5-1/2" Rnd Nikl-Brnz Ring & Strainer	BI	1	1	\$552.00
832-35DSQ	3" No-Hub - 5-7/8" Sqr Stnls Steel Ring & Strainer	BI	1	1	\$1,196.00
832-35DSR	3" No-Hub - 5-1/2" Rnd Stnls Steel Ring & Strainer	BI	1	1	\$1,104.00
<b>ACCESSORIES</b>					
832-EX3CQ	Ductile Iron Extension Adapter - 2" Min - 3-3/8" Max	BI	1	1	\$120.00
832-PCQ	Coring Plug Wrench	BI	1	1	\$87.00
832-S3CQ	Two Adjustment Shims, Two 3/4" Screws	BI	1	1	\$22.00
832-WCQ	Flexible Red Locating Bristles w/ Screw	BI	1	1	\$26.00
835-2CQ	Trapshield™ For 2" Drain Outlet	BI	1	50	\$199.00
835-3CQ	Trapshield™ For 3" Drain Outlet	BI	1	25	\$224.00
863-FACQ	Round Aluminum Condensate Funnel w/ Screws	BI	1	12	\$168.00
863-FNCQ	Round Nikl-Brnz Condensate Funnel w/ Screws	BI	1	12	\$370.00
863-FNOCQ	Oval Nikl-Brnz Condensate Funnel w/ Screws	BI	1	12	\$815.00

Cast Iron - No-Hub Connection

9" Tops

Options: Add suffix to item no. Add price to list  
 V = Vandal-Resistant Strainer: \$23.00; C = Clamping Collar: \$149.00;

Item Number	Item Description	Pkg Type	Min Qty	Case Qty	Price
<b>ROUGH-IN FIXTURE</b>					
832-49DF	4" No-Hub	BI	1	1	\$530.00
832-6DF	6" No-Hub	BI	1	1	\$530.00
<b>FINISH FIXTURE</b>					
832-6DHNR	9" Rnd Nikl-Brnz Ring & Strainer	BI	1	1	\$679.00
832-6DHSR	9" Rnd Stnls Steel Ring & Strainer	BI	1	1	\$679.00
<b>COMPLETE ASSEMBLY</b>					
832-49DNR	4" No-Hub - 9" Rnd Nikl-Brnz Ring & Strainer	BI	1	1	\$1,207.00
832-49DSR	4" No-Hub - 9" Rnd Stnls Steel Ring & Strainer	BI	1	1	\$1,207.00
832-6DNR	6" No-Hub - 9" Rnd Nikl-Brnz Ring & Strainer	BI	1	1	\$1,207.00
832-6DSR	6" No-Hub - 9" Rnd Stnls Steel Ring & Strainer	BI	1	1	\$1,207.00
<b>ACCESSORIES</b>					
832-PCQ	Coring Plug Wrench	BI	1	1	\$87.00
832-SD9	Ductile iron strainer - sets inside Coring Sleeve. Use in place of Finish Fixture	BI	1	1	\$306.00
832-WCQ	Flexible Red Locating Bristles w/ Screw	BI	1	1	\$26.00
835-4CQ	Trapshield™ For 4" Drain Outlet	BI	1	20	\$265.00
863-FACQ	Round Aluminum Condensate Funnel w/ Screws	BI	1	12	\$168.00
863-FNCQ	Round Nikl-Brnz Condensate Funnel w/ Screws	BI	1	12	\$370.00
863-FNOCQ	Oval Nikl-Brnz Condensate Funnel w/ Screws	BI	1	12	\$815.00



832-49DF



832-6DHNR



832-6DNR



832-WCQ

Cast Iron - Push-Joint Connection

6-1/2" Tops

Options: Add suffix to item no. Add price to list  
 V = Vandal-Resistant Strainer: \$23.00; H = Hinged Strainer (1): \$54.00;  
 E = Extended Ring (2): \$267.00; B = Complies with Buy American Act (2): \$211.00;  
 M = Medium-duty strainer (3,000 lbs. safe-load) (3): \$134.00; P = Push-joint gasket to fit Sch. 40 ABS/PVC pipe: \$25.00;

1: Not available for iron strainers 2: For round nickel bronze ring/strainer only 3: For round 304 SS ring/strainer only

Item Number	Item Description	Pkg Type	Min Qty	Case Qty	Price
<b>ROUGH-IN FIXTURE</b>					
832-63DF	3" PJ Conn.	BI	1	1	\$276.00
832-64DF	4" PJ Conn.	BI	1	1	\$368.00



832-63DF

Supply

Drainage

Support

Specialties

Appendix

Supply

Drainage

Support

Specialties

Appendix



832-4DHNQ



832-63DSQ



832-S4CQ

### Cast Iron - Push-Joint Connection (Cont)

#### 6-1/2" Tops

Item Number	Item Description	Pkg Type	Min Qty	Case Qty	Price
<b>FINISH FIXTURE</b>					
832-4DHIR	6-1/2" Rnd Ductile Iron Ring & Strainer	BI	1	10	\$278.00
832-4DHNQ	7" Sqr Nikl-Brnz Ring & Strainer	BI	1	10	\$453.00
832-4DHNR	6-1/2" Rnd Nikl-Brnz Ring & Strainer	BI	1	10	\$320.00
832-4DHSQ	7" Sqr Stnls Steel Ring & Strainer	BI	1	10	\$453.00
832-4DHSR	6-1/2" Rnd Stnls Steel Ring & Strainer	BI	1	10	\$320.00
<b>COMPLETE ASSEMBLY</b>					
<b>832-63DIR</b>	3" PJ Conn. - 6-1/2" Rnd Ductile Iron Ring & Strainer	BI	1	1	\$644.00
832-63DNQ	3" PJ Conn. - 7" Sqr Nikl-Brnz Ring & Strainer	BI	1	1	\$828.00
832-63DNR	3" PJ Conn. - 6-1/2" Rnd Nikl-Brnz Ring & Strainer	BI	1	1	\$671.60
<b>832-63DSQ</b>	3" PJ Conn. - 7" Sqr Stnls Steel Ring & Strainer	BI	1	1	\$1,472.00
<b>832-63DSR</b>	3" PJ Conn. - 6-1/2" Rnd Stnls Steel Ring & Strainer	BI	1	1	\$1,380.00
832-64DIR	4" PJ Conn. - 6-1/2" Rnd Ductile Iron Ring & Strainer	BI	1	1	\$644.00
<b>832-64DNQ</b>	4" PJ Conn. - 7" Sqr Nikl-Brnz Ring & Strainer	BI	1	1	\$828.00
832-64DNR	4" PJ Conn. - 6-1/2" Rnd Nikl-Brnz Ring & Strainer	BI	1	1	\$671.60
<b>832-64DSQ</b>	4" PJ Conn. - 7" Sqr Stnls Steel Ring & Strainer	BI	1	1	\$1,472.00
<b>832-64DSR</b>	4" PJ Conn. - 6-1/2" Rnd Stnls Steel Ring & Strainer	BI	1	1	\$1,380.00
<b>ACCESSORIES</b>					
<b>832-EX4CQ</b>	Ductile Iron Extension Adapter - 2" Min - 4" Max	BI	1	1	\$120.00
<b>832-PCQ</b>	Coring Plug Wrench	BI	1	1	\$87.00
<b>832-S4CQ</b>	Two Adjustment Shims, Two 3/4" Screws	BI	1	1	\$22.00
<b>832-UMCQ</b>	4-1/4" Stainless Steel Debris Basket	BI	1	1	\$75.00
<b>832-WCQ</b>	Flexible Red Locating Bristles w/ Screw	BI	1	1	\$26.00
<b>835-3CQ</b>	Trapshield™ For 3" Drain Outlet	BI	1	25	\$224.00
<b>835-4CQ</b>	Trapshield™ For 4" Drain Outlet	BI	1	20	\$265.00
<b>858-PG3CQ</b>	Push-Joint Gasket For 3" Sch. 40 Pipe	BI	1	1	\$55.00
<b>858-PG4CQ</b>	Push-Joint Gasket For 4" Sch. 40 Pipe	BI	1	1	\$53.00
<b>863-FACQ</b>	Round Aluminum Condensate Funnel w/ Screws	BI	1	12	\$168.00
<b>863-FNCQ</b>	Round Nikl-Brnz Condensate Funnel w/ Screws	BI	1	12	\$370.00
<b>863-FNOCQ</b>	Oval Nikl-Brnz Condensate Funnel w/ Screws	BI	1	12	\$815.00

**Stainless Steel - No-Hub Connection**

**6-1/2" Tops**

**Options:** Add suffix to item no. Add price to list  
**V** = Vandal-Resistant Strainer: \$23.00; **H** = Hinged Strainer: \$54.00;  
**M** = Medium-duty strainer (3,000 lbs. safe-load) (1): \$134.00;

1: Not available for square ring/strainer

Item Number	Item Description	Pkg Type	Min Qty	Case Qty	Price
<b>ROUGH-IN FIXTURE</b>					
832-3SF	3" No-Hub	Bl	1	1	\$1,420.00
832-4SF	4" No-Hub	Bl	1	1	\$1,420.00
<b>FINISH FIXTURE</b>					
832-4SHSQ	7" Sqr Stnls Steel Ring & Strainer	Bl	1	1	\$780.00
832-4SHSR	6-1/2" Rnd Stnls Steel Ring & Strainer	Bl	1	1	\$668.00
<b>COMPLETE ASSEMBLY</b>					
832-3SSQ	3" No-Hub - 7" Sqr Stnls Steel Ring & Strainer	Bl	1	1	\$2,198.00
832-3SSR	3" No-Hub - 6-1/2" Rnd Stnls Steel Ring & Strainer	Bl	1	1	\$2,087.00
832-4SSQ	4" No-Hub - 7" Sqr Stnls Steel Ring & Strainer	Bl	1	1	\$2,198.00
832-4SSR	4" No-Hub - 6-1/2" Rnd Stnls Steel Ring & Strainer	Bl	1	1	\$2,087.00
<b>ACCESSORIES</b>					
832-PCQ	Coring Plug Wrench	Bl	1	1	\$87.00
832-S4CQ	Two Adjustment Shims, Two 3/4" Screws	Bl	1	1	\$22.00
832-UMCQ	4-1/4" Stainless Steel Debris Basket	Bl	1	1	\$75.00
832-WCQ	Flexible Red Locating Bristles w/ Screw	Bl	1	1	\$26.00
835-3CQ	Trapshield™ For 3" Drain Outlet	Bl	1	25	\$224.00
835-4CQ	Trapshield™ For 4" Drain Outlet	Bl	1	20	\$265.00
863-FACQ	Round Aluminum Condensate Funnel w/ Screws	Bl	1	12	\$168.00
863-FNCQ	Round Nikl-Brnz Condensate Funnel w/ Screws	Bl	1	12	\$370.00
863-FNOCQ	Oval Nikl-Brnz Condensate Funnel w/ Screws	Bl	1	12	\$815.00



832-4SF



832-4SHSR



832-3SSR

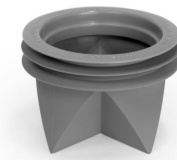

835-3CQ

Supply

Drainage

Support

Specialties

Appendix



833-22DF



832-4DHIR



833-22DNQ

## Cast Iron - No-Hub Connection

### 6-1/2" Tops

**Options:** Add suffix to item no. Add price to list

**V** = Vandal-Resistant Strainer: \$23.00; **H** = Hinged Strainer (1): \$54.00;

**E** = Extended Ring (2): \$267.00; **B** = Complies with Buy American Act (2): \$211.00;

**M** = Medium-duty strainer (3,000 lbs safe-load) (3): \$134.00;

1: Not available for iron strainers 2: For round nickel bronze ring/strainer only 3: For round 304 SS ring/strainer only

Item Number	Item Description	Pkg Type	Min Qty	Case Qty	Price
<b>ROUGH-IN FIXTURE</b>					
833-22DF	2" No-Hub	BI	1	1	\$250.00
833-23DF	3" No-Hub	BI	1	1	\$300.00
833-24DF	4" No-Hub	BI	1	1	\$350.00
<b>FINISH FIXTURE</b>					
832-4DHIR	6-1/2" Rnd Ductile Iron Ring & Strainer	BI	1	10	\$278.00
832-4DHNQ	7" Sqr Nikl-Brmz Ring & Strainer	BI	1	10	\$453.00
832-4DHNR	6-1/2" Rnd Nikl-Brmz Ring & Strainer	BI	1	10	\$320.00
832-4DHSQ	7" Sqr Stnls Steel Ring & Strainer	BI	1	10	\$453.00
832-4DHSR	6-1/2" Rnd Stnls Steel Ring & Strainer	BI	1	10	\$320.00
<b>COMPLETE ASSEMBLY</b>					
833-22DIR	2" No-Hub - 6-1/2" Rnd Ductile Iron Ring & Strainer	BI	1	1	\$700.00
833-22DNQ	2" No-Hub - 7" Sqr Nikl-Brmz Ring & Strainer	BI	1	1	\$900.00
833-22DNR	2" No-Hub - 6-1/2" Rnd Nikl-Brmz Ring & Strainer	BI	1	1	\$730.00
<b>833-22DSQ</b>	2" No-Hub - 7" Sqr Stnls Steel Ring & Strainer	BI	1	1	\$1,600.00
<b>833-22DSR</b>	2" No-Hub - 6-1/2" Rnd Stnls Steel Ring & Strainer	BI	1	1	\$1,500.00
833-23DIR	3" No-Hub - 6-1/2" Rnd Ductile Iron Ring & Strainer	BI	1	1	\$700.00
833-23DNQ	3" No-Hub - 7" Sqr Nikl-Brmz Ring & Strainer	BI	1	1	\$890.00
833-23DNR	3" No-Hub - 6-1/2" Rnd Nikl-Brmz Ring & Strainer	BI	1	1	\$730.00
<b>833-23DSQ</b>	3" No-Hub - 7" Sqr Stnls Steel Ring & Strainer	BI	1	1	\$1,600.00
<b>833-23DSR</b>	3" No-Hub - 6-1/2" Rnd Stnls Steel Ring & Strainer	BI	1	1	\$1,500.00
833-24DIR	4" No-Hub - 6-1/2" Rnd Ductile Iron Ring & Strainer	BI	1	1	\$700.00
833-24DNQ	4" No-Hub - 7" Sqr Nikl-Brmz Ring & Strainer	BI	1	1	\$900.00
833-24DNR	4" No-Hub - 6-1/2" Rnd Nikl-Brmz Ring & Strainer	BI	1	1	\$730.00
<b>833-24DSQ</b>	4" No-Hub - 7" Sqr Stnls Steel Ring & Strainer	BI	1	1	\$1,600.00
<b>833-24DSR</b>	4" No-Hub - 6-1/2" Rnd Stnls Steel Ring & Strainer	BI	1	1	\$1,500.00

Cast Iron - No-Hub Connection (Cont)

6-1/2" Tops

Item Number	Item Description	Pkg Type	Min Qty	Case Qty	Price
<b>ACCESSORIES</b>					
832-EX4CQ	Ductile Iron Extension Adapter - 2" Min - 4" Max	BI	1	1	\$120.00
832-PCQ	Coring Plug Wrench	BI	1	1	\$87.00
832-S4CQ	Two Adjustment Shims, Two 3/4" Screws	BI	1	1	\$22.00
832-UMCQ	4-1/4" Stainless Steel Debris Basket	BI	1	1	\$75.00
832-WCQ	Flexible Red Locating Bristles w/ Screw	BI	1	1	\$26.00
835-2CQ	Trapshield™ For 2" Drain Outlet	BI	1	50	\$199.00
835-3CQ	Trapshield™ For 3" Drain Outlet	BI	1	25	\$224.00
835-4CQ	Trapshield™ For 4" Drain Outlet	BI	1	20	\$265.00
863-FACQ	Round Aluminum Condensate Funnel w/ Screws	BI	1	12	\$168.00
863-FNCQ	Round Nikl-Brnz Condensate Funnel w/ Screws	BI	1	12	\$370.00
863-FNOCQ	Oval Nikl-Brnz Condensate Funnel w/ Screws	BI	1	12	\$815.00



832-EX4CQ

Cast Iron - No-Hub Connection

5-1/2" Tops

Options: Add suffix to item no. Add price to list

V = Vandal-Resistant Strainer: \$23.00; B = Complies with Buy American Act (1): \$211.00;

E = Extended ring (1): \$267.00;

1: For round nickel bronze ring/strainer only

Item Number	Item Description	Pkg Type	Min Qty	Case Qty	Price
<b>ROUGH-IN FIXTURE</b>					
833-225DF	2" No-Hub	BI	1	1	\$250.00
833-235DF	3" No-Hub	BI	1	1	\$300.00
<b>FINISH FIXTURE</b>					
832-3DHNQ	5-7/8" Sqr Nikl-Brnz Ring & Strainer	BI	1	1	\$340.00
832-3DHNH	5-1/2" Rnd Nikl-Brnz Ring & Strainer	BI	1	10	\$260.00
832-3DHSQ	5-7/8" Sqr Stnls Steel Ring & Strainer	BI	1	1	\$340.00
832-3DHSR	5-1/2" Rnd Stnls Steel Ring & Strainer	BI	1	1	\$260.00
<b>COMPLETE ASSEMBLY</b>					
833-225DNQ	2" No-Hub - 5-7/8" Sqr Nikl-Brnz Ring & Strainer	BI	1	1	\$800.00
833-225DNR	2" No-Hub - 5-1/2" Rnd Nikl-Brnz Ring & Strainer	BI	1	1	\$600.00
833-225DSQ	2" No-Hub - 5-7/8" Sqr Stnls Steel Ring & Strainer	BI	1	1	\$1,300.00
833-225DSR	2" No-Hub - 5-1/2" Rnd Stnls Steel Ring & Strainer	BI	1	1	\$1,200.00
833-235DNQ	3" No-Hub - 5-7/8" Sqr Nikl-Brnz Ring & Strainer	BI	1	1	\$800.00
833-235DNR	3" No-Hub - 5-1/2" Rnd Nikl-Brnz Ring & Strainer	BI	1	1	\$600.00
833-235DSQ	3" No-Hub - 5-7/8" Sqr Stnls Steel Ring & Strainer	BI	1	1	\$1,300.00
833-235DSR	3" No-Hub - 5-1/2" Rnd Stnls Steel Ring & Strainer	BI	1	1	\$1,200.00



833-225DF



833-235DF



833-225DSR



835-3CQ

### Cast Iron - No-Hub Connection (Cont)

#### 5-1/2" Tops

Item Number	Item Description	Pkg Type	Min Qty	Case Qty	Price
<b>ACCESSORIES</b>					
832-EX3CQ	Ductile Iron Extension Adapter - 2" Min - 3-3/8" Max	BI	1	1	\$120.00
832-PCQ	Coring Plug Wrench	BI	1	1	\$87.00
832-S3CQ	Two Adjustment Shims, Two 3/4" Screws	BI	1	1	\$22.00
832-WCQ	Flexible Red Locating Bristles w/ Screw	BI	1	1	\$26.00
835-2CQ	Trapshield™ For 2" Drain Outlet	BI	1	50	\$199.00
835-3CQ	Trapshield™ For 3" Drain Outlet	BI	1	25	\$224.00
863-FACQ	Round Aluminum Condensate Funnel w/ Screws	BI	1	12	\$168.00
863-FNCQ	Round Nikl-Brnz Condensate Funnel w/ Screws	BI	1	12	\$370.00
863-FNOCQ	Oval Nikl-Brnz Condensate Funnel w/ Screws	BI	1	12	\$815.00

### Cast Iron - Push-Joint Connection

#### 6-1/2" Tops



833-62DF



832-4DHIR

**Options:** Add suffix to item no. Add price to list

**V** = Vandal-Resistant Strainer: \$23.00; **H** = Hinged Strainer (1): \$54.00;

**E** = Extended ring (2): \$267.00; **B** = Complies with Buy American Act (2): \$211.00;

**M** = Medium-duty strainer (3,000 lbs. safe-load) (3): \$134.00; **P** = Push-joint gasket to fit Sch. 40 ABS/PVC pipe (4): \$25.00;

1: Not available for iron strainers. 2: For round nickel bronze ring/strainer only 3: For round 304 SS ring/strainer only 4: Not available for 2" drains.

Item Number	Item Description	Pkg Type	Min Qty	Case Qty	Price
<b>ROUGH-IN FIXTURE</b>					
833-62DF	2" PJ Conn.	BI	1	1	\$300.00
833-63DF	3" PJ Conn.	BI	1	1	\$350.00
833-64DF	4" PJ Conn.	BI	1	1	\$400.00
<b>FINISH FIXTURE</b>					
832-4DHIR	6-1/2" Rnd Ductile Iron Ring & Strainer	BI	1	10	\$278.00
832-4DHNQ	7" Sqr Nikl-Brnz Ring & Strainer	BI	1	10	\$453.00
832-4DHNR	6-1/2" Rnd Nikl-Brnz Ring & Strainer	BI	1	10	\$320.00
832-4DHSQ	7" Sqr Stnls Steel Ring & Strainer	BI	1	10	\$453.00
832-4DHSR	6-1/2" Rnd Stnls Steel Ring & Strainer	BI	1	10	\$320.00

Cast Iron - Push-Joint Connection (Cont)

6-1/2" Tops

Item Number	Item Description	Pkg Type	Min Qty	Case Qty	Price
<b>COMPLETE ASSEMBLY</b>					
833-62DIR	2" PJ Conn. - 6-1/2" Rnd Ductile Iron Ring & Strainer	BI	1	1	\$700.00
833-62DNQ	2" PJ Conn. - 7" Sqr Nikl-Brnz Ring & Strainer	BI	1	1	\$900.00
833-62DNR	2" PJ Conn. - 6-1/2" Rnd Nikl-Brnz Ring & Strainer	BI	1	1	\$730.00
833-62DSQ	2" PJ Conn. - 7" Sqr Stnls Steel Ring & Strainer	BI	1	1	\$1,600.00
833-62DSR	2" PJ Conn. - 6-1/2" Rnd Stnls Steel Ring & Strainer	BI	1	1	\$1,500.00
833-63DIR	3" PJ Conn. - 6-1/2" Rnd Ductile Iron Ring & Strainer	BI	1	1	\$700.00
833-63DNQ	3" PJ Conn. - 7" Sqr Nikl-Brnz Ring & Strainer	BI	1	1	\$900.00
833-63DNR	3" PJ Conn. - 6-1/2" Rnd Nikl-Brnz Ring & Strainer	BI	1	1	\$730.00
833-63DSQ	3" PJ Conn. - 7" Sqr Stnls Steel Ring & Strainer	BI	1	1	\$1,600.00
833-63DSR	3" PJ Conn. - 6-1/2" Rnd Stnls Steel Ring & Strainer	BI	1	1	\$1,500.00
833-64DIR	4" PJ Conn. - 6-1/2" Rnd Ductile Iron Ring & Strainer	BI	1	1	\$700.00
833-64DNQ	4" PJ Conn. - 7" Sqr Nikl-Brnz Ring & Strainer	BI	1	1	\$900.00
833-64DNR	4" PJ Conn. - 6-1/2" Rnd Nikl-Brnz Ring & Strainer	BI	1	1	\$730.00
833-64DSQ	4" PJ Conn. - 7" Sqr Stnls Steel Ring & Strainer	BI	1	1	\$1,600.00
833-64DSR	4" PJ Conn. - 6-1/2" Rnd Stnls Steel Ring & Strainer	BI	1	1	\$1,500.00
<b>ACCESSORIES</b>					
832-EX4CQ	Ductile Iron Extension Adapter - 2" Min - 4" Max	BI	1	1	\$120.00
832-PCQ	Coring Plug Wrench	BI	1	1	\$87.00
832-S4CQ	Two Adjustment Shims, Two 3/4" Screws	BI	1	1	\$22.00
832-UMCQ	4-1/4" Stainless Steel Debris Basket	BI	1	1	\$75.00
832-WCQ	Flexible Red Locating Bristles w/ Screw	BI	1	1	\$26.00
835-2CQ	Trapshield™ For 2" Drain Outlet	BI	1	50	\$199.00
835-3CQ	Trapshield™ For 3" Drain Outlet	BI	1	25	\$224.00
835-4CQ	Trapshield™ For 4" Drain Outlet	BI	1	20	\$265.00
858-PG3CQ	Push-Joint Gasket For 3" Sch. 40 Pipe	BI	1	1	\$55.00
858-PG4CQ	Push-Joint Gasket For 4" Sch. 40 Pipe	BI	1	1	\$53.00
863-FACQ	Round Aluminum Condensate Funnel w/ Screws	BI	1	12	\$168.00
863-FNCQ	Round Nikl-Brnz Condensate Funnel w/ Screws	BI	1	12	\$370.00
863-FNOCQ	Oval Nikl-Brnz Condensate Funnel w/ Screws	BI	1	12	\$815.00



833-62DNQ



858-PG3CQ

Supply

Drainage

Support

Specialties

Appendix



833-635DF



832-3DHSR



833-625DSQ



832-EX3CQ

## Cast Iron - Push-Joint Connection

### 5-1/2" Tops

**Options:** Add suffix to item no. Add price to list

**V** = Vandal-Resistant Strainer: \$23.00; **B** = Complies with Buy American Act (1): \$211.00;

**E** = Extended ring (1): \$267.00; **P** = Push-joint gasket to fit Sch. 40 pipe (2): \$25.00;

1: For round nickel bronze ring/strainer only 2: For 3" drains only.

Item Number	Item Description	Pkg Type	Min Qty	Case Qty	Price
<b>ROUGH-IN FIXTURE</b>					
833-625DF	2" PJ Conn.	BI	1	1	\$300.00
833-635DF	3" PJ Conn.	BI	1	1	\$350.00
<b>FINISH FIXTURE</b>					
832-3DHNQ	5-7/8" Sqr Nikl-Brnz Ring & Strainer	BI	1	1	\$340.00
832-3DHNR	5-1/2" Rnd Nikl-Brnz Ring & Strainer	BI	1	10	\$260.00
832-3DHSQ	5-7/8" Sqr Stnls Steel Ring & Strainer	BI	1	1	\$340.00
832-3DHSR	5-1/2" Rnd Stnls Steel Ring & Strainer	BI	1	1	\$260.00
<b>COMPLETE ASSEMBLY</b>					
833-625DNQ	2" PJ Conn. - 5-7/8" Sqr Nikl-Brnz Ring & Strainer	BI	1	1	\$800.00
833-625DNR	2" PJ Conn. - 5-1/2" Rnd Nikl-Brnz Ring & Strainer	BI	1	1	\$600.00
833-625DSQ	2" PJ Conn. - 5-7/8" Sqr Stnls Steel Ring & Strainer	BI	1	1	\$1,300.00
833-625DSR	2" PJ Conn. - 5-1/2" Rnd Stnls Steel Ring & Strainer	BI	1	1	\$1,200.00
833-635DNQ	3" PJ Conn. - 5-7/8" Sqr Nikl-Brnz Ring & Strainer	BI	1	1	\$800.00
833-635DNR	3" PJ Conn. - 5-1/2" Rnd Nikl-Brnz Ring & Strainer	BI	1	1	\$600.00
833-635DSQ	3" PJ Conn. - 5-7/8" Sqr Stnls Steel Ring & Strainer	BI	1	1	\$1,300.00
833-635DSR	3" PJ Conn. - 5-1/2" Rnd Stnls Steel Ring & Strainer	BI	1	1	\$1,200.00
<b>ACCESSORIES</b>					
832-EX3CQ	Ductile Iron Extension Adapter - 2" Min - 3-3/8" Max	BI	1	1	\$120.00
832-PCQ	Coring Plug Wrench	BI	1	1	\$87.00
832-S3CQ	Two Adjustment Shims, Two 3/4" Screws	BI	1	1	\$22.00
832-WCQ	Flexible Red Locating Bristles w/ Screw	BI	1	1	\$26.00
835-2CQ	Trapshield™ For 2" Drain Outlet	BI	1	50	\$199.00
835-3CQ	Trapshield™ For 3" Drain Outlet	BI	1	25	\$224.00
858-PG3CQ	Push-Joint Gasket For 3" Sch. 40 Pipe	BI	1	1	\$55.00
863-FACQ	Round Aluminum Condensate Funnel w/ Screws	BI	1	12	\$168.00
863-FNCQ	Round Nikl-Brnz Condensate Funnel w/ Screws	BI	1	12	\$370.00
863-FNOCQ	Oval Nikl-Brnz Condensate Funnel w/ Screws	BI	1	12	\$815.00

**Cast Iron - No-Hub Connection**

**Nickel-Bronze Ring & Strainer**

Options: Add suffix to item no. Add price to list

A = Acid-Resistant Epoxy Coated Cast Iron: \$175.00; B = Sediment Bucket: \$105.00;

Item Number	Item Description	Pkg Type	Min Qty	Case Qty	Price
<b>5" ROUND STRAINER</b>					
862-225NR	2" No-Hub - 5" Nikl-Brnz Ring & Strainer	B	1	1	\$540.00
862-235NR	3" No-Hub - 5" Nikl-Brnz Ring & Strainer	B	1	1	\$540.00
862-245NR	4" No-Hub - 5" Nikl-Brnz Ring & Strainer	B	1	1	\$600.00
<b>6" ROUND STRAINER</b>					
862-226NR	2" No-Hub - 6" Nikl-Brnz Ring & Strainer	B	1	1	\$657.00
862-236NR	3" No-Hub - 6" Nikl-Brnz Ring & Strainer	B	1	1	\$657.00
862-246NR	4" No-Hub - 6" Nikl-Brnz Ring & Strainer	B	1	1	\$657.00
<b>7" ROUND STRAINER</b>					
862-227NR	2" No-Hub - 7" Nikl-Brnz Ring & Strainer	B	1	1	\$845.00
862-237NR	3" No-Hub - 7" Nikl-Brnz Ring & Strainer	B	1	1	\$845.00
862-247NR	4" No-Hub - 7" Nikl-Brnz Ring & Strainer	B	1	1	\$845.00
<b>8" ROUND STRAINER</b>					
862-228NR	2" No-Hub - 8" Nikl-Brnz Ring & Strainer	B	1	1	\$1,000.00
862-238NR	3" No-Hub - 8" Nikl-Brnz Ring & Strainer	B	1	1	\$1,000.00
862-248NR	4" No-Hub - 8" Nikl-Brnz Ring & Strainer	B	1	1	\$1,000.00
<b>10" ROUND STRAINER</b>					
862-2210NR	2" No-Hub - 10" Nikl-Brnz Ring & Strainer	B	1	1	\$1,300.00
862-2310NR	3" No-Hub - 10" Nikl-Brnz Ring & Strainer	B	1	1	\$1,300.00
862-2410NR	4" No-Hub - 10" Nikl-Brnz Ring & Strainer	B	1	1	\$1,300.00
<b>5" SQUARE STRAINER</b>					
862-225NQ	2" No-Hub - 5" Nikl-Brnz Ring & Strainer	B	1	1	\$720.00
862-235NQ	3" No-Hub - 5" Nikl-Brnz Ring & Strainer	B	1	1	\$720.00
862-245NQ	4" No-Hub - 5" Nikl-Brnz Ring & Strainer	B	1	1	\$800.00
<b>6" SQUARE STRAINER</b>					
862-226NQ	2" No-Hub - 6" Nikl-Brnz Ring & Strainer	B	1	1	\$810.00
862-236NQ	3" No-Hub - 6" Nikl-Brnz Ring & Strainer	B	1	1	\$801.00
862-246NQ	4" No-Hub - 6" Nikl-Brnz Ring & Strainer	B	1	1	\$810.00
<b>7" SQUARE STRAINER</b>					
862-227NQ	2" No-Hub - 7" Nikl-Brnz Ring & Strainer	B	1	1	\$1,000.00
862-237NQ	3" No-Hub - 7" Nikl-Brnz Ring & Strainer	B	1	1	\$1,000.00
862-247NQ	4" No-Hub - 7" Nikl-Brnz Ring & Strainer	B	1	1	\$1,000.00
<b>8" SQUARE STRAINER</b>					
862-228NQ	2" No-Hub - 8" Nikl-Brnz Ring & Strainer	B	1	1	\$1,300.00
862-238NQ	3" No-Hub - 8" Nikl-Brnz Ring & Strainer	B	1	1	\$1,300.00
862-248NQ	4" No-Hub - 8" Nikl-Brnz Ring & Strainer	B	1	1	\$1,300.00
<b>10" SQUARE STRAINER</b>					
862-2210NQ	2" No-Hub - 10" Nikl-Brnz Ring & Strainer	B	1	1	\$1,600.00
862-2310NQ	3" No-Hub - 10" Nikl-Brnz Ring & Strainer	B	1	1	\$1,600.00
862-2410NQ	4" No-Hub - 10" Nikl-Brnz Ring & Strainer	B	1	1	\$1,600.00
<b>ACCESSORIES</b>					
862-EX4	4" Threaded Extension Adapter - MIP X FIP	B	1	1	\$120.00
863-FACQ	Round Aluminum Condensate Funnel w/ Screws	BI	1	12	\$168.00
863-FNCQ	Round Nikl-Brnz Condensate Funnel w/ Screws	BI	1	12	\$370.00
863-FNOCQ	Oval Nikl-Brnz Condensate Funnel w/ Screws	BI	1	12	\$815.00



862-235NR

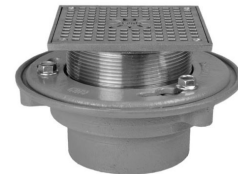

862-226NQ

Supply

Drainage

Support

Specialties

Appendix



862-247NRE

### Cast Iron - No-Hub Connection

#### Nickel-Bronze Ring & Strainer - Extended Rim

Options: Add suffix to item no. Add price to list

A = Acid-Resistant Epoxy Coated Cast Iron: \$175.00; B = Sediment Bucket: \$105.00;

Item Number	Item Description	Pkg Type	Min Qty	Case Qty	Price
<b>7" ROUND STRAINER</b>					
862-227NRE	2" No-Hub - 7" Nikl-Brnz Ring & Strainer	B	1	1	\$1,400.00
862-237NRE	3" No-Hub - 7" Nikl-Brnz Ring & Strainer	B	1	1	\$1,400.00
862-247NRE	4" No-Hub - 7" Nikl-Brnz Ring & Strainer	B	1	1	\$1,400.00
<b>10" ROUND STRAINER</b>					
862-2210NRE	2" No-Hub - 10" Nikl-Brnz Ring & Strainer	B	1	1	\$1,500.00
862-2310NRE	3" No-Hub - 10" Nikl-Brnz Ring & Strainer	B	1	1	\$2,000.00
862-2410NRE	4" No-Hub - 10" Nikl-Brnz Ring & Strainer	B	1	1	\$2,000.00
<b>ACCESSORIES</b>					
862-EX4	4" Threaded Extension Adapter - MIP X FIP	B	1	1	\$120.00



862-245SR



862-245SQ

### Cast Iron - No-Hub Connection

#### Stainless Steel Ring & Strainer

Options: Add suffix to item no. Add price to list

A = Acid-Resistant Epoxy Coated Cast Iron: \$175.00; B = Sediment Bucket: \$105.00;

Item Number	Item Description	Pkg Type	Min Qty	Case Qty	Price
<b>5" ROUND STRAINER</b>					
862-225SR	2" No-Hub - 5" Stnls Steel Ring & Strainer	B	1	1	\$1,080.00
862-235SR	3" No-Hub - 5" Stnls Steel Ring & Strainer	B	1	1	\$1,080.00
862-245SR	4" No-Hub - 5" Stnls Steel Ring & Strainer	B	1	1	\$1,200.00
<b>6" ROUND STRAINER</b>					
862-226SR	2" No-Hub - 6" Stnls Steel Ring & Strainer	B	1	1	\$1,350.00
862-236SR	3" No-Hub - 6" Stnls Steel Ring & Strainer	B	1	1	\$1,350.00
862-246SR	4" No-Hub - 6" Stnls Steel Ring & Strainer	B	1	1	\$1,350.00
<b>5" SQUARE STRAINER</b>					
862-225SQ	2" No-Hub - 5" Stnls Steel Ring & Strainer	B	1	1	\$1,170.00
862-235SQ	3" No-Hub - 5" Stnls Steel Ring & Strainer	B	1	1	\$1,170.00
862-245SQ	4" No-Hub - 5" Stnls Steel Ring & Strainer	B	1	1	\$1,300.00
<b>6" SQUARE STRAINER</b>					
862-226SQ	2" No-Hub - 6" Stnls Steel Ring & Strainer	B	1	1	\$1,440.00
862-236SQ	3" No-Hub - 6" Stnls Steel Ring & Strainer	B	1	1	\$1,440.00
862-246SQ	4" No-Hub - 6" Stnls Steel Ring & Strainer	B	1	1	\$1,440.00
<b>ACCESSORIES</b>					
862-EX4	4" Threaded Extension Adapter - MIP X FIP	B	1	1	\$120.00

**Cast Iron - No-Hub Connection**

**Cast Iron Strainer**

Options: Add suffix to item no. Add price to list

A = Acid-Resistant Epoxy Coated Cast Iron: \$175.00; B = Sediment Bucket: \$105.00;

Item Number	Item Description	Pkg Type	Min Qty	Case Qty	Price
<b>7" ROUND STRAINER</b>					
862-227I	2" No-Hub - 7" Ductile Iron Ring & Strainer	B	1	1	\$630.00
862-227IN	2" No-Hub - 7-1/4" Ductile Iron w/ NB Veneer Ring & Strainer	B	1	1	\$900.00
862-237I	3" No-Hub - 7" Ductile Iron Ring & Strainer	B	1	1	\$630.00
862-237IN	3" No-Hub - 7-1/4" Ductile Iron w/ NB Veneer Ring & Strainer	B	1	1	\$900.00
862-247I	4" No-Hub - 7" Ductile Iron Ring & Strainer	B	1	1	\$630.00
862-247IN	4" No-Hub - 7-1/4" Ductile Iron w/ NB Veneer Ring & Strainer	B	1	1	\$900.00
<b>9" ROUND STRAINER</b>					
862-229I	2" No-Hub - 9" Ductile Iron Ring & Strainer	B	1	1	\$872.00
862-229IN	2" No-Hub - 9-3/8" Ductile Iron w/ NB Veneer Ring & Strainer	B	1	1	\$1,250.00
862-239I	3" No-Hub - 9" Ductile Iron Ring & Strainer	B	1	1	\$872.00
862-239IN	3" No-Hub - 9-3/8" Ductile Iron w/ NB Veneer Ring & Strainer	B	1	1	\$1,250.00
862-249I	4" No-Hub - 9" Ductile Iron Ring & Strainer	B	1	1	\$872.00
862-249IN	4" No-Hub - 9-3/8" Ductile Iron w/ NB Veneer Ring & Strainer	B	1	1	\$1,250.00
<b>ACCESSORIES</b>					
862-EX4	4" Threaded Extension Adapter - MIP X FIP	B	1	1	\$120.00

**Cast Iron - Push-Joint Connection**

**Nickel-Bronze Ring & Strainer**

Options: Add suffix to item no. Add price to list

A = Acid-Resistant Epoxy Coated Cast Iron: \$175.00; B = Sediment Bucket: \$105.00;

Item Number	Item Description	Pkg Type	Min Qty	Case Qty	Price
<b>5" ROUND STRAINER</b>					
862-625NR	2" PJ Conn. - 5" Nikl-Bmz Ring & Strainer	B	1	1	\$540.00
862-635NR	3" PJ Conn. - 5" Nikl-Bmz Ring & Strainer	B	1	1	\$540.00
862-645NR	4" PJ Conn. - 5" Nikl-Bmz Ring & Strainer	B	1	1	\$600.00
<b>6" ROUND STRAINER</b>					
862-626NR	2" PJ Conn. - 6" Nikl-Bmz Ring & Strainer	B	1	1	\$657.00
862-636NR	3" PJ Conn. - 6" Nikl-Bmz Ring & Strainer	B	1	1	\$657.00
862-646NR	4" PJ Conn. - 6" Nikl-Bmz Ring & Strainer	B	1	1	\$657.00
<b>7" ROUND STRAINER</b>					
862-627NR	2" PJ Conn. - 7" Nikl-Bmz Ring & Strainer	B	1	1	\$845.00
862-637NR	3" PJ Conn. - 7" Nikl-Bmz Ring & Strainer	B	1	1	\$845.00
862-647NR	4" PJ Conn. - 7" Nikl-Bmz Ring & Strainer	B	1	1	\$845.00



862-247IN



862-249I



862-625NR



862-625NQ

### Cast Iron - Push-Joint Connection (Cont)

#### Nickel-Bronze Ring & Strainer

Item Number	Item Description	Pkg Type	Min Qty	Case Qty	Price
<b>8" ROUND STRAINER</b>					
862-628NR	2" PJ Conn. - 8" Nikl-Brnz Ring & Strainer	B	1	1	\$1,000.00
862-638NR	3" PJ Conn. - 8" Nikl-Brnz Ring & Strainer	B	1	1	\$1,000.00
862-648NR	4" PJ Conn. - 8" Nikl-Brnz Ring & Strainer	B	1	1	\$1,000.00
<b>10" ROUND STRAINER</b>					
862-6210NR	2" PJ Conn. - 10" Nikl-Brnz Ring & Strainer	B	1	1	\$1,200.00
862-6310NR	3" PJ Conn. - 10" Nikl-Brnz Ring & Strainer	B	1	1	\$1,200.00
862-6410NR	4" PJ Conn. - 10" Nikl-Brnz Ring & Strainer	B	1	1	\$1,200.00
<b>5" SQUARE STRAINER</b>					
862-625NQ	2" PJ Conn. - 5" Nikl-Brnz Ring & Strainer	B	1	1	\$720.00
862-635NQ	3" PJ Conn. - 5" Nikl-Brnz Ring & Strainer	B	1	1	\$720.00
862-645NQ	4" PJ Conn. - 5" Nikl-Brnz Ring & Strainer	B	1	1	\$800.00
<b>6" SQUARE STRAINER</b>					
862-626NQ	2" PJ Conn. - 6" Nikl-Brnz Ring & Strainer	B	1	1	\$810.00
862-636NQ	3" PJ Conn. - 6" Nikl-Brnz Ring & Strainer	B	1	1	\$810.00
862-646NQ	4" PJ Conn. - 6" Nikl-Brnz Ring & Strainer	B	1	1	\$810.00
<b>7" SQUARE STRAINER</b>					
862-627NQ	2" PJ Conn. - 7" Nikl-Brnz Ring & Strainer	B	1	1	\$1,000.00
862-637NQ	3" PJ Conn. - 7" Nikl-Brnz Ring & Strainer	B	1	1	\$1,000.00
862-647NQ	4" PJ Conn. - 7" Nikl-Brnz Ring & Strainer	B	1	1	\$1,000.00
<b>8" SQUARE STRAINER</b>					
862-628NQ	2" PJ Conn. - 8" Nikl-Brnz Ring & Strainer	B	1	1	\$1,300.00
862-638NQ	3" PJ Conn. - 8" Nikl-Brnz Ring & Strainer	B	1	1	\$1,300.00
862-648NQ	4" PJ Conn. - 8" Nikl-Brnz Ring & Strainer	B	1	1	\$1,300.00
<b>10" SQUARE STRAINER</b>					
862-6210NQ	2" PJ Conn. - 10" Nikl-Brnz Ring & Strainer	B	1	1	\$1,600.00
862-6310NQ	3" PJ Conn. - 10" Nikl-Brnz Ring & Strainer	B	1	1	\$1,600.00
862-6410NQ	4" PJ Conn. - 10" Nikl-Brnz Ring & Strainer	B	1	1	\$1,600.00
<b>ACCESSORIES</b>					
862-EX4	4" Threaded Extension Adapter - MIP X FIP	B	1	1	\$120.00
863-FACQ	Round Aluminum Condensate Funnel w/ Screws	BI	1	12	\$168.00
863-FNCQ	Round Nikl-Brnz Condensate Funnel w/ Screws	BI	1	12	\$370.00
863-FNOCQ	Oval Nikl-Brnz Condensate Funnel w/ Screws	BI	1	12	\$815.00

### Cast Iron - Push-Joint Connection

#### Nickel-Bronze Ring & Strainer - Extended Rim



862-627NRE

**Options:** Add suffix to item no. Add price to list

**A** = Acid-Resistant Epoxy Coated Cast Iron: \$175.00; **B** = Sediment Bucket: \$105.00;

Item Number	Item Description	Pkg Type	Min Qty	Case Qty	Price
<b>7" ROUND STRAINER</b>					
862-627NRE	2" PJ Conn. - 7" Nikl-Brnz Ring & Strainer	B	1	1	\$1,400.00
862-637NRE	3" PJ Conn. - 7" Nikl-Brnz Ring & Strainer	B	1	1	\$1,400.00
862-647NRE	4" PJ Conn. - 7" Nikl-Brnz Ring & Strainer	B	1	1	\$1,400.00

## Cast Iron - Push-Joint Connection (Cont)

### Nickel-Bronze Ring & Strainer - Extended Rim

Item Number	Item Description	Pkg Type	Min Qty	Case Qty	Price
<b>10" ROUND STRAINER</b>					
862-6210NRE	2" PJ Conn. - 10" Nikl-Brnz Ring & Strainer	B	1	1	\$2,000.00
862-6310NRE	3" PJ Conn. - 10" Nikl-Brnz Ring & Strainer	B	1	1	\$2,000.00
862-6410NRE	4" PJ Conn. - 10" Nikl-Brnz Ring & Strainer	B	1	1	\$2,000.00
<b>ACCESSORIES</b>					
862-EX4	4" Threaded Extension Adapter - MIP X FIP	B	1	1	\$120.00

## Cast Iron - Push-Joint Connection

### Stainless Steel Ring & Strainer

**Options:** Add suffix to item no. Add price to list

A = Acid-Resistant Epoxy Coated Cast Iron: \$175.00; B = Sediment Bucket: \$105.00;

Item Number	Item Description	Pkg Type	Min Qty	Case Qty	Price
<b>5" ROUND STRAINER</b>					
862-625SR	2" PJ Conn. - 5" Stnls Steel Ring & Strainer	B	1	1	\$1,080.00
862-635SR	3" PJ Conn. - 5" Stnls Steel Ring & Strainer	B	1	1	\$1,080.00
862-645SR	4" PJ Conn. - 5" Stnls Steel Ring & Strainer	B	1	1	\$1,200.00
<b>6" ROUND STRAINER</b>					
862-626SR	2" PJ Conn. - 6" Stnls Steel Ring & Strainer	B	1	1	\$1,350.00
862-636SR	3" PJ Conn. - 6" Stnls Steel Ring & Strainer	B	1	1	\$1,350.00
862-646SR	4" PJ Conn. - 6" Stnls Steel Ring & Strainer	B	1	1	\$1,350.00
<b>5" SQUARE STRAINER</b>					
862-625SQ	2" PJ Conn. - 5" Stnls Steel Ring & Strainer	B	1	1	\$1,170.00
862-635SQ	3" PJ Conn. - 5" Stnls Steel Ring & Strainer	B	1	1	\$1,170.00
862-645SQ	4" PJ Conn. - 5" Stnls Steel Ring & Strainer	B	1	1	\$1,300.00
<b>6" SQUARE STRAINER</b>					
862-626SQ	2" PJ Conn. - 6" Stnls Steel Ring & Strainer	B	1	1	\$1,440.00
862-636SQ	3" PJ Conn. - 6" Stnls Steel Ring & Strainer	B	1	1	\$1,440.00
862-646SQ	4" PJ Conn. - 6" Stnls Steel Ring & Strainer	B	1	1	\$1,440.00
<b>ACCESSORIES</b>					
862-EX4	4" Threaded Extension Adapter - MIP X FIP	B	1	1	\$120.00



862-625SR



862-625SQ



862-627I



862-627IN



862-629I

## Cast Iron - Push-Joint Connection

### Cast Iron Strainer

**Options:** Add suffix to item no. Add price to list

**A** = Acid-Resistant Epoxy Coated Cast Iron: \$175.00; **B** = Sediment Bucket: \$105.00;

Item Number	Item Description	Pkg Type	Min Qty	Case Qty	Price
<b>7" ROUND STRAINER</b>					
862-627I	2" PJ Conn. - 7" Ductile Iron Ring & Strainer	B	1	1	\$630.00
862-627IN	2" PJ Conn. - 7-1/4" Ductile Iron w/ NB Veneer Ring & Strainer	B	1	1	\$900.00
862-637I	3" PJ Conn. - 7" Ductile Iron Ring & Strainer	B	1	1	\$630.00
862-637IN	3" PJ Conn. - 7-1/4" Ductile Iron w/ NB Veneer Ring & Strainer	B	1	1	\$900.00
862-647I	4" PJ Conn. - 7" Ductile Iron Ring & Strainer	B	1	1	\$630.00
862-647IN	4" PJ Conn. - 7-1/4" Ductile Iron w/ NB Veneer Ring & Strainer	B	1	1	\$900.00
<b>9" ROUND STRAINER</b>					
862-629I	2" PJ Conn. - 9" Ductile Iron Ring & Strainer	B	1	1	\$872.00
862-629IN	2" PJ Conn. - 9-3/8" Ductile Iron w/ NB Veneer Ring & Strainer	B	1	1	\$1,250.00
862-639I	3" PJ Conn. - 9" Ductile Iron Ring & Strainer	B	1	1	\$872.00
862-639IN	3" PJ Conn. - 9-3/8" Ductile Iron w/ NB Veneer Ring & Strainer	B	1	1	\$1,250.00
862-649I	4" PJ Conn. - 9" Ductile Iron Ring & Strainer	B	1	1	\$872.00
862-649IN	4" PJ Conn. - 9-3/8" Ductile Iron w/ NB Veneer Ring & Strainer	B	1	1	\$1,250.00
<b>ACCESSORIES</b>					
862-EX4	4" Threaded Extension Adapter - MIP X FIP	B	1	1	\$120.00

Halo™ Floor Drains

Cast Iron - No-Hub Connection

Options: Add suffix to item no. Add price to list

M = Clamping collar kit (1): \$70.00; V = Vandal-Resistant Strainer: \$23.00;

B = Complies with Buy American Act (2): \$211.00; E = Extended Ring (2): \$267.00;

9 = 90-deg. Side Outlet Connection: \$86.00;

1: Add 'M' code after dash - other options to end of item no. 2: For round nickel bronze ring/strainer only

Item Number	Item Description	Pkg Type	Min Qty	Case Qty	Price
<b>NICKEL-BRONZE RING &amp; STRAINER</b>					
822-2DNQ	2" No-Hub - 5-7/8" Sqr Ring & Strainer	BI	1	4	\$588.00
822-2DNR	2" No-Hub - 5-1/2" Rnd Ring & Strainer	BI	1	4	\$500.00
822-3DNQ	3" No-Hub - 5-7/8" Sqr Ring & Strainer	BI	1	4	\$588.00
822-3DNR	3" No-Hub - 5-1/2" Rnd Ring & Strainer	BI	1	4	\$500.00
<b>STAINLESS STEEL RING &amp; STRAINER</b>					
822-2DSQ	2" No-Hub - 5-7/8" Sqr Ring & Strainer	BI	1	4	\$588.00
822-2DSR	2" No-Hub - 5-1/2" Rnd Ring & Strainer	BI	1	4	\$500.00
822-3DSQ	3" No-Hub - 5-7/8" Sqr Ring & Strainer	BI	1	1	\$588.00
822-3DSR	3" No-Hub - 5-1/2" Rnd Ring & Strainer	BI	1	1	\$500.00
<b>ACCESSORIES</b>					
822-EX3CQ	Ductile Iron Extension Adapter	BI	1	1	\$120.00
835-2CQ	Trapshield™ For 2" Drain Outlet	BI	1	50	\$199.00
835-35CQ	Trapshield™ For 3-1/2" Drain Outlet	BI	1	25	\$224.00
835-3CQ	Trapshield™ For 3" Drain Outlet	BI	1	25	\$224.00
863-FACQ	Round Aluminum Condensate Funnel w/ Screws	BI	1	12	\$168.00
863-FNCQ	Round Nikl-Brnz Condensate Funnel w/ Screws	BI	1	12	\$370.00



822-2DNR



822-2DSQ

FinishLine Halo™ Floor Drains

Cast Iron - No-Hub Connection

Options: Add suffix to item no. Add price to list

M = Clamping collar kit (1): \$70.00; V = Vandal-Resistant Strainer: \$23.00;

B = Complies with Buy American Act (2): \$211.00; E = Extended Ring (2): \$267.00;

9 = 90-deg. Side Outlet Connection: \$86.00;

1: Add 'M' code after dash - other options to end of item no. 2: For round nickel bronze ring/strainer only

Item Number	Item Description	Pkg Type	Min Qty	Case Qty	Price
<b>ROUGH-IN FIXTURE</b>					
822-2DF	2" No-Hub	BI	1	1	\$311.00
822-3DF	3" No-Hub	BI	1	4	\$311.00
<b>FINISH FIXTURE</b>					
832-3DHNQ	5-7/8" Sqr Nikl-Brnz Ring & Strainer	BI	1	1	\$340.00
832-3DHNR	5-1/2" Rnd Nikl-Brnz Ring & Strainer	BI	1	10	\$260.00
832-3DHSQ	5-7/8" Sqr Stnls Steel Ring & Strainer	BI	1	1	\$340.00
832-3DHSR	5-1/2" Rnd Stnls Steel Ring & Strainer	BI	1	1	\$260.00



822-2DF



832-3DHNQ



822-F3DSR

## FinishLine Halo™ Floor Drains (Cont)

### Cast Iron - No-Hub Connection

Item Number	Item Description	Pkg Type	Min Qty	Case Qty	Price
<b>COMPLETE ASSEMBLY</b>					
822-F2DNQ	2" No-Hub - 5-7/8" Sqr Nikl-Brnz Ring & Strainer	BI	1	1	\$664.00
822-F2DNR	2" No-Hub - 5-1/2" Rnd Nikl-Brnz Ring & Strainer	BI	1	1	\$581.00
<b>822-F2DSQ</b>	2" No-Hub - 5-7/8" Sqr Stnls Steel Ring & Strainer	BI	1	1	\$664.00
<b>822-F2DSR</b>	2" No-Hub - 5-1/2" Rnd Stnls Steel Ring & Strainer	BI	1	1	\$581.00
822-F3DNQ	3" No-Hub - 5-7/8" Sqr Nikl-Brnz Ring & Strainer	BI	1	1	\$664.00
822-F3DNR	3" No-Hub - 5-1/2" Rnd Nikl-Brnz Ring & Strainer	BI	1	1	\$581.00
<b>822-F3DSQ</b>	3" No-Hub - 5-7/8" Sqr Stnls Steel Ring & Strainer	BI	1	1	\$664.00
<b>822-F3DSR</b>	3" No-Hub - 5-1/2" Rnd Stnls Steel Ring & Strainer	BI	1	1	\$581.00
<b>ACCESSORIES</b>					
<b>822-EX3CQ</b>	Ductile Iron Extension Adapter	BI	1	1	\$120.00
<b>832-EX3CQ</b>	Ductile Iron Extension Adapter - 2" Min - 3-3/8" Max	BI	1	1	\$120.00
<b>832-S3CQ</b>	Two Adjustment Shims, Two 3/4" Screws	BI	1	1	\$22.00
<b>835-2CQ</b>	Trapshield™ For 2" Drain Outlet	BI	1	50	\$199.00
<b>835-3CQ</b>	Trapshield™ For 3" Drain Outlet	BI	1	25	\$224.00
<b>863-FACQ</b>	Round Aluminum Condensate Funnel w/ Screws	BI	1	12	\$168.00
<b>863-FNCQ</b>	Round Nikl-Brnz Condensate Funnel w/ Screws	BI	1	12	\$370.00

9" Diameter

Cast Iron - No-Hub Connection

Options: Add suffix to item no. Add price to list

S = ABS Sand Bucket: \$83.00; U = ABS Debris Bucket: \$83.00;

C = Cast Iron Clamping Collar: \$149.00; V = Vandal-Resistant Strainer (1): \$68.00;

W = Stainless Steel Debris Basket: \$180.00; F = Round Nickel-Bronze Condensate Funnel: \$370.00;

FA = Round Aluminum Condensate Funnel: \$168.00; FO = Oval Nickel-Bronze Condensate Funnel: \$815.00;

6 = ABS Flat Strainer for Drain Outlet (2): \$68.00;

1: Not available for drains with cast iron strainers 2: Not available for 6" drains

Item Number	Item Description	Pkg Type	Min Qty	Case Qty	Price
<b>NICKEL-BRONZE RING &amp; STRAINER</b>					
860-22N	2" No-Hub - 10" Rnd Grate	Bl	1	1	\$1,420.00
860-23N	3" No-Hub - 10" Rnd Grate	Bl	1	1	\$1,491.00
860-24N	4" No-Hub - 10" Rnd Grate	Bl	1	1	\$1,420.00
860-26N	6" No-Hub - 10" Rnd Grate	Bl	1	1	\$1,420.00
<b>STAINLESS STEEL RING &amp; STRAINER</b>					
860-22Z	2" No-Hub - 10" Rnd Grate	Bl	1	1	\$1,491.00
860-23Z	3" No-Hub - 10" Rnd Grate	Bl	1	1	\$1,491.00
860-24Z	4" No-Hub - 10" Rnd Grate	Bl	1	1	\$1,420.00
860-26Z	6" No-Hub - 10" Rnd Grate	Bl	1	1	\$1,420.00
<b>CAST IRON STRAINER</b>					
860-22I	2" No-Hub - 9-1/4" Rnd Grate	Bl	1	1	\$636.00
860-23I	3" No-Hub - 9-1/4" Rnd Grate	Bl	1	1	\$636.00
860-24I	4" No-Hub - 9-1/4" Rnd Grate	Bl	1	1	\$636.00
860-26I	6" No-Hub - 9-1/4" Rnd Grate	Bl	1	1	\$636.00

9" Diameter

Cast Iron - Push-Joint Connection

Options: Add suffix to item no. Add price to list

S = ABS Sand Bucket: \$83.00; U = ABS Debris Bucket: \$83.00;

C = Cast iron Clamping Collar: \$149.00; V = Vandal-Resistant Strainer (1): \$68.00;

W = Stainless Steel Debris Basket: \$180.00; F = Round Nickel-Bronze Condensate Funnel: \$370.00;

FA = Round Aluminum Condensate Funnel: \$168.00; FO = Oval Nickel-Bronze Condensate Funnel: \$815.00;

6 = ABS Flat Strainer for Drain Outlet: \$68.00; P = Push-Joint Gasket to fit Sch. 40 Pipe (2): \$25.00;

1: Not available for drains with cast iron strainers 2: For drains with 3" and 4" push-joint connections

Item Number	Item Description	Pkg Type	Min Qty	Case Qty	Price
<b>NICKEL-BRONZE RING &amp; STRAINER</b>					
860-62N	2" PJ Conn. - 10" Rnd Grate	Bl	1	1	\$1,420.00
860-63N	3" PJ Conn. - 10" Rnd Grate	Bl	1	1	\$1,420.00
860-64N	4" PJ Conn. - 10" Rnd Grate	Bl	1	1	\$1,491.00



860-22N



860-23Z



860-22I



860-62N

Supply

Drainage

Support

Specialties

Appendix



860-63Z



860-62I



860-R222I



860-Q222I

## 9" Diameter (Cont)

### Cast Iron - Push-Joint Connection

Item Number	Item Description	Pkg Type	Min Qty	Case Qty	Price
<b>STAINLESS STEEL RING &amp; STRAINER</b>					
860-62Z	2" PJ Conn. - 10" Rnd Grate	BI	1	1	\$1,420.00
<b>860-63Z</b>	3" PJ Conn. - 10" Rnd Grate	BI	1	1	\$1,420.00
<b>860-64Z</b>	4" PJ Conn. - 10" Rnd Grate	BI	1	1	\$1,491.00
<b>CAST IRON STRAINER</b>					
860-62I	2" PJ Conn. - 9-1/4" Rnd Grate	BI	1	1	\$636.00
<b>860-63I</b>	3" PJ Conn. - 9-1/4" Rnd Grate	BI	1	1	\$636.00
860-64I	4" PJ Conn. - 9-1/4" Rnd Grate	BI	1	1	\$636.00

## 12" Diameter

### Cast Iron - No-Hub Connection

**Options:** Add suffix to item no. Add price to list

**9** = 90-deg. Side Outlet Connection (1): \$490.00; **A** = Acid-Resistant Epoxy Coated Cast Iron: \$1,100.00;

**B** = Sediment Bucket (2): \$220.00; **E** = Adjustable Extension: \$690.00;

**H** = Hinged Square Grate: \$650.00; **X** = Extra Heavy-duty Grate: \$250.00;

1: For 2" - 4" No-Hub Only 2: Not available for drains with Adjustable Extension

Item Number	Item Description	Pkg Type	Min Qty	Case Qty	Price
<b>ROUND CAST IRON STRAINER</b>					
<b>860-R222I</b>	2" No-Hub - 12" Ring & Strainer	B	1	1	\$1,575.00
860-R223I	3" No-Hub - 12" Ring & Strainer	B	1	1	\$1,575.00
860-R224I	4" No-Hub - 12" Ring & Strainer	B	1	1	\$1,575.00
860-R226I	6" No-Hub - 12" Ring & Strainer	B	1	1	\$1,575.00
<b>860-R228I</b>	8" No-Hub - 12" Ring & Strainer	B	1	1	\$1,950.00
<b>ROUND CAST IRON STRAINER - NICKEL-BRONZE VENEER</b>					
<b>860-R222IN</b>	2" No-Hub - 12" Ring & Strainer	B	1	1	\$2,200.00
860-R223IN	3" No-Hub - 12" Ring & Strainer	B	1	1	\$2,200.00
860-R224IN	4" No-Hub - 12" Ring & Strainer	B	1	1	\$2,200.00
860-R226IN	6" No-Hub - 12" Ring & Strainer	B	1	1	\$2,200.00
<b>860-R228IN</b>	8" No-Hub - 12" Ring & Strainer	B	1	1	\$2,800.00
<b>SQUARE CAST IRON STRAINER</b>					
<b>860-Q222I</b>	2" No-Hub - 12" Ring & Strainer	B	1	1	\$1,860.00
860-Q223I	3" No-Hub - 12" Ring & Strainer	B	1	1	\$1,860.00
860-Q224I	4" No-Hub - 12" Ring & Strainer	B	1	1	\$1,860.00
860-Q226I	6" No-Hub - 12" Ring & Strainer	B	1	1	\$1,860.00
<b>860-Q228I</b>	8" No-Hub - 12" Ring & Strainer	B	1	1	\$2,237.00
<b>SQUARE CAST IRON STRAINER - NICKEL-BRONZE VENEER</b>					
<b>860-Q222IN</b>	2" No-Hub - 12" Ring & Strainer	B	1	1	\$2,800.00
860-Q223IN	3" No-Hub - 12" Ring & Strainer	B	1	1	\$2,800.00
860-Q224IN	4" No-Hub - 12" Ring & Strainer	B	1	1	\$2,800.00
860-Q226IN	6" No-Hub - 12" Ring & Strainer	B	1	1	\$2,800.00
<b>860-Q228IN</b>	8" No-Hub - 12" Ring & Strainer	B	1	1	\$3,080.00

**12" Diameter**

**Cast Iron - Push-Joint Connection**

**Options:** Add suffix to item no. Add price to list

**9** = 90-deg. Side Outlet Connection (1): \$490.00; **A** = Acid-Resistant Epoxy Coated Cast Iron: \$1,100.00;

**B** = Sediment Bucket (2): \$220.00; **E** = Adjustable Extension: \$690.00;

**H** = Hinged Square Grate: \$650.00; **X** = Extra Heavy-duty Grate: \$250.00;

1: For 2" - 4" No-Hub Only 2: Not available for drains with Adjustable Extension



860-R262I



860-Q262I

Item Number	Item Description	Pkg Type	Min Qty	Case Qty	Price
<b>ROUND CAST IRON STRAINER</b>					
860-R262I	2" PJ Conn. - 12" Ring & Strainer	B	1	1	\$1,575.00
860-R263I	3" PJ Conn. - 12" Ring & Strainer	B	1	1	\$1,575.00
860-R264I	4" PJ Conn. - 12" Ring & Strainer	B	1	1	\$1,575.00
860-R266I	6" PJ Conn. - 12" Ring & Strainer	B	1	1	\$1,575.00
<b>ROUND CAST IRON STRAINER - NICKEL-BRONZE VENEER</b>					
860-R262IN	2" PJ Conn. - 12" Ring & Strainer	B	1	1	\$2,200.00
860-R263IN	3" PJ Conn. - 12" Ring & Strainer	B	1	1	\$2,200.00
860-R264IN	4" PJ Conn. - 12" Ring & Strainer	B	1	1	\$2,200.00
860-R266IN	6" PJ Conn. - 12" Ring & Strainer	B	1	1	\$2,200.00
<b>SQUARE CAST IRON STRAINER</b>					
860-Q262I	2" PJ Conn. - 12" Ring & Strainer	B	1	1	\$1,860.00
860-Q263I	3" PJ Conn. - 12" Ring & Strainer	B	1	1	\$1,860.00
860-Q264I	6" PJ Conn. - 12" Ring & Strainer	B	1	1	\$1,860.00
860-Q266I	6" PJ Conn. - 12" Ring & Strainer	B	1	1	\$1,860.00
<b>SQUARE CAST IRON STRAINER - NICKEL-BRONZE VENEER</b>					
860-Q262IN	2" PJ Conn. - 12" Ring & Strainer	B	1	1	\$2,800.00
860-Q263IN	3" PJ Conn. - 12" Ring & Strainer	B	1	1	\$2,800.00
860-Q264IN	4" PJ Conn. - 12" Ring & Strainer	B	1	1	\$2,800.00
860-Q266IN	6" PJ Conn. - 12" Ring & Strainer	B	1	1	\$2,800.00

**Stainless Steel**

**No-Hub Connection**

Item Number	Item Description	Pkg Type	Min Qty	Case Qty	Price
<b>DRAINS</b>					
860-3SS	3" No-Hub - 6-3/4" Rnd Grate	BI	1	1	\$3,660.00
860-4SS	4" No-Hub - 8-7/8" Rnd Grate	BI	1	1	\$4,280.00
<b>ACCESSORIES</b>					
860-3SSS	6-3/4" Rnd Grate	B	1	1	\$929.00
860-4SSS	8-7/8" Rnd Grate	BI	1	1	\$1,299.00
860-4SSU	Debris Bucket For 860-4SS	BI	1	1	\$287.00



860-3SS

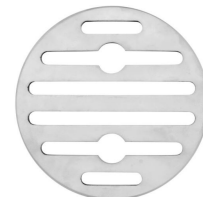

860-3SSS

Supply

Drainage

Support

Specialties

Appendix



862-45LNR

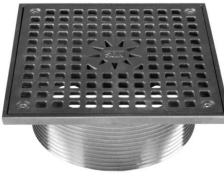

862-45LNQ



862-47LNRE

## Adjustable Floor Drain Head

### Nickel-Bronze - MIP Thread Connection

**Options:** Add suffix to item no. Add price to list  
**B** = Sediment Bucket: \$105.00;

Item Number	Item Description	Pkg Type	Min Qty	Case Qty	Price
<b>ROUND STRAINER</b>					
862-410LNR	4" MIP - 10" Nikl-Brnz Ring & Strainer	BI	1	8	\$1,200.00
862-45LNR	4" MIP - 5" Nikl-Brnz Ring & Strainer	BI	1	20	\$350.00
862-46LNR	4" MIP - 6" Nikl-Brnz Ring & Strainer	BI	1	20	\$450.00
862-47LNR	4" MIP - 7" Nikl-Brnz Ring & Strainer	BI	1	12	\$600.00
862-48LNR	4" MIP - 8" Nikl-Brnz Ring & Strainer	BI	1	8	\$850.00
<b>SQUARE STRAINER</b>					
862-410LNQ	4" MIP - 10" Nikl-Brnz Ring & Strainer	BI	1	4	\$1,600.00
862-45LNQ	4" MIP - 5" Nikl-Brnz Ring & Strainer	BI	1	20	\$500.00
862-46LNQ	4" MIP - 6" Nikl-Brnz Ring & Strainer	BI	1	16	\$600.00
862-47LNQ	4" MIP - 7" Nikl-Brnz Ring & Strainer	BI	1	12	\$800.00
862-48LNQ	4" MIP - 8" Nikl-Brnz Ring & Strainer	BI	1	8	\$1,000.00
<b>ACCESSORIES</b>					
862-EX4	4" Threaded Extension Adapter - MIP X FIP	B	1	1	\$120.00

## Adjustable Floor Drain Head

### Nickel-Bronze Extended Rim - MIP Thread Connection

**Options:** Add suffix to item no. Add price to list  
**B** = Sediment Bucket: \$105.00;

Item Number	Item Description	Pkg Type	Min Qty	Case Qty	Price
<b>ROUND EXTENDED RIM</b>					
862-410LNRE	4" MIP - 10" Nikl-Brnz Ring & Strainer w/ Extended Rim	BI	1	8	\$2,000.00
862-47LNRE	4" MIP - 7" Nikl-Brnz Ring & Strainer w/ Extended Rim	BI	1	8	\$1,200.00
<b>ACCESSORIES</b>					
862-EX4	4" Threaded Extension Adapter - MIP X FIP	B	1	1	\$120.00

## Adjustable Floor Drain Head

### Stainless Steel - MIP Thread Connection

**Options:** Add suffix to item no. Add price to list  
**B** = Sediment Bucket: \$105.00;

Item Number	Item Description	Pkg Type	Min Qty	Case Qty	Price
<b>ROUND STRAINER</b>					
862-45LSR	4" MIP - 5" Stnls Steel Ring & Strainer	BI	1	24	\$900.00
862-46LSR	4" MIP - 6" Stnls Steel Ring & Strainer	BI	1	20	\$1,100.00
<b>SQUARE STRAINER</b>					
862-45LSQ	4" MIP - 5" Stnls Steel Ring & Strainer	BI	1	20	\$1,000.00
862-46LSQ	4" MIP - 6" Stnls Steel Ring & Strainer	BI	1	16	\$1,200.00
<b>ACCESSORIES</b>					
862-EX4	4" Threaded Extension Adapter - MIP X FIP	B	1	1	\$120.00



862-45LSR

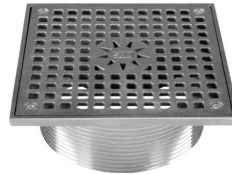

862-45LSQ

## Adjustable Floor Drain Head

### Cast Iron - MIP Thread Connection

**Options:** Add suffix to item no. Add price to list  
**B** = Sediment Bucket: \$105.00;

Item Number	Item Description	Pkg Type	Min Qty	Case Qty	Price
<b>CAST IRON RING &amp; STRAINER</b>					
862-47LI	4" MIP - 7" Ductile Iron Ring & Strainer	BI	1	1	\$455.00
862-49LI	4" MIP - 9" Ductile Iron Ring & Strainer	BI	1	1	\$787.00
<b>CAST IRON RING &amp; STRAINER - NICKEL-BRONZE VENEER</b>					
862-47LIN	4" MIP - 7" Ductile Iron Ring & Strainer w/ NB Veneer	BI	1	4	\$875.00
862-49LIN	4" MIP - 9" Ductile Iron Ring & Strainer w/ NB Veneer	BI	1	1	\$1,175.00
<b>ACCESSORIES</b>					
862-EX4	4" Threaded Extension Adapter - MIP X FIP	B	1	1	\$120.00



862-47LIN

## TrapShield™

### Trap Protection Device

Item Number	Item Description	Pkg Type	Min Qty	Case Qty	Price
835-2CQ	Trapshield™ For 2" Drain Outlet	BI	1	50	\$199.00
835-35CQ	Trapshield™ For 3-1/2" Drain Outlet	BI	1	25	\$224.00
835-3CQ	Trapshield™ For 3" Drain Outlet	BI	1	25	\$224.00
835-4CQ	Trapshield™ For 4" Drain Outlet	BI	1	20	\$265.00

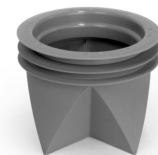

835-3CQ

Supply

Drainage

Support

Specialties

Appendix



836-2

## DeckAnchor™ Fixture Mounting Fitting

### Cast Iron - No-Hub Connection

Item Number	Item Description	Pkg Type	Min Qty	Case Qty	Price
836-2	DeckAnchor™ 2" No-Hub	BI	1	1	\$375.00
836-3	DeckAnchor™ 3" No-Hub	BI	1	1	\$404.00
836-4	DeckAnchor™ 4" No-Hub	BI	1	1	\$431.00
836-6	DeckAnchor™ 6" No-Hub	BI	1	1	\$462.00



862-B23

## Floor Drain Adapters

### Flashing Drain Adapters - 4" FIP Thread

Item Number	Item Description	Pkg Type	Min Qty	Case Qty	Price
<b>CAST IRON - NO-HUB CONNECTION</b>					
862-B22	4" FIP x 2" No-Hub	B	1	1	\$225.00
862-B23	4" FIP x 3" No-Hub	B	1	1	\$270.00
862-B24	4" FIP x 4" No-Hub	B	1	1	\$315.00
<b>CAST IRON - PUSH-JOINT CONNECTION</b>					
862-B62	4" FIP x 2" PJ Conn.	B	1	1	\$270.00
862-B63	4" FIP x 3" PJ Conn.	B	1	1	\$315.00
862-B64	4" FIP x 4" PJ Conn.	B	1	1	\$360.00



862-B63

## Floor Drain Adapters

### No-Hub Adapters

Item Number	Item Description	Pkg Type	Min Qty	Case Qty	Price
<b>CAST IRON - FIP X NO-HUB ADAPTER</b>					
842-221	2" Cast Iron No-Hub w/ 2" FIP Thread	BI	1	2	\$57.00
842-241	4" Cast Iron No-Hub w/ 4" FIP Thread	BI	1	2	\$57.00



842-221

## Floor Drain Adapters

### Push-Joint Adapters

**Options:** Add suffix to item no. Add price to list  
 P = Push-joint gasket to fit Sc. 40 ABS/PVC pipe: \$7.50;

Item Number	Item Description	Pkg Type	Min Qty	Case Qty	Price
<b>CAST IRON - FIP X PUSH-JOINT ADAPTER</b>					
858-63L	3" PJ Conn. w/ 3" FIP Thread	BI	1	4	\$45.12
858-64L	4" PJ Conn. w/ 4" FIP Thread	BI	1	4	\$150.00



858-64L

**Condensate Funnels**

Item Number	Item Description	Pkg Type	Min Qty	Case Qty	Price
<b>ROUND 4"</b>					
863-FACQ	Round Aluminum Condensate Funnel w/ Screws	BI	1	12	\$168.00
863-FNCQ	Round Nikl-Brnz Condensate Funnel w/ Screws	BI	1	12	\$370.00
<b>OVAL 4" X 9"</b>					
863-FNOCQ	Oval Nikl-Brnz Condensate Funnel w/ Screws	BI	1	12	\$815.00



863-FACQ

Supply

Drainage

Support

Specialties

Appendix



# Specification Floor Sinks

**Cast Iron Square Floor Sinks**

**Cast Iron Round Floor Sinks**

**FatMax™ Stainless Steel  
Floor Sinks**



Cast iron floor sinks are enamel coated for resistance to abrasion, acids and corrosion.



**861-Q2226**  
Page 264



**861-QF2226**  
Page 264



**861-Q2328**  
Page 265



**861-QF2328**  
Page 265



**861-Q2221**  
Page 266



**861-QF2221**  
Page 266



**861-Q2286**  
Page 268



**861-QF2286**  
Page 268



**861-R2286**  
Page 269



**861-RF2286**  
Page 269



**861-R2228**  
Page 271



**861-RF2228**  
Page 271



**860-4SS**  
Page 272

 <b>861-Q2226</b> Page 264	 <b>861-QF2226</b> Page 264	 <b>861-Q2328</b> Page 265	 <b>861-QF2328</b> Page 265	 <b>861-Q2221</b> Page 266
 <b>861-QF2221</b> Page 266	 <b>861-Q2286</b> Page 268	 <b>861-QF2286</b> Page 268	 <b>861-R2286</b> Page 269	 <b>861-RF2286</b> Page 269
 <b>861-R2228</b> Page 271	 <b>861-RF2228</b> Page 271	 <b>860-4SS</b> Page 272		

**12" x 12" x 6" - Alpha Series**

**Cast Iron - No-Hub Connection**

**Options:** Add suffix to item no. Add price to list

**I** = Full ARE Cast Iron Grate: \$189.00; **I2** = Open-Half ARE Cast Iron Grate: \$189.00;

**I3** = Open-Quarter ARE Cast Iron Grate: \$189.00; **N** = Full Nickel-Bronze Grate: \$2,017.00;

**N2** = Open-Half Nickel-Bronze Grate: \$2,017.00; **N3** = Open-Quarter Nickel-Bronze Grate: \$2,017.00;

**W** = Stainless Steel Debris Basket: \$202.00; **D** = Aluminum Dome Bottom Strainer: \$70.00;

**C** = Clamping Collar with Bolts (1): \$202.00;

1: For use with flanged floor sink.

Item Number	Item Description	Pkg Type	Min Qty	Case Qty	Price
<b>FLOOR SINKS</b>					
861-22X	2" No-Hub	BI	1	1	\$928.00
861-22XF	2" No-Hub, w/ Flange	BI	1	1	\$1,378.00
861-23X	3" No-Hub	BI	1	1	\$928.00
861-23XF	3" No-Hub, w/ Flange	BI	1	1	\$1,378.00
861-24X	4" No-Hub	BI	1	1	\$928.00
861-24XF	4" No-Hub, w/ Flange	BI	1	1	\$1,378.00
<b>ACCESSORIES</b>					
861-52I	A.R.E. Cast Iron Open-Half Grate	BI	1	10	\$189.00
861-52IN	Nikl-Brnz Open-Half Grate	BI	1	1	\$2,017.00
861-53I	A.R.E. Cast Iron Open-Quarter Grate	BI	1	10	\$189.00
861-53IN	Nikl-Brnz Open-Quarter Strainer	BI	1	1	\$2,017.00
861-5I	A.R.E. Cast Iron Full Grate	BI	1	1	\$189.00
861-5IN	Nikl-Brnz Full Grate	BI	1	2	\$2,017.00
861-AC	Aluminum Clamping Collar w/ Bolts, For Flanged Model	B	1	1	\$202.00
861-AD	Aluminum Dome Bottom Strainer	BI	1	20	\$70.00
861-UMI	Stnls Steel Debris Basket	BI	1	5	\$202.00
<b>863-FACQ</b>	Round Aluminum Condensate Funnel w/ Screws	BI	1	12	\$168.00
<b>863-FNCQ</b>	Round Nikl-Brnz Condensate Funnel w/ Screws	BI	1	12	\$370.00
<b>863-FNOCQ</b>	Oval Nikl-Brnz Condensate Funnel w/ Screws	BI	1	12	\$815.00



861-22X



861-23XF

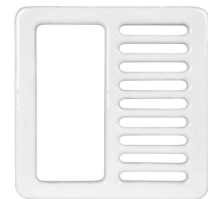

861-52I



861-AD

Supply

Drainage

Support

Specialties

Appendix



861-Q2226



861-QF2226

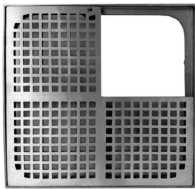

861-GNQ2T



861-TA22

## 12" x 12" x 6" - Bravo Series

### Cast Iron - No-Hub Connection

Options: Add suffix to item no. Add price to list

2 = Open-Half Grate (1): N/C; 3 = Open-Quarter Grate (1): N/C;

B = Aluminum Bucket: \$348.00; C = Clamping Collar (2): \$300.00;

T = 1/2" Trap Primer Connection: \$213.00;

1: For sinks with grates only 2: For sinks with anchor flange

Item Number	Item Description	Pkg Type	Min Qty	Case Qty	Price
<b>FLOOR SINKS WITH AL DOME BOTTOM STRAINER</b>					
861-Q2226	2" No-Hub - No Grate	B	1	1	\$2,350.00
861-Q2226A	2" No-Hub - ARE Grate	B	1	1	\$2,568.00
<b>861-Q2226N</b>	2" No-Hub - Nikl-Brnz Grate	B	1	1	\$3,055.00
861-Q2326	3" No-Hub - No Grate	B	1	1	\$2,350.00
861-Q2326A	3" No-Hub - ARE Grate	B	1	1	\$2,568.00
<b>861-Q2326N</b>	3" No-Hub - Nikl-Brnz Grate	B	1	1	\$3,055.00
861-Q2426	4" No-Hub - No Grate	B	1	1	\$2,350.00
861-Q2426A	4" No-Hub - ARE Grate	B	1	1	\$2,568.00
<b>861-Q2426N</b>	4" No-Hub - Nikl-Brnz Grate	B	1	1	\$3,055.00
861-QF2226	2" No-Hub - No Grate, w/ Flange	B	1	1	\$2,835.00
<b>861-QF2226A</b>	2" No-Hub - ARE Grate, w/ Flange	B	1	1	\$3,053.00
<b>861-QF2226N</b>	2" No-Hub - Nikl-Brnz Grate, w/ Flange	B	1	1	\$3,540.00
861-QF2326	3" No-Hub - No Grate, w/ Flange	B	1	1	\$2,835.00
<b>861-QF2326A</b>	3" No-Hub - ARE Grate, w/ Flange	B	1	1	\$3,053.00
<b>861-QF2326N</b>	3" No-Hub - Nikl-Brnz Grate, w/ Flange	B	1	1	\$3,540.00
861-QF2426	4" No-Hub - No Grate, w/ Flange	B	1	1	\$2,835.00
<b>861-QF2426A</b>	4" No-Hub - ARE Grate, w/ Flange	B	1	1	\$3,053.00
<b>861-QF2426N</b>	4" No-Hub - Nikl-Brnz Grate, w/ Flange	B	1	1	\$3,540.00
<b>ACCESSORIES</b>					
<b>861-BQ2</b>	Aluminum Bucket	B	1	1	\$348.00
<b>861-CQ2</b>	Clamping Collar	B	1	1	\$300.00
861-GAQ2F	A.R.E. Full Grate	B	1	6	\$218.00
861-GAQ2H	A.R.E. Open-Half Grate	B	1	6	\$218.00
861-GAQ2T	A.R.E. Open-Quarter Grate	B	1	6	\$218.00
861-GNQ2F	Nickl-Brnz Full Grate	B	1	1	\$1,440.00
861-GNQ2H	Nickl-Brnz Open-Half Grate	B	1	1	\$1,440.00
861-GNQ2T	Nickl-Brnz Open-Quarter Grate	B	1	1	\$1,440.00
<b>863-FACQ</b>	Round Aluminum Condensate Funnel w/ Screws	BI	1	12	\$168.00
<b>863-FNCQ</b>	Round Nikl-Brnz Condensate Funnel w/ Screws	BI	1	12	\$370.00
<b>863-FNOCQ</b>	Oval Nikl-Brnz Condensate Funnel w/ Screws	BI	1	12	\$815.00
<b>TRAP PRIMER ADAPTER</b>					
<b>861-TA22</b>	2" No-Hub - 1/2" FIP	B	1	1	\$213.00
<b>861-TA23</b>	3" No-Hub - 1/2" FIP	B	1	1	\$213.00
<b>861-TA24</b>	4" No-Hub - 1/2" FIP	B	1	1	\$213.00

**12" x 12" x 8"**

**Cast Iron - No-Hub Connection**

**Options:** Add suffix to item no. Add price to list

**2** = Open-Half Grate (1): N/C; **3** = Open-Quarter Grate (1): N/C;  
**B** = Aluminum Bucket: \$348.00; **C** = Clamping Collar (2): \$300.00;  
**T** = 1/2" Trap Primer Connection: \$213.00;

1: For sinks with grates only 2: For sinks with anchor flange

Item Number	Item Description	Pkg Type	Min Qty	Case Qty	Price
<b>FLOOR SINKS WITH AL DOME BOTTOM STRAINER</b>					
861-Q2228	2" No-Hub - No Grate	B	1	1	\$2,450.00
<b>861-Q2228A</b>	2" No-Hub - ARE Grate	B	1	1	\$2,668.00
<b>861-Q2228N</b>	2" No-Hub - Nikl-Brnz Grate	B	1	1	\$3,155.00
861-Q2328	3" No-Hub - No Grate	B	1	1	\$2,450.00
<b>861-Q2328A</b>	3" No-Hub - ARE Grate	B	1	1	\$2,668.00
<b>861-Q2328N</b>	3" No-Hub - Nikl-Brnz Grate	B	1	1	\$3,155.00
<b>861-Q2428</b>	4" No-Hub - No Grate	B	1	1	\$2,450.00
<b>861-Q2428A</b>	4" No-Hub - ARE Grate	B	1	1	\$2,668.00
<b>861-Q2428N</b>	4" No-Hub - Nikl-Brnz Grate	B	1	1	\$3,155.00
861-QF2228	2" No-Hub - No Grate, w/ Flange	B	1	1	\$2,935.00
<b>861-QF2228A</b>	2" No-Hub - ARE Grate, w/ Flange	B	1	1	\$3,153.00
<b>861-QF2228N</b>	2" No-Hub - Nikl-Brnz Grate, w/ Flange	B	1	1	\$3,640.00
861-QF2328	3" No-Hub - No Grate, w/ Flange	B	1	1	\$2,935.00
<b>861-QF2328A</b>	3" No-Hub - ARE Grate, w/ Flange	B	1	1	\$3,153.00
<b>861-QF2328N</b>	3" No-Hub - Nikl-Brnz Grate, w/ Flange	B	1	1	\$3,640.00
861-QF2428	4" No-Hub - No Grate, w/ Flange	B	1	1	\$2,935.00
<b>861-QF2428A</b>	4" No-Hub - ARE Grate, w/ Flange	B	1	1	\$3,153.00
<b>861-QF2428N</b>	4" No-Hub - Nikl-Brnz Grate, w/ Flange	B	1	1	\$3,640.00
<b>ACCESSORIES</b>					
<b>861-BQ2</b>	Aluminum Bucket	B	1	1	\$348.00
<b>861-CQ2</b>	Clamping Collar	B	1	1	\$300.00
861-GAQ2F	A.R.E. Full Grate	B	1	6	\$218.00
861-GAQ2H	A.R.E. Open-Half Grate	B	1	6	\$218.00
861-GAQ2T	A.R.E. Open-Quarter Grate	B	1	6	\$218.00
861-GNQ2F	Nickl-Brnz Full Grate	B	1	1	\$1,440.00
861-GNQ2H	Nickl-Brnz Open-Half Grate	B	1	1	\$1,440.00
861-GNQ2T	Nickl-Brnz Open-Quarter Grate	B	1	1	\$1,440.00
<b>863-FACQ</b>	Round Aluminum Condensate Funnel w/ Screws	Bl	1	12	\$168.00
<b>863-FNCQ</b>	Round Nikl-Brnz Condensate Funnel w/ Screws	Bl	1	12	\$370.00
<b>863-FNOCQ</b>	Oval Nikl-Brnz Condensate Funnel w/ Screws	Bl	1	12	\$815.00
<b>TRAP PRIMER ADAPTER</b>					
<b>861-TA22</b>	2" No-Hub - 1/2" FIP	B	1	1	\$213.00
<b>861-TA23</b>	3" No-Hub - 1/2" FIP	B	1	1	\$213.00
<b>861-TA24</b>	4" No-Hub - 1/2" FIP	B	1	1	\$213.00



861-Q2328



861-QF2228



861-GNQ2H



861-TA23

Supply

Drainage

Support

Specialties

Appendix



861-Q2221



861-QF2221

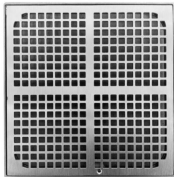

861-GNQ2F



861-TA24

**12" x 12" x 10"**

**Cast Iron - No-Hub Connection**

**Options:** Add suffix to item no. Add price to list  
**2** = Open-Half Grate (1): N/C; **3** = Open-Quarter Grate (1): N/C;  
**B** = Aluminum Bucket: \$348.00; **C** = Clamping Collar (2): \$300.00;  
**T** = 1/2" Trap Primer Connection: \$213.00;

1: For sinks with grates only 2: For sinks with anchor flange

Item Number	Item Description	Pkg Type	Min Qty	Case Qty	Price
<b>FLOOR SINKS WITH AL DOME BOTTOM STRAINER</b>					
861-Q2221	2" No-Hub - No Grate	B	1	1	\$2,650.00
<b>861-Q2221A</b>	2" No-Hub - ARE Grate	B	1	1	\$2,868.00
<b>861-Q2221N</b>	2" No-Hub - Nikl-Brnz Grate	B	1	1	\$3,355.00
861-Q2321	3" No-Hub - No Grate	B	1	1	\$2,650.00
<b>861-Q2321A</b>	3" No-Hub - ARE Grate	B	1	1	\$2,868.00
<b>861-Q2321N</b>	3" No-Hub - Nikl-Brnz Grate	B	1	1	\$3,355.00
861-Q2421	4" No-Hub - No Grate	B	1	1	\$2,650.00
<b>861-Q2421A</b>	4" No-Hub - ARE Grate	B	1	1	\$2,868.00
<b>861-Q2421N</b>	4" No-Hub - Nikl-Brnz Grate	B	1	1	\$3,355.00
861-QF2221	2" No-Hub - No Grate, w/ Flange	B	1	1	\$3,100.00
<b>861-QF2221A</b>	2" No-Hub - ARE Grate, w/ Flange	B	1	1	\$3,318.00
<b>861-QF2221N</b>	2" No-Hub - Nikl-Brnz Grate, w/ Flange	B	1	1	\$3,805.00
861-QF2321	3" No-Hub - No Grate, w/ Flange	B	1	1	\$3,100.00
<b>861-QF2321A</b>	3" No-Hub - ARE Grate, w/ Flange	B	1	1	\$3,318.00
<b>861-QF2321N</b>	3" No-Hub - Nikl-Brnz Grate, w/ Flange	B	1	1	\$3,805.00
861-QF2421	4" No-Hub - No Grate, w/ Flange	B	1	1	\$3,100.00
<b>861-QF2421A</b>	4" No-Hub - ARE Grate, w/ Flange	B	1	1	\$3,318.00
<b>861-QF2421N</b>	4" No-Hub - Nikl-Brnz Grate, w/ Flange	B	1	1	\$3,805.00
<b>ACCESSORIES</b>					
<b>861-BQ2</b>	Aluminum Bucket	B	1	1	\$348.00
<b>861-CQ2</b>	Clamping Collar	B	1	1	\$300.00
861-GAQ2F	A.R.E. Full Grate	B	1	6	\$218.00
861-GAQ2H	A.R.E. Open-Half Grate	B	1	6	\$218.00
861-GAQ2T	A.R.E. Open-Quarter Grate	B	1	6	\$218.00
861-GNQ2F	Nickl-Brnz Full Grate	B	1	1	\$1,440.00
861-GNQ2H	Nickl-Brnz Open-Half Grate	B	1	1	\$1,440.00
861-GNQ2T	Nickl-Brnz Open-Quarter Grate	B	1	1	\$1,440.00
<b>863-FACQ</b>	Round Aluminum Condensate Funnel w/ Screws	BI	1	12	\$168.00
<b>863-FNCQ</b>	Round Nikl-Brnz Condensate Funnel w/ Screws	BI	1	12	\$370.00
<b>863-FNOCQ</b>	Oval Nikl-Brnz Condensate Funnel w/ Screws	BI	1	12	\$815.00
<b>TRAP PRIMER ADAPTER</b>					
<b>861-TA22</b>	2" No-Hub - 1/2" FIP	B	1	1	\$213.00
<b>861-TA23</b>	3" No-Hub - 1/2" FIP	B	1	1	\$213.00
<b>861-TA24</b>	4" No-Hub - 1/2" FIP	B	1	1	\$213.00

**8" x 8" x 6" - Alpha Series**

**Cast Iron - No-Hub Connection**

**Options:** Add suffix to item no. Add price to list

**I** = Full ARE Cast Iron Grate: \$141.00; **I2** = Open-Half ARE Cast Iron Grate: \$141.00;

**I3** = Open-Quarter ARE Cast Iron Grate: \$141.00; **N** = Full Nickel-Bronze Grate: \$885.00;

**N2** = Open-Half Nickel-Bronze Grate: \$885.00; **N3** = Open-Quarter Nickel-Bronze Grate: \$885.00;

**D** = Aluminum Dome Bottom Strainer: \$70.00;



861-282X



861-58I

Item Number	Item Description	Pkg Type	Min Qty	Case Qty	Price
<b>FLOOR SINKS</b>					
861-282X	2" No-Hub	BI	1	1	\$605.00
861-283X	3" No-Hub	BI	1	1	\$605.00
861-284X	4" No-Hub	BI	1	1	\$605.00
<b>ACCESSORIES</b>					
861-582I	A.R.E. Cast Iron Open-Half Grate	BI	1	1	\$141.00
861-582IN	Nikl-Brnz Open-Half Grate	BI	1	1	\$885.00
861-583I	A.R.E. Cast Iron Open-Quarter Grate	BI	1	1	\$141.00
861-583IN	Nikl-Brnz Open-Quarter Grate	BI	1	1	\$885.00
861-58I	A.R.E. Cast Iron Full Grate	BI	1	1	\$141.00
<b>861-58IN</b>	Nikl-Brnz Full Grate	BI	1	1	\$885.00
861-AD	Aluminum Dome Bottom Strainer	BI	1	20	\$70.00
<b>863-FACQ</b>	Round Aluminum Condensate Funnel w/ Screws	BI	1	12	\$168.00
<b>863-FNCQ</b>	Round Nikl-Brnz Condensate Funnel w/ Screws	BI	1	12	\$370.00
<b>863-FNOCQ</b>	Oval Nikl-Brnz Condensate Funnel w/ Screws	BI	1	12	\$815.00

Supply

Drainage

Support

Specialties

Appendix



861-Q2286



861-QF2286



861-GAQ8H



861-TA22

## 8" x 8" x 6" - Bravo Series

### Cast Iron - No-Hub Connection

**Options:** Add suffix to item no. Add price to list

**2** = Open-Half Grate (1): N/C; **3** = Open-Quarter Grate (1): N/C;

**B** = Aluminum Bucket: \$250.00; **C** = Clamping Collar (2): \$202.00;

**T** = 1/2" Trap Primer Connection: \$213.00;

1: For sinks with grates only 2: For sinks with anchor flange

Item Number	Item Description	Pkg Type	Min Qty	Case Qty	Price
<b>FLOOR SINKS WITH AL DOME BOTTOM STRAINER</b>					
861-Q2286	2" No-Hub - No Grate	B	1	1	\$1,725.00
<b>861-Q2286A</b>	2" No-Hub - ARE Grate	B	1	1	\$1,943.00
<b>861-Q2286N</b>	2" No-Hub - Nikl-Brnz Grate	B	1	1	\$2,015.00
861-Q2386	3" No-Hub - No Grate	B	1	1	\$1,725.00
<b>861-Q2386A</b>	3" No-Hub - ARE Grate	B	1	1	\$1,943.00
<b>861-Q2386N</b>	3" No-Hub - Nikl-Brnz Grate	B	1	1	\$2,015.00
861-Q2486	4" No-Hub - No Grate	B	1	1	\$1,725.00
<b>861-Q2486A</b>	4" No-Hub - ARE Grate	B	1	1	\$1,943.00
<b>861-Q2486N</b>	4" No-Hub - Nikl-Brnz Grate	B	1	1	\$2,015.00
861-QF2286	2" No-Hub - No Grate, w/ Flange	B	1	1	\$1,960.00
<b>861-QF2286A</b>	2" No-Hub - ARE Grate, w/ Flange	B	1	1	\$2,178.00
<b>861-QF2286N</b>	2" No-Hub - Nikl-Brnz Grate, w/ Flange	B	1	1	\$2,250.00
861-QF2386	3" No-Hub - No Grate, w/ Flange	B	1	1	\$1,960.00
<b>861-QF2386A</b>	3" No-Hub - ARE Grate, w/ Flange	B	1	1	\$2,178.00
<b>861-QF2386N</b>	3" No-Hub - Nikl-Brnz Grate, w/ Flange	B	1	1	\$2,250.00
861-QF2486	4" No-Hub - No Grate, w/ Flange	B	1	1	\$1,960.00
<b>861-QF2486A</b>	4" No-Hub - ARE Grate, w/ Flange	B	1	1	\$2,178.00
<b>861-QF2486N</b>	4" No-Hub - Nikl-Brnz Grate, w/ Flange	B	1	1	\$2,250.00
<b>ACCESSORIES</b>					
<b>861-BQ8</b>	Aluminum Bucket	B	1	1	\$250.00
<b>861-CQ8</b>	Clamping Collar	B	1	1	\$202.00
861-GAQ8F	A.R.E. Full Grate	B	1	6	\$218.00
861-GAQ8H	A.R.E. Open-Half Grate	B	1	6	\$218.00
861-GAQ8T	A.R.E. Open-Quarter Grate	B	1	6	\$218.00
861-GNQ8F	Nickl-Brnz Full Grate	B	1	1	\$825.00
861-GNQ8H	Nickl-Brnz Open-Half Grate	B	1	1	\$825.00
861-GNQ8T	Nickl-Brnz Open-Quarter Grate	B	1	1	\$825.00
<b>863-FACQ</b>	Round Aluminum Condensate Funnel w/ Screws	BI	1	12	\$168.00
<b>863-FNCQ</b>	Round Nikl-Brnz Condensate Funnel w/ Screws	BI	1	12	\$370.00
<b>863-FNOCQ</b>	Oval Nikl-Brnz Condensate Funnel w/ Screws	BI	1	12	\$815.00
<b>TRAP PRIMER ADAPTER</b>					
<b>861-TA22</b>	2" No-Hub - 1/2" FIP	B	1	1	\$213.00
<b>861-TA23</b>	3" No-Hub - 1/2" FIP	B	1	1	\$213.00
<b>861-TA24</b>	4" No-Hub - 1/2" FIP	B	1	1	\$213.00

8" x 6"

Cast Iron - No-Hub Connection

Options: Add suffix to item no. Add price to list

2 = Open-Half Grate (1): N/C; 3 = Open-Quarter Grate (1): N/C;

B = Aluminum Bucket: \$250.00; C = Clamping Collar with Anchor Flange: \$202.00;

T = 1/2" Trap Primer Connection: \$213.00;

1: For sinks with grates only

Item Number	Item Description	Pkg Type	Min Qty	Case Qty	Price
<b>FLOOR SINKS WITH AL DOME BOTTOM STRAINER</b>					
861-R2286	2" No-Hub - No Grate	B	1	1	\$1,400.00
<b>861-R2286A</b>	2" No-Hub - ARE Grate	B	1	1	\$1,618.00
<b>861-R2286N</b>	2" No-Hub - Nikl-Brnz Grate	B	1	1	\$1,750.00
861-R2386	3" No-Hub - No Grate	B	1	1	\$1,400.00
<b>861-R2386A</b>	3" No-Hub - ARE Grate	B	1	1	\$1,618.00
<b>861-R2386N</b>	3" No-Hub - Nikl-Brnz Grate	B	1	1	\$1,750.00
861-R2486	4" No-Hub - No Grate	B	1	1	\$1,400.00
<b>861-R2486A</b>	4" No-Hub - ARE Grate	B	1	1	\$1,618.00
<b>861-R2486N</b>	4" No-Hub - Nikl-Brnz Grate	B	1	1	\$1,750.00
861-RF2286	2" No-Hub - No Grate, w/ Flange	B	1	1	\$1,700.00
<b>861-RF2286A</b>	2" No-Hub - ARE Grate, w/ Flange	B	1	1	\$1,918.00
<b>861-RF2286N</b>	2" No-Hub - Nikl-Brnz Grate, w/ Flange	B	1	1	\$2,050.00
861-RF2386	3" No-Hub - No Grate, w/ Flange	B	1	1	\$1,700.00
<b>861-RF2386A</b>	3" No-Hub - ARE Grate, w/ Flange	B	1	1	\$1,918.00
<b>861-RF2386N</b>	3" No-Hub - Nikl-Brnz Grate, w/ Flange	B	1	1	\$2,050.00
861-RF2486	4" No-Hub - No Grate, w/ Flange	B	1	1	\$1,700.00
<b>861-RF2486A</b>	4" No-Hub - ARE Grate, w/ Flange	B	1	1	\$1,918.00
<b>861-RF2486N</b>	4" No-Hub - Nikl-Brnz Grate, w/ Flange	B	1	1	\$2,050.00
<b>ACCESSORIES</b>					
<b>861-BR8</b>	Aluminum Bucket	B	1	1	\$250.00
<b>861-CR8</b>	Collar Clamp	B	1	1	\$202.00
861-GAR8F	A.R.E. Full Grate	B	1	6	\$218.00
861-GAR8H	A.R.E. Open-Half Grate	B	1	6	\$218.00
861-GAR8T	A.R.E. Open-Quarter Grate	B	1	6	\$218.00
861-GNR8F	Nickl-Brnz Full Grate	B	1	1	\$350.00
861-GNR8H	Nickl-Brnz Open-Half Grate	B	1	1	\$350.00
861-GNR8T	Nickl-Brnz Open-Quarter Grate	B	1	1	\$350.00
<b>863-FACQ</b>	Round Aluminum Condensate Funnel w/ Screws	Bl	1	12	\$168.00
<b>863-FNCQ</b>	Round Nikl-Brnz Condensate Funnel w/ Screws	Bl	1	12	\$370.00
<b>863-FNOCQ</b>	Oval Nikl-Brnz Condensate Funnel w/ Screws	Bl	1	12	\$815.00
<b>TRAP PRIMER ADAPTER</b>					
<b>861-TA22</b>	2" No-Hub - 1/2" FIP	B	1	1	\$213.00
<b>861-TA23</b>	3" No-Hub - 1/2" FIP	B	1	1	\$213.00
<b>861-TA24</b>	4" No-Hub - 1/2" FIP	B	1	1	\$213.00



861-R2286



861-RF2286



861-GAR8T



861-TA23

Supply

Drainage

Support

Specialties

Appendix



860-293X

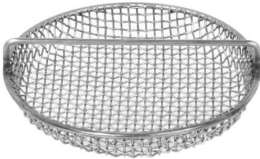

860-UMCQ

**9" x 6"**

**Cast Iron - No-Hub Connection**

**Options:** Add suffix to item no. Add price to list

**I** = Full ARE Cast Iron Grate: \$140.00; **I2** = Open-Half ARE Cast Iron Grate: \$140.00;

**I3** = Open-Quarter ARE Cast Iron Grate: \$140.00; **N** = Full Nickel-Bronze Grate: \$500.00;

**N2** = Open-Half Nickel-Bronze Grate: \$500.00; **S** = Full 304 Stainless Steel Grate: \$500.00;

**S2** = Open-Half 304 Stainless Steel Grate: \$500.00; **W** = Stainless Steel Debris Basket: \$180.00;

**D** = Aluminum Dome Bottom Strainer: \$70.00;

Item Number	Item Description	Pkg Type	Min Qty	Case Qty	Price
<b>FLOOR SINKS</b>					
860-292X	2" No-Hub	BI	1	1	\$563.00
860-293X	3" No-Hub	BI	1	1	\$563.00
860-294X	4" No-Hub	BI	1	1	\$563.00
<b>ACCESSORIES</b>					
860-592I	ARE Cast Iron Open-Half Grate	BI	1	10	\$138.00
860-593I	ARE Cast Iron Open-Quarter Grate	BI	1	10	\$138.00
860-59I	ARE Cast Iron Full Grate	BI	1	10	\$138.00
<b>860-RGN2CQ</b>	Nickl-Brnz Ring And Open-Half Strainer	BI	1	1	\$950.00
<b>860-RGNCQ</b>	Nickl-Brnz Ring And Full Strainer	BI	1	1	\$950.00
<b>860-RGS2CQ</b>	304 Stnls Steel Ring And Open-Half Strainer	BI	1	1	\$950.00
<b>860-RGSCQ</b>	304 Stnls Steel Ring And Full Strainer	BI	1	1	\$950.00
<b>860-UMCQ</b>	Stainless Steel Debris Basket	BI	1	1	\$83.00
861-AD	Aluminum Dome Bottom Strainer	BI	1	20	\$70.00
<b>863-FACQ</b>	Round Aluminum Condensate Funnel w/ Screws	BI	1	12	\$168.00
<b>863-FNCQ</b>	Round Nikl-Brnz Condensate Funnel w/ Screws	BI	1	12	\$370.00
<b>863-FNOCQ</b>	Oval Nikl-Brnz Condensate Funnel w/ Screws	BI	1	12	\$815.00

12" x 8"

Cast Iron - No-Hub Connection

Options: Add suffix to item no. Add price to list

2 = Open-Half Grate (1): N/C; 3 = Open-Quarter Grate (1): N/C;  
 B = Aluminum Bucket: \$348.00; C = Clamping Collar (2): \$250.00;  
 T = 1/2" Trap Primer Connection: \$213.00;

1: For sinks with grates only 2: For sinks with anchor flange

Item Number	Item Description	Pkg Type	Min Qty	Case Qty	Price
<b>FLOOR SINKS WITH AL DOME BOTTOM STRAINER</b>					
861-R2228	2" No-Hub - No Grate	B	1	1	\$1,600.00
<b>861-R2228A</b>	2" No-Hub - ARE Grate	B	1	1	\$1,818.00
<b>861-R2228N</b>	2" No-Hub - Nikl-Brnz Grate	B	1	1	\$2,085.00
861-R2328	3" No-Hub - No Grate	B	1	1	\$1,600.00
<b>861-R2328A</b>	3" No-Hub - ARE Grate	B	1	1	\$1,818.00
<b>861-R2328N</b>	3" No-Hub - Nikl-Brnz Grate	B	1	1	\$2,085.00
861-R2428	4" No-Hub - No Grate	B	1	1	\$1,600.00
<b>861-R2428A</b>	4" No-Hub - ARE Grate	B	1	1	\$1,818.00
<b>861-R2428N</b>	4" No-Hub - Nikl-Brnz Grate	B	1	1	\$2,085.00
861-RF2228	2" No-Hub - No Grate, w/ Flange	B	1	1	\$2,200.00
<b>861-RF2228A</b>	2" No-Hub - ARE Grate, w/ Flange	B	1	1	\$2,418.00
<b>861-RF2228N</b>	2" No-Hub - Nikl-Brnz Grate, w/ Flange	B	1	1	\$2,685.00
861-RF2328	3" No-Hub - No Grate, w/ Flange	B	1	1	\$2,200.00
<b>861-RF2328A</b>	3" No-Hub - ARE Grate, w/ Flange	B	1	1	\$2,418.00
<b>861-RF2328N</b>	3" No-Hub - Nikl-Brnz Grate, w/ Flange	B	1	1	\$2,685.00
861-RF2428	4" No-Hub - No Grate, w/ Flange	B	1	1	\$2,200.00
<b>861-RF2428A</b>	4" No-Hub - ARE Grate, w/ Flange	B	1	1	\$2,418.00
<b>861-RF2428N</b>	4" No-Hub - Nikl-Brnz Grate, w/ Flange	B	1	1	\$2,685.00
<b>ACCESSORIES</b>					
<b>861-BR2</b>	Aluminum Bucket	B	1	1	\$348.00
<b>861-CR2</b>	Collar Clamp	B	1	1	\$300.00
861-GAR2F	A.R.E. Full Grate	B	1	6	\$218.00
861-GAR2H	A.R.E. Open-Half Grate	B	1	6	\$218.00
861-GAR2T	A.R.E. Open-Quarter Grate	B	1	6	\$218.00
861-GNR2F	Nickl-Brnz Full Grate	B	1	1	\$1,440.00
861-GNR2H	Nickl-Brnz Open-Half Grate	B	1	1	\$1,440.00
861-GNR2T	Nickl-Brnz Open-Quarter Grate	B	1	1	\$1,440.00
<b>863-FACQ</b>	Round Aluminum Condensate Funnel w/ Screws	Bl	1	12	\$168.00
<b>863-FNCQ</b>	Round Nikl-Brnz Condensate Funnel w/ Screws	Bl	1	12	\$370.00
<b>863-FNOCQ</b>	Oval Nikl-Brnz Condensate Funnel w/ Screws	Bl	1	12	\$815.00
<b>TRAP PRIMER ADAPTER</b>					
<b>861-TA22</b>	2" No-Hub - 1/2" FIP	B	1	1	\$213.00
<b>861-TA23</b>	3" No-Hub - 1/2" FIP	B	1	1	\$213.00
<b>861-TA24</b>	4" No-Hub - 1/2" FIP	B	1	1	\$213.00



861-R2228



861-RF2228



Nickl-Brnz open-half grate



861-TA24

Supply

Drainage

Support

Specialties

Appendix

Supply

Drainage

Support

Specialties

Appendix



860-3SS



860-3SSS

## Stainless Steel Floor Sink

### No-Hub Connection

Item Number	Item Description	Pkg Type	Min Qty	Case Qty	Price
<b>FLOOR SINKS</b>					
860-3SS	3" No-Hub - 6-3/4" Rnd Grate	BI	1	1	\$3,660.00
860-4SS	4" No-Hub - 8-7/8" Rnd Grate	BI	1	1	\$4,280.00
<b>ACCESSORIES</b>					
860-3SSS	6-3/4" Rnd Grate	B	1	1	\$929.00
860-4SSS	8-7/8" Rnd Grate	BI	1	1	\$1,299.00
860-4SSU	Debris Bucket For 860-4SS	BI	1	1	\$287.00

# Specification Roof Drains

**Roof Drains**

**Promenade Drains**

**Scupper Drains**

**Accessories**





**868-1504**  
Page 275



**868-524B**  
Page 276



**868-F524**  
Page 276



**868-I4**  
Page 277



**868-123**  
Page 277



**868-824**  
Page 278



**868-2010**  
Page 278



**868-D1503**  
Page 280



**868-D824**  
Page 281



**868-R623I**  
Page 282



**868-S4A**  
Page 283



**868-N6F**  
Page 284



**868-N4S**  
Page 284



**868-V234**  
Page 284

## 15" Roof Drain - Alpha Series

### Cast Iron - No-Hub Connection

**Options:** Add suffix to item no. Add price to list

**H** = Undermount Hardware Kit: \$119.00; **U** = Underdeck Clamp Kit: \$229.00;  
**S** = Sump Receiver: \$274.00; **E** = Adjustable Extension Assembly Kit: \$830.00;  
**W** = 2" High External Water Dam: \$290.00; **P** = 2" High Internal Water Dam: \$290.00;  
**A** = Aluminum Dome Strainer (1): \$290.00; **V** = Vandal-Resistant Dome: \$150.00;

1: In lieu of cast iron dome (standard)



868-1504

Item Number	Item Description	Pkg Type	Min Qty	Case Qty	Price
<b>ROOF DRAINS</b>					
868-1503	3" No-Hub w/ Cast Iron Dome Strainer	Bl	1	1	\$815.00
868-1504	4" No-Hub w/ Cast Iron Dome Strainer	Bl	1	1	\$815.00
868-1506	6" No-Hub w/ Cast Iron Dome Strainer	Bl	1	1	\$815.00
868-1508	8" No-Hub w/ Cast Iron Dome Strainer	Bl	1	1	\$815.00
<b>ACCESSORIES</b>					
868-15AD	12-1/2" Aluminum Dome Strainer	Bl	1	1	\$290.00
868-15CD	12-1/2" Cast Iron Dome Strainer	Bl	1	1	\$205.00
868-15EXT	Adjustable Extension Assembly Kit	Bl	1	1	\$830.00
868-15S	Sump Receiver - 16ga Galvanized Steel	Bl	1	1	\$274.00
868-15SH	Undermount Hardware Kit: 4 Pieces Angle Bracket, Thread Rod, Nuts, Washers	Bl	1	10	\$119.00
868-15U	Underdeck Clamp Kit: 4 Pieces Thread Rod, Nuts, Washers, Two Clamping Bars	Bl	1	5	\$229.00
868-15WD	External Water Dam - 2" High	Bl	1	5	\$290.00

## 15" Roof Drain - Bravo Series

### Cast Iron - No-Hub Connection

**Options:** Add suffix to item no. Add price to list

**9** = 90-deg. Side Outlet Connection (1): \$486.00; **2** = 2" High SS Perforated Extension: \$734.00;  
**4** = 4" High SS Perforated Extension: \$734.00; **P** = Top Mount Sump Receiver: \$415.00;  
**S** = Sump Receiver: \$260.00; **C** = Underdeck Clamp: \$230.00;  
**E** = Adjustable Extension Assembly Kit: \$830.00; **G** = 2" High SS Gravel Guard: \$742.00;  
**H** = 4" High Internal Water Dam: \$400.00; **W** = 2" High External Water Dam: \$183.00;

1: Not available for 6" or 8" drains



868-522

Item Number	Item Description	Pkg Type	Min Qty	Case Qty	Price
<b>CAST IRON DOME</b>					
868-523	3" No-Hub w/ Cast Iron Dome Strainer	B	1	1	\$925.00
868-524	4" No-Hub w/ Cast Iron Dome Strainer	B	1	1	\$925.00
868-526	6" No-Hub w/ Cast Iron Dome Strainer	B	1	1	\$1,200.00
868-528	8" No-Hub w/ Cast Iron Dome Strainer	B	1	1	\$1,540.00



868-524B

### 15" Roof Drain - Bravo Series (Cont)

#### Cast Iron - No-Hub Connection

Item Number	Item Description	Pkg Type	Min Qty	Case Qty	Price
<b>POLY DOME</b>					
868-523B	3" No-Hub w/ Poly Dome Strainer	B	1	1	\$775.00
868-524B	4" No-Hub w/ Poly Dome Strainer	B	1	1	\$775.00
868-526B	6" No-Hub w/ Poly Dome Strainer	B	1	1	\$1,252.00
868-528B	8" No-Hub w/ Poly Dome Strainer	B	1	1	\$1,340.00
<b>ALUMINUM DOME</b>					
868-523A	3" No-Hub w/ Aluminum Dome Strainer	B	1	1	\$975.00
868-524A	4" No-Hub w/ Aluminum Dome Strainer	B	1	1	\$975.00
868-526A	6" No-Hub w/ Aluminum Dome Strainer	B	1	1	\$1,250.00
868-528A	8" No-Hub w/ Aluminum Dome Strainer	B	1	1	\$1,590.00

### 15" Adjustable Weir Roof Drain

#### Cast Iron - No-Hub Connection



868-F524

**Options:** Add suffix to item no. Add price to list

**9** = 90-deg. Side Outlet Connection (1): \$486.00; **2** = 2" High SS Perforated Extension: \$734.00;

**4** = 4" High SS Perforated Extension: \$734.00; **P** = Top Mount Sump Receiver: \$415.00;

**S** = Sump Receiver: \$260.00; **C** = Underdeck Clamp: \$230.00;

**E** = Adjustable Extension Assembly Kit: \$695.00; **G** = 2" High SS Gravel Guard: \$742.00;

1: Not available for 6" drains

Item Number	Item Description	Pkg Type	Min Qty	Case Qty	Price
<b>CAST IRON DOME</b>					
868-F523	3" No-Hub w/ Cast Iron Dome Strainer	B	1	1	\$1,875.00
868-F524	4" No-Hub w/ Cast Iron Dome Strainer	B	1	1	\$1,875.00
868-F526	6" No-Hub w/ Cast Iron Dome Strainer	B	1	1	\$2,145.00
<b>POLY DOME</b>					
868-F523B	3" No-Hub w/ Poly Dome Strainer	B	1	1	\$1,660.00
868-F524B	4" No-Hub w/ Poly Dome Strainer	B	1	1	\$1,660.00
868-F526B	6" No-Hub w/ Poly Dome Strainer	B	1	1	\$1,940.00
<b>ALUMINUM DOME</b>					
868-F523A	3" No-Hub w/ Aluminum Dome Strainer	B	1	1	\$2,112.00
868-F524A	4" No-Hub w/ Aluminum Dome Strainer	B	1	1	\$2,112.00
868-F526A	6" No-Hub w/ Aluminum Dome Strainer	B	1	1	\$2,382.00

## 11" Roof Drain

### Cast Iron - No-Hub Connection

**Options:** Add suffix to item no. Add price to list

**V** = Vandal-Resistant Dome: \$150.00; **W** = 2-3/16" High External Water Dam: \$210.00;

**P** = Steel Screen Installed Over Dome Strainer: \$140.00; **STP2** = 2" High Internal Water Dam: \$210.00;

**U** = Underdeck Clamp Kit: \$145.00; **S** = Sump Receiver: \$125.00;

**E** = Extension Collar Kit: \$140.00;



868-13

Item Number	Item Description	Pkg Type	Min Qty	Case Qty	Price
<b>ROOF DRAINS WITH POLY DOME STRAINER</b>					
868-13	3" No-Hub	Bl	1	2	\$915.00
868-14	4" No-Hub	Bl	1	2	\$915.00
868-16	6" No-Hub	Bl	1	2	\$995.00
<b>ROOF DRAINS WITH ALUMINUM DOME STRAINER</b>					
868-13M	3" No-Hub	Bl	1	1	\$1,207.00
868-14M	4" No-Hub	Bl	1	2	\$1,207.00
868-16M	6" No-Hub	Bl	1	1	\$1,310.00
<b>ACCESSORIES</b>					
868-CCQ	Under Deck Clamp Kit: 11" Epoxy-Coated Clamping Plate, Thread Rod, Nuts & Washers	Bl	1	5	\$305.00
868-ECQ	Extension Collar Kit: 13" Extension Collar, Thread Rod, Nuts & Washers	Bl	1	5	\$290.00
868-MCCQ	Epoxy-Coated Aluminum Replacement Gravel Guard	Bl	1	10	\$315.00
868-MDCQ	9-1/4" Diameter, Cast Aluminum	Bl	1	1	\$315.00
868-SCQ	Sump Receiver: 11-1/2" Sump Receiver Plate	Bl	1	10	\$230.00
868-WDCQ	Epoxy-Coated Aluminum External Water Dam, 2-3/16"	Bl	1	1	\$425.72

## 10" Roof Drain

### Cast Iron - No-Hub Connection

**Options:** Add suffix to item no. Add price to list

**P** = Top Mount Sump Receiver: \$380.00; **S** = Sump Receiver: \$245.00;

**C** = Underdeck Clamp Kit: \$145.00; **W** = 2" High Internal Water Dam: \$365.00;



868-123

Item Number	Item Description	Pkg Type	Min Qty	Case Qty	Price
<b>CAST IRON DOME</b>					
868-123	3" No Hub w/ Cast Iron Dome Strainer	B	1	1	\$983.00
868-124	4" No Hub w/ Cast Iron Dome Strainer	B	1	1	\$618.00



868-F123

## 10" Weir Roof Drain

### Cast Iron No-Hub Connection

**Options:** Add suffix to item no. Add price to list

**P** = Top Mount Sump Receiver: \$380.00; **S** = Sump Receiver: \$245.00;

**C** = Underdeck Clamp Kit: \$145.00;

Item Number	Item Description	Pkg Type	Min Qty	Case Qty	Price
<b>ADJUSTABLE WEIR</b>					
868-F123	3" No Hub w/ Cast Iron Dome Strainer	B	1	1	\$1,200.00
868-F124	4" No Hub w/ Cast Iron Dome Strainer	B	1	1	\$1,200.00
<b>FIXED WEIR</b>					
868-M123	3" No Hub w/ Cast Iron Dome Strainer	B	1	1	\$1,200.00
868-M124	4" No Hub w/ Cast Iron Dome Strainer	B	1	1	\$1,200.00



868-824

## 8" Roof Drain

### Cast Iron - No-Hub Connection

**Options:** Add suffix to item no. Add price to list

**9** = 90-deg. Side Outlet Connection (1): \$310.00; **S** = Sump Receiver: \$245.00;

**C** = Underdeck Clamp Kit: \$150.00; **W** = 2" High Internal Water Dam: \$185.00;

1: Not available for 6" drains

Item Number	Item Description	Pkg Type	Min Qty	Case Qty	Price
<b>ALUMINUM DOME</b>					
868-822	2" No-Hub w/ Aluminum Dome Strainer	B	1	1	\$750.00
868-823	3" No-Hub w/ Aluminum Dome Strainer	B	1	1	\$750.00
868-824	4" No-Hub w/ Aluminum Dome Strainer	B	1	1	\$750.00



868-2010

## 20" Large-Capacity Roof Drain

### Cast Iron - No-Hub Connection

**Options:** Add suffix to item no. Add price to list

**H** = Undermount Hardware Kit: \$404.00; **U** = Underdeck Clamp Kit: \$444.00;

**S** = Sump Receiver: \$726.00; **W** = 2" High External Water Dam: \$478.00;

Item Number	Item Description	Pkg Type	Min Qty	Case Qty	Price
<b>ROOF DRAINS</b>					
868-2010	10" No-Hub - Cast Iron Dome	BI	1	1	\$1,995.00
868-2012	12" No-Hub - Cast Iron Dome	BI	1	1	\$2,200.00

## 20" Large-Capacity Roof Drain (Cont)

### Cast Iron - No-Hub Connection

Item Number	Item Description	Pkg Type	Min Qty	Case Qty	Price
<b>ACCESSORIES</b>					
868-20CD	18-1/4" Diameter, Cast Iron	BI	1	1	\$540.00
868-20S	Sump Receiver	BI	1	1	\$800.00
868-20SH	Sump Receiver Hardware Kit	BI	1	1	\$450.00
868-20U	Underdeck Clamp Kit: 4 Pieces Thread Rod, Nuts, Washers, Two Clamping Bars	BI	1	1	\$460.00
868-20WD	External Water Dam - 2" High	BI	1	1	\$525.00

Supply

Drainage

Support

Specialties

Appendix



868-D1503

## 15" Roof Drain & Overflow - Alpha Series

### Cast Iron - No-Hub Connection

· 2" High external water dam (for overflow fixture) is standard

**Options:** Add suffix to item no. Add price to list

**A** = Aluminum Dome Strainer (1): \$474.00; **E** = Adjustable Extension Assembly Kit: \$1,660.00;

**H** = Undermount Hardware Kit: \$238.00; **P** = 2" High Internal Water Dam (2): N/C;

**U** = Underdeck Clamp Kit: \$458.00;

1: In lieu of cast iron dome (standard) 2: In lieu of external water dam (for overflow fixture)

Item Number	Item Description	Pkg Type	Min Qty	Case Qty	Price
<b>ROOF DRAIN &amp; OVERFLOW</b>					
868-D1503	3" No-Hub Cast Iron Roof Drain & Overflow	BI	1	1	\$2,460.00
868-D1504	4" No-Hub Cast Iron Roof Drain & Overflow	BI	1	1	\$2,460.00
868-D1506	6" No-Hub Cast Iron Roof Drain & Overflow	BI	1	1	\$2,460.00
868-D1508	8" No-Hub Cast Iron Roof Drain & Overflow	BI	1	1	\$2,460.00
<b>ACCESSORIES</b>					
<b>868-15AD</b>	12-1/2" Aluminum Dome Strainer	BI	1	1	\$290.00
868-15CD	12-1/2" Cast Iron Dome Strainer	BI	1	1	\$205.00
868-15EXT	Adjustable Extension Assembly Kit	BI	1	1	\$830.00
868-15S2	Double Sump Receiver Only - 12ga Powder-Coated Steel	BI	1	1	\$787.00
868-15SH	Undermount Hardware Kit: 4 Pieces Angle Bracket, Thread Rod, Nuts, Washers	BI	1	10	\$119.00
868-15U	Underdeck Clamp Kit: 4 Pieces Thread Rod, Nuts, Washers, Two Clamping Bars	BI	1	5	\$229.00

## 15" Roof Drain & Overflow - Bravo Series

### Cast Iron - No-Hub Connection

· 4" High internal water dam (for overflow fixture) is standard. Can be cut/shortened per specifications

**Options:** Add suffix to item no. Add price to list

**2** = 2" High SS Perforated Extension: \$1,468.00; **4** = 4" High SS Perforated Extension: \$1,468.00;

**W** = 2" External Water Dam (1): \$225.00; **E** = Adjustable Extension Assembly Kit: \$1,660.00;

**G** = 2" High SS Gravel Guard: \$1,484.00;

1: In lieu of internal water dam (for overflow fixture)

Item Number	Item Description	Pkg Type	Min Qty	Case Qty	Price
<b>CAST IRON DOME</b>					
<b>868-D523</b>	3" No-Hub w/ Cast Iron Dome Strainer	B	1	1	\$2,750.00
<b>868-D524</b>	4" No-Hub w/ Cast Iron Dome Strainer	B	1	1	\$2,750.00
<b>868-D526</b>	6" No-Hub w/ Cast Iron Dome Strainer	B	1	1	\$3,400.00
<b>868-D528</b>	8" No-Hub w/ Cast Iron Dome Strainer	B	1	1	\$3,895.00

## 15" Roof Drain & Overflow - Bravo Series (Cont)

### Cast Iron - No-Hub Connection



868-D524B

Item Number	Item Description	Pkg Type	Min Qty	Case Qty	Price
<b>POLY DOME</b>					
868-D523B	3" No-Hub w/ Poly Dome Strainer	B	1	1	\$2,357.00
868-D524B	4" No-Hub w/ Poly Dome Strainer	B	1	1	\$2,357.00
868-D526B	6" No-Hub w/ Poly Dome Strainer	B	1	1	\$2,930.00
868-D528B	8" No-Hub w/ Poly Dome Strainer	B	1	1	\$3,500.00
<b>ALUMINUM DOME</b>					
868-D523A	3" No-Hub w/ Aluminum Dome Strainer	B	1	1	\$3,224.00
868-D524A	4" No-Hub w/ Aluminum Dome Strainer	B	1	1	\$3,224.00
868-D526A	6" No-Hub w/ Aluminum Dome Strainer	B	1	1	\$3,874.00
868-D528A	8" No-Hub w/ Aluminum Dome Strainer	B	1	1	\$4,369.00

## 8" Roof Drain & Overflow

### Cast Iron - No-Hub Connection



868-D824

· 4" High internal water dam (for overflow fixture). Can be cut/shortened per specifications

**Options:** Add suffix to item no. Add price to list

**9** = 90-deg. Side Outlet Connection (1): \$620.00; **C** = Underdeck Clamp: \$290.00;

1: Not available for 6" drains

Item Number	Item Description	Pkg Type	Min Qty	Case Qty	Price
868-D822	2" No-Hub w/ Aluminum Dome Strainer	B	1	1	\$1,745.00
868-D823	3" No-Hub w/ Aluminum Dome Strainer	B	1	1	\$1,745.00
868-D824	4" No-Hub w/ Aluminum Dome Strainer	B	1	1	\$1,745.00

Supply

Drainage

Support

Specialties

Appendix



868-R623I



868-R623IN



868-Q624IN

## Promenade Drain

### Cast Iron - No-Hub Connection

**Options:** Add suffix to item no. Add price to list

**2** = 2" High SS Perforated Extension: \$800.00; **4** = 4" High SS Perforated Extension: \$800.00;

**9** = 90-deg. Side Outlet Connection (1): \$500.00; **B** = Sediment Bucket (2): \$250.00;

**C** = Underdeck Clamp: \$250.00; **E** = Adjustable Extension Assembly Kit: \$830.00;

**P** = Top Mount Sump Receiver: \$450.00; **S** = Sump Receiver: \$260.00;

**X** = Extra Heavy-Duty Grate: \$250.00;

1: Not available for 6" drains 2: Not available for drains with Adjustable Extension

Item Number	Item Description	Pkg Type	Min Qty	Case Qty	Price
<b>ROUND DUCTILE STRAINER</b>					
868-R623I	3" No-Hub - 16" Ductile Iron Ring & Strainer	B	1	1	\$2,450.00
868-R624I	4" No-Hub - 16" Ductile Iron Ring & Strainer	B	1	1	\$2,450.00
868-R626I	6" No-Hub - 16" Ductile Iron Ring & Strainer	B	1	1	\$2,450.00
868-R628I	8" No-Hub - 16" Ductile Iron Ring & Strainer	B	1	1	\$2,450.00
<b>ROUND DUCTILE STRAINER - NICKEL-BRONZE VENEER</b>					
868-R623IN	3" No-Hub - 16-3/8" Ductile Iron w/ NB Veneer Ring & Strainer	B	1	1	\$4,890.00
868-R624IN	4" No-Hub - 16-3/8" Ductile Iron w/ NB Veneer Ring & Strainer	B	1	1	\$4,890.00
868-R626IN	6" No-Hub - 16-3/8" Ductile Iron w/ NB Veneer Ring & Strainer	B	1	1	\$4,890.00
868-R628IN	8" No-Hub - 16-3/8" Ductile Iron w/ NB Veneer Ring & Strainer	B	1	1	\$4,890.00
<b>SQUARE DUCTILE STRAINER</b>					
868-Q623I	3" No-Hub - 16" Ductile Iron Ring & Strainer	B	1	1	\$2,780.00
868-Q624I	4" No-Hub - 16" Ductile Iron Ring & Strainer	B	1	1	\$2,780.00
868-Q626I	6" No-Hub - 16" Ductile Iron Ring & Strainer	B	1	1	\$2,780.00
868-Q628I	8" No-Hub - 16" Ductile Iron Ring & Strainer	B	1	1	\$2,780.00
<b>SQUARE DUCTILE STRAINER - NICKEL-BRONZE VENEER</b>					
868-Q623IN	3" No-Hub - 16-3/8" Ductile Iron w/ NB Veneer Ring & Strainer	B	1	1	\$5,290.00
868-Q624IN	4" No-Hub - 16-3/8" Ductile Iron w/ NB Veneer Ring & Strainer	B	1	1	\$5,290.00
868-Q626IN	6" No-Hub - 16-3/8" Ductile Iron w/ NB Veneer Ring & Strainer	B	1	1	\$5,290.00
868-Q628IN	8" No-Hub - 16-3/8" Ductile Iron w/ NB Veneer Ring & Strainer	B	1	1	\$5,290.00

**Cast Iron - FIP Connection**

Item Number	Item Description	Pkg Type	Min Qty	Case Qty	Price
<b>ANGLE ALUMINUM STRAINER</b>					
868-S3A	3" FIP Scupper w/ Angled Aluminum Grate	BI	1	1	\$702.00
868-S4A	4" FIP Scupper w/ Angled Aluminum Grate	BI	1	1	\$702.00
868-S6A	6" FIP Scupper w/ Angled Aluminum Grate	BI	1	1	\$1,300.00
<b>FLUSH ALUMINUM STRAINER</b>					
868-S3F	3" FIP Scupper w/ Flush Aluminum Grate	BI	1	1	\$800.00
868-S4F	4" FIP Scupper w/ Flush Aluminum Grate	BI	1	1	\$800.00
868-S6F	6" FIP Scupper w/ Flush Aluminum Grate	BI	1	1	\$1,230.00



868-S4A



868-S4F

Supply

Drainage

Support

Specialties

Appendix

Supply

Drainage

Support

Specialties

Appendix



868-N3H



868-N6F

### Nickel-Bronze Downspout Nozzles

Item Number	Item Description	Pkg Type	Min Qty	Case Qty	Price
<b>NO-HUB CONNECTION</b>					
868-N3H	Downspout Nozzle 3" w/ Ring No-Hub Connection	BI	1	1	\$1,338.00
868-N4H	Downspout Nozzle 4" w/ Ring No-Hub Connection	BI	1	1	\$1,338.00
868-N6H	Downspout Nozzle 6" w/ Ring No-Hub Connection	BI	1	1	\$2,402.00
868-N8H	Downspout Nozzle 8" w/ Ring No-Hub Connection	BI	1	1	\$3,285.00
<b>FIP THREAD CONNECTION</b>					
868-N3F	Downspout Nozzle 3" w/ Ring FIP Thread Connection	BI	1	1	\$1,338.00
868-N4F	Downspout Nozzle 4" w/ Ring FIP Thread Connection	BI	1	1	\$1,338.00
<b>868-N6F</b>	Downspout Nozzle 6" w/ Ring FIP Thread Connection	BI	1	1	\$2,402.00
<b>868-N8F</b>	Downspout Nozzle 8" w/ Ring FIP Thread Connection	BI	1	1	\$3,285.00
<b>ACCESSORIES</b>					
868-NS3	3" Bird Screen w/ Screws	BI	1	1	\$84.00
868-NS4	4" Bird Screen w/ Screws	BI	1	1	\$100.00
868-NS6	6" Bird Screen w/ Screws	BI	1	1	\$115.00
<b>868-NS8</b>	8" Bird Screen w/ Screws	BI	1	1	\$135.00

### Stainless Steel Downspout Nozzle Cover



Item Number	Item Description	Pkg Type	Min Qty	Case Qty	Price
868-N3S	3", Hinged Cover	BI	1	1	\$3,604.00
868-N4S	4", Hinged Cover	BI	1	1	\$3,604.00
868-N6S	6", Hinged Cover	BI	1	1	\$3,801.00
868-N8S	8", Hinged Cover	BI	1	1	\$3,989.00

### Vent Cap



868-V234

#### Cast Iron - Set Screw Connection

Item Number	Item Description	Pkg Type	Min Qty	Case Qty	Price
868-V234	Cast Iron Vent Cap For 2", 3", Or 4" Pipe	BI	1	1	\$485.00

# Specification Cleanouts

**FinishLine™ Adjustable Cleanouts**

**Access Cover Cleanouts**

**Halo™ Cleanouts**

**Cleanout Fittings**

**Wall Cleanouts**

**Plugs**



FinishLine™ Cleanouts are adjustable both before and AFTER the concrete pour. The FinishLine virtually eliminates cleanouts set too low or not level. Installations are faster, easier, and more professional looking.



**834-4DNR**  
**Page 287**



**834-6DNR**  
**Page 288**



**834-3SSR**  
**Page 290**



**854-221Q**  
**Page 292**



**854-221S**  
**Page 293**



**851-24I**  
**Page 296**



**850-9I**  
**Page 297**



**822-C3DSR**  
**Page 298**



**853-T24I**  
**Page 299**



**873-36**  
**Page 300**



**971-99**  
**Page 300**

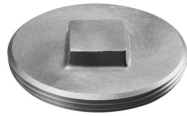

**876-RS30**  
**Page 301**

Cast Iron - No-Hub Connection

6-1/2" Tops

Options: Add suffix to item no. Add price to list

V = Vandal-Resistant Cover: \$23.00; S = Stamping: Specify Letters (1): \$75.00;

C = Carpet Marker: \$100.00; B = Brass Cleanout Plug (2): \$85.00;

Z = Complies with Buy American Act (3): \$125.00; H = Special-Duty Cover (15,000 lbs. safe load) (4): \$135.00;

1: Not available for iron covers 2: In lieu of polypro (standard) 3: For round nickel-bronze covers only 4: Not available for stainless steel covers

Item Number	Item Description	Pkg Type	Min Qty	Case Qty	Price
<b>ROUGH-IN FIXTURE</b>					
834-3DF	3" No-Hub	Bl	1	1	\$280.00
834-4DF	4" No-Hub	Bl	1	1	\$280.00
<b>FINISH FIXTURE</b>					
834-4DHIR	6-1/2" Rnd Ductile Iron Ring & Strainer	Bl	1	10	\$293.00
834-4DHNQ	6-5/8" Sqr Nikl-Brnz Ring & Strainer	Bl	1	10	\$559.00
834-4DHNR	6-1/2" Rnd Nikl-Brnz Ring & Strainer	Bl	1	10	\$453.00
834-4DHSQ	6-5/8" Sqr Stnls Steel Ring & Strainer	Bl	1	1	\$559.00
834-4DHSR	6-1/2" Rnd Stnls Steel Ring & Strainer	Bl	1	1	\$453.00
<b>COMPLETE ASSEMBLY</b>					
834-3DIR	3" No-Hub - 6-1/2" Rnd Ductile Iron Ring & Strainer	Bl	1	1	\$750.00
834-3DNQ	3" No-Hub - 6-5/8" Sqr Nikl-Brnz Ring & Strainer	Bl	1	1	\$919.00
834-3DNR	3" No-Hub - 6-1/2" Rnd Nikl-Brnz Ring & Strainer	Bl	1	1	\$819.00
834-3DSQ	3" No-Hub - 6-5/8" Sqr Stnls Steel Ring & Strainer	Bl	1	1	\$919.00
834-3DSR	3" No-Hub - 6-1/2" Rnd Stnls Steel Ring & Strainer	Bl	1	1	\$1,025.00
834-4DIR	4" No-Hub - 6-1/2" Rnd Ductile Iron Ring & Strainer	Bl	1	1	\$860.00
834-4DNQ	4" No-Hub - 6-5/8" Sqr Nikl-Brnz Ring & Strainer	Bl	1	1	\$1,196.00
834-4DNR	4" No-Hub - 6-1/2" Rnd Nikl-Brnz Ring & Strainer	Bl	1	1	\$1,096.00
834-4DSQ	4" No-Hub - 6-5/8" Sqr Stnls Steel Ring & Strainer	Bl	1	1	\$837.00
834-4DSR	4" No-Hub - 6-1/2" Rnd Stnls Steel Ring & Strainer	Bl	1	1	\$1,075.00
<b>ACCESSORIES</b>					
832-EX4CQ	Ductile Iron Extension Adapter - 2" Min - 4" Max	Bl	1	1	\$120.00
832-PCQ	Coring Plug Wrench	Bl	1	1	\$87.00
832-S4CQ	Two Adjustment Shims, Two 3/4" Screws	Bl	1	1	\$22.00
832-WCQ	Flexible Red Locating Bristles w/ Screw	Bl	1	1	\$26.00



834-3DF



834-4DHIR



834-3DIR



832-WCQ

Supply

Drainage

Support

Specialties

Appendix



834-49DF



834-6DHNR



834-49DIR



832-P



834-63DF

## Cast Iron - No-Hub Connection

### 9" Tops

**Options:** Add suffix to item no. Add price to list

**V** = Vandal-Resistant Cover: \$23.00; **S** = Stamping: specify letters (1): \$75.00;

**C** = Carpet Marker: \$30.00; **B** = Brass plug in place of polypro: \$75.00;

**F** = Clamping Collar: \$149.00;

1: Not available for iron covers

Item Number	Item Description	Pkg Type	Min Qty	Case Qty	Price
<b>ROUGH-IN FIXTURE</b>					
834-49DF	4" No-Hub	BI	1	1	\$572.00
834-6DF	6" No-Hub	BI	1	1	\$572.00
<b>FINISH FIXTURE</b>					
834-6DHIR	9" Rnd Iron Ring & Strainer	BI	1	1	\$439.00
834-6DHNR	9" Rnd Nikl-Brnz Ring & Strainer	BI	1	1	\$1,024.00
834-6DHSR	9" Rnd Stnls Steel Ring & Strainer	BI	1	1	\$1,024.00
<b>COMPLETE ASSEMBLY</b>					
834-49DIR	4" No-Hub - 9" Rnd Ductile Iron Ring & Strainer	BI	1	1	\$1,200.00
834-49DNR	4" No-Hub - 9" Rnd Nikl-Brnz Ring & Strainer	BI	1	1	\$1,552.00
834-49DSR	4" No-Hub - 9" Rnd Stnls Steel Ring & Strainer	BI	1	1	\$1,552.00
834-6DIR	6" No-Hub - 9" Rnd Ductile Iron Ring & Strainer	BI	1	1	\$1,010.00
834-6DNR	6" No-Hub - 9" Rnd Nikl-Brnz Ring & Strainer	BI	1	1	\$1,594.00
834-6DSR	6" No-Hub - 9" Rnd Stnls Steel Ring & Strainer	BI	1	1	\$1,594.00
<b>ACCESSORIES</b>					
832-PCQ	Coring Plug Wrench	BI	1	1	\$87.00
832-WCQ	Flexible Red Locating Bristles w/ Screw	BI	1	1	\$26.00

## Cast Iron - Push-Joint Connection

### 6-1/2" Tops

**Options:** Add suffix to item no. Add price to list

**V** = Vandal-Resistant Cover: \$23.00; **S** = Stamping: Specify Letters (1): \$75.00;

**C** = Carpet Marker: \$100.00; **B** = Brass Cleanout Plug (2): \$85.00;

**Z** = Complies with Buy American Act (3): \$125.00; **P** = Push-joint Gasket to fit Sch. 40 ABS/PVC Pipe: \$25.00;

**H** = Special-Duty Cover (15,000 lbs. safe load) (4): \$135.00;

1: Not available for iron covers. 2: In lieu of polypro (standard) 3: For round nickel-bronze covers only 4: Not available for stainless steel covers

Item Number	Item Description	Pkg Type	Min Qty	Case Qty	Price
<b>ROUGH-IN FIXTURE</b>					
834-63DF	3" PJ Conn.	BI	1	1	\$312.00
834-64DF	4" PJ Conn.	BI	1	1	\$312.00

**Cast Iron - Push-Joint Connection (Cont)**

**6-1/2" Tops**

Item Number	Item Description	Pkg Type	Min Qty	Case Qty	Price
<b>FINISH FIXTURE</b>					
834-4DHIR	6-1/2" Rnd Ductile Iron Ring & Strainer	Bl	1	10	\$293.00
834-4DHNQ	6-5/8" Sqr Nikl-Brnz Ring & Strainer	Bl	1	10	\$559.00
834-4DHNR	6-1/2" Rnd Nikl-Brnz Ring & Strainer	Bl	1	10	\$453.00
834-4DHSQ	6-5/8" Sqr Stnls Steel Ring & Strainer	Bl	1	1	\$559.00
834-4DHSR	6-1/2" Rnd Stnls Steel Ring & Strainer	Bl	1	1	\$453.00
<b>COMPLETE ASSEMBLY</b>					
834-63DIR	3" PJ Conn. - 6-1/2" Rnd Ductile Iron Ring & Strainer	Bl	1	1	\$750.00
834-63DNQ	3" PJ Conn. - 6-5/8" Sqr Nikl-Brnz Ring & Strainer	Bl	1	1	\$837.00
834-63DNR	3" PJ Conn. - 6-1/2" Rnd Nikl-Brnz Ring & Strainer	Bl	1	1	\$731.00
834-63DSQ	3" PJ Conn. - 6-5/8" Sqr Stnls Steel Ring & Strainer	Bl	1	1	\$837.00
834-63DSR	3" PJ Conn. - 6-1/2" Rnd Stnls Steel Ring & Strainer	Bl	1	1	\$731.00
834-64DIR	4" PJ Conn. - 6-1/2" Rnd Ductile Iron Ring & Strainer	Bl	1	1	\$860.00
834-64DNQ	4" PJ Conn. - 6-5/8" Sqr Nikl-Brnz Ring & Strainer	Bl	1	1	\$837.00
834-64DNR	4" PJ Conn. - 6-1/2" Rnd Nikl-Brnz Ring & Strainer	Bl	1	1	\$731.00
834-64DSQ	4" PJ Conn. - 6-5/8" Sqr Stnls Steel Ring & Strainer	Bl	1	1	\$837.00
834-64DSR	4" PJ Conn. - 6-1/2" Rnd Stnls Steel Ring & Strainer	Bl	1	1	\$731.00
<b>ACCESSORIES</b>					
832-EX4CQ	Ductile Iron Extension Adapter - 2" Min - 4" Max	Bl	1	1	\$120.00
832-PCQ	Coring Plug Wrench	Bl	1	1	\$87.00
832-S4CQ	Two Adjustment Shims, Two 3/4" Screws	Bl	1	1	\$22.00
832-WCQ	Flexible Red Locating Bristles w/ Screw	Bl	1	1	\$26.00



834-4DHIR



834-63DNQ

**Stainless Steel - No-Hub Connection**

**6-1/2" Tops**

Options: Add suffix to item no. Add price to list  
 V = Vandal-Resistant Cover: \$23.00;

Item Number	Item Description	Pkg Type	Min Qty	Case Qty	Price
<b>ROUGH-IN FIXTURE</b>					
834-3SF	3" Hub	Bl	1	1	\$1,441.00
834-4SF	4" Hub	Bl	1	1	\$1,441.00
<b>FINISH FIXTURE</b>					
834-4SHSQ	6-5/8" Sqr Stnls Steel Ring & Strainer	Bl	1	1	\$900.00
834-4SHSR	6-1/2" Rnd Stnls Steel Ring & Strainer	Bl	1	1	\$794.00



834-3SF



834-4SHSR

Supply

Drainage

Support

Specialties

Appendix

Supply

Drainage

Support

Specialties

Appendix



834-3SSR

### Stainless Steel - No-Hub Connection (Cont)

#### 6-1/2" Tops

Item Number	Item Description	Pkg Type	Min Qty	Case Qty	Price
<b>COMPLETE ASSEMBLY</b>					
834-3SSQ	3" No-Hub - 6-5/8" Sqr Stnls Steel Ring & Strainer	BI	1	1	\$2,341.00
834-3SSR	3" No-Hub - 6-1/2" Rnd Stnls Steel Ring & Strainer	BI	1	1	\$2,235.00
834-4SSQ	4" No-Hub - 6-5/8" Sqr Stnls Steel Ring & Strainer	BI	1	1	\$2,341.00
834-4SSR	4" No-Hub - 6-1/2" Rnd Stnls Steel Ring & Strainer	BI	1	1	\$2,235.00
<b>ACCESSORIES</b>					
832-PCQ	Coring Plug Wrench	BI	1	1	\$87.00
832-S4CQ	Two Adjustment Shims, Two 3/4" Screws	BI	1	1	\$22.00
832-WCQ	Flexible Red Locating Bristles w/ Screw	BI	1	1	\$26.00

## Cast Iron - No-Hub Connection

### Nickel-Bronze Cover

**Options:** Add suffix to item no. Add price to list

**A** = Acid-Resistant Epoxy Coated Cast Iron: \$335.00; **B** = Brass Cleanout Plug (1): \$153.00;  
**F** = Anchor Flange with Clamping Collar: \$125.00; **C** = Nickel-Bronze Carpet Clamp: \$295.00;  
**M** = Carpet Marker: \$75.00;

1: In lieu of ABS (standard)

Item Number	Item Description	Pkg Type	Min Qty	Case Qty	Price
<b>ROUND COVER</b>					
854-22NR	2" No-Hub - 5-5/8" Nickel-Bronze Ring & Cover	B	1	1	\$775.00
854-23NR	3" No-Hub - 5-5/8" Nickel-Bronze Ring & Cover	B	1	1	\$737.10
854-24NR	4" No-Hub - 5-5/8" Nickel-Bronze Ring & Cover	B	1	1	\$986.40
<b>SQUARE COVER</b>					
854-22NQ	2" No-Hub - 5-5/8" Nickel-Bronze Ring & Cover	B	1	1	\$875.00
854-23NQ	3" No-Hub - 5-5/8" Nickel-Bronze Ring & Cover	B	1	1	\$827.10
854-24NQ	4" No-Hub - 5-5/8" Nickel-Bronze Ring & Cover	B	1	1	\$1,076.40

## Cast Iron - No-Hub Connection

### Stainless Steel Cover

**Options:** Add suffix to item no. Add price to list

**A** = Acid-Resistant Epoxy Coated Cast Iron: \$335.00; **B** = Brass Cleanout Plug (1): \$153.00;  
**F** = Anchor Flange with Clamping Collar: \$125.00; **M** = Carpet Marker: \$75.00;

1: In lieu of ABS (standard)

Item Number	Item Description	Pkg Type	Min Qty	Case Qty	Price
<b>ROUND COVER</b>					
854-22SR	2" No-Hub - 5-5/8" Stainless Steel Ring & Cover	B	1	1	\$977.00
854-23SR	3" No-Hub - 5-5/8" Stainless Steel Ring & Cover	B	1	1	\$922.50
854-24SR	4" No-Hub - 5-5/8" Stainless Steel Ring & Cover	B	1	1	\$967.50



854-24NR



854-24NQ



854-24SR

Supply

Drainage

Support

Specialties

Appendix

Supply

Drainage

Support

Specialties

Appendix



854-24I



854-22IQ

### Cast Iron - No-Hub Connection

#### Ductile Iron Cover

**Options:** Add suffix to item no. Add price to list

**A** = Acid-Resistant Epoxy Coated Cast Iron: \$335.00; **B** = Brass Cleanout Plug (1): \$153.00;

**F** = Anchor Flange with Clamping Collar: \$125.00; **C** = Nickel-Bronze Carpet Clamp: \$295.00;

**M** = Carpet Marker: \$75.00;

1: In lieu of ABS (standard)

Item Number	Item Description	Pkg Type	Min Qty	Case Qty	Price
<b>ROUND COVER</b>					
<b>854-22I</b>	2" No-Hub - 5-1/4" Ductile Iron Ring & Cover	B	1	1	\$630.00
854-23I	3" No-Hub - 5-1/4" Ductile Iron Ring & Cover	B	1	1	\$675.00
854-24I	4" No-Hub - 5-1/4" Ductile Iron Ring & Cover	B	1	1	\$774.00
854-26I	6" No-Hub - 8-1/4" Ductile Iron Ring & Cover	B	1	1	\$1,500.00
<b>854-28I</b>	8" No-Hub - 9-1/4" Ductile Iron Ring & Cover	B	1	1	\$1,775.00
<b>SQUARE COVER</b>					
<b>854-22IQ</b>	2" No-Hub - 5-1/4" Ductile Iron Ring & Cover	B	1	1	\$630.00
854-23IQ	3" No-Hub - 5-1/4" Ductile Iron Ring & Cover	B	1	1	\$750.00
854-24IQ	4" No-Hub - 5-1/4" Ductile Iron Ring & Cover	B	1	1	\$860.00

### Cast Iron - No-Hub Connection

#### Ductile Iron Cover with Nickel-Bronze Veneer

**Options:** Add suffix to item no. Add price to list

**A** = Acid-Resistant Epoxy Coated Cast Iron: \$335.00; **B** = Brass Cleanout Plug (1): \$153.00;

**F** = Anchor Flange with Clamping Collar: \$125.00; **C** = Nickel-Bronze Carpet Clamp: \$295.00;

**M** = Carpet Marker: \$75.00;

1: In lieu of ABS (standard)



854-24IN



854-22INQ

Item Number	Item Description	Pkg Type	Min Qty	Case Qty	Price
<b>ROUND COVER</b>					
<b>854-22IN</b>	2" No-Hub - 5-5/8" Ductile Iron w/ NB Veneer Ring & Cover	B	1	1	\$832.00
854-23IN	3" No-Hub - 5-5/8" Ductile Iron w/ NB Veneer Ring & Cover	B	1	1	\$948.00
854-24IN	4" No-Hub - 5-5/8" Ductile Iron w/ NB Veneer Ring & Cover	B	1	1	\$1,061.00
854-26IN	6" No-Hub - 8-3/4" Ductile Iron w/ NB Veneer Ring & Cover	B	1	1	\$1,700.00
<b>854-28IN</b>	8" No-Hub - 9-3/4" Ductile Iron w/ NB Veneer Ring & Cover	B	1	1	\$1,975.00
<b>SQUARE COVER</b>					
<b>854-22INQ</b>	2" No-Hub - 5-5/8" Ductile Iron w/ NB Veneer Ring & Cover	B	1	1	\$832.00
854-23INQ	3" No-Hub - 5-5/8" Ductile Iron w/ NB Veneer Ring & Cover	B	1	1	\$948.00
854-24INQ	4" No-Hub - 5-5/8" Ductile Iron w/ NB Veneer Ring & Cover	B	1	1	\$1,100.00

## Cast Iron - No-Hub Connection

### Ductile Iron Cover with Stainless Steel Veneer

**Options:** Add suffix to item no. Add price to list

**A** = Acid-Resistant Epoxy Coated Cast Iron: \$335.00; **B** = Brass Cleanout Plug (1): \$153.00;

**F** = Anchor Flange with Clamping Collar: \$125.00; **M** = Carpet Marker: \$75.00;

1: In lieu of ABS (standard)



854-22IS

Item Number	Item Description	Pkg Type	Min Qty	Case Qty	Price
<b>ROUND COVER</b>					
854-22IS	2" No-Hub - 5-5/8" Ductile Iron w/ SS Veneer Ring & Cover	B	1	1	\$978.00
854-23IS	3" No-Hub - 5-5/8" Ductile Iron w/ SS Veneer Ring & Cover	B	1	1	\$1,035.00
854-24IS	4" No-Hub - 5-5/8" Ductile Iron w/ SS Veneer Ring & Cover	B	1	1	\$1,123.00
854-26IS	6" No-Hub - 8-3/4" Ductile Iron w/ SS Veneer Ring & Cover	B	1	1	\$1,900.00
854-28IS	8" No-Hub - 9-3/4" Ductile Iron w/ SS Veneer Ring & Cover	B	1	1	\$2,200.00

## Cast Iron - Push-Joint Connection

### Nickel-Bronze Cover

**Options:** Add suffix to item no. Add price to list

**A** = Acid-Resistant Epoxy Coated Cast Iron: \$335.00; **B** = Brass Cleanout Plug (1): \$153.00;

**F** = Anchor Flange with Clamping Collar: \$125.00; **C** = Nickel-Bronze Carpet Clamp: \$295.00;

**M** = Carpet Marker: \$75.00;

1: In lieu of ABS (standard)



854-64NR



854-64NQ

Item Number	Item Description	Pkg Type	Min Qty	Case Qty	Price
<b>ROUND COVER</b>					
854-62NR	2" PJ Conn. - 5-5/8" Nickel-Bronze Ring & Cover	B	1	1	\$775.00
854-63NR	3" PJ Conn. - 5-5/8" Nickel-Bronze Ring & Cover	B	1	1	\$775.00
854-64NR	4" PJ Conn. - 5-5/8" Nickel-Bronze Ring & Cover	B	1	1	\$775.00
<b>SQUARE COVER</b>					
854-62NQ	2" PJ Conn. - 5-5/8" Nickel-Bronze Ring & Cover	B	1	1	\$875.00
854-63NQ	3" PJ Conn. - 5-5/8" Nickel-Bronze Ring & Cover	B	1	1	\$875.00
854-64NQ	4" PJ Conn. - 5-5/8" Nickel-Bronze Ring & Cover	B	1	1	\$875.00



854-64SR

### Cast Iron - Push-Joint Connection Stainless Steel Cover

**Options:** Add suffix to item no. Add price to list

**A** = Acid-Resistant Epoxy Coated Cast Iron: \$335.00; **B** = Brass Cleanout Plug (1): \$153.00;

**F** = Anchor Flange with Clamping Collar: \$125.00; **M** = Carpet Marker: \$75.00;

1: In lieu of ABS (standard)

Item Number	Item Description	Pkg Type	Min Qty	Case Qty	Price
<b>ROUND COVER</b>					
854-62SR	2" PJ Conn. - 5-5/8" Stainless Steel Ring & Cover	B	1	1	\$977.00
854-63SR	3" PJ Conn. - 5-5/8" Stainless Steel Ring & Cover	B	1	1	\$977.00
854-64SR	4" PJ Conn. - 5-5/8" Stainless Steel Ring & Cover	B	1	1	\$977.00

### Cast Iron - Push-Joint Connection Ductile Iron Cover

**Options:** Add suffix to item no. Add price to list

**A** = Acid-Resistant Epoxy Coated Cast Iron: \$335.00; **B** = Brass Cleanout Plug (1): \$153.00;

**F** = Anchor Flange with Clamping Collar: \$125.00; **C** = Nickel-Bronze Carpet Clamp: \$295.00;

**M** = Carpet Marker: \$75.00;

1: In lieu of ABS (standard)



854-62I



854-62IQ

Item Number	Item Description	Pkg Type	Min Qty	Case Qty	Price
<b>ROUND COVER</b>					
854-62I	2" PJ Conn. - 5-1/4" Ductile Iron Ring & Cover	B	1	1	\$630.00
854-63I	3" PJ Conn. - 5-1/4" Ductile Iron Ring & Cover	B	1	1	\$675.00
854-64I	4" PJ Conn. - 5-1/4" Ductile Iron Ring & Cover	B	1	1	\$774.00
854-66I	6" PJ Conn. - 8-1/4" Ductile Iron Ring & Cover	B	1	1	\$1,500.00
854-68I	8" PJ Conn. - 9-1/4" Ductile Iron Ring & Cover	B	1	1	\$1,775.00
<b>SQUARE COVER</b>					
854-62IQ	2" PJ Conn. - 5-1/4" Ductile Iron Ring & Cover	B	1	1	\$630.00
854-63IQ	3" PJ Conn. - 5-1/4" Ductile Iron Ring & Cover	B	1	1	\$750.00
854-64IQ	4" PJ Conn. - 5-1/4" Ductile Iron Ring & Cover	B	1	1	\$860.00

## Cast Iron - Push-Joint Connection

### Ductile Iron Cover with Nickel-Bronze Veneer

**Options:** Add suffix to item no. Add price to list

**A** = Acid-Resistant Epoxy Coated Cast Iron: \$335.00; **B** = Brass Cleanout Plug (1): \$153.00;  
**F** = Anchor Flange with Clamping Collar: \$125.00; **C** = Nickel-Bronze Carpet Clamp: \$295.00;  
**M** = Carpet Marker: \$75.00;

1: In lieu of ABS (standard)

Item Number	Item Description	Pkg Type	Min Qty	Case Qty	Price
<b>ROUND COVER</b>					
<b>854-62IN</b>	2" PJ Conn. - 5-5/8" Ductile Iron w/ NB Veneer Ring & Cover	B	1	1	\$832.00
854-63IN	3" PJ Conn. - 5-5/8" Ductile Iron w/ NB Veneer Ring & Cover	B	1	1	\$948.00
854-64IN	4" PJ Conn. - 5-5/8" Ductile Iron w/ NB Veneer Ring & Cover	B	1	1	\$1,061.00
<b>854-66IN</b>	6" PJ Conn. - 8-3/4" Ductile Iron w/ NB Veneer Ring & Cover	B	1	1	\$1,700.00
<b>854-68IN</b>	8" PJ Conn. - 9-3/4" Ductile Iron w/ NB Veneer Ring & Cover	B	1	1	\$1,975.00
<b>SQUARE COVER</b>					
<b>854-62INQ</b>	2" PJ Conn. - 5-5/8" Ductile Iron w/ NB Veneer Ring & Cover	B	1	1	\$832.00
854-63INQ	3" PJ Conn. - 5-5/8" Ductile Iron w/ NB Veneer Ring & Cover	B	1	1	\$948.00
854-64INQ	4" PJ Conn. - 5-5/8" Ductile Iron w/ NB Veneer Ring & Cover	B	1	1	\$1,061.00



854-62IN



854-62INQ

## Cast Iron - Push-Joint Connection

### Ductile Iron Cover with Stainless Steel Veneer

**Options:** Add suffix to item no. Add price to list

**A** = Acid-Resistant Epoxy Coated Cast Iron: \$335.00; **B** = Brass Cleanout Plug (1): \$153.00;  
**F** = Anchor Flange with Clamping Collar: \$125.00; **M** = Carpet Marker: \$75.00;

1: In lieu of ABS (standard)

Item Number	Item Description	Pkg Type	Min Qty	Case Qty	Price
<b>ROUND COVER</b>					
<b>854-62IS</b>	2" PJ Conn. - 5-5/8" Ductile Iron w/ SS Veneer Ring & Cover	B	1	1	\$978.00
854-63IS	3" PJ Conn. - 5-5/8" Ductile Iron w/ SS Veneer Ring & Cover	B	1	1	\$1,035.00
854-64IS	4" PJ Conn. - 5-5/8" Ductile Iron w/ SS Veneer Ring & Cover	B	1	1	\$1,123.00
<b>854-66IS</b>	6" PJ Conn. - 8-3/4" Ductile Iron w/ SS Veneer Ring & Cover	B	1	1	\$1,900.00
<b>854-68IS</b>	8" PJ Conn. - 9-3/4" Ductile Iron w/ SS Veneer Ring & Cover	B	1	1	\$2,200.00



854-62IS

Supply

Drainage

Support

Specialties

Appendix



851-24N



851-24I



851-64N



851-64I

### Cast Iron - No-Hub Connection

**Options:** Add suffix to item no. Add price to list

**V** = Vandal-Resistant Cover: \$23.00; **S** = Stamping: Specify Letters (1): \$75.00;

**C** = Carpet Marker (1): \$75.00;

1: Not available for cast iron covers

Item Number	Item Description	Pkg Type	Min Qty	Case Qty	Price
<b>NICKEL-BRONZE COVER</b>					
851-24N	4" Cast Iron No-Hub - 6" Rnd Ring & Cover	BI	1	2	\$830.00
<b>TENZ-ALLOY COVER</b>					
851-24T	4" Cast Iron No-Hub - 6" Rnd Ring & Cover	BI	1	2	\$479.00
<b>CAST IRON COVER</b>					
851-24I	4" Cast Iron No-Hub - 6" Rnd Ring & Cover	BI	1	2	\$381.00

### Cast Iron - Push-Joint Connection

**Options:** Add suffix to item no. Add price to list

**V** = Vandal-Resistant Cover: \$23.00; **S** = Stamping: Specify Letters (1): \$75.00;

**C** = Carpet Marker (1): \$75.00; **P** = Push-Joint Gasket to fit Sch. 40 ABS/PVC Pipe (2): \$25.00;

1: Not available for cast iron covers 2: For 4" cleanouts only

Item Number	Item Description	Pkg Type	Min Qty	Case Qty	Price
<b>NICKEL-BRONZE COVER</b>					
851-64N	4" Cast Iron PJ Conn. - 6" Rnd Ring & Cover	BI	1	2	\$830.00
851-66N	6" Cast Iron PJ Conn. - 8-3/8" Rnd Ring & Cover	BI	1	2	\$2,109.00
<b>TENZ-ALLOY COVER</b>					
851-64T	4" Cast Iron PJ Conn. - 6" Rnd Ring & Cover	BI	1	2	\$479.00
851-66T	6" Cast Iron PJ Conn. - 8-3/8" Rnd Ring & Cover	BI	1	2	\$1,547.00
<b>CAST IRON COVER</b>					
851-64I	4" Cast Iron PJ Conn. - 6" Rnd Ring & Cover	BI	1	2	\$381.00
851-66I	6" Cast Iron PJ Conn. - 8-3/8" Rnd Ring & Cover	BI	1	2	\$1,490.00

## Heavy-Duty Cleanout Housing

### Double Flanged

Item Number	Item Description	Pkg Type	Min Qty	Case Qty	Price
<b>CAST IRON</b>					
850-9I	8-1/2" Inner Diam, w/ Lifting Device	BI	1	1	\$1,700.00
<b>NB LAMINATED CAST IRON</b>					
850-9IN	8-1/2" Inner Diam, w/ Lifting Device	BI	1	1	\$2,400.00



850-9I



850-9IN

Supply

Drainage

Support

Specialties

Appendix



822-C3DNQ



822-C3DSR

## Halo™ Adjustable Cleanouts

### Cast Iron - No-Hub Connection

· Halo cleanout fixtures include 882-ST302 mechanical sealing plug

**Options:** Add suffix to item no. Add price to list

**V** = Vandal-Resistant Cover: \$23.00; **S** = Stamping: Specify Letters: \$75.00;

**C** = Carpet Marker: \$75.00; **Z** = Complies with Buy American Act (1): \$125.00;

1: For round nickel-bronze covers only

Item Number	Item Description	Pkg Type	Min Qty	Case Qty	Price
<b>NICKEL-BRONZE RING &amp; COVER</b>					
822-C3DNQ	3" No-Hub - 5-7/8" Sqr Ring & Cover	BI	1	1	\$734.00
822-C3DNR	3" No-Hub - 5-1/2" Rnd Ring & Cover	BI	1	4	\$588.00
<b>STAINLESS STEEL RING &amp; COVER</b>					
822-C3DSQ	3" No-Hub - 5-7/8" Sqr Ring & Cover	BI	1	1	\$734.00
822-C3DSR	3" No-Hub - 5-1/2" Rnd Ring & Cover	BI	1	1	\$588.00

## FinishLine Halo™ Adjustable Cleanouts

### Cast Iron - No-Hub Connection

· Halo cleanout fixtures include 882-ST302 mechanical sealing plug

**Options:** Add suffix to item no. Add price to list

**V** = Vandal-Resistant Cover: \$23.00; **S** = Stamping: Specify Letters: \$75.00;

**C** = Carpet Marker: \$75.00; **Z** = Complies with Buy American Act (1): \$125.00;

1: For round nickel-bronze covers only



822-C3DF



834-3DHNR



822-CF3DNQ

Item Number	Item Description	Pkg Type	Min Qty	Case Qty	Price
<b>ROUGH-IN FIXTURE</b>					
822-C3DF	3" No-Hub	BI	1	1	\$339.00
<b>FINISH FIXTURE</b>					
834-3DHNR	5-1/2" Rnd Nikl-Brnz Ring & Strainer	BI	1	1	\$323.00
<b>COMPLETE ASSEMBLY</b>					
822-CF3DNQ	3" No-Hub - 5-7/8" Sqr Nikl-Brnz Ring & Cover	BI	1	1	\$802.00
822-CF3DNR	3" No-Hub - 5-1/2" Rnd Nikl-Brnz Ring & Cover	BI	1	1	\$664.00
822-CF3DSQ	3" No-Hub - 5-7/8" Sqr Stnls Steel Ring & Cover	BI	1	1	\$802.00
822-CF3DSR	3" No-Hub - 5-1/2" Rnd Stnls Steel Ring & Cover	BI	1	1	\$664.00

**Cleanout Tees**

**Cast Iron - No-Hub Connection**

Item Number	Item Description	Pkg Type	Min Qty	Case Qty	Price
853-T22I	2" No-Hub w/ Brass Plug	BI	1	16	\$325.00
853-T23I	3" No-Hub w/ Brass Plug	BI	1	6	\$400.00
853-T24I	4" No-Hub w/ Brass Plug	BI	1	4	\$600.00
853-T26I	6" No-Hub w/ Brass Plug	BI	1	1	\$1,700.00
853-T28I	8" No-Hub w/ Brass Plug	BI	1	1	\$2,000.00



853-T24I

**Cleanout Ferrules**

**Cleanout Ferrules**

Item Number	Item Description	Pkg Type	Min Qty	Case Qty	Price
853-F22I	2" No-Hub w/ Brass Plug	BI	1	36	\$130.00
853-F23I	3" No-Hub w/ Brass Plug	BI	1	27	\$200.00
853-F24I	4" No-Hub w/ Brass Plug	BI	1	16	\$275.00
853-F26I	6" No-Hub w/ Brass Plug	BI	1	4	\$550.00



853-F23I

Supply

Drainage

Support

Specialties

Appendix



870-93

### Cleanout Covers

#### Heavy-Duty Stainless Steel

**Options:** Add suffix to item no. Add price to list  
**S** = Stamping: Specify Letters (1): \$75.00;

1: Not available for cast iron covers

Item Number	Item Description	Pkg Type	Min Qty	Case Qty	Price
<b>16-GA COVER</b>					
870-93	3" Diameter	BI	10	10	\$20.00
870-94	4" Diameter	BI	10	10	\$33.00
870-95	5" Diameter	BI	10	10	\$72.00
870-96	6" Diameter	BI	10	10	\$53.00
870-98	8" Diameter	BI	10	10	\$72.00

### Cleanout Cover Kits

#### Stainless Steel

Item Number	Item Description	Pkg Type	Min Qty	Case Qty	Price
<b>20-GA COVER WITH SCREW</b>					
873-10	10" Cover, 3-1/2" Screw	B	1	1	\$84.00
873-6	6" Cover, 3-1/2" Screw	BI	1	1	\$56.00
873-8	8" Cover, 3-1/2" Screw	BI	1	1	\$75.00
<b>20-GA COVER WITH SCREW AND BRASS PLUG</b>					
873-256	6" Cover, 2-1/2" Plug, 3-1/2" Screw	BI	1	1	\$114.00
873-26	6" Cover, 2" Plug, 3-1/2" Screw	BI	1	1	\$101.00
873-356	6" Cover, 3-1/2" Plug, 3-1/2" Screw	BI	1	1	\$192.00
873-36	6" Cover, 3" Plug, 3-1/2" Screw	BI	1	1	\$137.00
873-48	8" Cover, 4" Plug, 3-1/2" Screw	BI	1	1	\$209.00
873-610	10" Cover, 6" Plug, 3-1/2" Screw	BI	1	1	\$582.00
873-810	10" Cover, 8" Plug, 3-1/2" Screw	BI	1	1	\$804.00



873-8



873-36

### Square Access Panels

Item Number	Item Description	Pkg Type	Min Qty	Case Qty	Price
971-77	7" x 7", Metal	B	1	1	\$793.00
971-99	9" x 9", Metal	B	1	1	\$1,161.00



971-99

**Brass - Slotted**

Item Number	Item Description	Pkg Type	Min Qty	Case Qty	Price
876-SL15	1-1/2"	Bl	10	10	\$53.00
876-SL20	2"	Bl	10	10	\$76.00
876-SL25	2-1/2"	Bl	10	10	\$92.00
876-SL30	3"	Bl	10	10	\$110.00
876-SL35	3-1/2"	Bl	10	10	\$163.00
876-SL40	4"	Bl	10	10	\$178.00
876-SL60	6"	Bl	10	10	\$634.00
876-SL80	8"	Bl	10	10	\$1,282.00

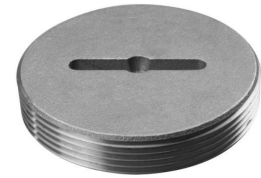

876-SL25

**Brass - Square-Head**

Item Number	Item Description	Pkg Type	Min Qty	Case Qty	Price
<b>RAISED SQUARE</b>					
876-RS15	1-1/2"	Bl	10	10	\$53.00
876-RS20	2"	Bl	10	10	\$76.00
876-RS25	2-1/2"	Bl	10	10	\$92.00
876-RS30	3"	Bl	10	10	\$110.00
876-RS35	3-1/2"	Bl	10	10	\$163.00
876-RS40	4"	Bl	10	10	\$178.00
876-RS50	5"	Bl	10	10	\$400.00
876-RS60	6"	Bl	10	10	\$634.00
876-RS80	8"	Bl	10	10	\$1,282.00
<b>COUNTERSUNK SQUARE</b>					
876-CS15	1-1/2"	Bl	10	10	\$53.00
876-CS20	2"	Bl	10	10	\$76.00
876-CS25	2-1/2"	Bl	10	10	\$92.00
876-CS30	3"	Bl	10	10	\$110.00
876-CS35	3-1/2"	Bl	10	10	\$163.00
876-CS40	4"	Bl	10	10	\$178.00
876-CS60	6"	Bl	10	10	\$634.00
876-CS80	8"	Bl	10	10	\$1,282.00



876-RS20



876-CS35



# ● Specification Fixture Carriers

**Water Closet Carriers**

**Lavatory Carriers**

Floor-mounted Carriers and supports for commercial water closet and lavatory fixtures. Water closet carriers available for bariatric applications up to 1,000 lbs.

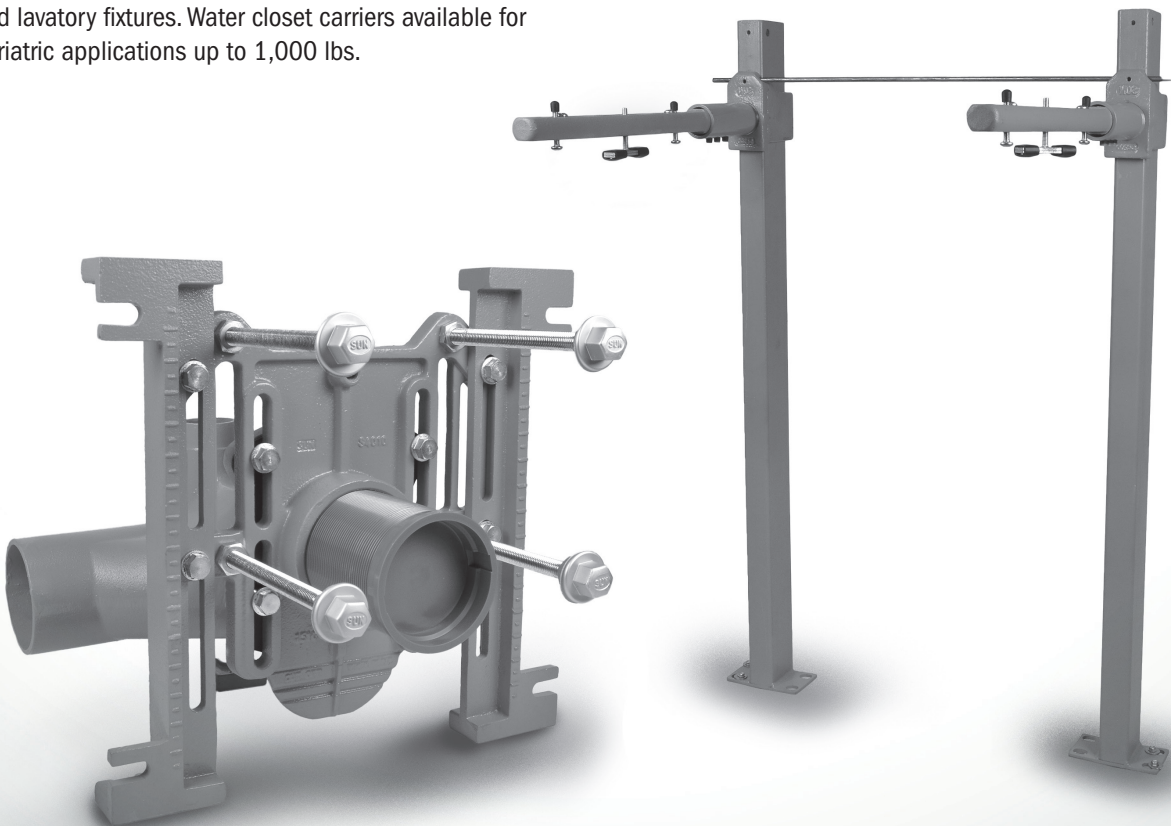

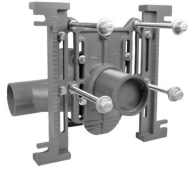

**837-HSR**  
Page 305

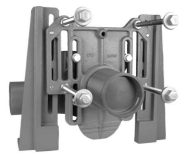

**837-HXR**  
Page 305

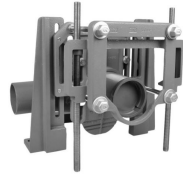

**837-HBR**  
Page 306

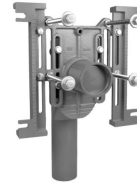

**837-VS10**  
Page 306



**837-VX10**  
Page 307









**837-VB10**  
Page 307

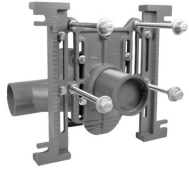
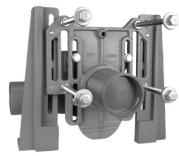
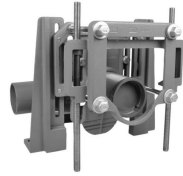

**837-7P**  
Page 309



**837-7D2**  
Page 309

 <b>837-HSR</b> Page 305	 <b>837-HXR</b> Page 305	 <b>837-HBR</b> Page 306	 <b>837-VS10</b> Page 306	 <b>837-VX10</b> Page 307
 <b>837-VB10</b> Page 307	 <b>837-7P</b> Page 309	 <b>837-7D2</b> Page 309		

**Horizontal**

**Standard (500 Lb)**

**Options:** Add suffix to item no. Add price to list  
 T = 12" ABS Threaded Coupling (1): \$53.00;

1: In lieu of 6" coupling (standard)

**Related Products**

Carrier Bracket p 529

Item Number	Item Description	Pkg Type	Min Qty	Case Qty	Price
<b>STANDARD</b>					
837-HSD	4" No-Hub, Double	B	1	1	\$3,674.00
837-HSL	4" No-Hub, Left	B	1	1	\$1,964.00
837-HSR	4" No-Hub, Right	B	1	1	\$1,964.00
<b>WIDE CHASE</b>					
837-HSDW	4" No-Hub, Double	B	1	1	\$4,500.00
837-HSLW	4" No-Hub, Left	B	1	1	\$2,400.00
837-HSRW	4" No-Hub, Right	B	1	1	\$2,400.00

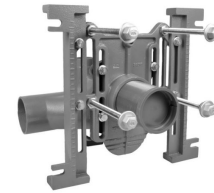

837-HSR

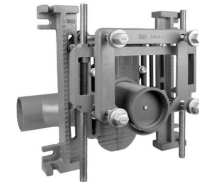

837-HSRW

**Horizontal**

**Extra-Heavy (750 Lb)**

**Options:** Add suffix to item no. Add price to list  
 T = 12" ABS Threaded Coupling (1): \$53.00;

1: In lieu of 6" coupling (standard)

Item Number	Item Description	Pkg Type	Min Qty	Case Qty	Price
837-HXD	4" No-Hub, Double	B	1	1	\$7,000.00
837-HXL	4" No-Hub, Left	B	1	1	\$4,000.00
837-HXR	4" No-Hub, Right	B	1	1	\$4,000.00

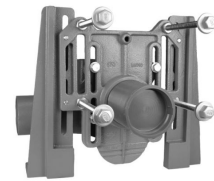

837-HXR

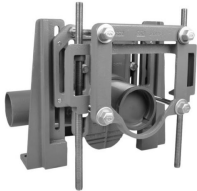

837-HBR

### Horizontal Bariatric (1,000 Lb)

**Options:** Add suffix to item no. Add price to list  
T = 12" ABS Threaded Coupling (1): \$53.00;

1: In lieu of 6" coupling (standard)

Item Number	Item Description	Pkg Type	Min Qty	Case Qty	Price
837-HBD	4" No-Hub, Double	B	1	1	\$9,800.00
837-HBL	4" No-Hub, Left	B	1	1	\$5,700.00
837-HBR	4" No-Hub, Right	B	1	1	\$5,700.00

### Vertical Standard (500 Lb)

**Options:** Add suffix to item no. Add price to list  
T = 12" ABS Threaded Coupling (1): \$53.00;

1: In lieu of 6" coupling (standard)

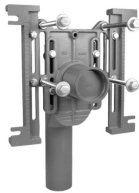

837-VS10

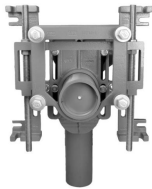

837-VS10W

Item Number	Item Description	Pkg Type	Min Qty	Case Qty	Price
<b>STANDARD</b>					
837-VS10	4" No-Hub, No-Side Inlet	B	1	1	\$2,200.00
837-VS12	4" No-Hub, 2 Side Inlets	B	1	1	\$2,900.00
837-VS1L	4" No-Hub, Left Side Inlet	B	1	1	\$2,600.00
837-VS1R	4" No-Hub, Right Side Inlet	B	1	1	\$2,600.00
837-VS20	4" No-Hub, No-Side Inlet, Double	B	1	1	\$3,900.00
837-VS21	4" No-Hub, 1 Side Inlet, Double	B	1	1	\$4,300.00
837-VS22	4" No-Hub, 2 Side Inlets Double	B	1	1	\$4,600.00
<b>WIDE CHASE</b>					
837-VS10W	4" No-Hub, No-Side Inlet	B	1	1	\$2,390.00
837-VS12W	4" No-Hub, Two Side Inlets	B	1	1	\$3,084.00
837-VS1LW	4" No-Hub, Left Side Inlet	B	1	1	\$2,740.00
837-VS1RW	4" No-Hub, Right Side Inlet	B	1	1	\$2,740.00
837-VS20W	4" No-Hub, No-Side Inlet, Double	B	1	1	\$4,311.00
837-VS21W	4" No-Hub, 1 Side Inlet, Double	B	1	1	\$4,647.00
837-VS22W	4" No-Hub, 2 Side Inlets Double	B	1	1	\$4,994.00

**Vertical**

**Extra-Heavy (750 Lb)**

**Options:** Add suffix to item no. Add price to list  
 T = 12" ABS Threaded Coupling (1): \$53.00;

1: In lieu of 6" coupling (standard)



837-VX10

Item Number	Item Description	Pkg Type	Min Qty	Case Qty	Price
<b>SINGLE</b>					
837-VX10	4" No-Hub, No-Side Inlet	B	1	1	\$4,500.00
837-VX12	4" No-Hub, 2 Side Inlets	B	1	1	\$5,400.00
837-VX1L	4" No-Hub, Left Side Inlet	B	1	1	\$4,950.00
837-VX1R	4" No-Hub, Right Side Inlet	B	1	1	\$4,950.00
<b>DOUBLE</b>					
837-VX20	4" No-Hub, No-Side Inlet, Double	B	1	1	\$8,800.00
837-VX21	4" No-Hub, 1 Side Inlet, Double	B	1	1	\$9,250.00
837-VX22	4" No-Hub, 2 Side Inlets Double	B	1	1	\$9,700.00

**Vertical**

**Bariatric (1,000 Lb)**

**Options:** Add suffix to item no. Add price to list  
 T = 12" ABS Threaded Coupling (1): \$53.00;

1: In lieu of 6" coupling (standard)



837-VB10

Item Number	Item Description	Pkg Type	Min Qty	Case Qty	Price
<b>SINGLE</b>					
837-VB10	4" No-Hub, No-Side Inlet	B	1	1	\$6,200.00
837-VB12	4" No-Hub, 2 Side Inlets	B	1	1	\$6,900.00
837-VB1L	4" No-Hub, Left Side Inlet	B	1	1	\$5,745.00
837-VB1R	4" No-Hub, Right Side Inlet	B	1	1	\$5,745.00
<b>DOUBLE</b>					
837-VB20	4" No-Hub, No-Side Inlet, Double	B	1	1	\$11,985.00
837-VB21	4" No-Hub, 1 Side Inlet, Double	B	1	1	\$12,435.00
837-VB22	4" No-Hub, 2 Side Inlets Double	B	1	1	\$12,880.00

**Closet Carrier Accessories**

Item Number	Item Description	Pkg Type	Min Qty	Case Qty	Price
<b>THREADED COUPLINGS</b>					
837-06	4" ABS Threaded WC Coupling - 6" Long	BI	1	1	\$41.00
837-12	4" ABS Threaded WC Coupling - 12" Long	BI	1	1	\$103.00

Supply

Drainage

Support

Specialties

Appendix



837-FPA

### Closet Carrier Accessories (Cont)

Item Number	Item Description	Pkg Type	Min Qty	Case Qty	Price
<b>FACE PLATE ASSEMBLY KIT</b>					
837-FPA	WC Carrier Faceplate Assembly Kit - Standard	BI	1	1	\$1,300.00
837-FPAH	WC Carrier Faceplate Assembly Kit - Heavy-Duty	BI	1	1	\$1,400.00
<b>SUPPORT LEGS &amp; ANCHORS</b>					
<b>837-LEG</b>	Standard Leg Support (1) for WC Carrier Faceplate - Reversible	BI	1	1	\$200.00
<b>837-LEGHL</b>	Heavy-Duty Leg Support for WC Carrier Faceplate - Left	BI	1	1	\$225.00
<b>837-LEGHR</b>	Heavy-Duty Leg Support for WC Carrier Faceplate - Right	BI	1	1	\$225.00
837-RA	Rear Anchor Support Kit for WC Carrier - Standard	BI	1	35	\$150.00
<b>HARDWARE PACKS</b>					
837-FH	Finish Hardware Pack for WC Carrier	BI	1	30	\$150.00
837-RH	Rough-in Hardware Pack for WC Carrier	BI	1	35	\$150.00
837-TR	Thread Rod & Sleeve Pack for WC Carrier	BI	1	15	\$75.00

**Concealed Arm**

**Options:** Add suffix to item no. Add price to list

**B** = Back-to-Back Carrier: \$500.00;

Item Number	Item Description	Pkg Type	Min Qty	Case Qty	Price
837-7C15	Lavatory Carrier, 15" Concealed Arm	B	1	1	\$1,200.00
837-7C18	Lavatory Carrier, 18" Concealed Arm	B	1	1	\$1,200.00
837-7C22	Lavatory Carrier, 22" Concealed Arm	B	1	1	\$1,200.00



837-7C

**Adjustable Concealed Arm**

**Options:** Add suffix to item no. Add price to list

**B** = Back-to-Back Carrier: \$500.00;

Item Number	Item Description	Pkg Type	Min Qty	Case Qty	Price
837-7CA15	Lavatory Carrier, 15" Adjustable Concealed Arm	B	1	1	\$1,500.00
837-7CA18	Lavatory Carrier, 18" Adjustable Concealed Arm	B	1	1	\$1,500.00
837-7CA22	Lavatory Carrier, 22" Adjustable Concealed Arm	B	1	1	\$1,500.00



**Plate Type**

**Single**

**Options:** Add suffix to item no. Add price to list

**B** = Back-to-Back Carrier: \$500.00;

Item Number	Item Description	Pkg Type	Min Qty	Case Qty	Price
837-7P	Lavatory Carrier, Plate Type For Fountain Or Urinal	B	1	1	\$900.00
837-7P2	Lavatory Carrier, Plate Type For Bi-Level Drinking Fountain	B	1	1	\$1,200.00



837-7P

**Plate Type**

**Double**

**Options:** Add suffix to item no. Add price to list

**B** = Back-to-Back Carrier: \$500.00;

Item Number	Item Description	Pkg Type	Min Qty	Case Qty	Price
837-7D	Lavatory Carrier, Double Plate Type For Fountain Or Urinal	B	1	1	\$1,000.00
837-7D2	Lavatory Carrier, Double Plate Type For Bi-Level Drinking Fountain	B	1	1	\$1,450.00



837-7D2

Supply

Drainage

Support

Specialties

Appendix

Supply



837-7W

### Wall Plate

Item Number	Item Description	Pkg Type	Min Qty	Case Qty	Price
837-7W	Lavatory Carrier, Wall Plate	B	1	1	\$260.00

Drainage

Support

Specialties

Appendix



# **Commercial Drainage**

**Floor Drains**

**Floor Sinks**

**Roof Drains**

**Cleanouts**

# Commercial Drainage



## Floor Drains

Adjustable and non-adjustable floor drains for on-grade and above-grade applications. Cast iron, PVC and ABS connections available. Designed in accordance with ASME A112.6.3 Standard for Floor and Trench Drains.

**Note:** All floor drains installed in above-grade applications must be leak tested for watertightness according to local codes and standards. Failure to do so will void the warranty.

## Floor Sinks

PVC floor sinks designed for direct or indirect waste applications.

Designed in accordance with ASME A112.6.7 Standard for Sanitary Floor Sinks.

**Note:** All floor sinks installed in above-grade applications must be leak tested for watertightness according to local codes and standards. Failure to do so will void the warranty.

## Roof Drains

Roof drain, overflow, scupper and accessory fixtures available with PVC and ABS connections.

Designed in accordance with ASME A112.6.4 Standard for Roof, Deck, and Balcony Drains.

**Note:** All roof drains must be leak tested for watertightness according to local codes and standards. Failure to do so will void the warranty.

## Cleanouts

Adjustable and non-adjustable cleanout fixtures provide access to drain lines. PVC and ABS connections available. Designed in accordance with ASME A112.36.2M Standard for Cleanouts.

**Note:** All roof drains must be leak tested for watertightness according to local codes and standards. Failure to do so will void the warranty.

# Commercial Floor Drains

**FinishLine™ On-Grade Floor Drains**

**FatMax™ Floor Drains**

**FinishLine™ Above-Grade Floor Drains**

**Halo™ Floor Drains**

**Floor Drain Accessories**

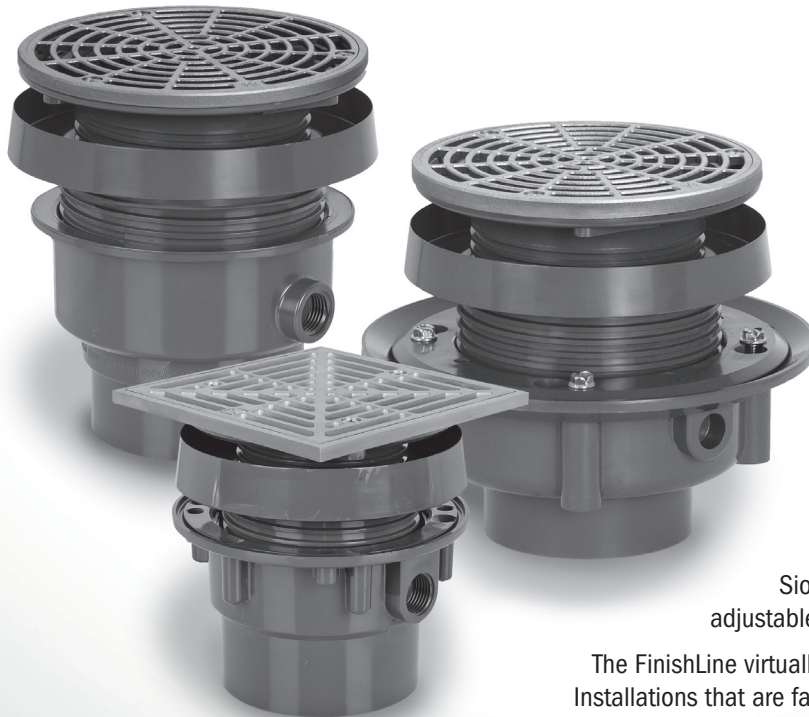

Sioux Chief's FinishLine™ Floor drain system is adjustable both before and AFTER the concrete pour.

The FinishLine virtually eliminates drains set too low or not level. Installations that are faster, easier, and more professional looking.



**832-2PNQ**  
Page 315



**832-35ASR**  
Page 317



**842-36PI**  
Page 318



**842-36LP**  
Page 319



**843-2PNR**  
Page 320



**860-2AZ**  
Page 321



**864-2P**  
Page 322



**833-2PSR**  
Page 323



**833-35ANR**  
Page 325



**833-22NR**  
Page 326



**833-235SR**  
Page 327



**833-62NR**  
Page 329



**833-625NQ**  
Page 330



**863-42NQ**  
Page 331



**863-325NR**  
Page 332



**863-24NQ**  
Page 333



**863-64NQ**  
Page 334



**822-2PSQ**  
Page 335



**822-F2ANR**  
Page 336

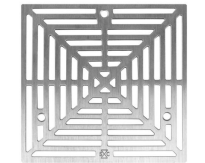

**842-SNQ3**  
Page 338

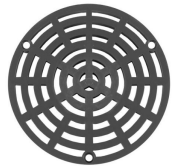

**842-SP2**  
Page 338



**842-82PT**  
Page 339



**863-HP23**  
Page 339



**850-VW1**  
Page 340

**PVC/ABS - Sch. 40 Hub Connection**

**6-1/2" Tops**

**Options:** Add suffix to item no. Add price to list

**V** = Vandal-Resistant Strainer: \$6.50; **H** = Hinged Strainer: \$16.00;

**E** = Extended Ring (1): \$78.00; **B** = Complies with Buy American Act (1): \$62.00;

1: For round nickel bronze ring/strainer only



832-36AF



832-4HSR

Item Number	Item Description	Pkg Type	Min Qty	Case Qty	Price
<b>ROUGH-IN FIXTURE</b>					
832-2AF	2" ABS Hub	Bl	1	10	\$23.95
832-2PF	2" PVC Hub	Bl	1	10	\$23.95
832-36AF	3" ABS Hub	Bl	1	10	\$23.95
832-36PF	3" PVC Hub	Bl	1	10	\$23.95
832-4AF	4" ABS Hub	Bl	1	10	\$23.95
832-4PF	4" PVC Hub	Bl	1	10	\$23.95
<b>FINISH FIXTURE</b>					
832-4HNQ	7" Sqr Nikl-Brnz Ring & Strainer	Bl	1	10	\$96.41
832-4HNR	6-1/2" Rnd Nikl-Brnz Ring & Strainer	Bl	1	10	\$64.92
832-4HSQ	7" Sqr Stnls Steel Ring & Strainer	Bl	1	1	\$96.41
832-4HSR	6-1/2" Rnd Stnls Steel Ring & Strainer	Bl	1	10	\$64.92
<b>COMPLETE ASSEMBLY</b>					
832-2ANQ	2" ABS Hub - 7" Sqr Nikl-Brnz Ring & Strainer	Bl	1	1	\$120.37
832-2ANR	2" ABS Hub - 6-1/2" Rnd Nikl-Brnz Ring & Strainer	Bl	1	1	\$88.86
<b>832-2ASQ</b>	2" ABS Hub - 7" Sqr Stnls Steel Ring & Strainer	Bl	1	1	\$120.37
<b>832-2ASR</b>	2" ABS Hub - 6-1/2" Rnd Stnls Steel Ring & Strainer	Bl	1	1	\$88.86
832-2PNQ	2" PVC Hub - 7" Sqr Nikl-Brnz Ring & Strainer	Bl	1	1	\$120.37
832-2PNR	2" PVC Hub - 6-1/2" Rnd Nikl-Brnz Ring & Strainer	Bl	1	1	\$88.86
832-2PSQ	2" PVC Hub - 7" Sqr Stnls Steel Ring & Strainer	Bl	1	1	\$120.37
832-2PSR	2" PVC Hub - 6-1/2" Rnd Stnls Steel Ring & Strainer	Bl	1	1	\$88.86
<b>832-36ANQ</b>	3" ABS Hub - 7" Sqr Nikl-Brnz Ring & Strainer	Bl	1	1	\$120.37
832-36ANR	3" ABS Hub - 6-1/2" Rnd Nikl-Brnz Ring & Strainer	Bl	1	1	\$88.86
<b>832-36ASQ</b>	3" ABS Hub - 7" Sqr Stnls Steel Ring & Strainer	Bl	1	1	\$120.37
<b>832-36ASR</b>	3" ABS Hub - 6-1/2" Rnd Stnls Steel Ring & Strainer	Bl	1	1	\$88.86
832-36PNQ	3" PVC Hub - 7" Sqr Nikl-Brnz Ring & Strainer	Bl	1	1	\$120.37
832-36PNR	3" PVC Hub - 6-1/2" Rnd Nikl-Brnz Ring & Strainer	Bl	1	1	\$88.86
832-36PSQ	3" PVC Hub - 7" Sqr Stnls Steel Ring & Strainer	Bl	1	1	\$120.37
832-36PSR	3" PVC Hub - 6-1/2" Rnd Stnls Steel Ring & Strainer	Bl	1	1	\$88.86
<b>832-4ANQ</b>	4" ABS Hub - 7" Sqr Nikl-Brnz Ring & Strainer	Bl	1	1	\$120.37
832-4ANR	4" ABS Hub - 6-1/2" Rnd Nikl-Brnz Ring & Strainer	Bl	1	1	\$88.86
<b>832-4ASQ</b>	4" ABS Hub - 7" Sqr Stnls Steel Ring & Strainer	Bl	1	1	\$120.37
<b>832-4ASR</b>	4" ABS Hub - 6-1/2" Rnd Stnls Steel Ring & Strainer	Bl	1	1	\$88.86
832-4PNQ	4" PVC Hub - 7" Sqr Nikl-Brnz Ring & Strainer	Bl	1	1	\$120.37
832-4PNR	4" PVC Hub - 6-1/2" Rnd Nikl-Brnz Ring & Strainer	Bl	1	1	\$88.86
832-4PSQ	4" PVC Hub - 7" Sqr Stnls Steel Ring & Strainer	Bl	1	1	\$120.37

Supply

Drainage

Support

Specialties

Appendix



832-2PNQ

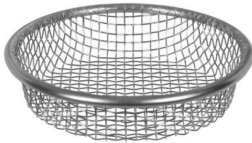

832-UM

**PVC/ABS - Sch. 40 Hub Connection (Cont)**

**6-1/2" Tops**

Item Number	Item Description	Pkg Type	Min Qty	Case Qty	Price
<b>COMPLETE ASSEMBLY</b>					
832-4PSR	4" PVC Hub - 6-1/2" Rnd Stnls Steel Ring & Strainer	BI	1	1	\$88.86
<b>ACCESSORIES</b>					
832-4HHD	Hub Drain Finish Fixture for 6-1/2" Top	BI	1	10	\$18.91
832-4HPR	Finish Fixture with 6-1/2" Rnd ABS Ring & Strainer	BI	1	10	\$34.63
832-EX4	Ductile Iron Extension Adapter - 2" Min - 4" Max	BI	1	1	\$34.14
832-P	Coring Plug Wrench	BI	1	1	\$24.65
832-S4	Two Adjustment Shims, Two 3/4" Screws	BI	1	10	\$6.10
832-UM	4-1/4" Stainless Steel Debris Basket	BI	1	15	\$21.43
832-W	Flexible Red Locating Bristles w/ Screw	BI	1	10	\$7.26
835-2	Trapshield™ For 2" Drain Outlet	BI	1	50	\$56.31
835-3	Trapshield™ For 3" Drain Outlet	BI	1	25	\$63.36
835-4	Trapshield™ For 4" Drain Outlet	BI	1	20	\$74.98
863-FA	Round Aluminum Condensate Funnel w/ Screws	BI	1	12	\$49.15
863-FN	Round Nikl-Brnz Condensate Funnel w/ Screws	BI	1	12	\$109.99
863-FNO	Oval Nikl-Brnz Condensate Funnel w/ Screws	BI	1	12	\$243.96

**PVC/ABS - Sch. 40 Hub Connection**

**5-1/2" Tops**

**Options:** Add suffix to item no. Add price to list

**V** = Vandal-Resistant Strainer: \$6.50; **B** = Complies with Buy American Act (1): \$62.00;

**E** = Extended Ring (1): \$78.00;

1: For round nickel bronze ring/strainer only



832-25PF



832-3HNQ



832-35ASR

Item Number	Item Description	Pkg Type	Min Qty	Case Qty	Price
<b>ROUGH-IN FIXTURE</b>					
832-25AF	2" ABS Hub	BI	1	10	\$19.55
832-25PF	2" PVC Hub	BI	1	10	\$19.55
832-35AF	3" ABS Hub	BI	1	10	\$19.55
832-35PF	3" PVC Hub	BI	1	10	\$19.55
<b>FINISH FIXTURE</b>					
832-3HNQ	5-7/8" Sqr Nikl-Brnz Ring & Strainer	BI	1	10	\$65.56
832-3HNR	5-1/2" Rnd Nikl-Brnz Ring & Strainer	BI	1	10	\$46.64
832-3HSQ	5-7/8" Sqr Stnls Steel Ring & Strainer	BI	1	10	\$65.56
832-3HSR	5-1/2" Rnd Stnls Steel Ring & Strainer	BI	1	10	\$46.64

**PVC/ABS - Sch. 40 Hub Connection (Cont)**

**5-1/2" Tops**



832-EPS3

Item Number	Item Description	Pkg Type	Min Qty	Case Qty	Price
<b>COMPLETE ASSEMBLY</b>					
832-25ANQ	2" ABS Hub - 5-7/8" Sqr Nikl-Brnz Ring & Strainer	Bl	1	1	\$85.06
832-25ANR	2" ABS Hub - 5-1/2" Rnd Nikl-Brnz Ring & Strainer	Bl	1	1	\$66.17
832-25ASQ	2" ABS Hub - 5-7/8" Sqr Stnls Steel Ring & Strainer	Bl	1	1	\$85.06
832-25ASR	2" ABS Hub - 5-1/2" Rnd Stnls Steel Ring & Strainer	Bl	1	1	\$66.17
832-25PNQ	2" PVC Hub - 5-7/8" Sqr Nikl-Brnz Ring & Strainer	Bl	1	1	\$85.06
832-25PNR	2" PVC Hub - 5-1/2" Rnd Nikl-Brnz Ring & Strainer	Bl	1	1	\$66.17
832-25PSQ	2" PVC Hub - 5-7/8" Sqr Stnls Steel Ring & Strainer	Bl	1	1	\$85.06
832-25PSR	2" PVC Hub - 5-1/2" Rnd Stnls Steel Ring & Strainer	Bl	1	1	\$66.17
832-35ANQ	3" ABS Hub - 5-7/8" Sqr Nikl-Brnz Ring & Strainer	Bl	1	1	\$85.06
832-35ANR	3" ABS Hub - 5-1/2" Rnd Nikl-Brnz Ring & Strainer	Bl	1	1	\$66.17
832-35ASQ	3" ABS Hub - 5-7/8" Sqr Stnls Steel Ring & Strainer	Bl	1	1	\$85.06
832-35ASR	3" ABS Hub - 5-1/2" Rnd Stnls Steel Ring & Strainer	Bl	1	1	\$66.17
832-35PNQ	3" PVC Hub - 5-7/8" Sqr Nikl-Brnz Ring & Strainer	Bl	1	1	\$85.06
832-35PNR	3" PVC Hub - 5-1/2" Rnd Nikl-Brnz Ring & Strainer	Bl	1	1	\$66.17
832-35PSQ	3" PVC Hub - 5-7/8" Sqr Stnls Steel Ring & Strainer	Bl	1	1	\$85.06
832-35PSR	3" PVC Hub - 5-1/2" Rnd Stnls Steel Ring & Strainer	Bl	1	1	\$66.17
<b>ACCESSORIES</b>					
822-EX3	Ductile Iron Extension Adapter	B	1	1	\$33.96
832-3HHD	Hub Drain Finish Fixture for 5-1/2" Top	Bl	1	10	\$15.64
832-3HS	Finish Fixture with Rnd 5-1/2" 18-Ga Stnls Steel Strainer	Bl	1	10	\$19.80
832-EPS3	Extended ABS Coring Sleeve & Plug	Bl	1	1	\$15.82
832-EX3	Ductile Iron Extension Adapter - 2" Min - 3-3/8" Max	Bl	1	1	\$34.14
832-P	Coring Plug Wrench	Bl	1	1	\$24.65
832-S3	Two Adjustment Shims, Two 3/4" Screws	Bl	1	10	\$6.10
832-W	Flexible Red Locating Bristles w/ Screw	Bl	1	10	\$7.26
835-2	Trapshield™ For 2" Drain Outlet	Bl	1	50	\$56.31
835-3	Trapshield™ For 3" Drain Outlet	Bl	1	25	\$63.36
863-FA	Round Aluminum Condensate Funnel w/ Screws	Bl	1	12	\$49.15
863-FN	Round Nikl-Brnz Condensate Funnel w/ Screws	Bl	1	12	\$109.99
863-FNO	Oval Nikl-Brnz Condensate Funnel w/ Screws	Bl	1	12	\$243.96

Supply

Drainage

Support

Specialties

Appendix



842-2ANR



842-36PSQ



842-36PI

## Adjustable Floor Drain

### PVC/ABS - Sch. 40 Hub Connection

**Options:** Add suffix to item no. Add price to list

**V** = Vandal-Resistant Strainer: \$6.50; **H** = Hinged Strainer (1): \$16.00;

**E** = Extended Ring (2): \$78.00; **B** = Complies with Buy American Act (2): \$65.00;

**Y** = Ductile Iron Head Adapter (3): \$26.00; **M** = Medium-Duty Strainer (3,000 lbs. safe-load) (4): \$39.00;

1: For 6-1/2" and 7" nickel-bronze or SS304 ring/strainer only 2: For round nickel bronze ring/strainer only 3: In lieu of ABS (standard) 4: For 6-1/2" round SS 304 ring/strainer only

Item Number	Item Description	Pkg Type	Min Qty	Case Qty	Price
<b>NICKEL-BRONZE RING &amp; STRAINER</b>					
<b>842-2ANQ</b>	2" ABS Hub - 5-7/8" Sqr Ring & Strainer	BI	1	1	\$90.48
842-2ANR	2" ABS Hub - 5-1/2" Rnd Ring & Strainer	BI	1	10	\$68.76
842-2PNQ	2" PVC Hub - 5-7/8" Sqr Ring & Strainer	BI	1	10	\$90.48
842-2PNR	2" PVC Hub - 5-1/2" Rnd Ring & Strainer	BI	1	10	\$68.76
<b>842-36ANQ</b>	3" ABS Hub - 7" Sqr Ring & Strainer	BI	1	1	\$119.43
<b>842-36ANR</b>	3" PVC Hub - 6-1/2" Rnd Ring & Strainer	BI	1	1	\$83.25
842-36PNQ	3" PVC Hub - 7" Sqr Ring & Strainer	BI	1	10	\$119.43
842-36PNR	3" PVC Hub - 6-1/2" Rnd Ring & Strainer	BI	1	10	\$83.25
<b>842-3ANQ</b>	3" ABS Hub - 5-7/8" Sqr Ring & Strainer	BI	1	1	\$90.48
842-3ANR	3" PVC Hub - 5-1/2" Rnd Ring & Strainer	BI	1	8	\$68.76
842-3PNQ	3" PVC Hub - 5-7/8" Sqr Ring & Strainer	BI	1	10	\$90.48
842-3PNR	3" PVC Hub - 5-1/2" Rnd Ring & Strainer	BI	1	8	\$68.76
<b>842-4ANQ</b>	4" ABS Hub - 7" Sqr Ring & Strainer	BI	1	1	\$119.43
842-4ANR	4" ABS Hub - 6-1/2" Rnd Ring & Strainer	BI	1	10	\$83.25
842-4PNQ	4" PVC Hub - 7" Sqr Ring & Strainer	BI	1	10	\$119.43
842-4PNR	4" PVC Hub - 6-1/2" Rnd Ring & Strainer	BI	1	10	\$83.25
<b>STAINLESS STEEL RING &amp; STRAINER</b>					
<b>842-2ASQ</b>	2" ABS Hub - 5-7/8" Sqr Ring & Strainer	BI	1	1	\$90.48
<b>842-2ASR</b>	2" ABS Hub - 5-1/2" Rnd Ring & Strainer	BI	1	1	\$68.76
842-2PSQ	2" PVC Hub - 5-7/8" Sqr Ring & Strainer	BI	1	10	\$90.48
842-2PSR	2" PVC Hub - 5-1/2" Rnd Ring & Strainer	BI	1	10	\$68.76
<b>842-36ASQ</b>	3" ABS Hub - 7" Sqr Ring & Strainer	BI	1	1	\$119.43
<b>842-36ASR</b>	3" PVC Hub - 6-1/2" Rnd Ring & Strainer	BI	1	1	\$83.25
<b>842-36PSQ</b>	3" PVC Hub - 7" Sqr Ring & Strainer	BI	1	1	\$119.43
842-36PSR	3" PVC Hub - 6-1/2" Rnd Ring & Strainer	BI	1	10	\$83.25
<b>842-3ASQ</b>	3" ABS Hub - 5-7/8" Sqr Ring & Strainer	BI	1	1	\$90.48
<b>842-3ASR</b>	3" PVC Hub - 5-1/2" Rnd Ring & Strainer	BI	1	1	\$68.76
842-3PSQ	3" PVC Hub - 5-7/8" Sqr Ring & Strainer	BI	1	10	\$90.48
842-3PSR	3" PVC Hub - 5-1/2" Rnd Ring & Strainer	BI	1	8	\$68.76
<b>842-4ASQ</b>	4" ABS Hub - 7" Sqr Ring & Strainer	BI	1	1	\$119.43
<b>842-4ASR</b>	4" ABS Hub - 6-1/2" Rnd Ring & Strainer	BI	1	1	\$83.25
842-4PSQ	4" PVC Hub - 7" Sqr Ring & Strainer	BI	1	1	\$119.43
842-4PSR	4" PVC Hub - 6-1/2" Rnd Ring & Strainer	BI	1	10	\$83.25
<b>CAST IRON RING &amp; STRAINER</b>					
842-36PI	3" PVC Hub - 6-5/8" Rnd Ring & Strainer	BI	1	2	\$67.74
842-4PI	4" PVC Hub - 6-5/8" Rnd Ring & Strainer	BI	1	2	\$67.74

**Adjustable Floor Drain (Cont)**

**PVC/ABS - Sch. 40 Hub Connection**

Item Number	Item Description	Pkg Type	Min Qty	Case Qty	Price
<b>ACCESSORIES</b>					
835-2	Trapshield™ For 2" Drain Outlet	Bl	1	50	\$56.31
835-3	Trapshield™ For 3" Drain Outlet	Bl	1	25	\$63.36
835-35	Trapshield™ For 3-1/2" Drain Head	Bl	1	25	\$63.36
835-4	Trapshield™ For 4" Drain Outlet	Bl	1	20	\$74.98
842-UM	4-5/8" Stainless Steel Debris Basket	Bl	1	1	\$21.67
863-FA	Round Aluminum Condensate Funnel w/ Screws	Bl	1	12	\$49.15
863-FN	Round Nikl-Brnz Condensate Funnel w/ Screws	Bl	1	12	\$109.99
863-FNO	Oval Nikl-Brnz Condensate Funnel w/ Screws	Bl	1	12	\$243.96



863-FA

**Adjustable Floor Drain Head**

**ABS - MIP Thread Connection**

**Options:** Add suffix to item no. Add price to list

**V** = Vandal-Resistant Strainer: \$6.50; **H** = Hinged Strainer (1): \$16.00;

**E** = Extended Ring (2): \$78.00; **M** = Medium-Duty Strainer (3,000 lbs. safe-load) (3): \$39.00;

1: For 6-1/2" and 7" nickel-bronze or SS304 ring/strainer only 2: For 5-1/2" and 6-1/2" round nickel bronze ring/strainer only 3: For 6-1/2" round SS 304 ring/strainer only

Item Number	Item Description	Pkg Type	Min Qty	Case Qty	Price
<b>NICKEL-BRONZE RING &amp; STRAINER</b>					
842-2LNQ	2" MIP - 4-1/2" Sqr Ring & Strainer	Bl	1	5	\$65.15
842-2LNR	2" MIP - 4-1/2" Rnd Ring & Strainer	Bl	1	10	\$50.67
842-36LNQ	3" MIP - 7" Sqr Ring & Strainer	Bl	1	5	\$108.57
842-36LNR	3" MIP - 6-1/2" Rnd Ring & Strainer	Bl	1	10	\$72.38
842-3LNQ	3" MIP - 5-7/8" Sqr Ring & Strainer	Bl	1	5	\$83.25
842-3LNR	3" MIP - 5-1/2" Rnd Ring & Strainer	Bl	1	10	\$61.52
842-3LNRPK	3" MIP - 5-1/2" Rnd Ring & Strainer	Cl	5	5	\$62.52
842-4LNQ	4" MIP - 7" Sqr Ring & Strainer	Bl	1	5	\$112.20
842-4LNR	4" MIP - 6-1/2" Rnd Ring & Strainer	Bl	1	10	\$75.99
<b>STAINLESS STEEL RING &amp; STRAINER</b>					
842-2LSQ	2" MIP - 4-1/2" Sqr Ring & Strainer	Bl	1	1	\$65.15
842-2LSR	2" MIP - 4-1/2" Rnd Ring & Strainer	Bl	1	1	\$50.67
<b>842-36LSQ</b>	3" MIP - 7" Sqr Ring & Strainer	Bl	1	1	\$108.57
842-36LSR	3" MIP - 6-1/2" Rnd Ring & Strainer	Bl	1	10	\$72.38
842-3LSQ	3" MIP - 5-7/8" Sqr Ring & Strainer	Bl	1	5	\$83.25
842-3LSR	3" MIP - 5-1/2" Rnd Ring & Strainer	Bl	1	10	\$61.52
<b>842-4LSQ</b>	4" MIP - 7" Sqr Ring & Strainer	Bl	1	1	\$112.20
842-4LSR	4" MIP - 6-1/2" Rnd Ring & Strainer	Bl	1	10	\$75.99
<b>GRAY ABS STRAINER</b>					
842-2LP	2" MIP - 4-3/8" Rnd Ring & Strainer	Bl	1	10	\$28.96
<b>842-36LP</b>	3" MIP - 6-1/2" Rnd Ring & Strainer	Bl	1	1	\$36.19
842-3LP	3" MIP - 5-1/2" Rnd Ring & Strainer	Bl	1	10	\$32.58
842-4LP	4" MIP - 6-1/2" Rnd Ring & Strainer	Bl	1	10	\$39.82



842-2LNQ



842-36LP



863-FNO

### Adjustable Floor Drain Head (Cont)

#### ABS - MIP Thread Connection

Item Number	Item Description	Pkg Type	Min Qty	Case Qty	Price
<b>ACCESSORIES</b>					
832-UM	4-1/4" Stainless Steel Debris Basket	BI	1	15	\$21.43
863-FA	Round Aluminum Condensate Funnel w/ Screws	BI	1	12	\$49.15
863-FN	Round Nikl-Brnz Condensate Funnel w/ Screws	BI	1	12	\$109.99
863-FNO	Oval Nikl-Brnz Condensate Funnel w/ Screws	BI	1	12	\$243.96

### Non-Adjustable Floor Drain

#### PVC/ABS - Sch. 40 Hub Connection

**Options:** Add suffix to item no. Add price to list  
 V = Vandal-Resistant Strainer: \$6.50;



843-2PNR



843-2PS



843-2PP

Item Number	Item Description	Pkg Type	Min Qty	Case Qty	Price
<b>NICKEL-BRONZE RING &amp; STRAINER</b>					
<b>843-2ANQ</b>	2" ABS Hub - 4-1/2" Sqr Ring & Strainer	BI	1	1	\$68.76
843-2ANR	2" ABS Hub - 4-1/2" Rnd Ring & Strainer	BI	1	10	\$54.29
843-2PNQ	2" PVC Hub - 4-1/2" Sqr Ring & Strainer	BI	1	5	\$68.76
843-2PNR	2" PVC Hub - 4-1/2" Rnd Ring & Strainer	BI	1	10	\$54.29
843-3ANQ	3" ABS Hub - 5-7/8" Sqr Ring & Strainer	BI	1	10	\$85.04
<b>843-3ANR</b>	3" ABS Hub - 5-1/2" Rnd Ring & Strainer	BI	1	1	\$63.33
843-3PNQ	3" PVC Hub - 5-7/8" Sqr Ring & Strainer	BI	1	10	\$85.04
843-3PNR	3" PVC Hub - 5-1/2" Rnd Ring & Strainer	BI	1	10	\$63.33
<b>843-4ANQ</b>	4" ABS Hub - 7" Sqr Ring & Strainer	BI	1	1	\$114.37
<b>843-4ANR</b>	4" ABS Hub - 6-1/2" Rnd Ring & Strainer	BI	1	4	\$78.17
843-4PNQ	4" PVC Hub - 7" Sqr Ring & Strainer	BI	1	10	\$114.37
843-4PNR	4" PVC Hub - 6-1/2" Rnd Ring & Strainer	BI	1	4	\$78.17
<b>18-GA STAINLESS STEEL STRAINER</b>					
843-2AS	2" ABS Hub - 4-1/2" Rnd Ring & Strainer	BI	1	10	\$26.21
843-2PS	2" PVC Hub - 4-1/2" Rnd Ring & Strainer	BI	1	10	\$26.21
<b>843-3AS</b>	3" ABS Hub - 5-1/2" Rnd Ring & Strainer	BI	1	1	\$28.06
843-3PS	3" PVC Hub - 5-1/2" Rnd Ring & Strainer	BI	1	10	\$28.06
<b>843-4AS</b>	4" ABS Hub - 6-1/2" Rnd Ring & Strainer	BI	1	1	\$35.94
843-4PS	4" PVC Hub - 6-1/2" Rnd Ring & Strainer	BI	1	4	\$35.94
<b>ABS STRAINER</b>					
<b>843-2AP</b>	2" ABS Hub - 4-1/2" Rnd Ring & Strainer	BI	1	1	\$25.34
843-2PP	2" PVC Hub - 4-1/2" Rnd Ring & Strainer	BI	1	1	\$25.34
843-3AP	3" ABS Hub - 5-1/2" Rnd Ring & Strainer	BI	1	10	\$27.13
843-3PP	3" PVC Hub - 5-1/2" Rnd Ring & Strainer	BI	1	10	\$27.13
<b>843-4PP</b>	4" PVC Hub - 6-1/2" Rnd Ring & Strainer	BI	1	1	\$41.98

**PVC/ABS - Sch. 40 Hub Connection**

**Options:** Add suffix to item no. Add price to list

- N** = Nickel-Bronze Veneer (1): \$120.25; **S** = ABS Sand Bucket: \$14.00;
- U** = ABS Debris Bucket: \$14.00; **C** = ABS Clamping Collar: \$17.00;
- V** = Vandal-Resistant Strainer (2): \$12.00; **T** = Tapped Trap Primer Connection - 1/2" FIP: \$12.00;
- 2** = Open-Half Strainer (2); **N/C**; **W** = Stainless Steel Debris Basket: \$52.00;
- F** = Round Nickel-Bronze Condensate Funnel: \$108.00; **FA** = Round Aluminum Condensate Funnel: \$48.00;
- FO** = Oval Nickel-Bronze Condensate Funnel: \$238.00; **6** = ABS Flat Strainer for Drain Outlet (3): \$12.00;
- D** = ABS Dome Bottom Strainer (3): \$10.00; **J** = Solid PVC Cover with Lift Handle (4): \$45.00;
- L** = Aluminum Dome Bottom Strainer (3): \$22.00;

1: For drains with cast iron strainers only 2: Not available for cast iron strainers 3: Not available for 6" drains 4: For sinks with NO strainer only

Item Number	Item Description	Pkg Type	Min Qty	Case Qty	Price
<b>NICKEL-BRONZE RING &amp; STRAINER</b>					
860-2AN	2" ABS Hub - 9-3/4" Rnd Grate	BI	1	1	\$343.80
860-2PN	2" PVC Hub - 9-3/4" Rnd Grate	BI	1	1	\$343.80
860-3AN	3" ABS Hub - 9-3/4" Rnd Grate	BI	1	1	\$343.80
860-3PN	3" PVC Hub - 9-3/4" Rnd Grate	BI	1	4	\$343.80
860-4AN	4" ABS Hub - 9-3/4" Rnd Grate	BI	1	1	\$343.80
860-4PN	4" PVC Hub - 9-3/4" Rnd Grate	BI	1	4	\$343.80
860-6AN	6" ABS Hub - 9-3/4" Rnd Grate	BI	1	1	\$463.24
860-6PN	6" PVC Hub - 9-3/4" Rnd Grate	BI	1	1	\$463.24
<b>STAINLESS STEEL RING &amp; STRAINER</b>					
860-2AZ	2" ABS Hub - 9-3/4" Rnd Grate	BI	1	1	\$343.80
860-2PZ	2" PVC Hub - 9-3/4" Rnd Grate	BI	1	4	\$343.80
860-3AZ	3" ABS Hub - 9-3/4" Rnd Grate	BI	1	1	\$343.80
860-3PZ	3" PVC Hub - 9-3/4" Rnd Grate	BI	1	4	\$343.80
860-4AZ	4" ABS Hub - 9-3/4" Rnd Grate	BI	1	4	\$343.80
860-4PZ	4" PVC Hub - 9-3/4" Rnd Grate	BI	1	4	\$343.80
860-6AZ	6" ABS Hub - 9-3/4" Rnd Grate	BI	1	1	\$463.24
860-6PZ	6" PVC Hub - 9-3/4" Rnd Grate	BI	1	1	\$463.24
<b>ABS STRAINER</b>					
860-2A	2" ABS Hub - 9" Rnd Grate	BI	1	1	\$83.25
860-2P	2" PVC Hub - 9" Rnd Grate	BI	1	4	\$83.25
860-3A	3" ABS Hub - 9" Rnd Grate	BI	1	4	\$83.25
860-3P	3" PVC Hub - 9" Rnd Grate	BI	1	4	\$83.25
860-4A	4" ABS Hub - 9" Rnd Grate	BI	1	1	\$83.25
860-4P	4" PVC Hub - 9" Rnd Grate	BI	1	4	\$83.25
860-6A	6" ABS Hub - 9" Rnd Grate	BI	1	1	\$202.66
860-6P	6" PVC Hub - 9" Rnd Grate	BI	1	1	\$202.66
<b>CAST IRON RING &amp; STRAINER</b>					
860-2AI	2" ABS Hub - 9-7/8" Rnd Grate	BI	1	1	\$155.13
860-2PI	2" PVC Hub - 9-7/8" Rnd Grate	BI	1	1	\$155.13
860-3AI	3" ABS Hub - 9-7/8" Rnd Grate	BI	1	2	\$155.13
860-3PI	3" PVC Hub - 9-7/8" Rnd Grate	BI	1	2	\$155.13
860-4AI	4" ABS Hub - 9-7/8" Rnd Grate	BI	1	1	\$155.13
860-4PI	4" PVC Hub - 9-7/8" Rnd Grate	BI	1	2	\$155.13
860-6AI	6" ABS Hub - 9-7/8" Rnd Grate	BI	1	1	\$279.98
860-6PI	6" PVC Hub - 9-7/8" Rnd Grate	BI	1	2	\$279.98



860-3PN



860-2AZ



860-2P



860-2PI

Supply

Drainage

Support

Specialties

Appendix

Supply

Drainage

Support

Specialties

Appendix



860-GP



860-S



860-D



864-2P



864-GP

FatMax™ Floor Drain Accessories

Item Number	Item Description	Pkg Type	Min Qty	Case Qty	Price
<b>STRAINERS</b>					
860-GA	ABS Full Strainer w/ Lift Handle	BI	1	12	\$36.19
<b>860-GA2</b>	ABS Open-Half Strainer	BI	1	1	\$24.38
860-GI	Cast Iron Full Strainer Only	BI	1	5	\$87.22
860-GN	Nckl-Brnz Full Strainer Only	BI	1	1	\$207.41
<b>860-GN2</b>	Nickl-Brnz Open-Half Strainer Only	BI	1	1	\$147.86
860-GP	PVC Full Strainer w/ Lift Handle	BI	1	16	\$36.19
860-GP2	PVC Open-Half Strainer	BI	1	10	\$24.38
860-GPJ	PVC Full Cover	BI	1	16	\$43.43
860-RGN	Nckl-Brnz Ring And Full Strainer	BI	1	1	\$305.00
860-RGN2	Nickl-Brnz Ring And Open-Half Strainer	BI	1	1	\$305.00
860-RGS	304 Stnls Steel Ring And Full Strainer	BI	1	1	\$305.00
860-RGS2	304 Stnls Steel Ring And Open-Half Strainer	BI	1	1	\$305.00
<b>ACCESSORIES</b>					
860-6	Flat Secondary Strainer - Gray ABS	BI	1	10	\$11.58
860-C	Clamping Collar w/ Screws - Gray ABS	BI	1	10	\$14.85
<b>860-CI</b>	Cast Iron Clamping Collar w/ Stainless Steel Screws	BI	1	10	\$26.93
860-D	Dome Bottom Strainer - Gray ABS	BI	1	80	\$9.42
860-S	Sand Bucket For Drain Sump Area - Gray ABS	BI	1	20	\$14.10
860-U	Debris Bucket For Drain Sump Area - Gray ABS	BI	1	20	\$14.10
860-UM	Stainless Steel Debris Basket	BI	1	5	\$53.08

LittleMax™ General Purpose Floor Drain

Options: Add suffix to item no. Add price to list

V = Vandal-Resistant Strainer: \$12.00; T = Tapped Trap Primer Connection - 1/2" FIP: \$8.00;

S = Sand Bucket: \$12.00; U = Stainless Steel Debris Basket for Sump Area: \$41.00;

2 = Open-Half Strainer: \$20.00; 3 = Open-Quarter Strainer: \$20.00;

X = Less Strainer: N/C;

Item Number	Item Description	Pkg Type	Min Qty	Case Qty	Price
<b>DRAINS</b>					
864-2A	2" Hub - 6-5/8" Rnd ABS Grate	BI	1	3	\$55.15
864-2P	2" Hub - 6-5/8" Rnd ABS Grate	BI	1	3	\$55.15
864-3A	3" Hub - 6-5/8" Rnd ABS Grate	BI	1	3	\$55.15
864-3P	3" Hub - 6-5/8" Rnd ABS Grate	BI	1	3	\$55.15
<b>864-4A</b>	4" Hub - 6-5/8" Rnd ABS Grate	BI	1	3	\$55.15
864-4P	4" Hub - 6-5/8" Rnd ABS Grate	BI	1	3	\$55.15
<b>ACCESSORIES</b>					
864-GP	PVC Strainer w/ Lift Handle, Loose Set	BI	1	1	\$19.99
864-S	PVC Sand Bucket (Fits Inside Sump Area)	BI	1	10	\$12.41
864-UM	Stainless Steel Mesh Debris Basket	BI	1	10	\$41.36

**PVC/ABS - Sch. 40 Hub Connection**

**6-1/2" Tops**

Options: Add suffix to item no. Add price to list

V = Vandal-Resistant Strainer: \$6.50; H = Hinged Strainer: \$16.00;

E = Extended Ring: \$78.00; B = Complies with Buy American Act: \$62.00;

Item Number	Item Description	Pkg Type	Min Qty	Case Qty	Price
<b>ROUGH-IN FIXTURE</b>					
833-2AF	2" ABS Hub	Bl	1	10	\$44.93
833-2PF	2" PVC Hub	Bl	1	10	\$44.93
833-3AF	3" ABS Hub	Bl	1	1	\$44.93
833-3PF	3" PVC Hub	Bl	1	10	\$44.93
833-4AF	4" ABS Hub	Bl	1	10	\$44.93
833-4PF	4" PVC Hub	Bl	1	10	\$44.93
<b>FINISH FIXTURE</b>					
832-4HNQ	7" Sqr Nikl-Brnz Ring & Strainer	Bl	1	10	\$96.41
832-4HNR	6-1/2" Rnd Nikl-Brnz Ring & Strainer	Bl	1	10	\$64.92
832-4HSQ	7" Sqr Stnls Steel Ring & Strainer	Bl	1	1	\$96.41
832-4HSR	6-1/2" Rnd Stnls Steel Ring & Strainer	Bl	1	10	\$64.92
<b>COMPLETE ASSEMBLY</b>					
<b>833-2ANQ</b>	2" ABS Hub - 7" Sqr Nikl-Brnz Ring & Strainer	Bl	1	1	\$140.42
833-2ANR	2" ABS Hub - 6-1/2" Rnd Nikl-Brnz Ring & Strainer	Bl	1	1	\$109.20
<b>833-2ASQ</b>	2" ABS Hub - 7" Sqr Stnls Steel Ring & Strainer	Bl	1	1	\$140.42
833-2ASR	2" ABS Hub - 6-1/2" Rnd Stnls Steel Ring & Strainer	Bl	1	1	\$109.20
833-2PNQ	2" PVC Hub - 7" Sqr Nikl-Brnz Ring & Strainer	Bl	1	1	\$140.42
833-2PNR	2" PVC Hub - 6-1/2" Rnd Nikl-Brnz Ring & Strainer	Bl	1	1	\$109.20
<b>833-2PSQ</b>	2" PVC Hub - 7" Sqr Stnls Steel Ring & Strainer	Bl	1	1	\$140.42
<b>833-2PSR</b>	2" PVC Hub - 6-1/2" Rnd Stnls Steel Ring & Strainer	Bl	1	1	\$109.20
<b>833-3ANQ</b>	3" ABS Hub - 7" Sqr Nikl-Brnz Ring & Strainer	Bl	1	1	\$140.42
833-3ANR	3" ABS Hub - 6-1/2" Rnd Nikl-Brnz Ring & Strainer	Bl	1	1	\$109.20
<b>833-3ASQ</b>	3" ABS Hub - 7" Sqr Stnls Steel Ring & Strainer	Bl	1	1	\$140.42
833-3ASR	3" ABS Hub - 6-1/2" Rnd Stnls Steel Ring & Strainer	Bl	1	1	\$109.20
833-3PNQ	3" PVC Hub - 7" Sqr Nikl-Brnz Ring & Strainer	Bl	1	1	\$140.42
833-3PNR	3" PVC Hub - 6-1/2" Rnd Nikl-Brnz Ring & Strainer	Bl	1	1	\$109.20
<b>833-3PSQ</b>	3" PVC Hub - 7" Sqr Stnls Steel Ring & Strainer	Bl	1	1	\$140.42
<b>833-3PSR</b>	3" PVC Hub - 6-1/2" Rnd Stnls Steel Ring & Strainer	Bl	1	1	\$109.20
<b>833-4ANQ</b>	4" ABS Hub - 7" Sqr Nikl-Brnz Ring & Strainer	Bl	1	1	\$140.42
833-4ANR	4" ABS Hub - 6-1/2" Rnd Nikl-Brnz Ring & Strainer	Bl	1	1	\$109.20
<b>833-4ASQ</b>	4" ABS Hub - 7" Sqr Stnls Steel Ring & Strainer	Bl	1	1	\$140.42
<b>833-4ASR</b>	4" ABS Hub - 6-1/2" Rnd Stnls Steel Ring & Strainer	Bl	1	1	\$109.20
833-4PNQ	4" PVC Hub - 7" Sqr Nikl-Brnz Ring & Strainer	Bl	1	1	\$140.42
833-4PNR	4" PVC Hub - 6-1/2" Rnd Nikl-Brnz Ring & Strainer	Bl	1	1	\$109.20
<b>833-4PSQ</b>	4" PVC Hub - 7" Sqr Stnls Steel Ring & Strainer	Bl	1	1	\$140.42
833-4PSR	4" PVC Hub - 6-1/2" Rnd Stnls Steel Ring & Strainer	Bl	1	1	\$109.20



833-3PF



832-4HNQ



833-2PSR

Supply

Drainage

Support

Specialties

Appendix



832-P

**PVC/ABS - Sch. 40 Hub Connection (Cont)**

**6-1/2" Tops**

Item Number	Item Description	Pkg Type	Min Qty	Case Qty	Price
<b>ACCESSORIES</b>					
832-4HHD	Hub Drain Finish Fixture for 6-1/2" Top	BI	1	10	\$18.91
832-4HPR	Finish Fixture with 6-1/2" Rnd ABS Ring & Strainer	BI	1	10	\$34.63
832-EX4	Ductile Iron Extension Adapter - 2" Min - 4" Max	BI	1	1	\$34.14
832-P	Coring Plug Wrench	BI	1	1	\$24.65
832-S4	Two Adjustment Shims, Two 3/4" Screws	BI	1	10	\$6.10
832-UM	4-1/4" Stainless Steel Debris Basket	BI	1	15	\$21.43
832-W	Flexible Red Locating Bristles w/ Screw	BI	1	10	\$7.26
835-2	Trapshield™ For 2" Drain Outlet	BI	1	50	\$56.31
835-3	Trapshield™ For 3" Drain Outlet	BI	1	25	\$63.36
835-4	Trapshield™ For 4" Drain Outlet	BI	1	20	\$74.98
863-FA	Round Aluminum Condensate Funnel w/ Screws	BI	1	12	\$49.15
863-FN	Round Nikl-Brnz Condensate Funnel w/ Screws	BI	1	12	\$109.99
863-FNO	Oval Nikl-Brnz Condensate Funnel w/ Screws	BI	1	12	\$243.96



833-25PF



832-3HNQ

**PVC/ABS - Sch. 40 Hub Connection**

**5-1/2" Tops**

· Cast iron base adapter with ABS clamping collar, coring sleeve, and head adapter.

**Options:** Add suffix to item no. Add price to list

**V** = Vandal-Resistant Strainer: \$6.50; **B** = Complies with Buy American Act (1): \$62.00;

**E** = Extended Ring (1): \$78.00;

1: For round nickel bronze ring/strainer only

Item Number	Item Description	Pkg Type	Min Qty	Case Qty	Price
<b>ROUGH-IN FIXTURE</b>					
<b>833-25AF</b>	2" ABS Hub	BI	1	1	\$39.35
833-25PF	2" PVC Hub	BI	1	1	\$39.35
<b>833-35AF</b>	3" ABS Hub	BI	1	1	\$39.35
833-35PF	3" PVC Hub	BI	1	1	\$39.35
<b>FINISH FIXTURE</b>					
832-3HNQ	5-7/8" Sqr Nikl-Brnz Ring & Strainer	BI	1	10	\$65.56
832-3HNR	5-1/2" Rnd Nikl-Brnz Ring & Strainer	BI	1	10	\$46.64
832-3HSQ	5-7/8" Sqr Stnls Steel Ring & Strainer	BI	1	10	\$65.56
832-3HSR	5-1/2" Rnd Stnls Steel Ring & Strainer	BI	1	10	\$46.64

**PVC/ABS - Sch. 40 Hub Connection (Cont)**

**5-1/2" Tops**

Item Number	Item Description	Pkg Type	Min Qty	Case Qty	Price
<b>COMPLETE ASSEMBLY</b>					
833-25ANQ	2" ABS Hub - 5-7/8" Sqr Nikl-Brnz Ring & Strainer	Bl	1	1	\$109.18
833-25ANR	2" ABS Hub - 5-1/2" Rnd Nikl-Brnz Ring & Strainer	Bl	1	1	\$89.58
833-25ASQ	2" ABS Hub - 5-7/8" Sqr Stnls Steel Ring & Strainer	Bl	1	1	\$109.18
833-25ASR	2" ABS Hub - 5-1/2" Rnd Stnls Steel Ring & Strainer	Bl	1	1	\$89.58
833-25PNQ	2" PVC Hub - 5-7/8" Sqr Nikl-Brnz Ring & Strainer	Bl	1	1	\$104.22
833-25PNR	2" PVC Hub - 5-1/2" Rnd Nikl-Brnz Ring & Strainer	Bl	1	1	\$85.51
833-25PSQ	2" PVC Hub - 5-7/8" Sqr Stnls Steel Ring & Strainer	Bl	1	1	\$104.22
833-25PSR	2" PVC Hub - 5-1/2" Rnd Stnls Steel Ring & Strainer	Bl	1	1	\$85.51
833-35ANQ	3" ABS Hub - 5-7/8" Sqr Nikl-Brnz Ring & Strainer	Bl	1	1	\$104.22
833-35ANR	3" ABS Hub - 5-1/2" Rnd Nikl-Brnz Ring & Strainer	Bl	1	1	\$85.51
833-35ASQ	3" ABS Hub - 5-7/8" Sqr Stnls Steel Ring & Strainer	Bl	1	1	\$104.22
833-35ASR	3" ABS Hub - 5-1/2" Rnd Stnls Steel Ring & Strainer	Bl	1	1	\$85.51
833-35PNQ	3" PVC Hub - 5-7/8" Sqr Nikl-Brnz Ring & Strainer	Bl	1	1	\$104.22
833-35PNR	3" PVC Hub - 5-1/2" Rnd Nikl-Brnz Ring & Strainer	Bl	1	1	\$85.51
833-35PSQ	3" PVC Hub - 5-7/8" Sqr Stnls Steel Ring & Strainer	Bl	1	1	\$104.22
833-35PSR	3" PVC Hub - 5-1/2" Rnd Stnls Steel Ring & Strainer	Bl	1	1	\$85.51
<b>ACCESSORIES</b>					
832-3HHD	Hub Drain Finish Fixture for 5-1/2" Top	Bl	1	10	\$15.64
832-3HS	Finish Fixture with Rnd 5-1/2" 18-Ga Stnls Steel Strainer	Bl	1	10	\$19.80
832-EPS3	Extended ABS Coring Sleeve & Plug	Bl	1	1	\$15.82
832-EX3	Ductile Iron Extension Adapter - 2" Min - 3-3/8" Max	Bl	1	1	\$34.14
832-P	Coring Plug Wrench	Bl	1	1	\$24.65
832-S3	Two Adjustment Shims, Two 3/4" Screws	Bl	1	10	\$6.10
832-W	Flexible Red Locating Bristles w/ Screw	Bl	1	10	\$7.26
835-2	Trapshield™ For 2" Drain Outlet	Bl	1	50	\$56.31
835-3	Trapshield™ For 3" Drain Outlet	Bl	1	25	\$63.36
863-FA	Round Aluminum Condensate Funnel w/ Screws	Bl	1	12	\$49.15
863-FN	Round Nikl-Brnz Condensate Funnel w/ Screws	Bl	1	12	\$109.99
863-FNO	Oval Nikl-Brnz Condensate Funnel w/ Screws	Bl	1	12	\$243.96



833-35ANR



832-EPS3

Supply

Drainage

Support

Specialties

Appendix



833-22F



832-4HNQ



833-22NR

## ABS on Iron - No-Hub Connection

### 6-1/2" Tops

· Cast iron base adapter with ABS clamping collar, coring sleeve, and head adapter.

**Options:** Add suffix to item no. Add price to list

**V** = Vandal-Resistant Strainer: \$6.50; **H** = Hinged Strainer: \$16.00;

**E** = Extended Ring (1): \$78.00; **B** = Complies with Buy American Act (1): \$62.00;

1: For round nickel-bronze ring/strainer only

Item Number	Item Description	Pkg Type	Min Qty	Case Qty	Price
<b>ROUGH-IN FIXTURE</b>					
833-22F	2" No-Hub	BI	1	1	\$66.18
833-23F	3" No-Hub	BI	1	1	\$66.18
833-24F	4" No-Hub	BI	1	1	\$66.18
<b>FINISH FIXTURE</b>					
832-4HNQ	7" Sqr Nikl-Brmz Ring & Strainer	BI	1	10	\$96.41
832-4HNR	6-1/2" Rnd Nikl-Brmz Ring & Strainer	BI	1	10	\$64.92
832-4HSQ	7" Sqr Stnls Steel Ring & Strainer	BI	1	1	\$96.41
832-4HSR	6-1/2" Rnd Stnls Steel Ring & Strainer	BI	1	10	\$64.92
<b>COMPLETE ASSEMBLY</b>					
<b>833-22NQ</b>	2" No-Hub - 7" Sqr Nikl-Brmz Ring & Strainer	BI	1	1	\$175.70
833-22NR	2" No-Hub - 6-1/2" Rnd Nikl-Brmz Ring & Strainer	BI	1	1	\$140.08
<b>833-22SQ</b>	2" No-Hub - 7" Sqr Stnls Steel Ring & Strainer	BI	1	1	\$175.70
833-22SR	2" No-Hub - 6-1/2" Rnd Stnls Steel Ring & Strainer	BI	1	1	\$140.08
<b>833-23NQ</b>	3" No-Hub - 7" Sqr Nikl-Brmz Ring & Strainer	BI	1	1	\$175.70
833-23NR	3" No-Hub - 6-1/2" Rnd Nikl-Brmz Ring & Strainer	BI	1	1	\$140.08
<b>833-23SQ</b>	3" No-Hub - 7" Sqr Stnls Steel Ring & Strainer	BI	1	1	\$175.70
833-23SR	3" No-Hub - 6-1/2" Rnd Stnls Steel Ring & Strainer	BI	1	1	\$140.08
<b>833-24NQ</b>	4" No-Hub - 7" Sqr Nikl-Brmz Ring & Strainer	BI	1	1	\$175.70
833-24NR	4" No-Hub - 6-1/2" Rnd Nikl-Brmz Ring & Strainer	BI	1	1	\$140.08
<b>833-24SQ</b>	4" No-Hub - 7" Sqr Stnls Steel Ring & Strainer	BI	1	1	\$175.70
<b>833-24SR</b>	4" No-Hub - 6-1/2" Rnd Stnls Steel Ring & Strainer	BI	1	1	\$140.08

**ABS on Iron - No-Hub Connection (Cont)**

**6-1/2" Tops**

Item Number	Item Description	Pkg Type	Min Qty	Case Qty	Price
<b>ACCESSORIES</b>					
832-4HHD	Hub Drain Finish Fixture for 6-1/2" Top	Bl	1	10	\$18.91
832-4HPR	Finish Fixture with 6-1/2" Rnd ABS Ring & Strainer	Bl	1	10	\$34.63
832-EX4	Ductile Iron Extension Adapter - 2" Min - 4" Max	Bl	1	1	\$34.14
832-P	Coring Plug Wrench	Bl	1	1	\$24.65
832-S4	Two Adjustment Shims, Two 3/4" Screws	Bl	1	10	\$6.10
832-UM	4-1/4" Stainless Steel Debris Basket	Bl	1	15	\$21.43
832-W	Flexible Red Locating Bristles w/ Screw	Bl	1	10	\$7.26
835-2	Trapshield™ For 2" Drain Outlet	Bl	1	50	\$56.31
835-3	Trapshield™ For 3" Drain Outlet	Bl	1	25	\$63.36
835-4	Trapshield™ For 4" Drain Outlet	Bl	1	20	\$74.98
863-FA	Round Aluminum Condensate Funnel w/ Screws	Bl	1	12	\$49.15
863-FN	Round Nikl-Brnz Condensate Funnel w/ Screws	Bl	1	12	\$109.99
863-FNO	Oval Nikl-Brnz Condensate Funnel w/ Screws	Bl	1	12	\$243.96



832-4HHD

**ABS on Iron - No-Hub Connection**

**5-1/2" Tops**

**Options:** Add suffix to item no. Add price to list

**V** = Vandal-Resistant Strainer: \$6.50; **B** = Complies with Buy American Act (1): \$62.00;

**E** = Extended Ring (2): \$78.00;

1: For round nickel-bronzed ring/strainer only 2: For round nickel-bronze ring/strainer only

Item Number	Item Description	Pkg Type	Min Qty	Case Qty	Price
<b>ROUGH-IN FIXTURE</b>					
833-225F	2" No-Hub	Bl	1	1	\$62.03
833-235F	3" No-Hub	Bl	1	1	\$62.03
<b>FINISH FIXTURE</b>					
832-3HNQ	5-7/8" Sqr Nikl-Brnz Ring & Strainer	Bl	1	10	\$65.56
832-3HNR	5-1/2" Rnd Nikl-Brnz Ring & Strainer	Bl	1	10	\$46.64
832-3HSQ	5-7/8" Sqr Stnls Steel Ring & Strainer	Bl	1	10	\$65.56
832-3HSR	5-1/2" Rnd Stnls Steel Ring & Strainer	Bl	1	10	\$46.64
<b>COMPLETE ASSEMBLY</b>					
833-225NQ	2" No-Hub - 5-7/8" Sqr Nikl-Brnz Ring & Strainer	Bl	1	1	\$136.82
833-225NR	2" No-Hub - 5-1/2" Rnd Nikl-Brnz Ring & Strainer	Bl	1	1	\$115.15
833-225SQ	2" No-Hub - 5-7/8" Sqr Stnls Steel Ring & Strainer	Bl	1	1	\$136.82
833-225SR	2" No-Hub - 5-1/2" Rnd Stnls Steel Ring & Strainer	Bl	1	1	\$115.15
833-235NQ	3" No-Hub - 5-7/8" Sqr Nikl-Brnz Ring & Strainer	Bl	1	1	\$136.82
833-235NR	3" No-Hub - 5-1/2" Rnd Nikl-Brnz Ring & Strainer	Bl	1	1	\$115.15
833-235SQ	3" No-Hub - 5-7/8" Sqr Stnls Steel Ring & Strainer	Bl	1	1	\$136.82
833-235SR	3" No-Hub - 5-1/2" Rnd Stnls Steel Ring & Strainer	Bl	1	1	\$115.15



833-235F



832-3HSR



833-235SR



832-S3

### ABS on Iron - No-Hub Connection (Cont)

#### 5-1/2" Tops

Item Number	Item Description	Pkg Type	Min Qty	Case Qty	Price
<b>ACCESSORIES</b>					
832-3HHD	Hub Drain Finish Fixture for 5-1/2" Top	BI	1	10	\$15.64
832-3HS	Finish Fixture with Rnd 5-1/2" 18-Ga Stnls Steel Strainer	BI	1	10	\$19.80
832-EX3	Ductile Iron Extension Adapter - 2" Min - 3-3/8" Max	BI	1	1	\$34.14
832-P	Coring Plug Wrench	BI	1	1	\$24.65
832-S3	Two Adjustment Shims, Two 3/4" Screws	BI	1	10	\$6.10
832-W	Flexible Red Locating Bristles w/ Screw	BI	1	10	\$7.26
835-2	Trapshield™ For 2" Drain Outlet	BI	1	50	\$56.31
835-3	Trapshield™ For 3" Drain Outlet	BI	1	25	\$63.36
863-FA	Round Aluminum Condensate Funnel w/ Screws	BI	1	12	\$49.15
863-FN	Round Nikl-Brnz Condensate Funnel w/ Screws	BI	1	12	\$109.99
863-FNO	Oval Nikl-Brnz Condensate Funnel w/ Screws	BI	1	12	\$243.96



833-62F



832-4HNQ

### ABS on Iron - Push-Joint Connection

#### 6-1/2" Tops

· Cast iron base adapter with ABS clamping collar, coring sleeve, and head adapter.

**Options:** Add suffix to item no. Add price to list  
**V** = Vandal-Resistant Strainer: \$6.50; **H** = Hinged Strainer: \$16.00;  
**E** = Extended Ring (1): \$78.00; **B** = Complies with Buy American Act (1): \$62.00;  
**P** = Push-Joint Gasket to Fit Sch. 40 ABS/PVC Pipe (2): \$5.00;

1: For round nickel-bronze ring/strainer only 2: For 3" & 4" drains only

Item Number	Item Description	Pkg Type	Min Qty	Case Qty	Price
<b>ROUGH-IN FIXTURE</b>					
833-62F	2" PJ Conn.	BI	1	1	\$66.18
833-63F	3" PJ Conn.	BI	1	1	\$66.18
833-64F	4" PJ Conn.	BI	1	4	\$66.18
<b>FINISH FIXTURE</b>					
832-4HNQ	7" Sqr Nikl-Brnz Ring & Strainer	BI	1	10	\$96.41
832-4HNR	6-1/2" Rnd Nikl-Brnz Ring & Strainer	BI	1	10	\$64.92
832-4HSQ	7" Sqr Stnls Steel Ring & Strainer	BI	1	1	\$96.41
832-4HSR	6-1/2" Rnd Stnls Steel Ring & Strainer	BI	1	10	\$64.92

**ABS on Iron - Push-Joint Connection (Cont)**

**6-1/2" Tops**

Item Number	Item Description	Pkg Type	Min Qty	Case Qty	Price
<b>COMPLETE ASSEMBLY</b>					
833-62NQ	2" PJ Conn. - 7" Sqr Nikl-Brnz Ring & Strainer	Bl	1	1	\$175.70
833-62NR	2" PJ Conn. - 6-1/2" Rnd Nikl-Brnz Ring & Strainer	Bl	1	1	\$140.08
833-62SQ	2" PJ Conn. - 7" Sqr Stnls Steel Ring & Strainer	Bl	1	1	\$175.70
833-62SR	2" PJ Conn. - 6-1/2" Rnd Stnls Steel Ring & Strainer	Bl	1	1	\$140.08
833-63NQ	3" PJ Conn. - 7" Sqr Nikl-Brnz Ring & Strainer	Bl	1	1	\$175.70
833-63NR	3" PJ Conn. - 6-1/2" Rnd Nikl-Brnz Ring & Strainer	Bl	1	1	\$140.08
833-63SQ	3" PJ Conn. - 7" Sqr Stnls Steel Ring & Strainer	Bl	1	1	\$175.70
833-63SR	3" PJ Conn. - 6-1/2" Rnd Stnls Steel Ring & Strainer	Bl	1	1	\$140.08
833-64NQ	4" PJ Conn. - 7" Sqr Nikl-Brnz Ring & Strainer	Bl	1	1	\$175.70
833-64NR	4" PJ Conn. - 6-1/2" Rnd Nikl-Brnz Ring & Strainer	Bl	1	1	\$140.80
833-64SQ	4" PJ Conn. - 7" Sqr Stnls Steel Ring & Strainer	Bl	1	1	\$175.70
833-64SR	4" PJ Conn. - 6-1/2" Rnd Stnls Steel Ring & Strainer	Bl	1	1	\$140.80
<b>ACCESSORIES</b>					
832-4HHD	Hub Drain Finish Fixture for 6-1/2" Top	Bl	1	10	\$18.91
832-4HPR	Finish Fixture with 6-1/2" Rnd ABS Ring & Strainer	Bl	1	10	\$34.63
832-EX4	Ductile Iron Extension Adapter - 2" Min - 4" Max	Bl	1	1	\$34.14
832-P	Coring Plug Wrench	Bl	1	1	\$24.65
832-S4	Two Adjustment Shims, Two 3/4" Screws	Bl	1	10	\$6.10
832-UM	4-1/4" Stainless Steel Debris Basket	Bl	1	15	\$21.43
832-W	Flexible Red Locating Bristles w/ Screw	Bl	1	10	\$7.26
835-2	Trapshield™ For 2" Drain Outlet	Bl	1	50	\$56.31
835-3	Trapshield™ For 3" Drain Outlet	Bl	1	25	\$63.36
835-4	Trapshield™ For 4" Drain Outlet	Bl	1	20	\$74.98
858-PG3	Push-Joint Gasket For 3" Sch. 40 Pipe	Bl	1	20	\$15.40
858-PG4	Push-Joint Gasket For 4" Sch. 40 Pipe	Bl	1	20	\$14.74
863-FA	Round Aluminum Condensate Funnel w/ Screws	Bl	1	12	\$49.15
863-FN	Round Nikl-Brnz Condensate Funnel w/ Screws	Bl	1	12	\$109.99
863-FNO	Oval Nikl-Brnz Condensate Funnel w/ Screws	Bl	1	12	\$243.96



833-62NR



832-4HHD

Supply

Drainage

Support

Specialties

Appendix



833-625F



832-3HNR



833-625NQ



832-W

## ABS on Iron - Push-Joint Connection

### 5-1/2" Tops

· Cast iron base adapter with ABS clamping collar, coring sleeve, and head adapter.

**Options:** Add suffix to item no. Add price to list

**V** = Vandal-Resistant Strainer: \$6.50; **B** = Complies with Buy American Act (1): \$62.00;

**E** = Extended Ring (1): \$78.00; **P** = Push-Joint Gasket to Fit Sch. 40 ABS/PVC Pipe (2): \$5.00;

1: For round nickel-bronze ring/strainer only 2: For 3" drains only

Item Number	Item Description	Pkg Type	Min Qty	Case Qty	Price
<b>ROUGH-IN FIXTURE</b>					
833-625F	2" PJ Conn.	BI	1	1	\$62.03
833-635F	3" PJ Conn.	BI	1	1	\$62.03
<b>FINISH FIXTURE</b>					
832-3HNQ	5-7/8" Sqr Nikl-Brnz Ring & Strainer	BI	1	10	\$65.56
832-3HNR	5-1/2" Rnd Nikl-Brnz Ring & Strainer	BI	1	10	\$46.64
832-3HSQ	5-7/8" Sqr Stnls Steel Ring & Strainer	BI	1	10	\$65.56
832-3HSR	5-1/2" Rnd Stnls Steel Ring & Strainer	BI	1	10	\$46.64
<b>COMPLETE ASSEMBLY</b>					
833-625NQ	2" PJ Conn. - 5-7/8" Sqr Nikl-Brnz Ring & Strainer	BI	1	1	\$136.82
833-625NR	2" PJ Conn. - 5-1/2" Rnd Nikl-Brnz Ring & Strainer	BI	1	1	\$115.15
833-625SQ	2" PJ Conn. - 5-7/8" Sqr Stnls Steel Ring & Strainer	BI	1	1	\$136.82
833-625SR	2" PJ Conn. - 5-1/2" Rnd Stnls Steel Ring & Strainer	BI	1	1	\$115.15
833-635NQ	3" PJ Conn. - 5-7/8" Sqr Nikl-Brnz Ring & Strainer	BI	1	1	\$136.82
833-635NR	3" PJ Conn. - 5-1/2" Rnd Nikl-Brnz Ring & Strainer	BI	1	1	\$115.15
833-635SQ	3" PJ Conn. - 5-7/8" Sqr Stnls Steel Ring & Strainer	BI	1	1	\$136.82
833-635SR	3" PJ Conn. - 5-1/2" Rnd Stnls Steel Ring & Strainer	BI	1	1	\$115.15
<b>ACCESSORIES</b>					
832-3HHD	Hub Drain Finish Fixture for 5-1/2" Top	BI	1	10	\$15.64
832-3HS	Finish Fixture with Rnd 5-1/2" 18-Ga Stnls Steel Strainer	BI	1	10	\$19.80
832-EX3	Ductile Iron Extension Adapter - 2" Min - 3-3/8" Max	BI	1	1	\$34.14
832-P	Coring Plug Wrench	BI	1	1	\$24.65
832-S3	Two Adjustment Shims, Two 3/4" Screws	BI	1	10	\$6.10
832-W	Flexible Red Locating Bristles w/ Screw	BI	1	10	\$7.26
835-2	Trapshield™ For 2" Drain Outlet	BI	1	50	\$56.31
835-3	Trapshield™ For 3" Drain Outlet	BI	1	25	\$63.36
858-PG3	Push-Joint Gasket For 3" Sch. 40 Pipe	BI	1	20	\$15.40
863-FA	Round Aluminum Condensate Funnel w/ Screws	BI	1	12	\$49.15
863-FN	Round Nikl-Brnz Condensate Funnel w/ Screws	BI	1	12	\$109.99
863-FNO	Oval Nikl-Brnz Condensate Funnel w/ Screws	BI	1	12	\$243.96

**PVC/ABS - Sch. 40 Hub Connection**

**6-1/2" Tops**

**Options:** Add suffix to item no. Add price to list

**V** = Vandal-Resistant Strainer: \$6.50; **H** = Hinged Strainer: \$16.00;

**Y** = Ductile Iron Head Adapter (1): \$26.00; **D** = Ductile Iron Clamping Collar (1): \$26.00;

**T** = Tapped Trap Primer Connection - 1/2" FIP: \$12.00; **E** = Extended Ring (2): \$78.00;

**B** = Complies with Buy American Act (2): \$62.00; **M** = Medium-Duty Strainer (3,000 lbs. safe-load) (3): \$39.00;

1: In lieu of ABS (standard) 2: For round nickel-bronze ring/strainer only 3: For round 304 SS ring/strainer only



863-42NR



863-42NQ

Item Number	Item Description	Pkg Type	Min Qty	Case Qty	Price
<b>NICKEL-BRONZE RING &amp; STRAINER</b>					
863-32NQ	2" ABS Hub - 7" Sqr Ring & Strainer	Bl	1	2	\$142.95
863-32NR	2" ABS Hub - 6-1/2" Rnd Ring & Strainer	Bl	1	6	\$106.77
863-33NQ	3" ABS Hub - 7" Sqr Ring & Strainer	Bl	1	1	\$142.95
863-33NR	3" ABS Hub - 6-1/2" Rnd Ring & Strainer	Bl	1	6	\$106.77
863-34NQ	4" ABS Hub - 7" Sqr Ring & Strainer	Bl	1	2	\$142.95
863-34NR	4" ABS Hub - 6-1/2" Rnd Ring & Strainer	Bl	1	6	\$106.77
863-42NQ	2" PVC Hub - 7" Sqr Ring & Strainer	Bl	1	2	\$142.95
863-42NR	2" PVC Hub - 6-1/2" Rnd Ring & Strainer	Bl	1	6	\$106.77
863-43NQ	3" PVC Hub - 7" Sqr Ring & Strainer	Bl	1	2	\$142.95
863-43NR	3" PVC Hub - 6-1/2" Rnd Ring & Strainer	Bl	1	6	\$106.77
863-44NQ	4" PVC Hub - 7" Sqr Ring & Strainer	Bl	1	2	\$142.95
863-44NR	4" PVC Hub - 6-1/2" Rnd Ring & Strainer	Bl	1	6	\$106.77
<b>STAINLESS STEEL RING &amp; STRAINER</b>					
863-32SQ	2" ABS Hub - 7" Sqr Ring & Strainer	Bl	1	2	\$142.95
863-32SR	2" ABS Hub - 6-1/2" Rnd Ring & Strainer	Bl	1	6	\$106.77
863-33SQ	3" ABS Hub - 7" Sqr Ring & Strainer	Bl	1	2	\$142.95
863-33SR	3" ABS Hub - 6-1/2" Rnd Ring & Strainer	Bl	1	6	\$106.77
863-34SQ	4" ABS Hub - 7" Sqr Ring & Strainer	Bl	1	2	\$142.95
863-34SR	4" ABS Hub - 6-1/2" Rnd Ring & Strainer	Bl	1	6	\$106.77
863-42SQ	2" PVC Hub - 7" Sqr Ring & Strainer	Bl	1	1	\$142.95
863-42SR	2" PVC Hub - 6-1/2" Rnd Ring & Strainer	Bl	1	6	\$106.77
863-43SQ	3" PVC Hub - 7" Sqr Ring & Strainer	Bl	1	1	\$142.95
863-43SR	3" PVC Hub - 6-1/2" Rnd Ring & Strainer	Bl	1	1	\$106.77
863-44SQ	4" PVC Hub - 7" Sqr Ring & Strainer	Bl	1	1	\$142.95
863-44SR	4" PVC Hub - 6-1/2" Rnd Ring & Strainer	Bl	1	1	\$106.77
<b>ACCESSORIES</b>					
835-2	Trapshield™ For 2" Drain Outlet	Bl	1	50	\$56.31
835-3	Trapshield™ For 3" Drain Outlet	Bl	1	25	\$63.36
835-35	Trapshield™ For 3-1/2" Drain Head	Bl	1	25	\$63.36
835-4	Trapshield™ For 4" Drain Outlet	Bl	1	20	\$74.98
842-UM	4-5/8" Stainless Steel Debris Basket	Bl	1	1	\$21.67
863-FA	Round Aluminum Condensate Funnel w/ Screws	Bl	1	12	\$49.15
863-FN	Round Nikl-Brnz Condensate Funnel w/ Screws	Bl	1	12	\$109.99
863-FNO	Oval Nikl-Brnz Condensate Funnel w/ Screws	Bl	1	12	\$243.96

Supply

Drainage

Support

Specialties

Appendix



863-435NQ



863-425SQ

## PVC/ABS - Sch. 40 Hub Connection

### 5-1/2" Tops

**Options:** Add suffix to item no. Add price to list

**V** = Vandal-Resistant Strainer: \$6.50; **Y** = Ductile Iron Head Adapter (1): \$26.00;

**D** = Ductile Iron Clamping Collar (1): \$26.00; **T** = Tapped Trap Primer Connection - 1/2" FIP: \$12.00;

**E** = Extended Ring (2): \$78.00; **B** = Complies with Buy American Act (2): \$62.00;

1: In lieu of ABS (standard) 2: For round nickel-bronze ring/strainer only

Item Number	Item Description	Pkg Type	Min Qty	Case Qty	Price
<b>NICKEL-BRONZE RING &amp; STRAINER</b>					
863-325NQ	2" ABS Hub - 5-7/8" Sqr Ring & Strainer	BI	1	2	\$112.20
863-325NR	2" ABS Hub - 5-1/2" Rnd Ring & Strainer	BI	1	6	\$90.48
<b>863-335NQ</b>	3" ABS Hub - 5-7/8" Sqr Ring & Strainer	BI	1	2	\$111.38
863-335NR	3" ABS Hub - 5-1/2" Rnd Ring & Strainer	BI	1	6	\$89.82
<b>863-345NQ</b>	4" ABS Hub - 5-7/8" Sqr Ring & Strainer	BI	1	2	\$112.20
<b>863-345NR</b>	4" ABS Hub - 5-1/2" Rnd Ring & Strainer	BI	1	6	\$90.48
863-425NQ	2" PVC Hub - 5-7/8" Sqr Ring & Strainer	BI	1	2	\$112.20
863-425NR	2" PVC Hub - 5-1/2" Rnd Ring & Strainer	BI	1	6	\$90.48
863-435NQ	3" PVC Hub - 5-7/8" Sqr Ring & Strainer	BI	1	2	\$111.38
863-435NR	3" PVC Hub - 5-1/2" Rnd Ring & Strainer	BI	1	6	\$89.82
<b>863-445NQ</b>	4" PVC Hub - 5-7/8" Sqr Ring & Strainer	BI	1	1	\$112.20
863-445NR	4" PVC Hub - 5-1/2" Rnd Ring & Strainer	BI	1	6	\$90.48
<b>STAINLESS STEEL RING &amp; STRAINER</b>					
<b>863-325SQ</b>	2" ABS Hub - 5-7/8" Sqr Ring & Strainer	BI	1	2	\$112.20
863-325SR	2" ABS Hub - 5-1/2" Rnd Ring & Strainer	BI	1	6	\$90.48
863-335SQ	3" ABS Hub - 5-7/8" Sqr Ring & Strainer	BI	1	2	\$111.38
863-335SR	3" ABS Hub - 5-1/2" Rnd Ring & Strainer	BI	1	6	\$89.82
<b>863-425SQ</b>	2" PVC Hub - 5-7/8" Sqr Ring & Strainer	BI	1	2	\$112.20
<b>863-425SR</b>	2" PVC Hub - 5-1/2" Rnd Ring & Strainer	BI	1	1	\$90.48
863-435SQ	3" PVC Hub - 5-7/8" Sqr Ring & Strainer	BI	1	2	\$111.38
863-435SR	3" PVC Hub - 5-1/2" Rnd Ring & Strainer	BI	1	6	\$89.82
<b>ACCESSORIES</b>					
822-EX3	Ductile Iron Extension Adapter	B	1	1	\$33.96
835-2	Trapshield™ For 2" Drain Outlet	BI	1	50	\$56.31
835-3	Trapshield™ For 3" Drain Outlet	BI	1	25	\$63.36
835-35	Trapshield™ For 3-1/2" Drain Head	BI	1	25	\$63.36
835-4	Trapshield™ For 4" Drain Outlet	BI	1	20	\$74.98
863-FA	Round Aluminum Condensate Funnel w/ Screws	BI	1	12	\$49.15
863-FN	Round Nikl-Brnz Condensate Funnel w/ Screws	BI	1	12	\$109.99

**ABS on Iron - No-Hub Connection**

**Options:** Add suffix to item no. Add price to list

- V** = Vandal-Resistant Strainer: \$6.50; **H** = Hinged Strainer: \$16.00;
- Y** = Ductile Iron Head Adapter (1): \$26.00; **D** = Ductile Iron Clamping Collar (1): \$26.00;
- E** = Extended Ring (2): \$78.00; **B** = Complies with Buy American Act (2): \$62.00;
- M** = Medium-Duty Strainer (3,000 lbs. safe-load) (3): \$39.00;

1: In lieu of ABS (standard) 2: For round nickel-bronze ring/strainer only 3: For round 304 SS ring/strainer only



863-24NQ



842-UM

Item Number	Item Description	Pkg Type	Min Qty	Case Qty	Price
<b>NICKEL-BRONZE RING &amp; STRAINER</b>					
863-22NQ	2" No-Hub - 7" Sqr Ring & Strainer	Bl	1	2	\$207.40
863-22NR	2" No-Hub - 6-1/2" Rnd Ring & Strainer	Bl	1	3	\$164.84
863-23NQ	3" No-Hub - 7" Sqr Ring & Strainer	Bl	1	2	\$207.40
863-23NR	3" No-Hub - 6-1/2" Rnd Ring & Strainer	Bl	1	2	\$164.84
<b>863-24NQ</b>	4" No-Hub - 7" Sqr Ring & Strainer	Bl	1	1	\$207.40
863-24NR	4" No-Hub - 6-1/2" Rnd Ring & Strainer	Bl	1	1	\$164.84
<b>STAINLESS STEEL RING &amp; STRAINER</b>					
<b>863-22SQ</b>	2" No-Hub - 7" Sqr Ring & Strainer	Bl	1	1	\$207.40
<b>863-22SR</b>	2" No-Hub - 6-1/2" Rnd Ring & Strainer	Bl	1	1	\$164.84
<b>863-23SQ</b>	3" No-Hub - 7" Sqr Ring & Strainer	Bl	1	1	\$207.40
<b>863-23SR</b>	3" No-Hub - 6-1/2" Rnd Ring & Strainer	Bl	1	1	\$164.84
<b>863-24SQ</b>	4" No-Hub - 7" Sqr Ring & Strainer	Bl	1	1	\$207.40
<b>863-24SR</b>	4" No-Hub - 6-1/2" Rnd Ring & Strainer	Bl	1	2	\$164.84
<b>ACCESSORIES</b>					
835-2	Trapshield™ For 2" Drain Outlet	Bl	1	50	\$56.31
835-3	Trapshield™ For 3" Drain Outlet	Bl	1	25	\$63.36
835-35	Trapshield™ For 3-1/2" Drain Head	Bl	1	25	\$63.36
835-4	Trapshield™ For 4" Drain Outlet	Bl	1	20	\$74.98
842-UM	4-5/8" Stainless Steel Debris Basket	Bl	1	1	\$21.67
863-FA	Round Aluminum Condensate Funnel w/ Screws	Bl	1	12	\$49.15
863-FN	Round Nikl-Brnz Condensate Funnel w/ Screws	Bl	1	12	\$109.99
863-FNO	Oval Nikl-Brnz Condensate Funnel w/ Screws	Bl	1	12	\$243.96

Supply

Drainage

Support

Specialties

Appendix



### ABS on Iron - Push-Joint Connection

**Options:** Add suffix to item no. Add price to list

**V** = Vandal-Resistant Strainer: \$6.50; **H** = Hinged Strainer: \$16.00;

**Y** = Ductile Iron Head Adapter (1): \$26.00; **D** = Ductile Iron Clamping Collar (1): \$26.00;

**E** = Extended Ring (2): \$78.00; **B** = Complies with Buy American Act (2): \$62.00;

**P** = Push-Joint Gasket to fit Sch. 40 Pipe (3): \$5.00; **M** = Medium-Duty Strainer (3,000 lbs. safe-load) (4): \$39.00;

1: In lieu of ABS (standard) 2: For round nickel-bronze ring/strainer only 3: Not available for 2" drains 4: For round 304 SS ring/strainer only

Item Number	Item Description	Pkg Type	Min Qty	Case Qty	Price
<b>NICKEL-BRONZE RING &amp; STRAINER</b>					
<b>863-62NQ</b>	2" PJ Conn. - 7" Sqr Ring & Strainer	BI	1	1	\$207.40
863-62NR	2" PJ Conn. - 6-1/2" Rnd Ring & Strainer	BI	1	3	\$164.84
<b>863-63NQ</b>	3" PJ Conn. - 7" Sqr Ring & Strainer	BI	1	1	\$207.40
863-63NR	3" PJ Conn. - 6-1/2" Rnd Ring & Strainer	BI	1	2	\$164.84
<b>863-64NQ</b>	4" PJ Conn. - 7" Sqr Ring & Strainer	BI	1	1	\$207.40
863-64NR	4" PJ Conn. - 6-1/2" Rnd Ring & Strainer	BI	1	2	\$164.84
<b>STAINLESS STEEL RING &amp; STRAINER</b>					
<b>863-62SQ</b>	2" PJ Conn. - 7" Sqr Ring & Strainer	BI	1	1	\$207.40
<b>863-62SR</b>	2" PJ Conn. - 6-1/2" Rnd Ring & Strainer	BI	1	1	\$164.84
<b>863-63SQ</b>	3" PJ Conn. - 7" Sqr Ring & Strainer	BI	1	1	\$207.40
<b>863-63SR</b>	3" PJ Conn. - 6-1/2" Rnd Ring & Strainer	BI	1	1	\$164.84
<b>863-64SQ</b>	4" PJ Conn. - 7" Sqr Ring & Strainer	BI	1	1	\$207.40
<b>863-64SR</b>	4" PJ Conn. - 6-1/2" Rnd Ring & Strainer	BI	1	1	\$164.84
<b>ACCESSORIES</b>					
835-2	Trapshield™ For 2" Drain Outlet	BI	1	50	\$56.31
835-3	Trapshield™ For 3" Drain Outlet	BI	1	25	\$63.36
835-35	Trapshield™ For 3-1/2" Drain Head	BI	1	25	\$63.36
835-4	Trapshield™ For 4" Drain Outlet	BI	1	20	\$74.98
842-UM	4-5/8" Stainless Steel Debris Basket	BI	1	1	\$21.67
863-FA	Round Aluminum Condensate Funnel w/ Screws	BI	1	12	\$49.15
863-FN	Round Nikl-Brnz Condensate Funnel w/ Screws	BI	1	12	\$109.99
863-FNO	Oval Nikl-Brnz Condensate Funnel w/ Screws	BI	1	12	\$243.96

Halo™ Floor Drains

PVC/ABS - Sch. 40 Hub Connection

Options: Add suffix to item no. Add price to list

M = Clamping Collar Kit (1): \$19.50; V = Vandal-Resistant Strainer: \$6.50;

B = Complies with Buy American Act (2): \$62.00; E = Extended Ring (2): \$78.00;

1: Add 'M' after dash - all other options at end of item no. 2: For round nickel bronze ring/strainer only

Item Number	Item Description	Pkg Type	Min Qty	Case Qty	Price
<b>NICKEL-BRONZE RING &amp; STRAINER</b>					
822-2ANQ	2" ABS Hub - 5-7/8" Sqr Ring & Strainer	Bl	1	4	\$91.73
822-2ANR	2" ABS Hub - 5-1/2" Rnd Ring & Strainer	Bl	1	4	\$72.10
822-2PNQ	2" PVC Hub - 5-7/8" Sqr Ring & Strainer	Bl	1	4	\$91.73
822-2PNR	2" PVC Hub - 5-1/2" Rnd Ring & Strainer	Bl	1	4	\$72.10
<b>822-3ANQ</b>	<b>3" ABS Hub - 5-7/8" Sqr Ring &amp; Strainer</b>	Bl	1	4	\$91.73
822-3ANR	3" ABS Hub - 5-1/2" Rnd Ring & Strainer	Bl	1	4	\$72.10
822-3PNQ	3" PVC Hub - 5-7/8" Sqr Ring & Strainer	Bl	1	4	\$91.73
822-3PNR	3" PVC Hub - 5-1/2" Rnd Ring & Strainer	Bl	1	4	\$72.10
<b>STAINLESS STEEL RING &amp; STRAINER</b>					
822-2ASQ	2" ABS Hub - 5-7/8" Sqr Ring & Strainer	Bl	1	4	\$91.73
822-2ASR	2" ABS Hub - 5-1/2" Rnd Ring & Strainer	Bl	1	4	\$72.10
822-2PSQ	2" PVC Hub - 5-7/8" Sqr Ring & Strainer	Bl	1	4	\$91.73
822-2PSR	2" PVC Hub - 5-1/2" Rnd Ring & Strainer	Bl	1	4	\$72.10
<b>822-3ASQ</b>	<b>3" ABS Hub - 5-7/8" Sqr Ring &amp; Strainer</b>	Bl	1	4	\$91.73
<b>822-3ASR</b>	<b>3" ABS Hub - 5-1/2" Rnd Ring &amp; Strainer</b>	Bl	1	1	\$72.10
822-3PSQ	3" PVC Hub - 5-7/8" Sqr Ring & Strainer	Bl	1	4	\$91.73
822-3PSR	3" PVC Hub - 5-1/2" Rnd Ring & Strainer	Bl	1	4	\$72.10
<b>18-GA STAINLESS STEEL STRAINER</b>					
822-2AS	2" ABS Hub - 5-3/8" Rnd Ring & Strainer	Bl	1	4	\$42.60
822-2PS	2" PVC Hub - 5-3/8" Rnd Ring & Strainer	Bl	1	4	\$42.60
822-3AS	3" ABS Hub - 5-3/8" Rnd Ring & Strainer	Bl	1	4	\$42.60
822-3PS	3" PVC Hub - 5-3/8" Rnd Ring & Strainer	Bl	1	4	\$42.60
<b>ACCESSORIES</b>					
822-CKIT	Clamping Collar Kit	Bl	1	10	\$20.94
822-EX3	Ductile Iron Extension Adapter	B	1	1	\$33.96
822-TB	Thread Bushing For Halo Head	Bl	1	10	\$19.66
835-2	Trapshield™ For 2" Drain Outlet	Bl	1	50	\$56.31
835-3	Trapshield™ For 3" Drain Outlet	Bl	1	25	\$63.36
835-35	Trapshield™ For 3-1/2" Drain Head	Bl	1	25	\$63.36
863-FA	Round Aluminum Condensate Funnel w/ Screws	Bl	1	12	\$49.15
863-FN	Round Nikl-Brnz Condensate Funnel w/ Screws	Bl	1	12	\$109.99
863-FNO	Oval Nikl-Brnz Condensate Funnel w/ Screws	Bl	1	12	\$243.96



822-3ANR



822-2PSQ



822-3PF



832-3HSQ



822-F2ANR

## FinishLine Halo™ Floor Drains

### PVC/ABS - Sch. 40 Hub Connection

**Options:** Add suffix to item no. Add price to list

**M** = Clamping Collar Kit (1): \$19.50; **V** = Vandal-Resistant Strainer: \$6.50;

**B** = Complies with Buy American Act (2): \$62.00; **E** = Extended Ring (2): \$78.00;

1: Add 'M' after dash - all other options at end of item no. 2: For round nickel bronze ring/strainer only

Item Number	Item Description	Pkg Type	Min Qty	Case Qty	Price
<b>ROUGH-IN FIXTURE</b>					
822-2AF	2" ABS Hub	BI	1	4	\$49.78
822-2PF	2" PVC Hub	BI	1	4	\$49.78
<b>822-3AF</b>	3" ABS Hub	BI	1	4	\$49.78
822-3PF	3" PVC Hub	BI	1	4	\$49.78
<b>FINISH FIXTURE</b>					
832-3HNQ	5-7/8" Sqr Nikl-Brnz Ring & Strainer	BI	1	10	\$65.56
832-3HNR	5-1/2" Rnd Nikl-Brnz Ring & Strainer	BI	1	10	\$46.64
832-3HSQ	5-7/8" Sqr Stnls Steel Ring & Strainer	BI	1	10	\$65.56
832-3HSR	5-1/2" Rnd Stnls Steel Ring & Strainer	BI	1	10	\$46.64
<b>COMPLETE ASSEMBLY</b>					
<b>822-F2ANQ</b>	2" ABS Hub - 5-7/8" Sqr Ring & Strainer	BI	1	1	\$117.95
822-F2ANR	2" ABS Hub - 5-1/2" Rnd Ring & Strainer	BI	1	1	\$98.30
<b>822-F2ASQ</b>	2" ABS Hub - 5-7/8" Sqr Ring & Strainer	BI	1	1	\$117.95
<b>822-F2ASR</b>	2" ABS Hub - 5-1/2" Rnd Ring & Strainer	BI	1	1	\$98.30
822-F2PNQ	2" PVC Hub - 5-7/8" Sqr Ring & Strainer	BI	1	1	\$117.95
822-F2PNR	2" PVC Hub - 5-1/2" Rnd Ring & Strainer	BI	1	1	\$98.30
822-F2PSQ	2" PVC Hub - 5-7/8" Sqr Ring & Strainer	BI	1	1	\$117.95
822-F2PSR	2" PVC Hub - 5-1/2" Rnd Ring & Strainer	BI	1	1	\$98.30
<b>822-F3ANQ</b>	3" ABS Hub - 5-7/8" Sqr Ring & Strainer	BI	1	1	\$117.95
<b>822-F3ANR</b>	3" ABS Hub - 5-1/2" Rnd Ring & Strainer	BI	1	1	\$98.30
<b>822-F3ASQ</b>	3" ABS Hub - 5-7/8" Sqr Ring & Strainer	BI	1	1	\$117.95
<b>822-F3ASR</b>	3" ABS Hub - 5-1/2" Rnd Ring & Strainer	BI	1	1	\$98.30
822-F3PNQ	3" ABS Hub - 5-7/8" Sqr Ring & Strainer	BI	1	1	\$117.95
822-F3PNR	3" ABS Hub - 5-1/2" Rnd Ring & Strainer	BI	1	1	\$98.30
<b>822-F3PSQ</b>	3" ABS Hub - 5-7/8" Sqr Ring & Strainer	BI	1	1	\$117.95
822-F3PSR	3" ABS Hub - 5-1/2" Rnd Ring & Strainer	BI	1	1	\$98.30

**FinishLine Halo™ Floor Drains (Cont)**

**PVC/ABS - Sch. 40 Hub Connection**

Item Number	Item Description	Pkg Type	Min Qty	Case Qty	Price
<b>ACCESSORIES</b>					
822-CKIT	Clamping Collar Kit	BI	1	10	\$20.94
822-EX3	Ductile Iron Extension Adapter	B	1	1	\$33.96
832-3HHD	Hub Drain Finish Fixture for 5-1/2" Top	BI	1	10	\$15.64
832-3HS	Finish Fixture with Rnd 5-1/2" 18-Ga Stnls Steel Strainer	BI	1	10	\$19.80
832-EPS3	Extended ABS Coring Sleeve & Plug	BI	1	1	\$15.82
832-EX3	Ductile Iron Extension Adapter - 2" Min - 3-3/8" Max	BI	1	1	\$34.14
832-P	Coring Plug Wrench	BI	1	1	\$24.65
832-S3	Two Adjustment Shims, Two 3/4" Screws	BI	1	10	\$6.10
832-W	Flexible Red Locating Bristles w/ Screw	BI	1	10	\$7.26
835-2	Trapshield™ For 2" Drain Outlet	BI	1	50	\$56.31
835-3	Trapshield™ For 3" Drain Outlet	BI	1	25	\$63.36
863-FA	Round Aluminum Condensate Funnel w/ Screws	BI	1	12	\$49.15
863-FN	Round Nikl-Brnz Condensate Funnel w/ Screws	BI	1	12	\$109.99
863-FNO	Oval Nikl-Brnz Condensate Funnel w/ Screws	BI	1	12	\$243.96



822-EX3

Supply

Drainage

Support

Specialties

Appendix



835-2

### TrapShield™ Trap Protection Device

Item Number	Item Description	Pkg Type	Min Qty	Case Qty	Price
835-2	Trapshield™ For 2" Drain Outlet	BI	1	50	\$56.31
835-3	Trapshield™ For 3" Drain Outlet	BI	1	25	\$63.36
835-35	Trapshield™ For 3-1/2" Drain Head	BI	1	25	\$63.36
835-4	Trapshield™ For 4" Drain Outlet	BI	1	20	\$74.98



842-SNQ3

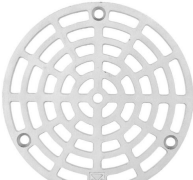

842-SCS2



842-SD4

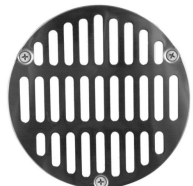

842-SS2



842-SP2

### Replacement Strainers

Item Number	Item Description	Pkg Type	Min Qty	Case Qty	Price
<b>NICKEL-BRONZE STRAINERS</b>					
842-SN2	4" Dia. Rnd - 4.25 Sqr. Inch Free Area - 3" Screw Centers	BI	1	20	\$28.07
842-SN3	5-1/16" Dia. Rnd - 7.5 Sqr. Inch Free Area - 3-7/8" Screw Centers	BI	1	10	\$34.14
842-SN4	6-1/16" Dia. Rnd - 11.75 Sqr. Inch Free Area - 4-7/8" Screw Centers	BI	1	20	\$37.91
<b>842-SNQ2</b>	4" Dia. Sqr - 7.6 Sqr. Inch Free Area - 3" Screw Centers	BI	1	1	\$43.23
842-SNQ3	5-3/8" Dia. Sqr - 12.75 Sqr. Inch Free Area - 3-7/8" Screw Centers	BI	1	1	\$61.69
842-SNQ4	6-11/16" Dia. Sqr - 16.4 Sqr. Inch Free Area - 4-7/8" Screw Centers	BI	1	20	\$75.83
<b>CAST STAINLESS STEEL STRAINERS</b>					
<b>842-SCS2</b>	4" Dia. Rnd - 4.25 Sqr. Inch Free Area - 3" Screw Centers	BI	1	1	\$38.68
842-SCS3	5-1/8" Dia. Rnd - 7.5 Sqr. Inch Free Area - 3-7/8" Screw Centers	BI	1	10	\$56.88
842-SCS4	6-1/8" Dia. Rnd - 11.75 Sqr. Inch Free Area - 4-7/8" Screw Centers	BI	1	10	\$64.48
<b>842-SCSQ2</b>	4" Dia. Sqr - 7.6 Sqr. Inch Free Area - 3" Screw Centers	BI	1	1	\$53.85
<b>842-SCSQ3</b>	5-3/8" Dia. Sqr - 12.75 Sqr. Inch Free Area - 3-7/8" Screw Centers	BI	1	1	\$79.63
<b>842-SCSQ4</b>	6-1/2" Dia. Sqr - 16.4 Sqr. Inch Free Area - 4-7/8" Screw Centers	BI	1	1	\$102.38
<b>CAST IRON STRAINERS</b>					
842-SD4	6-1/16" Dia. Rnd - 13.25 Sqr. Inch Free Area - 4-7/8" Screw Centers	BI	1	1	\$16.23
<b>842-SI2</b>	4-1/2" Dia. Rnd - 4.18 Sqr. Inch Free Area	BI	1	1	\$25.56
842-SI3	5-5/8" Dia. Rnd - 6.81 Sqr. Inch Free Area	BI	1	10	\$23.80
842-SI4	6-3/16" Dia. Rnd - 9.58 Sqr. Inch Free Area	BI	1	2	\$31.71
<b>STAMPED STAINLESS STEEL STRAINERS</b>					
842-SS2	4" Dia. Rnd - 2.66 Sqr. Inch Free Area - 3" Screw Centers	BI	1	10	\$7.60
842-SS3	5-1/16" Dia. Rnd - 5.09 Sqr. Inch Free Area - 3-7/8" Screw Centers	BI	1	10	\$9.09
842-SS4	6-1/16" Dia. Rnd - 9.25 Sqr. Inch Free Area - 4-7/8" Screw Centers	BI	1	10	\$12.53
<b>GRAY ABS STRAINERS</b>					
<b>842-SP2</b>	4" Dia. Rnd - 4.18 Sqr. Inch Free Area - 3" Screw Centers	BI	1	1	\$7.97
842-SP3	5-1/16" Dia. Rnd - 5.15 Sqr. Inch Free Area - 3-7/8" Screw Centers	BI	1	10	\$9.88
842-SP4	6-1/16" Dia. Rnd - 8.74 Sqr. Inch Free Area - 4-7/8" Screw Centers	BI	1	10	\$12.90

**Floor Drain Adapters**

**Trap Primer Adapters**

Item Number	Item Description	Pkg Type	Min Qty	Case Qty	Price
<b>PVC/ABS - FIP X SCH. 40 HUB CONNECTION</b>					
842-82AT	2" ABS Hub w/ 1/2" FIP Trap Primer Port	BI	1	10	\$13.39
842-82PT	2" PVC Hub w/ 1/2" FIP Trap Primer Port	BI	1	10	\$13.39
842-83AT	3" ABS Hub w/ 1/2" FIP Trap Primer Port	BI	1	10	\$17.85
842-83PT	3" PVC Hub w/ 1/2" FIP Trap Primer Port	BI	1	10	\$17.85
842-84AT	4" ABS Hub w/ 1/2" FIP Trap Primer Port	BI	1	10	\$20.07
842-84PT	4" PVC Hub w/ 1/2" FIP Trap Primer Port	BI	1	10	\$20.07
<b>PVC/ABS - SCH. 40 HUB X SCH. 40 HUB CONNECTION</b>					
695-2A	2" ABS Hub Adapter w/ 1/2" FIP Port	BI	1	10	\$18.80
695-2P	2" PVC Hub Adapter w/ 1/2" FIP Port	BI	1	10	\$18.80
695-3A	3" ABS Hub Adapter w/ 1/2" FIP Port	B	1	10	\$21.32
695-3P	3" PVC Hub Adapter w/ 1/2" FIP Port	BI	1	10	\$21.32
695-4A	4" ABS Hub Adapter w/ 1/2" FIP Port	B	1	10	\$25.07
695-4P	4" PVC Hub Adapter w/ 1/2" FIP Port	BI	1	10	\$25.07

**Floor Drain Adapters**

**Flashing Drain Adapters**

**Options:** Add suffix to item no. Add price to list  
 T = Tapped/plugged trap primer port for ABS/PVC: \$16.00;

Item Number	Item Description	Pkg Type	Min Qty	Case Qty	Price
<b>PVC/ABS - SCH. 40 HUB CONNECTION</b>					
863-HA23	2" ABS Hub w/ 3" FIP Thread	BI	1	10	\$43.43
<b>863-HA33</b>	3" ABS Hub w/ 3" FIP Thread	BI	1	10	\$43.43
<b>863-HA44</b>	4" ABS Hub w/ 4" FIP Thread	BI	1	10	\$43.43
863-HP23	2" PVC Hub w/ 3" FIP Thread	BI	1	10	\$43.43
863-HP33	3" PVC Hub w/ 3" FIP Thread	BI	1	10	\$43.43
863-HP34	3" PVC Hub w/ 4" FIP Thread	BI	1	10	\$43.43
863-HP44	4" PVC Hub w/ 4" FIP Thread	BI	1	10	\$43.43

**Condensate Funnels**

Item Number	Item Description	Pkg Type	Min Qty	Case Qty	Price
<b>ROUND 4"</b>					
863-FA	Round Aluminum Condensate Funnel w/ Screws	BI	1	12	\$49.15
863-FN	Round Nikl-Brnz Condensate Funnel w/ Screws	BI	1	12	\$109.99
<b>OVAL 4" X 9"</b>					
863-FNO	Oval Nikl-Brnz Condensate Funnel w/ Screws	BI	1	12	\$243.96



842-82PT



695-2P



863-HP23



863-FA

Supply

Drainage

Support

Specialties

Appendix

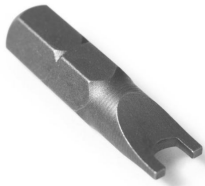

850-VW1

### Vandal-Resistant Strainer Screws

Item Number	Item Description	Pkg Type	Min Qty	Case Qty	Price
<b>10-24 SIZE</b>					
850-V105	1/2" Stainless, 12/Bag	BI	1	25	\$17.87
850-V106	5/8" Stainless, 12/Bag	BI	1	25	\$17.87
<b>850-V109</b>	1" Stainless, 12/Bag	BI	1	1	\$17.87
850-VW1	#10 Span For Most Drain Strainers And Cleanout Covers	BI	10	10	\$21.05
<b>1/4-20 SIZE</b>					
850-V407	3/4" Stainless	BI	1	1	\$4.50
850-V415	1-1/2" Stainless	BI	1	1	\$4.08
850-V425	2-1/2" Stainless	BI	1	1	\$4.08
850-VW4	#14 Span For 850 And 851 Series Covers	BI	10	10	\$21.05

# Commercial Floor Sinks

**SquareMax™ Square Floor Sinks**

**FatMax™ Round Floor Sinks**

**LittleMax™ Compact Floor Sinks**

Sioux Chief's PVC floor sinks are made from a tough, impact-modified PVC resin. They are corrosion-resistant and withstand water temperatures up to 180°F without distortion.





**PVC - Sch. 40 Hub Connection**

**Floor Sinks**

**Options:** Add suffix to item no. Add price to list

**D** = ABS Dome Bottom Strainer (1): \$10.00; **U** = Aluminum Dome Bottom Strainer (1): \$22.00;

**C** = PVC Clamping Collar: \$20.00; **W** = Stainless Steel Debris Basket: \$60.00;

**2** = Open-Half Strainer (2): N/C; **3** = Open-Quarter Strainer (2): N/C;

**V** = Vandal-Resistant Strainer (2): \$12.00; **T** = Tapped Trap Primer Connection - 1/2" FIP: \$12.00;

**F** = Round Nickel-Bronze Condensate Funnel: \$108.00; **FA** = Round Aluminum Condensate Funnel: \$48.00;

**FO** = Oval Nickel-Bronze Condensate Funnel: \$238.00; **6** = ABS Flat Strainer for Drain Outlet (1): \$12.00;

1: Not available for 6" sinks 2: Available for sinks with PVC, NB, and SS strainers only

Item Number	Item Description	Pkg Type	Min Qty	Case Qty	Price
<b>SINK ONLY - NO STRAINER</b>					
861-2PX	2" Hub	Bl	1	3	\$65.15
861-2PXR	2" Hub	Bl	1	3	\$65.15
861-3PX	3" Hub	Bl	1	3	\$65.15
861-3PXR	3" Hub	Bl	1	3	\$65.15
861-4PX	4" Hub	Bl	1	3	\$65.15
861-6PX	6" Hub	Bl	1	2	\$166.48
<b>PVC STRAINER</b>					
861-2P	2" Hub - 11-3/16" Sqr Grate	Bl	1	1	\$97.72
861-3P	3" Hub - 11-3/16" Sqr Grate	Bl	1	1	\$97.72
861-4P	4" Hub - 11-3/16" Sqr Grate	Bl	1	1	\$97.72
861-6P	6" Hub - 11-3/16" Sqr Grate	Bl	1	1	\$199.04
<b>NICKEL-BRONZE RING &amp; STRAINER</b>					
861-2PN	2" Hub - 11-3/4" Sqr Grate	Bl	1	1	\$571.82
861-3PN	3" Hub - 11-3/4" Sqr Grate	Bl	1	1	\$571.82
861-4PN	4" Hub - 11-3/4" Sqr Grate	Bl	1	1	\$571.82
861-6PN	6" Hub - 11-3/4" Sqr Grate	Bl	1	1	\$673.14
<b>STAINLESS STEEL RING &amp; STRAINER</b>					
861-2PZ	2" Hub - 11-3/4" Sqr Grate	Bl	1	1	\$571.82
861-3PZ	3" Hub - 11-3/4" Sqr Grate	Bl	1	1	\$571.82
861-4PZ	4" Hub - 11-3/4" Sqr Grate	Bl	1	1	\$571.82
861-6PZ	6" Hub - 11-3/4" Sqr Grate	Bl	1	1	\$673.14
<b>DUCTILE IRON RING &amp; STRAINER</b>					
861-2PI	2" Hub - 11-3/4" Sqr Grate	Bl	1	1	\$249.72
861-3PI	3" Hub - 11-3/4" Sqr Grate	Bl	1	1	\$249.72
861-4PI	4" Hub - 11-3/4" Sqr Grate	Bl	1	1	\$249.72
861-6PI	6" Hub - 11-3/4" Sqr Grate	Bl	1	1	\$351.06



861-2PX



861-2P



861-3PN



861-2PZ

Supply

Drainage

Support

Specialties

Appendix

Supply

Drainage

Support

Specialties

Appendix



861-5

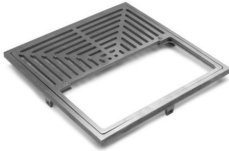

861-51NR

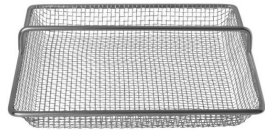

861-UM



863-FNO



863-U

**SquareMax™ Floor Sink Accessories**

Item Number	Item Description	Pkg Type	Min Qty	Case Qty	Price
<b>STRAINERS</b>					
861-5	PVC Full Strainer w/ Lift Handle	BI	1	15	\$32.58
861-51	PVC Open-Half Strainer	BI	1	15	\$24.97
861-51NR	Nikl-Brnz Ring & Open-Half Strainer	BI	1	3	\$530.00
861-51SR	Stnls Steel Ring & Open-Half Strainer	BI	1	3	\$437.53
861-53	PVC Open-Quarter Strainer	BI	1	15	\$28.96
861-53N	Nikl-Brnz Open-Quarter Strainer Only	BI	1	1	\$279.43
861-53NR	Nikl-Brnz Ring & Open-Quarter Strainer	BI	1	3	\$530.00
<b>861-53SR</b>	Stnls Steel Ring & Open-Quarter Strainer	BI	1	1	\$484.18
861-5CI	Heel-Proof, Ductile Iron Ring & Full Strainer	BI	1	3	\$189.56
861-5CIG	Heel-Proof, Ductile Iron Strainer Only	BI	1	1	\$113.74
861-5NR	Nikl-Brnz Ring & Full Strainer	BI	1	3	\$530.00
861-5SR	Stnls Steel Ring & Full Strainer	BI	1	1	\$530.80
<b>ACCESSORIES</b>					
861-6	Flat Secondary Strainer - White ABS	BI	1	10	\$11.58
861-C	PVC Clamping Collar w/ Stainless Steel Bolts	BI	1	5	\$18.93
861-D	Dome Bottom Strainer - White ABS	BI	1	80	\$9.42
861-UM	Stainless Steel Debris Basket	BI	1	5	\$60.67
863-FA	Round Aluminum Condensate Funnel w/ Screws	BI	1	12	\$49.15
863-FN	Round Nikl-Brnz Condensate Funnel w/ Screws	BI	1	12	\$109.99
863-FNO	Oval Nikl-Brnz Condensate Funnel w/ Screws	BI	1	12	\$243.96
863-U	Aluminum Dome Bottom Strainer (Not For 6" Conn.)	BI	1	5	\$21.73

**PVC - Sch. 40 Hub Connection**

**Floor Sinks**

**Options:** Add suffix to item no. Add price to list

**S** = ABS Sand Bucket: \$14.00; **U** = ABS Debris Bucket: \$14.00;

**C** = ABS Clamping Collar: \$17.00; **D** = ABS Dome Bottom Strainer: \$10.00;

**V** = Vandal-Resistant Strainer (1): \$12.00; **T** = Tapped Trap Primer Connection - 1/2" FIP: \$12.00;

**2** = Open-Half Strainer (1): N/C; **3** = Open-Quarter Strainer (2): N/C;

**W** = Stainless Steel Debris Basket: \$52.00; **F** = Round Nickel-Bronze Condensate Funnel: \$108.00;

**FA** = Round Aluminum Condensate Funnel: \$48.00; **FO** = Oval Nickel-Bronze Condensate Funnel: \$238.00;

**J** = Solid PVC Cover with Lift Handle (3): \$45.00; **6** = ABS Flat Strainer for Drain Outlet: \$12.00;

**L** = Aluminum Dome Bottom Strainer: \$22.00;

1: Not available for iron strainers 2: For PVC Strainers Only 3: For sinks with NO strainer only



860-W2P



860-W2PN

Item Number	Item Description	Pkg Type	Min Qty	Case Qty	Price
<b>SINK ONLY - NO STRAINER</b>					
860-W2PX	2" White PVC Hub - 9" Rnd Grate	Bl	1	4	\$53.20
860-W3PX	3" White PVC Hub - 9" Rnd Grate	Bl	1	4	\$53.20
860-W4PX	4" White PVC Hub - 9" Rnd Grate	Bl	1	4	\$53.20
<b>PVC STRAINER</b>					
860-W2P	2" White PVC Hub - 9" Rnd Grate	Bl	1	4	\$83.25
860-W3P	3" White PVC Hub - 9" Rnd Grate	Bl	1	4	\$83.25
860-W4P	4" White PVC Hub - 9" Rnd Grate	Bl	1	4	\$83.25
<b>NICKEL-BRONZE RING &amp; STRAINER</b>					
860-W2PN	2" White PVC Hub - 9-3/4" Rnd Grate	Bl	1	1	\$343.80
860-W3PN	3" White PVC Hub - 9-3/4" Rnd Grate	Bl	1	4	\$343.80
860-W4PN	4" White PVC Hub - 9-3/4" Rnd Grate	Bl	1	4	\$343.80
<b>STAINLESS STEEL RING &amp; STRAINER</b>					
860-W2PZ	2" White PVC Hub - 9-3/4" Rnd Grate	Bl	1	1	\$343.80
860-W3PZ	3" White PVC Hub - 9-3/4" Rnd Grate	Bl	1	1	\$343.80
860-W4PZ	4" White PVC Hub - 9-3/4" Rnd Grate	Bl	1	4	\$343.80
<b>DUCTILE IRON RING &amp; STRAINER</b>					
860-W2PI	2" White PVC Hub - 9-7/8" Rnd Grate	Bl	1	1	\$148.39
860-W3PI	3" White PVC Hub - 9-7/8" Rnd Grate	Bl	1	2	\$148.39
860-W4PI	4" White PVC Hub - 9-7/8" Rnd Grate	Bl	1	2	\$148.39

Supply

Drainage

Support

Specialties

Appendix

Supply

Drainage

Support

Specialties

Appendix



860-WGP2

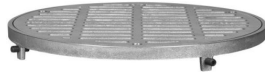

860-RGS



860-C



860-WS



860-WU



861-D

### FatMax™ Floor Sink Accessories

Item Number	Item Description	Pkg Type	Min Qty	Case Qty	Price
<b>STRAINERS</b>					
860-GI	Cast Iron Full Strainer Only	BI	1	5	\$87.22
860-GN	Nckl-Brnz Full Strainer Only	BI	1	1	\$207.41
<b>860-GN2</b>	Nickl-Brnz Open-Half Strainer Only	BI	1	1	\$147.86
<b>860-GN3</b>	Nickl-Brnz Open-Quarter Strainer Only	BI	1	1	\$173.28
860-RGN	Nckl-Brnz Ring And Full Strainer	BI	1	1	\$305.00
860-RGN2	Nickl-Brnz Ring And Open-Half Strainer	BI	1	1	\$305.00
860-RGS	304 Stnls Steel Ring And Full Strainer	BI	1	1	\$305.00
860-RGS2	304 Stnls Steel Ring And Open-Half Strainer	BI	1	1	\$305.00
860-WGP	PVC Full Strainer w/ Lift Handle	BI	1	16	\$36.19
860-WGP2	PVC Open-Half Strainer	BI	1	10	\$28.96
860-WGP3	PVC Open-Quarter Strainer	BI	1	10	\$33.29
860-WGPJ	PVC Full Cover	BI	1	16	\$43.43
<b>ACCESSORIES</b>					
860-C	Clamping Collar w/ Screws - Gray ABS	BI	1	10	\$14.85
860-UM	Stainless Steel Debris Basket	BI	1	5	\$53.08
860-WS	Sand Bucket For Sump Area - White PVC	BI	1	20	\$14.10
860-WU	Debris Bucket For Sump Area - White PVC	BI	1	20	\$14.10
861-6	Flat Secondary Strainer - White ABS	BI	1	10	\$11.58
861-D	Dome Bottom Strainer - White ABS	BI	1	80	\$9.42
863-FA	Round Aluminum Condensate Funnel w/ Screws	BI	1	12	\$49.15
863-FN	Round Nikl-Brnz Condensate Funnel w/ Screws	BI	1	12	\$109.99
863-FNO	Oval Nikl-Brnz Condensate Funnel w/ Screws	BI	1	12	\$243.96
863-U	Aluminum Dome Bottom Strainer (Not For 6" Conn.)	BI	1	5	\$21.73

**PVC - Sch. 40 Hub Connection**

**Options:** Add suffix to item no. Add price to list

**V** = Vandal-Resistant Strainer: \$12.00; **T** = Tapped Trap Primer Connection - 1/2" FIP: \$8.00;

**S** = Sand Bucket: \$12.00; **U** = Stainless Steel Debris Basket for Sump Area: \$41.00;

**2** = Open-Half Strainer: \$20.00; **3** = Open-Quarter Strainer: \$20.00;

**X** = Less Strainer: N/C;

Item Number	Item Description	Pkg Type	Min Qty	Case Qty	Price
<b>FLOOR SINKS</b>					
864-W2P	2" Hub - 6-5/8" Rnd PVC Grate	Bl	1	3	\$55.15
864-W3P	3" Hub - 6-5/8" Rnd PVC Grate	Bl	1	3	\$55.15
864-W4P	4" Hub - 6-5/8" Rnd PVC Grate	Bl	1	3	\$55.15
<b>ACCESSORIES</b>					
863-FA	Round Aluminum Condensate Funnel w/ Screws	Bl	1	12	\$49.15
863-FN	Round Nikl-Brnz Condensate Funnel w/ Screws	Bl	1	12	\$109.99
863-FNO	Oval Nikl-Brnz Condensate Funnel w/ Screws	Bl	1	12	\$243.96
864-UM	Stainless Steel Mesh Debris Basket	Bl	1	10	\$41.36
864-WGP	PVC Strainer w/ Lift Handle, Loose Set	Bl	1	1	\$19.99
<b>864-WGP2</b>	Open-Half PVC Strainer, Loose Set	Bl	1	1	\$39.99
864-WS	PVC Sand Bucket (Fits Inside Sump Area)	Bl	1	10	\$12.41



864-W2P

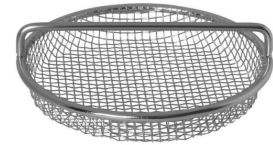

864-UM

Supply

Drainage

Support

Specialties

Appendix



# Commercial Roof Drains

Roof Drains

Planter Area Drains





## 11" Roof Drain

### PVC/ABS - Sch. 40 Hub Connection

**Options:** Add suffix to item no. Add price to list

**V** = Vandal-Resistant Dome: \$12.00; **W** = 2-3/16" High External Water Dam: \$125.00;

**P** = Steel Screen Installed over Dome Strainer: \$75.00; **STP2** = 2" High Internal Water Dam: \$100.00;

**U** = Underdeck Clamp Kit: \$85.00; **S** = Sump Receiver: \$67.00;

**E** = Extension Collar Kit: \$78.00;



868-P3

Item Number	Item Description	Pkg Type	Min Qty	Case Qty	Price
<b>ROOF DRAINS WITH POLY DOME STRAINER</b>					
868-A3	3" ABS Hub	BI	1	2	\$129.64
868-A4	4" ABS Hub	BI	1	2	\$129.64
<b>868-A6</b>	6" ABS Hub	BI	1	2	\$142.29
868-P3	3" PVC Hub	BI	1	2	\$129.64
868-P4	4" PVC Hub	BI	1	2	\$129.64
868-P6	6" PVC Hub	BI	1	2	\$142.29
<b>ROOF DRAINS WITH ALUMINUM DOME STRAINER</b>					
<b>868-A3M</b>	3" ABS Hub	BI	1	2	\$189.58
<b>868-A4M</b>	4" ABS Hub	BI	1	2	\$189.58
<b>868-A6M</b>	6" ABS Hub	BI	1	2	\$202.24
868-P3M	3" PVC Hub	BI	1	2	\$189.58
868-P4M	4" PVC Hub	BI	1	2	\$189.58
868-P6M	6" PVC Hub	BI	1	2	\$202.24
<b>ACCESSORIES</b>					
868-C	Under Deck Clamp Kit: 11" Epoxy-Coated Clamping Plate, Thread Rod, Nuts & Washers	BI	1	5	\$86.00
868-E	Extension Collar Kit: 13" Extension Collar, Thread Rod, Nuts & Washers	BI	1	5	\$78.50
868-MC	Epoxy-Coated Aluminum Replacement Gravel Guard	BI	1	10	\$92.48
868-MD	9-1/4" Diameter, Cast Aluminum Dome	BI	1	5	\$90.10
868-S	Sump Receiver: 11-1/2" Sump Receiver Plate	BI	1	10	\$67.58
868-WD	Epoxy-Coated Aluminum External Water Dam, 2-3/16"	BI	1	1	\$126.55

Supply

Drainage

Support

Specialties

Appendix



867-P2

## 10" Roof Drain

### PVC/ABS - Sch. 40 Hub Connection

**Options:** Add suffix to item no. Add price to list

**V** = Vandal-Resistant Dome: \$12.00; **P** = Steel Screen Installed over Dome Strainer: \$75.00;

**C** = Ductile Iron Gravel Guard (1): \$35.00; **STP2** = 2" High Internal Water Dam: \$75.00;

**U** = Underdeck Clamp Kit: \$38.00;

1: In lieu of PVC (standard)

Item Number	Item Description	Pkg Type	Min Qty	Case Qty	Price
<b>ROOF DRAINS WITH POLY DOME STRAINER</b>					
<b>867-A2</b>	2" ABS Hub	BI	2	2	\$60.92
867-A3	3" ABS Hub	BI	2	2	\$60.92
867-A4	4" ABS Hub	BI	2	2	\$60.92
867-P2	2" PVC Hub	BI	2	2	\$60.92
867-P3	3" PVC Hub	BI	2	2	\$60.92
867-P4	4" PVC Hub	BI	2	2	\$60.92
<b>ROOF DRAINS WITH CAST IRON DOME STRAINER</b>					
<b>867-A2M</b>	2" ABS Hub	BI	2	2	\$89.59
<b>867-A3M</b>	3" ABS Hub	BI	2	2	\$89.59
<b>867-A4M</b>	4" ABS Hub	BI	2	2	\$89.59
867-P2M	2" PVC Hub	BI	2	2	\$89.59
867-P3M	3" PVC Hub	BI	2	2	\$89.59
867-P4M	4" PVC Hub	BI	2	2	\$89.59
<b>ACCESSORIES</b>					
867-C	Underdeck Clamp Kit	BI	1	25	\$38.00
867-HC	PVC Replacement Gravel Guard	BI	1	5	\$16.49
867-HD	7-1/2" Diameter, Polypro Dome	BI	1	5	\$15.06
867-MC	Ductile Iron Replacement Gravel Guard	BI	1	1	\$33.72
867-MD	7-1/2" Diameter, Cast Iron Dome	BI	1	5	\$52.46
867-UM	Stainless Steel Dome Screen	BI	1	1	\$75.09

## 8" Roof Drain & Overflow - Cast Iron Dome

### Cast Iron - No-Hub Connection

Item Number	Item Description	Pkg Type	Min Qty	Case Qty	Price
867-DI2	2" No-Hub Roof Drain & Overflow Combo	BI	1	1	\$140.30
867-DI3	3" No-Hub Roof Drain & Overflow Combo	BI	1	1	\$140.30
867-DI4	4" No-Hub Roof Drain & Overflow Combo	BI	1	1	\$140.30



867-DI2

Supply

Drainage

Support

Specialties

Appendix

Supply

Drainage

Support

Specialties

Appendix



867-L3PP



867-C

### PVC/ABS - Sch. 40 Hub Connection

Item Number	Item Description	Pkg Type	Min Qty	Case Qty	Price
<b>PLANTER-AREA DRAINS</b>					
867-L3AP	3" ABS Hub, Poly Dome Strainer w/ SS Screen	BI	1	1	\$164.86
867-L3PP	3" PVC Hub, Poly Dome Strainer w/ SS Screen	BI	1	1	\$164.86
<b>867-L4AP</b>	4" ABS Hub, Poly Dome Strainer w/ SS Screen	BI	1	1	\$164.86
867-L4PP	4" PVC Hub, Poly Dome Strainer w/ SS Screen	BI	1	1	\$164.86
<b>ACCESSORIES</b>					
867-C	Underdeck Clamp Kit	BI	1	25	\$38.00
867-HC	PVC Replacement Gravel Guard	BI	1	5	\$16.49
867-MC	Ductile Iron Replacement Gravel Guard	BI	1	1	\$33.72
867-UM	Stainless Steel Dome Screen	BI	1	1	\$75.09

# Commercial Cleanouts

**FinishLine™ Adjustable Cleanouts**

**Access Cover Cleanouts**

**Halo™ Cleanouts**

**Wall Cleanouts**

**Cleanout Bushing**

**Plugs/Accessories**

FinishLine™ Cleanouts are adjustable both before and AFTER the concrete pour.



The FinishLine virtually eliminates cleanouts set too low or not level. Installations are faster, easier, and more professional looking.



**834-4PNQ**  
Page 357



**852-4PI**  
Page 358



**852-3LNQ**  
Page 358



**822-C3PSR**  
Page 360



**822-CF3PNR**  
Page 361



**851-44N**  
Page 362



**850-3T**  
Page 363



**870-3**  
Page 364



**871-4**  
Page 364



**873-240**  
Page 365



**875-3P**  
Page 367



**875-84PN**  
Page 367



**878-20**  
Page 368



**878-S30**  
Page 369



**876-30**  
Page 369



**852-CN3**  
Page 370

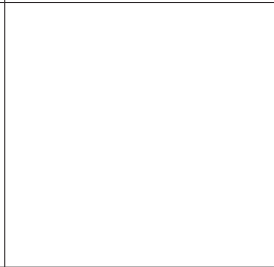
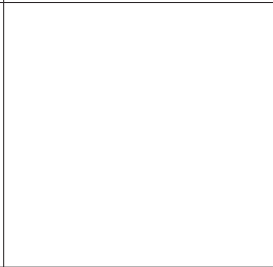
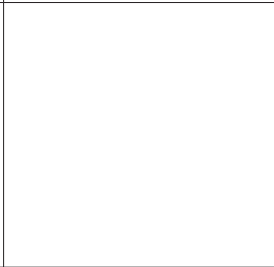
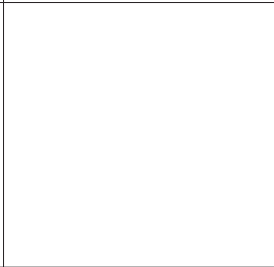
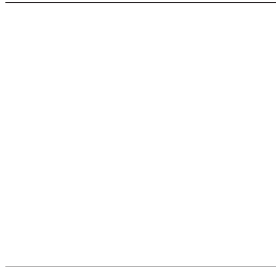
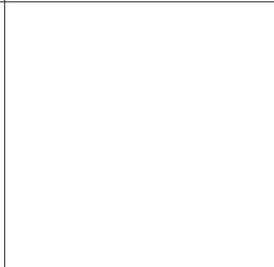
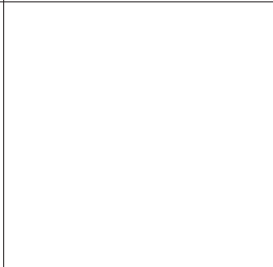
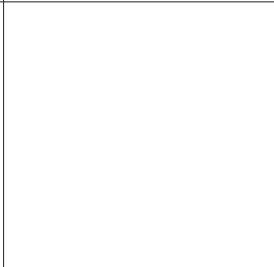
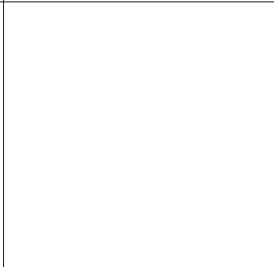

PVC/ABS - Sch. 40 Hub Connection

6-1/2" Tops

Options: Add suffix to item no. Add price to list

V = Vandal-Resistant Cover: \$6.50; S = Stamping: Specify Letters: \$12.50;

C = Carpet Marker: \$16.00; B = Brass Cleanout Plug (1): \$12.00;

Z = Complies with Buy American Act (2): \$62.00;

1: In lieu of polypro (standard) 2: For round nickel-bronze ring/cover only



834-4AF



834-3PNQ

Item Number	Item Description	Pkg Type	Min Qty	Case Qty	Price
<b>ROUGH-IN FIXTURE</b>					
834-3AF	3" ABS Hub	Bl	1	10	\$27.47
834-3PF	3" PVC Hub	Bl	1	10	\$27.47
834-4AF	4" ABS Hub	Bl	1	10	\$28.78
834-4PF	4" PVC Hub	Bl	1	10	\$27.47
<b>FINISH FIXTURE</b>					
834-4HNQ	6-5/8" Sqr Nikl-Brnz Ring & Strainer	Bl	1	10	\$106.73
834-4HNR	6-1/2" Rnd Nikl-Brnz Ring & Strainer	Bl	1	10	\$81.77
834-4HSQ	6-5/8" Sqr Stnls Steel Ring & Strainer	Bl	1	10	\$106.73
834-4HSR	6-1/2" Rnd Stnls Steel Ring & Strainer	Bl	1	10	\$81.77
<b>COMPLETE ASSEMBLY</b>					
834-3ANQ	3" Hub - 6-5/8" Sqr Nikl-Brnz Ring & Strainer	Bl	1	1	\$134.16
834-3ANR	3" Hub - 6-1/2" Rnd Nikl-Brnz Ring & Strainer	Bl	1	1	\$109.20
<b>834-3ASQ</b>	3" Hub - 6-5/8" Sqr Stnls Steel Ring & Strainer	Bl	1	1	\$134.16
<b>834-3ASR</b>	3" Hub - 6-1/2" Rnd Stnls Steel Ring & Strainer	Bl	1	1	\$109.20
834-3PNQ	3" Hub - 6-5/8" Sqr Nikl-Brnz Ring & Strainer	Bl	1	1	\$134.16
834-3PNR	3" Hub - 6-1/2" Rnd Nikl-Brnz Ring & Strainer	Bl	1	1	\$109.20
834-3PSQ	3" Hub - 6-5/8" Sqr Stnls Steel Ring & Strainer	Bl	1	1	\$134.16
834-3PSR	3" Hub - 6-1/2" Rnd Stnls Steel Ring & Strainer	Bl	1	1	\$109.20
834-4ANQ	4" Hub - 6-5/8" Sqr Nikl-Brnz Ring & Strainer	Bl	1	1	\$134.16
834-4ANR	4" Hub - 6-1/2" Rnd Nikl-Brnz Ring & Strainer	Bl	1	1	\$109.20
<b>834-4ASQ</b>	4" Hub - 6-5/8" Sqr Stnls Steel Ring & Strainer	Bl	1	1	\$134.16
<b>834-4ASR</b>	4" Hub - 6-1/2" Rnd Stnls Steel Ring & Strainer	Bl	1	1	\$109.20
834-4PNQ	4" Hub - 6-5/8" Sqr Nikl-Brnz Ring & Strainer	Bl	1	1	\$134.16
834-4PNR	4" Hub - 6-1/2" Rnd Nikl-Brnz Ring & Strainer	Bl	1	1	\$109.20
834-4PSQ	4" Hub - 6-5/8" Sqr Stnls Steel Ring & Strainer	Bl	1	1	\$134.16
834-4PSR	4" Hub - 6-1/2" Rnd Stnls Steel Ring & Strainer	Bl	1	1	\$109.20
<b>ACCESSORIES</b>					
832-EX4	Ductile Iron Extension Adapter - 2" Min - 4" Max	Bl	1	1	\$34.14
832-S4	Two Adjustment Shims, Two 3/4" Screws	Bl	1	10	\$6.10
832-W	Flexible Red Locating Bristles w/ Screw	Bl	1	10	\$7.26

Supply

Drainage

Support

Specialties

Appendix



852-3ANR



852-3PSQ



852-4PI



852-3LNQ

### PVC/ABS - Sch. 40 Hub Connection

**Options:** Add suffix to item no. Add price to list

**V** = Vandal-Resistant Cover: \$6.50; **S** = Stamping: Specify Letters (1): \$12.50;

**Z** = Complies with Buy American Act (2): \$62.00; **C** = Carpet Marker: \$16.00;

**H** = Special-Duty Cover (15,000 lbs. safe load) (3): \$39.75; **Y** = Ductile Iron Head Adapter (4): \$26.00;

1: Not available for iron covers. 2: For round nickel-bronze ring/cover only 3: Not available for stainless steel covers 4: In lieu of ABS (standard)

Item Number	Item Description	Pkg Type	Min Qty	Case Qty	Price
<b>NICKEL-BRONZE RING &amp; COVER</b>					
<b>852-3ANQ</b>	3" ABS Hub - 6-5/8" Sqr Ring & Cover	BI	1	1	\$133.33
852-3ANR	3" ABS Hub - 6-1/2" Rnd Ring & Cover	BI	1	5	\$104.65
852-3PNQ	3" PVC Hub - 6-5/8" Sqr Ring & Cover	BI	1	2	\$133.33
852-3PNR	3" PVC Hub - 6-1/2" Rnd Ring & Cover	BI	1	5	\$104.65
<b>852-4ANQ</b>	4" ABS Hub - 6-5/8" Sqr Ring & Cover	BI	1	1	\$133.33
852-4ANR	4" ABS Hub - 6-1/2" Rnd Ring & Cover	BI	1	10	\$104.65
852-4PNQ	4" PVC Hub - 6-5/8" Sqr Ring & Cover	BI	1	2	\$133.33
852-4PNR	4" PVC Hub - 6-1/2" Rnd Ring & Cover	BI	1	10	\$104.65
<b>STAINLESS STEEL RING &amp; COVER</b>					
<b>852-3ASQ</b>	3" ABS Hub - 6-5/8" Sqr Ring & Cover	BI	1	1	\$133.33
852-3ASR	3" ABS Hub - 6-1/2" Rnd Ring & Cover	BI	1	5	\$104.65
<b>852-3PSQ</b>	3" PVC Hub - 6-5/8" Sqr Ring & Cover	BI	1	1	\$133.33
852-3PSR	3" PVC Hub - 6-1/2" Rnd Ring & Cover	BI	1	1	\$104.65
<b>852-4ASQ</b>	4" ABS Hub - 6-5/8" Sqr Ring & Cover	BI	1	1	\$133.33
<b>852-4ASR</b>	4" ABS Hub - 6-1/2" Rnd Ring & Cover	BI	1	1	\$104.65
852-4PSQ	4" PVC Hub - 6-5/8" Sqr Ring & Cover	BI	1	2	\$133.33
852-4PSR	4" PVC Hub - 6-1/2" Rnd Ring & Cover	BI	1	10	\$104.65
<b>CAST IRON RING &amp; COVER</b>					
<b>852-3AI</b>	3" ABS Hub - 6-1/2" Rnd Ring & Cover	BI	1	1	\$61.64
852-3PI	3" PVC Hub - 6-1/2" Rnd Ring & Cover	BI	1	2	\$61.64
<b>852-4AI</b>	4" ABS Hub - 6-1/2" Rnd Ring & Cover	BI	1	1	\$61.64
852-4PI	4" PVC Hub - 6-1/2" Rnd Ring & Cover	BI	1	2	\$61.64

### ABS - MIP Thread Connection

**Options:** Add suffix to item no. Add price to list

**V** = Vandal-Resistant Cover: \$6.50; **S** = Stamping: Specify Letters (1): \$12.50;

1: Not available for iron covers.

Item Number	Item Description	Pkg Type	Min Qty	Case Qty	Price
<b>NICKEL-BRONZE RING &amp; COVER</b>					
852-2LNR	2" ABS MIP - 4-1/2" Rnd Ring & Cover	BI	1	10	\$60.92
852-3LNQ	3" ABS MIP - 5-7/8" Sqr Ring & Cover	BI	1	5	\$111.10
852-3LNR	3" ABS MIP - 5-1/2" Rnd Ring & Cover	BI	1	10	\$75.25
852-4LNQ	4" ABS MIP - 6-5/8" Sqr Ring & Cover	BI	1	1	\$132.61
852-4LNR	4" ABS MIP - 6-1/2" Rnd Ring & Cover	BI	1	10	\$103.95
852-4LNRPK	4" ABS MIP - 6-1/2" Rnd Ring & Cover	CI	5	5	\$104.95

**ABS - MIP Thread Connection (Cont)**

Item Number	Item Description	Pkg Type	Min Qty	Case Qty	Price
<b>STAINLESS STEEL RING &amp; COVER</b>					
852-3LSQ	3" ABS MIP - 5-7/8" Sqr Ring & Cover	Bl	1	1	\$111.10
852-3LSR	3" ABS MIP - 5-1/2" Rnd Ring & Cover	Bl	1	10	\$75.25
852-4LSQ	4" ABS MIP - 6-5/8" Sqr Ring & Cover	Bl	1	1	\$132.61
852-4LSR	4" ABS MIP - 6-1/2" Rnd Ring & Cover	Bl	1	1	\$103.95
<b>CAST IRON RING &amp; COVER</b>					
852-3LI	3" ABS MIP - 6-1/8" Rnd Ring & Cover	Bl	1	2	\$53.76
852-4LI	4" ABS MIP - 6-1/2" Rnd Ring & Cover	Bl	1	2	\$52.74
<b>GRAY ABS COVER</b>					
852-3LP	3" ABS MIP - 5-1/2" Rnd Ring & Cover	Bl	1	10	\$32.27
852-4LP	4" ABS MIP - 6-1/2" Rnd Ring & Cover	Bl	1	1	\$32.27



852-3LSR



852-3LI



852-3LP

Supply

Drainage

Support

Specialties

Appendix



822-C3ANR



822-C3ASR

### Halo™ Adjustable Cleanouts

#### PVC/ABS - Sch. 40 Hub Connection

**Options:** Add suffix to item no. Add price to list

**V** = Vandal-Resistant Cover: \$6.50; **S** = Stamping: Specify Letters: \$12.50;

**C** = Carpet Marker: \$16.00; **Z** = Complies with Buy American Act (1): \$62.00;

1: For round nickel-bronze ring/cover only

Item Number	Item Description	Pkg Type	Min Qty	Case Qty	Price
<b>NICKEL-BRONZE RING &amp; COVER</b>					
822-C3ANQ	3" ABS Hub - 5-7/8" Sqr Ring & Cover	BI	1	1	\$124.50
822-C3ANR	3" ABS Hub - 5-1/2" Rnd Ring & Cover	BI	1	1	\$91.73
<b>822-C3PNQ</b>	3" PVC Hub - 5-7/8" Sqr Ring & Cover	BI	1	1	\$124.50
822-C3PNR	3" PVC Hub - 5-1/2" Rnd Ring & Cover	BI	1	4	\$91.73
<b>822-C4ANQ</b>	Inside 4" ABS - 5-7/8" Sqr Ring & Cover	BI	1	1	\$147.44
822-C4ANR	Inside 4" ABS - 5-1/2" Rnd Ring & Cover	BI	1	1	\$114.68
<b>822-C4PNQ</b>	Inside 4" PVC - 5-7/8" Sqr Ring & Cover	BI	1	1	\$147.44
822-C4PNR	Inside 4" PVC - 5-1/2" Rnd Ring & Cover	BI	1	1	\$114.68
<b>STAINLESS STEEL RING &amp; COVER</b>					
<b>822-C3ASQ</b>	3" ABS Hub - 5-7/8" Sqr Ring & Cover	BI	1	1	\$124.50
<b>822-C3ASR</b>	3" ABS Hub - 5-1/2" Rnd Ring & Cover	BI	1	1	\$91.73
<b>822-C3PSQ</b>	3" PVC Hub - 5-7/8" Sqr Ring & Cover	BI	1	1	\$124.50
822-C3PSR	3" PVC Hub - 5-1/2" Rnd Ring & Cover	BI	1	4	\$91.73
<b>822-C4ASQ</b>	Inside 4" ABS - 5-7/8" Sqr Ring & Cover	BI	1	1	\$147.44
<b>822-C4ASR</b>	Inside 4" ABS - 5-1/2" Rnd Ring & Cover	BI	1	1	\$114.68
<b>822-C4PSQ</b>	Inside 4" PVC - 5-7/8" Sqr Ring & Cover	BI	1	1	\$147.44
822-C4PSR	Inside 4" PVC - 5-1/2" Rnd Ring & Cover	BI	1	4	\$114.68
<b>ACCESSORIES</b>					
822-EX3	Ductile Iron Extension Adapter	B	1	1	\$33.96

### FinishLine Halo™ Adjustable Cleanouts

#### PVC/ABS - Sch. 40 Hub Connection

**Options:** Add suffix to item no. Add price to list

**V** = Vandal-Resistant Cover: \$6.50; **S** = Stamping: Specify Letters: \$12.50;

**C** = Carpet Marker: \$16.00; **Z** = Complies with Buy American Act (1): \$62.00;

1: For round nickel-bronze ring/cover only



822-C3PF



834-3HSQ

Item Number	Item Description	Pkg Type	Min Qty	Case Qty	Price
<b>ROUGH-IN FIXTURE</b>					
822-C3AF	3" ABS Hub	BI	1	1	\$56.36
<b>822-C3PF</b>	3" PVC Hub	BI	1	1	\$56.36
<b>FINISH FIXTURE</b>					
<b>834-3HNQ</b>	5-7/8" Sqr Nikl-Brnz Ring & Strainer	BI	1	1	\$89.88
834-3HNR	5-1/2" Rnd Nikl-Brnz Ring & Strainer	BI	1	10	\$58.65
<b>834-3HSQ</b>	5-7/8" Sqr Stnls Steel Ring & Strainer	BI	1	1	\$89.88
<b>834-3HSR</b>	5-1/2" Rnd Stnls Steel Ring & Strainer	BI	1	1	\$58.65

**FinishLine Halo™ Adjustable Cleanouts (Cont)**

**PVC/ABS - Sch. 40 Hub Connection**

Item Number	Item Description	Pkg Type	Min Qty	Case Qty	Price
<b>COMPLETE ASSEMBLY</b>					
822-CF3ANQ	3" ABS Hub - 5-7/8" Sqr Nikl-Brnz Ring & Cover	Bl	1	1	\$150.74
822-CF3ANR	3" ABS Hub - 5-1/2" Rnd Nikl-Brnz Ring & Cover	Bl	1	1	\$117.95
822-CF3ASQ	3" ABS Hub - 5-7/8" Sqr Stnls Steel Ring & Cover	Bl	1	1	\$150.74
822-CF3ASR	3" ABS Hub - 5-1/2" Rnd Stnls Steel Ring & Cover	Bl	1	1	\$117.95
822-CF3PNQ	3" PVC Hub - 5-7/8" Sqr Nikl-Brnz Ring & Cover	Bl	1	1	\$150.74
822-CF3PNR	3" PVC Hub - 5-1/2" Rnd Nikl-Brnz Ring & Cover	Bl	1	1	\$117.95
822-CF3PSQ	3" PVC Hub - 5-7/8" Sqr Stnls Steel Ring & Cover	Bl	1	1	\$150.74
822-CF3PSR	3" PVC Hub - 5-1/2" Rnd Stnls Steel Ring & Cover	Bl	1	1	\$117.95
<b>ACCESSORIES</b>					
822-EX3	Ductile Iron Extension Adapter	B	1	1	\$33.96
832-EX3	Ductile Iron Extension Adapter - 2" Min - 3-3/8" Max	Bl	1	1	\$34.14
832-S3	Two Adjustment Shims, Two 3/4" Screws	Bl	1	10	\$6.10
832-W	Flexible Red Locating Bristles w/ Screw	Bl	1	10	\$7.26



822-CF3PNR

Supply

Drainage

Support

Specialties

Appendix

Supply

Drainage

Support

Specialties

Appendix



851-44N



851-34I

## PVC/ABS - Sch. 40 Hub Connection

**Options:** Add suffix to item no. Add price to list

**V** = Vandal-Resistant Cover: \$6.50; **S** = Stamping: Specify Letters (1): \$12.50;

**C** = Carpet Marker (1): \$16.00;

1: Not available for iron covers.

Item Number	Item Description	Pkg Type	Min Qty	Case Qty	Price
<b>NICKEL-BRONZE COVER</b>					
851-33N	3" ABS Hub - 4-3/8" Rnd Ring & Cover	BI	1	2	\$129.74
851-34N	4" ABS Hub - 6" Rnd Ring & Cover	BI	1	2	\$163.88
851-36N	6" ABS Hub - 8-3/8" Rnd Ring & Cover	BI	1	2	\$303.86
851-43N	3" PVC Hub - 4-3/8" Rnd Ring & Cover	BI	1	2	\$129.74
851-44N	4" PVC Hub - 6" Rnd Ring & Cover	BI	1	2	\$163.88
851-46N	6" PVC Hub - 8-3/8" Rnd Ring & Cover	BI	1	2	\$303.86
<b>TENZ-ALLOY COVER</b>					
<b>851-33T</b>	3" ABS Hub - 4-3/8" Rnd Ring & Cover	BI	1	2	\$88.76
851-34T	4" ABS Hub - 6" Rnd Ring & Cover	BI	1	2	\$95.61
<b>851-36T</b>	6" ABS Hub - 8-3/8" Rnd Ring & Cover	BI	1	2	\$163.88
851-43T	3" PVC Hub - 4-3/8" Rnd Ring & Cover	BI	1	2	\$88.76
851-44T	4" PVC Hub - 6" Rnd Ring & Cover	BI	1	2	\$95.61
851-46T	6" PVC Hub - 8-3/8" Rnd Ring & Cover	BI	1	2	\$163.88
<b>CAST IRON COVER</b>					
851-34I	4" ABS Hub - 6" Rnd Ring & Cover	BI	1	2	\$82.09
<b>851-36I</b>	6" ABS Hub - 8-1/2" Rnd Ring & Cover	BI	1	2	\$167.76
851-44I	4" PVC Hub - 6" Rnd Ring & Cover	BI	1	2	\$82.09
851-46I	6" PVC Hub - 8-1/2" Rnd Ring & Cover	BI	1	2	\$167.76
<b>NB LAMINATED CAST IRON COVER</b>					
<b>851-36IN</b>	6" ABS Hub - 7-1/8" Rnd Ring & Cover	BI	1	2	\$334.58
851-46IN	6" PVC Hub - 7-1/8" Rnd Ring & Cover	BI	1	2	\$334.58

**Set Screw Connection**

**Options:** Add suffix to item no. Add price to list  
**V** = Vandal-Resistant Cover: \$6.50; **S** = Stamping: Specify Letters (1): \$12.50;  
 1: Not available for iron covers

Item Number	Item Description	Pkg Type	Min Qty	Case Qty	Price
<b>NICKEL-BRONZE</b>					
850-234N	5-1/2" Cover - Over 2", 3", Or 4" Pipe	Bl	1	10	\$101.79
850-2N	6-1/2" Cover - Over 2" Pipe	Bl	1	6	\$211.31
850-3N	7-1/8" Cover - Over 3" Pipe	Bl	1	6	\$313.11
850-4N	9-1/8" Cover - Over 4" Pipe	Bl	1	6	\$414.90
<b>TENZ-ALLOY</b>					
850-2T	6-1/2" Cover - Over 2" Pipe	Bl	1	6	\$86.37
850-3T	7-1/8" Cover - Over 3" Pipe	Bl	1	6	\$109.81
850-4T	9-1/8" Cover - Over 4" Pipe	Bl	1	6	\$164.42
<b>CAST IRON</b>					
850-2I	6" Cover - Over 2" Pipe	Bl	1	6	\$73.90
850-3I	7-1/8" Cover - Over 3" Pipe	Bl	1	4	\$86.07
850-4I	8-1/2" Cover - Over 4" Pipe	Bl	1	2	\$115.75
<b>NIKL-BRNZ LAMINATED CAST IRON</b>					
850-4IN	8-3/4" Cover - Over 4" Pipe	Bl	1	2	\$492.96



850-234N

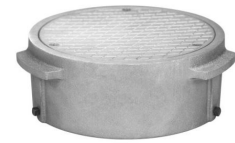

850-2T



850-2I

Supply

Drainage

Support

Specialties

Appendix



870-3

## Cleanout Covers

### Stainless Steel Covers

**Options:** Add suffix to item no. Add price to list  
**S** = Stamping; Specify Letters: \$12.50;

Item Number	Item Description	Pkg Type	Min Qty	Case Qty	Price
<b>20-GA COVER</b>					
870-3	3" Diameter	BI	25	25	\$5.11
870-4	4" Diameter	BI	25	25	\$6.45
870-5	5" Diameter	BI	25	25	\$9.41
870-6	6" Diameter	BI	25	25	\$9.73
870-8	8" Diameter	BI	10	10	\$12.35
870-810	10" Diameter	BI	5	5	\$22.01
870-812	12" Diameter	BI	5	5	\$30.84

## Cleanout Covers

### ABS Covers



871-4



871-18

Item Number	Item Description	Pkg Type	Min Qty	Case Qty	Price
<b>FLAT COVER</b>					
871-4	White - 4-1/2" Diameter	BI	25	25	\$3.26
871-6	White - 6-1/2" Diameter	BI	25	25	\$5.94
871-8	White - 8-1/2" Diameter	BI	1	10	\$9.34
872-4	Chrome-Plated - 4-1/4" Diameter	BI	25	25	\$9.57
872-6	Chrome-Plated - 7-1/4" Diameter	BI	25	25	\$13.70
872-8	Chrome-Plated - 9-1/4" Diameter	BI	10	10	\$18.17
<b>RAISED COVER</b>					
871-16	White - 7-1/4" Diameter × 1-1/4" Height	BI	25	25	\$14.97
871-18	White - 9-1/4" Diameter × 1-1/4" Height	BI	10	10	\$20.40
872-16	Chrome-Plated - 7-1/4" Diameter × 1-1/4" Height	BI	25	25	\$19.77
872-18	Chrome-Plated - 9-1/4" Diameter × 1-1/4" Height	BI	10	10	\$26.47

Cleanout Cover Kits

Stainless Steel Covers

Options: Add suffix to item no. Add price to list  
 V = Vandal-Resistant Cover Screw (1): \$6.50;

1: For 873 Series only

Item Number	Item Description	Pkg Type	Min Qty	Case Qty	Price
<b>20-GA COVER WITH SCREW</b>					
870-3PK1	3" Cover, 2-1/2" Screw	Bl	5	5	\$7.61
870-4PK1	4" Cover, 2-1/2" Screw	Bl	5	5	\$8.95
870-6PK1	6" Cover, 2-1/2" Screw	Cl	5	5	\$12.23
870-8PK1	8" Cover, 2-1/2" Screw	Bl	5	5	\$15.35
<b>20-GA COVER WITH SCREW AND POLYPRO PLUG</b>					
873-240P	4" Cover, 2" Plug, 2-1/2" Screw	Bl	1	10	\$13.65
873-350P	5" Cover, 3" Plug, 2-1/2" Screw	Bl	1	10	\$18.50
873-460P	6" Cover, 4" Plug, 2-1/2" Screw	Bl	1	10	\$22.73
<b>20-GA COVER WITH SCREW AND BRASS PLUG</b>					
873-240	4" Cover, 2" Plug, 2-1/2" Screw	Bl	1	10	\$17.80
873-350	5" Cover, 3" Plug, 2-1/2" Screw	Bl	1	10	\$26.12
873-460	6" Cover, 4" Plug, 2-1/2" Screw	Bl	1	10	\$33.44
<b>20-GA COVER WITH SCREW AND WALL BAR</b>					
870-B3	3" Cover, 6" Screw, 9" Wall Bar	Bl	1	10	\$11.83
870-B4	4" Cover, 6" Screw, 9" Wall Bar	Bl	1	10	\$12.55
870-B5	5" Cover, 6" Screw, 9" Wall Bar	Bl	1	10	\$17.57
870-B6	6" Cover, 6" Screw, 9" Wall Bar	Bl	1	10	\$19.71
870-B8	8" Cover, 6" Screw, 9" Wall Bar	Bl	1	10	\$24.01

Cleanout Cover Accessories

Item Number	Item Description	Pkg Type	Min Qty	Case Qty	Price
<b>THREADED WALL BAR</b>					
870-B	1/4" x 20 Threaded Wall Bar, 9" Length	B	25	100	\$3.81
<b>CARPET MARKER KIT</b>					
870-2CM	Stainless Steel Carpet Marker w/ 1-1/2" Screw	Bl	25	25	\$4.30



870-6PK1



873-350



870-B4



870-B



870-2CM



874-1

### Cleanout Cover Accessories (Cont)

Item Number	Item Description	Pkg Type	Min Qty	Case Qty	Price
<b>CLEANOUT COVER SCREW</b>					
874-1	1/4" × 20 Stainless Steel Screw 1 1/2" Length	B	25	1000	\$0.99
874-1C	1/4" × 20 Chrome Plated Screw 1 1/2" Length	B	25	1000	\$1.88
874-1W	1/4" × 20 White Epoxy-Coated Screw 1 1/2" Length	B	25	100	\$2.96
874-2	1/4" × 20 Stainless Steel Screw 2 1/4" Length	B	25	1000	\$1.53
874-2N	1/4"-20 × 2"	B	50	200	\$0.59
874-3C	1/4" × 20 Chrome Plated Screw 3" Length	B	25	500	\$1.82
874-3W	1/4" × 20 White Epoxy-Coated Screw 3" Length	B	25	1000	\$4.15
874-4	1/4" × 20 Stainless Steel Screw 4" Length	B	25	500	\$3.01
874-4C	1/4" × 20 Chrome Plated Screw 4 1/2" Length	B	25	500	\$2.50
874-4W	1/4" × 20 White Epoxy-Coated Screw 4 1/2" Length	B	25	100	\$5.17
874-6	1/4" × 20 Stainless Steel Screw 6" Length	B	25	1000	\$6.03
874-6C	1/4" × 20 Chrome Plated Screw 6" Length	B	25	100	\$3.15
874-6W	1/4" × 20 White Epoxy-Coated Screw 6" Length	B	25	100	\$6.71

**Inside-Pipe Cleanout Bushing**

Item Number	Item Description	Pkg Type	Min Qty	Case Qty	Price
<b>BUSHING</b>					
875-2A	2" Black ABS Bushing with 1-1/2" Plug	BI	20	20	\$6.37
875-2P	2" White ABS Bushing with 1-1/2" Plug	BI	20	20	\$6.37
875-3A	3" Black ABS Bushing with 2-1/2" Plug	BI	20	20	\$7.65
875-3P	3" White ABS Bushing with 2-1/2" Plug	BI	20	20	\$7.65
875-4A	4" Black ABS Bushing with 3-1/2" Plug	BI	20	20	\$9.25
875-4P	4" White ABS Bushing with 3-1/2" Plug	BI	20	20	\$9.25
<b>BUSHING WITH 16-GA COVER</b>					
875-8230P	2" White ABS Bushing with 1-1/2" Plug & Stnls Steel Cover	BI	1	10	\$14.90
875-8340P	3" White ABS Bushing with 2-1/2" Plug & Stnls Steel Cover	BI	1	10	\$19.04
875-8450P	4" White ABS Bushing with 3-1/2" Plug & Stnls Steel Cover	BI	1	10	\$20.92

**Inside-Pipe Cleanout Fitting with Nickel-Bronze Cover**

Item Number	Item Description	Pkg Type	Min Qty	Case Qty	Price
<b>INSIDE 4" PIPE</b>					
875-84AN	4" ABS Cleanout with Cover	BI	1	12	\$54.32
875-84PN	4" PVC Cleanout with Cover	BI	1	12	\$54.32
<b>INSIDE 3" PIPE</b>					
875-83AN	3" ABS Cleanout with Cover	BI	1	12	\$40.35
875-83PN	3" PVC Cleanout with Cover	BI	1	12	\$40.35



875-2P



875-8230P



875-84PN

Supply

Drainage

Support

Specialties

Appendix



878-20



878-025

**Polypropylene - Slotted**

Item Number	Item Description	Pkg Type	Min Qty	Case Qty	Price
<b>WITH THREADED BRASS INSERT</b>					
878-15	1-1/2" White	B	25	25	\$2.18
878-15PK	1-1/2" White	CI	25	25	\$2.43
878-20	2" White	B	25	25	\$2.18
878-20PK	2" White	CI	25	25	\$2.43
878-25	2-1/2" White	B	25	25	\$2.87
878-30	3" White	B	25	25	\$3.33
878-30PK	3" White	CI	25	25	\$3.58
878-35	3-1/2" White	B	25	25	\$3.98
878-35PK	3-1/2" White	CI	25	25	\$4.23
878-40	4" White	B	25	25	\$4.63
878-40PK	4" White	CI	25	25	\$4.88
878-50	5" White	B	25	25	\$12.25
878-60	6" White	B	8	8	\$13.90
879-15	1-1/2" Black	B	25	25	\$2.18
879-15PK	1-1/2" Black	CI	25	25	\$2.43
879-20	2" Black	B	25	25	\$2.18
879-20PK	2" Black	CI	25	25	\$2.43
879-25	2-1/2" Black	B	25	25	\$2.87
879-30	3" Black	B	25	25	\$3.33
879-30PK	3" Black	CI	25	25	\$3.58
879-35	3-1/2" Black	B	25	25	\$3.98
879-35PK	3-1/2" Black	CI	25	25	\$4.23
879-40	4" Black	B	25	25	\$4.63
879-40PK	4" Black	CI	25	25	\$4.88
<b>879-50</b>	5" Black	B	20	20	\$12.25
879-60	6" Black	B	8	8	\$13.90
<b>NO INSERT</b>					
878-015	1-1/2" White	B	25	25	\$1.34
878-015PK	1-1/2" White	CI	25	25	\$1.59
878-020	2" White	B	25	25	\$1.46
878-020PK	2" White	B	25	25	\$1.71
878-025	2-1/2" White	B	25	25	\$1.79
878-025PK	2-1/2" White	CI	25	25	\$2.04
878-030	3" White	B	25	25	\$2.01
878-030PK	3" White	CI	25	25	\$2.26
878-035	3-1/2" White	B	25	25	\$2.50
878-035PK	3-1/2" White	CI	25	25	\$2.75
878-040	4" White	B	25	25	\$2.87
878-040PK	4" White	CI	25	25	\$3.12
879-015	1-1/2" Black	B	25	25	\$1.34
879-015PK	1-1/2" Black	CI	25	25	\$1.59
879-020	2" Black	B	25	25	\$1.46
879-020PK	2" Black	CI	25	25	\$1.71
879-025	2-1/2" Black	B	25	25	\$1.79
<b>879-025PK</b>	2-1/2" Black	CI	25	25	\$2.04
879-030	3" Black	B	25	25	\$2.01
879-030PK	3" Black	CI	25	25	\$2.26
879-035	3-1/2" Black	B	25	25	\$2.50
879-035PK	3-1/2" Black	CI	25	25	\$2.75
879-040	4" Black	B	25	25	\$2.87
879-040PK	4" Black	CI	25	25	\$3.12

**Polypropylene - Square-Head**

Item Number	Item Description	Pkg Type	Min Qty	Case Qty	Price
878-S15	1-1/2" White	B	25	25	\$1.34
878-S20	2" White	B	25	25	\$1.52
878-S30	3" White	B	25	25	\$2.17
878-S40	4" White	B	25	25	\$3.07
879-S15	1-1/2" Black	B	25	25	\$1.34
879-S20	2" Black	B	25	25	\$1.52
879-S30	3" Black	B	25	25	\$2.17
879-S40	4" Black	B	25	25	\$3.07



878-S15

**Brass - Square-Head**

Item Number	Item Description	Pkg Type	Min Qty	Case Qty	Price
<b>RAISED SQUARE</b>					
876-15PK	1-1/2"	CI	10	10	\$5.60
876-20	2"	BI	20	20	\$6.34
876-20PK	2"	CI	10	10	\$6.59
876-25PK	2-1/2"	CI	10	10	\$8.03
876-30	3"	BI	20	20	\$11.50
876-30PK	3"	CI	10	10	\$11.75
876-35	3-1/2"	BI	20	20	\$15.23
876-35PK	3-1/2"	BI	10	10	\$15.48
876-40	4"	BI	20	20	\$16.47
876-40PK	4"	CI	10	10	\$16.72
876-50	5"	BI	1	10	\$29.01
876-60	6"	BI	1	10	\$44.62
<b>COUNTERSUNK SQUARE</b>					
877-20	2"	BI	1	20	\$6.34
877-25	2-1/2"	BI	1	20	\$8.00
877-30	3"	BI	1	20	\$11.50
877-30PK	3"	BI	10	10	\$11.75
877-35	3-1/2"	BI	1	20	\$15.23
877-35PK	3 1/2"	BI	10	10	\$15.48
877-40	4"	BI	1	20	\$16.47
877-40PK	4"	BI	10	10	\$16.72
877-60	6"	BI	1	10	\$44.62



876-20

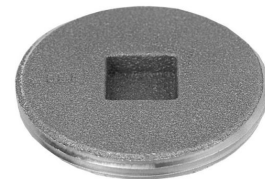

877-30

**PVC - Spanner**

Item Number	Item Description	Pkg Type	Min Qty	Case Qty	Price
878-915	1-1/2"	B	10	20	\$17.21
878-920	2"	B	10	10	\$17.21
878-930	3"	B	10	10	\$16.74
878-935	3-1/2"	B	10	20	\$17.98
878-940	4"	B	10	10	\$18.49
878-950	5"	B	10	10	\$21.76
878-960	6"	B	10	10	\$28.05
878-980	8"	B	10	10	\$46.55



878-920

Supply

Drainage

Support

Specialties

Appendix

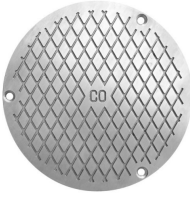

852-CN2

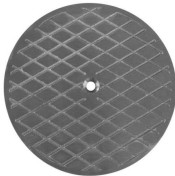

851-CN3



850-CN2



852-CT4

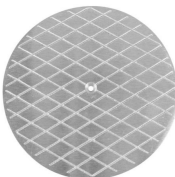

851-CT3

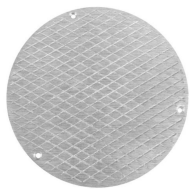

850-CT2

## Replacement Cleanout Covers

### Nickel Bronze Covers

**Options:** Add suffix to item no. Add price to list  
**B** = Beveled Edge for Floor Plate (1): \$10.00;

1: For 851 Series covers

Item Number	Item Description	Pkg Type	Min Qty	Case Qty	Price
<b>FOR 834 &amp; 852 SERIES</b>					
<b>852-CN2</b>	4" Rnd Cover	BI	1	10	\$46.61
852-CN3	5-1/16" Rnd Cover	BI	1	10	\$50.17
852-CN4	6-1/16" Rnd Cover	BI	1	10	\$68.09
<b>852-HCN4</b>	6-1/18" Rnd Cover	BI	1	1	\$96.03
<b>FOR 851 SERIES</b>					
851-CN3	5-1/4" Rnd Cover	BI	1	10	\$78.52
851-CN4	6-1/8" Rnd Cover	BI	1	10	\$112.68
851-CN6	7-3/4" Rnd Cover	BI	1	10	\$126.34
851-CN8	8-3/8" Rnd Cover	BI	1	10	\$160.45
<b>FOR 850 SERIES</b>					
850-CN2	6-1/16" Rnd Cover	BI	1	10	\$77.32
850-CN3	6-3/8" Rnd Cover	BI	1	10	\$106.78
850-CN4	8-3/8" Rnd Cover	BI	1	1	\$184.10

## Replacement Cleanout Covers

### Tenz-Alloy Covers

**Options:** Add suffix to item no. Add price to list  
**B** = Beveled Edge for Floor Plate (1): \$10.00;

1: For 851 Series covers

Item Number	Item Description	Pkg Type	Min Qty	Case Qty	Price
<b>FOR 834 &amp; 852 SERIES</b>					
<b>852-CT4</b>	6-1/16" Rnd Cover	BI	1	2	\$33.69
<b>FOR 851 SERIES</b>					
851-CT3	5-1/4" Rnd Cover	BI	1	10	\$37.54
851-CT4	6-1/8" Rnd Cover	BI	1	10	\$47.79
851-CT6	7-3/4" Rnd Cover	BI	1	10	\$58.04
851-CT8	8-3/8" Rnd Cover	BI	1	10	\$75.12
<b>FOR 850 SERIES</b>					
850-CT2	6-1/16" Rnd Cover	BI	1	10	\$33.15
850-CT3	6-3/8" Rnd Cover	BI	1	10	\$54.18
850-CT4	8-3/8" Rnd Cover	BI	1	10	\$85.55

**Replacement Cleanout Covers**

**Cast Iron Covers**

Item Number	Item Description	Pkg Type	Min Qty	Case Qty	Price
<b>FOR 834 &amp; 852 SERIES</b>					
852-CD4	6-1/8" Rnd Cover	Bl	1	10	\$20.98
<b>852-CI3</b>	5-1/16" Rnd Cover	Bl	1	1	\$26.23
852-CI4	6-1/16" Rnd Cover	Bl	1	5	\$41.22
852-HCD4	6-1/8" Rnd Cover	Bl	1	1	\$27.50
<b>FOR 851 SERIES</b>					
851-CI3	4-1/8" Rnd Cover	Bl	1	1	\$20.80
851-CI4	5-1/8" Rnd Cover	Bl	1	1	\$24.98
851-CI6	6-1/8" Rnd Cover	Bl	1	10	\$35.71
851-CI8	7-3/4" Rnd Cover	Bl	1	10	\$42.84
<b>FOR 850 SERIES</b>					
<b>850-CI2</b>	5-1/8" Rnd Cover	Bl	1	1	\$26.57
850-CI3	6-3/16" Rnd Cover	Bl	1	1	\$42.35
<b>850-CI4</b>	7-3/4" Rnd Cover	Bl	1	1	\$50.04

**Replacement Cleanout Covers**

**Stainless Steel Covers**

Item Number	Item Description	Pkg Type	Min Qty	Case Qty	Price
<b>FOR 834 &amp; 852 SERIES</b>					
<b>852-CS3</b>	5-1/8" Rnd Cover	Bl	1	1	\$50.17
<b>852-CS4</b>	6-1/8" Rnd Cover	Bl	1	1	\$68.09

**Replacement Cleanout Covers**

**Gray ABS Covers**

Item Number	Item Description	Pkg Type	Min Qty	Case Qty	Price
<b>FOR 834 &amp; 852 SERIES</b>					
<b>852-CP3</b>	5-1/16" Rnd Cover	Bl	1	1	\$14.34
<b>852-CP4</b>	6-1/16" Rnd Cover	Bl	1	1	\$16.85



852-CD4

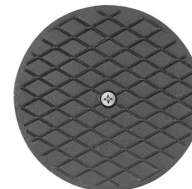

851-CI3

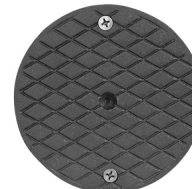

850-CI3



852-CS3

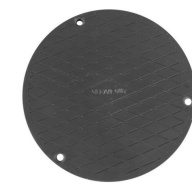

852-CP3

